

[MS-RDC]: Remote Differential Compression Algorithm

Intellectual Property Rights Notice for Open Specifications Documentation

- **Technical Documentation.** Microsoft publishes Open Specifications documentation for protocols, file formats, languages, standards as well as overviews of the interaction among each of these technologies.
- **Copyrights.** This documentation is covered by Microsoft copyrights. Regardless of any other terms that are contained in the terms of use for the Microsoft website that hosts this documentation, you may make copies of it in order to develop implementations of the technologies described in the Open Specifications and may distribute portions of it in your implementations using these technologies or your documentation as necessary to properly document the implementation. You may also distribute in your implementation, with or without modification, any schema, IDL's, or code samples that are included in the documentation. This permission also applies to any documents that are referenced in the Open Specifications.
- **No Trade Secrets.** Microsoft does not claim any trade secret rights in this documentation.
- **Patents.** Microsoft has patents that may cover your implementations of the technologies described in the Open Specifications. Neither this notice nor Microsoft's delivery of the documentation grants any licenses under those or any other Microsoft patents. However, a given Open Specification may be covered by Microsoft [Open Specification Promise](#) or the [Community Promise](#). If you would prefer a written license, or if the technologies described in the Open Specifications are not covered by the Open Specifications Promise or Community Promise, as applicable, patent licenses are available by contacting iplg@microsoft.com.
- **Trademarks.** The names of companies and products contained in this documentation may be covered by trademarks or similar intellectual property rights. This notice does not grant any licenses under those rights. For a list of Microsoft trademarks, visit www.microsoft.com/trademarks.
- **Fictitious Names.** The example companies, organizations, products, domain names, email addresses, logos, people, places, and events depicted in this documentation are fictitious. No association with any real company, organization, product, domain name, email address, logo, person, place, or event is intended or should be inferred.

Reservation of Rights. All other rights are reserved, and this notice does not grant any rights other than specifically described above, whether by implication, estoppel, or otherwise.

Tools. The Open Specifications do not require the use of Microsoft programming tools or programming environments in order for you to develop an implementation. If you have access to Microsoft programming tools and environments you are free to take advantage of them. Certain Open Specifications are intended for use in conjunction with publicly available standard specifications and network programming art, and assumes that the reader either is familiar with the aforementioned material or has immediate access to it.

Revision Summary

Date	Revision History	Revision Class	Comments
03/02/2007	1.0		Version 1.0 release
04/03/2007	1.1		Version 1.1 release
05/11/2007	1.2		Version 1.2 release
06/01/2007	1.2.1	Editorial	Revised and edited the technical content.
07/03/2007	1.2.2	Editorial	Revised and edited the technical content.
08/10/2007	1.2.3	Editorial	Revised and edited the technical content.
09/28/2007	1.2.4	Editorial	Revised and edited the technical content.
10/23/2007	1.2.5	Editorial	Revised and edited the technical content.
01/25/2008	1.2.6	Editorial	Revised and edited the technical content.
03/14/2008	1.2.7	Editorial	Revised and edited the technical content.
06/20/2008	1.3	Minor	Updated the technical content.
07/25/2008	1.3.1	Editorial	Revised and edited the technical content.
08/29/2008	2.0	Major	Updated and revised the technical content.
10/24/2008	2.0.1	Editorial	Revised and edited the technical content.
12/05/2008	3.0	Major	Updated and revised the technical content.
01/16/2009	3.0.1	Editorial	Revised and edited the technical content.
02/27/2009	3.0.2	Editorial	Revised and edited the technical content.
04/10/2009	3.0.3	Editorial	Revised and edited the technical content.
05/22/2009	3.0.4	Editorial	Revised and edited the technical content.
07/02/2009	3.0.5	Editorial	Revised and edited the technical content.
08/14/2009	3.0.6	Editorial	Revised and edited the technical content.
09/25/2009	3.0.7	Editorial	Revised and edited the technical content.
11/06/2009	3.0.8	Editorial	Revised and edited the technical content.
12/18/2009	3.0.9	Editorial	Revised and edited the technical content.
01/29/2010	3.0.10	Editorial	Revised and edited the technical content.
03/12/2010	4.0	Major	Updated and revised the technical content.

Date	Revision History	Revision Class	Comments
04/23/2010	5.0	Major	Updated and revised the technical content.
06/04/2010	5.0.1	Editorial	Revised and edited the technical content.
07/16/2010	5.0.1	No change	No changes to the meaning, language, or formatting of the technical content.
08/27/2010	5.0.1	No change	No changes to the meaning, language, or formatting of the technical content.
10/08/2010	5.0.1	No change	No changes to the meaning, language, or formatting of the technical content.
11/19/2010	5.1	Minor	Clarified the meaning of the technical content.
01/07/2011	5.1	No change	No changes to the meaning, language, or formatting of the technical content.
02/11/2011	5.1	No change	No changes to the meaning, language, or formatting of the technical content.
03/25/2011	5.1	No change	No changes to the meaning, language, or formatting of the technical content.
05/06/2011	5.1	No change	No changes to the meaning, language, or formatting of the technical content.
06/17/2011	5.2	Minor	Clarified the meaning of the technical content.
09/23/2011	5.2	No change	No changes to the meaning, language, or formatting of the technical content.
12/16/2011	5.2	No change	No changes to the meaning, language, or formatting of the technical content.
03/30/2012	5.2	No change	No changes to the meaning, language, or formatting of the technical content.
07/12/2012	5.3	Minor	Clarified the meaning of the technical content.
10/25/2012	5.3	No change	No changes to the meaning, language, or formatting of the technical content.
01/31/2013	5.3	No change	No changes to the meaning, language, or formatting of the technical content.
08/08/2013	6.0	Major	Significantly changed the technical content.
11/14/2013	6.0	No change	No changes to the meaning, language, or formatting of the technical content.
02/13/2014	6.0	No change	No changes to the meaning, language, or formatting of the technical content.

Date	Revision History	Revision Class	Comments
05/15/2014	6.0	No change	No changes to the meaning, language, or formatting of the technical content.

Contents

1 Introduction	7
1.1 Glossary	7
1.2 References	9
1.2.1 Normative References	9
1.2.2 Informative References	9
1.3 Overview	9
1.4 Relationship to Other Protocols	11
1.5 Prerequisites/Preconditions	11
1.6 Applicability Statement	11
1.7 Versioning and Capability Negotiation	11
1.8 Vendor-Extensible Fields	11
1.9 Standards Assignments	11
2 Messages	12
2.1 Transport	12
2.2 Message Syntax	12
2.2.1 Common Data Types	12
2.2.1.1 RdcVersion	12
2.2.1.2 FileHeader	12
2.2.2 Signature Files	13
2.2.2.1 ChunkSignature	13
2.2.3 Similarity Data	14
3 Protocol Details	15
3.1 Common Details	15
3.1.1 Abstract Data Model	15
3.1.2 Timers	15
3.1.3 Initialization	15
3.1.4 Higher-Layer Triggered Events	17
3.1.5 Message Processing Events and Sequencing Rules	18
3.1.5.1 Chunk Generation	18
3.1.5.1.1 H3 Hash	19
3.1.5.1.2 Finding Chunk Boundaries	20
3.1.5.2 Signature Computation	21
3.1.5.3 Recursion	22
3.1.5.3.1 Recursion Depth	22
3.1.5.4 Similarity	22
3.1.5.4.1 Similarity Data Calculation	23
3.1.5.4.2 Finding Seed Files	24
3.1.5.5 Generating the Target File	25
3.1.6 Timer Events	26
3.1.7 Other Local Events	26
4 Protocol Examples	27
4.1 Example System Architecture	27
4.2 H3	28
4.3 FilterMax	29
4.4 Sample Recursive Client Transfer	30
4.5 Sample Input and Generated Signature File	32
4.6 Sample Similarity Calculation	70

4.7 Other Considerations.....	70
5 Security.....	72
5.1 Security Considerations for Implementers.....	72
5.2 Index of Security Parameters	72
6 Appendix A: Product Behavior.....	73
7 Change Tracking.....	74
8 Index	75

1 Introduction

Remote differential compression (RDC), a compression algorithm, enables efficient synchronization of **files** with a remote source by using compression techniques to minimize the amount of data sent between a **source location** and a **target location**. The data is usually, though not always, in the form of a file stored on a file system. Unlike more traditional compression algorithms that rely on some regularity in the data to be compressed, RDC breaks a file into **chunks**. The chunks not already present on the target location can be identified by the application transferring the data stream. The application can then transfer the missing chunks from the source location.

Section 2 of this specification is normative and can contain the terms MAY, SHOULD, MUST, MUST NOT, and SHOULD NOT as defined in RFC 2119. Section 1.6 is also normative but cannot contain those terms. All other sections and examples in this specification are informative.

1.1 Glossary

The following terms are defined in [\[MS-GLOS\]](#):

hash function

The following terms are specific to this document:

chunks: The pieces of a **file** defined by the **cut points**.

client: For the purposes of this document only, the **client** is the **target location** machine.

collision-resistant hash function: A **hash function** having the property that (in practice) differing inputs do not produce the same hash (or collide).

cut points: The locations in a **file** where **RDC** has determined boundary points between blocks (or **chunks**). The **cut points** for a particular **file** depend on the content of the **file** and the parameters with which **RDC** is running.

file: A **file** is a typed data stream. For the purposes of this document only, **file** does not imply storage of the data stream in any particular medium or with any particular organization, or, for example, in a file system (italic is used when referring to traditional *files*).

hash window: The length, in bytes, of the domain of the **rolling hash function**. That is, the parameter n in the definition of **rolling hash function**.

horizon: An integer parameter of the **RDC FilterMax algorithm**. It refers to the number of consecutive hash values on both sides of a **file** offset.

local maximum: A pair consisting of an offset i in a **file** and the hash value $h(b_{i-\text{Hash Window}} \dots b_i)$ that has the property that for all $j \geq 0$, such that $i - \text{horizon} \leq j \leq i + \text{horizon}$, $j = i$ OR $h(b_{j-\text{Hash Window}} \dots b_j) < h(b_{i-\text{Hash Window}} \dots b_i)$, where for all $k < 0$, b_k is defined to be 0. **Local maxima** are used to find **cut points** by the **RDC FilterMax algorithm**.

MD4: Message Digest 4, as defined in [\[RFC1320\]](#). **MD4** is a collision-resistant, non-rolling hash function that produces a 16-byte hash. While **MD4** is no longer considered to be cryptographically secure, **RDC** does not rely on cryptographic security in its **hash function**.

min-wise independent hash functions: A set $H = \{ H_1, H_2, \dots, H_n \}$ of **hash functions** is said to be min-wise independent if, for any input D and for any subset X of $\{1, \dots, n\}$, any index i of X has an equal probability of yielding the smallest value $H_i(D)$ of the values $H_j(D)$ for j in X .

RDC FilterMax algorithm: The algorithm that **RDC** uses to determine the **cut points** in a **file**. The **RDC FilterMax algorithm** has the property that it will often find **cut points** that result in identical **chunks** being found in differing **files**, even when the **files** differ by insertions and deletions of bytes, not simply by length-preserving byte modifications. See section [3.1.5.1](#).

recursion level: For very large **files**, even the **signature file** may be large. To reduce the bandwidth required to transfer **signature files**, **RDC** may be used to reduce the number of bytes that must be moved from **source location** to **target location** to transfer the **signature file**. This process may be repeated a number of times, producing successively smaller **signature files**. The **recursion level** is the number of times it is repeated. The first **signature file** is **recursion level 1**. The **source file** is referred to as being at **recursion level 0**.

remote differential compression (RDC): In general, the term **RDC** may refer to any of a class of compression algorithms designed to compare two **files** residing at different locations without requiring one of the **files** to be transferred in its entirety to the other location. In this document, unless otherwise noted, the terms **remote differential compression** and **RDC** always refer to the **RDC** algorithm developed by Microsoft.

rolling hash function: A **hash function** that can be computed incrementally over a set of data. Given an arbitrary integer $n \geq 0$, some bytes $b_0 \dots b_{n-1}$, and their hash $h(b_0 \dots b_{n-1})$, a **hash function** h is a **rolling hash function** if one can compute $h(b_1 \dots b_n)$ in time that does not depend on n .

seed data: See **seed file**.

seed file: A **file** or **files** at the **target location** used to supply data used in reconstructing the **source file**. **RDC** may use an arbitrary number of **seed files** in the process of copying a single **source file**. Selecting **seed files** can be guided by using **similarity traits** (see section [3.1.5.4.2](#)).

server: For the purposes of this document only, the **server** is the **source location**.

signature: A structure containing a hash and block **chunk** size. The hash field is 16 bytes, and the **chunk** size field is a 2-byte unsigned integer. See section [2.2.2.1](#).

signature file: A **file** containing the **signatures** of another (source) **file**. There is a simple header that identifies the type of the **file** as a **signature file**, the size of the header itself, and the **RDC** library version number. Following the header are the **signatures** from the **source file** in the order they are generated from the **chunks**. See section [2.2.2](#).

similarity data: Information on a **file** that can be used to determine an appropriate **seed file** to select to reduce the amount of data transferred. **Similarity data** consists of one or more **similarity traits**.

similarity trait: A trait that summarizes an independent feature of a **file**. The features are computed by taking **min-wise independent hash functions** of a **file's signatures**. For information about how traits are computed, see section [3.1.5.4](#). **Similarity traits** are used in selecting **seed files**.

source data: See **source file**.

source file: A **file** on a **source location** that is to be copied by **RDC**. Sometimes referred to as source.

source location: The **source location** is the location from which a **file** is being transferred after it has been compressed with **RDC**.

target file: A **file** on the **target location** that is the destination of an **RDC** copy.

target location: The **target location** is the destination location of a file that has been compressed by **RDC**.

MAY, SHOULD, MUST, SHOULD NOT, MUST NOT: These terms (in all caps) are used as described in [\[RFC2119\]](#). All statements of optional behavior use either MAY, SHOULD, or SHOULD NOT.

1.2 References

References to Microsoft Open Specifications documentation do not include a publishing year because links are to the latest version of the documents, which are updated frequently. References to other documents include a publishing year when one is available.

1.2.1 Normative References

We conduct frequent surveys of the normative references to assure their continued availability. If you have any issue with finding a normative reference, please contact dochelp@microsoft.com. We will assist you in finding the relevant information.

[RFC1320] Rivest, R., "The MD4 Message-Digest Algorithm", RFC 1320, April 1992, <http://www.ietf.org/rfc/rfc1320.txt>

[RFC2119] Bradner, S., "Key words for use in RFCs to Indicate Requirement Levels", BCP 14, RFC 2119, March 1997, <http://www.rfc-editor.org/rfc/rfc2119.txt>

1.2.2 Informative References

[FIPS180-2] FIPS PUBS, "Secure Hash Standard", FIPS PUB 180-2, August 2002, <http://csrc.nist.gov/publications/fips/fips180-2/fips180-2.pdf>

[LBFS] Muthitacharoen, A., Chen, B., and Mazieres, D., "A Low-Bandwidth Network File System", October 2001, <http://www.sosp.org/2001/papers/mazieres.pdf>

[MS-FRS2] Microsoft Corporation, "[Distributed File System Replication Protocol](#)".

[MSDN-RDCAPI] Microsoft Corporation, "Remote Differential Compression", <http://msdn.microsoft.com/en-us/library/aa373254.aspx>

[MS-GLOS] Microsoft Corporation, "[Windows Protocols Master Glossary](#)".

[UASDC] Ziv, J. and Lempel, A., "A Universal Algorithm for Sequential Data Compression", May 1977, <http://ieeexplore.ieee.org/iel5/18/22696/01055714.pdf>

1.3 Overview

Remote differential compression (RDC) is a compression algorithm that is used in other protocols, but it is not a protocol itself. For example, it is used by the SD Microsoft Distributed File System Replication Protocol [\[MS-FRS2\]](#).

Traditional compression algorithms operate by finding some kind of redundancy in the file to be compressed, and then represent it more compactly. For example, the Lempel-Ziv algorithm (for more information, see [\[UASDC\]](#)) finds repeated substrings in the **source file** and replaces second and successive instances of them with references to the initial string in the compressed file. By contrast, RDC tries to find blocks of data that are identical between the source file (on the source location) and a set of **seed files** (on the target location). This makes it possible for the protocol that is transferring the *file* between two locations to reduce the number of bytes transferred between the source location and target location when reconstructing the source file on the target location.

The fundamental observation that drives RDC is this: By dividing a file into chunks and determining what chunks are already present at the target location, a correct copy of a source file can be constructed at the target location. To accomplish this, it is only necessary to transfer those chunks not already present at the target location, and combine them in the proper order with those chunks that are already present at the target location. If many chunks of the source file are already present at the target location, this technique can greatly reduce the amount of data that is required to be transferred compared to transferring the entire source file from the source location.

The set of chunks that make up a file can be expressed in far fewer bytes than the entire file by means of a **signature file**. The **signature** of a chunk is its length and a collision-resistant hash of its contents. Because hashes produce small, fixed-size outputs, for even modest-size chunks, the signature will be much smaller than the chunk.

Any method of determining chunk boundaries will suffice to produce correct behavior. However, because it is common to create a file by inserting or deleting bytes from a previously existing file, or by combining several previously existing files, it is advantageous to have a chunking method that can find equal chunks at some point after the insertion or deletion. A necessary consequence of this property is that the chunking method is required to be data dependent. It cannot simply use fixed offsets.

The RDC chunking method computes a rolling hash over the data using the H3 **hash function**, as described in section [3.1.5.1.1](#), and selects as chunk boundaries the offsets that have the largest value of H3 within a given **horizon**. Because this computation depends only on the bytes within the horizon (plus possibly one **hash window** size of bytes before the horizon), any change outside of the horizon will not affect the chunk boundaries. Thus, the chunking will produce identical chunks sufficiently far away from the change, including insertions and deletions.

This idea was the basis of MIT's Low-Bandwidth Network File System (LBFS) (for more information, see [\[LBFS\]](#)), although LBFS differs from RDC in many details.

RDC can be used within a single machine or to optimize transfer between two machines. For example, RDC can be used as part of a network protocol that engages in a handshake of the form:

1. Machine A sends Machine B a request to transfer *file* f_B .
2. Machine B partitions *file* f_B into chunks and computes the signature for each of the chunks. Machine B sends its list of chunk signatures, $\text{Sig}B_1 \dots \text{Sig}B_n$, to Machine A. This list provides the basis for Machine A being able to reconstruct *file* f_B .
3. Using **similarity data**, as described in section [3.1.5.4](#), Machine A selects a *file* f_A as a seed file and partitions it into chunks. It computes a signature for each chunk, as described in section [3.1.5.2](#).
4. As Machine A receives the chunk signatures from Machine B, it compares the received signatures against the set of signatures $\text{Sig}A_1, \dots, \text{Sig}A_m$ that it has computed on its seed file (that is, *file* f_A) in step 2. As part of this comparison, Machine A records every distinct signature value it received

from Machine B that does not match one of its own signatures SigA_k computed on the chunks of file f_A .

5. Machine A sends a request to Machine B for all the chunks whose signatures were received in the previous step from Machine B, but that did not have a matching signature on Machine A. The chunks are requested by offset and length in file f_B based on corresponding information that was sent in step 2.
6. Machine B sends the contents of the requested chunks to Machine A.
7. Machine A reconstructs file f_B by using the chunks received in step 6 from Machine B, as well as its own chunks of file f_A that matched signatures sent by Machine B in step 4. After this reconstruction step is complete, Machine A has completed the transfer of f_B .

RDC takes advantage of the fact that a list of signatures can be treated as a binary large object (BLOB), and therefore can be treated as a signature file, which is amenable to RDC. Thus, a recursive application of RDC is possible by feeding the signature file obtained in step 2 to RDC. This is useful in cases in which the file to be transferred is so large that even its signature file is large relative to the set of bytes that have changed.

1.4 Relationship to Other Protocols

RDC is not a protocol, but provides a way for other protocols to increase their efficiency when these protocols are involved in moving files from one machine to another. The Distributed File System (DFS) replication system [\[MS-FRS2\]](#) is the only application that currently uses RDC.

1.5 Prerequisites/Preconditions

None.

1.6 Applicability Statement

RDC can be used any time it would be helpful to store or transfer the differences between a source and a set of seeds instead of storing or transferring the source file in its entirety. RDC is only useful when there is data in common between the files being compared. However, RDC is the compression and differencing algorithm and is in no way involved with the actual data transfer.

An example of when it may be helpful to use RDC is when individuals collaborate on shared documents over a wide-area, low-bandwidth network. During a round of edits, it is advantageous to work on a local copy of the shared document. Thus, the shared document should be copied between the involved sites when a different editor takes over. Instead of copying over the entire contents of the document, it might be beneficial to copy over only what has been edited.

1.7 Versioning and Capability Negotiation

RDC supports versioning through a version number in the signature header. See section [2.2.1.1](#).

1.8 Vendor-Extensible Fields

None.

1.9 Standards Assignments

None.

2 Messages

2.1 Transport

Because RDC is an algorithm, it does not have a defined transport. It is entirely up to the application using RDC to define a transport mechanism, if required.

2.2 Message Syntax

This section defines the format of the files that RDC uses between the target location and source location.

All multibyte integers represented in this document are in least-significant-byte-first order, colloquially called little-endian.

All integer constants that appear are in decimal, unless otherwise noted.

2.2.1 Common Data Types

2.2.1.1 RdcVersion

RdcVersion represents a version of RDC and is used to determine whether two versions of RDC, possibly on different machines, can interoperate.

The RdcVersion structure is defined as follows.

0	1	2	3	4	5	6	7	8	9	10	11	12	13	14	15	16	17	18	19	20	21	22	23	24	25	26	27	28	29	30	31
LibraryVersion																BuildNumber															

LibraryVersion: A 16-bit unsigned integer that indicates the version of the RDC implementation. The value of LibraryVersion MUST be set to 0x0001.

BuildNumber: A 16-bit unsigned integer that indicates the version of the software implementing the algorithm. The value of BuildNumber MUST be set to 0x0001.

2.2.1.2 FileHeader

The FileHeader structure represents the header of a signature file, which is defined in section [2.2.2](#).

The FileHeader structure is defined as follows.

0	1	2	3	4	5	6	7	8	9	10	11	12	13	14	15	16	17	18	19	20	21	22	23	24	25	26	27	28	29	30	31
HeaderSize																															
Version																															
MinVersionRequired																															

Padding
FileType
FileType (continued)

HeaderSize: The size of the FileHeader structure in bytes. MUST be 0x00000018.

Version: The version of RDC that generated this signature file. See section [2.2.1.1](#).

MinVersionRequired: An RdcVersion representing the lowest version of RDC that can understand this signature file. See section [2.2.1.1](#). It MUST be 0x00010001.

Padding: Reserved for future use; MUST be 0, and ignored on receipt.

FileType: An unsigned 64-bit integer that indicates the RDC file type of a *file*. The value of FileType MUST be set to 0x00000001.

2.2.2 Signature Files

The signature file consists of a header and zero or more RDC chunk signatures, as shown in the following diagram.

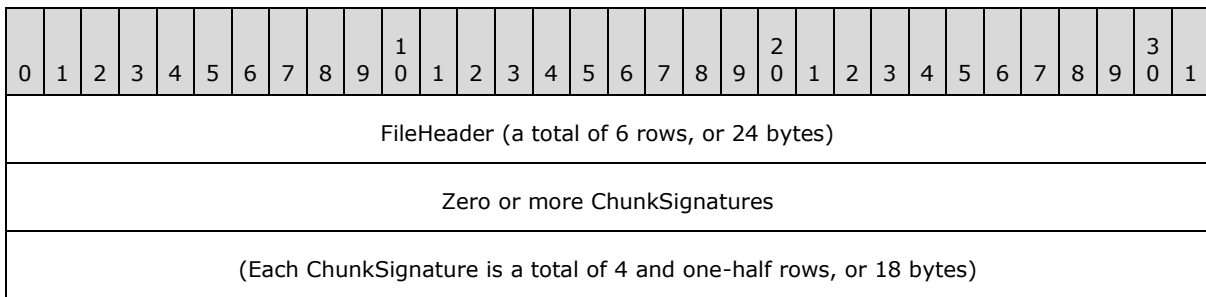

FileHeader: A FileHeader structure, as specified in section [2.2.1.2](#). The FileType field of the FileHeader structure MUST be 1 for a signature file.

ChunkSignatures: Zero or more ChunkSignatures. See section [2.2.2.1](#).

2.2.2.1 ChunkSignature

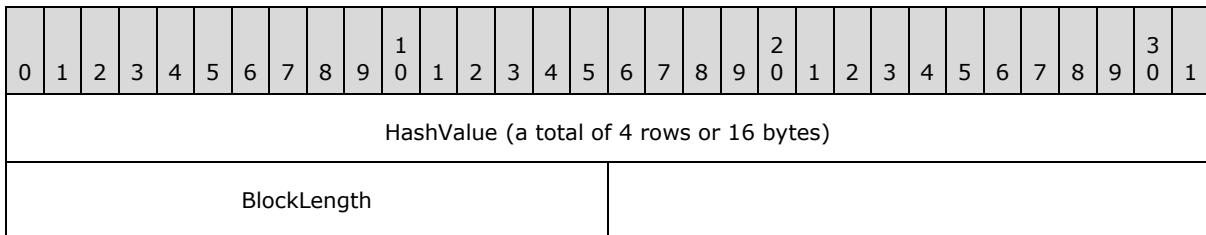

HashValue: MUST be the **MD4** digest of a data chunk.

BlockLength: A 16-bit unsigned integer that contains the length of the data chunk that is represented by this signature. The block length MUST be nonzero.

Bits 16–31 of the Last Row: Because a signature is 18 bytes long, and because the 32-bit width of the rows in the diagram does not evenly divide into 18 bytes, the last 16 bits of the diagram is space that is not part of the signature at all. This fact is represented by an empty area in the preceding diagram.

2.2.3 Similarity Data

Applications of RDC can include similarity data in their network protocols. The format of the similarity data is as follows.

0	1	2	3	4	5	6	7	8	9	10	11	12	13	14	15	16	17	18	19	20	21	22	23	24	25	26	27	28	29	30	31
t0								t1								t2								t3							
t4								t5								t6								t7							
t8								t9								t10								t11							
t12								t13								t14								t15							

t0 Through t15: Similarity traits. See section [3.1.5.4](#). Each **similarity trait** is an 8-bit unsigned integer value.

3 Protocol Details

3.1 Common Details

The target location and source location **MUST** compute identical signatures for identical chunks, and both the target location and source location **MUST** use the same algorithm and the same parameters for dividing files into chunks. The **RDC FilterMax algorithm** is used to divide files into chunks, as described in section [3.1.5.1](#). The specific parameters used as input to FilterMax are the responsibility of the user of RDC, and are not addressed in this document. This section specifies these processes.

3.1.1 Abstract Data Model

This section describes a conceptual model of possible data organization that an implementation maintains in order to use this algorithm. The described organization is provided to facilitate the explanation of how the algorithm behaves. This document does not mandate that implementations adhere to this model as long as their external behavior is consistent with what is described in this document.

H3 Lookup Table: A table containing 256 entries of 32-bit, unsigned integers used in computing the H3 hash function. The entries to the table are indexed from 0 through 255. This table is constant (that is, the values in this table do not change during the execution of RDC).

3.1.2 Timers

There are no timers in the RDC chunking and signature generation components.

3.1.3 Initialization

After initialization, the H3 lookup table **MUST** contain the following data.

Index	Values			
0	0x5e3f7c48	0x796a0d2b	0xbecd4e32	0x6f16159c
4	0x687312bc	0x12a6f30a	0x8fca2662	0x79b83d14
8	0x3fab3f30	0x984d6ca2	0x4df5fe6c	0x4acd3196
12	0x6245ad21	0x3a15e5ba	0x90db6499	0x05aacb6b
16	0x791cf724	0x504cd910	0x98093570	0x090392df
20	0xf193e5b8	0x42023c5b	0x80a95c6a	0x11e676be
24	0xc70f2117	0xeed4587f	0x6479e9bd	0x1b0c427c
28	0x410486ba	0x30f5b837	0xf957d307	0x1535f121
32	0xabe45e90	0x7a1ab8f0	0x1c6887e4	0x4170b7ba
36	0x8b491bed	0x5c920e73	0x1b1ed791	0x7a0ed482
40	0xcce86619	0x45dc7290	0x57e71362	0x2e24f01c
44	0x0a0637f3	0x0e8c5565	0x15944012	0x34f7eeea

Index	Values			
48	0xbc628141	0x1e200874	0xe9244379	0x3e63aeca
52	0x7a3b3cce	0x73f8a245	0xd734e215	0x834fa434
56	0xf96a0904	0xfb39a424	0x0bfa963a	0x9b236ee2
60	0xa2131005	0x3eb70acf	0x2907bcd8	0x3f685f3a
64	0x3765fd37	0x1c1c34d2	0x03a95179	0x024be6c3
68	0x06128960	0x844e7490	0xe2b371a3	0x3382909c
72	0x3d519a77	0x90971ec9	0x6ea745e5	0x490b3a5c
76	0x7f3916f7	0xbc150351	0x241a7ba0	0xec93c2bb
80	0x6c7083aa	0xf3937751	0xe6aa1df1	0x129fc001
84	0xb90709b9	0x7e59a4fc	0x4509e58a	0x8a93ed43
88	0x6934ce62	0x8ec6af1a	0xf36581a9	0x53d01d93
92	0xb34eef69	0x08494a84	0x0f6dff34	0x74729aa3
96	0x48b5475f	0xb986dc84	0xd0424c8d	0xb72ad089
100	0x0adbdb8	0x824fdb8	0x99ad1058	0x98faec38
104	0xe746242b	0x2b7ee7fc	0x2e151fa7	0x6413270f
108	0x68ed7239	0x7729e2d3	0x5697b3a5	0x0b90a6c3
112	0xdf7cefcf	0xded46a48	0x46956888	0xb3bb6dc4
116	0xe987578f	0xf82e74b7	0xc8eeeba4	0xdd960ff9
120	0x482ed28d	0x4f343078	0x563ab8a4	0x3ec7aa0d
124	0x2481d448	0x5fe98704	0x5aafc580	0x841d81ec
128	0xae7fe8fd	0x6b31ccb6	0x911ebdd4	0x75f4703d
132	0xe6855a0f	0x6184b42e	0x147a4a95	0x39528e48
136	0xe975b416	0x3cba13d3	0x1e23e544	0xf7955286
140	0xa5f96b7f	0xaa697aa	0x29e794e3	0x87628c09
144	0xfebf5f1	0xf8b070cd	0xe361b627	0x8c7a8682
148	0x69cab331	0xca867ad1	0xd0151a96	0xfc19a6b9
152	0x6d7439e7	0x64cd62ac	0x4a650747	0x9ddbfa28
156	0x337c8bed	0xf12a6860	0x3767ffd3	0x13559ced
160	0x71ac2011	0xc11dc687	0x260b7105	0xc13bca0c
164	0xcd0af893	0x793b54e6	0x89d27fc3	0xc6bd1c88

Index	Values			
168	0xe3337313	0x387bc671	0x61280de4	0x76941a36
172	0xaa52a2b9	0x6d7cb52c	0x18ff4d70	0x8987cf38
176	0x306e47ed	0xf7df8135	0x18a8e024	0xc9eb085f
180	0xc1a7c769	0xd5667a12	0x9c8be93a	0x028781b1
184	0x6213dada	0x07fef4f5	0x5e6bf91d	0x469ea798
188	0xb9654a37	0x1cb5e74e	0x525d502d	0xe805ec68
192	0xdd8c4320	0x7890848f	0x61e59c8e	0x1d99f9ef
196	0x25b60b20	0x2f198088	0xe01b6926	0xffa4917f
200	0xb2fa0f22	0xee8ac924	0x18a1c5a7	0xb76d8d7f
204	0x88ad5e0d	0x7b3fb12b	0xc8a91add	0x762a6f4e
208	0x056fad31	0xebecfab8	0xea54cd17	0x71f5af9f
212	0xfaeeca1	0x08a52f4d	0xbb5efebe	0x5bc04c2
216	0xcb2530b0	0x01bb862b	0xbb5d54f0	0x404deb4b
220	0x038658bd	0x09399005	0xdd862c8	0x8985776f
224	0xcfcfd717	0xbec756cb	0x52aecc5a	0x09ac3f62
228	0x62c1c6fb	0x76cc3221	0xcde6d028	0x844d9291
232	0xc143eeac	0x0ea5e772	0x8855456e	0xeb03a426
236	0x3398475d	0x73dc8107	0x681605d0	0xd18b6264
240	0x934e43eb	0x59e76d21	0xd3ce2b77	0x4ccfee1c
244	0x2f4af76d	0x8b12a309	0x849bb415	0xf45ad809
248	0xc7bcca7	0xac891c35	0x59db2274	0xbcd71393
252	0x2c9b1705	0xcb536a69	0xb2800f00	0x111313fc

The H3 lookup table is constant and so MUST NOT change at any time.

Note This data can be generated by setting the first 16 bytes of the table (that is, the first four 32-bit unsigned integers) to the MD4 hash of 16 bytes of zeros. Each successive 16 bytes of the table is the MD4 hash of the previous 16 bytes of the table. Implementing this procedure results in running the MD4 hash 64 times.

3.1.4 Higher-Layer Triggered Events

There are no higher-layer triggered events in the RDC chunking and signature generation components.

3.1.5 Message Processing Events and Sequencing Rules

Because RDC is not a protocol, it does not have messages. Instead, this section specifies the actions upon getting a request to determine the chunk boundaries in a file, or to compute the signature for a chunk.

This section contains a number of instances of pseudocode. In this pseudocode, operator precedence is the same as in the C language. The symbol "!=" is used for assignment, meaning that the variable appearing to the left of "!=" thereafter assumes the value to the right. The symbol "\" indicates a set difference, and is usually pronounced as the English word "without." For example, $\{a,b,c\} \setminus \{b\} = \{a,c\}$.

3.1.5.1 Chunk Generation

This section specifies the RDC FilterMax algorithm, which is used to generate chunks.

RDC chunk generation is initiated by the protocol or application that is using RDC for efficient data transfer. For an example, see [\[MS-FRS2\]](#) section 3.3.1.5.

RDC chunk generation takes as input a file and two parameters, the hash window and the horizon, and produces a set of offsets into the file that indicates the start of the chunks of the file. Prior to their use, the hash window and the horizon MUST be negotiated between the source location and target location of the file to ensure that chunks are generated consistently on both ends. Negotiation of hash window and horizon is application-specific and is not addressed in this document. [<1>](#)

The following diagram illustrates chunk generation.

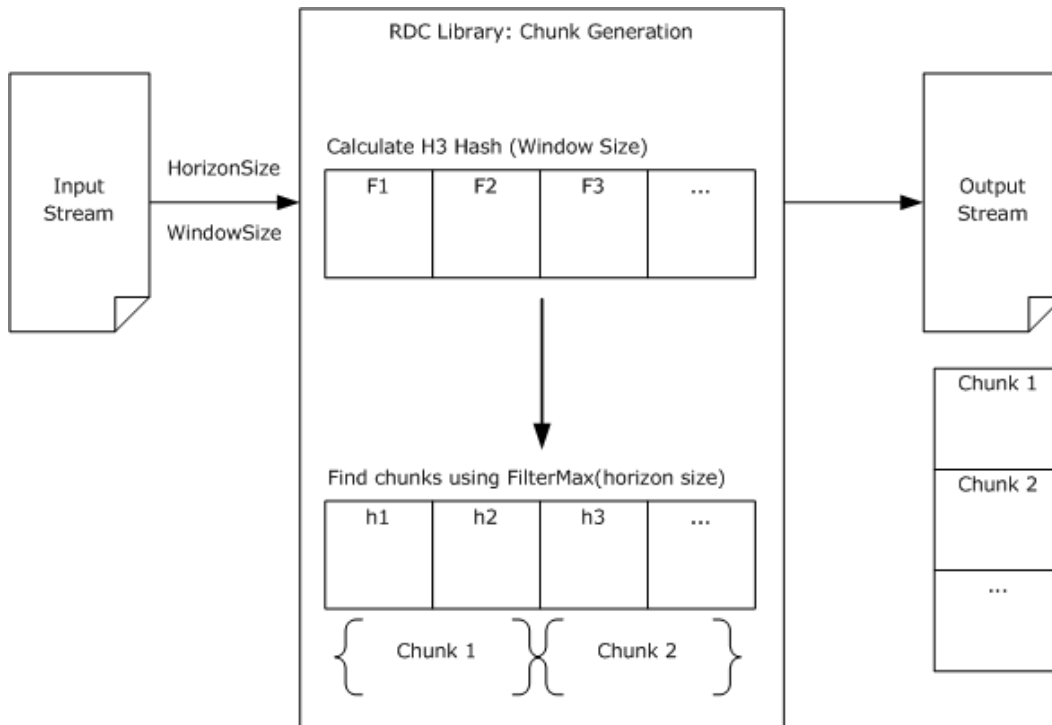

Figure 1: RDC chunk generation

With each chunk, RDC computes a signature. See section [3.1.5.2](#).

3.1.5.1.1 H3 Hash

RDC uses a **rolling hash function** called H3 in determining its chunk boundaries. H3 computes the hash of the hash window bytes (denoted as `windowSize` below) up to and including a particular byte in the file. Because it is a rolling hash function, the H3 hash of a given range is defined in terms of the hash of the range starting and ending 1 byte earlier.

`shift_amount` is an unsigned 32-bit integer that depends only on `windowSize`, and is used in computing H3. The `shift_amount` is calculated as follows.

```
shift_amount := 1
i := 32
while ((i > 0) AND ((windowSize MODULUS i) ≠ 0))
BEGIN
    shift_amount := shift_amount times 2
    i := the integer truncation (floor) of (i divided by 2)
END
shift_amount := shift_amount MODULUS 32
```

`hash_valuei` is an unsigned 32-bit integer that contains a calculated hash value. By definition, `hash_value-1` is zero. Computing the H3 value for the `windowSize` byte ending at byte `i` depends on `hash_valuei-1`. For the purposes of H3, all data bytes before the beginning of the *file* are treated as having a value of 0.

`trailingEdgeData` and `leadingEdgeData` contain the data bytes (unsigned 8-bit integers) that are at the trailing edge and leading edge in a sequence of `windowSize` bytes. These data bytes become indices into the H3 lookup table for the purposes of the hash calculation.

To add `leadingEdgeData` to the hash value and remove `trailingEdgeData` (that is, to compute the H3 value of the `windowSize` bytes ending with the leading edge), compute the following.

Note Subscripts are expressed with parentheses (for example, "`hash_valuei`" would be expressed as "`hash_value(i)`").

```
hash_value(i) :=
    rotate_bits_left(
        hash_value(i-1) XOR
        H3 lookup table[trailingEdgeData] XOR
        H3 lookupTable[leadingEdgeData],
        shift_amount
    )
```

This becomes the new `hash_value` for moving the window 1 byte farther along.

Note that when processing near the beginning of the *file* (when the leading edge is less than the hash window), the trailing edge will actually be less than zero (before the beginning of the *file*). In this case, H3 considers this nonexistent data to be all zeros.

The following pseudocode shows how `hash_value` is computed for each offset `i`.

Note Subscripts are expressed with parentheses (for example, "`hash_valuei`" would be expressed as "`hash_value(i)`").

```

hash_value(-1) := 0
FOR i = 0 to min(windowSize-1, Length of the file - 1)
    hash_value(i) :=
        rotate_bits_left(
            hash_value(i-1) XOR
            H3 lookup table[0] XOR
            H3 lookup table[File[i]], shift_amount)

FOR i = windowSize to Length of File - 1
BEGIN
    trailingEdgeData := File[i - windowSize]
    leadingEdgeData := File[i]
    hash_value(i) :=
        rotate_bits_left(
            hash_value(i-1) XOR
            H3 lookup table[trailingEdgeData] XOR
            H3 lookup table[leadingEdgeData],
            shift_amount)
END

```

For an example of H3 hash calculation, see section [4.2](#).

3.1.5.1.2 Finding Chunk Boundaries

Given a file F of length n consisting of bytes $b_0 .. b_{n-1}$ and parameters *windowSize* and *horizon*, RDC finds the chunk boundaries. *windowSize* MUST be an integer that is at least 2 and no more than 96. *horizon* MUST be an integer that is at least 128 and less than 16,384. Recall that *windowSize* and *horizon* are inputs to RDC, and MUST be negotiated between the two parties participating in a transfer using RDC.

A byte b_i is a **local maximum** if $i > horizon$ and for all $j \neq i$ where $i - horizon \leq j \leq i + horizon$, the H3 hash value after adding b_i is greater than that after adding any b_j .

To determine the chunks of F , define the first chunk to start with b_0 . Work through each consecutive byte from b_1 to b_{n-1} . A chunk starts at a byte that is a local maximum or that is 65,535 bytes beyond the last byte that started a chunk.

Thus, the following is a recursive definition of chunk boundaries.

Note Subscripts are expressed with parentheses (for example, "hash_value_{*i*}" would be expressed as "hash_value(*i*)").

```

File position 0 is a chunk boundary

File position  $n > 0$  is a chunk boundary if:
    FORALL  $k$  in {  $n-horizon .. n+horizon$  } \ {  $n$  }
        hash_value( $n$ ) > hash_value( $k$ )
or
     $n - 65,535$  is greater than or equal to 0 and
     $n - 65,535$  is a chunk boundary and
    FORALL  $k$  in {  $n - 65,534 .. n - 1$  }
         $k$  is not a chunk boundary.

```

Note The "\" operator means exclusion; so in this construct, it means all values in the range except n .

Define boundary_{*i*} to be the *i*th chunk boundary.

3.1.5.2 Signature Computation

There are two fields in a chunk signature: hash and block length. Given a chunk, the hash MUST be the MD4 hash [\[RFC1320\]](#) of the data in the chunk, and the block length MUST be the number of bytes in the chunk. Because the block length is an unsigned 16-bit integer, all chunks MUST be less than or equal to $2^{16}-1$ bytes in length. Recall that the signatures comprise the data in the signature file.

The following diagram illustrates signature computation.

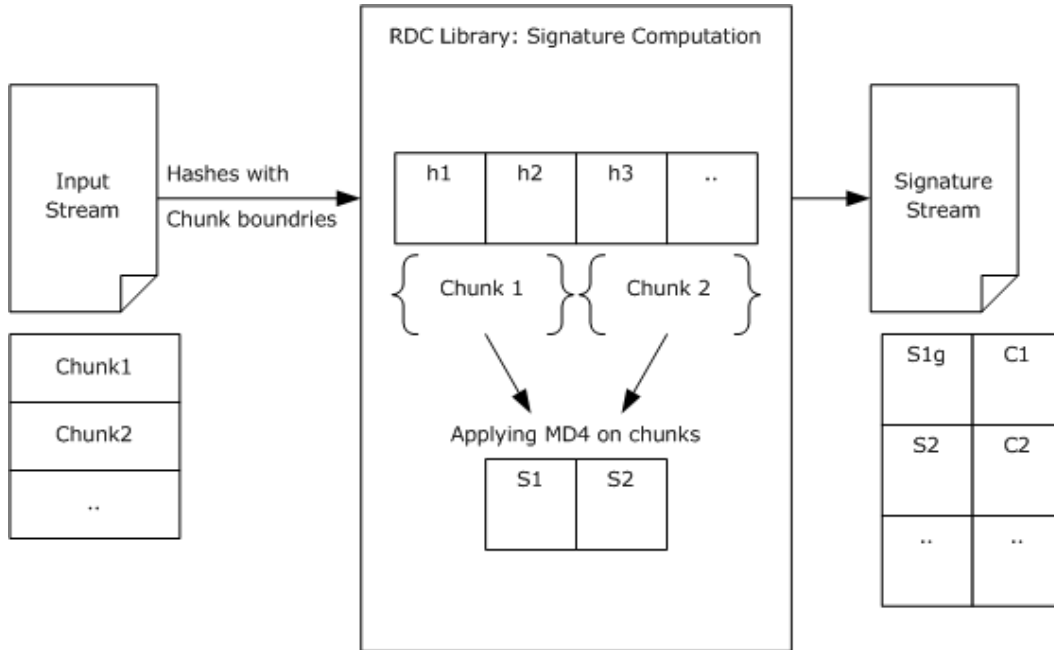

Figure 2: RDC signature computation

Thus, the set of signatures is specified by the following.

Note Subscripts are expressed with parentheses (for example, "boundary_i" would be expressed as "boundary(i)").

Let there be N chunks (0,1,.. N-1) defined on a file of size n

FOR each chunk consisting of bytes from

boundary(i) to boundary(i+1)-1 -(Initial Chunks where i < N-1)
 boundary(i) to n -(Terminal Chunk where i = N-1)

BEGIN

```

IF (Terminal Chunk)
  Signature Hash(i) :=
    MD4 of File[boundary(i)] ... File[n-1]
  Signature block Length(i) := n - boundary(i)
ELSE
  Signature Hash(i) :=
    MD4 of File[boundary(i)] ... File[boundary(i+1)-1]
  
```

Signature block Length(i) := boundary(i+1) - boundary(i)

END

3.1.5.3 Recursion

Just as RDC can be used to determine the differences between the two original *files*, RDC can first be applied to determine the differences between the two signature *files*, or between the signature *files* of the signature *files*, and so on. This is called recursion.

The following diagram illustrates recursion.

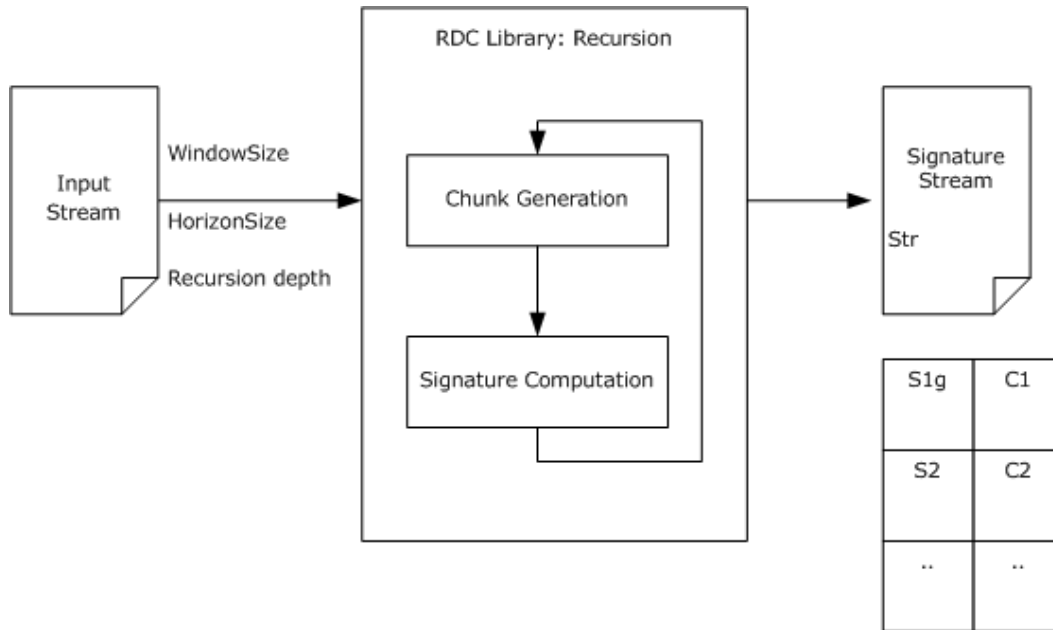

Figure 3: RDC recursion

For an example of recursion, see section [4.4](#).

3.1.5.3.1 Recursion Depth

An implementation MUST support a recursion depth of at least eight levels. [<2>](#) The depth of recursion that an application uses depends on the size of the signature *file* that is being transferred versus how many chunks of the signature *file* are required to be transferred for each **recursion level**. The application must determine when bandwidth would be better utilized by just sending a bigger signature *file* to avoid another round of signature data transfer.

The determination of recursion depth is application-specific, and is not addressed in this document. For an example of the determination of recursion depth, see [\[MS-FRS2\]](#) section 3.3.1.5.

3.1.5.4 Similarity

The effectiveness of data replication using RDC techniques depends to a large degree on the seed files that can be found at the target location. If the RDC scenario is simple, such as the synchronization of a *file* that has been replicated recently, the choice of seed file can be as simple as

the *file* that is being synchronized. If the RDC scenario is more complicated, such as the replication of a directory of *files*, it is possible that *files* have been added to the source location that do not exist on the target location, in which case there is no simple choice of seed files.

To help choose seed files under the circumstances outlined in the preceding paragraph, similarity data for new *files* at the source location are calculated and sent to the target location. The similarity data is used on the target location to find existing *files* that are similar to the new source location *files*. The existing target location *files* can then become the seed files for an RDC replication of the new source location *files*, making the transfer of the new *files* more efficient.

Similarity data can appear in protocols that use RDC, but it has no other effect on the protocol itself. <3> Recall that similarity data can be used for identifying a seed file on the target location. For examples of the use of similarity data, see [MS-FRS2] sections 1.7, 2.2.1.2.1, and 2.2.1.4.4.

The following diagram illustrates the calculation of similarity data.

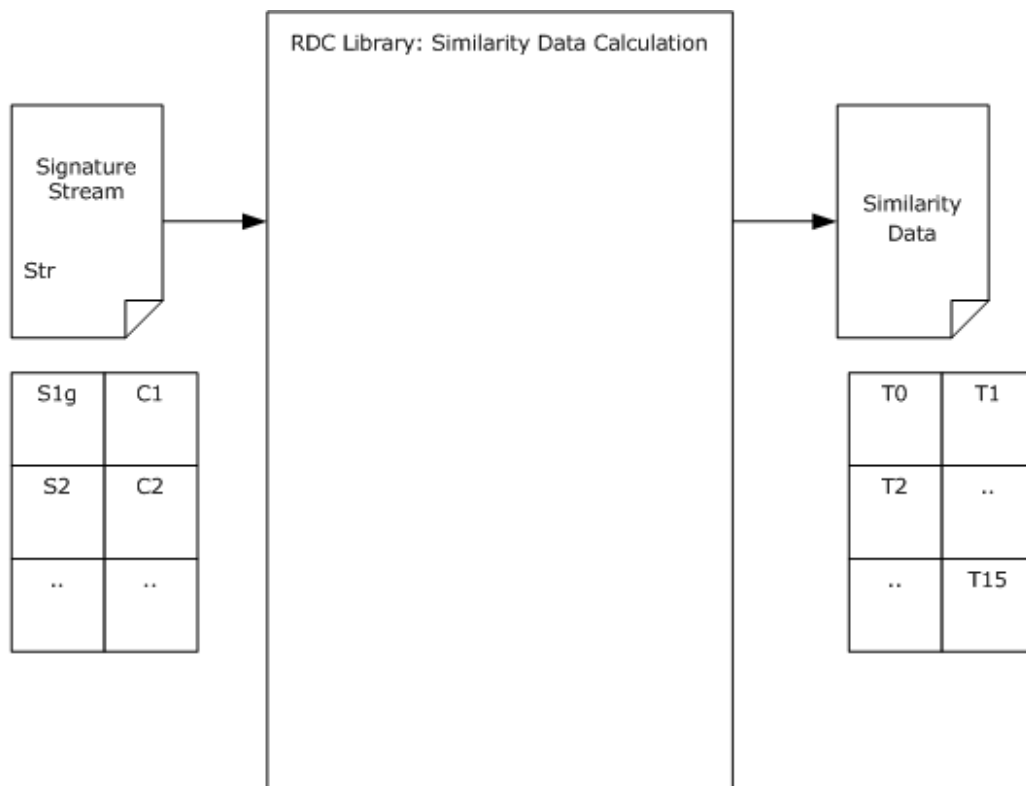

Figure 4: Similarity data calculation

3.1.5.4.1 Similarity Data Calculation

Given a file F to calculate the similarity data, a 16-byte array is required to store intermediate MD4 digests. The data construct is called a digest for the purpose of this discussion. The calculation of similarity data for a file is expressed using the following pseudocode.

```

Define Digest as unsigned char[16]
Digest md4Results
Digest sData[16] =
  { {0xff, 0xff, ..., 0xff},

```

```

    {0xff, 0xff, ..., 0xff},
    ...,
    {0xff, 0xff, ..., 0xff} }

unsigned char tempBuffer[17]

FOR each RDC Signature of a File
BEGIN
    Copy the RDC Signature data into tempBuffer
    FOR index = 0 to 15
    BEGIN
        tempBuffer[16] := index + 1
        Compute an MD4 digest for the data in tempBuffer,
        put the results in md4Results
        IF md4Results < sData[index]
            Copy the MD4 digest from md4Results to sData[index]
    END
END
END

```

The less-than comparison "md4Results < sData[index]" is a byte-by-byte comparison. For example, given A and B (two digests), the digests are considered as arrays of 16 unsigned 8-bit integers, where A_0 is the first byte and A_{15} is the last byte of A. $A < B$ is true if the first A_i that is different from B_i is less than B_i for values of i in 0 to 15.

Once all RDC signatures for a file have been processed, the similarity data is extracted from the array of temporary digest constructs (named sData in the preceding pseudocode). The similarity data is constructed by taking the 8th byte from each of the 16 digests computed in the preceding pseudocode and masking off the top 2 bits. This is shown in the following pseudocode.

```

unsigned char similarity[16]

FOR index = 0 to 15
    similarity[index] := sData[index, 7] & 0x3F

```

The data in similarity, shown in the preceding pseudocode, is the similarity data for the file.

Each trait of similarity data MUST be a value from 0 to 63 inclusive.

An implementation that does not compute similarity data MUST fill in all traits as zero.

3.1.5.4.2 Finding Seed Files

Using the similarity data that has been calculated for *files* on the target location, it may be possible to find RDC seed files for *files* that have been added to the source location but not to the target location. Similarity data consists of 16 bytes of data called similarity traits.

When the source location has a new *file* that requires replication on the target location, the application on the source location can send the similarity data of the new *file* to the target location. The application on the target location compares the similarity traits of the new *file* to the similarity traits of each of the target location's existing *files*, counting the similarity traits that are the same (that is, that match). The application can then determine which of the existing *files* are used as seed, based on the number of similarity trait matches; for example, based on a threshold or a majority scheme. The choice of what scheme is used is implementation-specific. [<4>](#)

Note that similarity traits are compared on a one-to-one basis so that there are at most 16 comparisons for each target location *file*. That is, the first similarity trait of the new *file* is compared to the first similarity trait of a target location *file*, the second similarity trait is compared to the second similarity trait, and so on.

Any number of target location *files* can be used as seed files for an RDC operation. Target location *files* with the greatest number of similarity traits that match the similarity traits of the new source location *file* are generally the best candidates.

3.1.5.5 Generating the Target File

To generate a **target file**, the protocol using RDC MUST obtain a signature file from the source location, and MUST select one or more seed files on the target location. The seed files can be selected in any vendor-specific manner, including using similarity data, as described in section [3.1.5.4](#).

The target location then reconstructs the target file by obtaining the necessary chunks from the source file and combining them with existing chunks from the seed files. It is the responsibility of the protocol using RDC to transport the signature file and any chunks.

The following diagram illustrates generation of a target file.

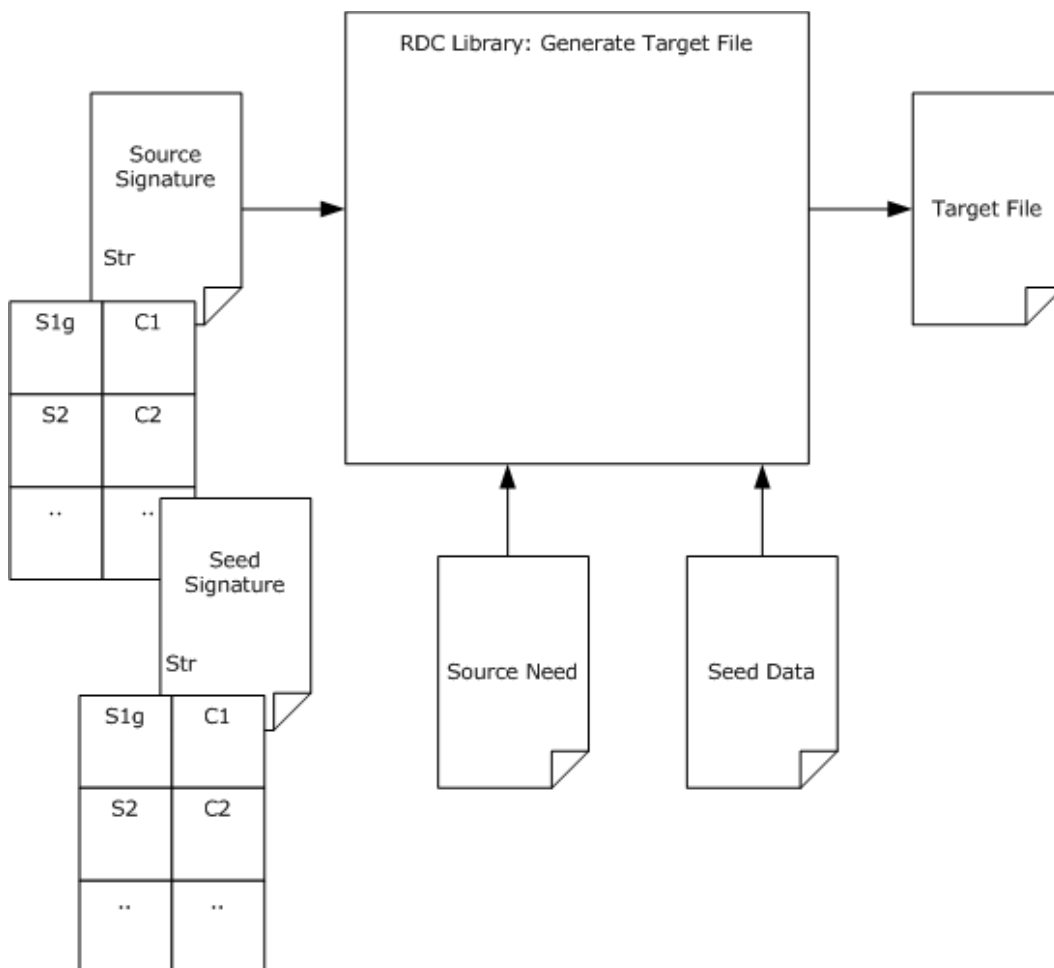

Figure 5: Generating the target file

The following pseudocode specifies the process of generating the target file. Note that each FOR loop iteration is independent of the others, and so may be executed concurrently.

Note Subscripts are expressed with parentheses (for example, "SouSig_i" would be expressed as "SouSig(i)").

```
Given n Source Signatures, SouSig(0) .. SouSig(n-1),
    and m Seed Signatures, SeedSig(0) .. SeedSig(m-1)
where each Signature has fields len and hash.

Produce Target File T, with bytes T(0) .. T(p)
where p is the sum of SouSig(i).len for all i in 0 .. n.

FOR i = 0 to n-1
BEGIN
    offset := sum SouSig(0) to SouSig(i).
    IF there exists j < m such that SeedSig(j).hash = SouSig(i).hash
        and SeedSig(j).len = SouSig(i).len
        T(offset) .. T(offset+SouSig(i).len) := the bytes from Chunk j
                                                of the seed.
    ELSE
    BEGIN
        Fetch Chunk i from the source location
        (how depends on the protocol using RDC).
        T(offset) .. T(offset+SouSig(i).len) := bytes from Chunk i
                                                of the Source.
    END
END
```

3.1.6 Timer Events

None.

3.1.7 Other Local Events

None.

4 Protocol Examples

4.1 Example System Architecture

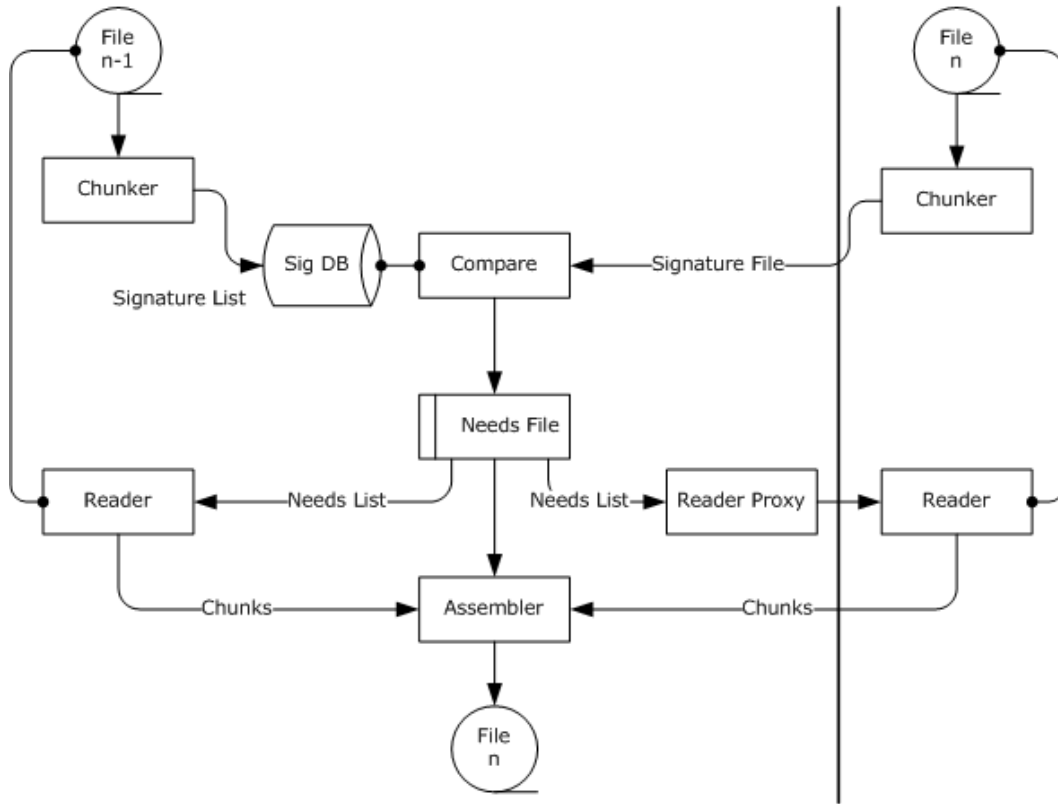

Figure 6: Data flow of RDC in an application

The preceding figure shows the data flow of a possible usage of RDC in an application. Note that there are other possible ways to utilize RDC in an application.

The following terms, in addition to the glossary terms defined in section [1.1](#), are used in this example.

Assembler: A function that constructs the target file using three inputs: needs lists, source chunks, and seed chunks.

Compare: A function that compares the signatures of the seed files and source files. After performing this comparison, the Compare function produces a list of needs.

Needs: A description of a block of data from either the source file or the seed file that is necessary to construct the target file.

Needs List: A list of needs in some application-defined format.

Reader: A function that reads chunks from a seed file or a source file as determined by the needs list.

Reader Proxy: A function that communicates with the reader on the source location.

The vertical line represents the network separation between two processes. The file to be transferred is hosted by the source service on the right (the source location for this example); the file is to be transferred to the target service on the left (the target location for this example).

Chunks of both the **seed data** and the corresponding **source data** are examined, and a signature is generated for each chunk. The signatures generated on the target location (that is, the seed signatures) can be stored using any mechanism. The signatures generated on the source location (that is, the source signatures) are sent to the target location in the form of a signature file.

The target location examines the source signatures. For each source signature, the target location tries to find a matching seed signature. If a matching seed signature is found, the target location already has the corresponding chunk of data and is not required to download it. If no matching seed signature can be found for a particular source signature, the target location must download the corresponding chunk of data from the source location.

When the target location has all of the data chunks (those it already had, and those it downloaded from the source location), the target location assembles the chunks in the order that corresponds to the signature file that was received from the source location.

For more information on the high-level aspects of RDC, see [\[MSDN-RDCAPI\]](#).

4.2 H3

This section gives an example of computing the H3 hashes of a sequence of 11 bytes of data with a windowSize of 4.

First, H3 must determine the appropriate shift_amount for a 4-byte windowSize. Applying the algorithm in section [3.1.5.1.1](#) yields a shift_amount of eight.

hash_value is initialized to 0x00, and the H3 algorithm starts at the first data byte. Recall that for the purposes of H3, all data bytes before the beginning of the file are treated as having 0 value. Therefore, in the example that follows, this is rotate_bits_left(0 XOR H3 Table[0] XOR H3 Table[0x48],8). Looking into the H3 table yields H3 Table[0] = 0x5e3f7c48 and H3 Table[0x48] = 0x3d519a77. Computing the XOR yields 0x636ee63f, and rotating left 8 bits yields 0x6ee63f63, which is the first H3 value, v0.

To compute v1, repeat the procedure using v0 as the initial hash_value; that is, rotate_bits_left(0x6ee63f63 XOR H3 Table[0] XOR H3 Table[0x65],8). H3 Table[0] = 0x5e3f7c48 and H3 Table[0x65] = 0x824fdbe8, so the result of the XOR is 0xb29698c3. Rotating yields v1 = 0x9698c3b2.

Because of the way shift_amount is computed, (windowSize * shift_amount) MODULUS 32 = 0. Therefore, when a byte is at the trailing edge of the window, the XOR with its corresponding table value is in the same position as when the table value was XORed in when it was at the leading edge. Furthermore, for all a, a XOR a = 0, so the second XOR cancels out the effect of the first one. Therefore, the H3 value for a window does not depend on any bytes outside the window, and H3 is a hash function.

The following diagram illustrates the computation of H3 hashes.

The hash values v0, v1, and so on represent the data bytes that are highlighted.

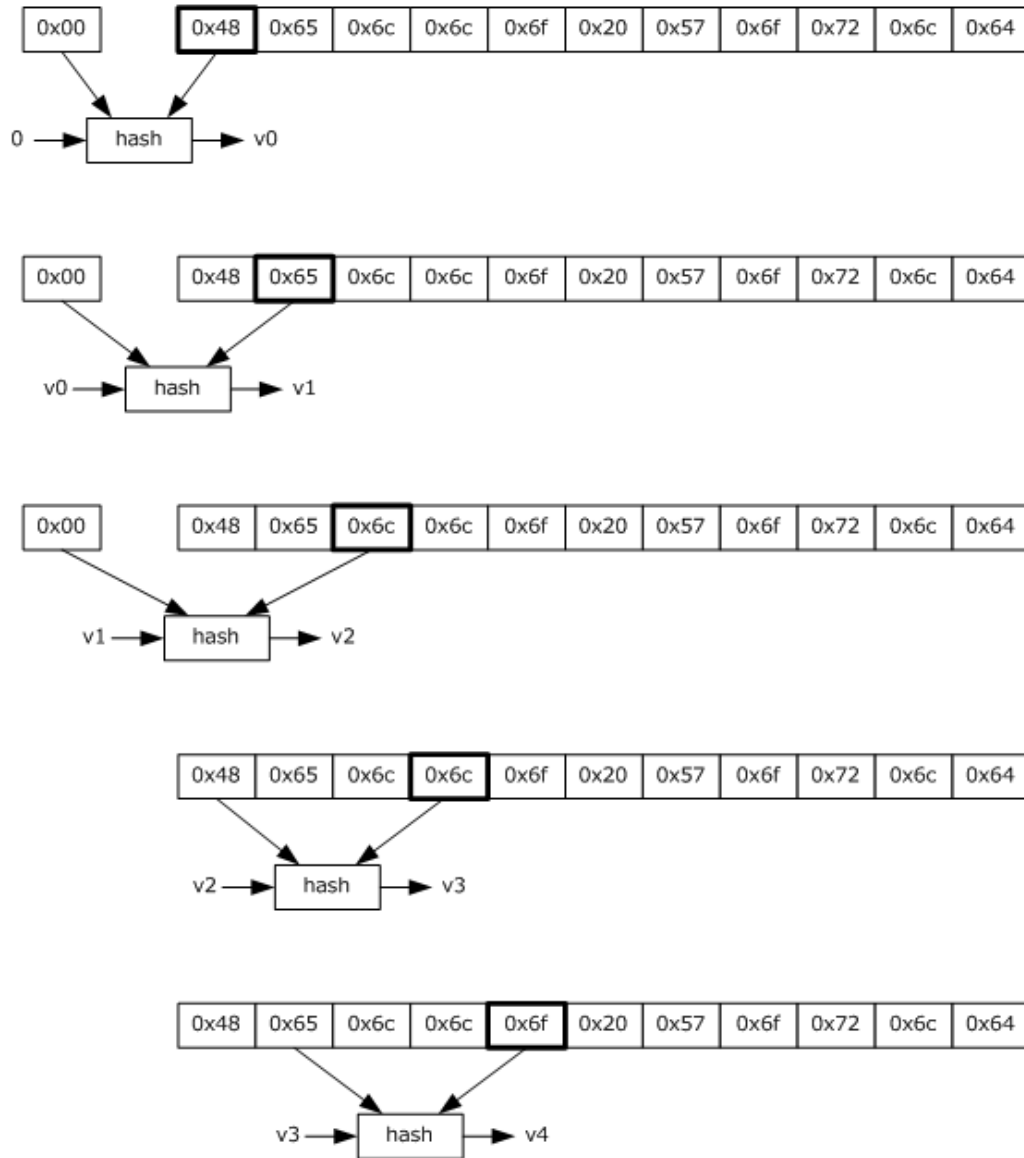

Figure 7: H3 hash computation

4.3 FilterMax

The relationship between local maximum and horizon is illustrated in the following figure, which assumes a horizon size of 128.

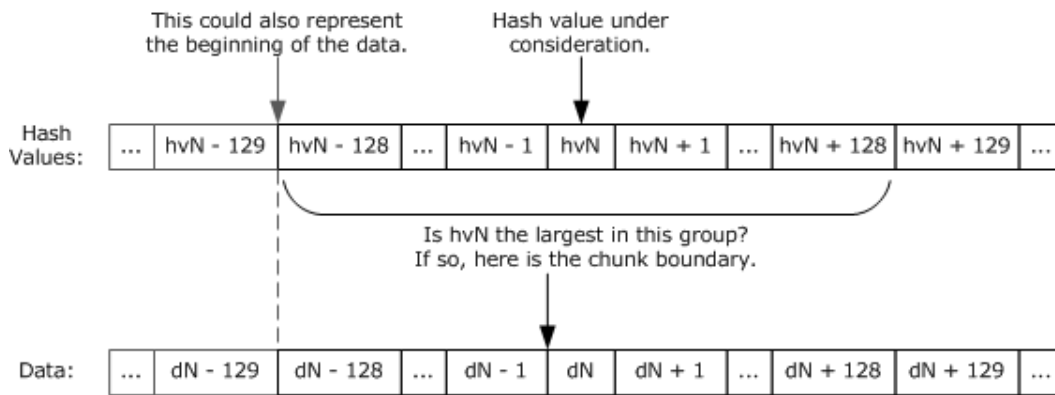

Figure 8: Relationship between local maximum and horizon

In the preceding diagram, consider if hvN is the largest in the indicated range of values. Then it follows that none of the other values in this range may be a local maximum (because they are smaller than hvN). Therefore, local maxima must be separated by at least horizon bytes.

4.4 Sample Recursive Client Transfer

This example illustrates the use of the RDC algorithm over a network protocol.

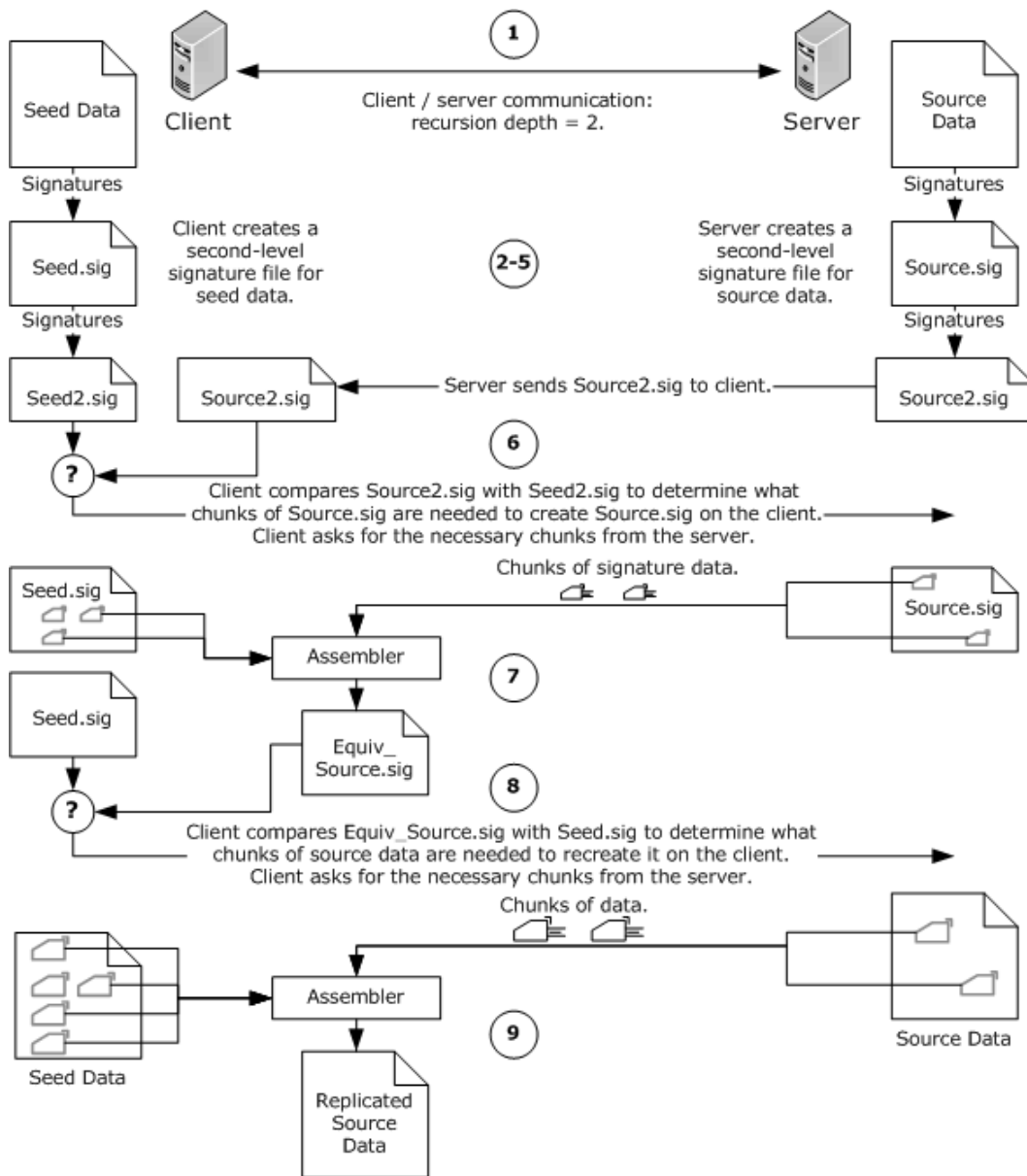

Figure 9: Recursion-depth calculation

A sample network application uses the following steps, which correspond to the preceding figure, to transfer data over the network using the RDC algorithm.

1. The target location (referred to here as **client**) and source location (referred to here as **server**) determine that a recursion depth of 2 is appropriate.

Notes:

- The RDC library allows the application to choose the recursion depth arbitrarily. Choosing an optimum recursion depth is difficult because many factors are involved, including the available network bandwidth and network latency, the speed and load of the disk storage systems on

the server and client machines, and available CPU time for computing signatures, if necessary. For an example of recursion-depth calculation, see [\[MS-FRS2\]](#) section 3.3.1.5.

- The terms client and server in this discussion refer only to the computers' roles in the RDC scenario, not to their operating systems.
 - The method used by the client and server to agree on recursion depth is application-specific.
2. The client generates signatures for the seed data and stores them in a *file* called seed.sig.
 3. The client generates signatures for seed.sig and stores them in a *file* called seed2.sig.
 4. The server generates signatures for the source data and stores them in a *file* called source.sig.
 5. The server generates signatures for source.sig and stores them in a *file* called source2.sig. The server then sends source2.sig to the client.
 6. The client examines the signatures in source2.sig, comparing them to the signatures in seed2.sig to determine the chunks of source.sig it requires.
 7. With source2.sig as a guide, the client creates a first-level signature file that is identical to source.sig (called equiv_source.sig for this example). Instead of transferring the entire source.sig *file* to the client, the much smaller source2.sig *file* is transferred along with the few pieces of source.sig that are required.
 8. The client examines the signatures in equiv_source.sig, comparing them to the signatures in seed.sig to determine the chunks of the source data it requires.
 9. With equiv_source.sig as a guide, the client recreates the source data using normal RDC techniques.

Using the preceding concepts, it may be possible to use a smaller amount of bandwidth to transfer the source data across the network. If, for example, the source data is approximately 9 gigabytes, the first-level signature file will be approximately 92 megabytes, but the second-level signature file will be only about 944 kilobytes.

4.5 Sample Input and Generated Signature File

To test an implementation, the following example of a source file (the full text of rfc1320.txt) is used, and the resultant signature file is generated using windowSize 16 and horizon 512.

File: rfc1320.txt displayed in hexadecimal format, 16 bytes per line.

```
00000000: 0d 0a 0d 0a 0d 0a 0d 0a 0d 0a 4e 65 74 77 6f 72
00000010: 6b 20 57 6f 72 6b 69 6e 67 20 47 72 6f 75 70 20
00000020: 20 20 20 20 20 20 20 20 20 20 20 20 20 20 20 20
00000030: 20 20 20 20 20 20 20 20 20 20 20 20 20 20 20 20
00000040: 20 20 20 20 20 20 20 20 20 52 2e 20 52 69 76 65
00000050: 73 74 0d 0a 52 65 71 75 65 73 74 20 66 6f 72 20
00000060: 43 6f 6d 6d 65 6e 74 73 3a 20 31 33 32 30 20 20
00000070: 20 20 20 20 20 20 20 20 20 4d 49 54 20 4c 61 62
00000080: 6f 72 61 74 6f 72 79 20 66 6f 72 20 43 6f 6d 70
00000090: 75 74 65 72 20 53 63 69 65 6e 63 65 0d 0a 4f 62
000000a0: 73 6f 6c 65 74 65 73 3a 20 52 46 43 20 31 31 38
000000b0: 36 20 20 20 20 20 20 20 20 20 20 20 20 20 20 20
000000c0: 20 20 20 20 20 20 20 20 20 20 20 61 6e 64 20 52
000000d0: 53 41 20 44 61 74 61 20 53 65 63 75 72 69 74 79
000000e0: 2c 20 49 6e 63 2e 0d 0a 20 20 20 20 20 20 20 20
```

000000f0: 20 20 20 20 20 20 20 20 20 20 20 20 20 20 20 20
00000100: 20 20 20 20 20 20 20 20 20 20 20 20 20 20 20 20
00000110: 20 20 20 20 20 20 20 20 20 20 20 20 20 20 20 20
00000120: 20 20 20 20 20 20 20 41 70 72 69 6c 20 31 39 39 32
00000130: 0d 0a 0d 0a 0d 0a 20 20 20 20 20 20 20 20 20 20
00000140: 20 20 20 20 20 20 20 20 54 68 65 20 4d 44
00000150: 34 20 4d 65 73 73 61 67 65 2d 44 69 67 65 73 74
00000160: 20 41 6c 67 6f 72 69 74 68 6d 0d 0a 0d 0a 53 74
00000170: 61 74 75 73 20 6f 66 20 74 68 69 65 20 4d 65 6d
00000180: 6f 0d 0a 0d 0a 20 20 20 54 68 69 73 20 6d 65 6d
00000190: 6f 20 70 72 6f 76 69 64 65 73 20 69 6e 66 6f 72
000001a0: 6d 61 74 69 6f 6e 20 66 6f 72 20 74 68 65 20 49
000001b0: 6e 74 65 72 6e 65 74 20 63 6f 6d 6d 75 6e 69 74
000001c0: 79 2e 20 20 49 74 20 64 6f 65 73 0d 0a 20 20 20
000001d0: 6e 6f 74 20 73 70 65 63 69 66 79 20 61 6e 20 49
000001e0: 6e 74 65 72 6e 65 74 20 73 74 61 6e 64 61 72 64
000001f0: 2e 20 20 44 69 73 74 72 69 62 75 74 69 6f 6e 20
00000200: 6f 66 20 74 68 69 73 20 6d 65 6d 6f 20 69 73 0d
00000210: 0a 20 20 20 75 6e 6c 69 6d 69 74 65 64 2e 0d 0a
00000220: 0d 0a 41 63 6b 6e 6f 77 6c 65 67 65 6d 65 6e 74
00000230: 73 0d 0a 0d 0a 20 20 20 57 65 20 77 6f 75 6c 64
00000240: 20 6c 69 6b 65 20 74 6f 20 74 68 61 6e 6b 20 44
00000250: 6f 6e 20 43 6f 70 70 65 72 73 6d 69 74 68 2c 20
00000260: 42 75 72 74 20 4b 61 6c 69 73 6b 69 2c 20 52 61
00000270: 6c 70 68 20 4d 65 72 6b 6c 65 2c 0d 0a 20 20 20
00000280: 61 6e 64 20 4e 6f 61 6d 20 4e 69 73 61 6e 20 66
00000290: 6f 72 20 6e 75 6d 65 72 6f 75 73 20 68 65 6c 70
000002a0: 66 75 6c 20 63 6f 6d 6d 65 6e 74 73 20 61 6e 64
000002b0: 20 73 75 67 67 65 73 74 69 6f 6e 73 2e 0d 0a 0d
000002c0: 0a 54 61 62 6c 65 20 6f 66 20 43 6f 6e 74 65 6e
000002d0: 74 73 0d 0a 0d 0a 20 20 20 31 2e 20 45 78 65 63
000002e0: 75 74 69 76 65 20 53 75 6d 6d 61 72 79 20 20 20
000002f0: 20 20 20 20 20 20 20 20 20 20 20 20 20 20 20 20
00000300: 20 20 20 20 20 20 20 20 20 20 20 20 20 20 20 20
00000310: 20 20 20 20 20 20 20 20 20 20 20 20 20 31 0d 0a
00000320: 20 20 20 32 2e 20 54 65 72 6d 69 6e 6f 6c 6f 67
00000330: 79 20 61 6e 64 20 4e 6f 74 61 74 69 6f 6e 20 20
00000340: 20 20 20 20 20 20 20 20 20 20 20 20 20 20 20 20
00000350: 20 20 20 20 20 20 20 20 20 20 20 20 20 20 20 20
00000360: 20 20 20 20 20 20 20 32 0d 0a 20 20 20 33 2e 20
00000370: 4d 44 34 20 41 6c 67 6f 72 69 74 68 6d 20 44 65
00000380: 73 63 72 69 70 74 69 6f 6e 20 20 20 20 20 20 20
00000390: 20 20 20 20 20 20 20 20 20 20 20 20 20 20 20 20
000003a0: 20 20 20 20 20 20 20 20 20 20 20 20 20 20 20 20
000003b0: 20 32 0d 0a 20 20 20 34 2e 20 53 75 6d 6d 61 72
000003c0: 79 20 20 20 20 20 20 20 20 20 20 20 20 20 20 20
000003d0: 20 20 20 20 20 20 20 20 20 20 20 20 20 20 20 20
000003e0: 20 20 20 20 20 20 20 20 20 20 20 20 20 20 20 20
000003f0: 20 20 20 20 20 20 20 20 20 20 20 36 0d 0a 20 20
00000400: 20 52 65 66 65 72 65 6e 63 65 73 20 20 20 20 20
00000410: 20 20 20 20 20 20 20 20 20 20 20 20 20 20 20 20
00000420: 20 20 20 20 20 20 20 20 20 20 20 20 20 20 20 20
00000430: 20 20 20 20 20 20 20 20 20 20 20 20 20 20 20 20
00000440: 20 20 20 20 20 36 0d 0a 20 20 20 41 50 50 45 4e
00000450: 44 49 58 20 41 20 2d 20 52 65 66 65 72 65 6e 63
00000460: 65 20 49 6d 70 6c 65 6d 65 6e 74 61 74 69 6f 6e
00000470: 20 20 20 20 20 20 20 20 20 20 20 20 20 20 20 20
00000480: 20 20 20 20 20 20 20 20 20 20 20 20 20 20 20 36
00000490: 0d 0a 20 20 20 53 65 63 75 72 69 74 79 20 43 6f

000004a0: 6e 73 69 64 65 72 61 74 69 6f 6e 73 20 20 20 20
000004b0: 20 20 20 20 20 20 20 20 20 20 20 20 20 20 20 20
000004c0: 20 20 20 20 20 20 20 20 20 20 20 20 20 20 20 20
000004d0: 20 20 20 20 20 20 20 20 32 30 0d 0a 20 20 20 41
000004e0: 75 74 68 6f 72 27 73 20 41 64 64 72 65 73 73 20
000004f0: 20 20 20 20 20 20 20 20 20 20 20 20 20 20 20 20
00000500: 20 20 20 20 20 20 20 20 20 20 20 20 20 20 20 20
00000510: 20 20 20 20 20 20 20 20 20 20 20 20 20 20 20 20
00000520: 20 20 32 30 0d 0a 0d 0a 31 2e 20 45 78 65 63 75
00000530: 74 69 76 65 20 53 75 6d 6d 61 72 79 0d 0a 0d 0a
00000540: 20 20 20 54 68 69 73 20 64 6f 63 75 6d 65 6e 74
00000550: 20 64 65 73 63 72 69 62 65 73 20 74 68 65 20 4d
00000560: 44 34 20 6d 65 73 73 61 67 65 2d 64 69 67 65 73
00000570: 74 20 61 6c 67 6f 72 69 74 68 6d 20 5b 31 5d 2e
00000580: 20 54 68 65 0d 0a 20 20 20 61 6c 67 6f 72 69 74
00000590: 68 6d 20 74 61 6b 65 73 20 61 73 20 69 6e 70 75
000005a0: 74 20 61 20 6d 65 73 73 61 67 65 20 6f 66 20 61
000005b0: 72 62 69 74 72 61 72 79 20 6c 65 6e 67 74 68 20
000005c0: 61 6e 64 20 70 72 6f 64 75 63 65 73 0d 0a 20 20
000005d0: 20 61 73 20 6f 75 74 70 75 74 20 61 20 31 32 38
000005e0: 2d 62 69 74 20 22 66 69 6e 67 65 72 70 72 69 6e
000005f0: 74 22 20 6f 72 20 22 6d 65 73 73 61 67 65 20 64
00000600: 69 67 65 73 74 22 20 6f 66 20 74 68 65 20 69 6e
00000610: 70 75 74 2e 0d 0a 20 20 20 49 74 20 69 73 20 63
00000620: 6f 6e 6a 65 63 74 75 72 65 64 20 74 68 61 74 20
00000630: 69 74 20 69 73 20 63 6f 6d 70 75 74 61 74 69 6f
00000640: 6e 61 6c 6c 79 20 69 6e 66 65 61 73 69 62 6c 65
00000650: 20 74 6f 20 70 72 6f 64 75 63 65 0d 0a 20 20 20
00000660: 74 77 6f 20 6d 65 73 73 61 67 65 73 20 68 61 76
00000670: 69 6e 67 20 74 68 65 20 73 61 6d 65 20 6d 65 73
00000680: 73 61 67 65 20 64 69 67 65 73 74 2c 20 6f 72 20
00000690: 74 6f 20 70 72 6f 64 75 63 65 20 61 6e 79 0d 0a
000006a0: 20 20 20 6d 65 73 73 61 67 65 20 68 61 76 69 6e
000006b0: 67 20 61 20 67 69 76 65 6e 20 70 72 65 73 70 65
000006c0: 63 69 66 69 65 64 20 74 61 72 67 65 74 20 6d 65
000006d0: 73 73 61 67 65 20 64 69 67 65 73 74 2e 20 54 68
000006e0: 65 20 4d 44 34 0d 0a 20 20 20 61 6c 67 6f 72 69
000006f0: 74 68 6d 20 69 73 20 69 6e 74 65 6e 64 65 64 20
00000700: 66 6f 72 20 64 69 67 69 74 61 6c 20 73 69 67 6e
00000710: 61 74 75 72 65 20 61 70 70 6c 69 63 61 74 69 6f
00000720: 6e 73 2c 20 77 68 65 72 65 20 61 0d 0a 20 20 20
00000730: 6c 61 72 67 65 20 66 69 6c 65 20 6d 75 73 74 20
00000740: 62 65 20 22 63 6f 6d 70 72 65 73 73 65 64 22 20
00000750: 69 6e 20 61 20 73 65 63 75 72 65 20 6d 61 6e 6e
00000760: 65 72 20 62 65 66 6f 72 65 20 62 65 69 6e 67 0d
00000770: 0a 20 20 20 65 6e 63 72 79 70 74 65 64 20 77 69
00000780: 74 68 20 61 20 70 72 69 76 61 74 65 20 28 73 65
00000790: 63 72 65 74 29 20 6b 65 79 20 75 6e 64 65 72 20
000007a0: 61 20 70 75 62 6c 69 63 2d 6b 65 79 20 63 72 79
000007b0: 70 74 6f 73 79 73 74 65 6d 0d 0a 20 20 20 73 75
000007c0: 63 68 20 61 73 20 52 53 41 2e 0d 0a 0d 0a 20 20
000007d0: 20 54 68 65 20 4d 44 34 20 61 6c 67 6f 72 69 74
000007e0: 68 6d 20 69 73 20 64 65 73 69 67 6e 65 64 20 74
000007f0: 6f 20 62 65 20 71 75 69 74 65 20 66 61 73 74 20
00000800: 6f 6e 20 33 32 2d 62 69 74 20 6d 61 63 68 69 6e
00000810: 65 73 2e 20 49 6e 0d 0a 20 20 20 61 64 64 69 74
00000820: 69 6f 6e 2c 20 74 68 65 20 4d 44 34 20 61 6c 67
00000830: 6f 72 69 74 68 6d 20 64 6f 65 73 20 6e 6f 74 20
00000840: 72 65 71 75 69 72 65 20 61 6e 79 20 6c 61 72 67

00000850: 65 20 73 75 62 73 74 69 74 75 74 69 6f 6e 0d 0a
00000860: 20 20 20 74 61 62 6c 65 73 3b 20 74 68 65 20 61
00000870: 6c 67 6f 72 69 74 68 6d 20 63 61 6e 20 62 65 20
00000880: 63 6f 64 65 64 20 71 75 69 74 65 20 63 6f 6d 70
00000890: 61 63 74 6c 79 2e 0d 0a 0d 0a 0d 0a 0d 0a 0d 0a
000008a0: 0d 0a 52 69 76 65 73 74 20 20 20 20 20 20 20 20
000008b0: 20 20 20 20 20 20 20 20 20 20 20 20 20 20 20 20
000008c0: 20 20 20 20 20 20 20 20 20 20 20 20 20 20 20 20
000008d0: 20 20 20 20 20 20 20 20 20 20 20 20 20 20 20 20
000008e0: 20 20 5b 50 61 67 65 20 31 5d 0d 0a 0c 0d 0a 52
000008f0: 46 43 20 31 33 32 30 20 20 20 20 20 20 20 20 20
00000900: 20 20 20 20 20 4d 44 34 20 4d 65 73 73 61 67 65
00000910: 2d 44 69 67 65 73 74 20 41 6c 67 6f 72 69 74 68
00000920: 6d 20 20 20 20 20 20 20 20 20 20 20 20 41 70 72
00000930: 69 6c 20 31 39 39 32 0d 0a 0d 0a 0d 0a 20 20 20
00000940: 54 68 65 20 4d 44 34 20 61 6c 67 6f 72 69 74 68
00000950: 6d 20 69 73 20 62 65 69 6e 67 20 70 6c 61 63 65
00000960: 64 20 69 6e 20 74 68 65 20 70 75 62 6c 69 63 20
00000970: 64 6f 6d 61 69 6e 20 66 6f 72 20 72 65 76 69 65
00000980: 77 20 61 6e 64 0d 0a 20 20 20 70 6f 73 73 69 62
00000990: 6c 65 20 61 64 6f 70 74 69 6f 6e 20 61 73 20 61
000009a0: 20 73 74 61 6e 64 61 72 64 2e 0d 0a 0d 0a 20 20
000009b0: 20 54 68 69 73 20 64 6f 63 75 6d 65 6e 74 20 72
000009c0: 65 70 6c 61 63 65 73 20 74 68 65 20 4f 63 74 6f
000009d0: 62 65 72 20 31 39 39 30 20 52 46 43 20 31 31 38
000009e0: 36 20 5b 32 5d 2e 20 20 54 68 65 20 6d 61 69 6e
000009f0: 0d 0a 20 20 20 64 69 66 66 65 72 65 6e 63 65 20
00000a00: 69 73 20 74 68 61 74 20 74 68 65 20 72 65 66 65
00000a10: 72 65 6e 63 65 20 69 6d 70 6c 65 6d 65 6e 74 61
00000a20: 74 69 6f 6e 20 6f 66 20 4d 44 34 20 69 6e 20 74
00000a30: 68 65 0d 0a 20 20 20 61 70 70 65 6e 64 69 78 20
00000a40: 69 73 20 6d 6f 72 65 20 70 6f 72 74 61 62 6c 65
00000a50: 2e 0d 0a 0d 0a 20 20 20 46 6f 72 20 4f 53 49 2d
00000a60: 62 61 73 65 64 20 61 70 70 6c 69 63 61 74 69 6f
00000a70: 6e 73 2c 20 4d 44 34 27 73 20 6f 62 6a 65 63 74
00000a80: 20 69 64 65 6e 74 69 66 69 65 72 20 69 73 0d 0a
00000a90: 0d 0a 20 20 20 6d 64 34 20 4f 42 4a 45 43 54 20
00000aa0: 49 44 45 4e 54 49 46 49 45 52 20 3a 3a 3d 0d 0a
00000ab0: 20 20 20 20 20 7b 69 73 6f 28 31 29 20 6d 65 6d
00000ac0: 62 65 72 2d 62 6f 64 79 28 32 29 20 55 53 28 38
00000ad0: 34 30 29 20 72 73 61 64 73 69 28 31 31 33 35 34
00000ae0: 39 29 20 64 69 67 65 73 74 41 6c 67 6f 72 69 74
00000af0: 68 6d 28 32 29 20 34 7d 0d 0a 0d 0a 20 20 20 49
00000b00: 6e 20 74 68 65 20 58 2e 35 30 39 20 74 79 70 65
00000b10: 20 41 6c 67 6f 72 69 74 68 6d 49 64 65 6e 74 69
00000b20: 66 69 65 72 20 5b 33 5d 2c 20 74 68 65 20 70 61
00000b30: 72 61 6d 65 74 65 72 73 20 66 6f 72 20 4d 44 34
00000b40: 0d 0a 20 20 20 73 68 6f 75 6c 64 20 68 61 76 65
00000b50: 20 74 79 70 65 20 4e 55 4c 4c 2e 0d 0a 0d 0a 32
00000b60: 2e 20 54 65 72 6d 69 6e 6f 6c 6f 67 79 20 61 6e
00000b70: 64 20 4e 6f 74 61 74 69 6f 6e 0d 0a 0d 0a 20 20
00000b80: 20 49 6e 20 74 68 69 73 20 64 6f 63 75 6d 65 6e
00000b90: 74 20 61 20 22 77 6f 72 64 22 20 69 73 20 61 20
00000ba0: 33 32 2d 62 69 74 20 71 75 61 6e 74 69 74 79 20
00000bb0: 61 6e 64 20 61 20 22 62 79 74 65 22 20 69 73 20
00000bc0: 61 6e 0d 0a 20 20 20 65 69 67 68 74 2d 62 69 74
00000bd0: 20 71 75 61 6e 74 69 74 79 2e 20 41 20 73 65 71
00000be0: 75 65 6e 63 65 20 6f 66 20 62 69 74 73 20 63 61
00000bf0: 6e 20 62 65 20 69 6e 74 65 72 70 72 65 74 65 64

00000c00: 20 69 6e 20 61 0d 0a 20 20 20 6e 61 74 75 72 61
00000c10: 6c 20 6d 61 6e 6e 65 72 20 61 73 20 61 20 73 65
00000c20: 71 75 65 6e 63 65 20 6f 66 20 62 79 74 65 73 2c
00000c30: 20 77 68 65 72 65 20 65 61 63 68 20 63 6f 6e 73
00000c40: 65 63 75 74 69 76 65 20 67 72 6f 75 70 0d 0a 20
00000c50: 20 20 6f 66 20 65 69 67 68 74 20 62 69 74 73 20
00000c60: 69 73 20 69 6e 74 65 72 70 72 65 74 65 64 20 61
00000c70: 73 20 61 20 62 79 74 65 20 77 69 74 68 20 74 68
00000c80: 65 20 68 69 67 68 2d 6f 72 64 65 72 20 28 6d 6f
00000c90: 73 74 0d 0a 20 20 20 73 69 67 6e 69 66 69 63 61
00000ca0: 6e 74 29 20 62 69 74 20 6f 66 20 65 61 63 68 20
00000cb0: 62 79 74 65 20 6c 69 73 74 65 64 20 66 69 72 73
00000cc0: 74 2e 20 53 69 6d 69 6c 61 72 6c 79 2c 20 61 20
00000cd0: 73 65 71 75 65 6e 63 65 20 6f 66 0d 0a 20 20 20
00000ce0: 62 79 74 65 73 20 63 61 6e 20 62 65 20 69 6e 74
00000cf0: 65 72 70 72 65 74 65 64 20 61 73 20 61 20 73 65
00000d00: 71 75 65 6e 63 65 20 6f 66 20 33 32 2d 62 69 74
00000d10: 20 77 6f 72 64 73 2c 20 77 68 65 72 65 20 65 61
00000d20: 63 68 0d 0a 20 20 20 63 6f 6e 73 65 63 75 74 69
00000d30: 76 65 20 67 72 6f 75 70 20 6f 66 20 66 6f 75 72
00000d40: 20 62 79 74 65 73 20 69 73 20 69 6e 74 65 72 70
00000d50: 72 65 74 65 64 20 61 73 20 61 20 77 6f 72 64 20
00000d60: 77 69 74 68 20 74 68 65 0d 0a 20 20 20 6c 6f 77
00000d70: 2d 6f 72 64 65 72 20 28 6c 65 61 73 74 20 73 69
00000d80: 67 6e 69 66 69 63 61 6e 74 29 20 62 79 74 65 20
00000d90: 67 69 76 65 6e 20 66 69 72 73 74 2e 0d 0a 0d 0a
00000da0: 20 20 20 4c 65 74 20 78 5f 69 20 64 65 6e 6f 74
00000db0: 65 20 22 78 20 73 75 62 20 69 22 2e 20 49 66 20
00000dc0: 74 68 65 20 73 75 62 73 63 72 69 70 74 20 69 73
00000dd0: 20 61 6e 20 65 78 70 72 65 73 73 69 6f 6e 2c 20
00000de0: 77 65 0d 0a 20 20 20 73 75 72 72 6f 75 6e 64 20
00000df0: 69 74 20 69 6e 20 62 72 61 63 65 73 2c 20 61 73
00000e00: 20 69 6e 20 78 5f 7b 69 2b 31 7d 2e 20 53 69 6d
00000e10: 69 6c 61 72 6c 79 2c 20 77 65 20 75 73 65 20 5e
00000e20: 20 66 6f 72 0d 0a 20 20 20 73 75 70 65 72 73 63
00000e30: 72 69 70 74 73 20 28 65 78 70 6f 6e 65 6e 74 69
00000e40: 61 74 69 6f 6e 29 2c 20 73 6f 20 74 68 61 74 20
00000e50: 78 5e 69 20 64 65 6e 6f 74 65 73 20 78 20 74 6f
00000e60: 20 74 68 65 20 69 2d 74 68 0d 0a 20 20 20 70 6f
00000e70: 77 65 72 2e 0d 0a 0d 0a 20 20 20 4c 65 74 20 74
00000e80: 68 65 20 73 79 6d 62 6f 6c 20 22 2b 22 20 64 65
00000e90: 6e 6f 74 65 20 61 64 64 69 74 69 6f 6e 20 6f 66
00000ea0: 20 77 6f 72 64 73 20 28 69 2e 65 2e 2c 20 6d 6f
00000eb0: 64 75 6c 6f 2d 32 5e 33 32 0d 0a 20 20 20 61 64
00000ec0: 64 69 74 69 6f 6e 29 2e 20 4c 65 74 20 58 20 3c
00000ed0: 3c 3c 20 73 20 64 65 6e 6f 74 65 20 74 68 65 20
00000ee0: 33 32 2d 62 69 74 20 76 61 6c 75 65 20 6f 62 74
00000ef0: 61 69 6e 65 64 20 62 79 20 63 69 72 63 75 6c 61
00000f00: 72 6c 79 0d 0a 20 20 20 73 68 69 66 74 69 6e 67
00000f10: 20 28 72 6f 74 61 74 69 6e 67 29 20 58 20 6c 65
00000f20: 66 74 20 62 79 20 73 20 62 69 74 20 70 6f 73 69
00000f30: 74 69 6f 6e 73 2e 20 4c 65 74 20 6e 6f 74 28 58
00000f40: 29 20 64 65 6e 6f 74 65 20 74 68 65 0d 0a 20 20
00000f50: 20 62 69 74 2d 77 69 73 65 20 63 6f 6d 70 6c 65
00000f60: 6d 65 6e 74 20 6f 66 20 58 2c 20 61 6e 64 20 6c
00000f70: 65 74 20 58 20 76 20 59 20 64 65 6e 6f 74 65 20
00000f80: 74 68 65 20 62 69 74 2d 77 69 73 65 20 4f 52 20
00000f90: 6f 66 20 58 0d 0a 20 20 20 61 6e 64 20 59 2e 20
00000fa0: 4c 65 74 20 58 20 78 6f 72 20 59 20 64 65 6e 6f

0000fb0: 74 65 20 74 68 65 20 62 69 74 2d 77 69 73 65 20
0000fc0: 58 4f 52 20 6f 66 20 58 20 61 6e 64 20 59 2c 20
0000fd0: 61 6e 64 20 6c 65 74 20 58 59 0d 0a 20 20 20 64
0000fe0: 65 6e 6f 74 65 20 74 68 65 20 62 69 74 2d 77 69
0000ff0: 73 65 20 41 4e 44 20 6f 66 20 58 20 61 6e 64 20

00001000: 59 2e 0d 0a 0d 0a 33 2e 20 4d 44 34 20 41 6c 67
00001010: 6f 72 69 74 68 6d 20 44 65 73 63 72 69 70 74 69
00001020: 6f 6e 0d 0a 0d 0a 20 20 20 57 65 20 62 65 67 69
00001030: 6e 20 62 79 20 73 75 70 70 6f 73 69 6e 67 20 74
00001040: 68 61 74 20 77 65 20 68 61 76 65 20 61 20 62 2d
00001050: 62 69 74 20 6d 65 73 73 61 67 65 20 61 73 20 69
00001060: 6e 70 75 74 2c 20 61 6e 64 20 74 68 61 74 0d 0a
00001070: 20 20 20 77 65 20 77 69 73 68 20 74 6f 20 66 69
00001080: 6e 64 20 69 74 73 20 6d 65 73 73 61 67 65 20 64
00001090: 69 67 65 73 74 2e 20 48 65 72 65 20 62 20 69 73
000010a0: 20 61 6e 20 61 72 62 69 74 72 61 72 79 0d 0a 20
000010b0: 20 20 6e 6f 6e 6e 65 67 61 74 69 76 65 20 69 6e
000010c0: 74 65 67 65 72 3b 20 62 20 6d 61 79 20 62 65 20
000010d0: 7a 65 72 6f 2c 20 69 74 20 6e 65 65 64 20 6e 6f
000010e0: 74 20 62 65 20 61 20 6d 75 6c 74 69 70 6c 65 20
000010f0: 6f 66 0d 0a 20 20 20 65 69 67 68 74 2c 20 61 6e
00001100: 64 20 69 74 20 6d 61 79 20 62 65 20 61 72 62 69
00001110: 74 72 61 72 69 6c 79 20 6c 61 72 67 65 2e 20 57
00001120: 65 20 69 6d 61 67 69 6e 65 20 74 68 65 20 62 69
00001130: 74 73 20 6f 66 20 74 68 65 0d 0a 20 20 20 6d 65
00001140: 73 73 61 67 65 20 77 72 69 74 74 65 6e 20 64 6f
00001150: 77 6e 20 61 73 20 66 6f 6c 6c 6f 77 73 3a 0d 0a
00001160: 0d 0a 20 20 20 20 20 20 20 20 20 20 20 20 20 20
00001170: 20 20 20 6d 5f 30 20 6d 5f 31 20 2e 2e 2e 20 6d
00001180: 5f 7b 62 2d 31 7d 0d 0a 0d 0a 0d 0a 0d 0a 0d 0a
00001190: 52 69 76 65 73 74 20 20 20 20 20 20 20 20 20 20
000011a0: 20 20 20 20 20 20 20 20 20 20 20 20 20 20 20 20
000011b0: 20 20 20 20 20 20 20 20 20 20 20 20 20 20 20 20
000011c0: 20 20 20 20 20 20 20 20 20 20 20 20 20 20 20 20
000011d0: 5b 50 61 67 65 20 32 5d 0d 0a 0c 0d 0a 52 46 43
000011e0: 20 31 33 32 30 20 20 20 20 20 20 20 20 20 20 20
000011f0: 20 20 20 4d 44 34 20 4d 65 73 73 61 67 65 2d 44
00001200: 69 67 65 73 74 20 41 6c 67 6f 72 69 74 68 6d 20
00001210: 20 20 20 20 20 20 20 20 20 20 20 41 70 72 69 6c
00001220: 20 31 39 39 32 0d 0a 0d 0a 0d 0a 20 20 20 54 68
00001230: 65 20 66 6f 6c 6c 6f 77 69 6e 67 20 66 69 76 65
00001240: 20 73 74 65 70 73 20 61 72 65 20 70 65 72 66 6f
00001250: 72 6d 65 64 20 74 6f 20 63 6f 6d 70 75 74 65 20
00001260: 74 68 65 20 6d 65 73 73 61 67 65 20 64 69 67 65
00001270: 73 74 0d 0a 20 20 20 6f 66 20 74 68 65 20 6d 65
00001280: 73 73 61 67 65 2e 0d 0a 0d 0a 33 2e 31 20 53 74
00001290: 65 70 20 31 2e 20 41 70 70 65 6e 64 20 50 61 64
000012a0: 64 69 6e 67 20 42 69 74 73 0d 0a 0d 0a 20 20 20
000012b0: 54 68 65 20 6d 65 73 73 61 67 65 20 69 73 20 22
000012c0: 70 61 64 64 65 64 22 20 28 65 78 74 65 6e 64 65
000012d0: 64 29 20 73 6f 20 74 68 61 74 20 69 74 73 20 6c
000012e0: 65 6e 67 74 68 20 28 69 6e 20 62 69 74 73 29 20
000012f0: 69 73 0d 0a 20 20 20 63 6f 6e 67 72 75 65 6e 74
00001300: 20 74 6f 20 34 34 38 2c 20 6d 6f 64 75 6c 6f 20
00001310: 35 31 32 2e 20 54 68 61 74 20 69 73 2c 20 74 68
00001320: 65 20 6d 65 73 73 61 67 65 20 69 73 20 65 78 74
00001330: 65 6e 64 65 64 20 73 6f 0d 0a 20 20 20 74 68 61

00001340: 74 20 69 74 20 69 73 20 6a 75 73 74 20 36 34 20
00001350: 62 69 74 73 20 73 68 79 20 6f 66 20 62 65 69 6e
00001360: 67 20 61 20 6d 75 6c 74 69 70 6c 65 20 6f 66 20
00001370: 35 31 32 20 62 69 74 73 20 6c 6f 6e 67 2e 0d 0a
00001380: 20 20 20 50 61 64 64 69 6e 67 20 69 73 20 61 6c
00001390: 77 61 79 73 20 70 65 72 66 6f 72 6d 65 64 2c 20
000013a0: 65 76 65 6e 20 69 66 20 74 68 65 20 6c 65 6e 67
000013b0: 74 68 20 6f 66 20 74 68 65 20 6d 65 73 73 61 67
000013c0: 65 20 69 73 0d 0a 20 20 20 61 6c 72 65 61 64 79
000013d0: 20 63 6f 6e 67 72 75 65 6e 74 20 74 6f 20 34 34
000013e0: 38 2c 20 6d 6f 64 75 6c 6f 20 35 31 32 2e 0d 0a
000013f0: 0d 0a 20 20 20 50 61 64 64 69 6e 67 20 69 73 20
00001400: 70 65 72 66 6f 72 6d 65 64 20 61 73 20 66 6f 6c
00001410: 6c 6f 77 73 3a 20 61 20 73 69 6e 67 6c 65 20 22
00001420: 31 22 20 62 69 74 20 69 73 20 61 70 70 65 6e 64
00001430: 65 64 20 74 6f 20 74 68 65 0d 0a 20 20 20 6d 65
00001440: 73 73 61 67 65 2c 20 61 6e 64 20 74 68 65 6e 20
00001450: 22 30 22 20 62 69 74 73 20 61 72 65 20 61 70 70
00001460: 65 6e 64 65 64 20 73 6f 20 74 68 61 74 20 74 68
00001470: 65 20 6c 65 6e 67 74 68 20 69 6e 20 62 69 74 73
00001480: 20 6f 66 0d 0a 20 20 20 74 68 65 20 70 61 64 64
00001490: 65 64 20 6d 65 73 73 61 67 65 20 62 65 63 6f 6d
000014a0: 65 73 20 63 6f 6e 67 72 75 65 6e 74 20 74 6f 20
000014b0: 34 34 38 2c 20 6d 6f 64 75 6c 6f 20 35 31 32 2e
000014c0: 20 49 6e 20 61 6c 6c 2c 20 61 74 0d 0a 20 20 20
000014d0: 6c 65 61 73 74 20 6f 6e 65 20 62 69 74 20 61 6e
000014e0: 64 20 61 74 20 6d 6f 73 74 20 35 31 32 20 62 69
000014f0: 74 73 20 61 72 65 20 61 70 70 65 6e 64 65 64 2e
00001500: 0d 0a 0d 0a 33 2e 32 20 53 74 65 70 20 32 2e 20
00001510: 41 70 70 65 6e 64 20 4c 65 6e 67 74 68 0d 0a 0d
00001520: 0a 20 20 20 41 20 36 34 2d 62 69 74 20 72 65 70
00001530: 72 65 73 65 6e 74 61 74 69 6f 6e 20 6f 66 20 62
00001540: 20 28 74 68 65 20 6c 65 6e 67 74 68 20 6f 66 20
00001550: 74 68 65 20 6d 65 73 73 61 67 65 20 62 65 66 6f
00001560: 72 65 20 74 68 65 0d 0a 20 20 20 70 61 64 64 69
00001570: 6e 67 20 62 69 74 73 20 77 65 72 65 20 61 64 64
00001580: 65 64 29 20 69 73 20 61 70 70 65 6e 64 65 64 20
00001590: 74 6f 20 74 68 65 20 72 65 73 75 6c 74 20 6f 66
000015a0: 20 74 68 65 20 70 72 65 76 69 6f 75 73 0d 0a 20
000015b0: 20 20 73 74 65 70 2e 20 49 6e 20 74 68 65 20 75
000015c0: 6e 6c 69 6b 65 6c 79 20 65 76 65 6e 74 20 74 68
000015d0: 61 74 20 62 20 69 73 20 67 72 65 61 74 65 72 20
000015e0: 74 68 61 6e 20 32 5e 36 34 2c 20 74 68 65 6e 20
000015f0: 6f 6e 6c 79 0d 0a 20 20 20 74 68 65 20 6c 6f 77
00001600: 2d 6f 72 64 65 72 20 36 34 20 62 69 74 73 20 6f
00001610: 66 20 62 20 61 72 65 20 75 73 65 64 2e 20 28 54
00001620: 68 65 73 65 20 62 69 74 73 20 61 72 65 20 61 70
00001630: 70 65 6e 64 65 64 20 61 73 20 74 77 6f 0d 0a 20
00001640: 20 20 33 32 2d 62 69 74 20 77 6f 72 64 73 20 61
00001650: 6e 64 20 61 70 70 65 6e 64 65 64 20 6c 6f 77 2d
00001660: 6f 72 64 65 72 20 77 6f 72 64 20 66 69 72 73 74
00001670: 20 69 6e 20 61 63 63 6f 72 64 61 6e 63 65 20 77
00001680: 69 74 68 20 74 68 65 0d 0a 20 20 20 70 72 65 76
00001690: 69 6f 75 73 20 63 6f 6e 76 65 6e 74 69 6f 6e 73
000016a0: 2e 29 0d 0a 0d 0a 20 20 20 41 74 20 74 68 69 73
000016b0: 20 70 6f 69 6e 74 20 74 68 65 20 72 65 73 75 6c
000016c0: 74 69 6e 67 20 6d 65 73 73 61 67 65 20 28 61 66
000016d0: 74 65 72 20 70 61 64 64 69 6e 67 20 77 69 74 68
000016e0: 20 62 69 74 73 20 61 6e 64 20 77 69 74 68 0d 0a

000016f0: 20 20 20 62 29 20 68 61 73 20 61 20 6c 65 6e 67
00001700: 74 68 20 74 68 61 74 20 69 73 20 61 6e 20 65 78
00001710: 61 63 74 20 6d 75 6c 74 69 70 6c 65 20 6f 66 20
00001720: 35 31 32 20 62 69 74 73 2e 20 45 71 75 69 76 61
00001730: 6c 65 6e 74 6c 79 2c 0d 0a 20 20 20 74 68 69 73
00001740: 20 6d 65 73 73 61 67 65 20 68 61 73 20 61 20 6c
00001750: 65 6e 67 74 68 20 74 68 61 74 20 69 73 20 61 6e
00001760: 20 65 78 61 63 74 20 6d 75 6c 74 69 70 6c 65 20
00001770: 6f 66 20 31 36 20 28 33 32 2d 62 69 74 29 0d 0a
00001780: 20 20 20 77 6f 72 64 73 2e 20 4c 65 74 20 4d 5b
00001790: 30 20 2e 2e 2e 20 4e 2d 31 5d 20 64 65 6e 6f 74
000017a0: 65 20 74 68 65 20 77 6f 72 64 73 20 6f 66 20 74
000017b0: 68 65 20 72 65 73 75 6c 74 69 6e 67 20 6d 65 73
000017c0: 73 61 67 65 2c 0d 0a 20 20 20 77 68 65 72 65 20
000017d0: 4e 20 69 73 20 61 20 6d 75 6c 74 69 70 6c 65 20
000017e0: 6f 66 20 31 36 2e 0d 0a 0d 0a 33 2e 33 20 53 74
000017f0: 65 70 20 33 2e 20 49 6e 69 74 69 61 6c 69 7a 65
00001800: 20 4d 44 20 42 75 66 66 65 72 0d 0a 0d 0a 20 20
00001810: 20 41 20 66 6f 75 72 2d 77 6f 72 64 20 62 75 66
00001820: 66 65 72 20 28 41 2c 42 2c 43 2c 44 29 20 69 73
00001830: 20 75 73 65 64 20 74 6f 20 63 6f 6d 70 75 74 65
00001840: 20 74 68 65 20 6d 65 73 73 61 67 65 20 64 69 67
00001850: 65 73 74 2e 0d 0a 20 20 20 48 65 72 65 20 65 61
00001860: 63 68 20 6f 66 20 41 2c 20 42 2c 20 43 2c 20 44
00001870: 20 69 73 20 61 20 33 32 2d 62 69 74 20 72 65 67
00001880: 69 73 74 65 72 2e 20 54 68 65 73 65 20 72 65 67
00001890: 69 73 74 65 72 73 20 61 72 65 0d 0a 20 20 20 69
000018a0: 6e 69 74 69 61 6c 69 7a 65 64 20 74 6f 20 74 68
000018b0: 65 20 66 6f 6c 6c 6f 77 69 6e 67 20 76 61 6c 75
000018c0: 65 73 20 69 6e 20 68 65 78 61 64 65 63 69 6d 61
000018d0: 6c 2c 20 6c 6f 77 2d 6f 72 64 65 72 20 62 79 74
000018e0: 65 73 0d 0a 20 20 20 66 69 72 73 74 29 3a 0d 0a
000018f0: 0d 0a 20 20 20 20 20 20 77 6f 72 64 20 41
00001900: 3a 20 30 31 20 32 33 20 34 35 20 36 37 0d 0a 20
00001910: 20 20 20 20 20 20 20 77 6f 72 64 20 42 3a 20 38
00001920: 39 20 61 62 20 63 64 20 65 66 0d 0a 20 20 20 20
00001930: 20 20 20 20 77 6f 72 64 20 43 3a 20 66 65 20 64
00001940: 63 20 62 61 20 39 38 0d 0a 20 20 20 20 20 20 20
00001950: 20 77 6f 72 64 20 44 3a 20 37 36 20 35 34 20 33
00001960: 32 20 31 30 0d 0a 0d 0a 0d 0a 0d 0a 0d 0a 0d 0a
00001970: 0d 0a 0d 0a 0d 0a 0d 0a 52 69 76 65 73 74 20 20
00001980: 20 20 20 20 20 20 20 20 20 20 20 20 20 20 20 20
00001990: 20 20 20 20 20 20 20 20 20 20 20 20 20 20 20 20
000019a0: 20 20 20 20 20 20 20 20 20 20 20 20 20 20 20 20
000019b0: 20 20 20 20 20 20 20 20 5b 50 61 67 65 20 33 5d
000019c0: 0d 0a 0c 0d 0a 52 46 43 20 31 33 32 30 20 20 20
000019d0: 20 20 20 20 20 20 20 20 20 20 4d 44 34 20 4d
000019e0: 65 73 73 61 67 65 2d 44 69 67 65 73 74 20 41 6c
000019f0: 67 6f 72 69 74 68 6d 20 20 20 20 20 20 20 20 20
00001a00: 20 20 20 41 70 72 69 6c 20 31 39 39 32 0d 0a 0d
00001a10: 0a 0d 0a 33 2e 34 20 53 74 65 70 20 34 2e 20 50
00001a20: 72 6f 63 65 73 73 20 4d 65 73 73 61 67 65 20 69
00001a30: 6e 20 31 36 2d 57 6f 72 64 20 42 6c 6f 63 6b 73
00001a40: 0d 0a 0d 0a 20 20 20 57 65 20 66 69 72 73 74 20
00001a50: 64 65 66 69 6e 65 20 74 68 72 65 65 20 61 75 78
00001a60: 69 6c 69 61 72 79 20 66 75 6e 63 74 69 6f 6e 73
00001a70: 20 74 68 61 74 20 65 61 63 68 20 74 61 6b 65 20
00001a80: 61 73 20 69 6e 70 75 74 0d 0a 20 20 20 74 68 72
00001a90: 65 65 20 33 32 2d 62 69 74 20 77 6f 72 64 73 20

00001aa0: 61 6e 64 20 70 72 6f 64 75 63 65 20 61 73 20 6f
00001ab0: 75 74 70 75 74 20 6f 6e 65 20 33 32 2d 62 69 74
00001ac0: 20 77 6f 72 64 2e 0d 0a 0d 0a 20 20 20 20 20 20
00001ad0: 20 20 46 28 58 2c 59 2c 5a 29 20 3d 20 58 59 20
00001ae0: 76 20 6e 6f 74 28 58 29 20 5a 0d 0a 20 20 20 20
00001af0: 20 20 20 20 47 28 58 2c 59 2c 5a 29 20 3d 20 58
00001b00: 59 20 76 20 58 5a 20 76 20 59 5a 0d 0a 20 20 20
00001b10: 20 20 20 20 20 48 28 58 2c 59 2c 5a 29 20 3d 20
00001b20: 58 20 78 6f 72 20 59 20 78 6f 72 20 5a 0d 0a 0d
00001b30: 0a 20 20 20 49 6e 20 65 61 63 68 20 62 69 74 20
00001b40: 70 6f 73 69 74 69 6f 6e 20 46 20 61 63 74 73 20
00001b50: 61 73 20 61 20 63 6f 6e 64 69 74 69 6f 6e 61 6c
00001b60: 3a 20 69 66 20 58 20 74 68 65 6e 20 59 20 65 6c
00001b70: 73 65 20 5a 2e 0d 0a 20 20 20 54 68 65 20 66 75
00001b80: 6e 63 74 69 6f 6e 20 46 20 63 6f 75 6c 64 20 68
00001b90: 61 76 65 20 62 65 65 6e 20 64 65 66 69 6e 65 64
00001ba0: 20 75 73 69 6e 67 20 2b 20 69 6e 73 74 65 61 64
00001bb0: 20 6f 66 20 76 20 73 69 6e 63 65 20 58 59 0d 0a
00001bc0: 20 20 20 61 6e 64 20 6e 6f 74 28 58 29 5a 20 77
00001bd0: 69 6c 6c 20 6e 65 76 65 72 20 68 61 76 65 20 22
00001be0: 31 22 20 62 69 74 73 20 69 6e 20 74 68 65 20 73
00001bf0: 61 6d 65 20 62 69 74 20 70 6f 73 69 74 69 6f 6e
00001c00: 2e 29 20 20 49 6e 0d 0a 20 20 20 65 61 63 68 20
00001c10: 62 69 74 20 70 6f 73 69 74 69 6f 6e 20 47 20 61
00001c20: 63 74 73 20 61 73 20 61 20 6d 61 6a 6f 72 69 74
00001c30: 79 20 66 75 6e 63 74 69 6f 6e 3a 20 69 66 20 61
00001c40: 74 20 6c 65 61 73 74 20 74 77 6f 20 6f 66 0d 0a
00001c50: 20 20 20 58 2c 20 59 2c 20 5a 20 61 72 65 20 6f
00001c60: 6e 2c 20 74 68 65 6e 20 47 20 68 61 73 20 61 20
00001c70: 22 31 22 20 62 69 74 20 69 6e 20 74 68 61 74 20
00001c80: 62 69 74 20 70 6f 73 69 74 69 6f 6e 2c 20 65 6c
00001c90: 73 65 20 47 20 68 61 73 0d 0a 20 20 20 61 20 22
00001ca0: 30 22 20 62 69 74 2e 20 49 74 20 69 73 20 69 6e
00001cb0: 74 65 72 65 73 74 69 6e 67 20 74 6f 20 6e 6f 74
00001cc0: 65 20 74 68 61 74 20 69 66 20 74 68 65 20 62 69
00001cd0: 74 73 20 6f 66 20 58 2c 20 59 2c 20 61 6e 64 20
00001ce0: 5a 0d 0a 20 20 20 61 72 65 20 69 6e 64 65 70 65
00001cf0: 6e 64 65 6e 74 20 61 6e 64 20 75 6e 62 69 61 73
00001d00: 65 64 2c 20 74 68 65 20 65 61 63 68 20 62 69 74
00001d10: 20 6f 66 20 66 28 58 2c 59 2c 5a 29 20 77 69 6c
00001d20: 6c 20 62 65 0d 0a 20 20 20 69 6e 64 65 70 65 6e
00001d30: 64 65 6e 74 20 61 6e 64 20 75 6e 62 69 61 73 65
00001d40: 64 2c 20 61 6e 64 20 73 69 6d 69 6c 61 72 6c 79
00001d50: 20 65 61 63 68 20 62 69 74 20 6f 66 20 67 28 58
00001d60: 2c 59 2c 5a 29 20 77 69 6c 6c 20 62 65 0d 0a 20
00001d70: 20 20 69 6e 64 65 70 65 6e 64 65 6e 74 20 61 6e
00001d80: 64 20 75 6e 62 69 61 73 65 64 2e 20 54 68 65 20
00001d90: 66 75 6e 63 74 69 6f 6e 20 48 20 69 73 20 74 68
00001da0: 65 20 62 69 74 2d 77 69 73 65 20 58 4f 52 20 6f
00001db0: 72 0d 0a 20 20 20 70 61 72 69 74 79 22 20 66 75
00001dc0: 6e 63 74 69 6f 6e 3b 20 69 74 20 68 61 73 20 70
00001dd0: 72 6f 70 65 72 74 69 65 73 20 73 69 6d 69 6c 61
00001de0: 72 20 74 6f 20 74 68 6f 73 65 20 6f 66 20 46 20
00001df0: 61 6e 64 20 47 2e 0d 0a 0d 0a 20 20 20 44 6f 20
00001e00: 74 68 65 20 66 6f 6c 6c 6f 77 69 6e 67 3a 0d 0a
00001e10: 0d 0a 20 20 20 20 20 20 50 72 6f 63 65 73 73 20
00001e20: 65 61 63 68 20 31 36 2d 77 6f 72 64 20 62 6c 6f
00001e30: 63 6b 2e 20 2a 2f 0d 0a 20 20 20 20 20 20 46 6f
00001e40: 72 20 69 20 3d 20 30 20 74 6f 20 4e 2f 31 36 2d

00001e50: 31 20 64 6f 0d 0a 0d 0a 20 20 20 20 20 20 20 20
00001e60: 2f 2a 20 43 6f 70 79 20 62 6c 6f 63 6b 20 69 20
00001e70: 69 6e 74 6f 20 58 2e 20 2a 2f 0d 0a 20 20 20 20
00001e80: 20 20 20 20 46 6f 72 20 6a 20 3d 20 30 20 74 6f
00001e90: 20 31 35 20 64 6f 0d 0a 20 20 20 20 20 20 20 20
00001ea0: 20 20 53 65 74 20 58 5b 6a 5d 20 74 6f 20 4d 5b
00001eb0: 69 2a 31 36 2b 6a 5d 2e 0d 0a 20 20 20 20 20 20
00001ec0: 20 20 65 6e 64 20 2f 2a 20 6f 66 20 6c 6f 6f 70
00001ed0: 20 6f 6e 20 6a 20 2a 2f 0d 0a 0d 0a 20 20 20 20
00001ee0: 20 20 20 20 2f 2a 20 53 61 76 65 20 41 20 61 73
00001ef0: 20 41 41 2c 20 42 20 61 73 20 42 42 2c 20 43 20
00001f00: 61 73 20 43 43 2c 20 61 6e 64 20 44 20 61 73 20
00001f10: 44 44 2e 20 2a 2f 0d 0a 20 20 20 20 20 20 20 20
00001f20: 41 41 20 3d 20 41 0d 0a 20 20 20 20 20 20 20 20
00001f30: 42 42 20 3d 20 42 0d 0a 20 20 20 20 20 20 20 20
00001f40: 43 43 20 3d 20 43 0d 0a 20 20 20 20 20 20 20 20
00001f50: 44 44 20 3d 20 44 0d 0a 0d 0a 20 20 20 20 20 20
00001f60: 20 20 2f 2a 20 52 6f 75 6e 64 20 31 2e 20 2a 2f
00001f70: 0d 0a 20 20 20 20 20 20 20 20 2f 2a 20 4c 65 74
00001f80: 20 5b 61 62 63 64 20 6b 20 73 5d 20 64 65 6e 6f
00001f90: 74 65 20 74 68 65 20 6f 70 65 72 61 74 69 6f 6e
00001fa0: 0d 0a 20 20 20 20 20 20 20 20 20 20 20 20 20 61
00001fb0: 20 3d 20 28 61 20 2b 20 46 28 62 2c 63 2c 64 29
00001fc0: 20 2b 20 58 5b 6b 5d 29 20 3c 3c 3c 20 73 2e 20
00001fd0: 2a 2f 0d 0a 20 20 20 20 20 20 20 20 2f 2a 20 44
00001fe0: 6f 20 74 68 65 20 66 6f 6c 6c 6f 77 69 6e 67 20
00001ff0: 31 36 20 6f 70 65 72 61 74 69 6f 6e 73 2e 20 2a

00002000: 2f 0d 0a 20 20 20 20 20 20 20 5b 41 42 43 44
00002010: 20 20 30 20 20 33 5d 20 20 5b 44 41 42 43 20 20
00002020: 31 20 20 37 5d 20 20 5b 43 44 41 42 20 20 32 20
00002030: 31 31 5d 20 20 5b 42 43 44 41 20 20 33 20 31 39
00002040: 5d 0d 0a 20 20 20 20 20 20 20 5b 41 42 43 44
00002050: 20 20 34 20 20 33 5d 20 20 5b 44 41 42 43 20 20
00002060: 35 20 20 37 5d 20 20 5b 43 44 41 42 20 20 36 20
00002070: 31 31 5d 20 20 5b 42 43 44 41 20 20 37 20 31 39
00002080: 5d 0d 0a 20 20 20 20 20 20 20 5b 41 42 43 44
00002090: 20 20 38 20 20 33 5d 20 20 5b 44 41 42 43 20 20
000020a0: 39 20 20 37 5d 20 20 5b 43 44 41 42 20 31 30 20
000020b0: 31 31 5d 20 20 5b 42 43 44 41 20 31 31 20 31 39
000020c0: 5d 0d 0a 20 20 20 20 20 20 20 5b 41 42 43 44
000020d0: 20 31 32 20 20 33 5d 20 20 5b 44 41 42 43 20 31
000020e0: 33 20 20 37 5d 20 20 5b 43 44 41 42 20 31 34 20
000020f0: 31 31 5d 20 20 5b 42 43 44 41 20 31 35 20 31 39
00002100: 5d 0d 0a 0d 0a 20 20 20 20 20 20 20 2f 2a 20
00002110: 52 6f 75 6e 64 20 32 2e 20 2a 2f 0d 0a 20 20 20
00002120: 20 20 20 20 20 2f 2a 20 4c 65 74 20 5b 61 62 63
00002130: 64 20 6b 20 73 5d 20 64 65 6e 6f 74 65 20 74 68
00002140: 65 20 6f 70 65 72 61 74 69 6f 6e 0d 0a 20 20 20
00002150: 20 20 20 20 20 20 20 20 20 20 61 20 3d 20 28 61
00002160: 20 2b 20 47 28 62 2c 63 2c 64 29 20 2b 20 58 5b
00002170: 6b 5d 20 2b 20 35 41 38 32 37 39 39 39 29 20 3c
00002180: 3c 3c 20 73 2e 20 2a 2f 0d 0a 0d 0a 0d 0a 0d 0a
00002190: 52 69 76 65 73 74 20 20 20 20 20 20 20 20 20 20
000021a0: 20 20 20 20 20 20 20 20 20 20 20 20 20 20 20 20
000021b0: 20 20 20 20 20 20 20 20 20 20 20 20 20 20 20 20
000021c0: 20 20 20 20 20 20 20 20 20 20 20 20 20 20 20 20
000021d0: 5b 50 61 67 65 20 34 5d 0d 0a 0c 0d 0a 52 46 43

000021e0: 20 31 33 32 30 20 20 20 20 20 20 20 20 20 20 20 20 20 20 20
000021f0: 20 20 20 4d 44 34 20 4d 65 73 73 61 67 65 2d 44
00002200: 69 67 65 73 74 20 41 6c 67 6f 72 69 74 68 6d 20
00002210: 20 20 20 20 20 20 20 20 20 20 20 20 41 70 72 69 6c
00002220: 20 31 39 39 32 0d 0a 0d 0a 0d 0a 20 20 20 20 20
00002230: 20 20 20 2f 2a 20 44 6f 20 74 68 65 20 66 6f 6c
00002240: 6c 6f 77 69 6e 67 20 31 36 20 6f 70 65 72 61 74
00002250: 69 6f 6e 73 2e 20 2a 2f 0d 0a 20 20 20 20 20 20
00002260: 20 20 5b 41 42 43 44 20 20 30 20 20 33 5d 20 20
00002270: 5b 44 41 42 43 20 20 34 20 20 35 5d 20 20 5b 43
00002280: 44 41 42 20 20 38 20 20 39 5d 20 20 5b 42 43 44
00002290: 41 20 31 32 20 31 33 5d 0d 0a 20 20 20 20 20 20
000022a0: 20 20 5b 41 42 43 44 20 20 31 20 20 33 5d 20 20
000022b0: 5b 44 41 42 43 20 20 35 20 20 35 5d 20 20 5b 43
000022c0: 44 41 42 20 20 39 20 20 39 5d 20 20 5b 42 43 44
000022d0: 41 20 31 33 20 31 33 5d 0d 0a 20 20 20 20 20 20
000022e0: 20 20 5b 41 42 43 44 20 20 32 20 20 33 5d 20 20
000022f0: 5b 44 41 42 43 20 20 36 20 20 35 5d 20 20 5b 43
00002300: 44 41 42 20 31 30 20 20 39 5d 20 20 5b 42 43 44
00002310: 41 20 31 34 20 31 33 5d 0d 0a 20 20 20 20 20 20
00002320: 20 20 5b 41 42 43 44 20 20 33 20 20 33 5d 20 20
00002330: 5b 44 41 42 43 20 20 37 20 20 35 5d 20 20 5b 43
00002340: 44 41 42 20 31 31 20 20 39 5d 20 20 5b 42 43 44
00002350: 41 20 31 35 20 31 33 5d 0d 0a 0d 0a 20 20 20 20
00002360: 20 20 20 20 2f 2a 20 52 6f 75 6e 64 20 33 2e 20
00002370: 2a 2f 0d 0a 20 20 20 20 20 20 20 20 2f 2a 20 4c
00002380: 65 74 20 5b 61 62 63 64 20 6b 20 73 5d 20 64 65
00002390: 6e 6f 74 65 20 74 68 65 20 6f 70 65 72 61 74 69
000023a0: 6f 6e 0d 0a 20 20 20 20 20 20 20 20 20 20 20 20
000023b0: 20 61 20 3d 20 28 61 20 2b 20 48 28 62 2c 63 2c
000023c0: 64 29 20 2b 20 58 5b 6b 5d 20 2b 20 36 45 44 39
000023d0: 45 42 41 31 29 20 3c 3c 3c 20 73 2e 20 2a 2f 0d
000023e0: 0a 20 20 20 20 20 20 20 20 2f 2a 20 44 6f 20 74
000023f0: 68 65 20 66 6f 6c 6c 6f 77 69 6e 67 20 31 36 20
00002400: 6f 70 65 72 61 74 69 6f 6e 73 2e 20 2a 2f 0d 0a
00002410: 20 20 20 20 20 20 20 20 20 20 20 20 5b 41 42 43 44 20 20 30
00002420: 20 20 33 5d 20 20 5b 44 41 42 43 20 20 38 20 20
00002430: 39 5d 20 20 5b 43 44 41 42 20 20 34 20 31 31 5d
00002440: 20 20 5b 42 43 44 41 20 31 32 20 31 35 5d 0d 0a
00002450: 20 20 20 20 20 20 20 20 5b 41 42 43 44 20 20 32
00002460: 20 20 33 5d 20 20 5b 44 41 42 43 20 31 30 20 20
00002470: 39 5d 20 20 5b 43 44 41 42 20 20 36 20 31 31 5d
00002480: 20 20 5b 42 43 44 41 20 31 34 20 31 35 5d 0d 0a
00002490: 20 20 20 20 20 20 20 20 5b 41 42 43 44 20 20 31
000024a0: 20 20 33 5d 20 20 5b 44 41 42 43 20 20 39 20 20
000024b0: 39 5d 20 20 5b 43 44 41 42 20 20 35 20 31 31 5d
000024c0: 20 20 5b 42 43 44 41 20 31 33 20 31 35 5d 0d 0a
000024d0: 20 20 20 20 20 20 20 20 5b 41 42 43 44 20 20 33
000024e0: 20 20 33 5d 20 20 5b 44 41 42 43 20 31 31 20 20
000024f0: 39 5d 20 20 5b 43 44 41 42 20 20 37 20 31 31 5d
00002500: 20 20 5b 42 43 44 41 20 31 35 20 31 35 5d 0d 0a
00002510: 0d 0a 20 20 20 20 20 20 20 20 2f 2a 20 54 68 65
00002520: 6e 20 70 65 72 66 6f 72 6d 20 74 68 65 20 66 6f
00002530: 6c 6c 6f 77 69 6e 67 20 61 64 64 69 74 69 6f 6e
00002540: 73 2e 20 28 54 68 61 74 20 69 73 2c 20 69 6e 63
00002550: 72 65 6d 65 6e 74 20 65 61 63 68 0d 0a 20 20 20
00002560: 20 20 20 20 20 20 20 20 6f 66 20 74 68 65 20 66
00002570: 6f 75 72 20 72 65 67 69 73 74 65 72 73 20 62 79
00002580: 20 74 68 65 20 76 61 6c 75 65 20 69 74 20 68 61

00002590: 64 20 62 65 66 6f 72 65 20 74 68 69 73 20 62 6c
000025a0: 6f 63 6b 0d 0a 20 20 20 20 20 20 20 20 20 20 20
000025b0: 77 61 73 20 73 74 61 72 74 65 64 2e 29 20 2a 2f
000025c0: 0d 0a 20 20 20 20 20 20 20 20 20 20 3d 20 41 20
000025d0: 2b 20 41 41 0d 0a 20 20 20 20 20 20 20 20 42 20
000025e0: 3d 20 42 20 2b 20 42 42 0d 0a 20 20 20 20 20 20
000025f0: 20 20 43 20 3d 20 43 20 2b 20 43 43 0d 0a 20 20
00002600: 20 20 20 20 20 20 44 20 3d 20 44 20 2b 20 44 44
00002610: 0d 0a 0d 0a 20 20 20 20 20 20 65 6e 64 20 2f 2a
00002620: 20 6f 66 20 6c 6f 6f 70 20 6f 6e 20 69 20 2a 2f
00002630: 0d 0a 0d 0a 20 20 20 4e 6f 74 65 2e 20 54 68 65
00002640: 20 76 61 6c 75 65 20 35 41 2e 2e 39 39 20 69 73
00002650: 20 61 20 68 65 78 61 64 65 63 69 6d 61 6c 20 33
00002660: 32 2d 62 69 74 20 63 6f 6e 73 74 61 6e 74 2c 20
00002670: 77 72 69 74 74 65 6e 20 77 69 74 68 0d 0a 20 20
00002680: 20 74 68 65 20 68 69 67 68 2d 6f 72 64 65 72 20
00002690: 64 69 67 69 74 20 66 69 72 73 74 2e 20 54 68 69
000026a0: 73 20 63 6f 6e 73 74 61 6e 74 20 72 65 70 72 65
000026b0: 73 65 6e 74 73 20 74 68 65 20 73 71 75 61 72 65
000026c0: 20 72 6f 6f 74 0d 0a 20 20 20 6f 66 20 32 2e 20
000026d0: 54 68 65 20 6f 63 74 61 6c 20 76 61 6c 75 65 20
000026e0: 6f 66 20 74 68 69 73 20 63 6f 6e 73 74 61 6e 74
000026f0: 20 69 73 20 30 31 33 32 34 30 34 37 34 36 33 31
00002700: 2e 0d 0a 0d 0a 20 20 20 54 68 65 20 76 61 6c 75
00002710: 65 20 36 45 2e 2e 41 31 20 69 73 20 61 20 68 65
00002720: 78 61 64 65 63 69 6d 61 6c 20 33 32 2d 62 69 74
00002730: 20 63 6f 6e 73 74 61 6e 74 2c 20 77 72 69 74 74
00002740: 65 6e 20 77 69 74 68 20 74 68 65 0d 0a 20 20 20
00002750: 68 69 67 68 2d 6f 72 64 65 72 20 64 69 67 69 74
00002760: 20 66 69 72 73 74 2e 20 20 54 68 69 73 20 63 6f
00002770: 6e 73 74 61 6e 74 20 72 65 70 72 65 73 65 6e 74
00002780: 73 20 74 68 65 20 73 71 75 61 72 65 20 72 6f 6f
00002790: 74 20 6f 66 0d 0a 20 20 20 33 2e 20 54 68 65 20
000027a0: 6f 63 74 61 6c 20 76 61 6c 75 65 20 6f 66 20 74
000027b0: 68 69 73 20 63 6f 6e 73 74 61 6e 74 20 69 73 20
000027c0: 30 31 35 36 36 36 33 36 35 36 34 31 2e 0d 0a 0d
000027d0: 0a 20 20 20 53 65 65 20 4b 6e 75 74 68 2c 20 54
000027e0: 68 65 20 41 72 74 20 6f 66 20 50 72 6f 67 72 61
000027f0: 6d 6d 69 6e 67 2c 20 56 6f 6c 75 6d 65 20 32 20
00002800: 28 53 65 6d 69 6e 75 6d 65 72 69 63 61 6c 0d 0a
00002810: 20 20 20 41 6c 67 6f 72 69 74 68 6d 73 29 2c 20
00002820: 53 65 63 6f 6e 64 20 45 64 69 74 69 6f 6e 20 28
00002830: 31 39 38 31 29 2c 20 41 64 64 69 73 6f 6e 2d 57
00002840: 65 73 6c 65 79 2e 20 54 61 62 6c 65 20 32 2c 20
00002850: 70 61 67 65 0d 0a 20 20 20 20 36 36 30 2e 0d 0a
00002860: 0d 0a 33 2e 35 20 53 74 65 70 20 35 2e 20 4f 75
00002870: 74 70 75 74 0d 0a 0d 0a 20 20 20 54 68 65 20 6d
00002880: 65 73 73 61 67 65 20 64 69 67 65 73 74 20 70 72
00002890: 6f 64 75 63 65 64 20 61 73 20 6f 75 74 70 75 74
000028a0: 20 69 73 20 41 2c 20 42 2c 20 43 2c 20 44 2e 20
000028b0: 54 68 61 74 20 69 73 2c 20 77 65 0d 0a 20 20 20
000028c0: 62 65 67 69 6e 20 77 69 74 68 20 74 68 65 20 6c
000028d0: 6f 77 2d 6f 72 64 65 72 20 62 79 74 65 20 6f 66
000028e0: 20 41 2c 20 61 6e 64 20 65 6e 64 20 77 69 74 68
000028f0: 20 74 68 65 20 68 69 67 68 2d 6f 72 64 65 72 20
00002900: 62 79 74 65 0d 0a 20 20 20 6f 66 20 44 2e 0d 0a
00002910: 0d 0a 20 20 20 54 68 69 73 20 63 6f 6d 70 6c 65
00002920: 74 65 73 20 74 68 65 20 64 65 73 63 72 69 70 74
00002930: 69 6f 6e 20 6f 66 20 4d 44 34 2e 20 41 20 72 65

00002940: 66 65 72 65 6e 63 65 20 69 6d 70 6c 65 6d 65 6e
00002950: 74 61 74 69 6f 6e 20 69 6e 0d 0a 20 20 20 43 20
00002960: 69 73 20 67 69 76 65 6e 20 69 6e 20 74 68 65 20
00002970: 61 70 70 65 6e 64 69 78 2e 0d 0a 0d 0a 0d 0a 0d
00002980: 0a 0d 0a 0d 0a 0d 0a 52 69 76 65 73 74 20 20 20
00002990: 20 20 20 20 20 20 20 20 20 20 20 20 20 20 20 20
000029a0: 20 20 20 20 20 20 20 20 20 20 20 20 20 20 20 20
000029b0: 20 20 20 20 20 20 20 20 20 20 20 20 20 20 20 20
000029c0: 20 20 20 20 20 20 20 5b 50 61 67 65 20 35 5d 0d
000029d0: 0a 0c 0d 0a 52 46 43 20 31 33 32 30 20 20 20 20
000029e0: 20 20 20 20 20 20 20 20 20 20 20 4d 44 34 20 4d 65
000029f0: 73 73 61 67 65 2d 44 69 67 65 73 74 20 41 6c 67
00002a00: 6f 72 69 74 68 6d 20 20 20 20 20 20 20 20 20 20
00002a10: 20 20 41 70 72 69 6c 20 31 39 39 32 0d 0a 0d 0a
00002a20: 0d 0a 34 2e 20 53 75 6d 6d 61 72 79 0d 0a 0d 0a
00002a30: 20 20 20 54 68 65 20 4d 44 34 20 6d 65 73 73 61
00002a40: 67 65 2d 64 69 67 65 73 74 20 61 6c 67 6f 72 69
00002a50: 74 68 6d 20 69 73 20 73 69 6d 70 6c 65 20 74 6f
00002a60: 20 69 6d 70 6c 65 6d 65 6e 74 2c 20 61 6e 64 20
00002a70: 70 72 6f 76 69 64 65 73 0d 0a 20 20 20 61 20 22
00002a80: 66 69 6e 67 65 72 70 72 69 6e 74 22 20 6f 72 20
00002a90: 6d 65 73 73 61 67 65 20 64 69 67 65 73 74 20 6f
00002aa0: 66 20 61 20 6d 65 73 73 61 67 65 20 6f 66 20 61
00002ab0: 72 62 69 74 72 61 72 79 20 6c 65 6e 67 74 68 2e
00002ac0: 0d 0a 20 20 20 49 74 20 69 73 20 63 6f 6e 6a 65
00002ad0: 63 74 75 72 65 64 20 74 68 61 74 20 74 68 65 20
00002ae0: 64 69 66 66 69 63 75 6c 74 79 20 6f 66 20 63 6f
00002af0: 6d 69 6e 67 20 75 70 20 77 69 74 68 20 74 77 6f
00002b00: 20 6d 65 73 73 61 67 65 73 0d 0a 20 20 20 68 61
00002b10: 76 69 6e 67 20 74 68 65 20 73 61 6d 65 20 6d 65
00002b20: 73 73 61 67 65 20 64 69 67 65 73 74 20 69 73 20
00002b30: 6f 6e 20 74 68 65 20 6f 72 64 65 72 20 6f 66 20
00002b40: 32 5e 36 34 20 6f 70 65 72 61 74 69 6f 6e 73 2c
00002b50: 0d 0a 20 20 20 61 6e 64 20 74 68 61 74 20 74 68
00002b60: 65 20 64 69 66 66 69 63 75 6c 74 79 20 6f 66 20
00002b70: 63 6f 6d 69 6e 67 20 75 70 20 77 69 74 68 20 61
00002b80: 6e 79 20 6d 65 73 73 61 67 65 20 68 61 76 69 6e
00002b90: 67 20 61 20 67 69 76 65 6e 0d 0a 20 20 20 6d 65
00002ba0: 73 73 61 67 65 20 64 69 67 65 73 74 20 69 73 20
00002bb0: 6f 6e 20 74 68 65 20 6f 72 64 65 72 20 6f 66 20
00002bc0: 32 5e 31 32 38 20 6f 70 65 72 61 74 69 6f 6e 73
00002bd0: 2e 20 54 68 65 20 4d 44 34 20 61 6c 67 6f 72 69
00002be0: 74 68 6d 0d 0a 20 20 20 68 61 73 20 62 65 65 6e
00002bf0: 20 63 61 72 65 66 75 6c 6c 79 20 73 63 72 75 74
00002c00: 69 6e 69 7a 65 64 20 66 6f 72 20 77 65 61 6b 6e
00002c10: 65 73 73 65 73 2e 20 49 74 20 69 73 2c 20 68 6f
00002c20: 77 65 76 65 72 2c 20 61 0d 0a 20 20 20 72 65 6c
00002c30: 61 74 69 76 65 6c 79 20 6e 65 77 20 61 6c 67 6f
00002c40: 72 69 74 68 6d 20 61 6e 64 20 66 75 72 74 68 65
00002c50: 72 20 73 65 63 75 72 69 74 79 20 61 6e 61 6c 79
00002c60: 73 69 73 20 69 73 20 6f 66 20 63 6f 75 72 73 65
00002c70: 0d 0a 20 20 20 6a 75 73 74 69 66 69 65 64 2c 20
00002c80: 61 73 20 69 73 20 74 68 65 20 63 61 73 65 20 77
00002c90: 69 74 68 20 61 6e 79 20 6e 65 77 20 70 72 6f 70
00002ca0: 6f 73 61 6c 20 6f 66 20 74 68 69 73 20 73 6f 72
00002cb0: 74 2e 0d 0a 0d 0a 52 65 66 65 72 65 6e 63 65 73
00002cc0: 0d 0a 0d 0a 20 20 20 5b 31 5d 20 52 69 76 65 73
00002cd0: 74 2c 20 52 2e 2c 20 22 54 68 65 20 4d 44 34 20
00002ce0: 6d 65 73 73 61 67 65 20 64 69 67 65 73 74 20 61

```

00002cf0: 6c 67 6f 72 69 74 68 6d 22 2c 20 69 6e 20 41 2e
00002d00: 4a 2e 20 20 4d 65 6e 65 7a 65 73 0d 0a 20 20 20
00002d10: 20 20 20 20 61 6e 64 20 53 2e 41 2e 20 56 61 6e
00002d20: 73 74 6f 6e 65 2c 20 65 64 69 74 6f 72 73 2c 20
00002d30: 41 64 76 61 6e 63 65 73 20 69 6e 20 43 72 79 70
00002d40: 74 6f 6c 6f 67 79 20 2d 20 43 52 59 50 54 4f 20
00002d50: 27 39 30 0d 0a 20 20 20 20 20 20 20 50 72 6f 63
00002d60: 65 65 64 69 6e 67 73 2c 20 70 61 67 65 73 20 33
00002d70: 30 33 2d 33 31 31 2c 20 53 70 72 69 6e 67 65 72
00002d80: 2d 56 65 72 6c 61 67 2c 20 31 39 39 31 2e 0d 0a
00002d90: 0d 0a 20 20 20 5b 32 5d 20 52 69 76 65 73 74 2c
00002da0: 20 52 2e 2c 20 22 54 68 65 20 4d 44 34 20 4d 65
00002db0: 73 73 61 67 65 20 44 69 67 65 73 74 20 41 6c 67
00002dc0: 6f 72 69 74 68 6d 22 2c 20 52 46 43 20 31 31 38
00002dd0: 36 2c 20 4d 49 54 2c 0d 0a 20 20 20 20 20 20 20
00002de0: 4f 63 74 6f 62 65 72 20 31 39 39 30 2e 0d 0a 0d
00002df0: 0a 20 20 20 5b 33 5d 20 43 43 49 54 54 20 52 65
00002e00: 63 6f 6d 6d 65 6e 64 61 74 69 6f 6e 20 58 2e 35
00002e10: 30 39 20 28 31 39 38 38 29 2c 20 22 54 68 65 20
00002e20: 44 69 72 65 63 74 6f 72 79 20 2d 0d 0a 20 20 20
00002e30: 20 20 20 20 41 75 74 68 65 6e 74 69 63 61 74 69
00002e40: 6f 6e 20 46 72 61 6d 65 77 6f 72 6b 22 2e 0d 0a
00002e50: 0d 0a 20 20 20 5b 34 5d 20 52 69 76 65 73 74 2c
00002e60: 20 52 2e 2c 20 22 54 68 65 20 4d 44 35 20 4d 65
00002e70: 73 73 61 67 65 2d 44 69 67 65 73 74 20 41 6c 67
00002e80: 6f 72 69 74 68 6d 22 2c 20 52 46 43 20 31 33 32
00002e90: 31 2c 20 4d 49 54 20 61 6e 64 0d 0a 20 20 20 20
00002ea0: 20 20 20 52 53 41 20 44 61 74 61 20 53 65 63 75
00002eb0: 72 69 74 79 2c 20 49 6e 63 2c 20 41 70 72 69 6c
00002ec0: 20 31 39 39 32 2e 0d 0a 0d 0a 41 50 50 45 4e 44
00002ed0: 49 58 20 41 20 2d 20 52 65 66 65 72 65 6e 63 65
00002ee0: 20 49 6d 70 6c 65 6d 65 6e 74 61 74 69 6f 6e 0d
00002ef0: 0a 0d 0a 20 20 20 54 68 69 73 20 61 70 70 65 6e
00002f00: 64 69 78 20 63 6f 6e 74 61 69 6e 73 20 74 68 65
00002f10: 20 66 6f 6c 6c 6f 77 69 6e 67 20 66 69 6c 65 73
00002f20: 3a 0d 0a 0d 0a 20 20 20 20 20 20 20 20 67 6c 6f
00002f30: 62 61 6c 2e 68 20 2d 2d 20 67 6c 6f 62 61 6c 20
00002f40: 68 65 61 64 65 72 20 66 69 6c 65 0d 0a 0d 0a 20
00002f50: 20 20 20 20 20 20 20 6d 64 34 2e 68 20 2d 2d 20
00002f60: 68 65 61 64 65 72 20 66 69 6c 65 20 66 6f 72 20
00002f70: 4d 44 34 0d 0a 0d 0a 20 20 20 20 20 20 20 20 6d
00002f80: 64 34 63 2e 63 20 2d 2d 20 73 6f 75 72 63 65 20
00002f90: 63 6f 64 65 20 66 6f 72 20 4d 44 34 0d 0a 0d 0a
00002fa0: 20 20 20 20 20 20 20 20 6d 64 64 72 69 76 65 72
00002fb0: 2e 63 20 2d 2d 20 74 65 73 74 20 64 72 69 76 65
00002fc0: 72 20 66 6f 72 20 4d 44 32 2c 20 4d 44 34 20 61
00002fd0: 6e 64 20 4d 44 35 0d 0a 0d 0a 20 20 20 54 68 65
00002fe0: 20 64 72 69 76 65 72 20 63 6f 6d 70 69 6c 65 73
00002ff0: 20 66 6f 72 20 4d 44 35 20 62 79 20 64 65 66 61

00003000: 75 6c 74 20 62 75 74 20 63 61 6e 20 63 6f 6d 70
00003010: 69 6c 65 20 66 6f 72 20 4d 44 32 20 6f 72 20 4d
00003020: 44 34 0d 0a 20 20 20 69 66 20 74 68 65 20 73 79
00003030: 6d 62 6f 6c 20 4d 44 20 69 73 20 64 65 66 69 6e
00003040: 65 64 20 6f 6e 20 74 68 65 20 43 20 63 6f 6d 70
00003050: 69 6c 65 72 20 63 6f 6d 6d 61 6e 64 20 6c 69 6e
00003060: 65 20 61 73 20 32 20 6f 72 20 34 2e 0d 0a 0d 0a
00003070: 20 20 20 54 68 65 20 69 6d 70 6c 65 6d 65 6e 74

```

00003080: 61 74 69 6f 6e 20 69 73 20 70 6f 72 74 61 62 6c
00003090: 65 20 61 6e 64 20 73 68 6f 75 6c 64 20 77 6f 72
000030a0: 6b 20 6f 6e 20 6d 61 6e 79 20 64 69 66 66 65 72
000030b0: 65 6e 74 0d 0a 20 20 20 70 6c 61 66 6f 72 6d 73
000030c0: 2e 20 48 6f 77 65 76 65 72 2c 20 69 74 20 69 73
000030d0: 20 6e 6f 74 20 64 69 66 66 69 63 75 6c 74 20 74
000030e0: 6f 20 6f 70 74 69 6d 69 7a 65 20 74 68 65 20 69
000030f0: 6d 70 6c 65 6d 65 6e 74 61 74 69 6f 6e 0d 0a 20
00003100: 20 20 6f 6e 20 70 61 72 74 69 63 75 6c 61 72 20
00003110: 70 6c 61 74 66 6f 72 6d 73 2c 20 61 6e 20 65 78
00003120: 65 72 63 69 73 65 20 6c 65 66 74 20 74 6f 20 74
00003130: 68 65 20 72 65 61 64 65 72 2e 20 46 6f 72 20 65
00003140: 78 61 6d 70 6c 65 2c 0d 0a 20 20 20 6f 6e 20 22
00003150: 6c 69 74 74 6c 65 2d 65 6e 64 69 61 6e 22 20 70
00003160: 6c 61 74 66 6f 72 6d 73 20 77 68 65 72 65 20 74
00003170: 68 65 20 6c 6f 77 65 73 74 2d 61 64 64 72 65 73
00003180: 73 65 64 20 62 79 74 65 20 69 6e 20 61 20 33 32
00003190: 2d 0d 0a 20 20 20 62 69 74 20 77 6f 72 64 20 69
000031a0: 73 20 74 68 65 20 6c 65 61 73 74 20 73 69 67 6e
000031b0: 69 66 69 63 61 6e 74 20 61 6e 64 20 74 68 65 72
000031c0: 65 20 61 72 65 20 6e 6f 20 61 6c 69 67 6e 6d 65
000031d0: 6e 74 0d 0a 20 20 20 72 65 73 74 72 69 63 74 69
000031e0: 6f 6e 73 2c 20 74 68 65 20 63 61 6c 6c 20 74 6f
000031f0: 20 44 65 63 6f 64 65 20 69 6e 20 4d 44 34 54 72
00003200: 61 6e 73 66 6f 72 6d 20 63 61 6e 20 62 65 20 72
00003210: 65 70 6c 61 63 65 64 20 77 69 74 68 0d 0a 0d 0a
00003220: 0d 0a 0d 0a 52 69 76 65 73 74 20 20 20 20 20 20
00003230: 20 20 20 20 20 20 20 20 20 20 20 20 20 20 20 20
00003240: 20 20 20 20 20 20 20 20 20 20 20 20 20 20 20 20
00003250: 20 20 20 20 20 20 20 20 20 20 20 20 20 20 20 20
00003260: 20 20 20 20 5b 50 61 67 65 20 36 5d 0d 0a 0c 0d
00003270: 0a 52 46 43 20 31 33 32 30 20 20 20 20 20 20 20
00003280: 20 20 20 20 20 20 20 4d 44 34 20 4d 65 73 73 61
00003290: 67 65 2d 44 69 67 65 73 74 20 41 6c 67 6f 72 69
000032a0: 74 68 6d 20 20 20 20 20 20 20 20 20 20 20 20 41
000032b0: 70 72 69 6c 20 31 39 39 32 0d 0a 0d 0a 0d 0a 20
000032c0: 20 20 61 20 74 79 70 65 63 61 73 74 2e 0d 0a 0d
000032d0: 0a 41 2e 31 20 67 6c 6f 62 61 6c 2e 68 0d 0a 0d
000032e0: 0a 2f 2a 20 47 4c 4f 42 41 4c 2e 48 20 2d 20 52
000032f0: 53 41 52 45 46 20 74 79 70 65 73 20 61 6e 64 20
00003300: 63 6f 6e 73 74 61 6e 74 73 0d 0a 20 2a 2f 0d 0a
00003310: 0d 0a 2f 2a 20 50 52 4f 54 4f 54 59 50 45 53 20
00003320: 73 68 6f 75 6c 64 20 62 65 20 73 65 74 20 74 6f
00003330: 20 6f 6e 65 20 69 66 20 61 6e 64 20 6f 6e 6c 79
00003340: 20 69 66 20 74 68 65 20 63 6f 6d 70 69 6c 65 72
00003350: 20 73 75 70 70 6f 72 74 73 0d 0a 20 20 20 20 20
00003360: 66 75 6e 63 74 69 6f 6e 20 61 72 67 75 6d 65 6e
00003370: 74 20 70 72 6f 74 6f 74 79 70 69 6e 67 2e 0d 0a
00003380: 20 20 20 54 68 65 20 66 6f 6c 6c 6f 77 69 6e 67
00003390: 20 6d 61 6b 65 73 20 50 52 4f 54 4f 54 59 50 45
000033a0: 53 20 64 65 66 61 75 6c 74 20 74 6f 20 30 20 69
000033b0: 66 20 69 74 20 68 61 73 20 6e 6f 74 20 61 6c 72
000033c0: 65 61 64 79 0d 0a 20 20 20 20 20 62 65 65 6e 20
000033d0: 64 65 66 69 6e 65 64 20 77 69 74 68 20 43 20 63
000033e0: 6f 6d 70 69 6c 65 72 20 66 6c 61 67 73 2e 0d 0a
000033f0: 20 2a 2f 0d 0a 23 69 66 6e 64 65 66 20 50 52 4f
00003400: 54 4f 54 59 50 45 53 0d 0a 23 64 65 66 69 6e 65
00003410: 20 50 52 4f 54 4f 54 59 50 45 53 20 30 0d 0a 23
00003420: 65 6e 64 69 66 0d 0a 0d 0a 2f 2a 20 50 4f 49 4e

00003430: 54 45 52 20 64 65 66 69 6e 65 73 20 61 20 67 65
00003440: 6e 65 72 69 63 20 70 6f 69 6e 74 65 72 20 74 79
00003450: 70 65 20 2a 2f 0d 0a 74 79 70 65 64 65 66 20 75
00003460: 6e 73 69 67 6e 65 64 20 63 68 61 72 20 2a 50 4f
00003470: 49 4e 54 45 52 3b 0d 0a 0d 0a 2f 2a 20 55 49 4e
00003480: 54 32 20 64 65 66 69 6e 65 73 20 61 20 74 77 6f
00003490: 20 62 79 74 65 20 77 6f 72 64 20 2a 2f 0d 0a 74
000034a0: 79 70 65 64 65 66 20 75 6e 73 69 67 6e 65 64 20
000034b0: 73 68 6f 72 74 20 69 6e 74 20 55 49 4e 54 32 3b
000034c0: 0d 0a 0d 0a 2f 2a 20 55 49 4e 54 34 20 64 65 66
000034d0: 69 6e 65 73 20 61 20 66 6f 75 72 20 62 79 74 65
000034e0: 20 77 6f 72 64 20 2a 2f 0d 0a 74 79 70 65 64 65
000034f0: 66 20 75 6e 73 69 67 6e 65 64 20 6c 6f 6e 67 20
00003500: 69 6e 74 20 55 49 4e 54 34 3b 0d 0a 0d 0a 2f 2a
00003510: 20 50 52 4f 54 4f 5f 4c 49 53 54 20 69 73 20 64
00003520: 65 66 69 6e 65 64 20 64 65 70 65 6e 64 69 6e 67
00003530: 20 6f 6e 20 68 6f 77 20 50 52 4f 54 4f 54 59 50
00003540: 45 53 20 69 73 20 64 65 66 69 6e 65 64 20 61 62
00003550: 6f 76 65 2e 0d 0a 20 20 20 49 66 20 75 73 69 6e
00003560: 67 20 50 52 4f 54 4f 54 59 50 45 53 2c 20 74 68
00003570: 65 6e 20 50 52 4f 54 4f 5f 4c 49 53 54 20 72 65
00003580: 74 75 72 6e 73 20 74 68 65 20 6c 69 73 74 2c 20
00003590: 6f 74 68 65 72 77 69 73 65 20 69 74 0d 0a 20 20
000035a0: 20 20 20 72 65 74 75 72 6e 73 20 61 6e 20 65 6d
000035b0: 70 74 79 20 6c 69 73 74 2e 0d 0a 20 2a 2f 0d 0a
000035c0: 0d 0a 23 69 66 20 50 52 4f 54 4f 54 59 50 45 53
000035d0: 0d 0a 23 64 65 66 69 6e 65 20 50 52 4f 54 4f 5f
000035e0: 4c 49 53 54 28 6c 69 73 74 29 20 6c 69 73 74 0d
000035f0: 0a 23 65 6c 73 65 0d 0a 23 64 65 66 69 6e 65 20
00003600: 50 52 4f 54 4f 5f 4c 49 53 54 28 6c 69 73 74 29
00003610: 20 28 29 0d 0a 23 65 6e 64 69 66 0d 0a 0d 0a 41
00003620: 2e 32 20 6d 64 34 2e 68 0d 0a 0d 0a 2f 2a 20 4d
00003630: 44 34 2e 48 20 2d 20 68 65 61 64 65 72 20 66 69
00003640: 6c 65 20 66 6f 72 20 4d 44 34 43 2e 43 0d 0a 20
00003650: 2a 2f 0d 0a 0d 0a 2f 2a 20 43 6f 70 79 72 69 67
00003660: 68 74 20 28 43 29 20 31 39 39 31 2d 32 2c 20 52
00003670: 53 41 20 44 61 74 61 20 53 65 63 75 72 69 74 79
00003680: 2c 20 49 6e 63 2e 20 43 72 65 61 74 65 64 20 31
00003690: 39 39 31 2e 20 41 6c 6c 0d 0a 20 20 20 72 69 67
000036a0: 68 74 73 20 72 65 73 65 72 76 65 64 2e 0d 0a 0d
000036b0: 0a 20 20 20 4c 69 63 65 6e 73 65 20 74 6f 20 63
000036c0: 6f 70 79 20 61 6e 64 20 75 73 65 20 74 68 69 73
000036d0: 20 73 6f 66 74 77 61 72 65 20 69 73 20 67 72 61
000036e0: 6e 74 65 64 20 70 72 6f 76 69 64 65 64 20 74 68
000036f0: 61 74 20 69 74 0d 0a 20 20 20 69 73 20 69 64 65
00003700: 6e 74 69 66 69 65 64 20 61 73 20 74 68 65 20 22
00003710: 52 53 41 20 44 61 74 61 20 53 65 63 75 72 69 74
00003720: 79 2c 20 49 6e 63 2e 20 4d 44 34 20 4d 65 73 73
00003730: 61 67 65 2d 44 69 67 65 73 74 0d 0a 20 20 20 41
00003740: 6c 67 6f 72 69 74 68 6d 22 20 69 6e 20 61 6c 6c
00003750: 20 6d 61 74 65 72 69 61 6c 20 6d 65 6e 74 69 6f
00003760: 6e 69 6e 67 20 6f 72 20 72 65 66 65 72 65 6e 63
00003770: 69 6e 67 20 74 68 69 73 20 73 6f 66 74 77 61 72
00003780: 65 0d 0a 20 20 20 6f 72 20 74 68 69 73 20 66 75
00003790: 6e 63 74 69 6f 6e 2e 0d 0a 0d 0a 0d 0a 0d 0a 52
000037a0: 69 76 65 73 74 20 20 20 20 20 20 20 20 20 20 20
000037b0: 20 20 20 20 20 20 20 20 20 20 20 20 20 20 20 20
000037c0: 20 20 20 20 20 20 20 20 20 20 20 20 20 20 20 20
000037d0: 20 20 20 20 20 20 20 20 20 20 20 20 20 20 20 5b

000037e0: 50 61 67 65 20 37 5d 0d 0a 0c 0d 0a 52 46 43 20
000037f0: 31 33 32 30 20 20 20 20 20 20 20 20 20 20 20 20
00003800: 20 20 4d 44 34 20 4d 65 73 73 61 67 65 2d 44 69
00003810: 67 65 73 74 20 41 6c 67 6f 72 69 74 68 6d 20 20
00003820: 20 20 20 20 20 20 20 20 20 20 41 70 72 69 6c 20
00003830: 31 39 39 32 0d 0a 0d 0a 0d 0a 20 20 20 4c 69 63
00003840: 65 6e 73 65 20 69 73 20 61 6c 73 6f 20 67 72 61
00003850: 6e 74 65 64 20 74 6f 20 6d 61 6b 65 20 61 6e 64
00003860: 20 75 73 65 20 64 65 72 69 76 61 74 69 76 65 20
00003870: 77 6f 72 6b 73 20 70 72 6f 76 69 64 65 64 0d 0a
00003880: 20 20 20 74 68 61 74 20 73 75 63 68 20 77 6f 72
00003890: 6b 73 20 61 72 65 20 69 64 65 6e 74 69 66 69 65
000038a0: 64 20 61 73 20 22 64 65 72 69 76 65 64 20 66 72
000038b0: 6f 6d 20 74 68 65 20 52 53 41 20 44 61 74 61 0d
000038c0: 0a 20 20 20 53 65 63 75 72 69 74 79 2c 20 49 6e
000038d0: 63 2e 20 4d 44 34 20 4d 65 73 73 61 67 65 2d 44
000038e0: 69 67 65 73 74 20 41 6c 67 6f 72 69 74 68 6d 22
000038f0: 20 69 6e 20 61 6c 6c 20 6d 61 74 65 72 69 61 6c
00003900: 0d 0a 20 20 20 6d 65 6e 74 69 6f 6e 69 6e 67 20
00003910: 6f 72 20 72 65 66 65 72 65 6e 63 69 6e 67 20 74
00003920: 68 65 20 64 65 72 69 76 65 64 20 77 6f 72 6b 2e
00003930: 0d 0a 0d 0a 20 20 20 52 53 41 20 44 61 74 61 20
00003940: 53 65 63 75 72 69 74 79 2c 20 49 6e 63 2e 20 6d
00003950: 61 6b 65 73 20 6e 6f 20 72 65 70 72 65 73 65 6e
00003960: 74 61 74 69 6f 6e 73 20 63 6f 6e 63 65 72 6e 69
00003970: 6e 67 20 65 69 74 68 65 72 0d 0a 20 20 20 74 68
00003980: 65 20 6d 65 72 63 68 61 6e 74 61 62 69 6c 69 74
00003990: 79 20 6f 66 20 74 68 69 73 20 73 6f 66 74 77 61
000039a0: 72 65 20 6f 72 20 74 68 65 20 73 75 69 74 61 62
000039b0: 69 6c 69 74 79 20 6f 66 20 74 68 69 73 0d 0a 20
000039c0: 20 20 73 6f 66 74 77 61 72 65 20 66 6f 72 20 61
000039d0: 6e 79 20 70 61 72 74 69 63 75 6c 61 72 20 70 75
000039e0: 72 70 6f 73 65 2e 20 49 74 20 69 73 20 70 72 6f
000039f0: 76 69 64 65 64 20 22 61 73 20 69 73 22 0d 0a 20
00003a00: 20 20 77 69 74 68 6f 75 74 20 65 78 70 72 65 73
00003a10: 73 20 6f 72 20 69 6d 70 6c 69 65 64 20 77 61 72
00003a20: 72 61 6e 74 79 20 6f 66 20 61 6e 79 20 6b 69 6e
00003a30: 64 2e 0d 0a 0d 0a 20 20 20 54 68 65 73 65 20 6e
00003a40: 6f 74 69 63 65 73 20 6d 75 73 74 20 62 65 20 72
00003a50: 65 74 61 69 6e 65 64 20 69 6e 20 61 6e 79 20 63
00003a60: 6f 70 69 65 73 20 6f 66 20 61 6e 79 20 70 61 72
00003a70: 74 20 6f 66 20 74 68 69 73 0d 0a 20 20 20 64 6f
00003a80: 63 75 6d 65 6e 74 61 74 69 6f 6e 20 61 6e 64 2f
00003a90: 6f 72 20 73 6f 66 74 77 61 72 65 2e 0d 0a 20 2a
00003aa0: 2f 0d 0a 0d 0a 2f 2a 20 4d 44 34 20 63 6f 6e 74
00003ab0: 65 78 74 2e 20 2a 2f 0d 0a 74 79 70 65 64 65 66
00003ac0: 20 73 74 72 75 63 74 20 7b 0d 0a 20 20 55 49 4e
00003ad0: 54 34 20 73 74 61 74 65 5b 34 5d 3b 20 20 20 20
00003ae0: 20 20 20 20 20 20 20 20 20 20 20 20 20 20 20 20
00003af0: 20 20 20 20 20 20 20 20 20 20 20 20 20 20 20 2f
00003b00: 2a 20 73 74 61 74 65 20 28 41 42 43 44 29 20 2a
00003b10: 2f 0d 0a 20 20 55 49 4e 54 34 20 63 6f 75 6e 74
00003b20: 5b 32 5d 3b 20 20 20 20 20 20 20 20 2f 2a 20 6e
00003b30: 75 6d 62 65 72 20 6f 66 20 62 69 74 73 2c 20 6d
00003b40: 6f 64 75 6c 6f 20 32 5e 36 34 20 28 6c 73 62 20
00003b50: 66 69 72 73 74 29 20 2a 2f 0d 0a 20 20 75 6e 73
00003b60: 69 67 6e 65 64 20 63 68 61 72 20 62 75 66 66 65
00003b70: 72 5b 36 34 5d 3b 20 20 20 20 20 20 20 20 20 20
00003b80: 20 20 20 20 20 20 20 20 20 20 20 20 20 20 20 2f

00003b90: 2a 20 69 6e 70 75 74 20 62 75 66 66 65 72 20 2a
00003ba0: 2f 0d 0a 7d 20 4d 44 34 5f 43 54 58 3b 0d 0a 0d
00003bb0: 0a 76 6f 69 64 20 4d 44 34 49 6e 69 74 20 50 52
00003bc0: 4f 54 4f 5f 4c 49 53 54 20 28 28 4d 44 34 5f 43
00003bd0: 54 58 20 2a 29 29 3b 0d 0a 76 6f 69 64 20 4d 44
00003be0: 34 55 70 64 61 74 65 20 50 52 4f 54 4f 5f 4c 49
00003bf0: 53 54 0d 0a 20 20 28 28 4d 44 34 5f 43 54 58 20
00003c00: 2a 2c 20 75 6e 73 69 67 6e 65 64 20 63 68 61 72
00003c10: 20 2a 2c 20 75 6e 73 69 67 6e 65 64 20 69 6e 74
00003c20: 29 29 3b 0d 0a 76 6f 69 64 20 4d 44 34 46 69 6e
00003c30: 61 6c 20 50 52 4f 54 4f 5f 4c 49 53 54 20 28 28
00003c40: 75 6e 73 69 67 6e 65 64 20 63 68 61 72 20 5b 31
00003c50: 36 5d 2c 20 4d 44 34 5f 43 54 58 20 2a 29 29 3b
00003c60: 0d 0a 0d 0a 41 2e 33 20 6d 64 34 63 2e 63 0d 0a
00003c70: 0d 0a 2f 2a 20 4d 44 34 43 2e 43 20 2d 20 52 53
00003c80: 41 20 44 61 74 61 20 53 65 63 75 72 69 74 79 2c
00003c90: 20 49 6e 63 2e 2c 20 4d 44 34 20 6d 65 73 73 61
00003ca0: 67 65 2d 64 69 67 65 73 74 20 61 6c 67 6f 72 69
00003cb0: 74 68 6d 0d 0a 20 2a 2f 0d 0a 0d 0a 2f 2a 20 43
00003cc0: 6f 70 79 72 69 67 68 74 20 28 43 29 20 31 39 39
00003cd0: 30 2d 32 2c 20 52 53 41 20 44 61 74 61 20 53 65
00003ce0: 63 75 72 69 74 79 2c 20 49 6e 63 2e 20 41 6c 6c
00003cf0: 20 72 69 67 68 74 73 20 72 65 73 65 72 76 65 64
00003d00: 2e 0d 0a 0d 0a 20 20 20 4c 69 63 65 6e 73 65 20
00003d10: 74 6f 20 63 6f 70 79 20 61 6e 64 20 75 73 65 20
00003d20: 74 68 69 73 20 73 6f 66 74 77 61 72 65 20 69 73
00003d30: 20 67 72 61 6e 74 65 64 20 70 72 6f 76 69 64 65
00003d40: 64 20 74 68 61 74 20 69 74 0d 0a 20 20 20 69 73
00003d50: 20 69 64 65 6e 74 69 66 69 65 64 20 61 73 20 74
00003d60: 68 65 20 22 52 53 41 20 44 61 74 61 20 53 65 63
00003d70: 75 72 69 74 79 2c 20 49 6e 63 2e 20 4d 44 34 20
00003d80: 4d 65 73 73 61 67 65 2d 44 69 67 65 73 74 0d 0a
00003d90: 20 20 20 41 6c 67 6f 72 69 74 68 6d 22 20 69 6e
00003da0: 20 61 6c 6c 20 6d 61 74 65 72 69 61 6c 20 6d 65
00003db0: 6e 74 69 6f 6e 69 6e 67 20 6f 72 20 72 65 66 65
00003dc0: 72 65 6e 63 69 6e 67 20 74 68 69 73 20 73 6f 66
00003dd0: 74 77 61 72 65 0d 0a 20 20 20 6f 72 20 74 68 69
00003de0: 73 20 66 75 6e 63 74 69 6f 6e 2e 0d 0a 0d 0a 20
00003df0: 20 20 4c 69 63 65 6e 73 65 20 69 73 20 61 6c 73
00003e00: 6f 20 67 72 61 6e 74 65 64 20 74 6f 20 6d 61 6b
00003e10: 65 20 61 6e 64 20 75 73 65 20 64 65 72 69 76 61
00003e20: 74 69 76 65 20 77 6f 72 6b 73 20 70 72 6f 76 69
00003e30: 64 65 64 0d 0a 20 20 20 74 68 61 74 20 73 75 63
00003e40: 68 20 77 6f 72 6b 73 20 61 72 65 20 69 64 65 6e
00003e50: 74 69 66 69 65 64 20 61 73 20 22 64 65 72 69 76
00003e60: 65 64 20 66 72 6f 6d 20 74 68 65 20 52 53 41 20
00003e70: 44 61 74 61 0d 0a 20 20 20 53 65 63 75 72 69 74
00003e80: 79 2c 20 49 6e 63 2e 20 4d 44 34 20 4d 65 73 73
00003e90: 61 67 65 2d 44 69 67 65 73 74 20 41 6c 67 6f 72
00003ea0: 69 74 68 6d 22 20 69 6e 20 61 6c 6c 20 6d 61 74
00003eb0: 65 72 69 61 6c 0d 0a 20 20 20 6d 65 6e 74 69 6f
00003ec0: 6e 69 6e 67 20 6f 72 20 72 65 66 65 72 65 6e 63
00003ed0: 69 6e 67 20 74 68 65 20 64 65 72 69 76 65 64 20
00003ee0: 77 6f 72 6b 2e 0d 0a 0d 0a 20 20 20 52 53 41 20
00003ef0: 44 61 74 61 20 53 65 63 75 72 69 74 79 2c 20 49
00003f00: 6e 63 2e 20 6d 61 6b 65 73 20 6e 6f 20 72 65 70
00003f10: 72 65 73 65 6e 74 61 74 69 6f 6e 73 20 63 6f 6e
00003f20: 63 65 72 6e 69 6e 67 20 65 69 74 68 65 72 0d 0a
00003f30: 20 20 20 74 68 65 20 6d 65 72 63 68 61 6e 74 61

00003f40: 62 69 6c 69 74 79 20 6f 66 20 74 68 69 73 20 73
00003f50: 6f 66 74 77 61 72 65 20 6f 72 20 74 68 65 20 73
00003f60: 75 69 74 61 62 69 6c 69 74 79 20 6f 66 20 74 68
00003f70: 69 73 0d 0a 20 20 20 73 6f 66 74 77 61 72 65 20
00003f80: 66 6f 72 20 61 6e 79 20 70 61 72 74 69 63 75 6c
00003f90: 61 72 20 70 75 72 70 6f 73 65 2e 20 49 74 20 69
00003fa0: 73 20 70 72 6f 76 69 64 65 64 20 22 61 73 20 69
00003fb0: 73 22 0d 0a 20 20 20 77 69 74 68 6f 75 74 20 65
00003fc0: 78 70 72 65 73 73 20 6f 72 20 69 6d 70 6c 69 65
00003fd0: 64 20 77 61 72 72 61 6e 74 79 20 6f 66 20 61 6e
00003fe0: 79 20 6b 69 6e 64 2e 0d 0a 0d 0a 0d 0a 0d 0a 0d
00003ff0: 0a 52 69 76 65 73 74 20 20 20 20 20 20 20 20 20

00004000: 20 20 20 20 20 20 20 20 20 20 20 20 20 20 20 20
00004010: 20 20 20 20 20 20 20 20 20 20 20 20 20 20 20 20
00004020: 20 20 20 20 20 20 20 20 20 20 20 20 20 20 20 20
00004030: 20 5b 50 61 67 65 20 38 5d 0d 0a 0c 0d 0a 52 46
00004040: 43 20 31 33 32 30 20 20 20 20 20 20 20 20 20 20
00004050: 20 20 20 20 4d 44 34 20 4d 65 73 73 61 67 65 2d
00004060: 44 69 67 65 73 74 20 41 6c 67 6f 72 69 74 68 6d
00004070: 20 20 20 20 20 20 20 20 20 20 20 20 41 70 72 69
00004080: 6c 20 31 39 39 32 0d 0a 0d 0a 0d 0a 20 20 20 54
00004090: 68 65 73 65 20 6e 6f 74 69 63 65 73 20 6d 75 73
000040a0: 74 20 62 65 20 72 65 74 61 69 6e 65 64 20 69 6e
000040b0: 20 61 6e 79 20 63 6f 70 69 65 73 20 6f 66 20 61
000040c0: 6e 79 20 70 61 72 74 20 6f 66 20 74 68 69 73 0d
000040d0: 0a 20 20 20 64 6f 63 75 6d 65 6e 74 61 74 69 6f
000040e0: 6e 20 61 6e 64 2f 6f 72 20 73 6f 66 74 77 61 72
000040f0: 65 2e 0d 0a 20 2a 2f 0d 0a 0d 0a 23 69 6e 63 6c
00004100: 75 64 65 20 22 67 6c 6f 62 61 6c 2e 68 22 0d 0a
00004110: 23 69 6e 63 6c 75 64 65 20 22 6d 64 34 2e 68 22
00004120: 0d 0a 0d 0a 2f 2a 20 43 6f 6e 73 74 61 6e 74 73
00004130: 20 66 6f 72 20 4d 44 34 54 72 61 6e 73 66 6f 72
00004140: 6d 20 72 6f 75 74 69 6e 65 2e 0d 0a 20 2a 2f 0d
00004150: 0a 23 64 65 66 69 6e 65 20 53 31 31 20 33 0d 0a
00004160: 23 64 65 66 69 6e 65 20 53 31 32 20 37 0d 0a 23
00004170: 64 65 66 69 6e 65 20 53 31 33 20 31 31 0d 0a 23
00004180: 64 65 66 69 6e 65 20 53 31 34 20 31 39 0d 0a 23
00004190: 64 65 66 69 6e 65 20 53 32 31 20 33 0d 0a 23 64
000041a0: 65 66 69 6e 65 20 53 32 32 20 35 0d 0a 23 64 65
000041b0: 66 69 6e 65 20 53 32 33 20 39 0d 0a 23 64 65 66
000041c0: 69 6e 65 20 53 32 34 20 31 33 0d 0a 23 64 65 66
000041d0: 69 6e 65 20 53 33 31 20 33 0d 0a 23 64 65 66 69
000041e0: 6e 65 20 53 33 32 20 39 0d 0a 23 64 65 66 69 6e
000041f0: 65 20 53 33 33 20 31 31 0d 0a 23 64 65 66 69 6e
00004200: 65 20 53 33 34 20 31 35 0d 0a 0d 0a 73 74 61 74
00004210: 69 63 20 76 6f 69 64 20 4d 44 34 54 72 61 6e 73
00004220: 66 6f 72 6d 20 50 52 4f 54 4f 5f 4c 49 53 54 20
00004230: 28 28 55 49 4e 54 34 20 5b 34 5d 2c 20 75 6e 73
00004240: 69 67 6e 65 64 20 63 68 61 72 20 5b 36 34 5d 29
00004250: 29 3b 0d 0a 73 74 61 74 69 63 20 76 6f 69 64 20
00004260: 45 6e 63 6f 64 65 20 50 52 4f 54 4f 5f 4c 49 53
00004270: 54 0d 0a 20 20 28 28 75 6e 73 69 67 6e 65 64 20
00004280: 63 68 61 72 20 2a 2c 20 55 49 4e 54 34 20 2a 2c
00004290: 20 75 6e 73 69 67 6e 65 64 20 69 6e 74 29 29 3b
000042a0: 0d 0a 73 74 61 74 69 63 20 76 6f 69 64 20 44 65
000042b0: 63 6f 64 65 20 50 52 4f 54 4f 5f 4c 49 53 54 0d
000042c0: 0a 20 20 28 28 55 49 4e 54 34 20 2a 2c 20 75 6e

000042d0: 73 69 67 6e 65 64 20 63 68 61 72 20 2a 2c 20 75
000042e0: 6e 73 69 67 6e 65 64 20 69 6e 74 29 29 3b 0d 0a
000042f0: 73 74 61 74 69 63 20 76 6f 69 64 20 4d 44 34 5f
00004300: 6d 65 6d 63 70 79 20 50 52 4f 54 4f 5f 4c 49 53
00004310: 54 20 28 28 50 4f 49 4e 54 45 52 2c 20 50 4f 49
00004320: 4e 54 45 52 2c 20 75 6e 73 69 67 6e 65 64 20 69
00004330: 6e 74 29 29 3b 0d 0a 73 74 61 74 69 63 20 76 6f
00004340: 69 64 20 4d 44 34 5f 6d 65 6d 73 65 74 20 50 52
00004350: 4f 54 4f 5f 4c 49 53 54 20 28 28 50 4f 49 4e 54
00004360: 45 52 2c 20 69 6e 74 2c 20 75 6e 73 69 67 6e 65
00004370: 64 20 69 6e 74 29 29 3b 0d 0a 0d 0a 73 74 61 74
00004380: 69 63 20 75 6e 73 69 67 6e 65 64 20 63 68 61 72
00004390: 20 50 41 44 44 49 4e 47 5b 36 34 5d 20 3d 20 7b
000043a0: 0d 0a 20 20 30 78 38 30 2c 20 30 2c 20 30 2c 20
000043b0: 30 2c 20 30 2c 20 30 2c 20 20 30 2c 20 30 2c 20 30
000043c0: 2c 20 30 2c 20 30 2c 20 30 2c 20 30 2c 20 30 2c
000043d0: 20 30 2c 20 30 2c 20 30 2c 20 30 2c 20 30 2c 20
000043e0: 30 2c 20 30 2c 20 30 2c 20 0d 0a 20 20 30 2c 20 30
000043f0: 2c 20 30 2c 20 30 2c 20 30 2c 20 30 2c 20 30 2c
00004400: 20 30 2c 20 30 2c 20 30 2c 20 30 2c 20 30 2c 20
00004410: 30 2c 20 30 2c 20 30 2c 20 20 30 2c 20 30 2c 20 30
00004420: 2c 20 30 2c 20 30 2c 20 30 2c 20 30 2c 20 30 2c
00004430: 0d 0a 20 20 30 2c 20 30 2c 20 30 2c 20 30 2c 20
00004440: 30 2c 20 30 2c 20 30 2c 20 20 30 2c 20 30 2c 20 30
00004450: 2c 20 30 2c 20 30 2c 20 30 2c 20 30 2c 20 30 2c
00004460: 20 30 2c 20 30 2c 20 30 2c 20 30 0d 0a 7d 3b 0d
00004470: 0a 0d 0a 2f 2a 20 46 2c 20 47 20 61 6e 64 20 48
00004480: 20 61 72 65 20 62 61 73 69 63 20 4d 44 34 20 66
00004490: 75 6e 63 74 69 6f 6e 73 2e 0d 0a 20 2a 2f 0d 0a
000044a0: 23 64 65 66 69 6e 65 20 46 28 78 2c 20 79 2c 20
000044b0: 7a 29 20 28 28 28 78 29 20 26 20 28 79 29 29 20
000044c0: 7c 20 28 28 7e 78 29 20 26 20 28 7a 29 29 29 0d
000044d0: 0a 23 64 65 66 69 6e 65 20 47 28 78 2c 20 79 2c
000044e0: 20 7a 29 20 28 28 28 78 29 20 26 20 28 79 29 29
000044f0: 20 7c 20 28 28 78 29 20 26 20 28 7a 29 29 20 7c
00004500: 20 28 28 79 29 20 26 20 28 7a 29 29 29 0d 0a 23
00004510: 64 65 66 69 6e 65 20 48 28 78 2c 20 79 2c 20 7a
00004520: 29 20 28 28 78 29 20 5e 20 28 79 29 20 5e 20 28
00004530: 7a 29 29 0d 0a 0d 0a 2f 2a 20 52 4f 54 41 54 45
00004540: 5f 4c 45 46 54 20 72 6f 74 61 74 65 73 20 78 20
00004550: 6c 65 66 74 20 6e 20 62 69 74 73 2e 0d 0a 20 2a
00004560: 2f 0d 0a 23 64 65 66 69 6e 65 20 52 4f 54 41 54
00004570: 45 5f 4c 45 46 54 28 78 2c 20 6e 29 20 28 28 28
00004580: 78 29 20 3c 3c 20 28 6e 29 29 20 7c 20 28 28 78
00004590: 29 20 3e 3e 20 28 33 32 2d 28 6e 29 29 29 29 0d
000045a0: 0a 0d 0a 2f 2a 20 46 46 2c 20 47 47 20 61 6e 64
000045b0: 20 48 48 20 61 72 65 20 74 72 61 6e 73 66 6f 72
000045c0: 6d 61 74 69 6f 6e 73 20 66 6f 72 20 72 6f 75 6e
000045d0: 64 73 20 31 2c 20 32 20 61 6e 64 20 33 20 2a 2f
000045e0: 0d 0a 2f 2a 20 52 6f 74 61 74 69 6f 6e 20 69 73
000045f0: 20 73 65 70 61 72 61 74 65 20 66 72 6f 6d 20 61
00004600: 64 64 69 74 69 6f 6e 20 74 6f 20 70 72 65 76 65
00004610: 6e 74 20 72 65 63 6f 6d 70 75 74 61 74 69 6f 6e
00004620: 20 2a 2f 0d 0a 0d 0a 0d 0a 0d 0a 52 69 76 65 73
00004630: 74 20 20 20 20 20 20 20 20 20 20 20 20 20 20 20
00004640: 20 20 20 20 20 20 20 20 20 20 20 20 20 20 20 20
00004650: 20 20 20 20 20 20 20 20 20 20 20 20 20 20 20 20
00004660: 20 20 20 20 20 20 20 20 20 20 20 5b 50 61 67 65
00004670: 20 39 5d 0d 0a 0c 0d 0a 52 46 43 20 31 33 32 30

00004680: 20 20 20 20 20 20 20 20 20 20 20 20 20 20 20 4d 44
00004690: 34 20 4d 65 73 73 61 67 65 2d 44 69 67 65 73 74
000046a0: 20 41 6c 67 6f 72 69 74 68 6d 20 20 20 20 20 20
000046b0: 20 20 20 20 20 20 41 70 72 69 6c 20 31 39 39 32
000046c0: 0d 0a 0d 0a 0d 0a 23 64 65 66 69 6e 65 20 46 46
000046d0: 28 61 2c 20 62 2c 20 63 2c 20 64 2c 20 78 2c 20
000046e0: 73 29 20 7b 20 5c 0d 0a 20 20 20 20 28 61 29 20
000046f0: 2b 3d 20 46 20 28 28 62 29 2c 20 28 63 29 2c 20
00004700: 28 64 29 29 20 2b 20 28 78 29 3b 20 5c 0d 0a 20
00004710: 20 20 20 28 61 29 20 3d 20 52 4f 54 41 54 45 5f
00004720: 4c 45 46 54 20 28 28 61 29 2c 20 28 73 29 29 3b
00004730: 20 5c 0d 0a 20 20 7d 0d 0a 23 64 65 66 69 6e 65
00004740: 20 47 47 28 61 2c 20 62 2c 20 63 2c 20 64 2c 20
00004750: 78 2c 20 73 29 20 7b 20 5c 0d 0a 20 20 20 20 28
00004760: 61 29 20 2b 3d 20 47 20 28 28 62 29 2c 20 28 63
00004770: 29 2c 20 28 64 29 29 20 2b 20 28 78 29 20 2b 20
00004780: 28 55 49 4e 54 34 29 30 78 35 61 38 32 37 39 39
00004790: 39 3b 20 5c 0d 0a 20 20 20 20 28 61 29 20 3d 20
000047a0: 52 4f 54 41 54 45 5f 4c 45 46 54 20 28 28 61 29
000047b0: 2c 20 28 73 29 29 3b 20 5c 0d 0a 20 20 7d 0d 0a
000047c0: 23 64 65 66 69 6e 65 20 48 48 28 61 2c 20 62 2c
000047d0: 20 63 2c 20 64 2c 20 78 2c 20 73 29 20 7b 20 5c
000047e0: 0d 0a 20 20 20 20 28 61 29 20 2b 3d 20 48 20 28
000047f0: 28 62 29 2c 20 28 63 29 2c 20 28 64 29 29 20 2b
00004800: 20 28 78 29 20 2b 20 28 55 49 4e 54 34 29 30 78
00004810: 36 65 64 39 65 62 61 31 3b 20 5c 0d 0a 20 20 20
00004820: 20 28 61 29 20 3d 20 52 4f 54 41 54 45 5f 4c 45
00004830: 46 54 20 28 28 61 29 2c 20 28 73 29 29 3b 20 5c
00004840: 0d 0a 20 20 7d 0d 0a 0d 0a 2f 2a 20 4d 44 34 20
00004850: 69 6e 69 74 69 61 6c 69 7a 61 74 69 6f 6e 2e 20
00004860: 42 65 67 69 6e 73 20 61 6e 20 4d 44 34 20 6f 70
00004870: 65 72 61 74 69 6f 6e 2c 20 77 72 69 74 69 6e 67
00004880: 20 61 20 6e 65 77 20 63 6f 6e 74 65 78 74 2e 0d
00004890: 0a 20 2a 2f 0d 0a 76 6f 69 64 20 4d 44 34 49 6e
000048a0: 69 74 20 28 63 6f 6e 74 65 78 74 29 0d 0a 4d 44
000048b0: 34 5f 43 54 58 20 2a 63 6f 6e 74 65 78 74 3b 20
000048c0: 20 20 20 20 20 20 20 20 20 20 20 20 20 20 20
000048d0: 20 20 20 20 20 20 20 20 20 20 20 20 20 20 20
000048e0: 20 20 20 20 20 20 20 2f 2a 20 63 6f 6e 74 65 78
000048f0: 74 20 2a 2f 0d 0a 7b 0d 0a 20 20 63 6f 6e 74 65
00004900: 78 74 2d 3e 63 6f 75 6e 74 5b 30 5d 20 3d 20 63
00004910: 6f 6e 74 65 78 74 2d 3e 63 6f 75 6e 74 5b 31 5d
00004920: 20 3d 20 30 3b 0d 0a 0d 0a 20 20 2f 2a 20 4c 6f
00004930: 61 64 20 6d 61 67 69 63 20 69 6e 69 74 69 61 6c
00004940: 69 7a 61 74 69 6f 6e 20 63 6f 6e 73 74 61 6e 74
00004950: 73 2e 0d 0a 20 20 20 2a 2f 0d 0a 20 20 63 6f 6e
00004960: 74 65 78 74 2d 3e 73 74 61 74 65 5b 30 5d 20 3d
00004970: 20 30 78 36 37 34 35 32 33 30 31 3b 0d 0a 20 20
00004980: 63 6f 6e 74 65 78 74 2d 3e 73 74 61 74 65 5b 31
00004990: 5d 20 3d 20 30 78 65 66 63 64 61 62 38 39 3b 0d
000049a0: 0a 20 20 63 6f 6e 74 65 78 74 2d 3e 73 74 61 74
000049b0: 65 5b 32 5d 20 3d 20 30 78 39 38 62 61 64 63 66
000049c0: 65 3b 0d 0a 20 20 63 6f 6e 74 65 78 74 2d 3e 73
000049d0: 74 61 74 65 5b 33 5d 20 3d 20 30 78 31 30 33 32
000049e0: 35 34 37 36 3b 0d 0a 7d 0d 0a 0d 0a 2f 2a 20 4d
000049f0: 44 34 20 62 6c 6f 63 6b 20 75 70 64 61 74 65 20
00004a00: 6f 70 65 72 61 74 69 6f 6e 2e 20 43 6f 6e 74 69
00004a10: 6e 75 65 73 20 61 6e 20 4d 44 34 20 6d 65 73 73
00004a20: 61 67 65 2d 64 69 67 65 73 74 0d 0a 20 20 20 20

00004a30: 20 6f 70 65 72 61 74 69 6f 6e 2c 20 70 72 6f 63
00004a40: 65 73 73 69 6e 67 20 61 6e 6f 74 68 65 72 20 6d
00004a50: 65 73 73 61 67 65 20 62 6c 6f 63 6b 2c 20 61 6e
00004a60: 64 20 75 70 64 61 74 69 6e 67 20 74 68 65 0d 0a
00004a70: 20 20 20 20 20 63 6f 6e 74 65 78 74 2e 0d 0a 20
00004a80: 2a 2f 0d 0a 76 6f 69 64 20 4d 44 34 55 70 64 61
00004a90: 74 65 20 28 63 6f 6e 74 65 78 74 2c 20 69 6e 70
00004aa0: 75 74 2c 20 69 6e 70 75 74 4c 65 6e 29 0d 0a 4d
00004ab0: 44 34 5f 43 54 58 20 2a 63 6f 6e 74 65 78 74 3b
00004ac0: 20 20 20 20 20 20 20 20 20 20 20 20 20 20 20 20
00004ad0: 20 20 20 20 20 20 20 20 20 20 20 20 20 20 20 20
00004ae0: 20 20 20 20 20 20 20 20 2f 2a 20 63 6f 6e 74 65
00004af0: 78 74 20 2a 2f 0d 0a 75 6e 73 69 67 6e 65 64 20
00004b00: 63 68 61 72 20 2a 69 6e 70 75 74 3b 20 20 20 20
00004b10: 20 20 20 20 20 20 20 20 20 20 20 20 20 20 20 20
00004b20: 20 20 20 20 20 20 20 20 20 20 20 20 2f 2a 20 69
00004b30: 6e 70 75 74 20 62 6c 6f 63 6b 20 2a 2f 0d 0a 75
00004b40: 6e 73 69 67 6e 65 64 20 69 6e 74 20 69 6e 70 75
00004b50: 74 4c 65 6e 3b 20 20 20 20 20 20 20 20 20 20 20
00004b60: 20 20 20 20 20 20 20 20 20 20 2f 2a 20 6c 65 6e
00004b70: 67 74 68 20 6f 66 20 69 6e 70 75 74 20 62 6c 6f
00004b80: 63 6b 20 2a 2f 0d 0a 7b 0d 0a 20 20 75 6e 73 69
00004b90: 67 6e 65 64 20 69 6e 74 20 69 2c 20 69 6e 64 65
00004ba0: 78 2c 20 70 61 72 74 4c 65 6e 3b 0d 0a 0d 0a 20
00004bb0: 20 2f 2a 20 43 6f 6d 70 75 74 65 20 6e 75 6d 62
00004bc0: 65 72 20 6f 66 20 62 79 74 65 73 20 6d 6f 64 20
00004bd0: 36 34 20 2a 2f 0d 0a 20 20 69 6e 64 65 78 20 3d
00004be0: 20 28 75 6e 73 69 67 6e 65 64 20 69 6e 74 29 28
00004bf0: 28 63 6f 6e 74 65 78 74 2d 3e 63 6f 75 6e 74 5b
00004c00: 30 5d 20 3e 3e 20 33 29 20 26 20 30 78 33 46 29
00004c10: 3b 0d 0a 20 20 2f 2a 20 55 70 64 61 74 65 20 6e
00004c20: 75 6d 62 65 72 20 6f 66 20 62 69 74 73 20 2a 2f
00004c30: 0d 0a 20 20 69 66 20 28 28 63 6f 6e 74 65 78 74
00004c40: 2d 3e 63 6f 75 6e 74 5b 30 5d 20 2b 3d 20 28 28
00004c50: 55 49 4e 54 34 29 69 6e 70 75 74 4c 65 6e 20 3c
00004c60: 3c 20 33 29 29 0d 0a 20 20 20 20 20 20 3c 20 28
00004c70: 28 55 49 4e 54 34 29 69 6e 70 75 74 4c 65 6e 20
00004c80: 3c 3c 20 33 29 29 0d 0a 20 20 20 20 63 6f 6e 74
00004c90: 65 78 74 2d 3e 63 6f 75 6e 74 5b 31 5d 2b 2b 3b
00004ca0: 0d 0a 20 20 63 6f 6e 74 65 78 74 2d 3e 63 6f 75
00004cb0: 6e 74 5b 31 5d 20 2b 3d 20 28 28 55 49 4e 54 34
00004cc0: 29 69 6e 70 75 74 4c 65 6e 20 3e 3e 20 32 39 29
00004cd0: 3b 0d 0a 0d 0a 20 20 70 61 72 74 4c 65 6e 20 3d
00004ce0: 20 36 34 20 2d 20 69 6e 64 65 78 3b 0d 0a 0d 0a
00004cf0: 0d 0a 0d 0a 52 69 76 65 73 74 20 20 20 20 20 20
00004d00: 20 20 20 20 20 20 20 20 20 20 20 20 20 20 20 20
00004d10: 20 20 20 20 20 20 20 20 20 20 20 20 20 20 20 20
00004d20: 20 20 20 20 20 20 20 20 20 20 20 20 20 20 20 20
00004d30: 20 20 20 5b 50 61 67 65 20 31 30 5d 0d 0a 0c 0d
00004d40: 0a 52 46 43 20 31 33 32 30 20 20 20 20 20 20 20
00004d50: 20 20 20 20 20 20 20 4d 44 34 20 4d 65 73 73 61
00004d60: 67 65 2d 44 69 67 65 73 74 20 41 6c 67 6f 72 69
00004d70: 74 68 6d 20 20 20 20 20 20 20 20 20 20 20 20 41
00004d80: 70 72 69 6c 20 31 39 39 32 0d 0a 0d 0a 0d 0a 20
00004d90: 20 2f 2a 20 54 72 61 6e 73 66 6f 72 6d 20 61 73
00004da0: 20 6d 61 6e 79 20 74 69 6d 65 73 20 61 73 20 70
00004db0: 6f 73 73 69 62 6c 65 2e 0d 0a 20 20 20 2a 2f 0d
00004dc0: 0a 20 20 69 66 20 28 69 6e 70 75 74 4c 65 6e 20
00004dd0: 3e 3d 20 70 61 72 74 4c 65 6e 29 20 7b 0d 0a 20

00004de0: 20 20 20 4d 44 34 5f 6d 65 6d 63 70 79 0d 0a 20
00004df0: 20 20 20 20 20 28 28 50 4f 49 4e 54 45 52 29 26
00004e00: 63 6f 6e 74 65 78 74 2d 3e 62 75 66 66 65 72 5b
00004e10: 69 6e 64 65 78 5d 2c 20 28 50 4f 49 4e 54 45 52
00004e20: 29 69 6e 70 75 74 2c 20 70 61 72 74 4c 65 6e 29
00004e30: 3b 0d 0a 20 20 20 20 4d 44 34 54 72 61 6e 73 66
00004e40: 6f 72 6d 20 28 63 6f 6e 74 65 78 74 2d 3e 73 74
00004e50: 61 74 65 2c 20 63 6f 6e 74 65 78 74 2d 3e 62 75
00004e60: 66 66 65 72 29 3b 0d 0a 0d 0a 20 20 20 20 66 6f
00004e70: 72 20 28 69 20 3d 20 70 61 72 74 4c 65 6e 3b 20
00004e80: 69 20 2b 20 36 33 20 3c 20 69 6e 70 75 74 4c 65
00004e90: 6e 3b 20 69 20 2b 3d 20 36 34 29 0d 0a 20 20 20
00004ea0: 20 20 20 4d 44 34 54 72 61 6e 73 66 6f 72 6d 20
00004eb0: 28 63 6f 6e 74 65 78 74 2d 3e 73 74 61 74 65 2c
00004ec0: 20 26 69 6e 70 75 74 5b 69 5d 29 3b 0d 0a 0d 0a
00004ed0: 20 20 20 20 69 6e 64 65 78 20 3d 20 30 3b 0d 0a
00004ee0: 20 20 7d 0d 0a 20 20 65 6c 73 65 0d 0a 20 20 20
00004ef0: 20 69 20 3d 20 30 3b 0d 0a 0d 0a 20 20 2f 2a 20
00004f00: 42 75 66 66 65 72 20 72 65 6d 61 69 6e 69 6e 67
00004f10: 20 69 6e 70 75 74 20 2a 2f 0d 0a 20 20 4d 44 34
00004f20: 5f 6d 65 6d 63 70 79 0d 0a 20 20 20 20 28 28 50
00004f30: 4f 49 4e 54 45 52 29 26 63 6f 6e 74 65 78 74 2d
00004f40: 3e 62 75 66 66 65 72 5b 69 6e 64 65 78 5d 2c 20
00004f50: 28 50 4f 49 4e 54 45 52 29 26 69 6e 70 75 74 5b
00004f60: 69 5d 2c 0d 0a 20 20 20 20 20 69 6e 70 75 74 4c
00004f70: 65 6e 2d 69 29 3b 0d 0a 7d 0d 0a 0d 0a 2f 2a 20
00004f80: 4d 44 34 20 66 69 6e 61 6c 69 7a 61 74 69 6f 6e
00004f90: 2e 20 45 6e 64 73 20 61 6e 20 4d 44 34 20 6d 65
00004fa0: 73 73 61 67 65 2d 64 69 67 65 73 74 20 6f 70 65
00004fb0: 72 61 74 69 6f 6e 2c 20 77 72 69 74 69 6e 67 20
00004fc0: 74 68 65 0d 0a 20 20 20 20 20 74 68 65 20 6d 65
00004fd0: 73 73 61 67 65 20 64 69 67 65 73 74 20 61 6e 64
00004fe0: 20 7a 65 72 6f 69 7a 69 6e 67 20 74 68 65 20 63
00004ff0: 6f 6e 74 65 78 74 2e 0d 0a 20 2a 2f 0d 0a 76 6f

00005000: 69 64 20 4d 44 34 46 69 6e 61 6c 20 28 64 69 67
00005010: 65 73 74 2c 20 63 6f 6e 74 65 78 74 29 0d 0a 75
00005020: 6e 73 69 67 6e 65 64 20 63 68 61 72 20 64 69 67
00005030: 65 73 74 5b 31 36 5d 3b 20 20 20 20 20 20 20 20
00005040: 20 20 20 20 20 20 20 20 20 20 20 20 20 20 20 20
00005050: 20 2f 2a 20 6d 65 73 73 61 67 65 20 64 69 67 65
00005060: 73 74 20 2a 2f 0d 0a 4d 44 34 5f 43 54 58 20 2a
00005070: 63 6f 6e 74 65 78 74 3b 20 20 20 20 20 20 20 20
00005080: 20 20 20 20 20 20 20 20 20 20 20 20 20 20 20 20
00005090: 20 20 20 20 20 20 20 20 20 20 20 20 20 20 20 20
000050a0: 2f 2a 20 63 6f 6e 74 65 78 74 20 2a 2f 0d 0a 7b
000050b0: 0d 0a 20 20 75 6e 73 69 67 6e 65 64 20 63 68 61
000050c0: 72 20 62 69 74 73 5b 38 5d 3b 0d 0a 20 20 75 6e
000050d0: 73 69 67 6e 65 64 20 69 6e 74 20 69 6e 64 65 78
000050e0: 2c 20 70 61 64 4c 65 6e 3b 0d 0a 0d 0a 20 20 2f
000050f0: 2a 20 53 61 76 65 20 6e 75 6d 62 65 72 20 6f 66
00005100: 20 62 69 74 73 20 2a 2f 0d 0a 20 20 45 6e 63 6f
00005110: 64 65 20 28 62 69 74 73 2c 20 63 6f 6e 74 65 78
00005120: 74 2d 3e 63 6f 75 6e 74 2c 20 38 29 3b 0d 0a 0d
00005130: 0a 20 20 2f 2a 20 50 61 64 20 6f 75 74 20 74 6f
00005140: 20 35 36 20 6d 6f 64 20 36 34 2e 0d 0a 20 20 20
00005150: 2a 2f 0d 0a 20 20 69 6e 64 65 78 20 3d 20 28 75
00005160: 6e 73 69 67 6e 65 64 20 69 6e 74 29 28 28 63 6f

00005170: 6e 74 65 78 74 2d 3e 63 6f 75 6e 74 5b 30 5d 20
00005180: 3e 3e 20 33 29 20 26 20 30 78 33 66 29 3b 0d 0a
00005190: 20 20 70 61 64 4c 65 6e 20 3d 20 28 69 6e 64 65
000051a0: 78 20 3c 20 35 36 29 20 3f 20 28 35 36 20 2d 20
000051b0: 69 6e 64 65 78 29 20 3a 20 28 31 32 30 20 2d 20
000051c0: 69 6e 64 65 78 29 3b 0d 0a 20 20 4d 44 34 55 70
000051d0: 64 61 74 65 20 28 63 6f 6e 74 65 78 74 2c 20 50
000051e0: 41 44 44 49 4e 47 2c 20 70 61 64 4c 65 6e 29 3b
000051f0: 0d 0a 0d 0a 20 20 2f 2a 20 41 70 70 65 6e 64 20
00005200: 6c 65 6e 67 74 68 20 28 62 65 66 6f 72 65 20 70
00005210: 61 64 64 69 6e 67 29 20 2a 2f 0d 0a 20 20 4d 44
00005220: 34 55 70 64 61 74 65 20 28 63 6f 6e 74 65 78 74
00005230: 2c 20 62 69 74 73 2c 20 38 29 3b 0d 0a 20 20 2f
00005240: 2a 20 53 74 6f 72 65 20 73 74 61 74 65 20 69 6e
00005250: 20 64 69 67 65 73 74 20 2a 2f 0d 0a 20 20 45 6e
00005260: 63 6f 64 65 20 28 64 69 67 65 73 74 2c 20 63 6f
00005270: 6e 74 65 78 74 2d 3e 73 74 61 74 65 2c 20 31 36
00005280: 29 3b 0d 0a 0d 0a 20 20 2f 2a 20 5a 65 72 6f 69
00005290: 7a 65 20 73 65 6e 73 69 74 69 76 65 20 69 6e 66
000052a0: 6f 72 6d 61 74 69 6f 6e 2e 0d 0a 20 20 20 2a 2f
000052b0: 0d 0a 20 20 4d 44 34 5f 6d 65 6d 73 65 74 20 28
000052c0: 28 50 4f 49 4e 54 45 52 29 63 6f 6e 74 65 78 74
000052d0: 2c 20 30 2c 20 73 69 7a 65 6f 66 20 28 2a 63 6f
000052e0: 6e 74 65 78 74 29 29 3b 0d 0a 0d 0a 0d 0a 0d 0a
000052f0: 52 69 76 65 73 74 20 20 20 20 20 20 20 20 20 20
00005300: 20 20 20 20 20 20 20 20 20 20 20 20 20 20 20 20
00005310: 20 20 20 20 20 20 20 20 20 20 20 20 20 20 20 20
00005320: 20 20 20 20 20 20 20 20 20 20 20 20 20 20 20 5b
00005330: 50 61 67 65 20 31 31 5d 0d 0a 0c 0d 0a 52 46 43
00005340: 20 31 33 32 30 20 20 20 20 20 20 20 20 20 20 20
00005350: 20 20 20 4d 44 34 20 4d 65 73 73 61 67 65 2d 44
00005360: 69 67 65 73 74 20 41 6c 67 6f 72 69 74 68 6d 20
00005370: 20 20 20 20 20 20 20 20 20 20 20 41 70 72 69 6c
00005380: 20 31 39 39 32 0d 0a 0d 0a 0d 0a 7d 0d 0a 0d 0a
00005390: 2f 2a 20 4d 44 34 20 62 61 73 69 63 20 74 72 61
000053a0: 6e 73 66 6f 72 6d 61 74 69 6f 6e 2e 20 54 72 61
000053b0: 6e 73 66 6f 72 6d 73 20 73 74 61 74 65 20 62 61
000053c0: 73 65 64 20 6f 6e 20 62 6c 6f 63 6b 2e 0d 0a 20
000053d0: 2a 2f 0d 0a 73 74 61 74 69 63 20 76 6f 69 64 20
000053e0: 4d 44 34 54 72 61 6e 73 66 6f 72 6d 20 28 73 74
000053f0: 61 74 65 2c 20 62 6c 6f 63 6b 29 0d 0a 55 49 4e
00005400: 54 34 20 73 74 61 74 65 5b 34 5d 3b 0d 0a 75 6e
00005410: 73 69 67 6e 65 64 20 63 68 61 72 20 62 6c 6f 63
00005420: 6b 5b 36 34 5d 3b 0d 0a 7b 0d 0a 20 20 55 49 4e
00005430: 54 34 20 61 20 3d 20 73 74 61 74 65 5b 30 5d 2c
00005440: 20 62 20 3d 20 73 74 61 74 65 5b 31 5d 2c 20 63
00005450: 20 3d 20 73 74 61 74 65 5b 32 5d 2c 20 64 20 3d
00005460: 20 73 74 61 74 65 5b 33 5d 2c 20 78 5b 31 36 5d
00005470: 3b 0d 0a 0d 0a 20 20 44 65 63 6f 64 65 20 28 78
00005480: 2c 20 62 6c 6f 63 6b 2c 20 36 34 29 3b 0d 0a 0d
00005490: 0a 20 20 2f 2a 20 52 6f 75 6e 64 20 31 20 2a 2f
000054a0: 0d 0a 20 20 46 46 20 28 61 2c 20 62 2c 20 63 2c
000054b0: 20 64 2c 20 78 5b 20 30 5d 2c 20 53 31 31 29 3b
000054c0: 20 2f 2a 20 31 20 2a 2f 0d 0a 20 20 46 46 20 28
000054d0: 64 2c 20 61 2c 20 62 2c 20 63 2c 20 78 5b 20 31
000054e0: 5d 2c 20 53 31 32 29 3b 20 2f 2a 20 32 20 2a 2f
000054f0: 0d 0a 20 20 46 46 20 28 63 2c 20 64 2c 20 61 2c
00005500: 20 62 2c 20 78 5b 20 32 5d 2c 20 53 31 33 29 3b
00005510: 20 2f 2a 20 33 20 2a 2f 0d 0a 20 20 46 46 20 28

00005520: 62 2c 20 63 2c 20 64 2c 20 61 2c 20 78 5b 20 33
00005530: 5d 2c 20 53 31 34 29 3b 20 2f 2a 20 34 20 2a 2f
00005540: 0d 0a 20 20 46 46 20 28 61 2c 20 62 2c 20 63 2c
00005550: 20 64 2c 20 78 5b 20 34 5d 2c 20 53 31 31 29 3b
00005560: 20 2f 2a 20 35 20 2a 2f 0d 0a 20 20 46 46 20 28
00005570: 64 2c 20 61 2c 20 62 2c 20 63 2c 20 78 5b 20 35
00005580: 5d 2c 20 53 31 32 29 3b 20 2f 2a 20 36 20 2a 2f
00005590: 0d 0a 20 20 46 46 20 28 63 2c 20 64 2c 20 61 2c
000055a0: 20 62 2c 20 78 5b 20 36 5d 2c 20 53 31 33 29 3b
000055b0: 20 2f 2a 20 37 20 2a 2f 0d 0a 20 20 46 46 20 28
000055c0: 62 2c 20 63 2c 20 64 2c 20 61 2c 20 78 5b 20 37
000055d0: 5d 2c 20 53 31 34 29 3b 20 2f 2a 20 38 20 2a 2f
000055e0: 0d 0a 20 20 46 46 20 28 61 2c 20 62 2c 20 63 2c
000055f0: 20 64 2c 20 78 5b 20 38 5d 2c 20 53 31 31 29 3b
00005600: 20 2f 2a 20 39 20 2a 2f 0d 0a 20 20 46 46 20 28
00005610: 64 2c 20 61 2c 20 62 2c 20 63 2c 20 78 5b 20 39
00005620: 5d 2c 20 53 31 32 29 3b 20 2f 2a 20 31 30 20 2a
00005630: 2f 0d 0a 20 20 46 46 20 28 63 2c 20 64 2c 20 61
00005640: 2c 20 62 2c 20 78 5b 31 30 5d 2c 20 53 31 33 29
00005650: 3b 20 2f 2a 20 31 31 20 2a 2f 0d 0a 20 20 46 46
00005660: 20 28 62 2c 20 63 2c 20 64 2c 20 61 2c 20 78 5b
00005670: 31 31 5d 2c 20 53 31 34 29 3b 20 2f 2a 20 31 32
00005680: 20 2a 2f 0d 0a 20 20 46 46 20 28 61 2c 20 62 2c
00005690: 20 63 2c 20 64 2c 20 78 5b 31 32 5d 2c 20 53 31
000056a0: 31 29 3b 20 2f 2a 20 31 33 20 2a 2f 0d 0a 20 20
000056b0: 46 46 20 28 64 2c 20 61 2c 20 62 2c 20 63 2c 20
000056c0: 78 5b 31 33 5d 2c 20 53 31 32 29 3b 20 2f 2a 20
000056d0: 31 34 20 2a 2f 0d 0a 20 20 46 46 20 28 63 2c 20
000056e0: 64 2c 20 61 2c 20 62 2c 20 78 5b 31 34 5d 2c 20
000056f0: 53 31 33 29 3b 20 2f 2a 20 31 35 20 2a 2f 0d 0a
00005700: 20 20 46 46 20 28 62 2c 20 63 2c 20 64 2c 20 61
00005710: 2c 20 78 5b 31 35 5d 2c 20 53 31 34 29 3b 20 2f
00005720: 2a 20 31 36 20 2a 2f 0d 0a 0d 0a 20 20 2f 2a 20
00005730: 52 6f 75 6e 64 20 32 20 2a 2f 0d 0a 20 20 47 47
00005740: 20 28 61 2c 20 62 2c 20 63 2c 20 64 2c 20 78 5b
00005750: 20 30 5d 2c 20 53 32 31 29 3b 20 2f 2a 20 31 37
00005760: 20 2a 2f 0d 0a 20 20 47 47 20 28 64 2c 20 61 2c
00005770: 20 62 2c 20 63 2c 20 78 5b 20 34 5d 2c 20 53 32
00005780: 32 29 3b 20 2f 2a 20 31 38 20 2a 2f 0d 0a 20 20
00005790: 47 47 20 28 63 2c 20 64 2c 20 61 2c 20 62 2c 20
000057a0: 78 5b 20 38 5d 2c 20 53 32 33 29 3b 20 2f 2a 20
000057b0: 31 39 20 2a 2f 0d 0a 20 20 47 47 20 28 62 2c 20
000057c0: 63 2c 20 64 2c 20 61 2c 20 78 5b 31 32 5d 2c 20
000057d0: 53 32 34 29 3b 20 2f 2a 20 32 30 20 2a 2f 0d 0a
000057e0: 20 20 47 47 20 28 61 2c 20 62 2c 20 63 2c 20 64
000057f0: 2c 20 78 5b 20 31 5d 2c 20 53 32 31 29 3b 20 2f
00005800: 2a 20 32 31 20 2a 2f 0d 0a 20 20 47 47 20 28 64
00005810: 2c 20 61 2c 20 62 2c 20 63 2c 20 78 5b 20 35 5d
00005820: 2c 20 53 32 32 29 3b 20 2f 2a 20 32 32 20 2a 2f
00005830: 0d 0a 20 20 47 47 20 28 63 2c 20 64 2c 20 61 2c
00005840: 20 62 2c 20 78 5b 20 39 5d 2c 20 53 32 33 29 3b
00005850: 20 2f 2a 20 32 33 20 2a 2f 0d 0a 20 20 47 47 20
00005860: 28 62 2c 20 63 2c 20 64 2c 20 61 2c 20 78 5b 31
00005870: 33 5d 2c 20 53 32 34 29 3b 20 2f 2a 20 32 34 20
00005880: 2a 2f 0d 0a 20 20 47 47 20 28 61 2c 20 62 2c 20
00005890: 63 2c 20 64 2c 20 78 5b 20 32 5d 2c 20 53 32 31
000058a0: 29 3b 20 2f 2a 20 32 35 20 2a 2f 0d 0a 20 20 47
000058b0: 47 20 28 64 2c 20 61 2c 20 62 2c 20 63 2c 20 78
000058c0: 5b 20 36 5d 2c 20 53 32 32 29 3b 20 2f 2a 20 32

000058d0: 36 20 2a 2f 0d 0a 20 20 47 47 20 28 63 2c 20 64
000058e0: 2c 20 61 2c 20 62 2c 20 78 5b 31 30 5d 2c 20 53
000058f0: 32 33 29 3b 20 2f 2a 20 32 37 20 2a 2f 0d 0a 20
00005900: 20 47 47 20 28 62 2c 20 63 2c 20 64 2c 20 61 2c
00005910: 20 78 5b 31 34 5d 2c 20 53 32 34 29 3b 20 2f 2a
00005920: 20 32 38 20 2a 2f 0d 0a 20 20 47 47 20 28 61 2c
00005930: 20 62 2c 20 63 2c 20 64 2c 20 78 5b 20 33 5d 2c
00005940: 20 53 32 31 29 3b 20 2f 2a 20 32 39 20 2a 2f 0d
00005950: 0a 20 20 47 47 20 28 64 2c 20 61 2c 20 62 2c 20
00005960: 63 2c 20 78 5b 20 37 5d 2c 20 53 32 32 29 3b 20
00005970: 2f 2a 20 33 30 20 2a 2f 0d 0a 20 20 47 47 20 28
00005980: 63 2c 20 64 2c 20 61 2c 20 62 2c 20 78 5b 31 31
00005990: 5d 2c 20 53 32 33 29 3b 20 2f 2a 20 33 31 20 2a
000059a0: 2f 0d 0a 20 20 47 47 20 28 62 2c 20 63 2c 20 64
000059b0: 2c 20 61 2c 20 78 5b 31 35 5d 2c 20 53 32 34 29
000059c0: 3b 20 2f 2a 20 33 32 20 2a 2f 0d 0a 0d 0a 0d 0a
000059d0: 0d 0a 0d 0a 52 69 76 65 73 74 20 20 20 20 20 20
000059e0: 20 20 20 20 20 20 20 20 20 20 20 20 20 20 20 20
000059f0: 20 20 20 20 20 20 20 20 20 20 20 20 20 20 20 20
00005a00: 20 20 20 20 20 20 20 20 20 20 20 20 20 20 20 20
00005a10: 20 20 20 5b 50 61 67 65 20 31 32 5d 0d 0a 0c 0d
00005a20: 0a 52 46 43 20 31 33 32 30 20 20 20 20 20 20 20
00005a30: 20 20 20 20 20 20 20 4d 44 34 20 4d 65 73 73 61
00005a40: 67 65 2d 44 69 67 65 73 74 20 41 6c 67 6f 72 69
00005a50: 74 68 6d 20 20 20 20 20 20 20 20 20 20 20 20 41
00005a60: 70 72 69 6c 20 31 39 39 32 0d 0a 0d 0a 0d 0a 20
00005a70: 20 2f 2a 20 52 6f 75 6e 64 20 33 20 2a 2f 0d 0a
00005a80: 20 20 48 48 20 28 61 2c 20 62 2c 20 63 2c 20 64
00005a90: 2c 20 78 5b 20 30 5d 2c 20 53 33 31 29 3b 20 2f
00005aa0: 2a 20 33 33 20 2a 2f 0d 0a 20 20 48 48 20 28 64
00005ab0: 2c 20 61 2c 20 62 2c 20 63 2c 20 78 5b 20 38 5d
00005ac0: 2c 20 53 33 32 29 3b 20 2f 2a 20 33 34 20 2a 2f
00005ad0: 0d 0a 20 20 48 48 20 28 63 2c 20 64 2c 20 61 2c
00005ae0: 20 62 2c 20 78 5b 20 34 5d 2c 20 53 33 33 29 3b
00005af0: 20 2f 2a 20 33 35 20 2a 2f 0d 0a 20 20 48 48 20
00005b00: 28 62 2c 20 63 2c 20 64 2c 20 61 2c 20 78 5b 31
00005b10: 32 5d 2c 20 53 33 34 29 3b 20 2f 2a 20 33 36 20
00005b20: 2a 2f 0d 0a 20 20 48 48 20 28 61 2c 20 62 2c 20
00005b30: 63 2c 20 64 2c 20 78 5b 20 32 5d 2c 20 53 33 31
00005b40: 29 3b 20 2f 2a 20 33 37 20 2a 2f 0d 0a 20 20 48
00005b50: 48 20 28 64 2c 20 61 2c 20 62 2c 20 63 2c 20 78
00005b60: 5b 31 30 5d 2c 20 53 33 32 29 3b 20 2f 2a 20 33
00005b70: 38 20 2a 2f 0d 0a 20 20 48 48 20 28 63 2c 20 64
00005b80: 2c 20 61 2c 20 62 2c 20 78 5b 20 36 5d 2c 20 53
00005b90: 33 33 29 3b 20 2f 2a 20 33 39 20 2a 2f 0d 0a 20
00005ba0: 20 48 48 20 28 62 2c 20 63 2c 20 64 2c 20 61 2c
00005bb0: 20 78 5b 31 34 5d 2c 20 53 33 34 29 3b 20 2f 2a
00005bc0: 20 34 30 20 2a 2f 0d 0a 20 20 48 48 20 28 61 2c
00005bd0: 20 62 2c 20 63 2c 20 64 2c 20 78 5b 20 31 5d 2c
00005be0: 20 53 33 31 29 3b 20 2f 2a 20 34 31 20 2a 2f 0d
00005bf0: 0a 20 20 48 48 20 28 64 2c 20 61 2c 20 62 2c 20
00005c00: 63 2c 20 78 5b 20 39 5d 2c 20 53 33 32 29 3b 20
00005c10: 2f 2a 20 34 32 20 2a 2f 0d 0a 20 20 48 48 20 28
00005c20: 63 2c 20 64 2c 20 61 2c 20 62 2c 20 78 5b 20 35
00005c30: 5d 2c 20 53 33 33 29 3b 20 2f 2a 20 34 33 20 2a
00005c40: 2f 0d 0a 20 20 48 48 20 28 62 2c 20 63 2c 20 64
00005c50: 2c 20 61 2c 20 78 5b 31 33 5d 2c 20 53 33 34 29
00005c60: 3b 20 2f 2a 20 34 34 20 2a 2f 0d 0a 20 20 48 48
00005c70: 20 28 61 2c 20 62 2c 20 63 2c 20 64 2c 20 78 5b

00005c80: 20 33 5d 2c 20 53 33 31 29 3b 20 2f 2a 20 34 35
00005c90: 20 2a 2f 0d 0a 20 20 48 48 20 28 64 2c 20 61 2c
00005ca0: 20 62 2c 20 63 2c 20 78 5b 31 31 5d 2c 20 53 33
00005cb0: 32 29 3b 20 2f 2a 20 34 36 20 2a 2f 0d 0a 20 20
00005cc0: 48 48 20 28 63 2c 20 64 2c 20 61 2c 20 62 2c 20
00005cd0: 78 5b 20 37 5d 2c 20 53 33 33 29 3b 20 2f 2a 20
00005ce0: 34 37 20 2a 2f 0d 0a 20 20 48 48 20 28 62 2c 20
00005cf0: 63 2c 20 64 2c 20 61 2c 20 78 5b 31 35 5d 2c 20
00005d00: 53 33 34 29 3b 20 2f 2a 20 34 38 20 2a 2f 0d 0a
00005d10: 0d 0a 20 20 73 74 61 74 65 5b 30 5d 20 2b 3d 20
00005d20: 61 3b 0d 0a 20 20 73 74 61 74 65 5b 31 5d 20 2b
00005d30: 3d 20 62 3b 0d 0a 20 20 73 74 61 74 65 5b 32 5d
00005d40: 20 2b 3d 20 63 3b 0d 0a 20 20 73 74 61 74 65 5b
00005d50: 33 5d 20 2b 3d 20 64 3b 0d 0a 0d 0a 20 20 2f 2a
00005d60: 20 5a 65 72 6f 69 7a 65 20 73 65 6e 73 69 74 69
00005d70: 76 65 20 69 6e 66 6f 72 6d 61 74 69 6f 6e 2e 0d
00005d80: 0a 20 20 20 2a 2f 0d 0a 20 20 4d 44 34 5f 6d 65
00005d90: 6d 73 65 74 20 28 28 50 4f 49 4e 54 45 52 29 78
00005da0: 2c 20 30 2c 20 73 69 7a 65 6f 66 20 28 78 29 29
00005db0: 3b 0d 0a 7d 0d 0a 0d 0a 2f 2a 20 45 6e 63 6f 64
00005dc0: 65 73 20 69 6e 70 75 74 20 28 55 49 4e 54 34 29
00005dd0: 20 69 6e 74 6f 20 6f 75 74 70 75 74 20 28 75 6e
00005de0: 73 69 67 6e 65 64 20 63 68 61 72 29 2e 20 41 73
00005df0: 73 75 6d 65 73 20 6c 65 6e 20 69 73 0d 0a 20 20
00005e00: 20 20 20 61 20 6d 75 6c 74 69 70 6c 65 20 6f 66
00005e10: 20 34 2e 0d 0a 20 2a 2f 0d 0a 73 74 61 74 69 63
00005e20: 20 76 6f 69 64 20 45 6e 63 6f 64 65 20 28 6f 75
00005e30: 74 70 75 74 2c 20 69 6e 70 75 74 2c 20 6c 65 6e
00005e40: 29 0d 0a 75 6e 73 69 67 6e 65 64 20 63 68 61 72
00005e50: 20 2a 6f 75 74 70 75 74 3b 0d 0a 55 49 4e 54 34
00005e60: 20 2a 69 6e 70 75 74 3b 0d 0a 75 6e 73 69 67 6e
00005e70: 65 64 20 69 6e 74 20 6c 65 6e 3b 0d 0a 7b 0d 0a
00005e80: 20 20 75 6e 73 69 67 6e 65 64 20 69 6e 74 20 69
00005e90: 2c 20 6a 3b 0d 0a 0d 0a 20 20 66 6f 72 20 28 69
00005ea0: 20 3d 20 30 2c 20 6a 20 3d 20 30 3b 20 6a 20 3c
00005eb0: 20 6c 65 6e 3b 20 69 2b 2b 2c 20 6a 20 2b 3d 20
00005ec0: 34 29 20 7b 0d 0a 20 20 20 20 6f 75 74 70 75 74
00005ed0: 5b 6a 5d 20 3d 20 28 75 6e 73 69 67 6e 65 64 20
00005ee0: 63 68 61 72 29 28 69 6e 70 75 74 5b 69 5d 20 26
00005ef0: 20 30 78 66 66 29 3b 0d 0a 20 20 20 20 6f 75 74
00005f00: 70 75 74 5b 6a 2b 31 5d 20 3d 20 28 75 6e 73 69
00005f10: 67 6e 65 64 20 63 68 61 72 29 28 28 69 6e 70 75
00005f20: 74 5b 69 5d 20 3e 3e 20 38 29 20 26 20 30 78 66
00005f30: 66 29 3b 0d 0a 20 20 20 20 6f 75 74 70 75 74 5b
00005f40: 6a 2b 32 5d 20 3d 20 28 75 6e 73 69 67 6e 65 64
00005f50: 20 63 68 61 72 29 28 28 69 6e 70 75 74 5b 69 5d
00005f60: 20 3e 3e 20 31 36 29 20 26 20 30 78 66 66 29 3b
00005f70: 0d 0a 20 20 20 20 6f 75 74 70 75 74 5b 6a 2b 33
00005f80: 5d 20 3d 20 28 75 6e 73 69 67 6e 65 64 20 63 68
00005f90: 61 72 29 28 28 69 6e 70 75 74 5b 69 5d 20 3e 3e
00005fa0: 20 32 34 29 20 26 20 30 78 66 66 29 3b 0d 0a 20
00005fb0: 20 7d 0d 0a 7d 0d 0a 0d 0a 2f 2a 20 44 65 63 6f
00005fc0: 64 65 73 20 69 6e 70 75 74 20 28 75 6e 73 69 67
00005fd0: 6e 65 64 20 63 68 61 72 29 20 69 6e 74 6f 20 6f
00005fe0: 75 74 70 75 74 20 28 55 49 4e 54 34 29 2e 20 41
00005ff0: 73 73 75 6d 65 73 20 6c 65 6e 20 69 73 0d 0a 20

00006000: 20 20 20 20 61 20 6d 75 6c 74 69 70 6c 65 20 6f

00006010: 66 20 34 2e 0d 0a 0d 0a 0d 0a 0d 0a 52 69 76 65
00006020: 73 74 20 20 20 20 20 20 20 20 20 20 20 20 20 20
00006030: 20 20 20 20 20 20 20 20 20 20 20 20 20 20 20 20
00006040: 20 20 20 20 20 20 20 20 20 20 20 20 20 20 20 20
00006050: 20 20 20 20 20 20 20 20 20 20 20 20 5b 50 61 67 65
00006060: 20 31 33 5d 0d 0a 0c 0d 0a 52 46 43 20 31 33 32
00006070: 30 20 20 20 20 20 20 20 20 20 20 20 20 20 20 4d
00006080: 44 34 20 4d 65 73 73 61 67 65 2d 44 69 67 65 73
00006090: 74 20 41 6c 67 6f 72 69 74 68 6d 20 20 20 20 20
000060a0: 20 20 20 20 20 20 20 20 41 70 72 69 6c 20 31 39 39
000060b0: 32 0d 0a 0d 0a 0d 0a 20 2a 2f 0d 0a 73 74 61 74
000060c0: 69 63 20 76 6f 69 64 20 44 65 63 6f 64 65 20 28
000060d0: 6f 75 74 70 75 74 2c 20 69 6e 70 75 74 2c 20 6c
000060e0: 65 6e 29 0d 0a 0d 0a 55 49 4e 54 34 20 2a 6f 75
000060f0: 74 70 75 74 3b 0d 0a 75 6e 73 69 67 6e 65 64 20
00006100: 63 68 61 72 20 2a 69 6e 70 75 74 3b 0d 0a 75 6e
00006110: 73 69 67 6e 65 64 20 69 6e 74 20 6c 65 6e 3b 0d
00006120: 0a 7b 0d 0a 20 20 75 6e 73 69 67 6e 65 64 20 69
00006130: 6e 74 20 69 2c 20 6a 3b 0d 0a 0d 0a 20 20 66 6f
00006140: 72 20 28 69 20 3d 20 30 2c 20 6a 20 3d 20 30 3b
00006150: 20 6a 20 3c 20 6c 65 6e 3b 20 69 2b 2b 2c 20 6a
00006160: 20 2b 3d 20 34 29 0d 0a 20 20 20 20 6f 75 74 70
00006170: 75 74 5b 69 5d 20 3d 20 28 28 55 49 4e 54 34 29
00006180: 69 6e 70 75 74 5b 6a 5d 29 20 7c 20 28 28 28 55
00006190: 49 4e 54 34 29 69 6e 70 75 74 5b 6a 2b 31 5d 29
000061a0: 20 3c 3c 20 38 29 20 7c 0d 0a 20 20 20 20 20 20
000061b0: 28 28 28 55 49 4e 54 34 29 69 6e 70 75 74 5b 6a
000061c0: 2b 32 5d 29 20 3c 3c 20 31 36 29 20 7c 20 28 28
000061d0: 28 55 49 4e 54 34 29 69 6e 70 75 74 5b 6a 2b 33
000061e0: 5d 29 20 3c 3c 20 32 34 29 3b 0d 0a 7d 0d 0a 0d
000061f0: 0a 2f 2a 20 4e 6f 74 65 3a 20 52 65 70 6c 61 63
00006200: 65 20 22 66 6f 72 20 6c 6f 6f 70 22 20 77 69 74
00006210: 68 20 73 74 61 6e 64 61 72 64 20 6d 65 6d 63 70
00006220: 79 20 69 66 20 70 6f 73 73 69 62 6c 65 2e 0d 0a
00006230: 20 2a 2f 0d 0a 73 74 61 74 69 63 20 76 6f 69 64
00006240: 20 4d 44 34 5f 6d 65 6d 63 70 79 20 28 6f 75 74
00006250: 70 75 74 2c 20 69 6e 70 75 74 2c 20 6c 65 6e 29
00006260: 0d 0a 50 4f 49 4e 54 45 52 20 6f 75 74 70 75 74
00006270: 3b 0d 0a 50 4f 49 4e 54 45 52 20 69 6e 70 75 74
00006280: 3b 0d 0a 75 6e 73 69 67 6e 65 64 20 69 6e 74 20
00006290: 6c 65 6e 3b 0d 0a 7b 0d 0a 20 20 75 6e 73 69 67
000062a0: 6e 65 64 20 69 6e 74 20 69 3b 0d 0a 0d 0a 20 20
000062b0: 66 6f 72 20 28 69 20 3d 20 30 3b 20 69 20 3c 20
000062c0: 6c 65 6e 3b 20 69 2b 2b 29 0d 0a 20 20 20 20 6f
000062d0: 75 74 70 75 74 5b 69 5d 20 3d 20 69 6e 70 75 74
000062e0: 5b 69 5d 3b 0d 0a 7d 0d 0a 0d 0a 2f 2a 20 4e 6f
000062f0: 74 65 3a 20 52 65 70 6c 61 63 65 20 22 66 6f 72
00006300: 20 6c 6f 6f 70 22 20 77 69 74 68 20 73 74 61 6e
00006310: 64 61 72 64 20 6d 65 6d 73 65 74 20 69 66 20 70
00006320: 6f 73 73 69 62 6c 65 2e 0d 0a 20 2a 2f 0d 0a 73
00006330: 74 61 74 69 63 20 76 6f 69 64 20 4d 44 34 5f 6d
00006340: 65 6d 73 65 74 20 28 6f 75 74 70 75 74 2c 20 76
00006350: 61 6c 75 65 2c 20 6c 65 6e 29 0d 0a 50 4f 49 4e
00006360: 54 45 52 20 6f 75 74 70 75 74 3b 0d 0a 69 6e 74
00006370: 20 76 61 6c 75 65 3b 0d 0a 75 6e 73 69 67 6e 65
00006380: 64 20 69 6e 74 20 6c 65 6e 3b 0d 0a 7b 0d 0a 20
00006390: 20 75 6e 73 69 67 6e 65 64 20 69 6e 74 20 69 3b
000063a0: 0d 0a 0d 0a 20 20 66 6f 72 20 28 69 20 3d 20 30
000063b0: 3b 20 69 20 3c 20 6c 65 6e 3b 20 69 2b 2b 29 0d

000063c0: 0a 20 20 20 20 28 28 63 68 61 72 20 2a 29 6f 75
000063d0: 74 70 75 74 29 5b 69 5d 20 3d 20 28 63 68 61 72
000063e0: 29 76 61 6c 75 65 3b 0d 0a 7d 0d 0a 0d 0a 41 2e
000063f0: 34 20 6d 64 64 72 69 76 65 72 2e 63 0d 0a 0d 0a
00006400: 2f 2a 20 4d 44 44 52 49 56 45 52 2e 43 20 2d 20
00006410: 74 65 73 74 20 64 72 69 76 65 72 20 66 6f 72 20
00006420: 4d 44 32 2c 20 4d 44 34 20 61 6e 64 20 4d 44 35
00006430: 0d 0a 20 2a 2f 0d 0a 0d 0a 2f 2a 20 43 6f 70 79
00006440: 72 69 67 68 74 20 28 43 29 20 31 39 39 30 2d 32
00006450: 2c 20 52 53 41 20 44 61 74 61 20 53 65 63 75 72
00006460: 69 74 79 2c 20 49 6e 63 2e 20 43 72 65 61 74 65
00006470: 64 20 31 39 39 30 2e 20 41 6c 6c 0d 0a 20 20 20
00006480: 72 69 67 68 74 73 20 72 65 73 65 72 76 65 64 2e
00006490: 0d 0a 0d 0a 0d 0a 0d 0a 0d 0a 52 69 76 65 73 74
000064a0: 20 20 20 20 20 20 20 20 20 20 20 20 20 20 20 20
000064b0: 20 20 20 20 20 20 20 20 20 20 20 20 20 20 20 20
000064c0: 20 20 20 20 20 20 20 20 20 20 20 20 20 20 20 20
000064d0: 20 20 20 20 20 20 20 20 20 5b 50 61 67 65 20 31
000064e0: 34 5d 0d 0a 0c 0d 0a 52 46 43 20 31 33 32 30 20
000064f0: 20 20 20 20 20 20 20 20 20 20 20 20 20 4d 44 34
00006500: 20 4d 65 73 73 61 67 65 2d 44 69 67 65 73 74 20
00006510: 41 6c 67 6f 72 69 74 68 6d 20 20 20 20 20 20 20
00006520: 20 20 20 20 20 41 70 72 69 6c 20 31 39 39 32 0d
00006530: 0a 0d 0a 0d 0a 20 20 20 52 53 41 20 44 61 74 61
00006540: 20 53 65 63 75 72 69 74 79 2c 20 49 6e 63 2e 20
00006550: 6d 61 6b 65 73 20 6e 6f 20 72 65 70 72 65 73 65
00006560: 6e 74 61 74 69 6f 6e 73 20 63 6f 6e 63 65 72 6e
00006570: 69 6e 67 20 65 69 74 68 65 72 0d 0a 20 20 20 74
00006580: 68 65 20 6d 65 72 63 68 61 6e 74 61 62 69 6c 69
00006590: 74 79 20 6f 66 20 74 68 69 73 20 73 6f 66 74 77
000065a0: 61 72 65 20 6f 72 20 74 68 65 20 73 75 69 74 61
000065b0: 62 69 6c 69 74 79 20 6f 66 20 74 68 69 73 0d 0a
000065c0: 20 20 20 73 6f 66 74 77 61 72 65 20 66 6f 72 20
000065d0: 61 6e 79 20 70 61 72 74 69 63 75 6c 61 72 20 70
000065e0: 75 72 70 6f 73 65 2e 20 49 74 20 69 73 20 70 72
000065f0: 6f 76 69 64 65 64 20 22 61 73 20 69 73 22 0d 0a
00006600: 20 20 20 77 69 74 68 6f 75 74 20 65 78 70 72 65
00006610: 73 73 20 6f 72 20 69 6d 70 6c 69 65 64 20 77 61
00006620: 72 72 61 6e 74 79 20 6f 66 20 61 6e 79 20 6b 69
00006630: 6e 64 2e 0d 0a 0d 0a 20 20 20 54 68 65 73 65 20
00006640: 6e 6f 74 69 63 65 73 20 6d 75 73 74 20 62 65 20
00006650: 72 65 74 61 69 6e 65 64 20 69 6e 20 61 6e 79 20
00006660: 63 6f 70 69 65 73 20 6f 66 20 61 6e 79 20 70 61
00006670: 72 74 20 6f 66 20 74 68 69 73 0d 0a 20 20 20 64
00006680: 6f 63 75 6d 65 6e 74 61 74 69 6f 6e 20 61 6e 64
00006690: 2f 6f 72 20 73 6f 66 74 77 61 72 65 2e 0d 0a 0d
000066a0: 0a 20 2a 2f 0d 0a 0d 0a 2f 2a 20 54 68 65 20 66
000066b0: 6f 6c 6c 6f 77 69 6e 67 20 6d 61 6b 65 73 20 4d
000066c0: 44 20 64 65 66 61 75 6c 74 20 74 6f 20 4d 44 35
000066d0: 20 69 66 20 69 74 20 68 61 73 20 6e 6f 74 20 61
000066e0: 6c 72 65 61 64 79 20 62 65 65 6e 0d 0a 20 20 20
000066f0: 20 20 64 65 66 69 6e 65 64 20 77 69 74 68 20 43
00006700: 20 63 6f 6d 70 69 6c 65 72 20 66 6c 61 67 73 2e
00006710: 0d 0a 20 2a 2f 0d 0a 23 69 66 6e 64 65 66 20 4d
00006720: 44 0d 0a 23 64 65 66 69 6e 65 20 4d 44 20 4d 44
00006730: 35 0d 0a 23 65 6e 64 69 66 0d 0a 0d 0a 23 69 6e
00006740: 63 6c 75 64 65 20 3c 73 74 64 69 6f 2e 68 3e 0d
00006750: 0a 23 69 6e 63 6c 75 64 65 20 3c 74 69 6d 65 2e
00006760: 68 3e 0d 0a 23 69 6e 63 6c 75 64 65 20 3c 73 74

00006770: 72 69 6e 67 2e 68 3e 0d 0a 23 69 6e 63 6c 75 64
00006780: 65 20 22 67 6c 6f 62 61 6c 2e 68 22 0d 0a 23 69
00006790: 66 20 4d 44 20 3d 3d 20 32 0d 0a 23 69 6e 63 6c
000067a0: 75 64 65 20 22 6d 64 32 2e 68 22 0d 0a 23 65 6e
000067b0: 64 69 66 0d 0a 23 69 66 20 4d 44 20 3d 3d 20 34
000067c0: 0d 0a 23 69 6e 63 6c 75 64 65 20 22 6d 64 34 2e
000067d0: 68 22 0d 0a 23 65 6e 64 69 66 0d 0a 23 69 66 20
000067e0: 4d 44 20 3d 3d 20 35 0d 0a 23 69 6e 63 6c 75 64
000067f0: 65 20 22 6d 64 35 2e 68 22 0d 0a 23 65 6e 64 69
00006800: 66 0d 0a 0d 0a 2f 2a 20 4c 65 6e 67 74 68 20 6f
00006810: 66 20 74 65 73 74 20 62 6c 6f 63 6b 2c 20 6e 75
00006820: 6d 62 65 72 20 6f 66 20 74 65 73 74 20 62 6c 6f
00006830: 63 6b 73 2e 0d 0a 20 2a 2f 0d 0a 23 64 65 66 69
00006840: 6e 65 20 54 45 53 54 5f 42 4c 4f 43 4b 5f 4c 45
00006850: 4e 20 31 30 30 30 0d 0a 23 64 65 66 69 6e 65 20
00006860: 54 45 53 54 5f 42 4c 4f 43 4b 5f 43 4f 55 4e 54
00006870: 20 31 30 30 30 0d 0a 0d 0a 73 74 61 74 69 63 20
00006880: 76 6f 69 64 20 4d 44 53 74 72 69 6e 67 20 50 52
00006890: 4f 54 4f 5f 4c 49 53 54 20 28 28 63 68 61 72 20
000068a0: 2a 29 29 3b 0d 0a 73 74 61 74 69 63 20 76 6f 69
000068b0: 64 20 4d 44 54 69 6d 65 54 72 69 61 6c 20 50 52
000068c0: 4f 54 4f 5f 4c 49 53 54 20 28 28 76 6f 69 64 29
000068d0: 29 3b 0d 0a 73 74 61 74 69 63 20 76 6f 69 64 20
000068e0: 4d 44 54 65 73 74 53 75 69 74 65 20 50 52 4f 54
000068f0: 4f 5f 4c 49 53 54 20 28 28 76 6f 69 64 29 29 3b
00006900: 0d 0a 73 74 61 74 69 63 20 76 6f 69 64 20 4d 44
00006910: 46 69 6c 65 20 50 52 4f 54 4f 5f 4c 49 53 54 20
00006920: 28 28 63 68 61 72 20 2a 29 29 3b 0d 0a 73 74 61
00006930: 74 69 63 20 76 6f 69 64 20 4d 44 46 69 6c 74 65
00006940: 72 20 50 52 4f 54 4f 5f 4c 49 53 54 20 28 28 76
00006950: 6f 69 64 29 29 3b 0d 0a 73 74 61 74 69 63 20 76
00006960: 6f 69 64 20 4d 44 50 72 69 6e 74 20 50 52 4f 54
00006970: 4f 5f 4c 49 53 54 20 28 28 75 6e 73 69 67 6e 65
00006980: 64 20 63 68 61 72 20 5b 31 36 5d 29 29 3b 0d 0a
00006990: 0d 0a 23 69 66 20 4d 44 20 3d 3d 20 32 0d 0a 23
000069a0: 64 65 66 69 6e 65 20 4d 44 5f 43 54 58 20 4d 44
000069b0: 32 5f 43 54 58 0d 0a 23 64 65 66 69 6e 65 20 4d
000069c0: 44 49 6e 69 74 20 4d 44 32 49 6e 69 74 0d 0a 23
000069d0: 64 65 66 69 6e 65 20 4d 44 55 70 64 61 74 65 20
000069e0: 4d 44 32 55 70 64 61 74 65 0d 0a 23 64 65 66 69
000069f0: 6e 65 20 4d 44 46 69 6e 61 6c 20 4d 44 32 46 69
00006a00: 6e 61 6c 0d 0a 0d 0a 0d 0a 0d 0a 52 69 76 65 73
00006a10: 74 20 20 20 20 20 20 20 20 20 20 20 20 20 20 20
00006a20: 20 20 20 20 20 20 20 20 20 20 20 20 20 20 20 20
00006a30: 20 20 20 20 20 20 20 20 20 20 20 20 20 20 20 20
00006a40: 20 20 20 20 20 20 20 20 20 20 20 5b 50 61 67 65 20
00006a50: 31 35 5d 0d 0a 0c 0d 0a 52 46 43 20 31 33 32 30
00006a60: 20 20 20 20 20 20 20 20 20 20 20 20 20 20 4d 44
00006a70: 34 20 4d 65 73 73 61 67 65 2d 44 69 67 65 73 74
00006a80: 20 41 6c 67 6f 72 69 74 68 6d 20 20 20 20 20 20
00006a90: 20 20 20 20 20 20 41 70 72 69 6c 20 31 39 39 32
00006aa0: 0d 0a 0d 0a 0d 0a 23 65 6e 64 69 66 0d 0a 23 69
00006ab0: 66 20 4d 44 20 3d 3d 20 34 0d 0a 23 64 65 66 69
00006ac0: 6e 65 20 4d 44 5f 43 54 58 20 4d 44 34 5f 43 54
00006ad0: 58 0d 0a 23 64 65 66 69 6e 65 20 4d 44 49 6e 69
00006ae0: 74 20 4d 44 34 49 6e 69 74 0d 0a 23 64 65 66 69
00006af0: 6e 65 20 4d 44 55 70 64 61 74 65 20 4d 44 34 55
00006b00: 70 64 61 74 65 0d 0a 23 64 65 66 69 6e 65 20 4d
00006b10: 44 46 69 6e 61 6c 20 4d 44 34 46 69 6e 61 6c 0d

00006b20: 0a 23 65 6e 64 69 66 0d 0a 23 69 66 20 4d 44 20
00006b30: 3d 3d 20 35 0d 0a 23 64 65 66 69 6e 65 20 4d 44
00006b40: 5f 43 54 58 20 4d 44 35 5f 43 54 58 0d 0a 23 64
00006b50: 65 66 69 6e 65 20 4d 44 49 6e 69 74 20 4d 44 35
00006b60: 49 6e 69 74 0d 0a 23 64 65 66 69 6e 65 20 4d 44
00006b70: 55 70 64 61 74 65 20 4d 44 35 55 70 64 61 74 65
00006b80: 0d 0a 23 64 65 66 69 6e 65 20 4d 44 46 69 6e 61
00006b90: 6c 20 4d 44 35 46 69 6e 61 6c 0d 0a 23 65 6e 64
00006ba0: 69 66 0d 0a 0d 0a 2f 2a 20 4d 61 69 6e 20 64 72
00006bb0: 69 76 65 72 2e 0d 0a 0d 0a 20 20 20 41 72 67 75
00006bc0: 6d 65 6e 74 73 20 28 6d 61 79 20 62 65 20 61 6e
00006bd0: 79 20 63 6f 6d 62 69 6e 61 74 69 6f 6e 29 3a 0d
00006be0: 0a 20 20 20 20 20 2d 73 73 74 72 69 6e 67 20 2d
00006bf0: 20 64 69 67 65 73 74 73 20 73 74 72 69 6e 67 0d
00006c00: 0a 20 20 20 20 20 2d 74 20 20 20 20 20 20 20 2d
00006c10: 20 72 75 6e 73 20 74 69 6d 65 20 74 72 69 61 6c
00006c20: 0d 0a 20 20 20 20 20 2d 78 20 20 20 20 20 20 20
00006c30: 2d 20 72 75 6e 73 20 74 65 73 74 20 73 63 72 69
00006c40: 70 74 0d 0a 20 20 20 20 20 66 69 6c 65 6e 61 6d
00006c50: 65 20 2d 20 64 69 67 65 73 74 73 20 66 69 6c 65
00006c60: 0d 0a 20 20 20 20 20 28 6e 6f 6e 65 29 20 20 20
00006c70: 2d 20 64 69 67 65 73 74 73 20 73 74 61 6e 64 61
00006c80: 72 64 20 69 6e 70 75 74 0d 0a 20 2a 2f 0d 0a 69
00006c90: 6e 74 20 6d 61 69 6e 20 28 61 72 67 63 2c 20 61
00006ca0: 72 67 76 29 0d 0a 69 6e 74 20 61 72 67 63 3b 0d
00006cb0: 0a 63 68 61 72 20 2a 61 72 67 76 5b 5d 3b 0d 0a
00006cc0: 7b 0d 0a 20 20 69 6e 74 20 69 3b 0d 0a 0d 0a 20
00006cd0: 20 69 66 20 28 61 72 67 63 20 3e 20 31 29 0d 0a
00006ce0: 20 20 20 20 66 6f 72 20 28 69 20 3d 20 31 3b 20
00006cf0: 69 20 3c 20 61 72 67 63 3b 20 69 2b 2b 29 0d 0a
00006d00: 20 20 20 20 20 20 69 66 20 28 61 72 67 76 5b 69
00006d10: 5d 5b 30 5d 20 3d 3d 20 27 2d 27 20 26 26 20 61
00006d20: 72 67 76 5b 69 5d 5b 31 5d 20 3d 3d 20 27 73 27
00006d30: 29 0d 0a 20 20 20 20 20 20 20 4d 44 53 74 72
00006d40: 69 6e 67 20 28 61 72 67 76 5b 69 5d 20 2b 20 32
00006d50: 29 3b 0d 0a 20 20 20 20 20 20 65 6c 73 65 20 69
00006d60: 66 20 28 73 74 72 63 6d 70 20 28 61 72 67 76 5b
00006d70: 69 5d 2c 20 22 2d 74 22 29 20 3d 3d 20 30 29 0d
00006d80: 0a 20 20 20 20 20 20 20 20 4d 44 54 69 6d 65 54
00006d90: 72 69 61 6c 20 28 29 3b 0d 0a 20 20 20 20 20 20
00006da0: 65 6c 73 65 20 69 66 20 28 73 74 72 63 6d 70 20
00006db0: 28 61 72 67 76 5b 69 5d 2c 20 22 2d 78 22 29 20
00006dc0: 3d 3d 20 30 29 0d 0a 20 20 20 20 20 20 20 4d
00006dd0: 44 54 65 73 74 53 75 69 74 65 20 28 29 3b 0d 0a
00006de0: 20 20 20 20 20 20 65 6c 73 65 0d 0a 20 20 20 20
00006df0: 20 20 20 20 4d 44 46 69 6c 65 20 28 61 72 67 76
00006e00: 5b 69 5d 29 3b 0d 0a 20 20 65 6c 73 65 0d 0a 20
00006e10: 20 20 20 4d 44 46 69 6c 74 65 72 20 28 29 3b 0d
00006e20: 0a 0d 0a 20 20 72 65 74 75 72 6e 20 28 30 29 3b
00006e30: 0d 0a 7d 0d 0a 0d 0a 2f 2a 20 44 69 67 65 73 74
00006e40: 73 20 61 20 73 74 72 69 6e 67 20 61 6e 64 20 70
00006e50: 72 69 6e 74 73 20 74 68 65 20 72 65 73 75 6c 74
00006e60: 2e 0d 0a 20 2a 2f 0d 0a 73 74 61 74 69 63 20 76
00006e70: 6f 69 64 20 4d 44 53 74 72 69 6e 67 20 28 73 74
00006e80: 72 69 6e 67 29 0d 0a 0d 0a 0d 0a 0d 0a 52 69 76
00006e90: 65 73 74 20 20 20 20 20 20 20 20 20 20 20 20 20
00006ea0: 20 20 20 20 20 20 20 20 20 20 20 20 20 20 20 20
00006eb0: 20 20 20 20 20 20 20 20 20 20 20 20 20 20 20 20
00006ec0: 20 20 20 20 20 20 20 20 20 20 20 20 5b 50 61 67

00006ed0: 65 20 31 36 5d 0d 0a 0c 0d 0a 52 46 43 20 31 33
00006ee0: 32 30 20 20 20 20 20 20 20 20 20 20 20 20 20 20
00006ef0: 4d 44 34 20 4d 65 73 73 61 67 65 2d 44 69 67 65
00006f00: 73 74 20 41 6c 67 6f 72 69 74 68 6d 20 20 20 20
00006f10: 20 20 20 20 20 20 20 20 41 70 72 69 6c 20 31 39
00006f20: 39 32 0d 0a 0d 0a 0d 0a 63 68 61 72 20 2a 73 74
00006f30: 72 69 6e 67 3b 0d 0a 7b 0d 0a 20 20 4d 44 5f 43
00006f40: 54 58 20 63 6f 6e 74 65 78 74 3b 0d 0a 20 20 75
00006f50: 6e 73 69 67 6e 65 64 20 63 68 61 72 20 64 69 67
00006f60: 65 73 74 5b 31 36 5d 3b 0d 0a 20 20 75 6e 73 69
00006f70: 67 6e 65 64 20 69 6e 74 20 6c 65 6e 20 3d 20 73
00006f80: 74 72 6c 65 6e 20 28 73 74 72 69 6e 67 29 3b 0d
00006f90: 0a 0d 0a 20 20 4d 44 49 6e 69 74 20 28 26 63 6f
00006fa0: 6e 74 65 78 74 29 3b 0d 0a 20 20 4d 44 55 70 64
00006fb0: 61 74 65 20 28 26 63 6f 6e 74 65 78 74 2c 20 73
00006fc0: 74 72 69 6e 67 2c 20 6c 65 6e 29 3b 0d 0a 20 20
00006fd0: 4d 44 46 69 6e 61 6c 20 28 64 69 67 65 73 74 2c
00006fe0: 20 26 63 6f 6e 74 65 78 74 29 3b 0d 0a 0d 0a 20
00006ff0: 20 70 72 69 6e 74 66 20 28 22 4d 44 25 64 20 28

00007000: 5c 22 25 73 5c 22 29 20 3d 20 22 2c 20 4d 44 2c
00007010: 20 73 74 72 69 6e 67 29 3b 0d 0a 20 20 4d 44 50
00007020: 72 69 6e 74 20 28 64 69 67 65 73 74 29 3b 0d 0a
00007030: 20 20 70 72 69 6e 74 66 20 28 22 5c 6e 22 29 3b
00007040: 0d 0a 7d 0d 0a 0d 0a 2f 2a 20 4d 65 61 73 75 72
00007050: 65 73 20 74 68 65 20 74 69 6d 65 20 74 6f 20 64
00007060: 69 67 65 73 74 20 54 45 53 54 5f 42 4c 4f 43 4b
00007070: 5f 43 4f 55 4e 54 20 54 45 53 54 5f 42 4c 4f 43
00007080: 4b 5f 4c 45 4e 2d 62 79 74 65 0d 0a 20 20 20 20
00007090: 20 62 6c 6f 63 6b 73 2e 0d 0a 20 2a 2f 0d 0a 73
000070a0: 74 61 74 69 63 20 76 6f 69 64 20 4d 44 54 69 6d
000070b0: 65 54 72 69 61 6c 20 28 29 0d 0a 7b 0d 0a 20 20
000070c0: 4d 44 5f 43 54 58 20 63 6f 6e 74 65 78 74 3b 0d
000070d0: 0a 20 20 74 69 6d 65 5f 74 20 65 6e 64 54 69 6d
000070e0: 65 2c 20 73 74 61 72 74 54 69 6d 65 3b 0d 0a 20
000070f0: 20 75 6e 73 69 67 6e 65 64 20 63 68 61 72 20 62
00007100: 6c 6f 63 6b 5b 54 45 53 54 5f 42 4c 4f 43 4b 5f
00007110: 4c 45 4e 5d 2c 20 64 69 67 65 73 74 5b 31 36 5d
00007120: 3b 0d 0a 20 20 75 6e 73 69 67 6e 65 64 20 69 6e
00007130: 74 20 69 3b 0d 0a 0d 0a 20 20 70 72 69 6e 74 66
00007140: 0d 0a 20 20 20 20 28 22 4d 44 25 64 20 74 69 6d
00007150: 65 20 74 72 69 61 6c 2e 20 44 69 67 65 73 74 69
00007160: 6e 67 20 25 64 20 25 64 2d 62 79 74 65 20 62 6c
00007170: 6f 63 6b 73 20 2e 2e 2e 22 2c 20 4d 44 2c 0d 0a
00007180: 20 20 20 20 20 54 45 53 54 5f 42 4c 4f 43 4b 5f
00007190: 4c 45 4e 2c 20 54 45 53 54 5f 42 4c 4f 43 4b 5f
000071a0: 43 4f 55 4e 54 29 3b 0d 0a 0d 0a 20 20 2f 2a 20
000071b0: 49 6e 69 74 69 61 6c 69 7a 65 20 62 6c 6f 63 6b
000071c0: 20 2a 2f 0d 0a 20 20 66 6f 72 20 28 69 20 3d 20
000071d0: 30 3b 20 69 20 3c 20 54 45 53 54 5f 42 4c 4f 43
000071e0: 4b 5f 4c 45 4e 3b 20 69 2b 2b 29 0d 0a 20 20 20
000071f0: 20 62 6c 6f 63 6b 5b 69 5d 20 3d 20 28 75 6e 73
00007200: 69 67 6e 65 64 20 63 68 61 72 29 28 69 20 26 20
00007210: 30 78 66 66 29 3b 0d 0a 0d 0a 20 20 2f 2a 20 53
00007220: 74 61 72 74 20 74 69 6d 65 72 20 2a 2f 0d 0a 20
00007230: 20 74 69 6d 65 20 28 26 73 74 61 72 74 54 69 6d
00007240: 65 29 3b 0d 0a 0d 0a 20 20 2f 2a 20 44 69 67 65
00007250: 73 74 20 62 6c 6f 63 6b 73 20 2a 2f 0d 0a 20 20

00007260: 4d 44 49 6e 69 74 20 28 26 63 6f 6e 74 65 78 74
00007270: 29 3b 0d 0a 20 20 66 6f 72 20 28 69 20 3d 20 30
00007280: 3b 20 69 20 3c 20 54 45 53 54 5f 42 4c 4f 43 4b
00007290: 5f 43 4f 55 4e 54 3b 20 69 2b 2b 29 0d 0a 20 20
000072a0: 20 20 4d 44 55 70 64 61 74 65 20 28 26 63 6f 6e
000072b0: 74 65 78 74 2c 20 62 6c 6f 63 6b 2c 20 54 45 53
000072c0: 54 5f 42 4c 4f 43 4b 5f 4c 45 4e 29 3b 0d 0a 20
000072d0: 20 4d 44 46 69 6e 61 6c 20 28 64 69 67 65 73 74
000072e0: 2c 20 26 63 6f 6e 74 65 78 74 29 3b 0d 0a 0d 0a
000072f0: 20 20 2f 2a 20 53 74 6f 70 20 74 69 6d 65 72 20
00007300: 2a 2f 0d 0a 20 20 74 69 6d 65 20 28 26 65 6e 64
00007310: 54 69 6d 65 29 3b 0d 0a 0d 0a 20 20 70 72 69 6e
00007320: 74 66 20 28 22 20 64 6f 6e 65 5c 6e 22 29 3b 0d
00007330: 0a 20 20 70 72 69 6e 74 66 20 28 22 44 69 67 65
00007340: 73 74 20 3d 20 22 29 3b 0d 0a 20 20 4d 44 50 72
00007350: 69 6e 74 20 28 64 69 67 65 73 74 29 3b 0d 0a 0d
00007360: 0a 0d 0a 0d 0a 52 69 76 65 73 74 20 20 20 20 20
00007370: 20 20 20 20 20 20 20 20 20 20 20 20 20 20 20 20
00007380: 20 20 20 20 20 20 20 20 20 20 20 20 20 20 20 20
00007390: 20 20 20 20 20 20 20 20 20 20 20 20 20 20 20 20
000073a0: 20 20 20 20 5b 50 61 67 65 20 31 37 5d 0d 0a 0c
000073b0: 0d 0a 52 46 43 20 31 33 32 30 20 20 20 20 20 20
000073c0: 20 20 20 20 20 20 20 20 4d 44 34 20 4d 65 73 73
000073d0: 61 67 65 2d 44 69 67 65 73 74 20 41 6c 67 6f 72
000073e0: 69 74 68 6d 20 20 20 20 20 20 20 20 20 20 20 20
000073f0: 41 70 72 69 6c 20 31 39 39 32 0d 0a 0d 0a 0d 0a
00007400: 20 20 70 72 69 6e 74 66 20 28 22 5c 6e 54 69 6d
00007410: 65 20 3d 20 25 6c 64 20 73 65 63 6f 6e 64 73 5c
00007420: 6e 22 2c 20 28 6c 6f 6e 67 29 28 65 6e 64 54 69
00007430: 6d 65 2d 73 74 61 72 74 54 69 6d 65 29 29 3b 0d
00007440: 0a 20 20 70 72 69 6e 74 66 0d 0a 20 20 20 20 28
00007450: 22 53 70 65 65 64 20 3d 20 25 6c 64 20 62 79 74
00007460: 65 73 2f 73 65 63 6f 6e 64 5c 6e 22 2c 0d 0a 20
00007470: 20 20 20 20 28 6c 6f 6e 67 29 54 45 53 54 5f 42
00007480: 4c 4f 43 4b 5f 4c 45 4e 20 2a 20 28 6c 6f 6e 67
00007490: 29 54 45 53 54 5f 42 4c 4f 43 4b 5f 43 4f 55 4e
000074a0: 54 2f 28 65 6e 64 54 69 6d 65 2d 73 74 61 72 74
000074b0: 54 69 6d 65 29 29 3b 0d 0a 7d 0d 0a 0d 0a 2f 2a
000074c0: 20 44 69 67 65 73 74 73 20 61 20 72 65 66 65 72
000074d0: 65 6e 63 65 20 73 75 69 74 65 20 6f 66 20 73 74
000074e0: 72 69 6e 67 73 20 61 6e 64 20 70 72 69 6e 74 73
000074f0: 20 74 68 65 20 72 65 73 75 6c 74 73 2e 0d 0a 20
00007500: 2a 2f 0d 0a 73 74 61 74 69 63 20 76 6f 69 64 20
00007510: 4d 44 54 65 73 74 53 75 69 74 65 20 28 29 0d 0a
00007520: 7b 0d 0a 20 20 70 72 69 6e 74 66 20 28 22 4d 44
00007530: 25 64 20 74 65 73 74 20 73 75 69 74 65 3a 5c 6e
00007540: 22 2c 20 4d 44 29 3b 0d 0a 0d 0a 20 20 4d 44 53
00007550: 74 72 69 6e 67 20 28 22 22 29 3b 0d 0a 20 20 4d
00007560: 44 53 74 72 69 6e 67 20 28 22 61 22 29 3b 0d 0a
00007570: 20 20 4d 44 53 74 72 69 6e 67 20 28 22 61 62 63
00007580: 22 29 3b 0d 0a 20 20 4d 44 53 74 72 69 6e 67 20
00007590: 28 22 6d 65 73 73 61 67 65 20 64 69 67 65 73 74
000075a0: 22 29 3b 0d 0a 20 20 4d 44 53 74 72 69 6e 67 20
000075b0: 28 22 61 62 63 64 65 66 67 68 69 6a 6b 6c 6d 6e
000075c0: 6f 70 71 72 73 74 75 76 77 78 79 7a 22 29 3b 0d
000075d0: 0a 20 20 4d 44 53 74 72 69 6e 67 0d 0a 20 20 20
000075e0: 20 28 22 41 42 43 44 45 46 47 48 49 4a 4b 4c 4d
000075f0: 4e 4f 50 51 52 53 54 55 56 57 58 59 5a 61 62 63
00007600: 64 65 66 67 68 69 6a 6b 6c 6d 6e 6f 70 71 72 73

00007610: 74 75 76 77 78 79 7a 30 31 32 33 34 35 36 37 38
00007620: 39 22 29 3b 0d 0a 20 20 4d 44 53 74 72 69 6e 67
00007630: 0d 0a 0d 0a 20 20 20 20 28 22 31 32 33 34 35 36
00007640: 37 38 39 30 31 32 33 34 35 36 37 38 39 30 31 32
00007650: 33 34 35 36 37 38 39 30 31 32 33 34 35 36 37 38
00007660: 39 30 5c 0d 0a 31 32 33 34 35 36 37 38 39 30 31
00007670: 32 33 34 35 36 37 38 39 30 31 32 33 34 35 36 37
00007680: 38 39 30 31 32 33 34 35 36 37 38 39 30 22 29 3b
00007690: 0d 0a 7d 0d 0a 0d 0a 2f 2a 20 44 69 67 65 73 74
000076a0: 73 20 61 20 66 69 6c 65 20 61 6e 64 20 70 72 69
000076b0: 6e 74 73 20 74 68 65 20 72 65 73 75 6c 74 2e 0d
000076c0: 0a 20 2a 2f 0d 0a 73 74 61 74 69 63 20 76 6f 69
000076d0: 64 20 4d 44 46 69 6c 65 20 28 66 69 6c 65 6e 61
000076e0: 6d 65 29 0d 0a 63 68 61 72 20 2a 66 69 6c 65 6e
000076f0: 61 6d 65 3b 0d 0a 7b 0d 0a 20 20 46 49 4c 45 20
00007700: 2a 66 69 6c 65 3b 0d 0a 20 20 4d 44 5f 43 54 58
00007710: 20 63 6f 6e 74 65 78 74 3b 0d 0a 20 20 69 6e 74
00007720: 20 6c 65 6e 3b 0d 0a 20 20 75 6e 73 69 67 6e 65
00007730: 64 20 63 68 61 72 20 62 75 66 66 65 72 5b 31 30
00007740: 32 34 5d 2c 20 64 69 67 65 73 74 5b 31 36 5d 3b
00007750: 0d 0a 0d 0a 20 20 69 66 20 28 28 66 69 6c 65 20
00007760: 3d 20 66 6f 70 65 6e 20 28 66 69 6c 65 6e 61 6d
00007770: 65 2c 20 22 72 62 22 29 29 20 3d 3d 20 4e 55 4c
00007780: 4c 29 0d 0a 20 20 20 20 70 72 69 6e 74 66 20 28
00007790: 22 25 73 20 63 61 6e 27 74 20 62 65 20 6f 70 65
000077a0: 6e 65 64 5c 6e 22 2c 20 66 69 6c 65 6e 61 6d 65
000077b0: 29 3b 0d 0a 0d 0a 20 20 65 6c 73 65 20 7b 0d 0a
000077c0: 20 20 20 20 4d 44 49 6e 69 74 20 28 26 63 6f 6e
000077d0: 74 65 78 74 29 3b 0d 0a 20 20 20 20 77 68 69 6c
000077e0: 65 20 28 6c 65 6e 20 3d 20 66 72 65 61 64 20 28
000077f0: 62 75 66 66 65 72 2c 20 31 2c 20 31 30 32 34 2c
00007800: 20 66 69 6c 65 29 29 0d 0a 20 20 20 20 20 20 20 4d
00007810: 44 55 70 64 61 74 65 20 28 26 63 6f 6e 74 65 78
00007820: 74 2c 20 62 75 66 66 65 72 2c 20 6c 65 6e 29 3b
00007830: 0d 0a 20 20 20 20 4d 44 46 69 6e 61 6c 20 28 64
00007840: 69 67 65 73 74 2c 20 26 63 6f 6e 74 65 78 74 29
00007850: 3b 0d 0a 0d 0a 20 20 20 20 66 63 6c 6f 73 65 20
00007860: 28 66 69 6c 65 29 3b 0d 0a 0d 0a 20 20 20 20 70
00007870: 72 69 6e 74 66 20 28 22 4d 44 25 64 20 28 25 73
00007880: 29 20 3d 20 22 2c 20 4d 44 2c 20 66 69 6c 65 6e
00007890: 61 6d 65 29 3b 0d 0a 20 20 20 4d 44 50 72 69
000078a0: 6e 74 20 28 64 69 67 65 73 74 29 3b 0d 0a 0d 0a
000078b0: 0d 0a 0d 0a 52 69 76 65 73 74 20 20 20 20 20 20
000078c0: 20 20 20 20 20 20 20 20 20 20 20 20 20 20 20 20
000078d0: 20 20 20 20 20 20 20 20 20 20 20 20 20 20 20 20
000078e0: 20 20 20 20 20 20 20 20 20 20 20 20 20 20 20 20
000078f0: 20 20 20 5b 50 61 67 65 20 31 38 5d 0d 0a 0c 0d
00007900: 0a 52 46 43 20 31 33 32 30 20 20 20 20 20 20 20
00007910: 20 20 20 20 20 20 20 4d 44 34 20 4d 65 73 73 61
00007920: 67 65 2d 44 69 67 65 73 74 20 41 6c 67 6f 72 69
00007930: 74 68 6d 20 20 20 20 20 20 20 20 20 20 20 20 41
00007940: 70 72 69 6c 20 31 39 39 32 0d 0a 0d 0a 0d 0a 20
00007950: 20 20 20 70 72 69 6e 74 66 20 28 22 5c 6e 22 29
00007960: 3b 0d 0a 20 20 7d 0d 0a 7d 0d 0a 0d 0a 2f 2a 20
00007970: 44 69 67 65 73 74 73 20 74 68 65 20 73 74 61 6e
00007980: 64 61 72 64 20 69 6e 70 75 74 20 61 6e 64 20 70
00007990: 72 69 6e 74 73 20 74 68 65 20 72 65 73 75 6c 74
000079a0: 2e 0d 0a 20 2a 2f 0d 0a 73 74 61 74 69 63 20 76
000079b0: 6f 69 64 20 4d 44 46 69 6c 74 65 72 20 28 29 0d

000079c0: 0a 7b 0d 0a 20 20 4d 44 5f 43 54 58 20 63 6f 6e
000079d0: 74 65 78 74 3b 0d 0a 20 20 69 6e 74 20 6c 65 6e
000079e0: 3b 0d 0a 20 20 75 6e 73 69 67 6e 65 64 20 63 68
000079f0: 61 72 20 62 75 66 66 65 72 5b 31 36 5d 2c 20 64
00007a00: 69 67 65 73 74 5b 31 36 5d 3b 0d 0a 0d 0a 20 20
00007a10: 4d 44 49 6e 69 74 20 28 26 63 6f 6e 74 65 78 74
00007a20: 29 3b 0d 0a 20 20 77 68 69 6c 65 20 28 6c 65 6e
00007a30: 20 3d 20 66 72 65 61 64 20 28 62 75 66 66 65 72
00007a40: 2c 20 31 2c 20 31 36 2c 20 73 74 64 69 6e 29 29
00007a50: 0d 0a 20 20 20 20 4d 44 55 70 64 61 74 65 20 28
00007a60: 26 63 6f 6e 74 65 78 74 2c 20 62 75 66 66 65 72
00007a70: 2c 20 6c 65 6e 29 3b 0d 0a 20 20 4d 44 46 69 6e
00007a80: 61 6c 20 28 64 69 67 65 73 74 2c 20 26 63 6f 6e
00007a90: 74 65 78 74 29 3b 0d 0a 0d 0a 20 20 4d 44 50 72
00007aa0: 69 6e 74 20 28 64 69 67 65 73 74 29 3b 0d 0a 20
00007ab0: 20 70 72 69 6e 74 66 20 28 22 5c 6e 22 29 3b 0d
00007ac0: 0a 7d 0d 0a 0d 0a 2f 2a 20 50 72 69 6e 74 73 20
00007ad0: 61 20 6d 65 73 73 61 67 65 20 64 69 67 65 73 74
00007ae0: 20 69 6e 20 68 65 78 61 64 65 63 69 6d 61 6c 2e
00007af0: 0d 0a 20 2a 2f 0d 0a 73 74 61 74 69 63 20 76 6f
00007b00: 69 64 20 4d 44 50 72 69 6e 74 20 28 64 69 67 65
00007b10: 73 74 29 0d 0a 75 6e 73 69 67 6e 65 64 20 63 68
00007b20: 61 72 20 64 69 67 65 73 74 5b 31 36 5d 3b 0d 0a
00007b30: 0d 0a 7b 0d 0a 20 20 75 6e 73 69 67 6e 65 64 20
00007b40: 69 6e 74 20 69 3b 0d 0a 0d 0a 20 20 66 6f 72 20
00007b50: 28 69 20 3d 20 30 3b 20 69 20 3c 20 31 36 3b 20
00007b60: 69 2b 2b 29 0d 0a 20 20 20 20 70 72 69 6e 74 66
00007b70: 20 28 22 25 30 32 78 22 2c 20 64 69 67 65 73 74
00007b80: 5b 69 5d 29 3b 0d 0a 7d 0d 0a 0d 0a 41 2e 35 20
00007b90: 54 65 73 74 20 73 75 69 74 65 0d 0a 0d 0a 20 20
00007ba0: 20 54 68 65 20 4d 44 34 20 74 65 73 74 20 73 75
00007bb0: 69 74 65 20 28 64 72 69 76 65 72 20 6f 70 74 69
00007bc0: 6f 6e 20 22 2d 78 22 29 20 73 68 6f 75 6c 64 20
00007bd0: 70 72 69 6e 74 20 74 68 65 20 66 6f 6c 6c 6f 77
00007be0: 69 6e 67 0d 0a 20 20 20 72 65 73 75 6c 74 73 3a
00007bf0: 0d 0a 0d 0a 4d 44 34 20 74 65 73 74 20 73 75 69
00007c00: 74 65 3a 0d 0a 4d 44 34 20 28 22 22 29 20 3d 20
00007c10: 33 31 64 36 63 66 65 30 64 31 36 61 65 39 33 31
00007c20: 62 37 33 63 35 39 64 37 65 30 63 30 38 39 63 30
00007c30: 0d 0a 4d 44 34 20 28 22 61 62 63 22 29 20 3d 20 62 64
00007c40: 65 35 32 63 62 33 31 64 65 33 33 65 34 36 32 34
00007c50: 35 65 30 35 66 62 64 62 64 36 66 62 32 34 0d 0a
00007c60: 4d 44 34 20 28 22 61 62 63 22 29 20 3d 20 61 34
00007c70: 34 38 30 31 37 61 61 66 32 31 64 38 35 32 35 66
00007c80: 63 31 30 61 65 38 37 61 61 36 37 32 39 64 0d 0a
00007c90: 4d 44 34 20 28 22 6d 65 73 73 61 67 65 20 64 69
00007ca0: 67 65 73 74 22 29 20 3d 20 64 39 31 33 30 61 38
00007cb0: 31 36 34 35 34 39 66 65 38 31 38 38 37 34 38 30
00007cc0: 36 65 31 63 37 30 31 34 62 0d 0a 4d 44 34 20 28
00007cd0: 22 61 62 63 64 65 66 67 68 69 6a 6b 6c 6d 6e 6f
00007ce0: 70 71 72 73 74 75 76 77 78 79 7a 22 29 20 3d 20
00007cf0: 64 37 39 65 31 63 33 30 38 61 61 35 62 62 63 64
00007d00: 65 65 61 38 65 64 36 33 64 66 34 31 32 64 61 39
00007d10: 0d 0a 4d 44 34 20 28 22 41 42 43 44 45 46 47 48
00007d20: 49 4a 4b 4c 4d 4e 4f 50 51 52 53 54 55 56 57 58
00007d30: 59 5a 61 62 63 64 65 66 67 68 69 6a 6b 6c 6d 6e
00007d40: 6f 70 71 72 73 74 75 76 77 78 79 7a 30 31 32 33
00007d50: 34 35 36 37 38 39 22 29 20 3d 0d 0a 30 34 33 66
00007d60: 38 35 38 32 66 32 34 31 64 62 33 35 31 63 65 36

```

00007d70: 32 37 65 31 35 33 65 37 66 30 65 34 0d 0a 4d 44
00007d80: 34 20 28 22 31 32 33 34 35 36 37 38 39 30 31 32
00007d90: 33 34 35 36 37 38 39 30 31 32 33 34 35 36 37 38
00007da0: 39 30 31 32 33 34 35 36 37 38 39 30 31 32 33 34
00007db0: 35 36 37 38 39 30 31 32 33 34 35 36 37 38 39 30
00007dc0: 31 32 33 34 35 36 0d 0a 37 38 39 30 31 32 33 34
00007dd0: 35 36 37 38 39 30 22 29 20 3d 20 65 33 33 62 34
00007de0: 64 64 63 39 63 33 38 66 32 31 39 39 63 33 65 37
00007df0: 62 31 36 34 66 63 63 30 35 33 36 0d 0a 0d 0a 0d
00007e00: 0a 0d 0a 52 69 76 65 73 74 20 20 20 20 20 20 20 20
00007e10: 20 20 20 20 20 20 20 20 20 20 20 20 20 20 20 20
00007e20: 20 20 20 20 20 20 20 20 20 20 20 20 20 20 20 20
00007e30: 20 20 20 20 20 20 20 20 20 20 20 20 20 20 20 20
00007e40: 20 20 5b 50 61 67 65 20 31 39 5d 0d 0a 0c 0d 0a
00007e50: 52 46 43 20 31 33 32 30 20 20 20 20 20 20 20 20
00007e60: 20 20 20 20 20 20 4d 44 34 20 4d 65 73 73 61 67
00007e70: 65 2d 44 69 67 65 73 74 20 41 6c 67 6f 72 69 74
00007e80: 68 6d 20 20 20 20 20 20 20 20 20 20 20 20 41 70
00007e90: 72 69 6c 20 31 39 39 32 0d 0a 0d 0a 0d 0a 53 65
00007ea0: 63 75 72 69 74 79 20 43 6f 6e 73 69 64 65 72 61
00007eb0: 74 69 6f 6e 73 0d 0a 0d 0a 20 20 20 54 68 65 20
00007ec0: 6c 65 76 65 6c 20 6f 66 20 73 65 63 75 72 69 74
00007ed0: 79 20 64 69 73 63 75 73 73 65 64 20 69 6e 20 74
00007ee0: 68 69 73 20 6d 65 6d 6f 20 69 73 20 63 6f 6e 73
00007ef0: 69 64 65 72 65 64 20 74 6f 20 62 65 0d 0a 20 20
00007f00: 20 73 75 66 66 69 63 69 65 6e 74 20 66 6f 72 20
00007f10: 69 6d 70 6c 65 6d 65 6e 74 69 6e 67 20 6d 6f 64
00007f20: 65 72 61 74 65 20 73 65 63 75 72 69 74 79 20 68
00007f30: 79 62 72 69 64 20 64 69 67 69 74 61 6c 2d 0d 0a
00007f40: 20 20 20 73 69 67 6e 61 74 75 72 65 20 73 63 68
00007f50: 65 6d 65 73 20 62 61 73 65 64 20 6f 6e 20 4d 44
00007f60: 34 20 61 6e 64 20 61 20 70 75 62 6c 69 63 2d 6b
00007f70: 65 79 20 63 72 79 70 74 6f 73 79 73 74 65 6d 2e
00007f80: 20 57 65 20 64 6f 0d 0a 20 20 20 6e 6f 74 20 6b
00007f90: 6e 6f 77 20 6f 66 20 61 6e 79 20 72 65 61 73 6f
00007fa0: 6e 20 74 68 61 74 20 4d 44 34 20 77 6f 75 6c 64
00007fb0: 20 6e 6f 74 20 62 65 20 73 75 66 66 69 63 69 65
00007fc0: 6e 74 20 66 6f 72 0d 0a 20 20 20 69 6d 70 6c 65
00007fd0: 6d 65 6e 74 69 6e 67 20 76 65 72 79 20 68 69 67
00007fe0: 68 20 73 65 63 75 72 69 74 79 20 64 69 67 69 74
00007ff0: 61 6c 2d 73 69 67 6e 61 74 75 72 65 20 73 63 68

00008000: 65 6d 65 73 2c 20 62 75 74 0d 0a 20 20 20 62 65
00008010: 63 61 75 73 65 20 4d 44 34 20 77 61 73 20 64 65
00008020: 73 69 67 6e 65 64 20 74 6f 20 62 65 20 65 78 63
00008030: 65 70 74 69 6f 6e 61 6c 6c 79 20 66 61 73 74 2c
00008040: 20 69 74 20 69 73 20 22 61 74 20 74 68 65 0d 0a
00008050: 20 20 20 65 64 67 65 22 20 69 6e 20 74 65 72 6d
00008060: 73 20 6f 66 20 72 69 73 6b 69 6e 67 20 73 75 63
00008070: 63 65 73 73 66 75 6c 20 63 72 79 70 74 61 6e 61
00008080: 6c 79 74 69 63 20 61 74 74 61 63 6b 2e 20 41 66
00008090: 74 65 72 0d 0a 20 20 20 66 75 72 74 68 65 72 20
000080a0: 63 72 69 74 69 63 61 6c 20 72 65 76 69 65 77 2c
000080b0: 20 69 74 20 6d 61 79 20 62 65 20 61 70 70 72 6f
000080c0: 70 72 69 61 74 65 20 74 6f 20 63 6f 6e 73 69 64
000080d0: 65 72 20 4d 44 34 20 66 6f 72 0d 0a 20 20 20 76
000080e0: 65 72 79 20 68 69 67 68 20 73 65 63 75 72 69 74
000080f0: 79 20 61 70 70 6c 69 63 61 74 69 6f 6e 73 2e 20

```

```

00008100: 46 6f 72 20 76 65 72 79 20 68 69 67 68 20 73 65
00008110: 63 75 72 69 74 79 20 61 70 70 6c 69 63 61 74 69
00008120: 6f 6e 73 0d 0a 20 20 20 62 65 66 6f 72 65 20 74
00008130: 68 65 20 63 6f 6d 70 6c 65 74 69 6f 6e 20 6f 66
00008140: 20 74 68 61 74 20 72 65 76 69 65 77 2c 20 74 68
00008150: 65 20 4d 44 35 20 61 6c 67 6f 72 69 74 68 6d 20
00008160: 5b 34 5d 20 69 73 0d 0a 20 20 20 72 65 63 6f 6d
00008170: 6d 65 6e 64 65 64 2e 0d 0a 0d 0a 41 75 74 68 6f
00008180: 72 27 73 20 41 64 64 72 65 73 73 0d 0a 0d 0a 20
00008190: 20 20 52 6f 6e 61 6c 64 20 4c 2e 20 52 69 76 65
000081a0: 73 74 0d 0a 20 20 20 4d 61 73 73 61 63 68 75 73
000081b0: 65 74 74 73 20 49 6e 73 74 69 74 75 74 65 20 6f
000081c0: 66 20 54 65 63 68 6e 6f 6c 6f 67 79 0d 0a 20 20
000081d0: 20 4c 61 62 6f 72 61 74 6f 72 79 20 66 6f 72 20
000081e0: 43 6f 6d 70 75 74 65 72 20 53 63 69 65 6e 63 65
000081f0: 0d 0a 20 20 20 4e 45 34 33 2d 33 32 34 0d 0a 20
00008200: 20 20 35 34 35 20 54 65 63 68 6e 6f 6c 6f 67 79
00008210: 20 53 71 75 61 72 65 0d 0a 20 20 20 43 61 6d 62
00008220: 72 69 64 67 65 2c 20 4d 41 20 20 30 32 31 33 39
00008230: 2d 31 39 38 36 0d 0a 0d 0a 20 20 20 50 68 6f 6e
00008240: 65 3a 20 28 36 31 37 29 20 32 35 33 2d 35 38 38
00008250: 30 0d 0a 20 20 20 45 4d 61 69 6c 3a 20 72 69 76
00008260: 65 73 74 40 74 68 65 6f 72 79 2e 6c 63 73 2e 6d
00008270: 69 74 2e 65 64 75 0d 0a 0d 0a 0d 0a 0d 0a 0d 0a
00008280: 0d 0a 0d 0a 0d 0a 0d 0a 0d 0a 0d 0a 0d 0a 0d 0a
00008290: 0d 0a 0d 0a 0d 0a 0d 0a 0d 0a 0d 0a 0d 0a 0d 0a
000082a0: 0d 0a 0d 0a 0d 0a 0d 0a 0d 0a 52 69 76 65
000082b0: 73 74 20 20 20 20 20 20 20 20 20 20 20 20 20 20
000082c0: 20 20 20 20 20 20 20 20 20 20 20 20 20 20 20 20
000082d0: 20 20 20 20 20 20 20 20 20 20 20 20 20 20 20 20
000082e0: 20 20 20 20 20 20 20 20 20 5b 50 61 67 65
000082f0: 20 32 30 5d 0d 0a 0c

```

The resulting signatures and similarity data are shown in the following table. The signatures are shown in the format of one signature per line.

Block length	MD4 hash
3108	1d6406ded92381dc22cc36b8899b9fdd
2249	919c5d8510ff6387340a61f87b4a3956
6190	b4485ec7719b17df2543a2f711ce6eff
17389	3e752ed7d8f7d7c17fee487b2491a3e0
1301	1ac5c13f71f575ea8f332465baba2cb0
3290	a74b42809f62ed2aa022592b2bbf222c

The resulting signature file is shown in the following diagram.

Note Hexadecimal numbers that are bold represent the beginning of a signature.

0	1	2	3	4	5	6	7	8	9	10	11	12	13	14	15	16	17	18	19	20	21	22	23	24	25	26	27	28	29	30	31
0x18, 0x00, 0x00, 0x00																															
0x01, 0x00, 0x01, 0x00																															
0x01, 0x00, 0x01, 0x00																															
0																															
0x01, 0x00, 0x00, 0x00																															
0																															
0x1d , 0x64, 0x06, 0xde																															
0xd9, 0x23, 0x81, 0xdc																															
0x22, 0xcc, 0x36, 0xb8																															
0x89, 0x9b, 0x9f, 0xdd																															
0x24, 0x0c, 0x91 , 0x9c																															
0x5d, 0x85, 0x10, 0xff																															
0x63, 0x87, 0x34, 0x0a																															
0x61, 0xf8, 0x7b, 0x4a																															
0x39, 0x56, 0xc9, 0x08																															
0xb4 , 0x48, 0x5e, 0xc7																															
0x71, 0x9b, 0x17, 0xdf																															
0x25, 0x43, 0xa2, 0xf7																															
0x11, 0xce, 0x6e, 0xff																															
0x2E, 0x18, 0x3e , 0x75																															
0x2e, 0xd7, 0xd8, 0xf7																															
0xd7, 0xc1, 0x7f, 0xee																															

0x48, 0x7b, 0x24, 0x91
0xa3, 0xe0, 0xED, 0x43
0x1a , 0xc5, 0xc1, 0x3f
0x71, 0xf5, 0x75, 0xea
0x8f, 0x33, 0x24, 0x65
0xba, 0xba, 0x2c, 0xb0
0x15, 0x05, 0xa7 , 0x4b
0x42, 0x80, 0x9f, 0x62
0xed, 0x2a, 0xa0, 0x22
0x59, 0x2b, 0x2b, 0xbf
0x22, 0x2c, 0xDA, 0x0C

4.6 Sample Similarity Calculation

To test an implementation, the following sample similarity data computation is used for a file. The similarity data shown is as computed over the preceding set of signatures. Each value is displayed in hexadecimal.

t0	t1	t2	t3	t4	t5	t6	t7	t8	t9	t10	t11	t12	t13	t14	t15
2a	38	3a	37	09	0b	3b	01	3e	26	27	29	2a	01	14	39

4.7 Other Considerations

The size of RDC chunks can be shown mathematically to be on average two times the horizon size.

The minimum size of RDC chunks is usually the same as the horizon size. One exception to this rule is when there are less than horizon-size bytes of data left from the current chunk boundary to the end of the data. The other exception to this rule is when the maximum block size is exceeded.

The maximum RDC chunk size is $2^{16}-1$ (65,535) bytes. One of the many possible examples of when this limit may be encountered is when large portions of the data (or all of the data) are the same (that is, all zeros or all ones). RDC automatically inserts a **cut point** to ensure that no block is larger than 65,535 bytes. If, for example, the first local maximum is found at position 65,540 in a file, there will be a cut point at positions 65,535 and 65,640, the second block being only 5 bytes long.

It is possible, of course, to apply RDC recursion to any number of levels. The depth of recursion that an application should use depends on the size of the signature file being transferred versus how many chunks of the signature file are required to be transferred for each recursion level. The

application must determine when bandwidth would be better utilized by just sending a bigger signature file to avoid another round of signature data transfer.

5 Security

5.1 Security Considerations for Implementers

RDC relies on a relatively weak hash function (that is, MD4) for its chunks. MD4 was chosen because it requires few cycles per byte, has a relatively low startup cost (because several hashes are computed per *file*, one per chunk), and yet it is still a reasonably **collision-resistant hash function**. This is to be taken in the context in which the main functionality of RDC is to speed up sufficiently many (but not necessarily all) *file* transfers. RDC itself does not advertise that the transfer is accurate, but integrity should be checked by strong hash functions. Strong hash functions can be computed when traversing the source *file* and sent over at the end or beginning of a transfer.

Thus, it is possible (even to be (rarely) expected) that two distinct chunks of data may have the same length and the same MD4 hash value. In this case, it is possible that the use of RDC will result in the construction of a target file that is, in fact, distinct from the source file.

An application using RDC should have an alternate means outside of RDC to determine if the target file has the same content as the original source file. <5>

One way to achieve this goal is to compute a hash (using some application-selected hash algorithm) on the entire contents of the source file and the target file. If the hashes do not match, the application could invoke some sort of recovery operation (such as transferring the source file without the use of RDC). If it is possible that the input data to RDC is generated by a source that is not trustworthy, this secondary hash should be cryptographically secure, so that an attacker cannot intentionally generate a file update that could result in a signature collision and consequent errant transfer.

5.2 Index of Security Parameters

None.

6 Appendix A: Product Behavior

The information in this specification is applicable to the following Microsoft products or supplemental software. References to product versions include released service packs:

- Windows Server 2003 R2 operating system
- Windows Vista operating system
- Windows Server 2008 operating system
- Windows 7 operating system
- Windows Server 2008 R2 operating system
- Windows 8 operating system
- Windows Server 2012 operating system
- Windows 8.1 operating system
- Windows Server 2012 R2 operating system

Exceptions, if any, are noted below. If a service pack or Quick Fix Engineering (QFE) number appears with the product version, behavior changed in that service pack or QFE. The new behavior also applies to subsequent service packs of the product unless otherwise specified. If a product edition appears with the product version, behavior is different in that product edition.

Unless otherwise specified, any statement of optional behavior in this specification that is prescribed using the terms SHOULD or SHOULD NOT implies product behavior in accordance with the SHOULD or SHOULD NOT prescription. Unless otherwise specified, the term MAY implies that the product does not follow the prescription.

<1> [Section 3.1.5.1](#): For an example of how Windows performs hash window and horizon negotiation, see [\[MS-FRS2\]](#) section 3.2.4.1.14.

<2> [Section 3.1.5.3.1](#): The RDC library in Windows supports a maximum recursion depth of eight.

<3> [Section 3.1.5.4](#): If the similarity data appears in a protocol, the Windows-based client and server use the methods described in section [3.1.5.4.1](#) to compute similarity data.

<4> [Section 3.1.5.4.2](#): FRS2 [\[MS-FRS2\]](#) may use several seed files, some of which are selected by finding the files that have the largest number of matching similarity traits. FRS2 also uses other techniques for finding seed files.

<5> [Section 5.1](#): Windows Distributed File System (DFS) replication [\[MS-FRS2\]](#), the only Microsoft component using RDC at the time of this writing, computes a SHA-1 hash [\[FIPS180-2\]](#) over the contents of the file. And if it does not match, it transfers the file without using RDC.

7 Change Tracking

No table of changes is available. The document is either new or has had no changes since its last release.

8 Index

A

[Applicability](#) 11

C

[Capability negotiation](#) 11

[Change tracking](#) 74

D

[Details](#) 15

E

[Examples](#) 27

F

[Fields - vendor-extensible](#) 11

G

[Glossary](#) 7

I

[Implementers - security considerations](#) 72

[Informative references](#) 9

[Introduction](#) 7

M

Messages

[syntax](#) 12

[transport](#) 12

N

[Normative references](#) 9

O

[Overview](#) 9

P

[Parameters - security](#) 72

[Preconditions](#) 11

[Prerequisites](#) 11

[Product behavior](#) 73

R

References

[informative](#) 9

[normative](#) 9

[Relationship to other protocols](#) 11

S

[Security](#) 72

[Standards assignments](#) 11

[Syntax - message](#) 12

T

[Tracking changes](#) 74

[Transport - message](#) 12

V

[Vendor-extensible fields](#) 11

[Versioning](#) 11