

[MS-PAR]: Print System Asynchronous Remote Protocol

Intellectual Property Rights Notice for Open Specifications Documentation

- **Technical Documentation.** Microsoft publishes Open Specifications documentation for protocols, file formats, languages, standards as well as overviews of the interaction among each of these technologies.
- **Copyrights.** This documentation is covered by Microsoft copyrights. Regardless of any other terms that are contained in the terms of use for the Microsoft website that hosts this documentation, you may make copies of it in order to develop implementations of the technologies described in the Open Specifications and may distribute portions of it in your implementations using these technologies or your documentation as necessary to properly document the implementation. You may also distribute in your implementation, with or without modification, any schema, IDL's, or code samples that are included in the documentation. This permission also applies to any documents that are referenced in the Open Specifications.
- **No Trade Secrets.** Microsoft does not claim any trade secret rights in this documentation.
- **Patents.** Microsoft has patents that may cover your implementations of the technologies described in the Open Specifications. Neither this notice nor Microsoft's delivery of the documentation grants any licenses under those or any other Microsoft patents. However, a given Open Specification may be covered by Microsoft [Open Specification Promise](#) or the [Community Promise](#). If you would prefer a written license, or if the technologies described in the Open Specifications are not covered by the Open Specifications Promise or Community Promise, as applicable, patent licenses are available by contacting iplg@microsoft.com.
- **Trademarks.** The names of companies and products contained in this documentation may be covered by trademarks or similar intellectual property rights. This notice does not grant any licenses under those rights. For a list of Microsoft trademarks, visit www.microsoft.com/trademarks.
- **Fictitious Names.** The example companies, organizations, products, domain names, email addresses, logos, people, places, and events depicted in this documentation are fictitious. No association with any real company, organization, product, domain name, email address, logo, person, place, or event is intended or should be inferred.

Reservation of Rights. All other rights are reserved, and this notice does not grant any rights other than specifically described above, whether by implication, estoppel, or otherwise.

Tools. The Open Specifications do not require the use of Microsoft programming tools or programming environments in order for you to develop an implementation. If you have access to Microsoft programming tools and environments you are free to take advantage of them. Certain Open Specifications are intended for use in conjunction with publicly available standard specifications and network programming art, and assumes that the reader either is familiar with the aforementioned material or has immediate access to it.

Revision Summary

| Date | Revision History | Revision Class | Comments |
|------------|------------------|----------------|--|
| 02/22/2007 | 0.01 | | MCPP Milestone 3 Initial Availability |
| 06/01/2007 | 1.0 | Major | Updated and revised the technical content. |
| 07/03/2007 | 1.0.1 | Editorial | Revised and edited the technical content. |
| 07/20/2007 | 1.0.2 | Editorial | Revised and edited the technical content. |
| 08/10/2007 | 1.0.3 | Editorial | Revised and edited the technical content. |
| 09/28/2007 | 1.1 | Minor | Updated the technical content. |
| 10/23/2007 | 1.2 | Minor | Updated the technical content. |
| 11/30/2007 | 1.2.1 | Editorial | Revised and edited the technical content. |
| 01/25/2008 | 1.2.2 | Editorial | Revised and edited the technical content. |
| 03/14/2008 | 2.0 | Major | Updated and revised the technical content. |
| 05/16/2008 | 3.0 | Major | Updated and revised the technical content. |
| 06/20/2008 | 3.1 | Minor | Updated the technical content. |
| 07/25/2008 | 4.0 | Major | Updated and revised the technical content. |
| 08/29/2008 | 4.1 | Minor | Updated the technical content. |
| 10/24/2008 | 5.0 | Major | Updated and revised the technical content. |
| 12/05/2008 | 5.1 | Minor | Updated the technical content. |
| 01/16/2009 | 5.2 | Minor | Updated the technical content. |
| 02/27/2009 | 6.0 | Major | Updated and revised the technical content. |
| 04/10/2009 | 7.0 | Major | Updated and revised the technical content. |
| 05/22/2009 | 7.0.1 | Editorial | Revised and edited the technical content. |
| 07/02/2009 | 7.0.2 | Editorial | Revised and edited the technical content. |
| 08/14/2009 | 7.1 | Minor | Updated the technical content. |
| 09/25/2009 | 7.2 | Minor | Updated the technical content. |
| 11/06/2009 | 7.2.1 | Editorial | Revised and edited the technical content. |
| 12/18/2009 | 7.2.2 | Editorial | Revised and edited the technical content. |
| 01/29/2010 | 7.3 | Minor | Updated the technical content. |

| Date | Revision History | Revision Class | Comments |
|-------------|-------------------------|-----------------------|--|
| 03/12/2010 | 7.4 | Minor | Updated the technical content. |
| 04/23/2010 | 7.5 | Minor | Updated the technical content. |
| 06/04/2010 | 8.0 | Major | Updated and revised the technical content. |
| 07/16/2010 | 8.1 | Minor | Clarified the meaning of the technical content. |
| 08/27/2010 | 8.1 | No change | No changes to the meaning, language, or formatting of the technical content. |
| 10/08/2010 | 9.0 | Major | Significantly changed the technical content. |
| 11/19/2010 | 9.0 | No change | No changes to the meaning, language, or formatting of the technical content. |
| 01/07/2011 | 9.0 | No change | No changes to the meaning, language, or formatting of the technical content. |
| 02/11/2011 | 9.0 | No change | No changes to the meaning, language, or formatting of the technical content. |
| 03/25/2011 | 9.0 | No change | No changes to the meaning, language, or formatting of the technical content. |
| 05/06/2011 | 9.0.1 | Editorial | Changed language and formatting in the technical content. |
| 06/17/2011 | 9.1 | Minor | Clarified the meaning of the technical content. |
| 09/23/2011 | 9.2 | Minor | Clarified the meaning of the technical content. |
| 12/16/2011 | 10.0 | Major | Significantly changed the technical content. |
| 03/30/2012 | 11.0 | Major | Significantly changed the technical content. |
| 07/12/2012 | 11.0 | No change | No changes to the meaning, language, or formatting of the technical content. |
| 10/25/2012 | 11.0 | No change | No changes to the meaning, language, or formatting of the technical content. |
| 01/31/2013 | 11.0 | No change | No changes to the meaning, language, or formatting of the technical content. |
| 08/08/2013 | 12.0 | Major | Significantly changed the technical content. |
| 11/14/2013 | 12.0 | No change | No changes to the meaning, language, or formatting of the technical content. |
| 02/13/2014 | 12.0 | No change | No changes to the meaning, language, or formatting of the technical content. |
| 05/15/2014 | 12.0 | No change | No changes to the meaning, language, or formatting of |

| Date | Revision History | Revision Class | Comments |
|------|------------------|----------------|------------------------|
| | | | the technical content. |

Contents

| | |
|--|-----------|
| 1 Introduction | 8 |
| 1.1 Glossary | 8 |
| 1.2 References | 10 |
| 1.2.1 Normative References | 10 |
| 1.2.2 Informative References | 11 |
| 1.3 Overview | 12 |
| 1.3.1 Management of the Print System | 12 |
| 1.3.2 Communication of Print Job Data | 13 |
| 1.3.3 Notification of Print System Changes | 14 |
| 1.4 Relationship to Other Protocols | 16 |
| 1.5 Prerequisites/Preconditions | 16 |
| 1.6 Applicability Statement | 17 |
| 1.7 Versioning and Capability Negotiation | 17 |
| 1.8 Vendor-Extensible Fields | 17 |
| 1.9 Standards Assignments | 18 |
| 2 Messages | 19 |
| 2.1 Transport | 19 |
| 2.2 Common Data Types | 19 |
| 2.2.1 EPrintPropertyType | 20 |
| 2.2.2 RpcPrintPropertyValue | 21 |
| 2.2.3 RpcPrintNamedProperty | 22 |
| 2.2.4 RpcPrintPropertiesCollection | 23 |
| 2.2.5 RMTNTFY_HANDLE | 23 |
| 2.2.6 NOTIFY_OPTIONS_CONTAINER | 24 |
| 2.2.7 NOTIFY_REPLY_CONTAINER | 24 |
| 2.2.8 CORE_PRINTER_DRIVER | 24 |
| 3 Protocol Details | 26 |
| 3.1 IRemoteWinspool Server Details | 26 |
| 3.1.1 Abstract Data Model | 26 |
| 3.1.2 Timers | 27 |
| 3.1.3 Initialization | 27 |
| 3.1.4 Message Processing Events and Sequencing Rules | 27 |
| 3.1.4.1 Printer Management Methods | 35 |
| 3.1.4.1.1 RpcAsyncOpenPrinter (Opnum 0) | 39 |
| 3.1.4.1.2 RpcAsyncAddPrinter (Opnum 1) | 39 |
| 3.1.4.1.3 RpcAsyncDeletePrinter (Opnum 7) | 40 |
| 3.1.4.1.4 RpcAsyncSetPrinter (Opnum 8) | 40 |
| 3.1.4.1.5 RpcAsyncGetPrinter (Opnum 9) | 41 |
| 3.1.4.1.6 RpcAsyncGetPrinterData (Opnum 16) | 41 |
| 3.1.4.1.7 RpcAsyncGetPrinterDataEx (Opnum 17) | 42 |
| 3.1.4.1.8 RpcAsyncSetPrinterData (Opnum 18) | 42 |
| 3.1.4.1.9 RpcAsyncSetPrinterDataEx (Opnum 19) | 43 |
| 3.1.4.1.10 RpcAsyncClosePrinter (Opnum 20) | 43 |
| 3.1.4.1.11 RpcAsyncEnumPrinterData (Opnum 27) | 44 |
| 3.1.4.1.12 RpcAsyncEnumPrinterDataEx (Opnum 28) | 45 |
| 3.1.4.1.13 RpcAsyncEnumPrinterKey (Opnum 29) | 45 |
| 3.1.4.1.14 RpcAsyncDeletePrinterData (Opnum 30) | 46 |
| 3.1.4.1.15 RpcAsyncDeletePrinterDataEx (Opnum 31) | 46 |

| | | |
|------------|--|----|
| 3.1.4.1.16 | RpcAsyncDeletePrinterKey (Opnum 32) | 47 |
| 3.1.4.1.17 | RpcAsyncSendRecvBidiData (Opnum 34) | 47 |
| 3.1.4.1.18 | RpcAsyncCreatePrinterIC (Opnum 35) | 48 |
| 3.1.4.1.19 | RpcAsyncPlayGdiScriptOnPrinterIC (Opnum 36) | 48 |
| 3.1.4.1.20 | RpcAsyncDeletePrinterIC (Opnum 37) | 49 |
| 3.1.4.1.21 | RpcAsyncEnumPrinters (Opnum 38) | 49 |
| 3.1.4.1.22 | RpcAsyncAddPerMachineConnection (Opnum 55) | 50 |
| 3.1.4.1.23 | RpcAsyncDeletePerMachineConnection (Opnum 56) | 50 |
| 3.1.4.1.24 | RpcAsyncEnumPerMachineConnections (Opnum 57) | 51 |
| 3.1.4.1.25 | RpcAsyncResetPrinter (Opnum 69) | 51 |
| 3.1.4.2 | Printer-Driver Management Methods | 52 |
| 3.1.4.2.1 | RpcAsyncGetPrinterDriver (Opnum 26) | 53 |
| 3.1.4.2.2 | RpcAsyncAddPrinterDriver (Opnum 39) | 54 |
| 3.1.4.2.3 | RpcAsyncEnumPrinterDrivers (Opnum 40) | 54 |
| 3.1.4.2.4 | RpcAsyncGetPrinterDriverDirectory (Opnum 41) | 55 |
| 3.1.4.2.5 | RpcAsyncDeletePrinterDriver (Opnum 42) | 56 |
| 3.1.4.2.6 | RpcAsyncDeletePrinterDriverEx (Opnum 43) | 56 |
| 3.1.4.2.7 | RpcAsyncInstallPrinterDriverFromPackage (Opnum 62) | 57 |
| 3.1.4.2.8 | RpcAsyncUploadPrinterDriverPackage (Opnum 63) | 59 |
| 3.1.4.2.9 | RpcAsyncGetCorePrinterDrivers (Opnum 64) | 61 |
| 3.1.4.2.10 | RpcAsyncCorePrinterDriverInstalled (Opnum 65) | 63 |
| 3.1.4.2.11 | RpcAsyncGetPrinterDriverPackagePath (Opnum 66) | 64 |
| 3.1.4.2.12 | RpcAsyncDeletePrinterDriverPackage (Opnum 67) | 65 |
| 3.1.4.3 | Printer-Port Management Methods | 67 |
| 3.1.4.3.1 | RpcAsyncXcvData (Opnum 33) | 67 |
| 3.1.4.3.2 | RpcAsyncEnumPorts (Opnum 47) | 68 |
| 3.1.4.3.3 | RpcAsyncAddPort (Opnum 49) | 68 |
| 3.1.4.3.4 | RpcAsyncSetPort (Opnum 50) | 69 |
| 3.1.4.4 | Print-Processor Management Methods | 69 |
| 3.1.4.4.1 | RpcAsyncAddPrintProcessor (Opnum 44) | 70 |
| 3.1.4.4.2 | RpcAsyncEnumPrintProcessors (Opnum 45) | 71 |
| 3.1.4.4.3 | RpcAsyncGetPrintProcessorDirectory (Opnum 46) | 71 |
| 3.1.4.4.4 | RpcAsyncDeletePrintProcessor (Opnum 53) | 72 |
| 3.1.4.4.5 | RpcAsyncEnumPrintProcessorDatatypes (Opnum 54) | 72 |
| 3.1.4.5 | Port Monitor Management Methods | 73 |
| 3.1.4.5.1 | RpcAsyncEnumMonitors (Opnum 48) | 73 |
| 3.1.4.5.2 | RpcAsyncAddMonitor (Opnum 51) | 74 |
| 3.1.4.5.3 | RpcAsyncDeleteMonitor (Opnum 52) | 74 |
| 3.1.4.6 | Form Management Methods | 75 |
| 3.1.4.6.1 | RpcAsyncAddForm (Opnum 21) | 75 |
| 3.1.4.6.2 | RpcAsyncDeleteForm (Opnum 22) | 76 |
| 3.1.4.6.3 | RpcAsyncGetForm (Opnum 23) | 76 |
| 3.1.4.6.4 | RpcAsyncSetForm (Opnum 24) | 77 |
| 3.1.4.6.5 | RpcAsyncEnumForms (Opnum 25) | 77 |
| 3.1.4.7 | Job Management Methods | 78 |
| 3.1.4.7.1 | RpcAsyncSetJob (Opnum 2) | 79 |
| 3.1.4.7.2 | RpcAsyncGetJob (Opnum 3) | 79 |
| 3.1.4.7.3 | RpcAsyncEnumJobs (Opnum 4) | 80 |
| 3.1.4.7.4 | RpcAsyncAddJob (Opnum 5) | 80 |
| 3.1.4.7.5 | RpcAsyncScheduleJob (Opnum 6) | 81 |
| 3.1.4.8 | Job Printing Methods | 81 |
| 3.1.4.8.1 | RpcAsyncStartDocPrinter (Opnum 10) | 82 |
| 3.1.4.8.2 | RpcAsyncStartPagePrinter (Opnum 11) | 82 |

| | | |
|------------|---|------------|
| 3.1.4.8.3 | RpcAsyncWritePrinter (Opnum 12) | 83 |
| 3.1.4.8.4 | RpcAsyncEndPagePrinter (Opnum 13)..... | 83 |
| 3.1.4.8.5 | RpcAsyncEndDocPrinter (Opnum 14) | 84 |
| 3.1.4.8.6 | RpcAsyncAbortPrinter (Opnum 15) | 84 |
| 3.1.4.8.7 | RpcAsyncReadPrinter (Opnum 68)..... | 85 |
| 3.1.4.9 | Printing-Related Notification Methods | 85 |
| 3.1.4.9.1 | RpcSyncRegisterForRemoteNotifications (Opnum 58)..... | 86 |
| 3.1.4.9.2 | RpcSyncUnRegisterForRemoteNotifications (Opnum 59)..... | 87 |
| 3.1.4.9.3 | RpcSyncRefreshRemoteNotifications (Opnum 60) | 88 |
| 3.1.4.9.4 | RpcAsyncGetRemoteNotifications (Opnum 61) | 89 |
| 3.1.4.10 | Job Named Property Management Methods | 90 |
| 3.1.4.10.1 | RpcAsyncGetJobNamedPropertyValue (Opnum 70) | 90 |
| 3.1.4.10.2 | RpcAsyncSetJobNamedProperty (Opnum 71) | 91 |
| 3.1.4.10.3 | RpcAsyncDeleteJobNamedProperty (Opnum 72)..... | 91 |
| 3.1.4.10.4 | RpcAsyncEnumJobNamedProperties (Opnum 73)..... | 92 |
| 3.1.4.11 | Branch Office Print Remote Logging Methods..... | 93 |
| 3.1.4.11.1 | RpcAsyncLogJobInfoForBranchOffice (Opnum 74)..... | 93 |
| 3.1.5 | Timer Events | 93 |
| 3.1.6 | Other Local Events | 93 |
| 3.2 | IRemoteWinspool Client Details | 94 |
| 3.2.1 | Abstract Data Model | 94 |
| 3.2.2 | Timers | 94 |
| 3.2.3 | Initialization | 94 |
| 3.2.4 | Message Processing Events and Sequencing Rules..... | 94 |
| 3.2.5 | Timer Events | 95 |
| 3.2.6 | Other Local Events | 95 |
| 4 | Protocol Examples..... | 96 |
| 4.1 | Adding a Printer to a Server..... | 96 |
| 4.2 | Adding a Printer Driver to a Server | 97 |
| 4.3 | Enumerating Printers on a Server | 97 |
| 4.4 | Enumerating Print Jobs on a Server | 98 |
| 4.5 | Receiving Notifications from a Server | 99 |
| 5 | Security..... | 103 |
| 5.1 | Security Considerations for Implementers..... | 103 |
| 5.2 | Index of Security Parameters | 103 |
| 6 | Appendix A: Full IDL..... | 104 |
| 7 | Appendix B: Product Behavior | 131 |
| 8 | Change Tracking..... | 137 |
| 9 | Index | 138 |

1 Introduction

This is a specification of the Print System Asynchronous Remote Protocol. It is based on the **Remote Procedure Call (RPC)** protocol ([\[C706\]](#) and [\[MS-RPCE\]](#)).

The Print System Asynchronous Remote Protocol supports printing and spooling operations between a client and server, including **print job** control and **print system** management. It is designed to be used asynchronously by clients whose implementations permit them to continue execution without waiting for an RPC method call to return. This protocol is parallel to the Print System Remote Protocol [\[MS-RPRN\]](#), but the two protocols support slightly different functionality.

Sections 1.8, 2, and 3 of this specification are normative and can contain the terms MAY, SHOULD, MUST, MUST NOT, and SHOULD NOT as defined in RFC 2119. Sections 1.5 and 1.9 are also normative but cannot contain those terms. All other sections and examples in this specification are informative.

1.1 Glossary

The following terms are defined in [\[MS-GLOS\]](#):

- access control entry (ACE)**
- authentication level**
- device**
- discretionary access control list (DACL)**
- domain**
- driver package**
- driver store**
- endpoint**
- enhanced metafile spool format (EMFSPOOL)**
- failover**
- globally unique identifier (GUID)**
- GUIDString**
- HRESULT**
- INF file**
- Interface Definition Language (IDL)**
- little-endian**
- named pipe**
- Network Data Representation (NDR)**
- object UUID**
- opnum**
- page description language (PDL)**
- principal name**
- print client**
- print job**
- print queue**
- print server**
- print system**
- printer driver**
- printer form**
- registry**
- remote procedure call (RPC)**
- RPC context handle**
- RPC dynamic endpoint**

RPC endpoint
security descriptor
security identifier (SID)
security provider
Simple and Protected GSS-API Negotiation Mechanism (SPNEGO)
spool file
Transmission Control Protocol (TCP)
Unicode
universally unique identifier (UUID)
universal serial bus (USB)
upgrade
UTF-16
UTF-16LE (Unicode Transformation Format, 16-bits, little-endian)
well-known endpoint

The following terms are defined in [\[MS-RPRN\]](#):

branch office print remote logging
event channel
Microsoft-Windows-PrintService

The following terms are specific to this document:

access level: The type of access the client requests for an object, such as read access, write access, or administrative access.

bid: See **bidirectional**.

bidirectional: The ability to move, transfer, or transmit in two directions.

CAB File: See **Cabinet File**.

Cabinet File: A file that has the suffix .cab and that acts as a container for other files. It serves as a compressed archive for a group of files. For more information, including the format of **cab Files**, see [\[MSDN-CAB\]](#).

class printer driver: Any **printer driver** declared by its manufacturer to be one from which a **derived printer driver** can derive. A **class printer driver** cannot itself be a **derived printer driver**.

core printer driver: A **printer driver** that other printer drivers depend on. In Windows, this term includes the Unidrv (for more information, see [\[MSDN-UNIDRV\]](#)) and Pscript (for more information, see [\[MSDN-PSCRIPT\]](#)) printer drivers.

derived printer driver: A **printer driver** declared by its manufacturer to depend on a particular **class printer driver** by sharing modules with the **class printer driver**.

information context: A special-purpose printer object that can only be used to obtain information about the fonts (For more information, see [\[MSDN-FONTS\]](#)) that are supported by a printer.

monitor module: An executable object that provides a communication path between the **print system** and the printers on a server.

multisz: A data type that defines an array of null-terminated, 16-bit Unicode **UTF-16LE**-encoded strings, with an additional null after the final **string**.

plug-in: An executable module that can be loaded by the **print server** to perform specific functions.

port: A logical name that represents a connection to a **device**. A port can represent a network address (for example, a **TCP/IP** address) or a local connection (for example, a **USB** port).

port monitor: A **plug-in** that communicates with a **device** that is connected to a port. A port monitor may interact with the **device** locally, remotely over a network, or through some other communication channel. The data that passes through a port monitor is in a form that can be understood by the destination **device**, such as **page description language (PDL)**.

port monitor module: A **monitor module** for a **port monitor**.

print processor: A **plug-in** that runs on a **print server** and processes **print job** data before it is sent to a print **device**.

print provider: A plug-in that runs on the **print server** and routes **print system** requests. Print providers are Windows-specific and not required by the protocol.

printer driver manifest: A file that is installed with a **printer driver** and lists attributes of the **printer driver**. The formatting of **printer driver manifests** is specific to the print server implementation.

printer driver upgrade: An **upgrade** operation where a newer **printer driver** is installed, replacing an older **printer driver**.

RAW format: **page description language (PDL)** data that can be sent to the **device** without further processing.

spool file format: The specific representation that is used in an instance of a **spool file**. Common examples for **spool file** formats are **enhanced metafile spool format (EMFSPool)** and **XML Paper Specification**. For more information, see [\[MS-EMFSPool\]](#), [\[MSDN-SPOOL\]](#) and [\[MSDN-XMLP\]](#).

string resource: A string stored in a resource library that can be retrieved with a key.

MAY, SHOULD, MUST, SHOULD NOT, MUST NOT: These terms (in all caps) are used as described in [\[RFC2119\]](#). All statements of optional behavior use either MAY, SHOULD, or SHOULD NOT.

1.2 References

References to Microsoft Open Specifications documentation do not include a publishing year because links are to the latest version of the documents, which are updated frequently. References to other documents include a publishing year when one is available.

1.2.1 Normative References

We conduct frequent surveys of the normative references to assure their continued availability. If you have any issue with finding a normative reference, please contact dochelp@microsoft.com. We will assist you in finding the relevant information.

[C706] The Open Group, "DCE 1.1: Remote Procedure Call", C706, August 1997, <https://www2.opengroup.org/ogsys/catalog/c706>

[C706-Ch2Intro] The Open Group, "Introduction to the RPC API", C706, August 1997, <http://www.opengroup.org/onlinepubs/9692999399/chap2.htm>

[C706-Ch6RPCCallModel] The Open Group, "Remote Procedure Call Model", C706, August 1997, <http://www.opengroup.org/onlinepubs/9692999399/chap6.htm>

[MS-DTYP] Microsoft Corporation, "[Windows Data Types](#)".

[MS-ERREF] Microsoft Corporation, "[Windows Error Codes](#)".

[MS-RPCE] Microsoft Corporation, "[Remote Procedure Call Protocol Extensions](#)".

[MS-RPRN] Microsoft Corporation, "[Print System Remote Protocol](#)".

[MS-SPNG] Microsoft Corporation, "[Simple and Protected GSS-API Negotiation Mechanism \(SPNEGO\) Extension](#)".

[RFC2119] Bradner, S., "Key words for use in RFCs to Indicate Requirement Levels", BCP 14, RFC 2119, March 1997, <http://www.rfc-editor.org/rfc/rfc2119.txt>

[RFC2781] Hoffman, P., and Yergeau, F., "UTF-16, an encoding of ISO 10646", RFC 2781, February 2000, <http://www.ietf.org/rfc/rfc2781.txt>

1.2.2 Informative References

[DEVMODE] Microsoft Corporation, "DEVMODE structure", [http://msdn.microsoft.com/en-us/library/dd183565\(VS.85\).aspx](http://msdn.microsoft.com/en-us/library/dd183565(VS.85).aspx)

[MS-EMFSPPOOL] Microsoft Corporation, "[Enhanced Metafile Spool Format](#)".

[MS-GLOS] Microsoft Corporation, "[Windows Protocols Master Glossary](#)".

[MS-SMB2] Microsoft Corporation, "[Server Message Block \(SMB\) Protocol Versions 2 and 3](#)".

[MS-WUSP] Microsoft Corporation, "[Windows Update Services: Client-Server Protocol](#)".

[MSDN-AUTHN] Microsoft Corporation, "Authentication-Service Constants", <http://msdn.microsoft.com/en-us/library/aa373556.aspx>

[MSDN-CAB] Microsoft Corporation, "Microsoft Cabinet Format", <http://msdn.microsoft.com/en-us/library/bb417343.aspx>

[MSDN-FONTS] Microsoft Corporation, "About Fonts", [http://msdn.microsoft.com/en-us/library/dd162470\(VS.85\).aspx](http://msdn.microsoft.com/en-us/library/dd162470(VS.85).aspx)

[MSDN-MUI] Microsoft Corporation, "Language Identifier Constants and Strings", <http://msdn.microsoft.com/en-us/library/ff741765.aspx>

[MSDN-PSCRIPT] Microsoft Corporation, "Microsoft PostScript Printer Driver", [http://msdn.microsoft.com/en-us/library/ff556561\(VS.85\).aspx](http://msdn.microsoft.com/en-us/library/ff556561(VS.85).aspx)

[MSDN-SPOOL] Microsoft Corporation, "Print Spooler Components", <http://msdn.microsoft.com/en-us/library/ff561109.aspx>

[MSDN-UINF] Microsoft Corporation, "Using INF Files", <http://msdn.microsoft.com/en-us/library/Aa741213.aspx>

[MSDN-UNIDRV] Microsoft Corporation, "Microsoft Universal Printer Driver", <http://msdn.microsoft.com/en-us/library/ff556567.aspx>

[MSDN-XMLP] Microsoft Corporation, "A First Look at APIs For Creating XML Paper Specification Documents", <http://msdn.microsoft.com/en-us/magazine/cc163664.aspx>

[MSFT-XMLSpecPaperEssPk] Microsoft Corporation, "Microsoft XML Paper Specification Essentials Pack", November 2004, <http://www.microsoft.com/downloads/en/details.aspx?FamilyID=b8dcffdd-e3a5-44cc-8021-7649fd37fee&displaylang=en>

1.3 Overview

The Print System Asynchronous Remote Protocol provides the following functions:

- Management of the print system of a **print server** from a client.
- Communication of print job data from a client to a print server.
- Notifications to the client of changes in the print server's print system.

Server processing instructions are specified by the parameters that are used in the protocol methods. These parameters include:

- **Printer driver** configuration information.
- The **spool file format** for the print data that is sent by the client.
- The **access level** of the connection.
- The target **print queue** name for name-based methods.
- A handle to the target print queue for handle-based methods.

Status information is communicated back to the client in the return codes from calls that are made to the print server.

The following sections give an overview of these functions.

1.3.1 Management of the Print System

A client can use this protocol to perform remote management operations on a print server. With server access credentials, client applications can manipulate the print server state and print server components, such as printer driver configuration and print queue configuration, or adding printer drivers and printers; they can monitor the print queue status; and they can perform general print server administration.

These operations are supported in the protocol by a set of container structures that are used by different print system components, specifically: DEVMODE_CONTAINER, DRIVER_CONTAINER, FORM_CONTAINER, JOB_CONTAINER, PORT_CONTAINER, SECURITY_CONTAINER, PRINTER_CONTAINER, and SPLCLIENT_CONTAINER. These print system components are supported as specified in [\[MS-RPRN\]](#) section 2.2.1.

To produce printed output that is the same, regardless of the configuration, the printer driver that is installed on the client computer must be identical to or compatible with the printer driver that is installed on the print server. This protocol provides the methods that the client can use after it connects to a printer on a print server to obtain the information about the printer driver that is associated with the printer. If necessary, the client computer can use this information to download the printer driver from the print server.

The client can also use this protocol to obtain detailed information about the settings of the printer and the printer driver that are installed on the server. The client application can use this information to perform layout and to make device-specific choices about paper formats, resolution, and color handling. After the client connects to a printer, this protocol provides the methods that the client can use to query these settings.

The following diagram illustrates this interaction using the scenario of adding a new printer:

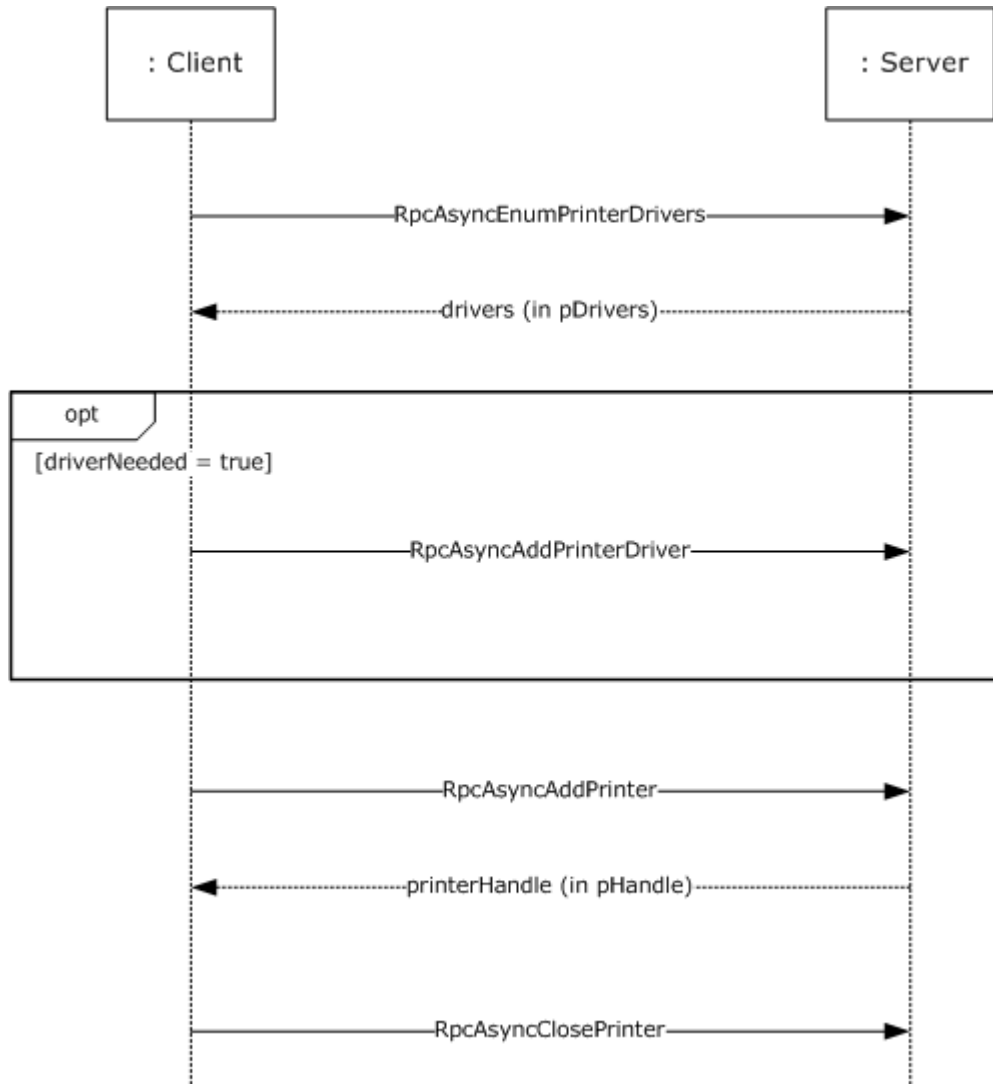

Figure 1: Adding a new printer

1.3.2 Communication of Print Job Data

Communication of print job data enables a client to print to **devices** that are hosted by the print server.

In one configuration, a client uses a printer driver that is installed on the client computer in order to convert a graphical representation of application content and layout into device-specific **page**

description language (PDL) data. It then sends the data, also called RAW data, to the print server using methods this protocol provides. The print server can temporarily store the RAW data from the client in a **spool file**, or it can print it immediately. As the print server sends the data to the target printer, the **print processor** on the print server that is associated with the target printer can post-process the RAW data in an implementation-specific way.

In another configuration, a client sends data to the print server in an intermediate format that contains graphics primitives and layout information as well as processing instructions for the print server. The print server can temporarily store this intermediate data in a spool file, or it can print it immediately. As the data is sent to the printer, the print processor on the print server that is associated with the printer converts the data from the intermediate spool file to device-specific PDL data, typically by using the printer driver that is installed on the print server. <1>

The following diagram illustrates this interaction.

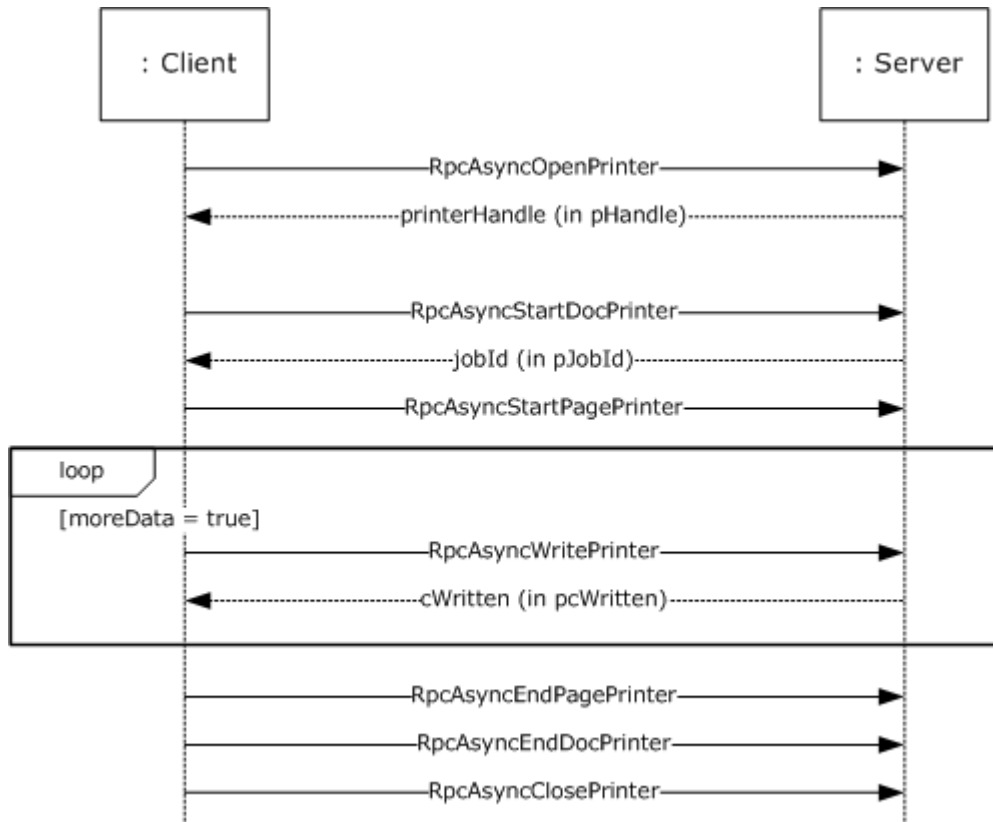

Figure 2: Communication of print job data

1.3.3 Notification of Print System Changes

This protocol also provides the methods that the client can use to register for incremental change notifications. These notifications enable the client application to maintain an accurate local view of the printer and printer driver settings by enabling the client application to synchronize the local view with the actual settings of those components on the print server, without having to repeatedly query the server for its complete configuration information.

A client can register with the print server to receive notifications of changes in a print queue. As long as the client is connected to the print server, it can poll the print server for the current status after it receives a notification.

The application calls [RpcAsyncGetRemoteNotifications \(section 3.1.4.9.4\)](#) to receive notification that something has changed. The server suspends the processing of this call until there are new notifications available on the print server, at which time the server prepares a response and returns from the outstanding **RpcAsyncGetRemoteNotifications** call.

Notifications include status changes of print server resources, for example when a print queue goes online, goes offline, or enters an error state.

The following diagram illustrates this interaction.

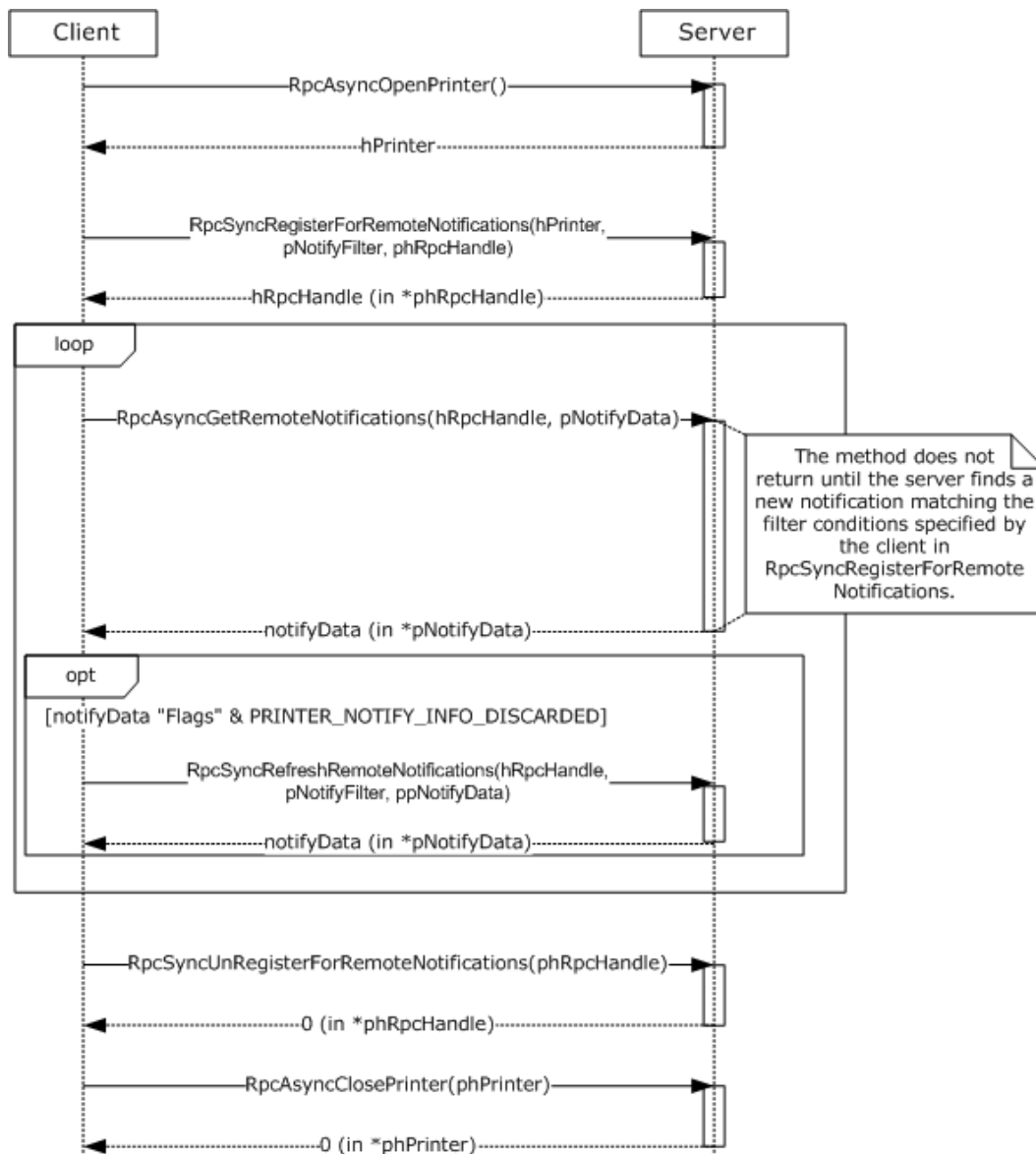

Figure 3: Notification of print system changes

In addition to composing and returning the notifications, the print server maintains a change identifier that changes whenever the server-side printing configuration changes; for example, changes to user-configurable settings, to print queue items, to print job status, or to the printer driver would cause this identifier to change. The client can query this change identifier by calling [RpcAsyncGetPrinterData \(section 3.1.4.1.6\)](#) with the **pValueName** parameter pointing to the string "ChangeID".

When a disconnected client reconnects to the print server, the client can query the change identifier again; if the change identifier is different from the one returned before the client was disconnected, the client can retrieve the complete configuration and update its view of the server configuration. The client retrieves the complete configuration by using the functions for [Management of the Print System \(section 1.3.1\)](#).

1.4 Relationship to Other Protocols

The Print System Asynchronous Remote Protocol is dependent on RPC [\[MS-RPCE\]](#) running on **TCP/IP**. These protocol relationships are shown in the following figure:

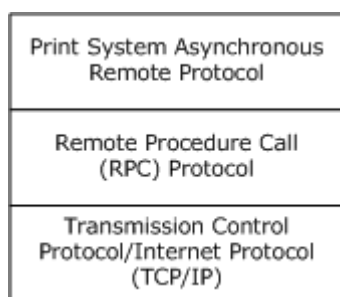

Figure 4: Protocol Relationships

The Print System Asynchronous Remote Protocol references the Print System Remote Protocol [\[MS-RPRN\]](#). Many of the data structures that are used in the Print System Asynchronous Remote Protocol are specified in [\[MS-RPRN\]](#) sections [2.2.1](#) and [2.2.2](#).

Note The implementation of the Print System Remote Protocol is required for all print servers, but a print server can additionally implement the Print System Asynchronous Remote Protocol.

This protocol does not specify methods for file transfer between client and server. The [\[MS-SMB2\]](#) protocol can be used to transfer files between client and server, as in driver download operations.

No protocols are dependent on the Print System Asynchronous Remote Protocol.

1.5 Prerequisites/Preconditions

The Print System Asynchronous Remote Protocol is a remote procedure call (RPC) interface, and therefore it has the prerequisites that are specified in [\[MS-RPCE\]](#) section 1.5, as common to RPC interfaces.

A **print client** is required to obtain the name of a print server that supports this protocol before this protocol is invoked. How a client does that is not addressed in this specification.

1.6 Applicability Statement

The Print System Asynchronous Remote Protocol is applicable only for printing operations between a system functioning as a client and a system functioning as a print server. This protocol scales from home use; to print device sharing between computers; to an enterprise-use scenario that has multiple print servers that are employed in a cluster configuration and client configurations that are managed by a directory access protocol.

1.7 Versioning and Capability Negotiation

This specification covers versioning issues in the following areas:

- **Supported Transports:** The Print System Asynchronous Remote Protocol uses remote procedure call (RPC) over TCP/IP only (section [2.1](#)).
- **Protocol Versions:** This protocol has only one interface version (section [3.1.4](#)).

Versioning of data structures is controlled through the use of information levels specified in container structures ([\[MS-RPRN\]](#) section 2.2.1). Data in a container that is identified by a given information level is typically a superset of the data identified by a lower level. This mechanism is also used in capability negotiation, as described below.

- **Security and Authentication Methods:** This protocol uses **Simple and Protected GSS-API Negotiation Mechanism (SPNEGO)** [\[MS-SPNG\]](#) and RPC packet **authentication levels** for security and authentication (section [2.1](#)). The parameters that are sent from client to server include a "token" ([\[MS-RPCE\]](#) section 2.2.2.12) that defines user credentials. The print server processes that token to verify access permissions.
- **Localization:** This protocol specifies languages and localizable **string resources** for **printer forms** (section [3.1.4.6.1](#)) and printer driver packages (section [3.1.4.2.11](#)).
Localization: The protocol does not contain locale-dependent information.
- **Return Values:** The methods comprising this RPC interface return zero to indicate successful completion and nonzero values to indicate failure. A server implementation of this protocol can return any nonzero value to signify an error condition (section [1.8](#)); however, the client does not interpret it, but simply returns the error code to the invoking application without taking any protocol action.
- **Capability Negotiation:** Functional negotiation in this protocol is supported through the use of information levels ([\[MS-RPRN\]](#) section 2.2.1). On connection to a server, a client requests an information level. If the level is supported by the server, the request is processed; otherwise, the server returns an error, and the client repeats the request with a lower level.

1.8 Vendor-Extensible Fields

The methods defined in the Print System Asynchronous Remote Protocol specify either the DWORD or **HRESULT** data type for return values.

DWORD return values are error codes as specified in [\[MS-ERREF\]](#) section 2.3. Implementers MUST reuse those values with their indicated meanings. Choosing any other value runs the risk of collisions.

HRESULT method return values are used as defined in [\[MS-ERREF\]](#) section 2.3. Implementers MAY<2> choose their own HRESULT values, but the C bit (0x20000000) MUST be set, indicating that it is a customer code.

1.9 Standards Assignments

| Parameter | Value | Reference |
|---|--------------------------------------|---|
| UUID | 76F03F96-CDFD-44FC-A22C-64950A001209 | Section 2.1 and [C706] Appendix A |
| Object UUID for all method calls | 9940CA8E-512F-4C58-88A9-61098D6896BD | [C706] section 2.3 |

2 Messages

2.1 Transport

The Print System Asynchronous Remote Protocol specifies the following transport requirements:

- This protocol MUST use:
 - The transport remote procedure call (RPC) over TCP/IP ([\[MS-RPCE\]](#) section 2.1.1.1).
 - **RPC dynamic endpoints** ([\[C706\]](#) section 4).
 - The UUID that is specified in section [1.9](#).
- A server of this protocol MUST use:
 - A Simple and Protected GSS-API Negotiation Mechanism (SPNEGO) [\[MS-SPNG\]](#) **security provider** ([\[MS-RPCE\]](#) section 3).
 - The default server **principal name** for the security provider, which is the authentication-service constant **RPC_C_AUTHN_GSS_NEGOTIATE**.[<3>](#)
- A client of this protocol MUST use:
 - A SPNEGO [\[MS-SPNG\]](#) security provider.
 - A principal name constructed by appending the name of the print server to the string "host/".
 - Packet authentication level ([\[MS-RPCE\]](#) section 3).
- A server of this protocol SHOULD impersonate the client while processing a method.[<4>](#)

2.2 Common Data Types

In addition to the remote procedure call (RPC) base types and definitions that are specified in [\[C706\]](#) and [\[MS-DTYP\]](#), additional data types are defined in this section.

The Print System Asynchronous Remote Protocol MUST indicate to the RPC runtime that it is to support both the **NDR** and NDR64 transfer syntaxes and provide a negotiation mechanism for determining which transfer syntax is used, as specified in [\[MS-RPCE\]](#) section 3.

This protocol MUST enable the ms_union extension, as specified in [\[MS-RPCE\]](#) section 2.2.4.

The Print System Asynchronous Remote Protocol employs a combination of the following data representations:

- **Interface Definition Language (IDL)** data structures that are used with RPC methods, including structures used as containers for custom C data, as specified in [\[MS-RPRN\]](#) section 2.2.1.
- Custom C data structures and their wire formats as used in custom-marshaled data streams, as specified in [\[MS-RPRN\]](#) section 2.2.2.

The following statements apply to the entire specification, unless noted otherwise:

- All **strings** that are defined in this protocol MUST consist of characters encoded in Unicode **UTF-16LE**, and MUST be null terminated. Each **UTF-16** code point in a **string**, including null terminating characters, MUST occupy 16 bits. The details of these strings are as specified in [\[RFC2781\]](#) section 2.1.
- A list of **strings** is referred to as a **multisz** structure, in which the characters making up the **string** N+1 MUST directly follow the terminating null character of **string** N. The last **string** in a multisz structure MUST be terminated by two null-terminated characters.
- All method parameters and structure members that specify the number of characters in a **string** or multisz structure include the number of terminating null characters.
- The term "NULL" means "a NULL pointer", and "zero" means the number 0.
- All method parameters and structure members that specify the size of a buffer that is pointed to by another parameter or member MUST be zero if the pointer parameter or member is NULL.
- The term "empty string" means a "string" containing only the terminating null character.

2.2.1 EPrintPropertyType

The **EPrintPropertyType** enumeration defines the data types for different printing properties.

```
typedef enum
{
    kPropertyTypeString = 1,
    kPropertyTypeInt32,
    kPropertyTypeInt64,
    kPropertyTypeByte,
    kPropertyTypeTime,
    kPropertyTypeDevMode,
    kPropertyTypeSD,
    kPropertyTypeNotificationReply,
    kPropertyTypeNotificationOptions
} EPrintPropertyType;
```

kPropertyTypeString: The data type is **string**.

kPropertyTypeInt32: The data type is a 32-bit signed integer.

kPropertyTypeInt64: The data type is a 64-bit signed integer.

kPropertyTypeByte: The data type is a **BYTE**.

kPropertyTypeTime: The data type is **SYSTEMTIME_CONTAINER**, as specified in [\[MS-RPRN\]](#) section 2.2.1.2.16.

kPropertyTypeDevMode: The data type is **DEVMODE_CONTAINER**, as specified in [\[MS-RPRN\]](#) section 2.2.1.2.1.

kPropertyTypeSD: The data type is **SECURITY_CONTAINER**, as specified in [\[MS-RPRN\]](#) section 2.2.1.2.13.

kPropertyTypeNotificationReply: The data type is **NOTIFY_REPLY_CONTAINER**, as specified in section [2.2.7](#).

kPropertyTypeNotificationOptions: The data type is **NOTIFY_OPTIONS_CONTAINER**, as specified in section [2.2.6](#).

2.2.2 RpcPrintPropertyValue

The **RpcPrintPropertyValue** structure specifies a data type and its value. Data types are members of the enumeration [EPrintPropertyType](#), specified in section [2.2.1](#).

```
typedef struct {
    EPrintPropertyType ePropertyType;
    [switch_type(EPrintPropertyType), switch_is(ePropertyType)]
    union {
        [case (kPropertyTypeString)]
            [string] wchar_t* propertyString;
        [case (kPropertyTypeInt32)]
            long propertyInt32;
        [case (kPropertyTypeInt64)]
            __int64 propertyInt64;
        [case (kPropertyTypeByte)]
            BYTE propertyByte;
        [case (kPropertyTypeTime)]
            SYSTEMTIME_CONTAINER propertyTimeContainer;
        [case (kPropertyTypeDevMode)]
            DEVMODE_CONTAINER propertyDevModeContainer;
        [case (kPropertyTypeSD)]
            SECURITY_CONTAINER propertySDContainer;
        [case (kPropertyTypeNotificationReply)]
            NOTIFY_REPLY_CONTAINER propertyReplyContainer;
        [case (kPropertyTypeNotificationOptions)]
            NOTIFY_OPTIONS_CONTAINER propertyOptionsContainer;
    } value;
} RpcPrintPropertyValue;
```

ePropertyType: This member MUST be a value from the **EPrintPropertyType** enumeration and MUST specify the data type of the variable.

value: This member MUST specify an information structure that corresponds to the type of property specified by the **ePropertyType** parameter. Information containers and structures are defined in [\[MS-RPRN\]](#) sections [2.2.1](#) and [2.2.2](#).

propertyString: Value is a **string**.

propertyInt32: Value is a 32-bit signed integer.

propertyInt64: Value is a 64-bit signed integer.

propertyByte: Value is a **BYTE**.

propertyTimeContainer: Value is a **SYSTEMTIME_CONTAINER**, specified in [\[MS-RPRN\]](#) section 2.2.1.2.16.

propertyDevModeContainer: Value is a **DEVMODE_CONTAINER**, specified in [\[MS-RPRN\]](#) section 2.2.1.2.1.

propertySDContainer: Value is a **SECURITY_CONTAINER**, specified in [\[MS-RPRN\]](#) section 2.2.1.2.13.

propertyReplyContainer: Value is a **NOTIFY_REPLY_CONTAINER**, specified in section [2.2.7](#).

propertyOptionsContainer: Value is a **NOTIFY_OPTIONS_CONTAINER**, specified in section [2.2.6](#).

2.2.3 RpcPrintNamedProperty

The **RpcPrintNamedProperty** structure specifies a name/typed-value pair that defines a single property.

```
typedef struct {
    [string] wchar_t* propertyName;
    RpcPrintPropertyValue propertyValue;
} RpcPrintNamedProperty;
```

propertyName: A pointer to a string that specifies the name of the property.

propertyValue: Specifies the value of the property.

When used as an input parameter, the **propertyName** and the **ePropertyType** member of **propertyValue** MUST be one of the following pairs:

| propertyName | propertyValue | |
|------------------------------------|----------------------------------|---|
| | ePropertyType | value |
| "RemoteNotifyFilter Flags" | kPropertyTypeInt32 | Same as fdwFlags , as specified in [MS-RPRN] section 3.1.4.10.4. |
| "RemoteNotifyFilter Options" | kPropertyTypeInt32 | Same as fdwOptions , as specified in [MS-RPRN] section 3.1.4.10.4. |
| "RemoteNotifyFilter NotifyOptions" | kPropertyTypeNotificationOptions | Same as pOptions , as specified in [MS-RPRN] section 3.1.4.10.4. |
| "RemoteNotifyFilter Color" | kPropertyTypeInt32 | Same as dwColor , as specified in [MS-RPRN] section 3.1.4.10.5. |

When used as an output parameter, the **propertyName** and the **ePropertyType** member of **propertyValue** MUST be one of the following pairs:

| propertyName | propertyValue | |
|--------------------------|--------------------------------|---|
| | ePropertyType | value |
| "RemoteNotifyData Flags" | kPropertyTypeInt32 | Same as fdwFlags , as specified in [MS-RPRN] section 3.2.4.1.4. |
| "RemoteNotifyData Info" | kPropertyTypeNotificationReply | Same as the pInfo member of the Reply union, as specified in [MS-RPRN] section 3.2.4.1.4. |
| "RemoteNotifyData Color" | kPropertyTypeInt32 | Same as dwColor , as specified in [MS-RPRN] section 3.2.4.1.4. |

2.2.4 RpcPrintPropertiesCollection

The **RpcPrintPropertiesCollection** structure MUST hold a collection of name/typed-value pairs.

```
typedef struct {
    [range(0,50)] DWORD numberOfProperties;
    [size_is(numberOfProperties), unique]
    RpcPrintNamedProperty* propertiesCollection;
} RpcPrintPropertiesCollection;
```

numberOfProperties: MUST contain a value that specifies the number of properties in the collection, and it MUST be between 0 and 50, inclusive.

propertiesCollection: MUST be a pointer to an array of **RpcPrintNamedProperty** values.

When used as input to specify notification filter settings, the following properties MUST be present in the collection pointed to by the **propertiesCollection** member:

- "RemoteNotifyFilter Flags"
- "RemoteNotifyFilter Options"
- "RemoteNotifyFilter NotifyOptions"
- "RemoteNotifyFilter Color"

When used as output to return notification data, the following properties MUST be present in the collection pointed to by the **propertiesCollection** member:

- "RemoteNotifyData Flags"
- "RemoteNotifyData Info"
- "RemoteNotifyData Color"

2.2.5 RMTNTFY_HANDLE

The **RMTNTFY_HANDLE** serves as an remote procedure call (RPC) context handle for methods that take an **RMTNTFY_HANDLE** parameter. **RPC context handles** are as specified in [\[C706-Ch2Intro\]](#) and [\[C706-Ch6RPCCallModel\]](#).

This type is declared as follows:

```
typedef [context_handle] void* RMTNTFY_HANDLE;
```

The **RMTNTFY_HANDLE** context handle is returned by [RpcSyncRegisterForRemoteNotifications](#).

2.2.6 NOTIFY_OPTIONS_CONTAINER

The **NOTIFY_OPTIONS_CONTAINER** structure encapsulates an **RPC_V2_NOTIFY_OPTIONS** structure, which specifies options for a change notification object that monitors a printer or print server for changes in state. For more information, see [\[MS-RPRN\]](#) section 2.2.1.13.1.

```
typedef struct _NOTIFY_OPTIONS_CONTAINER {
    RPC_V2_NOTIFY_OPTIONS* pOptions;
} NOTIFY_OPTIONS_CONTAINER;
```

pOptions: A pointer to an **RPC_V2_NOTIFY_OPTIONS** structure, as specified in [\[MS-RPRN\]](#) section 2.2.1.13.1.

2.2.7 NOTIFY_REPLY_CONTAINER

The **NOTIFY_REPLY_CONTAINER** structure encapsulates an **RPC_V2_NOTIFY_INFO** structure, which provides printer information members and current data for those members. For details, see [\[MS-RPRN\]](#) section 2.2.1.13.3.

```
typedef struct _NOTIFY_REPLY_CONTAINER {
    RPC_V2_NOTIFY_INFO* pInfo;
} NOTIFY_REPLY_CONTAINER;
```

pInfo: A pointer to an **RPC_V2_NOTIFY_INFO** structure, as specified in [\[MS-RPRN\]](#) section 2.2.1.13.3.

2.2.8 CORE_PRINTER_DRIVER

The **CORE_PRINTER_DRIVER** structure specifies information that identifies a specific **core printer driver**. See the [RpcAsyncGetCorePrinterDrivers \(section 3.1.4.2.9\)](#) method for an example of its use.

```
typedef struct _CORE_PRINTER_DRIVER {
    GUID CoreDriverGUID;
    FILETIME ftDriverDate;
    DWORDLONG dwlDriverVersion;
    wchar_t szPackageID[260];
} CORE_PRINTER_DRIVER;
```

CoreDriverGUID: A GUID, as defined in [\[MS-DTYP\]](#) sections [2.3.4](#), [2.3.4.2](#), and [2.3.4.3](#), value that uniquely identifies the package.

ftDriverDate: A [FILETIME](#) value that specifies the date this package was published.

dwlDriverVersion: A 64-bit value that specifies the version of the core printer driver. This version number MAY be used to match the driver version in the driver installation control file. [<5>](#)

szPackageID: A **string** that specifies the package name. The server MUST generate a unique package name when the package is uploaded using the [RpcAsyncUploadPrinterDriverPackage \(section 3.1.4.2.8\)](#) method. The length of the

string MUST not exceed the maximum path size, which is 260 characters, including a null-terminated character.

3 Protocol Details

3.1 IRemoteWinspool Server Details

The Print System Asynchronous Remote protocol server interface, [IRemoteWinspool](#), is identified by UUID 76F03F96-CDFD-44FC-A22C-64950A001209. The server implementation MUST only accept remote procedure call (RPC) method calls with the object UUID 9940CA8E-512F-4C58-88A9-61098D6896BD and reject all other method calls.

3.1.1 Abstract Data Model

This section describes a conceptual model of a possible data organization that an implementation might need to maintain in order to participate in this protocol. The organization that is described in this section is provided to facilitate the explanation of how the protocol behaves. This specification does not mandate that implementations adhere to this model as long as their external behavior is consistent with the behavior described in this specification.

This protocol depends on an abstract data model that maintains information about printers and related objects. These objects represent physical output devices, and they are used in the protocol to communicate with those devices, to print to them, and to manage their configurations.

A print server behaves as if it hosted the following objects in the hierarchy specified in the abstract data model for the Print System Remote Protocol ([\[MS-RPRN\]](#) section 3.1.1). Each of the following objects is described in more detail in [\[MS-RPRN\]](#) section 3.1.1.

Note A print server maintains only one copy of the data underlying the implementation that exposes [\[MS-RPRN\]](#) or [\[MS-PAR\]](#).

- **List of Print Server Names**
- **List of Form Objects**
- **List of Printers**
- **List of Printer Drivers**
- **List of Core Printer Drivers**
- **List of Language Monitors**
- **List of Port Monitors**
- **List of Ports**
- **List of Print Providers**
- **List of Print Processors**
- **List of Known Printers**
- **List of Notification Clients**
- **Job Named Properties**[<6>](#)
- **Branch Office Print Remote Log Entries**[<7>](#)

The abstract data model associates each printer with a single printer driver, a single printer **port**, and exactly one print processor. Every object stored in the abstract data model defines an associated set of attributes, as specified in [MS-RPRN] [IDL Data Types \(section 2.2.1\)](#) and [Custom-Marshaled Data Types \(section 2.2.2\)](#).

Note The previous conceptual data can be implemented using a variety of techniques. A print server can implement such data as needed.

3.1.2 Timers

No protocol timers are required on the server other than those that are used internally by remote procedure call (RPC) to implement resiliency to network outages, as specified in [\[MS-RPCE\]](#) section 3.2.3.2.

3.1.3 Initialization

The server SHOULD listen on **well-known endpoints** that are defined for this remote procedure call (RPC) interface. For more information, see section [2.1](#).

3.1.4 Message Processing Events and Sequencing Rules

An implementation of the Print System Asynchronous Remote Protocol MUST indicate the following to the remote procedure call (RPC) runtime ([\[MS-RPCE\]](#) section 3).

- It is to perform a strict NDR data consistency check at target level 6.0.
- It is to reject a NULL unique or full pointer with nonzero conformant value, as specified in [\[MS-RPCE\]](#) section 3.
- Using the **strict_context_handle** attribute, it is to reject the use of context handles that are created by the methods of a different RPC interface (see [\[MS-RPCE\]](#) section 2.2.4.15).

The methods that are defined by this protocol are grouped into functional categories, and their syntax and behavior are specified in sections, as shown in the following table. Most methods described in these sections have functional equivalents in the Print System Remote Protocol ([\[MS-RPRN\]](#) section 3.1.4).

| Functional category | Description | Section |
|----------------------------|---|-------------------------|
| Printer management | Methods used for discovering and obtaining access to supported printers. | 3.1.4.1 |
| Printer driver management | Methods for discovering and installing printer drivers. | 3.1.4.2 |
| Printer port management | Methods for discovering and communicating with printer ports. | 3.1.4.3 |
| Print-processor management | Methods for discovering and manipulating print-processor objects. | 3.1.4.4 |
| Port monitor management | Methods for discovering and installation of port monitor modules . | 3.1.4.5 |
| Form management | Methods for discovering and configuring printer forms. | 3.1.4.6 |
| Job management | Methods for discovering, defining, and scheduling print jobs. | 3.1.4.7 |
| Job printing | Methods for adding documents, pages, and data to print jobs. | 3.1.4.8 |

| Functional category | Description | Section |
|---|--|--------------------------|
| Printing-related notifications | Methods for obtaining notifications of printing events. | 3.1.4.9 |
| Job named property management | Methods for creating, updating, deleting, and enumerating Job Named Properties (section 3.1.1).<8> | 3.1.4.10 |
| Branch office print remote logging | Methods for processing Branch Office Print Remote Log Entries (section 3.1.1).<9> | 3.1.4.11 |

The following table lists all the methods of the Print System Asynchronous Remote Protocol in ascending order of their **opnums**.

Methods in RPC Opnum Order

| Method | Description |
|-------------------------------------|---|
| RpcAsyncOpenPrinter | RpcAsyncOpenPrinter retrieves a handle to a specified printer, port, print job or print server. A client uses this method to obtain a print handle to an existing printer on a remote computer. The counterpart of this method in the Print System Remote Protocol is RpcOpenPrinterEx . All parameters not defined below are specified in [MS-RPRN] section 3.1.4.2.14. Opnum: 0 |
| RpcAsyncAddPrinter | RpcAsyncAddPrinter installs a printer on the print server. The counterpart of this method in the Print System Remote Protocol is RpcAddPrinterEx . All parameters not defined below are specified in [MS-RPRN] section 3.1.4.2.15. Opnum: 1 |
| RpcAsyncSetJob | RpcAsyncSetJob pauses, resumes, cancels, or restarts a print job on a specified printer. This method also can set print job parameters, including the job priority and document name. Opnum: 2 |
| RpcAsyncGetJob | RpcAsyncGetJob retrieves information about a specified print job on a specified printer. Opnum: 3 |
| RpcAsyncEnumJobs | RpcAsyncEnumJobs retrieves information about a specified set of print jobs on a specified printer. Opnum: 4 |
| RpcAsyncAddJob | RpcAsyncAddJob returns ERROR_INVALID_PARAMETER . Opnum: 5 |
| RpcAsyncScheduleJob | RpcAsyncScheduleJob returns ERROR_SPL_NO_ADDJOB . |

| Method | Description |
|--|---|
| | Opnum: 6 |
| RpcAsyncDeletePrinter | RpcAsyncDeletePrinter deletes the specified printer object. The client MUST still call RpcAsyncClosePrinter (section 3.1.4.1.10) with the same PRINTER_HANDLE after calling RpcAsyncDeletePrinter . Opnum: 7 |
| RpcAsyncSetPrinter | RpcAsyncSetPrinter sets the state of a specified printer. Opnum: 8 |
| RpcAsyncGetPrinter | RpcAsyncGetPrinter retrieves information about a specified printer. Opnum: 9 |
| RpcAsyncStartDocPrinter | RpcAsyncStartDocPrinter notifies a specified printer that a document is being spooled for printing. Opnum: 10 |
| RpcAsyncStartPagePrinter | RpcAsyncStartPagePrinter notifies a specified printer that a page is about to be printed. Opnum: 11 |
| RpcAsyncWritePrinter | RpcAsyncWritePrinter adds data to the file representing the spool file for a specified printer, if the spooling option is turned on; or it sends data to the device directly, if the printer is configured for direct printing. Opnum: 12 |
| RpcAsyncEndPagePrinter | RpcAsyncEndPagePrinter notifies a specified printer that the application is at the end of a page in a print job. Opnum: 13 |
| RpcAsyncEndDocPrinter | RpcAsyncEndDocPrinter signals the completion of the current print job on a specified printer. Opnum: 14 |
| RpcAsyncAbortPrinter | RpcAsyncAbortPrinter aborts the current document on a specified printer. Opnum: 15 |
| RpcAsyncGetPrinterData | RpcAsyncGetPrinterData retrieves configuration data from a specified printer or print server. Opnum: 16 |
| RpcAsyncGetPrinterDataEx | RpcAsyncGetPrinterDataEx retrieves configuration data for the specified printer or print server. This method extends RpcAsyncGetPrinterData (section 3.1.4.1.6) and can retrieve values stored under a |

| Method | Description |
|---|--|
| | specified key by RpcAsyncSetPrinterDataEx (section 3.1.4.1.9) . Opnum: 17 |
| RpcAsyncSetPrinterData | RpcAsyncSetPrinterData sets the configuration data for a printer or print server. Opnum: 18 |
| RpcAsyncSetPrinterDataEx | RpcAsyncSetPrinterDataEx sets the configuration data for a printer or print server. This method is similar to RpcAsyncSetPrinterData (section 3.1.4.1.8) but also allows the caller to specify the registry key under which to store the data. Opnum: 19 |
| RpcAsyncClosePrinter | RpcAsyncClosePrinter closes a handle to a printer object, server object, job object, or port object, which is opened by calling RpcAsyncOpenPrinter (section 3.1.4.1.1) or RpcAsyncAddPrinter (section 3.1.4.1.2). Opnum: 20 |
| RpcAsyncAddForm | RpcAsyncAddForm adds a form name to the list of supported forms. Opnum: 21 |
| RpcAsyncDeleteForm | RpcAsyncDeleteForm removes a form name from the list of supported forms. Opnum: 22 |
| RpcAsyncGetForm | RpcAsyncGetForm retrieves information about a specified form. Opnum: 23 |
| RpcAsyncSetForm | RpcAsyncSetForm sets the form information for the specified printer. Opnum: 24 |
| RpcAsyncEnumForms | RpcAsyncEnumForms enumerates the forms that the specified printer supports. Opnum: 25 |
| RpcAsyncGetPrinterDriver | RpcAsyncGetPrinterDriver retrieves data about a specified printer driver on a specified printer. Opnum: 26 |
| RpcAsyncEnumPrinterData | RpcAsyncEnumPrinterData enumerates configuration data for a specified printer. Opnum: 27 |
| RpcAsyncEnumPrinterDataEx | RpcAsyncEnumPrinterDataEx enumerates all value names and data for a specified printer and key. This method extends RpcAsyncEnumPrinterData (section 3.1.4.1.11) by retrieving several values in a single call. |

| Method | Description |
|--|---|
| | Opnum: 28 |
| RpcAsyncEnumPrinterKey | RpcAsyncEnumPrinterKey enumerates the subkeys of a specified key for a specified printer. Opnum: 29 |
| RpcAsyncDeletePrinterData | RpcAsyncDeletePrinterData deletes a specified value from the configuration of a specified printer. Opnum: 30 |
| RpcAsyncDeletePrinterDataEx | RpcAsyncDeletePrinterDataEx deletes a specified value from the configuration of a specified printer. This method is similar to RpcAsyncDeletePrinterData (section 3.1.4.1.14) but accesses the configuration data using a set of named and typed values that are stored in a hierarchy of registry keys. Opnum: 31 |
| RpcAsyncDeletePrinterKey | RpcAsyncDeletePrinterKey deletes a specified key and all its subkeys from the configuration of a specified printer. Opnum: 32 |
| RpcAsyncXcvData | RpcAsyncXcvData provides the means by which a port monitor client component can communicate with its server-side counterpart, the actual port monitor that is hosted by the server. Opnum: 33 |
| RpcAsyncSendRecvBidiData | RpcAsyncSendRecvBidiData sends and receives bidirectional data. This method is used to communicate with print monitors that support such data. Opnum: 34 |
| RpcAsyncCreatePrinterIC | RpcAsyncCreatePrinterIC creates an information context on a specified printer. Opnum: 35 |
| RpcAsyncPlayGdiScriptOnPrinterIC | RpcAsyncPlayGdiScriptOnPrinterIC queries fonts for printer connections. Opnum: 36 |
| RpcAsyncDeletePrinterIC | RpcAsyncDeletePrinterIC deletes a printer information context. Opnum: 37 |
| RpcAsyncEnumPrinters | RpcAsyncEnumPrinters enumerates available local printers, printers on a specified print server, printers in a specified domain , or print providers . Opnum: 38 |
| RpcAsyncAddPrinterDriver | RpcAsyncAddPrinterDriver installs a specified local or a remote printer driver on a specified print server, |

| Method | Description |
|--|--|
| | and it links the configuration, data, and driver files. Opnum: 39 |
| RpcAsyncEnumPrinterDrivers | RpcAsyncEnumPrinterDrivers enumerates the printer drivers installed on a specified print server. Opnum: 40 |
| RpcAsyncGetPrinterDriverDirectory | RpcAsyncGetPrinterDriverDirectory retrieves the path of the printer-driver directory on a specified print server. Opnum: 41 |
| RpcAsyncDeletePrinterDriver | RpcAsyncDeletePrinterDriver removes the specified printer driver from the list of supported drivers for a specified print server. Opnum: 42 |
| RpcAsyncDeletePrinterDriverEx | RpcAsyncDeletePrinterDriverEx removes the specified printer driver from the list of supported drivers on a specified print server, and deletes the files associated with the driver. This method is similar to RpcAsyncDeletePrinterDriver (section 3.1.4.2.5) but can also delete specific versions of the driver. Opnum: 43 |
| RpcAsyncAddPrintProcessor | RpcAsyncAddPrintProcessor installs a specified print processor on the specified server and adds its name to an internal list of supported print processors. Opnum: 44 |
| RpcAsyncEnumPrintProcessors | RpcAsyncEnumPrintProcessors enumerates the print processors installed on a specified server. Opnum: 45 |
| RpcAsyncGetPrintProcessorDirectory | RpcAsyncGetPrintProcessorDirectory retrieves the path for the print processor on the specified server. Opnum: 46 |
| RpcAsyncEnumPorts | RpcAsyncEnumPorts enumerates the ports that are available for printing on a specified server. Opnum: 47 |
| RpcAsyncEnumMonitors | RpcAsyncEnumMonitors retrieves information about the port monitors installed on a specified server. Opnum: 48 |
| RpcAsyncAddPort | RpcAsyncAddPort adds a specified port name to the list of supported ports on a specified server. Opnum: 49 |
| RpcAsyncSetPort | RpcAsyncSetPort sets the status associated with a specified port on a specified print server. Opnum: 50 |

| Method | Description |
|---|---|
| RpcAsyncAddMonitor | RpcAsyncAddMonitor installs a specified local port monitor, and links the configuration, data, and monitor files on a specified print server. Opnum: 51 |
| RpcAsyncDeleteMonitor | RpcAsyncDeleteMonitor removes a specified port monitor from a specified print server. Opnum: 52 |
| RpcAsyncDeletePrintProcessor | RpcAsyncDeletePrintProcessor removes a specified print processor from a specified server. Opnum: 53 |
| RpcAsyncEnumPrintProcessorDatatypes | RpcAsyncEnumPrintProcessorDatatypes enumerates the data types that a specified print processor supports. Opnum: 54 |
| RpcAsyncAddPerMachineConnection | RpcAsyncAddPerMachineConnection persistently saves the configuration information for a connection, including the print server name and the name of the print providers for a specified connection. Opnum: 55 |
| RpcAsyncDeletePerMachineConnection | RpcAsyncDeletePerMachineConnection deletes the stored connection configuration information that corresponds to the pPrinterName parameter value. Opnum: 56 |
| RpcAsyncEnumPerMachineConnections | RpcAsyncEnumPerMachineConnections enumerates each of the per-machine connections into a specified buffer. Opnum: 57 |
| RpcSyncRegisterForRemoteNotifications | RpcSyncRegisterForRemoteNotifications opens a notification handle by using a printer handle or print server handle, to listen for remote printer change notifications. Opnum: 58 |
| RpcSyncUnRegisterForRemoteNotifications | RpcSyncUnRegisterForRemoteNotifications closes a notification handle that is opened by calling RpcSyncRegisterForRemoteNotifications (section 3.1.4.9.1). Opnum: 59 |
| RpcSyncRefreshRemoteNotifications | RpcSyncRefreshRemoteNotifications gets notification information for all requested members. This is called by a client if the "RemoteNotifyData Flags" property in the RpcPrintPropertiesCollection (section 2.2.4) instance, which was returned as part of the notification from an RpcAsyncGetRemoteNotifications (section 3.1.4.9.4) call, has the |

| Method | Description |
|---|--|
| | PRINTER_NOTIFY_INFO_DISCARDED bit set ([MS-RPRN] section 2.2.3.2). Opnum: 60 |
| RpcAsyncGetRemoteNotifications | RpcAsyncGetRemoteNotifications is used to poll the print server for specified change notifications. A call to this method is suspended until the server has a new change notification for the client. Subsequently, the client calls this method again to poll for additional notifications from the server. Opnum: 61 |
| RpcAsyncInstallPrinterDriverFromPackage | RpcAsyncInstallPrinterDriverFromPackage installs a printer driver from a driver package . Opnum: 62 |
| RpcAsyncUploadPrinterDriverPackage | RpcAsyncUploadPrinterDriverPackage uploads a driver package so it can be installed with RpcAsyncInstallPrinterDriverFromPackage . Opnum: 63 |
| RpcAsyncGetCorePrinterDrivers | RpcAsyncGetCorePrinterDrivers retrieves the globally unique identifier (GUID) , the version, the date of the specified core printer drivers, and the path to their packages. Opnum: 64 |
| RpcAsyncCorePrinterDriverInstalled | RpcAsyncCorePrinterDriverInstalled determines if a specific core printer driver is installed. Opnum: 65 |
| RpcAsyncGetPrinterDriverPackagePath | RpcAsyncGetPrinterDriverPackagePath gets the path to the specified printer driver package. Opnum: 66 |
| RpcAsyncDeletePrinterDriverPackage | RpcAsyncDeletePrinterDriverPackage deletes a specified printer driver package. Opnum: 67 |
| RpcAsyncReadPrinter | RpcAsyncReadPrinter retrieves data from the specified job object. Opnum: 68 |
| RpcAsyncResetPrinter | RpcAsyncResetPrinter resets the data type and device mode values to use for printing documents that are submitted by the RpcAsyncStartDocPrinter (section 3.1.4.8.1) method. Opnum: 69 |
| RpcAsyncGetJobNamedPropertyValue | RpcAsyncGetJobNamedPropertyValue retrieves the value of the specified Job Named Property (section 3.1.1) for the specified print job. Opnum: 70 |

| Method | Description |
|---|--|
| RpcAsyncSetJobNamedProperty | RpcAsyncSetJobNamedProperty creates a new Job Named Property or changes the value of an existent Job Named Property for the specified print job. Opnum: 71 |
| RpcAsyncDeleteJobNamedProperty | RpcAsyncDeleteJobNamedProperty deletes a Job Named Property for the specified print job. Opnum: 72 |
| RpcAsyncEnumJobNamedProperties | RpcAsyncEnumJobNamedProperties enumerates the Job Named Properties for the specified print job. Opnum: 73 |
| RpcAsyncLogJobInfoForBranchOffice | RpcAsyncLogJobInfoForBranchOffice processes one or more Branch Office Print Remote Log Entries (section 3.1.1) by writing them to the Microsoft-Windows-PrintService/Admin and Microsoft-Windows-PrintService/Operations event channels . Opnum: 74 |

All methods that are defined in this protocol are request/response RPC methods. Each method specifies either a [DWORD](#) or [HRESULT](#) data type for its return value. **DWORD** return values are error codes specified in section [2.2](#) of [\[MS-ERREF\]](#). A return value of zero indicates successful completion, and a nonzero value indicates failure, with exceptions specified later in this section.

A non-negative **HRESULT** return value indicates successful completion, and a negative value indicates failure ([\[MS-ERREF\]](#) section 2.1).

"ERROR_MORE_DATA" and "ERROR_INSUFFICIENT_BUFFER" are two nonzero return codes that have specific meanings in this protocol. When a method declaration in this specification has an output parameter that returns a required buffer size, the method can return one of the values from the following table. When calling a method that has one of these output parameters, the caller SHOULD NOT treat these return values as errors. The caller SHOULD use the data returned by the method, to learn the required buffer size and to resize the buffers. The caller SHOULD call the method again by using the resized buffers. These cases are noted in the method definitions in this section or in their corresponding method definitions of [\[MS-RPRN\]](#) section 3.1.4.

| Name/Value | Meaning |
|---|--|
| ERROR_INSUFFICIENT_BUFFER 0x0000007A | The buffer size specified in a method call is too small. |
| ERROR_MORE_DATA 0x000000EA | More data is available. |

3.1.4.1 Printer Management Methods

The Printer Management methods support the discovery, access, and configuration of printer and print server objects. The following table presents a list of printer management methods and their counterparts in the Print System Remote Protocol [\[MS-RPRN\]](#). All methods are specified in sections that follow.

Parameter descriptions, parameter validation, and processing and response requirements that are not specified in methods of the Print System Asynchronous Remote protocol [MS-PAR] are specified in the corresponding methods of the Print System Remote protocol [MS-RPRN].

| [MS-PAR] method | Description | Corresponding [MS-RPRN] method |
|--|--|-------------------------------------|
| RpcAsyncOpenPrinter | RpcAsyncOpenPrinter retrieves a handle to a specified printer or print server. A client uses this method to obtain a print handle to an existing printer on a remote machine. Opnum 0 | RpcOpenPrinterEx |
| RpcAsyncAddPrinter | RpcAsyncAddPrinter installs a printer on the print server. The counterpart of this method in the Print System Remote Protocol is RpcAddPrinterEx . All parameters not defined below are specified in [MS-RPRN] RpcAddPrinterEx . Opnum 1 | RpcAddPrinterEx |
| RpcAsyncDeletePrinter | RpcAsyncDeletePrinter deletes the specified printer object. The client MUST still call RpcAsyncClosePrinter (section 3.1.4.1.10) with the same PRINTER_HANDLE after calling RpcAsyncDeletePrinter . Opnum 7 | RpcDeletePrinter |
| RpcAsyncSetPrinter | RpcAsyncSetPrinter sets the state of a specified printer, optionally by performing an action to change the state. Opnum 8 | RpcSetPrinter |
| RpcAsyncGetPrinter | RpcAsyncGetPrinter retrieves information about a specified printer. Opnum 9 | RpcGetPrinter |
| RpcAsyncGetPrinterData | RpcAsyncGetPrinterData retrieves printer data from a specified printer or print server. Opnum 16 | RpcGetPrinterData |
| RpcAsyncGetPrinterDataEx | RpcAsyncGetPrinterDataEx retrieves configuration data for the specified printer or print server. Opnum 17 | RpcGetPrinterDataEx |
| RpcAsyncSetPrinterData | RpcAsyncSetPrinterData sets the configuration data for a printer or print server. | RpcSetPrinterData |

| [MS-PAR] method | Description | Corresponding [MS-RPRN] method |
|---|--|--|
| | Opnum 18 | |
| RpcAsyncSetPrinterDataEx | RpcAsyncSetPrinterDataEx sets the configuration data for a printer or print server. Opnum 19 | RpcSetPrinterDataEx |
| RpcAsyncClosePrinter | RpcAsyncClosePrinter closes a handle to a printer object, server object, job object or port object, opened by calling RpcAsyncOpenPrinter or RpcAsyncAddPrinter . Opnum 20 | RpcClosePrinter |
| RpcAsyncEnumPrinterData | RpcAsyncEnumPrinterData enumerates configuration data for a specified printer. Opnum 27 | RpcEnumPrinterData |
| RpcAsyncEnumPrinterDataEx | RpcAsyncEnumPrinterDataEx enumerates all value names and data for a specified printer and key. Opnum 28 | RpcEnumPrinterDataEx |
| RpcAsyncEnumPrinterKey | RpcAsyncEnumPrinterKey enumerates the subkeys of a specified key for a specified printer. Opnum 29 | RpcEnumPrinterKey |
| RpcAsyncDeletePrinterData | RpcAsyncDeletePrinterData deletes a specified value from the configuration of a specified printer. Opnum 30 | RpcDeletePrinterData |
| RpcAsyncDeletePrinterDataEx | RpcAsyncDeletePrinterDataEx deletes a specified value from the configuration data of a specified printer, which consists of a set of named and typed values stored in a hierarchy of registry keys. Opnum 31 | RpcDeletePrinterDataEx |
| RpcAsyncDeletePrinterKey | RpcAsyncDeletePrinterKey deletes a specified key and all of its subkeys from the configuration of a specified printer. Opnum 32 | RpcDeletePrinterKey |
| RpcAsyncSendRecvBidiData | RpcAsyncSendRecvBidiData sends and receives bidirectional data. This method is used to communicate with print monitors that support such data. | RpcSendRecvBidiData |

| [MS-PAR] method | Description | Corresponding [MS-RPRN] method |
|--|--|---|
| | Opnum 34 | |
| RpcAsyncCreatePrinterIC | RpcAsyncCreatePrinterIC creates an information context on a specified printer. Opnum 35 | RpcCreatePrinterIC |
| RpcAsyncPlayGdiScriptOnPrinterIC | RpcAsyncPlayGdiScriptOnPrinterIC queries fonts for printer connections. Opnum 36 | RpcPlayGdiScriptOnPrinterIC |
| RpcAsyncDeletePrinterIC | RpcAsyncDeletePrinterIC deletes a printer information context. Opnum 37 | RpcDeletePrinterIC |
| RpcAsyncEnumPrinters | RpcAsyncEnumPrinters enumerates available local printers, printers on a specified print server, printers in a specified domain, or print providers. Opnum 38 | RpcEnumPrinters |
| RpcAsyncAddPerMachineConnection | RpcAsyncAddPerMachineConnection persistently saves the configuration information for a connection, including the print server name and the name of the print provider for a specified connection. Opnum 55 | RpcAddPerMachineConnection |
| RpcAsyncDeletePerMachineConnection | RpcAsyncDeletePerMachineConnection deletes the stored connection configuration information that corresponds to the pPrinterName parameter value. Opnum 56 | RpcDeletePerMachineConnection |
| RpcAsyncEnumPerMachineConnections | RpcAsyncEnumPerMachineConnections enumerates each of the per-machine connections into a specified buffer. Opnum 57 | RpcEnumPerMachineConnections |
| RpcAsyncResetPrinter | RpcAsyncResetPrinter resets the data type and device mode values to use for printing documents submitted by the RpcAsyncStartDocPrinter (section 3.1.4.8.1) method. Opnum 69 | RpcResetPrinter |

3.1.4.1.1 RpcAsyncOpenPrinter (Opnum 0)

RpcAsyncOpenPrinter retrieves a handle to a specified printer, port, print job or print server. A client uses this method to obtain a print handle to an existing printer on a remote computer.

The counterpart of this method in the Print System Remote Protocol is **RpcOpenPrinterEx**. All parameters not defined below are specified in [\[MS-RPRN\]](#) section 3.1.4.2.14.

```
DWORD RpcAsyncOpenPrinter(  
    [in] handle_t hRemoteBinding,  
    [in, string, unique] wchar_t* pPrinterName,  
    [out] PRINTER_HANDLE* pHandle,  
    [in, string, unique] wchar_t* pDatatype,  
    [in] DEVMODE_CONTAINER* pDevModeContainer,  
    [in] DWORD AccessRequired,  
    [in] SPLCLIENT_CONTAINER* pClientInfo  
);
```

hRemoteBinding: An RPC explicit binding handle.

Return Values: This method MUST return zero to indicate successful completion or a nonzero Win32 error code ([\[MS-ERREF\]](#) section 2.2) to indicate failure. The client MUST treat any nonzero return value as a fatal error.

Exceptions Thrown: This method MUST NOT throw any exceptions other than those that are thrown by the underlying RPC protocol [\[MS-RPCE\]](#).

This method MUST adhere to the parameter validation, processing, and response requirements that are specified in [\[MS-RPRN\]](#) section 3.1.4.2.14.

3.1.4.1.2 RpcAsyncAddPrinter (Opnum 1)

RpcAsyncAddPrinter installs a printer on the print server.

The counterpart of this method in the Print System Remote Protocol is **RpcAddPrinterEx**. All parameters not defined below are specified in [\[MS-RPRN\]](#) section 3.1.4.2.15.

```
DWORD RpcAsyncAddPrinter(  
    [in] handle_t hRemoteBinding,  
    [in, string, unique] wchar_t* pName,  
    [in] PRINTER_CONTAINER* pPrinterContainer,  
    [in] DEVMODE_CONTAINER* pDevModeContainer,  
    [in] SECURITY_CONTAINER* pSecurityContainer,  
    [in] SPLCLIENT_CONTAINER* pClientInfo,  
    [out] PRINTER_HANDLE* pHandle  
);
```

hRemoteBinding: An RPC explicit binding handle.

Return Values: This method MUST return zero to indicate successful completion or a nonzero Win32 error code ([\[MS-ERREF\]](#) section 2.2) to indicate failure. The client MUST treat any nonzero return value as a fatal error.

Exceptions Thrown: This method MUST NOT throw any exceptions other than those that are thrown by the underlying RPC protocol [\[MS-RPCE\]](#).

This method MUST adhere to the parameter validation, processing, and response requirements that are specified in [\[MS-RPRN\]](#) section 3.1.4.2.15.

3.1.4.1.3 RpcAsyncDeletePrinter (Opnum 7)

RpcAsyncDeletePrinter deletes the specified printer object.

The counterpart of this method in the Print System Remote Protocol is **RpcDeletePrinter**. All parameters not defined below are specified in [\[MS-RPRN\]](#) section 3.1.4.2.4.

The client MUST still call [RpcAsyncClosePrinter](#) with the [PRINTER_HANDLE](#) represented by the *hPrinter* parameter after calling **RpcAsyncDeletePrinter**.

```
DWORD RpcAsyncDeletePrinter(  
    [in] PRINTER_HANDLE hPrinter  
);
```

hPrinter: A handle to a printer object that has been opened using either [RpcAsyncOpenPrinter \(section 3.1.4.1.1\)](#) or [RpcAsyncAddPrinter \(section 3.1.4.1.2\)](#).

Return Values: This method MUST return zero to indicate successful completion or a nonzero Win32 error code ([\[MS-ERREF\]](#) section 2.2) to indicate failure. The client MUST treat any nonzero return value as a fatal error.

Exceptions Thrown: This method MUST NOT throw any exceptions other than those that are thrown by the underlying RPC protocol [\[MS-RPCE\]](#).

This method MUST adhere to the parameter validation, processing, and response requirements that are specified in [\[MS-RPRN\]](#) section 3.1.4.2.4.

3.1.4.1.4 RpcAsyncSetPrinter (Opnum 8)

RpcAsyncSetPrinter sets configuration information, initialization data, and security information of the specified printer to the values contained in the method parameters. It can also perform an action to change the active status of the printer.

The counterpart of this method in the Print System Remote Protocol is **RpcSetPrinter**. All parameters not defined below are specified in [\[MS-RPRN\]](#) section 3.1.4.2.5.

```
DWORD RpcAsyncSetPrinter(  
    [in] PRINTER_HANDLE hPrinter,  
    [in] PRINTER_CONTAINER* pPrinterContainer,  
    [in] DEVMODE_CONTAINER* pDevModeContainer,  
    [in] SECURITY_CONTAINER* pSecurityContainer,  
    [in] DWORD Command  
);
```

hPrinter: A handle to a printer object or server object that has been opened by using either [RpcAsyncOpenPrinter \(section 3.1.4.1.1\)](#) or [RpcAsyncAddPrinter \(section 3.1.4.1.2\)](#).

Return Values: This method MUST return zero to indicate successful completion or a nonzero Win32 error code ([\[MS-ERREF\]](#) section 2.2) to indicate failure. The client MUST treat any nonzero return value as a fatal error.

Exceptions Thrown: This method MUST NOT throw any exceptions other than those that are thrown by the underlying RPC protocol [\[MS-RPCE\]](#).

This method MUST adhere to the parameter validation, processing, and response requirements that are specified in [\[MS-RPRN\]](#) section 3.1.4.2.5.

3.1.4.1.5 RpcAsyncGetPrinter (Opnum 9)

RpcAsyncGetPrinter retrieves information about a specified printer.

The counterpart of this method in the Print System Remote Protocol is **RpcGetPrinter**. All parameters not defined below are specified in [\[MS-RPRN\]](#) section 3.1.4.2.6.

```
DWORD RpcAsyncGetPrinter(  
    [in] PRINTER_HANDLE hPrinter,  
    [in] DWORD Level,  
    [in, out, unique, size_is(cbBuf)]  
        unsigned char* pPrinter,  
    [in] DWORD cbBuf,  
    [out] DWORD* pcbNeeded  
);
```

hPrinter: A handle to a printer object that has been opened by using either [RpcAsyncOpenPrinter \(section 3.1.4.1.1\)](#) or [RpcAsyncAddPrinter \(section 3.1.4.1.2\)](#).

Return Values: This method MUST return zero to indicate successful completion or a nonzero Win32 error code ([\[MS-ERREF\]](#) section 2.2) to indicate failure. Aside from the specific nonzero return values documented in section [3.1.4](#), the client MUST treat any nonzero return value as a fatal error.

Exceptions Thrown: This method MUST NOT throw any exceptions other than those that are thrown by the underlying RPC protocol [\[MS-RPCE\]](#).

This method MUST adhere to the parameter validation, processing, and response requirements that are specified in [\[MS-RPRN\]](#) section 3.1.4.2.6.

3.1.4.1.6 RpcAsyncGetPrinterData (Opnum 16)

RpcAsyncGetPrinterData retrieves configuration data for the specified printer or print server.

The counterpart of this method in the Print System Remote Protocol is **RpcGetPrinterData**. All parameters not defined below are specified in [\[MS-RPRN\]](#) section 3.1.4.2.7.

```
DWORD RpcAsyncGetPrinterData(  
    [in] PRINTER_HANDLE hPrinter,  
    [in, string] wchar_t* pValueName,  
    [out] DWORD* pType,  
    [out, size_is(nSize)] unsigned char* pData,  
    [in] DWORD nSize,  
    [out] DWORD* pcbNeeded  
);
```

hPrinter: A handle to a printer object or server object that has been opened using either [RpcAsyncOpenPrinter \(section 3.1.4.1.1\)](#) or [RpcAsyncAddPrinter \(section 3.1.4.1.2\)](#).

Return Values: This method MUST return zero to indicate successful completion or a nonzero Win32 error code ([\[MS-ERREF\]](#) section 2.2) to indicate failure. Aside from the specific nonzero return values documented in section [3.1.4](#), the client MUST treat any nonzero return value as a fatal error.

Exceptions Thrown: This method MUST NOT throw any exceptions other than those that are thrown by the underlying RPC protocol [\[MS-RPCE\]](#).

This method MUST adhere to the parameter validation, processing, and response requirements that are specified in [\[MS-RPRN\]](#) section 3.1.4.2.7.

3.1.4.1.7 RpcAsyncGetPrinterDataEx (Opnum 17)

RpcAsyncGetPrinterDataEx retrieves configuration data for the specified printer or print server. This method extends [RpcAsyncGetPrinterData \(section 3.1.4.1.6\)](#) and can retrieve values stored under the specified key by [RpcAsyncSetPrinterDataEx \(section 3.1.4.1.9\)](#).

The counterpart of this method in the Print System Remote Protocol is **RpcGetPrinterDataEx**. All parameters not defined below are specified in [\[MS-RPRN\]](#) section 3.1.4.2.19.

```
DWORD RpcAsyncGetPrinterDataEx(  
    [in] PRINTER_HANDLE hPrinter,  
    [in, string] const wchar_t* pKeyName,  
    [in, string] const wchar_t* pValueName,  
    [out] DWORD* pType,  
    [out, size_is(nSize)] unsigned char* pData,  
    [in] DWORD nSize,  
    [out] DWORD* pcbNeeded  
);
```

hPrinter: A handle to a printer object or server object that has been opened using either [RpcAsyncOpenPrinter \(section 3.1.4.1.1\)](#) or [RpcAsyncAddPrinter \(section 3.1.4.1.2\)](#).

Return Values: This method MUST return zero to indicate successful completion or a nonzero Win32 error code ([\[MS-ERREF\]](#) section 2.2) to indicate failure. Aside from the specific nonzero return values documented in section [3.1.4](#), the client MUST treat any nonzero return value as a fatal error.

Exceptions Thrown: This method MUST NOT throw any exceptions other than those that are thrown by the underlying RPC protocol [\[MS-RPCE\]](#).

This method MUST adhere to the parameter validation, processing, and response requirements that are specified in [\[MS-RPRN\]](#) section 3.1.4.2.19.

3.1.4.1.8 RpcAsyncSetPrinterData (Opnum 18)

RpcAsyncSetPrinterData sets configuration data for the specified printer or print server.

The counterpart of this method in the Print System Remote Protocol is **RpcSetPrinterData**. All parameters not defined below are specified in [\[MS-RPRN\]](#) section 3.1.4.2.8.

```
DWORD RpcAsyncSetPrinterData(  
    [in] PRINTER_HANDLE hPrinter,  
    [in, string] wchar_t* pValueName,  
    [in] DWORD Type,  
    [in, size_is(cbData)] unsigned char* pData,
```

```
[in] DWORD cbData
);
```

hPrinter: A handle to a printer object or server object that has been opened using either [RpcAsyncOpenPrinter \(section 3.1.4.1.1\)](#) or [RpcAsyncAddPrinter \(section 3.1.4.1.2\)](#).

Return Values: This method MUST return zero to indicate successful completion or a nonzero Win32 error code ([\[MS-ERREF\]](#) section 2.2) to indicate failure. The client MUST treat any nonzero return value as a fatal error.

Exceptions Thrown: This method MUST NOT throw any exceptions other than those that are thrown by the underlying RPC protocol [\[MS-RPCE\]](#).

This method MUST adhere to the parameter validation, processing, and response requirements that are specified in [\[MS-RPRN\]](#) section 3.1.4.2.8.

3.1.4.1.9 RpcAsyncSetPrinterDataEx (Opnum 19)

RpcAsyncSetPrinterDataEx sets configuration data for the specified printer or print server. This method is similar to [RpcAsyncSetPrinterData \(section 3.1.4.1.8\)](#) but also allows the caller to specify the **registry** key under which to store the data.

The counterpart of this method in the Print System Remote Protocol is **RpcSetPrinterDataEx**. All parameters not defined below are specified in [\[MS-RPRN\]](#) section 3.1.4.2.18.

```
DWORD RpcAsyncSetPrinterDataEx(
    [in] PRINTER_HANDLE hPrinter,
    [in, string] const wchar_t* pKeyName,
    [in, string] const wchar_t* pValueName,
    [in] DWORD Type,
    [in, size_is(cbData)] unsigned char* pData,
    [in] DWORD cbData
);
```

hPrinter: A handle to a printer object or server object that has been opened using either [RpcAsyncOpenPrinter \(section 3.1.4.1.1\)](#) or [RpcAsyncAddPrinter \(section 3.1.4.1.2\)](#).

Return Values: This method MUST return zero to indicate successful completion or a nonzero Win32 error code ([\[MS-ERREF\]](#) section 2.2) to indicate failure. The client MUST treat any nonzero return value as a fatal error.

Exceptions Thrown: This method MUST NOT throw any exceptions other than those that are thrown by the underlying RPC protocol [\[MS-RPCE\]](#).

This method MUST adhere to the parameter validation, processing, and response requirements specified in [\[MS-RPRN\]](#) section 3.1.4.2.18.

3.1.4.1.10 RpcAsyncClosePrinter (Opnum 20)

RpcAsyncClosePrinter closes a handle to a printer object, server object, job object, or port object, opened by calling [RpcAsyncOpenPrinter](#) or [RpcAsyncAddPrinter](#).

The counterpart of this method in the Print System Remote Protocol is **RpcClosePrinter**. All parameters not defined below are specified in [\[MS-RPRN\]](#) section 3.1.4.2.9.

```

DWORD RpcAsyncClosePrinter(
    [in, out] PRINTER_HANDLE* phPrinter
);

```

phPrinter: A pointer to a handle to a printer object, server object, job object, or port object that has been opened using either **RpcAsyncOpenPrinter** (section 3.1.4.1.1) or **RpcAsyncAddPrinter** (section 3.1.4.1.2).

Return Values: This method MUST return zero to indicate successful completion or a nonzero Win32 error code ([\[MS-ERREF\]](#) section 2.2) to indicate failure. The client MUST treat any nonzero return value as a fatal error.

Exceptions Thrown: This method MUST NOT throw any exceptions other than those that are thrown by the underlying RPC protocol [\[MS-RPCE\]](#).

This method MUST adhere to the parameter validation, processing, and response requirements that are specified in [\[MS-RPRN\]](#) section 3.1.4.2.9.

3.1.4.1.11 RpcAsyncEnumPrinterData (Opnum 27)

RpcAsyncEnumPrinterData enumerates configuration data for a specified printer.

The counterpart of this method in the Print System Remote Protocol is **RpcEnumPrinterData**. All parameters not defined below are specified in [\[MS-RPRN\]](#) section 3.1.4.2.16.

```

DWORD RpcAsyncEnumPrinterData(
    [in] PRINTER_HANDLE hPrinter,
    [in] DWORD dwIndex,
    [out, size_is(cbValueName/sizeof(wchar_t))]
    wchar_t* pValueName,
    [in] DWORD cbValueName,
    [out] DWORD* pcbValueName,
    [out] DWORD* pType,
    [out, size_is(cbData)] unsigned char* pData,
    [in] DWORD cbData,
    [out] DWORD* pcbData
);

```

hPrinter: A handle to a printer object that has been opened using either [RpcAsyncOpenPrinter \(section 3.1.4.1.1\)](#) or [RpcAsyncAddPrinter \(section 3.1.4.1.2\)](#).

Return Values: This method MUST return zero to indicate successful completion or a nonzero Win32 error code ([\[MS-ERREF\]](#) section 2.2) to indicate failure. Aside from the specific nonzero return values documented in section [3.1.4](#), the client MUST treat any nonzero return value as a fatal error.

Exceptions Thrown: This method MUST NOT throw any exceptions other than those that are thrown by the underlying RPC protocol [\[MS-RPCE\]](#).

This method MUST adhere to the parameter validation, processing, and response requirements that are specified in [\[MS-RPRN\]](#) section 3.1.4.2.16.

3.1.4.1.12 RpcAsyncEnumPrinterDataEx (Opnum 28)

RpcAsyncEnumPrinterDataEx enumerates all registry value names and data under the key for the specified printer.

The counterpart of this method in the Print System Remote Protocol is **RpcEnumPrinterDataEx**. All parameters not defined below are specified in [\[MS-RPRN\]](#) section 3.1.4.2.20.

```
DWORD RpcAsyncEnumPrinterDataEx(  
    [in] PRINTER_HANDLE hPrinter,  
    [in, string] const wchar_t* pKeyName,  
    [out, size_is(cbEnumValues)] unsigned char* pEnumValues,  
    [in] DWORD cbEnumValues,  
    [out] DWORD* pcbEnumValues,  
    [out] DWORD* pnEnumValues  
);
```

hPrinter: A handle to a printer object that has been opened using either [RpcAsyncOpenPrinter \(section 3.1.4.1.1\)](#) or [RpcAsyncAddPrinter \(section 3.1.4.1.2\)](#).

Return Values: This method MUST return zero to indicate successful completion or a nonzero Win32 error code ([\[MS-ERREF\]](#) section 2.2) to indicate failure. Aside from the specific nonzero return values documented in section [3.1.4](#), the client MUST treat any nonzero return value as a fatal error.

Exceptions Thrown: This method MUST NOT throw any exceptions other than those that are thrown by the underlying RPC protocol [\[MS-RPCE\]](#).

This method MUST adhere to the parameter validation, processing, and response requirements that are specified in [\[MS-RPRN\]](#) section 3.1.4.2.20.

3.1.4.1.13 RpcAsyncEnumPrinterKey (Opnum 29)

RpcAsyncEnumPrinterKey enumerates the subkeys of a specified key for a specified printer.

The counterpart of this method in the Print System Remote Protocol is **RpcEnumPrinterKey**. All parameters not defined below are specified in [\[MS-RPRN\]](#) section 3.1.4.2.21.

```
DWORD RpcAsyncEnumPrinterKey(  
    [in] PRINTER_HANDLE hPrinter,  
    [in, string] const wchar_t* pKeyName,  
    [out, size_is(cbSubkey/sizeof(wchar_t))]  
    wchar_t* pSubkey,  
    [in] DWORD cbSubkey,  
    [out] DWORD* pcbSubkey  
);
```

hPrinter: A handle to a printer object that has been opened using either [RpcAsyncOpenPrinter \(section 3.1.4.1.1\)](#) or [RpcAsyncAddPrinter \(section 3.1.4.1.2\)](#).

Return Values: This method MUST return zero to indicate successful completion or a nonzero Win32 error code ([\[MS-ERREF\]](#) section 2.2) to indicate failure. Aside from the specific nonzero return values documented in section [3.1.4](#), the client MUST treat any nonzero return value as a fatal error.

Exceptions Thrown: This method MUST NOT throw any exceptions other than those that are thrown by the underlying RPC protocol [\[MS-RPCE\]](#).

This method MUST adhere to the parameter validation, processing, and response requirements that are specified in [\[MS-RPRN\]](#) section 3.1.4.2.21.

3.1.4.1.14 **RpcAsyncDeletePrinterData (Opnum 30)**

RpcAsyncDeletePrinterData deletes a specified value from the configuration of a specified printer.

The counterpart of this method in the Print System Remote Protocol is **RpcDeletePrinterData**. All parameters not defined below are specified in [\[MS-RPRN\]](#) section 3.1.4.2.17.

```
DWORD RpcAsyncDeletePrinterData(  
    [in] PRINTER_HANDLE hPrinter,  
    [in, string] wchar_t* pValueName  
);
```

hPrinter: A handle to a printer object that has been opened using either [RpcAsyncOpenPrinter \(section 3.1.4.1.1\)](#) or [RpcAsyncAddPrinter \(section 3.1.4.1.2\)](#).

Return Values: This method MUST return zero to indicate successful completion or a nonzero Win32 error code ([\[MS-ERREF\]](#) section 2.2) to indicate failure. The client MUST treat any nonzero return value as a fatal error.

Exceptions Thrown: This method MUST NOT throw any exceptions other than those that are thrown by the underlying RPC protocol [\[MS-RPCE\]](#).

This method MUST adhere to the parameter validation, processing, and response requirements that are specified in [\[MS-RPRN\]](#) section 3.1.4.2.17.

3.1.4.1.15 **RpcAsyncDeletePrinterDataEx (Opnum 31)**

RpcAsyncDeletePrinterDataEx deletes a specified value from the configuration data of a specified printer, which consists of a set of named and typed values stored in a hierarchy of registry keys.

The counterpart of this method in the Print System Remote Protocol is **RpcDeletePrinterDataEx**. All parameters not defined below are specified in [\[MS-RPRN\]](#) section 3.1.4.2.22.

```
DWORD RpcAsyncDeletePrinterDataEx(  
    [in] PRINTER_HANDLE hPrinter,  
    [in, string] const wchar_t* pKeyName,  
    [in, string] const wchar_t* pValueName  
);
```

hPrinter: A handle to a printer object that has been opened using either [RpcAsyncOpenPrinter \(section 3.1.4.1.1\)](#) or [RpcAsyncAddPrinter \(section 3.1.4.1.2\)](#).

Return Values: This method MUST return zero to indicate successful completion or a nonzero Win32 error code ([\[MS-ERREF\]](#) section 2.2) to indicate failure. The client MUST treat any nonzero return value as a fatal error.

Exceptions Thrown: This method MUST NOT throw any exceptions other than those that are thrown by the underlying RPC protocol [\[MS-RPCE\]](#).

This method MUST adhere to the parameter validation, processing, and response requirements that are specified in [\[MS-RPRN\]](#) section 3.1.4.2.22.

3.1.4.1.16 RpcAsyncDeletePrinterKey (Opnum 32)

RpcAsyncDeletePrinterKey deletes a specified key and all of its subkeys from the configuration of a specified printer.

The counterpart of this method in the Print System Remote Protocol is **RpcDeletePrinterKey**. All parameters not defined below are specified in [\[MS-RPRN\]](#) section 3.1.4.2.23.

```
DWORD RpcAsyncDeletePrinterKey(  
    [in] PRINTER_HANDLE hPrinter,  
    [in, string] const wchar_t* pKeyName  
);
```

hPrinter: A handle to a printer object that has been opened using either [RpcAsyncOpenPrinter \(section 3.1.4.1.1\)](#) or [RpcAsyncAddPrinter \(section 3.1.4.1.2\)](#).

Return Values: This method MUST return zero to indicate successful completion or a nonzero Win32 error code ([\[MS-ERREF\]](#) section 2.2) to indicate failure. The client MUST treat any nonzero return value as a fatal error.

Exceptions Thrown: This method MUST NOT throw any exceptions other than those that are thrown by the underlying RPC protocol [\[MS-RPCE\]](#).

This method MUST adhere to the parameter validation, processing, and response requirements that are specified in [\[MS-RPRN\]](#) section 3.1.4.2.23.

3.1.4.1.17 RpcAsyncSendRecvBidiData (Opnum 34)

RpcAsyncSendRecvBidiData sends and receives bidirectional data. This method is used to communicate with print monitors that support such data.

The counterpart of this method in the Print System Remote Protocol is **RpcSendRecvBidiData**. All parameters not defined below are specified in [\[MS-RPRN\]](#) section 3.1.4.2.27.

```
DWORD RpcAsyncSendRecvBidiData(  
    [in] PRINTER_HANDLE hPrinter,  
    [in, string, unique] const wchar_t* pAction,  
    [in] RPC_BIDI_REQUEST_CONTAINER* pReqData,  
    [out] RPC_BIDI_RESPONSE_CONTAINER** ppRespData  
);
```

hPrinter: A handle to a printer object that has been opened using either [RpcAsyncOpenPrinter \(section 3.1.4.1.1\)](#) or [RpcAsyncAddPrinter \(section 3.1.4.1.2\)](#).

Return Values: This method MUST return zero to indicate successful completion or a nonzero Win32 error code ([\[MS-ERREF\]](#) section 2.2) to indicate failure. The client MUST treat any nonzero return value as a fatal error.

Exceptions Thrown: This method MUST NOT throw any exceptions other than those that are thrown by the underlying RPC protocol [\[MS-RPCE\]](#).

This method MUST adhere to the parameter validation, processing, and response requirements that are specified in [\[MS-RPRN\]](#) section 3.1.4.2.27.

3.1.4.1.18 RpcAsyncCreatePrinterIC (Opnum 35)

RpcAsyncCreatePrinterIC creates an information context for a specified printer.

The counterpart of this method in the Print System Remote Protocol is **RpcCreatePrinterIC**. All parameters not defined below are specified in [\[MS-RPRN\]](#) section 3.1.4.2.10.

```
DWORD RpcAsyncCreatePrinterIC(  
    [in] PRINTER_HANDLE hPrinter,  
    [out] GDI_HANDLE* pHandle,  
    [in] DEVMODE_CONTAINER* pDevModeContainer  
);
```

hPrinter: A handle to a printer object ([\[MS-RPRN\]](#) section 2.2.1.1.4) that has been opened using [RpcAsyncOpenPrinter \(section 3.1.4.1.1\)](#) or [RpcAsyncAddPrinter \(section 3.1.4.1.2\)](#).

Return Values: This method MUST return zero to indicate successful completion or a nonzero Win32 error code ([\[MS-ERREF\]](#) section 2.2) to indicate failure. The client MUST treat any nonzero return value as a fatal error.

Exceptions Thrown: This method MUST NOT throw any exceptions other than those that are thrown by the underlying RPC protocol [\[MS-RPCE\]](#).

This method MUST adhere to the parameter validation, processing, and response requirements that are specified in [\[MS-RPRN\]](#) section 3.1.4.2.10.

3.1.4.1.19 RpcAsyncPlayGdiScriptOnPrinterIC (Opnum 36)

RpcAsyncPlayGdiScriptOnPrinterIC returns font information for a printer connection.

The counterpart of this method in the Print System Remote Protocol is **RpcPlayGdiScriptOnPrinterIC**. All parameters not defined below are specified in [\[MS-RPRN\]](#) section 3.1.4.2.11.

```
DWORD RpcAsyncPlayGdiScriptOnPrinterIC(  
    [in] GDI_HANDLE hPrinterIC,  
    [in, size_is(cIn)] unsigned char* pIn,  
    [in] DWORD cIn,  
    [out, size_is(cOut)] unsigned char* pOut,  
    [in] DWORD cOut,  
    [in] DWORD ul  
);
```

hPrinterIC: A printer information context handle ([\[MS-RPRN\]](#) section 2.2.1.1.2) that has been returned by [RpcAsyncCreatePrinterIC \(section 3.1.4.1.18\)](#).

Return Values: This method MUST return zero to indicate successful completion or a nonzero Win32 error code ([\[MS-ERREF\]](#) section 2.2) to indicate failure. The client MUST treat any nonzero return value as a fatal error.

Exceptions Thrown: This method MUST NOT throw any exceptions other than those that are thrown by the underlying RPC protocol [\[MS-RPCE\]](#).

This method MUST adhere to the parameter validation, processing, and response requirements that are specified in [\[MS-RPRN\]](#) section 3.1.4.2.11.

3.1.4.1.20 RpcAsyncDeletePrinterIC (Opnum 37)

RpcAsyncDeletePrinterIC deletes a printer information context.

The counterpart of this method in the Print System Remote Protocol is **RpcDeletePrinterIC**. All parameters not defined below are specified in [\[MS-RPRN\]](#) section 3.1.4.2.12.

```
DWORD RpcAsyncDeletePrinterIC(  
    [in, out] GDI_HANDLE* phPrinterIC  
);
```

phPrinterIC: A non-NULL pointer to a printer information context handle ([\[MS-RPRN\]](#) section 2.2.1.1.2) that has been returned by [RpcAsyncCreatePrinterIC \(section 3.1.4.1.18\)](#).

Return Values: This method MUST return zero to indicate successful completion or a nonzero Win32 error code ([\[MS-ERREF\]](#) section 2.2) to indicate failure. The client MUST treat any nonzero return value as a fatal error.

Exceptions Thrown: This method MUST NOT throw any exceptions other than those that are thrown by the underlying RPC protocol [\[MS-RPCE\]](#).

This method MUST adhere to the parameter validation, processing, and response requirements that are specified in [\[MS-RPRN\]](#) section 3.1.4.2.12.

3.1.4.1.21 RpcAsyncEnumPrinters (Opnum 38)

RpcAsyncEnumPrinters enumerates available local printers, printers on a specified print server, printers in a specified domain, or print providers.

The counterpart of this method in the Print System Remote Protocol is **RpcEnumPrinters**. All parameters not defined below are specified in [\[MS-RPRN\]](#) section 3.1.4.2.1.

```
DWORD RpcAsyncEnumPrinters(  
    [in] handle_t hRemoteBinding,  
    [in] DWORD Flags,  
    [in, string, unique] wchar_t* Name,  
    [in] DWORD Level,  
    [in, out, unique, size_is(cbBuf)]  
        unsigned char* pPrinterEnum,  
    [in] DWORD cbBuf,  
    [out] DWORD* pcbNeeded,  
    [out] DWORD* pcReturned  
);
```

hRemoteBinding: An RPC explicit binding handle.

Return Values: This method MUST return zero to indicate successful completion or a nonzero Win32 error code ([\[MS-ERREF\]](#) section 2.2) to indicate failure. Aside from the specific nonzero return values documented in section [3.1.4](#), the client MUST treat any nonzero return value as a fatal error.

Exceptions Thrown: This method MUST NOT throw any exceptions other than those that are thrown by the underlying RPC protocol [\[MS-RPCE\]](#).

This method MUST adhere to the parameter validation, processing, and response requirements that are specified in [\[MS-RPRN\]](#) section 3.1.4.2.1.

3.1.4.1.22 RpcAsyncAddPerMachineConnection (Opnum 55)

RpcAsyncAddPerMachineConnection persistently saves the configuration information for a connection, including the print server name and the name of the print providers for the specified connection.

The counterpart of this method in the Print System Remote Protocol is **RpcAddPerMachineConnection**. All parameters not defined below are specified in [\[MS-RPRN\]](#) section 3.1.4.2.24.

```
DWORD RpcAsyncAddPerMachineConnection(  
    [in] handle_t hRemoteBinding,  
    [in, string, unique] wchar_t* pServer,  
    [in, string] const wchar_t* pPrinterName,  
    [in, string] const wchar_t* pPrintServer,  
    [in, string] const wchar_t* pProvider  
);
```

hRemoteBinding: An RPC explicit binding handle.

Return Values: This method MUST return zero to indicate successful completion or a nonzero Win32 error code ([\[MS-ERREF\]](#) section 2.2) to indicate failure. The client MUST treat any nonzero return value as a fatal error.

Exceptions Thrown: This method MUST NOT throw any exceptions other than those that are thrown by the underlying RPC protocol [\[MS-RPCE\]](#).

This method MUST adhere to the parameter validation, processing, and response requirements that are specified in [\[MS-RPRN\]](#) section 3.1.4.2.24.

3.1.4.1.23 RpcAsyncDeletePerMachineConnection (Opnum 56)

RpcAsyncDeletePerMachineConnection deletes the stored connection configuration information that corresponds to the pPrinterName parameter value.

The counterpart of this method in the Print System Remote Protocol is **RpcDeletePerMachineConnection**. All parameters not defined below are specified in [\[MS-RPRN\]](#) section 3.1.4.2.25.

```
DWORD RpcAsyncDeletePerMachineConnection(  
    [in] handle_t hRemoteBinding,  
    [in, string, unique] wchar_t* pServer,  
    [in, string] const wchar_t* pPrinterName  
);
```

hRemoteBinding: An RPC explicit binding handle.

Return Values: This method MUST return zero to indicate successful completion or a nonzero Win32 error code ([\[MS-ERREF\]](#) section 2.2) to indicate failure. The client MUST treat any nonzero return value as a fatal error.

Exceptions Thrown: This method MUST NOT throw any exceptions other than those that are thrown by the underlying RPC protocol [\[MS-RPCE\]](#).

This method MUST adhere to the parameter validation, processing, and response requirements that are specified in [\[MS-RPRN\]](#) section 3.1.4.2.25.

3.1.4.1.24 RpcAsyncEnumPerMachineConnections (Opnum 57)

RpcAsyncEnumPerMachineConnections enumerates each of the per-machine connections into a specified buffer.

The counterpart of this method in the Print System Remote Protocol is **RpcEnumPerMachineConnections**. All parameters not defined below are specified in [\[MS-RPRN\]](#) section 3.1.4.2.26.

```
DWORD RpcAsyncEnumPerMachineConnections(  
    [in] handle_t hRemoteBinding,  
    [in, string, unique] wchar_t* pServer,  
    [in, out, unique, size_is(cbBuf)]  
        unsigned char* pPrinterEnum,  
    [in] DWORD cbBuf,  
    [out] DWORD* pcbNeeded,  
    [out] DWORD* pcReturned  
);
```

hRemoteBinding: An RPC explicit binding handle.

Return Values: This method MUST return zero to indicate successful completion or a nonzero Win32 error code ([\[MS-ERREF\]](#) section 2.2) to indicate failure. Aside from the specific nonzero return values documented in section [3.1.4](#), the client MUST treat any nonzero return value as a fatal error.

Exceptions Thrown: This method MUST NOT throw any exceptions other than those that are thrown by the underlying RPC protocol [\[MS-RPCE\]](#).

This method MUST adhere to the parameter validation, processing, and response requirements that are specified in [\[MS-RPRN\]](#) section 3.1.4.2.26.

3.1.4.1.25 RpcAsyncResetPrinter (Opnum 69)

RpcAsyncResetPrinter resets the data type and device mode (For more information, see [\[DEVMODE\]](#)) values to use for printing documents submitted by the [RpcAsyncStartDocPrinter \(section 3.1.4.8.1\)](#) method.

The counterpart of this method in the Print System Remote Protocol is **RpcResetPrinter**. All parameters not defined below are specified in [\[MS-RPRN\]](#) section 3.1.4.2.13.

```
DWORD RpcAsyncResetPrinter(  
    [in] PRINTER_HANDLE hPrinter,  
    [in, string, unique] wchar_t* pDatatype,  
    [in] DEVMODE_CONTAINER* pDevModeContainer
```

);

hPrinter: A handle to a printer object that has been opened using either [RpcAsyncOpenPrinter \(section 3.1.4.1.1\)](#) or [RpcAsyncAddPrinter \(section 3.1.4.1.2\)](#).

Return Values: This method MUST return zero to indicate successful completion or a nonzero Win32 error code ([\[MS-ERREF\]](#) section 2.2) to indicate failure. The client MUST treat any nonzero return value as a fatal error.

Exceptions Thrown: This method MUST NOT throw any exceptions other than those that are thrown by the underlying RPC protocol [\[MS-RPCE\]](#).

This method MUST adhere to the parameter validation, processing, and response requirements that are specified in [\[MS-RPRN\]](#) section 3.1.4.2.13.

3.1.4.2 Printer-Driver Management Methods

The Printer-Driver Management methods support the discovery, access, and installation of printer drivers. The following table presents a list of printer-driver management methods and their counterparts, if any, in the Print System Remote Protocol [\[MS-RPRN\]](#). All methods are specified in sections that follow.

Parameter descriptions, parameter validation, and processing and response requirements that are not specified in methods of the Print System Asynchronous Remote protocol [\[MS-PAR\]](#) are specified in the corresponding methods of the Print System Remote protocol [\[MS-RPRN\]](#).

| [MS-PAR] method | Description | [MS-RPRN] method |
|---|--|--|
| RpcAsyncGetPrinterDriver | RpcAsyncGetPrinterDriver retrieves data about a specified printer driver on a specified printer. Opnum 26 | RpcGetPrinterDriver2 |
| RpcAsyncAddPrinterDriver | RpcAsyncAddPrinterDriver installs a specified local or a remote printer driver on a specified print server, and it links the configuration, data, and driver files. Opnum 39 | RpcAddPrinterDriverEx |
| RpcAsyncEnumPrinterDrivers | RpcAsyncEnumPrinterDrivers enumerates the printer drivers installed on a specified print server. Opnum 40 | RpcEnumPrinterDrivers |
| RpcAsyncGetPrinterDriverDirectory | RpcAsyncGetPrinterDriverDirectory retrieves the path of the printer-driver directory on a specified print server. Opnum 41 | RpcGetPrinterDriverDirectory |
| RpcAsyncDeletePrinterDriver | RpcAsyncDeletePrinterDriver removes the specified printer driver from the list of supported drivers for a specified print server. | RpcDeletePrinterDriver |

| [MS-PAR] method | Description | [MS-RPRN] method |
|---|--|--|
| | Opnum 42 | |
| RpcAsyncDeletePrinterDriverEx | RpcAsyncDeletePrinterDriverEx removes the specified printer driver from the list of supported drivers on a specified print server, and deletes the files associated with the driver. This method also can delete specific versions of the driver. Opnum 43 | RpcDeletePrinterDriverEx |
| RpcAsyncInstallPrinterDriverFromPackage | RpcAsyncInstallPrinterDriverFromPackage installs a printer driver from a driver package. Opnum 62 | None. |
| RpcAsyncUploadPrinterDriverPackage | RpcAsyncUploadPrinterDriverPackage uploads a driver package so that it can be installed with RpcAsyncInstallPrinterDriverFromPackage . Opnum 63 | None. |
| RpcAsyncGetCorePrinterDrivers | RpcAsyncGetCorePrinterDrivers gets the GUID, version, and date of the specified core printer drivers and the path to their packages. Opnum 64 | RpcGetCorePrinterDrivers |
| RpcAsyncCorePrinterDriverInstalled | RpcAsyncCorePrinterDriverInstalled determines if a specific core printer driver is installed. Opnum 65 | None. |
| RpcAsyncGetPrinterDriverPackagePath | RpcAsyncGetPrinterDriverPackagePath gets the path to the specified printer driver package. Opnum 66 | RpcGetPrinterDriverPackagePath |
| RpcAsyncDeletePrinterDriverPackage | RpcAsyncDeletePrinterDriverPackage deletes a specified printer driver package. Opnum 67 | None. |

3.1.4.2.1 RpcAsyncGetPrinterDriver (Opnum 26)

RpcAsyncGetPrinterDriver retrieves data about a specified printer driver on a specified printer.

The counterpart of this method in the Print System Remote Protocol is **RpcGetPrinterDriver2**. All parameters not defined below are specified in [\[MS-RPRN\]](#) section 3.1.4.4.6.

```
DWORD RpcAsyncGetPrinterDriver(
    [in] PRINTER_HANDLE hPrinter,
    [in, string, unique] wchar_t* pEnvironment,
```

```

[in] DWORD Level,
[in, out, unique, size_is(cbBuf)]
    unsigned char* pDriver,
[in] DWORD cbBuf,
[out] DWORD* pcbNeeded,
[in] DWORD dwClientMajorVersion,
[in] DWORD dwClientMinorVersion,
[out] DWORD* pdwServerMaxVersion,
[out] DWORD* pdwServerMinVersion
);

```

hPrinter: A handle to a printer object that has been opened by using either [RpcAsyncOpenPrinter \(section 3.1.4.1.1\)](#) or [RpcAsyncAddPrinter \(section 3.1.4.1.2\)](#).

Return Values: This method MUST return zero to indicate successful completion or a nonzero Win32 error code ([\[MS-ERREF\]](#) section 2.2) to indicate failure. Aside from the specific nonzero return values documented in section [3.1.4](#), the client MUST treat any nonzero return value as a fatal error.

Exceptions Thrown: This method MUST NOT throw any exceptions other than those that are thrown by the underlying RPC protocol [\[MS-RPCE\]](#).

This method MUST adhere to the parameter validation, processing, and response requirements that are specified in [\[MS-RPRN\]](#) section 3.1.4.4.6.

3.1.4.2.2 RpcAsyncAddPrinterDriver (Opnum 39)

RpcAsyncAddPrinterDriver installs a specified local or a remote printer driver on a specified print server, and it links the configuration, data, and driver files.

The counterpart of this method in the Print System Remote Protocol is **RpcAddPrinterDriverEx**. All parameters not defined below are specified in [\[MS-RPRN\]](#) section 3.1.4.4.8.

```

DWORD RpcAsyncAddPrinterDriver(
    [in] handle_t hRemoteBinding,
    [in, string, unique] wchar_t* pName,
    [in] DRIVER_CONTAINER* pDriverContainer,
    [in] DWORD dwFileCopyFlags
);

```

hRemoteBinding: An RPC explicit binding handle.

Return Values: This method MUST return zero to indicate successful completion or a nonzero Win32 error code ([\[MS-ERREF\]](#) section 2.2) to indicate failure. The client MUST treat any nonzero return value as a fatal error.

Exceptions Thrown: This method MUST NOT throw any exceptions other than those that are thrown by the underlying RPC protocol [\[MS-RPCE\]](#).

This method MUST adhere to the parameter validation, processing, and response requirements that are specified in [\[MS-RPRN\]](#) section 3.1.4.4.8.

3.1.4.2.3 RpcAsyncEnumPrinterDrivers (Opnum 40)

RpcAsyncEnumPrinterDrivers enumerates the printer drivers installed on a specified print server.

The counterpart of this method in the Print System Remote Protocol is **RpcEnumPrinterDrivers**. All parameters not defined below are specified in [\[MS-RPRN\]](#) section 3.1.4.4.2.

```
DWORD RpcAsyncEnumPrinterDrivers(  
    [in] handle_t hRemoteBinding,  
    [in, string, unique] wchar_t* pName,  
    [in, string, unique] wchar_t* pEnvironment,  
    [in] DWORD Level,  
    [in, out, unique, size_is(cbBuf)]  
        unsigned char* pDrivers,  
    [in] DWORD cbBuf,  
    [out] DWORD* pcbNeeded,  
    [out] DWORD* pcReturned  
);
```

hRemoteBinding: An RPC explicit binding handle.

Return Values: This method MUST return zero to indicate successful completion or a nonzero Win32 error code ([\[MS-ERREF\]](#) section 2.2) to indicate failure. Aside from the specific nonzero return values documented in section [3.1.4](#), the client MUST treat any nonzero return value as a fatal error.

Exceptions Thrown: This method MUST NOT throw any exceptions other than those that are thrown by the underlying RPC protocol [\[MS-RPCE\]](#).

This method MUST adhere to the parameter validation, processing, and response requirements that are specified in [\[MS-RPRN\]](#) section 3.1.4.4.2.

3.1.4.2.4 RpcAsyncGetPrinterDriverDirectory (Opnum 41)

RpcAsyncGetPrinterDriverDirectory retrieves the path of the printer driver directory on a specified print server.

The counterpart of this method in the Print System Remote Protocol is **RpcGetPrinterDriverDirectory**. All parameters not defined below are specified in [\[MS-RPRN\]](#) section 3.1.4.4.4.

```
DWORD RpcAsyncGetPrinterDriverDirectory(  
    [in] handle_t hRemoteBinding,  
    [in, string, unique] wchar_t* pName,  
    [in, string, unique] wchar_t* pEnvironment,  
    [in] DWORD Level,  
    [in, out, unique, size_is(cbBuf)]  
        unsigned char* pDriverDirectory,  
    [in] DWORD cbBuf,  
    [out] DWORD* pcbNeeded  
);
```

hRemoteBinding: An RPC explicit binding handle.

Return Values: This method MUST return zero to indicate successful completion or a nonzero Win32 error code ([\[MS-ERREF\]](#) section 2.2) to indicate failure. Aside from the specific nonzero return values documented in section [3.1.4](#), the client MUST treat any nonzero return value as a fatal error.

Exceptions Thrown: This method MUST NOT throw any exceptions other than those that are thrown by the underlying RPC protocol [\[MS-RPCE\]](#).

This method MUST adhere to the parameter validation, processing, and response requirements that are specified in [\[MS-RPRN\]](#) section 3.1.4.4.4.

3.1.4.2.5 RpcAsyncDeletePrinterDriver (Opnum 42)

RpcAsyncDeletePrinterDriver removes the specified printer driver from the list of supported drivers for a specified print server.

The counterpart of this method in the Print System Remote Protocol is **RpcDeletePrinterDriver**. All parameters not defined below are specified in [\[MS-RPRN\]](#) section 3.1.4.4.5.

```
DWORD RpcAsyncDeletePrinterDriver(  
    [in] handle_t hRemoteBinding,  
    [in, string, unique] wchar_t* pName,  
    [in, string] wchar_t* pEnvironment,  
    [in, string] wchar_t* pDriverName  
);
```

hRemoteBinding: An RPC explicit binding handle.

Return Values: This method MUST return zero to indicate successful completion or a nonzero Win32 error code ([\[MS-ERREF\]](#) section 2.2) to indicate failure. The client MUST treat any nonzero return value as a fatal error.

Exceptions Thrown: This method MUST NOT throw any exceptions other than those that are thrown by the underlying RPC protocol [\[MS-RPCE\]](#).

This method MUST adhere to the parameter validation, processing, and response requirements that are specified in [\[MS-RPRN\]](#) section 3.1.4.4.5.

3.1.4.2.6 RpcAsyncDeletePrinterDriverEx (Opnum 43)

RpcAsyncDeletePrinterDriverEx removes the specified printer driver from the list of supported drivers on a specified print server, and deletes the files associated with the driver. This method also can delete specific versions of the driver.

The counterpart of this method in the Print System Remote Protocol is **RpcDeletePrinterDriverEx**. All parameters not defined below are specified in [\[MS-RPRN\]](#) section 3.1.4.4.7.

```
DWORD RpcAsyncDeletePrinterDriverEx(  
    [in] handle_t hRemoteBinding,  
    [in, string, unique] wchar_t* pName,  
    [in, string] wchar_t* pEnvironment,  
    [in, string] wchar_t* pDriverName,  
    [in] DWORD dwDeleteFlag,  
    [in] DWORD dwVersionNum  
);
```

hRemoteBinding: An RPC explicit binding handle.

Return Values: This method MUST return zero to indicate successful completion or a nonzero Win32 error code ([\[MS-ERREF\]](#) section 2.2) to indicate failure. The client MUST treat any nonzero return value as a fatal error.

Exceptions Thrown: This method MUST NOT throw any exceptions other than those that are thrown by the underlying RPC protocol [\[MS-RPCE\]](#).

This method MUST adhere to the parameter validation, processing, and response requirements that are specified in [\[MS-RPRN\]](#) section 3.1.4.4.7.

3.1.4.2.7 RpcAsyncInstallPrinterDriverFromPackage (Opnum 62)

RpcAsyncInstallPrinterDriverFromPackage installs a printer driver from a driver package.

```
HRESULT RpcAsyncInstallPrinterDriverFromPackage(  
    [in] handle_t hRemoteBinding,  
    [in, string, unique] const wchar_t* pszServer,  
    [in, string, unique] const wchar_t* pszInfPath,  
    [in, string] const wchar_t* pszDriverName,  
    [in, string] const wchar_t* pszEnvironment,  
    [in] DWORD dwFlags  
);
```

hRemoteBinding: An RPC explicit binding handle.

pszServer: A pointer to a **string** that specifies the name of the print server on which to install the printer driver.

This **string** MUST contain the server name that was used to create the **hRemoteBinding** parameter. For RPC bind handles, refer to [\[MS-RPCE\]](#). For rules governing server names, refer to [\[MS-RPRN\]](#) section 2.2.4.16.

pszInfPath: A pointer to a **string** that specifies the path to a driver installation control file that specifies the printer driver.

This control file MAY ≤ 10 be used to install the driver on a target system. For rules governing path names, refer to [\[MS-RPRN\]](#) section 2.2.4.9.

pszDriverName: A pointer to a **string** that specifies the name of the printer driver.

pszEnvironment: A pointer to a **string** that specifies the environment name for which the printer driver is installed. For rules governing environment names, refer to [\[MS-RPRN\]](#) section 2.2.4.4.

dwFlags: A bitfield that specifies the options for installing printer driver files from a driver package.

| Value | Meaning |
|------------------------------------|--|
| 0x00000000 | Only the files that will not overwrite files with a newer version SHOULD be installed. |
| IPDFP_COPY_ALL_FILES 0x00000001 | All files SHOULD be installed, even if doing so would overwrite some newer versions. |

All other bits SHOULD be set to 0 by the client and MUST be ignored by the server upon receipt.

Return Values: This method MUST return zero or an HRESULT success value ([\[MS-ERREF\]](#) section 2.1) to indicate successful completion or an HRESULT error value to indicate failure.

Exceptions Thrown: This method MUST NOT throw any exceptions other than those that are thrown by the underlying RPC protocol [[MS-RPCE](#)].

Parameter Validation Requirements: Upon receiving this method call, the server MUST validate parameters as follows:

- The **string** pointed to by the **pszInfPath** parameter MUST contain a valid path name; otherwise the server MUST return ERROR_INVALID_PARAMETER.
- The **string** pointed to by the **pszEnvironment** parameter MUST specify one of the supported environment names on this server for that type of driver; otherwise the server MUST return ERROR_INVALID_ENVIRONMENT.

The print server SHOULD perform the following additional validation steps: [<11>](#)

- Validate that, if the printer driver specified by the client has a driver version of 0x00000004 (see *cVersion* in [\[MS-RPRN\]](#) section 2.2.1.3.1), the driver package specified by the printer client contains exactly one **printer driver manifest** for the printer driver and the printer driver manifest conforms to the implementation-specific rules governing the format of printer driver manifests; otherwise, the server MUST return ERROR_INVALID_PRINTER_DRIVER_MANIFEST.
- Validate that, if the printer driver specified by the client is a **derived printer driver**, either the **class printer driver** on which the derived printer driver depends is already installed on the print server, or a driver package containing the class printer driver is installed in the print server's **driver store**, or the print server can locate a driver package containing the class printer driver through some other implementation-specific mechanism; [<12>](#) otherwise, the server MUST return ERROR_UNKNOWN_PRINTER_DRIVER.
- Validate that any files referenced in the driver installation control file specified by the print client or in the printer driver manifest in the driver package specified by the print client are present on the print server; otherwise, the server MUST return ERROR_FILE_NOT_FOUND.
- Validate that, if the printer driver specified by the client has a driver version of 0x00000003 (see *cVersion* in [\[MS-RPRN\]](#) section 2.2.1.3.1), the string pointed to by the *pszEnvironment* parameter is not "Windows ARM"; otherwise, the server MUST return ERROR_NOT_SUPPORTED.

If the installation requested by the print client is a **printer driver upgrade** and the new printer driver has a driver version of 0x00000003, the print server SHOULD perform the following additional validation steps:

- Validate that the currently installed printer driver is not a class printer driver.
- Validate that if the currently installed printer driver has a driver version of 0x00000004, the currently installed printer driver does not have a newer driver date, or if the driver dates are the same, the currently installed printer driver does not have a newer manufacturer-provided driver version number.
- Validate that if the currently installed printer driver has a driver version of 0x00000004, there are no printers on the print server that are shared and also use the currently installed printer driver.

If this validation fails, the print server MUST return ERROR_PRINTER_DRIVER_BLOCKED. [<13>](#)

If the installation requested by the print client is a printer driver upgrade and the new printer driver has a driver version of 0x00000004, the print server SHOULD perform the following additional validation steps:

- Validate that, if the currently installed printer driver is a class printer driver, the new printer driver is also a class printer driver.
- Validate that, unless the currently installed printer driver is not a class printer driver and the new printer driver is a class printer driver, the currently installed printer driver does not have a newer driver date than the new printer driver, or, if the driver dates are the same, that the currently installed printer driver does not have a newer manufacturer-provided driver version number.
- Validate that, if there are one or more printers on the print server that are shared and also use the currently installed printer driver, the new printer driver does not indicate that printers using that printer driver cannot be shared.

If this validation fails, the print server MUST return S_FALSE.<14>

If parameter validation fails, the server MUST fail the operation immediately and return a nonzero error response to the client.

Processing and Response Requirements: If parameter validation succeeds, the server MUST process the method call by:

- Installing a printer driver from the driver package that is located in the print server's driver store, using an implementation-specific mechanism to determine the Boolean values of each of the attributes of the printer driver object.<15> If the printer driver is a derived printer driver and the class printer driver on which the derived printer driver depends is not currently installed, the print server MUST first install the class printer driver. If a driver package containing the class printer driver on which the derived printer driver depends is also located in the print server's driver store, the print server SHOULD install the class printer driver from the driver package that contains it. If a driver package containing the class printer driver is not located in the print server's driver store but the print server can locate a driver package containing the class printer driver through some other implementation-specific mechanism,<16> the print server SHOULD install the driver package containing the class printer driver and then SHOULD install the class printer driver from that driver package.<17>
- Returning the status of the operation.

If the operation is successful, the server MUST install the printer driver from the driver package before returning the response.

3.1.4.2.8 RpcAsyncUploadPrinterDriverPackage (Opnum 63)

RpcAsyncUploadPrinterDriverPackage uploads a driver package so it can be installed with [RpcAsyncInstallPrinterDriverFromPackage \(section 3.1.4.2.7\)](#).

```
HRESULT RpcAsyncUploadPrinterDriverPackage(  
    [in] handle_t hRemoteBinding,  
    [in, string, unique] const wchar_t* pszServer,  
    [in, string] const wchar_t* pszInfPath,  
    [in, string] const wchar_t* pszEnvironment,  
    [in] DWORD dwFlags,  
    [in, out, unique, size_is(*pcchDestInfPath)]  
        wchar_t* pszDestInfPath,  
    [in, out] DWORD* pcchDestInfPath
```

);

hRemoteBinding: An RPC explicit binding handle.

pszServer: A pointer to a **string** that specifies the name of the print server to which this method will upload the printer driver package.

This **string** contains the server name that was used to create the **hRemoteBinding** parameter. For RPC bind handles, refer to [\[MS-RPCE\]](#). For rules governing server names, refer to [\[MS-RPRN\]](#) section 2.2.4.16.

pszInfPath: A pointer to a **string** that specifies the path to a driver installation control file that specifies the printer driver.

This control file MAY be used to install the driver on a target system. [<18>](#) For rules governing path names, see [\[MS-RPRN\]](#) section 2.2.4.9.

The path specified by *pszInfPath* MUST be accessible by the server. [<19>](#)

pszEnvironment: A pointer to a **string** that specifies the environment name for which the driver package is uploaded. For rules governing environment names, see [\[MS-RPRN\]](#) section 2.2.4.4.

dwFlags: A bitfield that specifies the options for uploading a driver package.

| Value | Meaning |
|--------------------------------------|---|
| 0x00000000 | This method uploads the driver package that is named by the string pointed to by the pszInfPath parameter to the print server, but only if that driver package is not already present on the server. |
| UPDP_UPLOAD_ALWAYS 0x00000002 | This method uploads the driver package files specified by the pszInfPath parameter even if the driver package is already present on the print server. |
| UPDP_CHECK_DRIVERSTORE 0x00000004 | This method only checks the print server's driver store to see if the driver package specified by the pszInfPath parameter is already present on the print server. If the driver package is not present on the print server, this method returns ERROR_NOT_FOUND; otherwise, the method returns zero. This flag is ignored if the UPDP_UPLOAD_ALWAYS flag is set. |

All other bits are set to zero by the client and ignored by the server upon receipt.

pszDestInfPath: A pointer to a buffer that receives a **string** that specifies the full path of the directory to which the driver installation control file was copied. For rules governing path names, see [\[MS-RPRN\]](#) section 2.2.4.9.

The value of the **string** is ignored by the server upon input.

pcchDestInfPath: On input, this parameter is a pointer to a variable that specifies the size, in characters, of the buffer that is referenced by the **pszDestInfPath** parameter. The specified size is at least 260 characters.

On output, the variable to which this parameter points receives the size, in characters, of the path string. The path string includes the terminating null character that was written into the buffer referenced by the **pszDestInfPath** parameter.

Return Values: This method MUST return zero or an HRESULT success value ([\[MS-ERREF\]](#) section 2.1) to indicate successful completion or an HRESULT error value to indicate failure.

Exceptions Thrown: This method MUST NOT throw any exceptions other than those that are thrown by the underlying RPC protocol [MS-RPCE].

Parameter Validation Requirements: Upon receiving this method call, the server MUST validate parameters as follows:

- The **string** pointed to by the **pszInfPath** parameter MUST contain a valid path name; otherwise the server MUST return ERROR_INVALID_PARAMETER.
- The **string** pointed to by the **pszEnvironment** parameter MUST specify one of the supported environment names on this server for that type of driver; otherwise the server MUST return ERROR_INVALID_ENVIRONMENT.
- The size specified by the variable pointed to by **pcchDestInfPath** MUST be at least 260 characters; otherwise the server MUST return ERROR_INVALID_PARAMETER.

If parameter validation fails, the server MUST fail the operation immediately and return a nonzero error response to the client.

Processing and Response Requirements: If parameter validation succeeds, the server MUST process the method call as follows:

- If the dwFlags parameter is 0x00000000 and the driver package does not exist already in the server's driver store, upload the signed driver package to the driver store of the print server so that it can be installed with **RpcAsyncInstallPrinterDriverFromPackage**.
- If the dwFlags parameter is 0x00000002, upload the signed driver package to the driver store of the print server, even if it already exists in the server's driver store, so that it can be installed with **RpcAsyncInstallPrinterDriverFromPackage**.
- Return the driver store path name of the file that describes the printer driver in the buffer pointed to by the output parameter **pszDestInfPath**.[<20>](#)
- Set the contents of the output parameter **pcchDestInfPath** to the size of the data in the buffer.
- If the dwFlags parameter is 0x00000004, check whether the driver package already exists in the server's driver store. If the driver package exists, return zero; otherwise, return ERROR_FILE_NOT_FOUND.
- Return a response that contains the specified output parameters and the status of the operation.

If the operation is successful, the server MUST upload the driver package into the system driver store before returning the response.

3.1.4.2.9 RpcAsyncGetCorePrinterDrivers (Opnum 64)

RpcAsyncGetCorePrinterDrivers gets the GUID, versions, and publish dates of the specified core printer drivers, and the paths to their packages.

The counterpart of this method in the Print System Remote Protocol is [RpcGetCorePrinterDrivers](#).

```
HRESULT RpcAsyncGetCorePrinterDrivers(  
    [in] handle_t hRemoteBinding,  
    [in, string, unique] const wchar_t* pszServer,
```

```

[in, string] const wchar_t* pszEnvironment,
[in] DWORD cchCoreDrivers,
[in, size_is(cchCoreDrivers)] const wchar_t* pszzCoreDriverDependencies,
[in] DWORD cCorePrinterDrivers,
[out, size_is(cCorePrinterDrivers)]
    CORE_PRINTER_DRIVER* pCorePrinterDrivers
);

```

hRemoteBinding: An RPC explicit binding handle.

pszServer: A pointer to a string that specifies the name of the print server from which to get the core printer driver information. This string contains a server name that is identical to the server name that was used to create the *hRemoteBinding* parameter. For details on RPC bind handles, see [\[MS-RPCE\]](#). For rules governing print server names, see [\[MS-RPRN\]](#) section 2.2.4.16.

pszEnvironment: A pointer to a string that specifies the environment name for which the core printer driver information will be returned. For rules governing environment names, and Windows behaviors, see [\[MS-RPRN\]](#) section 2.2.4.4.

cchCoreDrivers: The size, in bytes, of the buffer that is referenced by the *pszzCoreDriverDependencies* parameter.

pszzCoreDriverDependencies: A pointer to a multisz that contains a list of IDs [<21>](#) of the core printer drivers to be retrieved.

A print client SHOULD obtain this list of IDs as follows:

1. Call [RpcAsyncGetPrinterDriver \(section 3.1.4.2.1\)](#) with a *Level* parameter value of 0x00000008.
2. A [_DRIVER_INFO_8](#) custom-marshaled structure ([\[MS-RPRN\]](#) section 2.2.2.4.8) is returned in the *pDriver* parameter.
3. In the [_DRIVER_INFO_8](#) structure, the **szzCoreDependenciesOffset** field contains an offset to a multisz that contains the list of IDs.

cCorePrinterDrivers: The count of [CORE_PRINTER_DRIVER \(section 2.2.8\)](#) structures that are contained in the buffer that is pointed to by the *pCorePrinterDrivers* parameter. It equals the number of IDs that are specified in the multisz that is pointed to by the *pszzCoreDriverDependencies* parameter.

pCorePrinterDrivers: A pointer to a buffer that receives an array of [CORE_PRINTER_DRIVER](#) structures.

Return Values: This method MUST return zero or an HRESULT success value ([\[MS-ERREF\]](#) section 2.1) to indicate successful completion or an HRESULT error value to indicate failure.

Exceptions Thrown: This method MUST NOT throw any exceptions other than those that are thrown by the underlying RPC protocol [\[MS-RPCE\]](#).

This method MUST adhere to the parameter validation, processing, and response requirements that are specified in [\[MS-RPRN\]](#) section 3.1.4.4.9.

3.1.4.2.10 RpcAsyncCorePrinterDriverInstalled (Opnum 65)

RpcAsyncCorePrinterDriverInstalled determines if a specific core printer driver is installed.

```
HRESULT RpcAsyncCorePrinterDriverInstalled(  
    [in] handle_t hRemoteBinding,  
    [in, string, unique] const wchar_t* pszServer,  
    [in, string] const wchar_t* pszEnvironment,  
    [in] GUID CoreDriverGUID,  
    [in] FILETIME ftDriverDate,  
    [in] DWORDLONG dwlDriverVersion,  
    [out] int* pbDriverInstalled  
);
```

hRemoteBinding: An RPC explicit binding handle.

pszServer: A pointer to a string that contains the name of the print server to check and determine if a core printer driver is installed. This string MUST contain a server name that is identical to the server name that was used to create the **hRemoteBinding** parameter. For details on RPC bind handles, see [\[MS-RPCE\]](#). For rules governing print server names, see [\[MS-RPRN\]](#) section 2.2.4.16.

pszEnvironment: A pointer to a string that contains the environment name of the core printer driver. For rules governing environment names and behaviors, see [\[MS-RPRN\]](#) section 2.2.4.4.

CoreDriverGUID: The GUID of the core printer driver.

ftDriverDate: The date of the core printer driver. [<22>](#)

dwlDriverVersion: The version [<23>](#) of the core printer driver.

pbDriverInstalled: A pointer to a variable that receives one of the following values.

| Value | Meaning |
|-------|---|
| 0 | The driver, or a newer version of the driver, is not installed. |
| 1 | The driver, or a newer version of the driver, is installed. |

Return Values: This method MUST return zero or an HRESULT success value ([\[MS-ERREF\]](#) section 2.1) to indicate successful completion or an HRESULT error value to indicate failure.

Exceptions Thrown: This method MUST NOT throw any exceptions other than those that are thrown by the underlying RPC protocol [\[MS-RPCE\]](#).

Parameter Validation Requirements: Upon receiving this method call, the server MUST validate parameters as follows:

- The string pointed to by the **pszEnvironment** parameter MUST specify one of the supported environment names on the server for that type of driver; otherwise the server MUST return `ERROR_INVALID_ENVIRONMENT`.
- The **pbDriverInstalled** parameter MUST NOT be NULL; otherwise the server MUST return `ERROR_INVALID_PARAMETER`.

If parameter validation fails, the server MUST fail the operation immediately, and return a nonzero error response to the client.

Processing and Response Requirements: If parameter validation succeeds, the server MUST process the method call by:

- Searching for the core printer driver with the specified CoreDriverGUID, ftDriverDate, and dwlDriverVersion in the list of installed core printer drivers on the print server.
- Setting the value of the variable pointed to by **pbDriverInstalled** to 1 if the search succeeded or to zero if not.
- Returning a response that MUST contain the output parameters mentioned above and the status of the operation.

The server MUST NOT change the **List of Core Printer Drivers** as part of processing this method call.

3.1.4.2.11 RpcAsyncGetPrinterDriverPackagePath (Opnum 66)

RpcAsyncGetPrinterDriverPackagePath gets the path to the specified printer driver package.

The counterpart of this method in the Print System Remote Protocol is [RpcGetPrinterDriverPackagePath](#), [MS-RPRN] section 3.1.4.4.10.

```
HRESULT RpcAsyncGetPrinterDriverPackagePath(  
    [in] handle_t hRemoteBinding,  
    [in, string, unique] const wchar_t* pszServer,  
    [in, string] const wchar_t* pszEnvironment,  
    [in, string, unique] const wchar_t* pszLanguage,  
    [in, string] const wchar_t* pszPackageID,  
    [in, out, unique, size_is(cchDriverPackageCab)]  
        wchar_t* pszDriverPackageCab,  
    [in] DWORD cchDriverPackageCab,  
    [out] DWORD* pcchRequiredSize  
);
```

hRemoteBinding: An RPC explicit binding handle.

pszServer: A pointer to a string that contains the name of the print server from which to get the printer driver package path. This string MUST contain a server name that is identical to the server name that was used to create the **hRemoteBinding** parameter. For details on RPC bind handles, see [MS-RPCE]. For rules governing print server names, see [MS-RPRN] section 2.2.4.16.

pszEnvironment: A pointer to a string that contains the environment name for which the driver package path is returned. For rules governing environment names and behaviors, see [MS-RPRN] section 2.2.4.4.

pszLanguage: A pointer to a string that contains the language for which the driver package path is returned. <24> Providing this pointer is optional. If the pointer is not provided, the value of this parameter MUST be NULL.

pszPackageID: A pointer to a string that contains package name. The package name is obtained by calling [RpcAsyncGetCorePrinterDrivers](#).

pszDriverPackageCab: A pointer to a string that contains the path name of the driver package file. [<25>](#) For rules governing path names, see [\[MS-RPRN\]](#) section 2.2.4.9.

pszDriverPackageCab MUST NOT be NULL unless **cchDriverPackageCab** is zero.

cchDriverPackageCab: The size, in characters, of the buffer that is referenced by the **pszDriverPackageCab** parameter. The value of this parameter MAY [<26>](#) be zero.

pcchRequiredSize: A pointer to a variable that receives the required size of the buffer that is pointed to by the **pszDriverPackageCab** parameter.

Return Values: This method MUST return zero or an HRESULT success value ([\[MS-ERREF\]](#) section 2.1) to indicate successful completion or an HRESULT error value to indicate failure.

Exceptions Thrown: This method MUST NOT throw any exceptions other than those that are thrown by the underlying RPC protocol [\[MS-RPCE\]](#).

Parameter Validation Requirements: Upon receiving this method call, the server MUST validate parameters as follows:

- The string pointed to by the **pszEnvironment** parameter MUST specify one of the supported environment names on the server for that type of driver; otherwise the server MUST return `ERROR_INVALID_ENVIRONMENT`.
- The value of the **pszPackageID** parameter MUST NOT be NULL; otherwise the server MUST return `ERROR_INVALID_PARAMETER`.
- The value of the **pcchRequiredSize** parameter MUST NOT be NULL; otherwise the server MUST return `ERROR_INVALID_PARAMETER`.
- The size specified by **cchDriverPackageCab** MUST be sufficient to hold the path name of the driver package file; otherwise the server MUST calculate the required number of characters and write this number to the variable pointed to by the **pcchRequiredSize** output parameter, and return `ERROR_INSUFFICIENT_BUFFER`.

If parameter validation fails, the server MUST fail the operation immediately and return a nonzero error response to the client.

Processing and Response Requirements: If parameter validation succeeds, the server MUST process the method call by:

- Searching for the driver-package **cab file** for the specified **pszPackageID**.
- Returning the driver package cab path for package ID in the output parameter **pszDriverPackageCab**.
- Setting the contents of the parameter **pcchRequiredSize** to the size of the string buffer required to hold the driver package cab.
- Returning a response that MUST contain the output parameters mentioned above and the status of the operation.

The server MUST NOT change the list of driver package cabs as part of processing this method call.

3.1.4.2.12 **RpcAsyncDeletePrinterDriverPackage (Opnum 67)**

RpcAsyncDeletePrinterDriverPackage deletes a specified printer driver package.

```

HRESULT RpcAsyncDeletePrinterDriverPackage(
    [in] handle_t hRemoteBinding,
    [in, string, unique] const wchar_t* pszServer,
    [in, string] const wchar_t* pszInfPath,
    [in, string] const wchar_t* pszEnvironment
);

```

hRemoteBinding: An RPC explicit binding handle.

pszServer: A non-NULL pointer to a **string** that specifies the name of the print server from which to delete the printer driver package. This **string** contains a server name that is identical to the server name that was used to create the **hRemoteBinding** parameter. For details on RPC bind handles, see [\[MS-RPCE\]](#). For rules governing print server names, see [\[MS-RPRN\]](#) section 2.2.4.16.

pszInfPath: A non-NULL pointer to a **string** that specifies the path name of a driver installation control file that specifies the printer driver and MAY<27> be used to delete the driver from the print server. For rules governing path names, see [\[MS-RPRN\]](#) section 2.2.4.9.

pszEnvironment: A non-NULL pointer to a **string** that specifies the environment name for which the driver will be deleted. For rules governing environment names and Windows behavior, see [\[MS-RPRN\]](#) section 2.2.4.4.

Return Values: This method MUST return zero or an HRESULT success value ([\[MS-ERREF\]](#) section 2.1) to indicate successful completion or an HRESULT error value to indicate failure.

Exceptions Thrown: This method MUST NOT throw any exceptions other than those that are thrown by the underlying RPC protocol [\[MS-RPCE\]](#).

Parameter Validation Requirements: Upon receiving this method call, the server MUST validate parameters as follows:

- The string pointed to by the **pszInfPath** parameter MUST contain an existing path name; otherwise the server MUST return ERROR_INVALID_PARAMETER.
- The string pointed to by the **pszEnvironment** parameter MUST specify one of the supported environment names on the server for that type of driver; otherwise the server MUST return ERROR_INVALID_ENVIRONMENT.

Additional validation SHOULD<28> be performed.

If parameter validation fails, the server MUST fail the operation immediately and return a nonzero error response to the client.

Processing and Response Requirements: If parameter validation succeeds, the server MUST search for the driver package based on **pszInfPath** and determine if the driver package is in use on the print server. A driver package is in use on a server if at least one printer driver on the server has been installed from the driver package as described in section [3.1.4.2.7](#), or if the driver package contains a core printer driver on which other printer drivers on the server depend. If the driver package is in use on the server, the server MUST return ERROR_PRINTER_DRIVER_PACKAGE_IN_USE. If the driver package is not in use, the server MUST delete it from the driver store of the print server.

If the operation is successful, the server MUST delete the driver package from the driver store of the print server, before returning a response that contains the status of the operation.

3.1.4.3 Printer-Port Management Methods

The Printer-Port Management methods support the discovery and communication with printer ports. The following table presents a list of printer-port management methods and their counterparts in the Print System Remote Protocol [\[MS-RPRN\]](#). All methods are specified in sections that follow.

Parameter descriptions, parameter validation, and processing and response requirements that are not specified in methods of the Print System Asynchronous Remote protocol [\[MS-PAR\]](#) are specified in the corresponding methods of the Print System Remote protocol [\[MS-RPRN\]](#).

| [MS-PAR] method | Description | [MS-RPRN] method |
|-----------------------------------|--|----------------------------------|
| RpcAsyncXcvData | RpcAsyncXcvData provides the means by which a port monitor client component can communicate with its server-side counterpart, the actual port-monitor hosted by the server. Opnum 33 | RpcXcvData |
| RpcAsyncEnumPorts | RpcAsyncEnumPorts enumerates the ports that are available for printing on a specified server. Opnum 47 | RpcEnumPorts |
| RpcAsyncAddPort | RpcAsyncAddPort adds a specified port name to the list of supported ports on a specified print server. Opnum 49 | RpcAddPortEx |
| RpcAsyncSetPort | RpcAsyncSetPort sets the status associated with a specified port on a specified print server. Opnum 50 | RpcSetPort |

3.1.4.3.1 RpcAsyncXcvData (Opnum 33)

RpcAsyncXcvData provides the means by which a port monitor client component can communicate with its server-side counterpart, the actual port monitor hosted by the server.

The counterpart of this method in the Print System Remote Protocol is **RpcXcvData**. All parameters not defined below are specified in [\[MS-RPRN\]](#) section 3.1.4.6.5.

```
DWORD RpcAsyncXcvData(  
    [in] PRINTER_HANDLE hXcv,  
    [in, string] const wchar_t* pszDataName,  
    [in, size_is(cbInputData)] unsigned char* pInputData,  
    [in] DWORD cbInputData,  
    [out, size_is(cbOutputData)] unsigned char* pOutputData,  
    [in] DWORD cbOutputData,  
    [out] DWORD* pcbOutputNeeded,  
    [in, out] DWORD* pdwStatus  
);
```

hXcv: A handle to a port object that has been opened by using [RpcAsyncOpenPrinter \(section 3.1.4.1.1\)](#).

Return Values: This method MUST return zero to indicate successful completion or a nonzero Win32 error code ([\[MS-ERREF\]](#) section 2.2) to indicate failure. Aside from the specific nonzero

return values documented in section [3.1.4](#), the client MUST treat any nonzero return value as a fatal error.

Exceptions Thrown: This method MUST NOT throw any exceptions other than those that are thrown by the underlying RPC protocol [\[MS-RPCE\]](#).

This method MUST adhere to the parameter validation, processing, and response requirements that are specified in [\[MS-RPRN\]](#) section 3.1.4.6.5.

3.1.4.3.2 RpcAsyncEnumPorts (Opnum 47)

RpcAsyncEnumPorts enumerates the ports that are available for printing on a specified server.

The counterpart of this method in the Print System Remote Protocol is **RpcEnumPorts**. All parameters not defined below are specified in [\[MS-RPRN\]](#) section 3.1.4.6.1.

```
DWORD RpcAsyncEnumPorts(  
    [in] handle_t hRemoteBinding,  
    [in, string, unique] wchar_t* pName,  
    [in] DWORD Level,  
    [in, out, unique, size_is(cbBuf)]  
        unsigned char* pPort,  
    [in] DWORD cbBuf,  
    [out] DWORD* pcbNeeded,  
    [out] DWORD* pcReturned  
);
```

hRemoteBinding: An RPC explicit binding handle.

Return Values: This method MUST return zero to indicate successful completion or a nonzero Win32 error code ([\[MS-ERREF\]](#) section 2.2) to indicate failure. Aside from the specific nonzero return values documented in section [3.1.4](#), the client MUST treat any nonzero return value as a fatal error.

Exceptions Thrown: This method MUST NOT throw any exceptions other than those that are thrown by the underlying RPC protocol [\[MS-RPCE\]](#).

This method MUST adhere to the parameter validation, processing, and response requirements that are specified in [\[MS-RPRN\]](#) section 3.1.4.6.1.

3.1.4.3.3 RpcAsyncAddPort (Opnum 49)

RpcAsyncAddPort adds a specified port name to the list of supported ports on a specified print server.

The counterpart of this method in the Print System Remote Protocol is **RpcAddPortEx**. All parameters not defined below are specified in [\[MS-RPRN\]](#) section 3.1.4.6.3.

```
DWORD RpcAsyncAddPort(  
    [in] handle_t hRemoteBinding,  
    [in, string, unique] wchar_t* pName,  
    [in] PORT_CONTAINER* pPortContainer,  
    [in] PORT_VAR_CONTAINER* pPortVarContainer,  
    [in, string] wchar_t* pMonitorName  
);
```

hRemoteBinding: An RPC explicit binding handle. RPC binding handles are specified in [\[C706\]](#) section [2.3](#).

Return Values: This method MUST return zero to indicate successful completion or a nonzero Win32 error code ([\[MS-ERREF\]](#) section 2.2) to indicate failure. The client MUST treat any nonzero return value as a fatal error.

Exceptions Thrown: This method MUST NOT throw any exceptions other than those that are thrown by the underlying RPC protocol [\[MS-RPCE\]](#).

This method MUST adhere to the parameter validation, processing, and response requirements that are specified in [\[MS-RPRN\]](#) section 3.1.4.6.3.

3.1.4.3.4 RpcAsyncSetPort (Opnum 50)

RpcAsyncSetPort sets the status associated with a specified port on a specified print server.

The counterpart of this method in the Print System Remote Protocol is **RpcSetPort**. All parameters not defined below are specified in [\[MS-RPRN\]](#) section 3.1.4.6.4.

```
DWORD RpcAsyncSetPort(  
    [in] handle_t hRemoteBinding,  
    [in, string, unique] wchar_t* pName,  
    [in, string, unique] wchar_t* pPortName,  
    [in] PORT_CONTAINER* pPortContainer  
);
```

hRemoteBinding: An RPC explicit binding handle.

Return Values: This method MUST return zero to indicate successful completion or a nonzero Win32 error code ([\[MS-ERREF\]](#) section 2.2) to indicate failure. The client MUST treat any nonzero return value as a fatal error.

Exceptions Thrown: This method MUST NOT throw any exceptions other than those that are thrown by the underlying RPC protocol [\[MS-RPCE\]](#).

This method MUST adhere to the parameter validation, processing, and response requirements that are specified in [\[MS-RPRN\]](#) section 3.1.4.6.4.

3.1.4.4 Print-Processor Management Methods

The Print-Processor Management methods support the discovery and manipulation of print processor objects. The following table presents a list of print processor management methods and their counterparts in the Print System Remote Protocol [\[MS-RPRN\]](#). All methods are specified in sections that follow.

Parameter descriptions, parameter validation, and processing and response requirements that are not specified in methods of the Print System Asynchronous Remote protocol [\[MS-PAR\]](#) are specified in the corresponding methods of the Print System Remote protocol [\[MS-RPRN\]](#).

| [MS-PAR] method | Description | [MS-RPRN] method |
|---|--|--------------------------------------|
| RpcAsyncAddPrintProcessor | RpcAsyncAddPrintProcessor installs a specified print processor on the specified server and adds its name to an internal list of supported | RpcAddPrintProcessor |

| [MS-PAR] method | Description | [MS-RPRN] method |
|---|---|--|
| | print processors. Opnum 44 | |
| RpcAsyncEnumPrintProcessors | RpcAsyncEnumPrintProcessors enumerates the print processors installed on a specified server. Opnum 45 | RpcEnumPrintProcessors |
| RpcAsyncGetPrintProcessorDirectory | RpcAsyncGetPrintProcessorDirectory retrieves the path for the print processor on the specified server. Opnum 46 | RpcGetPrintProcessorDirectory |
| RpcAsyncDeletePrintProcessor | RpcAsyncDeletePrintProcessor removes a specified print processor from a specified server. Opnum 53 | RpcDeletePrintProcessor |
| RpcAsyncEnumPrintProcessorDatatypes | RpcAsyncEnumPrintProcessorDatatypes enumerates the data types that a specified print processor supports. Opnum 54 | RpcEnumPrintProcessorDatatypes |

3.1.4.4.1 RpcAsyncAddPrintProcessor (Opnum 44)

RpcAsyncAddPrintProcessor installs a specified print processor on the specified server and adds its name to an internal list of supported print processors.

The counterpart of this method in the Print System Remote Protocol is **RpcAddPrintProcessor**. All parameters not defined below are specified in [\[MS-RPRN\]](#) section 3.1.4.8.1.

```
DWORD RpcAsyncAddPrintProcessor(
    [in] handle_t hRemoteBinding,
    [in, string, unique] wchar_t* pName,
    [in, string] wchar_t* pEnvironment,
    [in, string] wchar_t* pPathName,
    [in, string] wchar_t* pPrintProcessorName
);
```

hRemoteBinding: An RPC explicit binding handle.

Return Values: This method MUST return zero to indicate successful completion or a nonzero Win32 error code ([\[MS-ERREF\]](#) section 2.2) to indicate failure. The client MUST treat any nonzero return value as a fatal error.

Exceptions Thrown: This method MUST NOT throw any exceptions other than those that are thrown by the underlying RPC protocol [\[MS-RPCE\]](#).

This method MUST adhere to the parameter validation, processing, and response requirements that are specified in [\[MS-RPRN\]](#) section 3.1.4.8.1.

3.1.4.4.2 RpcAsyncEnumPrintProcessors (Opnum 45)

RpcAsyncEnumPrintProcessors enumerates the print processors installed on a specified server.

The counterpart of this method in the Print System Remote Protocol is **RpcEnumPrintProcessors**. All parameters not defined below are specified in [\[MS-RPRN\]](#) section 3.1.4.8.2.

```
DWORD RpcAsyncEnumPrintProcessors(  
    [in] handle_t hRemoteBinding,  
    [in, string, unique] wchar_t* pName,  
    [in, string, unique] wchar_t* pEnvironment,  
    [in] DWORD Level,  
    [in, out, unique, size_is(cbBuf)]  
        unsigned char* pPrintProcessorInfo,  
    [in] DWORD cbBuf,  
    [out] DWORD* pcbNeeded,  
    [out] DWORD* pcReturned  
);
```

hRemoteBinding: An RPC explicit binding handle.

Return Values: This method MUST return zero to indicate successful completion or a nonzero Win32 error code ([\[MS-ERREF\]](#) section 2.2) to indicate failure. Aside from the specific nonzero return values documented in section [3.1.4](#), the client MUST treat any nonzero return value as a fatal error.

Exceptions Thrown: This method MUST NOT throw any exceptions other than those that are thrown by the underlying RPC protocol [\[MS-RPCE\]](#).

This method MUST adhere to the parameter validation, processing, and response requirements that are specified in [\[MS-RPRN\]](#) section 3.1.4.8.2.

3.1.4.4.3 RpcAsyncGetPrintProcessorDirectory (Opnum 46)

RpcAsyncGetPrintProcessorDirectory retrieves the path for the print processor on the specified server.

The counterpart of this method in the Print System Remote Protocol is **RpcGetPrintProcessorDirectory**. All parameters not defined below are specified in [\[MS-RPRN\]](#) section 3.1.4.8.3.

```
DWORD RpcAsyncGetPrintProcessorDirectory(  
    [in] handle_t hRemoteBinding,  
    [in, string, unique] wchar_t* pName,  
    [in, string, unique] wchar_t* pEnvironment,  
    [in] DWORD Level,  
    [in, out, unique, size_is(cbBuf)]  
        unsigned char* pPrintProcessorDirectory,  
    [in] DWORD cbBuf,  
    [out] DWORD* pcbNeeded  
);
```

hRemoteBinding: An RPC explicit binding handle.

Return Values: This method MUST return zero to indicate successful completion or a nonzero Win32 error code ([\[MS-ERREF\]](#) section 2.2) to indicate failure. Aside from the specific nonzero

return values documented in section [3.1.4](#), the client MUST treat any nonzero return value as a fatal error.

Exceptions Thrown: This method MUST NOT throw any exceptions other than those that are thrown by the underlying RPC protocol [\[MS-RPCE\]](#).

This method MUST adhere to the parameter validation, processing, and response requirements that are specified in [\[MS-RPRN\]](#) section 3.1.4.8.3.

3.1.4.4.4 **RpcAsyncDeletePrintProcessor (Opnum 53)**

RpcAsyncDeletePrintProcessor removes a specified print processor from a specified server.

The counterpart of this method in the Print System Remote Protocol is **RpcDeletePrintProcessor**. All parameters not defined below are specified in [\[MS-RPRN\]](#) section 3.1.4.8.4.

```
DWORD RpcAsyncDeletePrintProcessor(  
    [in] handle_t hRemoteBinding,  
    [in, string, unique] wchar_t* Name,  
    [in, string, unique] wchar_t* pEnvironment,  
    [in, string] wchar_t* pPrintProcessorName  
);
```

hRemoteBinding: An RPC explicit binding handle.

Return Values: This method MUST return zero to indicate successful completion or a nonzero Win32 error code ([\[MS-ERREF\]](#) section 2.2) to indicate failure. The client MUST treat any nonzero return value as a fatal error.

Exceptions Thrown: This method MUST NOT throw any exceptions other than those that are thrown by the underlying RPC protocol [\[MS-RPCE\]](#).

This method MUST adhere to the parameter validation, processing, and response requirements that are specified in [\[MS-RPRN\]](#) section 3.1.4.8.4.

3.1.4.4.5 **RpcAsyncEnumPrintProcessorDatatypes (Opnum 54)**

RpcAsyncEnumPrintProcessorDatatypes enumerates the data types that a specified print processor supports.

The counterpart of this method in the Print System Remote Protocol is **RpcEnumPrintProcessorDatatypes**. All parameters not defined below are specified in [\[MS-RPRN\]](#) section 3.1.4.8.5.

```
DWORD RpcAsyncEnumPrintProcessorDatatypes(  
    [in] handle_t hRemoteBinding,  
    [in, string, unique] wchar_t* pName,  
    [in, string, unique] wchar_t* pPrintProcessorName,  
    [in] DWORD Level,  
    [in, out, unique, size_is(cbBuf)]  
        unsigned char* pDatatypes,  
    [in] DWORD cbBuf,  
    [out] DWORD* pcbNeeded,  
    [out] DWORD* pcReturned  
);
```

hRemoteBinding: An RPC explicit binding handle.

Return Values: This method MUST return zero to indicate successful completion or a nonzero Win32 error code ([\[MS-ERREF\]](#) section 2.2) to indicate failure. Aside from the specific nonzero return values documented in section [3.1.4](#), the client MUST treat any nonzero return value as a fatal error.

Exceptions Thrown: This method MUST NOT throw any exceptions other than those that are thrown by the underlying RPC protocol [\[MS-RPCE\]](#).

This method MUST adhere to the parameter validation, processing, and response requirements that are specified in [\[MS-RPRN\]](#) section 3.1.4.8.5.

3.1.4.5 Port Monitor Management Methods

The Port Monitor Management methods support the discovery and installation of port monitor modules. The following table presents a list of port monitor management methods and their counterparts in the Print System Remote Protocol [\[MS-RPRN\]](#). All methods are specified in sections that follow.

Parameter descriptions, parameter validation, and processing and response requirements that are not specified in methods of the Print System Asynchronous Remote protocol [\[MS-PAR\]](#) are specified in the corresponding methods of the Print System Remote protocol [\[MS-RPRN\]](#).

| [MS-PAR] method | Description | [MS-RPRN] method |
|---------------------------------------|--|----------------------------------|
| RpcAsyncEnumMonitors | RpcAsyncEnumMonitors retrieves information about the port monitors installed on a specified server. Opnum 48 | RpcEnumMonitors |
| RpcAsyncAddMonitor | RpcAsyncAddMonitor installs a specified local port monitor, and links the configuration, data, and monitor files on a specified print server. Opnum 51 | RpcAddMonitor |
| RpcAsyncDeleteMonitor | RpcAsyncDeleteMonitor removes a specified port monitor from a specified print server. Opnum 52 | RpcDeleteMonitor |

3.1.4.5.1 RpcAsyncEnumMonitors (Opnum 48)

RpcAsyncEnumMonitors retrieves information about the port monitors installed on a specified server.

The counterpart of this method in the Print System Remote Protocol is **RpcEnumMonitors**. All parameters not defined below are specified in [\[MS-RPRN\]](#) section 3.1.4.7.1.

```
DWORD RpcAsyncEnumMonitors(  
    [in] handle_t hRemoteBinding,  
    [in, string, unique] wchar_t* pName,  
    [in] DWORD Level,  
    [in, out, unique, size_is(cbBuf)]  
        unsigned char* pMonitor,  
    [in] DWORD cbBuf,
```

```
[out] DWORD* pcbNeeded,  
[out] DWORD* pcReturned  
);
```

hRemoteBinding: An RPC explicit binding handle.

Return Values: This method MUST return zero to indicate successful completion or a nonzero Win32 error code ([\[MS-ERREF\]](#) section 2.2) to indicate failure. Aside from the specific nonzero return values documented in section [3.1.4](#), the client MUST treat any nonzero return value as a fatal error.

Exceptions Thrown: This method MUST NOT throw any exceptions other than those that are thrown by the underlying RPC protocol [\[MS-RPCE\]](#).

This method MUST adhere to the parameter validation, processing, and response requirements that are specified in [\[MS-RPRN\]](#) section 3.1.4.7.1.

3.1.4.5.2 RpcAsyncAddMonitor (Opnum 51)

RpcAsyncAddMonitor installs a specified local port monitor, and links the configuration, data, and monitor files on a specified print server.

The counterpart of this method in the Print System Remote Protocol is **RpcAddMonitor**. All parameters not defined below are specified in [\[MS-RPRN\]](#) section 3.1.4.7.2.

```
DWORD RpcAsyncAddMonitor(  
[in] handle_t hRemoteBinding,  
[in, string, unique] wchar_t* Name,  
[in] MONITOR_CONTAINER* pMonitorContainer  
);
```

hRemoteBinding: An RPC explicit binding handle.

Return Values: This method MUST return zero to indicate successful completion or a nonzero Win32 error code ([\[MS-ERREF\]](#) section 2.2) to indicate failure. The client MUST treat any nonzero return value as a fatal error.

Exceptions Thrown: This method MUST NOT throw any exceptions other than those that are thrown by the underlying RPC protocol [\[MS-RPCE\]](#).

This method MUST adhere to the parameter validation, processing, and response requirements that are specified in [\[MS-RPRN\]](#) section 3.1.4.7.2.

3.1.4.5.3 RpcAsyncDeleteMonitor (Opnum 52)

RpcAsyncDeleteMonitor removes a specified port monitor from a specified print server.

The counterpart of this method in the Print System Remote Protocol is **RpcDeleteMonitor**. All parameters not defined below are specified in [\[MS-RPRN\]](#) section 3.1.4.7.3.

```
DWORD RpcAsyncDeleteMonitor(  
[in] handle_t hRemoteBinding,  
[in, string, unique] wchar_t* Name,  
[in, string, unique] wchar_t* pEnvironment,  
[in, string] wchar_t* pMonitorName  
);
```

);

hRemoteBinding: An RPC explicit binding handle.

Return Values: This method MUST return zero to indicate successful completion or a nonzero Win32 error code ([\[MS-ERREF\]](#) section 2.2) to indicate failure. The client MUST treat any nonzero return value as a fatal error.

Exceptions Thrown: This method MUST NOT throw any exceptions other than those that are thrown by the underlying RPC protocol [\[MS-RPCE\]](#).

This method MUST adhere to the parameter validation, processing, and response requirements that are specified in [\[MS-RPRN\]](#) section 3.1.4.7.3.

3.1.4.6 Form Management Methods

The Form Management methods support the discovery and configuration of printer forms. The following table presents a list of form management methods and their counterparts in the Print System Remote Protocol [\[MS-RPRN\]](#). All methods are specified in sections that follow.

Parameter descriptions, parameter validation, and processing and response requirements that are not specified in methods of the Print System Asynchronous Remote protocol [\[MS-PAR\]](#) are specified in the corresponding methods of the Print System Remote protocol [\[MS-RPRN\]](#).

| [MS-PAR] method | Description | [MS-RPRN] method |
|------------------------------------|--|----------------------------------|
| RpcAsyncAddForm | RpcAsyncAddForm adds a form name to the list of supported forms. Opnum 21 | RpcAddForm |
| RpcAsyncDeleteForm | RpcAsyncDeleteForm removes a form name from the list of supported forms. Opnum 22 | RpcDeleteForm |
| RpcAsyncGetForm | RpcAsyncGetForm retrieves information about a specified form. Opnum 23 | RpcGetForm |
| RpcAsyncSetForm | RpcAsyncSetForm sets the form information for the specified printer. Opnum 24 | RpcSetForm |
| RpcAsyncEnumForms | RpcAsyncEnumForms enumerates the forms that the specified printer supports. Opnum 25 | RpcEnumForms |

3.1.4.6.1 RpcAsyncAddForm (Opnum 21)

RpcAsyncAddForm adds a form name to the list of supported printer forms.

The counterpart of this method in the Print System Remote Protocol is **RpcAddForm**. All parameters not defined below are specified in [\[MS-RPRN\]](#) section 3.1.4.5.1.

```

DWORD RpcAsyncAddForm(
    [in] PRINTER_HANDLE hPrinter,
    [in] FORM_CONTAINER* pFormInfoContainer
);

```

hPrinter: A handle to a printer object or server object that has been opened by using either [RpcAsyncOpenPrinter \(section 3.1.4.1.1\)](#) or [RpcAsyncAddPrinter \(section 3.1.4.1.2\)](#).

Return Values: This method MUST return zero to indicate successful completion or a nonzero Win32 error code ([\[MS-ERREF\]](#) section 2.2) to indicate failure. The client MUST treat any nonzero return value as a fatal error.

Exceptions Thrown: This method MUST NOT throw any exceptions other than those that are thrown by the underlying RPC protocol [\[MS-RPCE\]](#).

This method MUST adhere to the parameter validation, processing, and response requirements that are specified in [\[MS-RPRN\]](#) section 3.1.4.5.1.

3.1.4.6.2 RpcAsyncDeleteForm (Opnum 22)

RpcAsyncDeleteForm removes a form name from the list of supported printer forms.

The counterpart of this method in the Print System Remote Protocol is **RpcDeleteForm**. All parameters not defined below are specified in [\[MS-RPRN\]](#) section 3.1.4.5.2.

```

DWORD RpcAsyncDeleteForm(
    [in] PRINTER_HANDLE hPrinter,
    [in, string] wchar_t* pFormName
);

```

hPrinter: A handle to a printer object or server object that has been opened by using either [RpcAsyncOpenPrinter \(section 3.1.4.1.1\)](#) or [RpcAsyncAddPrinter \(section 3.1.4.1.2\)](#).

Return Values: This method MUST return zero to indicate successful completion or a nonzero Win32 error code ([\[MS-ERREF\]](#) section 2.2) to indicate failure. The client MUST treat any nonzero return value as a fatal error.

Exceptions Thrown: This method MUST NOT throw any exceptions other than those that are thrown by the underlying RPC protocol [\[MS-RPCE\]](#).

This method MUST adhere to the parameter validation, processing, and response requirements that are specified in [\[MS-RPRN\]](#) section 3.1.4.5.2.

3.1.4.6.3 RpcAsyncGetForm (Opnum 23)

RpcAsyncGetForm retrieves information about a specified printer form.

The counterpart of this method in the Print System Remote Protocol is **RpcGetForm**. All parameters not defined below are specified in [\[MS-RPRN\]](#) section 3.1.4.5.3.

```

DWORD RpcAsyncGetForm(
    [in] PRINTER_HANDLE hPrinter,
    [in, string] wchar_t* pFormName,
    [in] DWORD Level,
    [in, out, unique, size_is(cbBuf)]
);

```

```

    unsigned char* pForm,
    [in] DWORD cbBuf,
    [out] DWORD* pcbNeeded
);

```

hPrinter: A handle to a printer object or server object that has been opened by using either [RpcAsyncOpenPrinter \(section 3.1.4.1.1\)](#) or [RpcAsyncAddPrinter \(section 3.1.4.1.2\)](#).

Return Values: This method MUST return zero to indicate successful completion or a nonzero Win32 error code ([\[MS-ERREF\]](#) section 2.2) to indicate failure. Aside from the specific nonzero return values documented in section [3.1.4](#), the client MUST treat any nonzero return value as a fatal error.

Exceptions Thrown: This method MUST NOT throw any exceptions other than those that are thrown by the underlying RPC protocol [\[MS-RPCE\]](#).

This method MUST adhere to the parameter validation, processing, and response requirements that are specified in [\[MS-RPRN\]](#) section 3.1.4.5.3.

3.1.4.6.4 RpcAsyncSetForm (Opnum 24)

RpcAsyncSetForm sets the printer form information for the specified printer.

The counterpart of this method in the Print System Remote Protocol is **RpcSetForm**. All parameters not defined below are specified in [\[MS-RPRN\]](#) section 3.1.4.5.4.

```

DWORD RpcAsyncSetForm(
    [in] PRINTER_HANDLE hPrinter,
    [in, string] wchar_t* pFormName,
    [in] FORM_CONTAINER* pFormInfoContainer
);

```

hPrinter: A handle to a printer object or server object that has been opened by using either [RpcAsyncOpenPrinter \(section 3.1.4.1.1\)](#) or [RpcAsyncAddPrinter \(section 3.1.4.1.2\)](#).

Return Values: This method MUST return zero to indicate successful completion or a nonzero Win32 error code ([\[MS-ERREF\]](#) section 2.2) to indicate failure. The client MUST treat any nonzero return value as a fatal error.

Exceptions Thrown: This method MUST NOT throw any exceptions other than those that are thrown by the underlying RPC protocol [\[MS-RPCE\]](#).

This method MUST adhere to the parameter validation, processing, and response requirements that are specified in [\[MS-RPRN\]](#) section 3.1.4.5.4.

3.1.4.6.5 RpcAsyncEnumForms (Opnum 25)

RpcAsyncEnumForms enumerates the printer forms that the specified printer supports.

The counterpart of this method in the Print System Remote Protocol is **RpcEnumForms**. All parameters not defined below are specified in [\[MS-RPRN\]](#) section 3.1.4.5.5.

```

DWORD RpcAsyncEnumForms(
    [in] PRINTER_HANDLE hPrinter,
    [in] DWORD Level,

```

```

[in, out, unique, size_is(cbBuf)]
    unsigned char* pForm,
[in] DWORD cbBuf,
[out] DWORD* pcbNeeded,
[out] DWORD* pcReturned
);

```

hPrinter: A handle to a printer object or server object that has been opened by using either [RpcAsyncOpenPrinter \(section 3.1.4.1.1\)](#) or [RpcAsyncAddPrinter \(section 3.1.4.1.2\)](#).

Return Values: This method MUST return zero to indicate successful completion or a nonzero Win32 error code ([\[MS-ERREF\]](#) section 2.2) to indicate failure. Aside from the specific nonzero return values documented in section [3.1.4](#), the client MUST treat any nonzero return value as a fatal error.

Exceptions Thrown: This method MUST NOT throw any exceptions other than those that are thrown by the underlying RPC protocol [\[MS-RPCE\]](#).

This method MUST adhere to the parameter validation, processing, and response requirements that are specified in [\[MS-RPRN\]](#) section 3.1.4.5.5.

3.1.4.7 Job Management Methods

The Job Management methods support the discovery, definition, and scheduling of print jobs. The following table presents a list of job management methods and their counterparts in the Print System Remote Protocol [\[MS-RPRN\]](#). All methods are specified in sections that follow.

Parameter descriptions, parameter validation, and processing and response requirements that are not specified in methods of the Print System Asynchronous Remote protocol [\[MS-PAR\]](#) are specified in the corresponding methods of the Print System Remote protocol [\[MS-RPRN\]](#).

| [MS-PAR] method | Description | [MS-RPRN] method |
|-------------------------------------|---|--------------------------------|
| RpcAsyncSetJob | RpcAsyncSetJob pauses, resumes, cancels, or restarts a print job on a specified printer. This method can also set print job parameters, including the job priority and document name. Opnum 2 | RpcSetJob |
| RpcAsyncGetJob | RpcAsyncGetJob retrieves information about a specified print job on a specified printer. Opnum 3 | RpcGetJob |
| RpcAsyncEnumJobs | RpcAsyncEnumJobs retrieves information about a specified set of print jobs on a specified printer. Opnum 4 | RpcEnumJobs |
| RpcAsyncAddJob | RpcAsyncAddJob returns ERROR_INVALID_PARAMETER Opnum 5 | RpcAddJob |
| RpcAsyncScheduleJob | RpcAsyncScheduleJob returns ERROR_SPL_NO_ADDJOB . Opnum 6 | RpcScheduleJob |

3.1.4.7.1 RpcAsyncSetJob (Opnum 2)

RpcAsyncSetJob pauses, resumes, cancels, or restarts a print job on a specified printer. This method can also set print job parameters, including the job priority and document name.

The counterpart of this method in the Print System Remote Protocol is **RpcSetJob**. All parameters not defined below are specified in [\[MS-RPRN\]](#) section 3.1.4.3.1.

```
DWORD RpcAsyncSetJob(  
    [in] PRINTER_HANDLE hPrinter,  
    [in] DWORD JobId,  
    [in, unique] JOB_CONTAINER* pJobContainer,  
    [in] DWORD Command  
);
```

hPrinter: A handle to a printer object that has been opened by using either [RpcAsyncOpenPrinter \(section 3.1.4.1.1\)](#) or [RpcAsyncAddPrinter \(section 3.1.4.1.2\)](#).

Return Values: This method MUST return zero to indicate successful completion or a nonzero Win32 error code ([\[MS-ERREF\]](#) section 2.2) to indicate failure. The client MUST treat any nonzero return value as a fatal error.

Exceptions Thrown: This method MUST NOT throw any exceptions other than those that are thrown by the underlying RPC protocol [\[MS-RPCE\]](#).

This method MUST adhere to the parameter validation, processing, and response requirements that are specified in [\[MS-RPRN\]](#) section 3.1.4.3.1.

3.1.4.7.2 RpcAsyncGetJob (Opnum 3)

RpcAsyncGetJob retrieves information about a specified print job on a specified printer.

The counterpart of this method in the Print System Remote Protocol is **RpcGetJob**. All parameters not defined below are specified in [\[MS-RPRN\]](#) section 3.1.4.3.2.

```
DWORD RpcAsyncGetJob(  
    [in] PRINTER_HANDLE hPrinter,  
    [in] DWORD JobId,  
    [in] DWORD Level,  
    [in, out, unique, size_is(cbBuf)]  
    unsigned char* pJob,  
    [in] DWORD cbBuf,  
    [out] DWORD* pcbNeeded  
);
```

hPrinter: A handle to a printer object that has been opened by using either [RpcAsyncOpenPrinter \(section 3.1.4.1.1\)](#) or [RpcAsyncAddPrinter \(section 3.1.4.1.2\)](#).

Return Values: This method MUST return zero to indicate successful completion or a nonzero Win32 error code ([\[MS-ERREF\]](#) section 2.2) to indicate failure. Aside from the specific nonzero return values documented in section [3.1.4](#), the client MUST treat any nonzero return value as a fatal error.

Exceptions Thrown: This method MUST NOT throw any exceptions other than those that are thrown by the underlying RPC protocol [\[MS-RPCE\]](#).

This method MUST adhere to the parameter validation, processing, and response requirements that are specified in [\[MS-RPRN\]](#) section 3.1.4.3.2.

3.1.4.7.3 RpcAsyncEnumJobs (Opnum 4)

RpcAsyncEnumJobs retrieves information about a specified set of print jobs on a specified printer.

The counterpart of this method in the Print System Remote Protocol is **RpcEnumJobs**. All parameters not defined below are specified in [\[MS-RPRN\]](#) section 3.1.4.3.3.

```
DWORD RpcAsyncEnumJobs(  
    [in] PRINTER_HANDLE hPrinter,  
    [in] DWORD FirstJob,  
    [in] DWORD NoJobs,  
    [in] DWORD Level,  
    [in, out, unique, size_is(cbBuf)]  
        unsigned char* pJob,  
    [in] DWORD cbBuf,  
    [out] DWORD* pcbNeeded,  
    [out] DWORD* pcReturned  
);
```

hPrinter: A handle to a printer object that has been opened by using either [RpcAsyncOpenPrinter \(section 3.1.4.1.1\)](#) or [RpcAsyncAddPrinter \(section 3.1.4.1.2\)](#).

Return Values: This method MUST return zero to indicate successful completion or a nonzero Win32 error code ([\[MS-ERREF\]](#) section 2.2) to indicate failure. Aside from the specific nonzero return values documented in section [3.1.4](#), the client MUST treat any nonzero return value as a fatal error.

Exceptions Thrown: This method MUST NOT throw any exceptions other than those that are thrown by the underlying RPC protocol [\[MS-RPCE\]](#).

This method MUST adhere to the parameter validation, processing, and response requirements that are specified in [\[MS-RPRN\]](#) section 3.1.4.3.3.

3.1.4.7.4 RpcAsyncAddJob (Opnum 5)

RpcAsyncAddJob does not perform any function, but returns **ERROR_INVALID_PARAMETER**.

The counterpart of this method in the Print System Remote Protocol is **RpcAddJob**. All parameters not defined below are specified in [\[MS-RPRN\]](#) section 3.1.4.3.4.

```
DWORD RpcAsyncAddJob(  
    [in] PRINTER_HANDLE hPrinter,  
    [in] DWORD Level,  
    [in, out, unique, size_is(cbBuf)]  
        unsigned char* pAddJob,  
    [in] DWORD cbBuf,  
    [out] DWORD* pcbNeeded  
);
```

hPrinter: A handle to a printer object that was opened using either [RpcAsyncOpenPrinter \(section 3.1.4.1.1\)](#) or [RpcAsyncAddPrinter \(section 3.1.4.1.2\)](#).

Return Values: This method MUST return **ERROR_INVALID_PARAMETER** ([\[MS-ERREF\]](#) section 2.2).

This method MUST be implemented to ensure compatibility with protocol clients.

3.1.4.7.5 RpcAsyncScheduleJob (Opnum 6)

RpcAsyncScheduleJob does not perform any function, but returns **ERROR_SPL_NO_ADDJOB**.

The counterpart of this method in the Print System Remote Protocol is **RpcScheduleJob**. All parameters not defined below are specified in [\[MS-RPRN\]](#) section 3.1.4.3.5.

```
DWORD RpcAsyncScheduleJob(  
    [in] PRINTER_HANDLE hPrinter,  
    [in] DWORD JobId  
);
```

hPrinter: A handle to a printer object that was opened using either [RpcAsyncOpenPrinter \(section 3.1.4.1.1\)](#) or [RpcAsyncAddPrinter \(section 3.1.4.1.2\)](#).

Return Values: This method MUST return **ERROR_SPL_NO_ADDJOB** ([\[MS-ERREF\]](#) section 2.2).

This method MUST be implemented to ensure compatibility with protocol clients.

3.1.4.8 Job Printing Methods

The Job Printing methods support the adding of documents, pages, and text to print jobs. The following table presents a list of job printing methods and their counterparts in the Print System Remote Protocol [\[MS-RPRN\]](#). All methods are specified in sections that follow.

Parameter descriptions, parameter validation, and processing and response requirements that are not specified in methods of the Print System Asynchronous Remote protocol [\[MS-PAR\]](#) are specified in the corresponding methods of the Print System Remote protocol [\[MS-RPRN\]](#).

| [MS-PAR] method | Description | [MS-RPRN] method |
|--|--|-------------------------------------|
| RpcAsyncStartDocPrinter | RpcAsyncStartDocPrinter notifies a specified printer that a document is being spooled for printing. Opnum 10 | RpcStartDocPrinter |
| RpcAsyncStartPagePrinter | RpcAsyncStartPagePrinter notifies a specified printer that a page is about to be printed. Opnum 11 | RpcStartPagePrinter |
| RpcAsyncWritePrinter | RpcAsyncWritePrinter adds data to the file representing the spool file for a specified printer, if the spooling option is turned on; or it sends data to the device directly, if the printer is configured for direct printing. Opnum 12 | RpcWritePrinter |
| RpcAsyncEndPagePrinter | RpcAsyncEndPagePrinter notifies a specified printer that the application is at the end of a | RpcEndPagePrinter |

| [MS-PAR] method | Description | [MS-RPRN] method |
|---------------------------------------|--|----------------------------------|
| | page in a print job. Opnum 13 | |
| RpcAsyncEndDocPrinter | RpcAsyncEndDocPrinter signals the completion of the current print job on a specified printer. Opnum 14 | RpcEndDocPrinter |
| RpcAsyncAbortPrinter | The RpcAsyncAbortPrinter method aborts the current document on a specified printer. Opnum 15 | RpcAbortPrinter |
| RpcAsyncReadPrinter | RpcAsyncReadPrinter retrieves data from the specified job object. Opnum 68 | RpcReadPrinter |

3.1.4.8.1 RpcAsyncStartDocPrinter (Opnum 10)

RpcStartDocPrinter notifies a specified printer that a document is being spooled for printing.

The counterpart of this method in the Print System Remote Protocol is **RpcStartDocPrinter**. All parameters not defined below are specified in [\[MS-RPRN\]](#) section 3.1.4.9.1.

```
DWORD RpcAsyncStartDocPrinter(
    [in] PRINTER_HANDLE hPrinter,
    [in] DOC_INFO_CONTAINER* pDocInfoContainer,
    [out] DWORD* pJobId
);
```

hPrinter: A handle to a printer object that was opened by using either [RpcAsyncOpenPrinter \(section 3.1.4.1.1\)](#) or [RpcAsyncAddPrinter \(section 3.1.4.1.2\)](#).

Return Values: This method MUST return zero to indicate successful completion or a nonzero Win32 error code ([\[MS-ERREF\]](#) section 2.2) to indicate failure. The client MUST treat any nonzero return value as a fatal error.

Exceptions Thrown: This method MUST NOT throw any exceptions other than those that are thrown by the underlying RPC protocol [\[MS-RPCE\]](#).

This method MUST adhere to the parameter validation, processing, and response requirements that are specified in [\[MS-RPRN\]](#) section 3.1.4.9.1.

3.1.4.8.2 RpcAsyncStartPagePrinter (Opnum 11)

RpcAsyncStartPagePrinter notifies a specified printer that a page is about to be printed.

The counterpart of this method in the Print System Remote Protocol is **RpcStartPagePrinter**. All parameters not defined below are specified in [\[MS-RPRN\]](#) section 3.1.4.9.2.

```
DWORD RpcAsyncStartPagePrinter(
    [in] PRINTER_HANDLE hPrinter
);
```

hPrinter: A handle to a printer object that was opened by using either [RpcAsyncOpenPrinter \(section 3.1.4.1.1\)](#) or [RpcAsyncAddPrinter \(section 3.1.4.1.2\)](#).

Return Values: This method MUST return zero to indicate successful completion or a nonzero Win32 error code ([\[MS-ERREF\]](#) section 2.2) to indicate failure. The client MUST treat any nonzero return value as a fatal error.

Exceptions Thrown: This method MUST NOT throw any exceptions other than those that are thrown by the underlying RPC protocol [\[MS-RPCE\]](#).

This method MUST adhere to the parameter validation, processing, and response requirements that are specified in [\[MS-RPRN\]](#) section 3.1.4.9.2.

3.1.4.8.3 RpcAsyncWritePrinter (Opnum 12)

RpcAsyncWritePrinter adds data to the file representing the spool file for a specified printer, if the spooling option is turned on; or it sends data to the device directly, if the printer is configured for direct printing.

The counterpart of this method in the Print System Remote Protocol is **RpcWritePrinter**. All parameters not defined below are specified in [\[MS-RPRN\]](#) section 3.1.4.9.3.

```
DWORD RpcAsyncWritePrinter(  
    [in] PRINTER_HANDLE hPrinter,  
    [in, size_is(cbBuf)] unsigned char* pBuf,  
    [in] DWORD cbBuf,  
    [out] DWORD* pcWritten  
);
```

hPrinter: A handle to a printer object or port object that was opened by using either [RpcAsyncOpenPrinter \(section 3.1.4.1.1\)](#) or [RpcAsyncAddPrinter \(section 3.1.4.1.2\)](#).

Return Values: This method MUST return zero to indicate successful completion or a nonzero Win32 error code ([\[MS-ERREF\]](#) section 2.2) to indicate failure. The client MUST treat any nonzero return value as a fatal error.

Exceptions Thrown: This method MUST NOT throw any exceptions other than those that are thrown by the underlying RPC protocol [\[MS-RPCE\]](#).

This method MUST adhere to the parameter validation, processing, and response requirements that are specified in [\[MS-RPRN\]](#) section 3.1.4.9.3.

3.1.4.8.4 RpcAsyncEndPagePrinter (Opnum 13)

RpcAsyncEndPagePrinter notifies a specified printer that the application is at the end of a page in a print job.

The counterpart of this method in the Print System Remote Protocol is **RpcEndPagePrinter**. All parameters not defined below are specified in [\[MS-RPRN\]](#) section 3.1.4.9.4.

```
DWORD RpcAsyncEndPagePrinter(  
    [in] PRINTER_HANDLE hPrinter  
);
```

hPrinter: A handle to a printer object that was opened by using either [RpcAsyncOpenPrinter \(section 3.1.4.1.1\)](#) or [RpcAsyncAddPrinter \(section 3.1.4.1.2\)](#).

Return Values: This method MUST return zero to indicate successful completion or a nonzero Win32 error code ([\[MS-ERREF\]](#) section 2.2) to indicate failure. The client MUST treat any nonzero return value as a fatal error.

Exceptions Thrown: This method MUST NOT throw any exceptions other than those that are thrown by the underlying RPC protocol [\[MS-RPCE\]](#).

This method MUST adhere to the parameter validation, processing, and response requirements that are specified in [\[MS-RPRN\]](#) section 3.1.4.9.4.

3.1.4.8.5 RpcAsyncEndDocPrinter (Opnum 14)

RpcAsyncEndDocPrinter signals the completion of the current print job on a specified printer.

The counterpart of this method in the Print System Remote Protocol is **RpcEndDocPrinter**. All parameters not defined below are specified in [\[MS-RPRN\]](#) section 3.1.4.9.7.

```
DWORD RpcAsyncEndDocPrinter(  
    [in] PRINTER_HANDLE hPrinter  
);
```

hPrinter: A handle to a printer object that has been opened by using either [RpcAsyncOpenPrinter \(section 3.1.4.1.1\)](#) or [RpcAsyncAddPrinter \(section 3.1.4.1.2\)](#).

Return Values: This method MUST return zero to indicate successful completion or a nonzero Win32 error code ([\[MS-ERREF\]](#) section 2.2) to indicate failure. The client MUST treat any nonzero return value as a fatal error.

Exceptions Thrown: This method MUST NOT throw any exceptions other than those that are thrown by the underlying RPC protocol [\[MS-RPCE\]](#).

This method MUST adhere to the parameter validation, processing, and response requirements that are specified in [\[MS-RPRN\]](#) section 3.1.4.9.7.

3.1.4.8.6 RpcAsyncAbortPrinter (Opnum 15)

RpcAsyncAbortPrinter aborts the current document on a specified printer.

The counterpart of this method in the Print System Remote Protocol is **RpcAbortPrinter**. All parameters not defined below are specified in [\[MS-RPRN\]](#) section 3.1.4.9.5.

```
DWORD RpcAsyncAbortPrinter(  
    [in] PRINTER_HANDLE hPrinter  
);
```

hPrinter: A handle to a printer object that has been opened by using either [RpcAsyncOpenPrinter \(section 3.1.4.1.1\)](#) or [RpcAsyncAddPrinter \(section 3.1.4.1.2\)](#).

Return Values: This method MUST return zero to indicate successful completion or a nonzero Win32 error code ([\[MS-ERREF\]](#) section 2.2) to indicate failure. The client MUST treat any nonzero return value as a fatal error.

Exceptions Thrown: This method MUST NOT throw any exceptions other than those that are thrown by the underlying RPC protocol [\[MS-RPCE\]](#).

This method MUST adhere to the parameter validation, processing, and response requirements that are specified in [\[MS-RPRN\]](#) section 3.1.4.9.5.

3.1.4.8.7 RpcAsyncReadPrinter (Opnum 68)

RpcAsyncReadPrinter retrieves data from the specified job object.

The counterpart of this method in the Print System Remote Protocol is **RpcReadPrinter**. All parameters not defined below are specified in [\[MS-RPRN\]](#) section 3.1.4.9.6.

```
DWORD RpcAsyncReadPrinter(
    [in] PRINTER_HANDLE hPrinter,
    [out, size_is(cbBuf)] unsigned char* pBuf,
    [in] DWORD cbBuf,
    [out] DWORD* pcNoBytesRead
);
```

hPrinter: A handle to a job object that has been opened by using either [RpcAsyncOpenPrinter \(section 3.1.4.1.1\)](#) or [RpcAsyncAddPrinter \(section 3.1.4.1.2\)](#).

Return Values: This method MUST return zero to indicate successful completion or a nonzero Win32 error code ([\[MS-ERREF\]](#) section 2.2) to indicate failure. The client MUST treat any nonzero return value as a fatal error.

Exceptions Thrown: This method MUST NOT throw any exceptions other than those that are thrown by the underlying RPC protocol [\[MS-RPCE\]](#).

This method MUST adhere to the parameter validation, processing, and response requirements that are specified in [\[MS-RPRN\]](#) section 3.1.4.9.6.

3.1.4.9 Printing-Related Notification Methods

The Printing-Related Notification methods support the registration for and receipt of notification events concerning a specific print job. The following table presents a list of printing-related notification methods and indicates that they have no counterparts in the Print System Remote Protocol [\[MS-RPRN\]](#). All methods are specified in sections that follow.

| [MS-PAR] method | Description | [MS-RPRN] method |
|--|---|------------------|
| RpcSyncRegisterForRemoteNotifications | RpcSyncRegisterForRemoteNotifications opens a notification handle by using a printer handle or print server handle, to listen for remote printer change notifications. Opnum 58 | None. |
| RpcSyncUnRegisterForRemoteNotification | RpcSyncUnRegisterForRemoteNotification s closes a notification handle opened by calling RpcSyncRegisterForRemoteNotifications (section 3.1.4.9.1). | None. |

| [MS-PAR] method | Description | [MS-RPRN] method |
|---|--|------------------|
| | Opnum 59 | |
| RpcSyncRefreshRemoteNotifications | RpcSyncRefreshRemoteNotifications gets notification information for all requested members. This is called by a client if the "RemoteNotifyData Flags" key in the RpcPrintPropertiesCollection instance, which was returned as part of the notification from an RpcAsyncGetRemoteNotifications call, has the PRINTER_NOTIFY_INFO_DISCARDED bit set. PRINTER_NOTIFY_INFO_DISCARDED is defined in [MS-RPRN] section 2.2.3.2. Opnum 60 | None. |
| RpcAsyncGetRemoteNotifications | A client uses RpcAsyncGetRemoteNotifications to poll the print server for specified change notifications. A call to this method is suspended until the server has a new change notification for the client. Subsequently, the client calls this method again to poll for additional notifications from the server. Opnum 61 | None. |

3.1.4.9.1 RpcSyncRegisterForRemoteNotifications (Opnum 58)

RpcSyncRegisterForRemoteNotifications opens a notification handle by using a printer handle or print server handle, to listen for remote printer change notifications.

```
HRESULT RpcSyncRegisterForRemoteNotifications(
    [in] PRINTER_HANDLE hPrinter,
    [in] RpcPrintPropertiesCollection* pNotifyFilter,
    [out] RMTNTFY_HANDLE* phRpcHandle
);
```

hPrinter: A handle to a printer object or print server object opened by using either [RpcAsyncOpenPrinter \(section 3.1.4.1.1\)](#) or [RpcAsyncAddPrinter \(section 3.1.4.1.2\)](#).

pNotifyFilter: A pointer to an [RpcPrintPropertiesCollection \(section 2.2.4\)](#) instance that contains the caller-specified notification filter settings.

phRpcHandle: A pointer to a variable that receives the remote notification handle.

Return Values: This method MUST return zero or an HRESULT success value ([\[MS-ERREF\]](#) section 2.1) to indicate successful completion, or an HRESULT error value to indicate failure.

Exceptions Thrown: This method MUST NOT throw any exceptions other than those that are thrown by the underlying RPC protocol [\[MS-RPCE\]](#).

Parameter Validation Requirements: Upon receiving this method call, the server MUST validate parameters as follows:

- The **hPrinter** printer object or server object handle MUST NOT be NULL and MUST point to a printer object or server object that can be monitored for notifications.
- The printer handle MUST be authorized to monitor printer objects for notifications. [<29>](#)
- The **pNotifyFilter** parameter MUST point to an **RpcPrintPropertiesCollection** instance that has all the name-value pairs required to register for notifications.

If parameter validation fails, the server MUST return immediately with a failure indication in its response to the client.

Processing and Response Requirements: If parameter validation succeeds, the server MUST process the method call by:

- Creating a notification object that points to the printer object or server object and contains notification filter data sent by the client.
- Adding the notification object to the list of notification clients for the printer object or server object.
- Associating the notification object with an RPC handle and returning the handle to the user.

If the operation is successful, when the client calls [RpcAsyncGetRemoteNotifications \(section 3.1.4.9.4\)](#) with the RPC handle returned from this method, the server MUST return the changes to the object indicated by the notification filter settings since the previous call to the same method.

3.1.4.9.2 RpcSyncUnRegisterForRemoteNotifications (Opnum 59)

RpcSyncUnRegisterForRemoteNotifications closes a notification handle opened by calling [RpcSyncRegisterForRemoteNotifications \(section 3.1.4.9.1\)](#).

```
HRESULT RpcSyncUnRegisterForRemoteNotifications(  
    [in, out] RMTNTFY_HANDLE* phRpcHandle  
);
```

phRpcHandle: A pointer to the remote notification handle from which the user no longer wants to receive notifications.

Return Values: This method MUST return zero or an HRESULT success value ([\[MS-ERREF\]](#) section 2.1) to indicate successful completion or an HRESULT error value to indicate failure.

Exceptions Thrown: This method MUST NOT throw any exceptions other than those that are thrown by the underlying RPC protocol [\[MS-RPCE\]](#).

Parameter Validation Requirements: Upon receiving this method call, the server MUST verify that the **phRpcHandle** parameter is not NULL, and that it points to a non-NULL [RMTNTFY_HANDLE](#) that is associated with a valid notification object created by a call to **RpcSyncRegisterForRemoteNotifications** (section 3.1.4.9.1).

If parameter validation fails, the server MUST return immediately, with a failure indication in its response to the client.

Processing and Response Requirements: If the operation is successful, the server MUST execute the following steps before returning:

- Remove the client from the list of notification clients associated with the printer object or server.
- Delete the notification object associated with the **RMTNTFY_HANDLE** specified by the `phRpcHandle` parameter.

3.1.4.9.3 **RpcSyncRefreshRemoteNotifications (Opnum 60)**

RpcSyncRefreshRemoteNotifications gets notification information for all requested members. This SHOULD be called by a client if the "RemoteNotifyData Flags" key in the [RpcPrintPropertiesCollection](#) instance, which was returned as part of the notification from an [RpcAsyncGetRemoteNotifications](#) call, has the **PRINTER_NOTIFY_INFO_DISCARDED** bit set. **PRINTER_NOTIFY_INFO_DISCARDED** is defined in [\[MS-RPRN\]](#) section 2.2.3.2.

```
HRESULT RpcSyncRefreshRemoteNotifications(  
    [in] RMTNTFY_HANDLE hRpcHandle,  
    [in] RpcPrintPropertiesCollection* pNotifyFilter,  
    [out] RpcPrintPropertiesCollection** ppNotifyData  
);
```

hRpcHandle: A remote notification handle that was opened by using [RpcSyncRegisterForRemoteNotifications \(section 3.1.4.9.1\)](#).

pNotifyFilter: A pointer to an **RpcPrintPropertiesCollection** (section 2.2.4) instance that contains the caller-specified notification filter settings.

ppNotifyData: A pointer to a variable that receives a pointer to an **RpcPrintPropertiesCollection** instance that contains the notification data.

Return Values: This method MUST return zero or an HRESULT success value ([\[MS-ERREF\]](#) section 2.1) to indicate successful completion or an HRESULT error value to indicate failure.

Exceptions Thrown: This method MUST NOT throw any exceptions other than those that are thrown by the underlying RPC protocol [\[MS-RPCE\]](#).

Parameter Validation Requirements: Upon receiving this method call, the server MUST validate parameters as follows:

- The **hRpcHandle** parameter MUST NOT be NULL and MUST be associated with a valid notification object created by a call to **RpcSyncRegisterForRemoteNotifications** (section 3.1.4.9.1).
- The **pNotifyFilter** parameter MUST point to an **RpcPrintPropertiesCollection** instance that has all the name-value pairs required to get notification data.

If parameter validation fails, the server MUST return immediately, with a failure indication in its response to the client.

Processing and Response Requirements: If parameter validation succeeds, the server MUST process the method call by:

- Storing the notification data requested by the client in the **RpcPrintPropertiesCollection** structure pointed to by **ppNotifyData**.
- Returning a response that contains the status of the operation.

If the operation is successful, the server MUST make the following changes to printer object data before returning the response:

- Store the notification synchronization value in the **RpcPrintPropertiesCollection** instance pointed to by **pNotifyFilter**, which corresponds to the "RemoteNotifyFilter Color" key. This value should be stored with the client information in the list of notification clients for the printer object or server so that the client can use it in **RpcAsyncGetRemoteNotifications** calls.
- Delete the notification data associated with the notification handle that has been successfully sent.

3.1.4.9.4 RpcAsyncGetRemoteNotifications (Opnum 61)

A print client uses **RpcAsyncGetRemoteNotifications** to poll the print server for specified change notifications. A call to this method is suspended until the server has a new change notification for the client. Subsequently, the client calls this method again to poll for additional notifications from the server.

```
HRESULT RpcAsyncGetRemoteNotifications(  
    [in] RMTNTFY_HANDLE hRpcHandle,  
    [out] RpcPrintPropertiesCollection** ppNotifyData  
);
```

hRpcHandle: A remote notification handle that was opened by using [RpcSyncRegisterForRemoteNotifications \(section 3.1.4.9.1\)](#).

ppNotifyData: A pointer to a variable that receives a pointer to an [RpcPrintPropertiesCollection \(section 2.2.4\)](#) instance that contains the notification data.

Return Values: This method MUST return zero or an HRESULT success value ([\[MS-ERREF\]](#) section 2.1) to indicate successful completion or an HRESULT error value to indicate failure.

Exceptions Thrown: This method MUST NOT throw any exceptions other than those that are thrown by the underlying RPC protocol [\[MS-RPCE\]](#).

Parameter Validation Requirements: Upon receiving this method call, the server MUST verify that the **hRpcHandle** parameter is not NULL, and that it is associated with a valid notification object created by a call to **RpcSyncRegisterForRemoteNotifications** (section 3.1.4.9.1).

If parameter validation fails, the server MUST return immediately, with a failure indication in its response to the client.

Processing and Response Requirements: If parameter validation succeeds, the server MUST process the method call by:

- Checking whether any change notification data is available on the notification object associated with this notification handle.
- If the change notification data is not available, waiting until the specified printer object or server changes and notification data becomes available.
- Returning a response that contains the status of the operation.

If the operation is successful, the server MUST process the message and compose a response to the client as follows:

- Create an **RpcPrintPropertiesCollection** object as follows:
- Store the notification data requested by the client in the "RemoteNotifyData Info" key in the **RpcPrintPropertiesCollection** object.
- Store the notification synchronization value in the "RemoteNotifyData Color" key in the **RpcPrintPropertiesCollection** object. The latest synchronization value was sent by the client in a prior call to [RpcSyncRefreshRemoteNotifications](#).
- Store a value specifying the members that have changed in the "RemoteNotifyData Flags" key in the **RpcPrintPropertiesCollection** object.
- Store this **RpcPrintPropertiesCollection** object in the **ppNotifyData** parameter.
- Delete the notification data associated with the notification handle that has been successfully sent.

3.1.4.10 Job Named Property Management Methods

The Job Named Property Management methods support the creation, update, deletion, and enumeration of **Job Named Properties** (section [3.1.1](#)). The following table presents a list of the **Job Named Property** management methods and their counterparts in the Print System Remote Protocol [[MS-RPRN](#)]. All methods are specified in the sections that follow.

| [MS-PAR] method | Description | [MS-RPRN] method |
|---|--|--|
| RpcAsyncGetJobNamedPropertyValue (section 3.1.4.10.1) | RpcAsyncGetJobNamedPropertyValue retrieves the value of the specified Job Named Property for the specified print job. Opnum: 70 | RpcGetJobNamedPropertyValue (section 3.1.4.12.1) |
| RpcAsyncSetJobNamedProperty (section 3.1.4.10.2) | RpcAsyncSetJobNamedProperty creates a new Job Named Property or changes the value of an existent Job Named Property for the specified print job. Opnum: 71 | RpcSetJobNamedProperty (section 3.1.4.12.2) |
| RpcAsyncDeleteJobNamedProperty (section 3.1.4.10.3) | RpcAsyncDeleteJobNamedProperty deletes a Job Named Property for the specified print job. Opnum: 72 | RpcDeleteJobNamedProperty (section 3.1.4.12.3) |
| RpcAsyncEnumJobNamedProperties (section 3.1.4.10.4) | RpcAsyncEnumJobNamedProperties enumerates the Job Named Properties for the specified print job. Opnum: 73 | RpcEnumJobNamedProperties (section 3.1.4.12.4) |

3.1.4.10.1 RpcAsyncGetJobNamedPropertyValue (Opnum 70)

RpcAsyncGetJobNamedPropertyValue retrieves the current value of the specified **Job Named Property** (section [3.1.1](#)).[<30>](#)

The counterpart of this method in the Print System Remote Protocol ([\[MS-RPRN\]](#)) is [RpcGetJobNamedPropertyValue](#). All parameters not defined below are specified in [\[MS-RPRN\]](#) section 3.1.4.12.1.

```
DWORD RpcAsyncGetJobNamedPropertyValue(  
    [in] PRINTER_HANDLE hPrinter,  
    [in] DWORD JobId,  
    [in, string] const wchar_t* pszName,  
    [out] RPC_PrintPropertyValue* pValue  
);
```

hPrinter: A handle to a printer object or server object that has been opened by using either [RpcAsyncOpenPrinter \(section 3.1.4.1.1\)](#) or [RpcAsyncAddPrinter \(section 3.1.4.1.2\)](#).

Return Values: This method MUST return zero to indicate successful completion or a nonzero Win32 error code ([\[MS-ERREF\]](#) section 2.2) to indicate failure. The client MUST treat any nonzero return value as a fatal error.

Exceptions Thrown: This method MUST NOT throw any exceptions other than those that are thrown by the underlying RPC protocol specified in [\[MS-RPCE\]](#).

This method MUST adhere to the parameter validation, processing, and response requirements that are specified in [\[MS-RPRN\]](#) section 3.1.4.12.1.

3.1.4.10.2 RpcAsyncSetJobNamedProperty (Opnum 71)

RpcAsyncSetJobNamedProperty creates a new **Job Named Property** (section [3.1.1](#)), or changes the value of an existing **Job Named Property** for the specified print job. [<31>](#)

The counterpart of this method in the Print System Remote Protocol is **RpcSetJobNamedProperty**. All parameters not defined below are specified in [\[MS-RPRN\]](#) section 3.1.4.12.2.

```
DWORD RpcAsyncSetJobNamedProperty(  
    [in] PRINTER_HANDLE hPrinter,  
    [in] DWORD JobId,  
    [in] RPC_PrintNamedProperty* pProperty  
);
```

hPrinter: A handle to a printer object or server object that has been opened by using either [RpcAsyncOpenPrinter \(section 3.1.4.1.1\)](#) or [RpcAsyncAddPrinter \(section 3.1.4.1.2\)](#).

Return Values: This method MUST return zero to indicate successful completion or a nonzero Win32 error code ([\[MS-ERREF\]](#) section 2.2) to indicate failure. The client MUST treat any nonzero return value as a fatal error.

Exceptions Thrown: This method MUST NOT throw any exceptions other than those that are thrown by the underlying RPC protocol specified in [\[MS-RPCE\]](#).

This method MUST adhere to the parameter validation, processing, and response requirements that are specified in [\[MS-RPRN\]](#) section 3.1.4.12.2.

3.1.4.10.3 RpcAsyncDeleteJobNamedProperty (Opnum 72)

RpcAsyncDeleteJobNamedProperty deletes an existing **Job Named Property** (section [3.1.1](#)) for the specified print job. [<32>](#)

The counterpart of this method in the Print System Remote Protocol is [RpcDeleteJobNamedProperty](#). All parameters not defined below are specified in [\[MS-RPRN\]](#) section 3.1.4.12.3.

```
DWORD RpcAsyncDeleteJobNamedProperty(  
    [in] PRINTER_HANDLE hPrinter,  
    [in] DWORD JobId,  
    [in, string] const wchar_t* pszName  
);
```

hPrinter: A handle to a printer object or server object that has been opened by using either [RpcAsyncOpenPrinter \(section 3.1.4.1.1\)](#) or [RpcAsyncAddPrinter \(section 3.1.4.1.2\)](#).

Return Values: This method MUST return zero to indicate successful completion or a nonzero Win32 error code ([\[MS-ERREF\]](#) section 2.2) to indicate failure. The client MUST treat any nonzero return value as a fatal error.

Exceptions Thrown: This method MUST NOT throw any exceptions other than those that are thrown by the underlying RPC protocol specified in [\[MS-RPCE\]](#).

This method MUST adhere to the parameter validation, processing, and response requirements that are specified in [\[MS-RPRN\]](#) section 3.1.4.12.3.

3.1.4.10.4 RpcAsyncEnumJobNamedProperties (Opnum 73)

RpcAsyncEnumJobNamedProperties enumerates the **Job Named Property** (section [3.1.1](#)) for the specified print job. [<33>](#)

The counterpart of this method in the Print System Remote Protocol is [RpcEnumJobNamedProperties \(section 3.1.4.12.4\)](#). All parameters not defined below are specified in [\[MS-RPRN\]](#) section 3.1.4.12.4.

```
DWORD RpcAsyncEnumJobNamedProperties(  
    [in] PRINTER_HANDLE hPrinter,  
    [in] DWORD JobId,  
    [out] DWORD* pcProperties,  
    [out, size_is, (*pcProperties)]  
    RPC_PrintNamedProperty** ppProperties  
);
```

hPrinter: A handle to a printer object or server object that has been opened by using either [RpcAsyncOpenPrinter \(section 3.1.4.1.1\)](#) or [RpcAsyncAddPrinter \(section 3.1.4.1.2\)](#).

Return Values: This method MUST return zero to indicate successful completion or a nonzero Win32 error code ([\[MS-ERREF\]](#) section 2.2) to indicate failure. The client MUST treat any nonzero return value as a fatal error.

Exceptions Thrown: This method MUST NOT throw any exceptions other than those that are thrown by the underlying RPC protocol [\[MS-RPCE\]](#).

This method MUST adhere to the parameter validation, processing, and response requirements that are specified in [\[MS-RPRN\]](#) section 3.1.4.12.4.

3.1.4.11 Branch Office Print Remote Logging Methods

The Branch Office Print Remote Logging methods support the processing of **Branch Office Print Remote Log Entries** (section [3.1.1](#)) for a specified printer. The following table presents a list of branch office print remote logging methods and their counterparts in the Print System Remote Protocol [[MS-RPRN](#)]. All methods are specified in the sections that follow.

| [MS-PAR] method | Description | [MS-RPRN] method |
|--|---|---|
| RpcAsyncLogJobInfoForBranchOffice (section 3.1.4.11.1) | RpcAsyncLogJobInfoForBranchOffice processes one or more Branch Office Print Remote Log Entries by writing them to the Microsoft-Windows-PrintService/Admin and Microsoft-Windows-PrintService/Operations event channels. Opnum: 74 | RpcLogJobInfoForBranchOffice (section 3.1.4.13.1) |

3.1.4.11.1 RpcAsyncLogJobInfoForBranchOffice (Opnum 74)

RpcAsyncLogJobInfoForBranchOffice processes one or more **Branch Office Print Remote Log Entries** (section [3.1.1](#)). <34>

The counterpart of this method in the Print System Remote Protocol is [RpcLogJobInfoForBranchOffice](#). All parameters not defined below are specified in [[MS-RPRN](#)] section 3.1.4.13.1.

```
DWORD RpcAsyncLogJobInfoForBranchOffice (
    [in] PRINTER_HANDLE hPrinter,
    [in, ref] RPC_BranchOfficeJobDataContainer* pBranchOfficeJobDataContainer
);
```

hPrinter: A handle to a printer object that has been opened by using either [RpcAsyncOpenPrinter \(section 3.1.4.1.1\)](#) or [RpcAsyncAddPrinter \(section 3.1.4.1.2\)](#).

Return Values: This method MUST return zero to indicate successful completion or a nonzero Win32 error code ([\[MS-ERREF\]](#) section 2.2) to indicate failure. The client MUST treat any nonzero return value as a fatal error.

Exceptions Thrown: This method MUST NOT throw any exceptions other than those that are thrown by the underlying RPC protocol specified in [[MS-RPCE](#)].

This method MUST adhere to the parameter validation, processing, and response requirements that are specified in [[MS-RPRN](#)] section 3.1.4.13.1.

3.1.5 Timer Events

No protocol timer events are required on the server other than the timers that are required in the underlying RPC protocol.

3.1.6 Other Local Events

No local events are maintained on the server other than the events that are maintained in the underlying RPC protocol.

3.2 IRemoteWinspool Client Details

3.2.1 Abstract Data Model

No abstract data model is required.

3.2.2 Timers

No protocol timers are required on the client—other than the timers that are required in the underlying RPC protocol.

3.2.3 Initialization

The Print System Asynchronous Remote client MUST perform the following initialization actions:

- To call RPC methods, create an RPC binding handle ([C706] section 2.3) to the server **RPC endpoint** with an impersonation type of **RPC_C_IMPL_LEVEL_IMPERSONATE** ([MS-RPCE] section 2.2.1.1.9). Binding handles are either context handles that are used across multiple calls to the server or handles that are bound to a single call to the server.
- Reuse a binding handle for multiple invocations when creating a print job, as in a call to [RpcAsyncOpenPrinter \(section 3.1.4.1.1\)](#) followed by multiple calls to [RpcAsyncStartPagePrinter \(section 3.1.4.8.2\)](#) and [RpcAsyncWritePrinter \(section 3.1.4.8.3\)](#).

For methods that expect an RPC binding handle, the server assumes that the binding handle has been derived from the *server name* parameter of the method or from the server name portion of the *printer name* parameter of the method. This assumption is analogous to requirements of the same kind expressed in [MS-RPRN] sections 2.2.1.1.7, 3.1.4.1.4, and 3.1.4.1.5. A server implementation MAY<35> choose to support server names that are not identical to the server name used to create the RPC binding handle and, as a result, effectively route the call to another server.

The print client SHOULD perform the following initialization actions:

- Reuse a binding handle for multiple invocations, as in a call to **RpcAsyncOpenPrinter** followed by multiple calls to [RpcAsyncGetPrinter \(section 3.1.4.1.5\)](#), [RpcAsyncGetPrinterData \(section 3.1.4.1.6\)](#), or [RpcAsyncSetPrinter \(section 3.1.4.1.4\)](#). However, for name-based calls, the client SHOULD create a separate binding handle for each method invocation.

The print client MUST perform the following actions for all method calls:

- Specify the object UUID 9940CA8E-512F-4C58-88A9-61098D6896BD.
- Ensure that the call occurs with causal ordering ([MS-RPCE] section 3.1.1.4.1).
- Either reuse an existing authenticated RPC binding handle in the cases described above, or create an authenticated RPC binding handle using the SPNEGO security provider ([MS-SPNG]) and packet authentication ([MS-RPCE] section 2.2.1.1.8), as described in section 2.1.<36>

3.2.4 Message Processing Events and Sequencing Rules

The Print System Asynchronous Remote Protocol MUST indicate the following to the RPC runtime ([MS-RPCE] section 3):

- That it is to perform a strict NDR data consistency check at target level 6.0.

- That it is to reject a NULL unique or full pointer with nonzero conformant value.

The client SHOULD NOT make any decisions based on the errors that are returned from the RPC server, but SHOULD notify the application invoker of the error received in the higher layer. Otherwise, no special message processing is required on the client except for what is required in the underlying RPC protocol. [<37>](#)

3.2.5 Timer Events

No protocol timer events are required on the client other than the timers that are required in the underlying RPC protocol.

3.2.6 Other Local Events

No local events are maintained on the client other than the events that are maintained in the underlying RPC protocol.

4 Protocol Examples

Examples 4.1 through 4.4 are functionally equivalent to examples 4.1 through 4.4 in [MS-RPRN], respectively, and therefore are not duplicated here in detail. Only the sequence diagrams with substituted method names are contained here.

Example 4.5 is different, and details are contained in this document.

4.1 Adding a Printer to a Server

A client adds a printer to a server by following the steps shown below, which are described in [MS-RPRN] section 4.1; and by applying the parameter substitutions that are specified in [MS-RPRN] section 3.1.4.1.

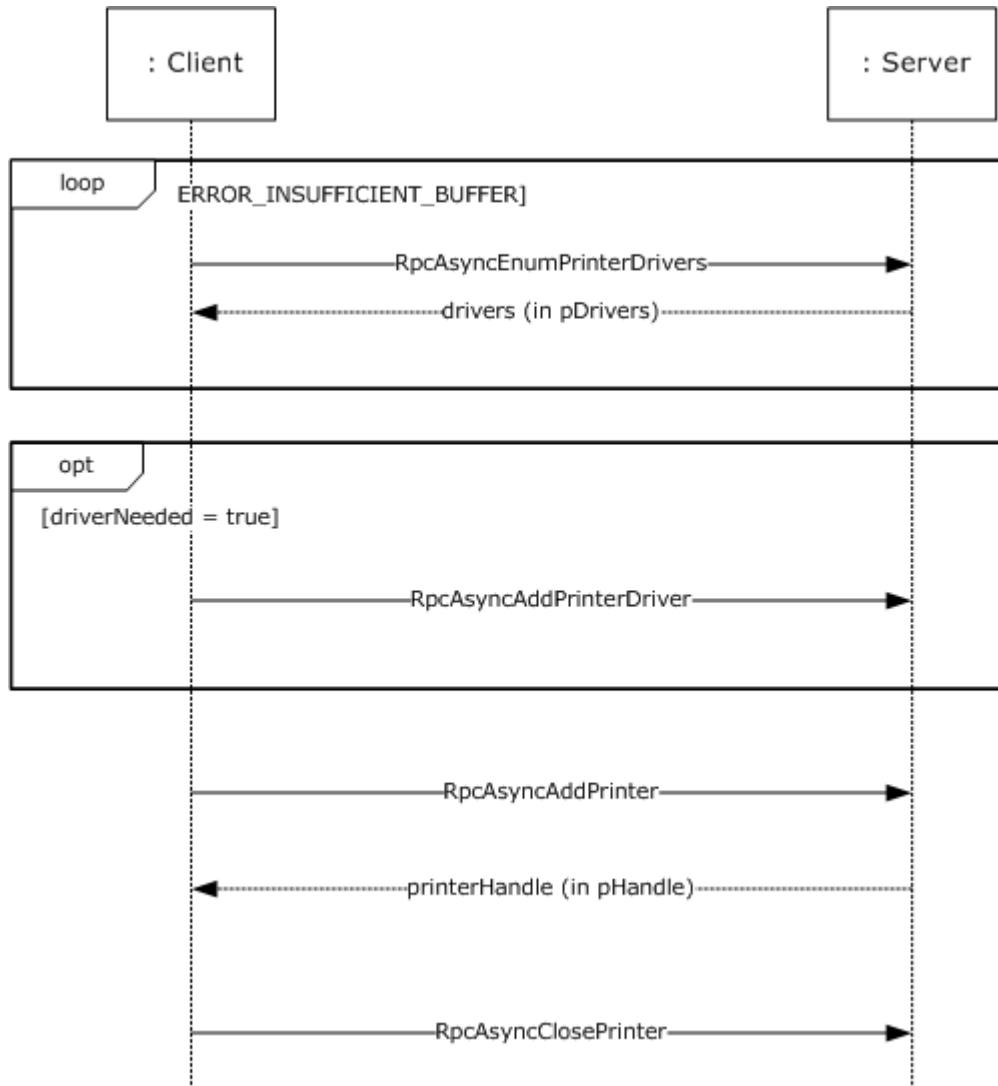

Figure 5: Adding a printer to a server

4.2 Adding a Printer Driver to a Server

A client adds a printer driver to a server by following the steps shown below, which are described in [\[MS-RPRN\]](#) section 4.2; and by applying the parameter substitutions that are specified in [\[MS-RPRN\]](#) section 3.1.4.1.

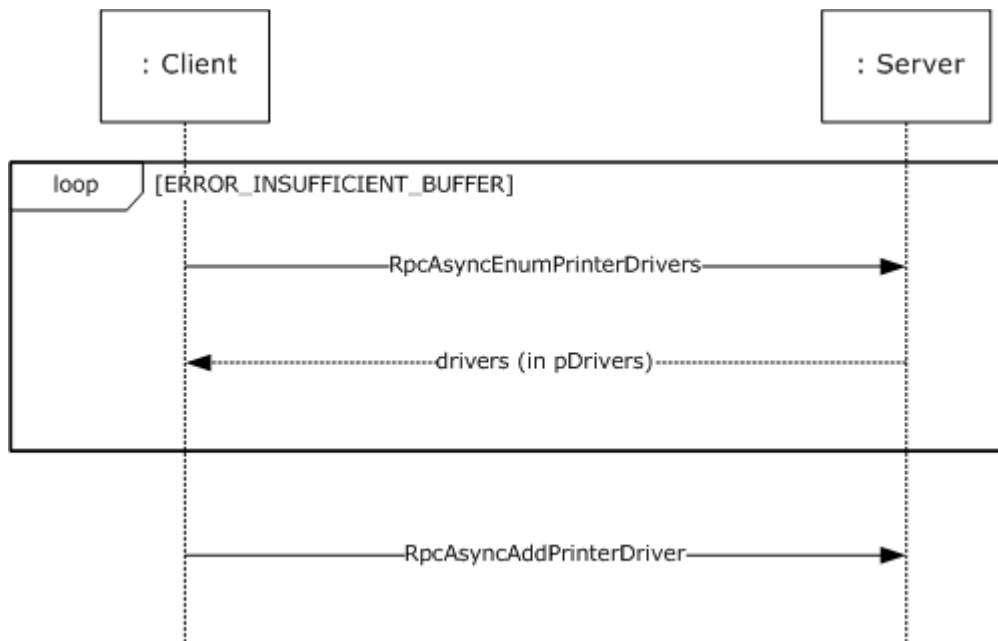

Figure 6: Adding a printer driver to a server

4.3 Enumerating Printers on a Server

A client enumerates printers on a server by following the steps shown below, which are described in [\[MS-RPRN\]](#) section 4.3; and by applying the parameter substitutions that are specified in [\[MS-RPRN\]](#) section 3.1.4.1.

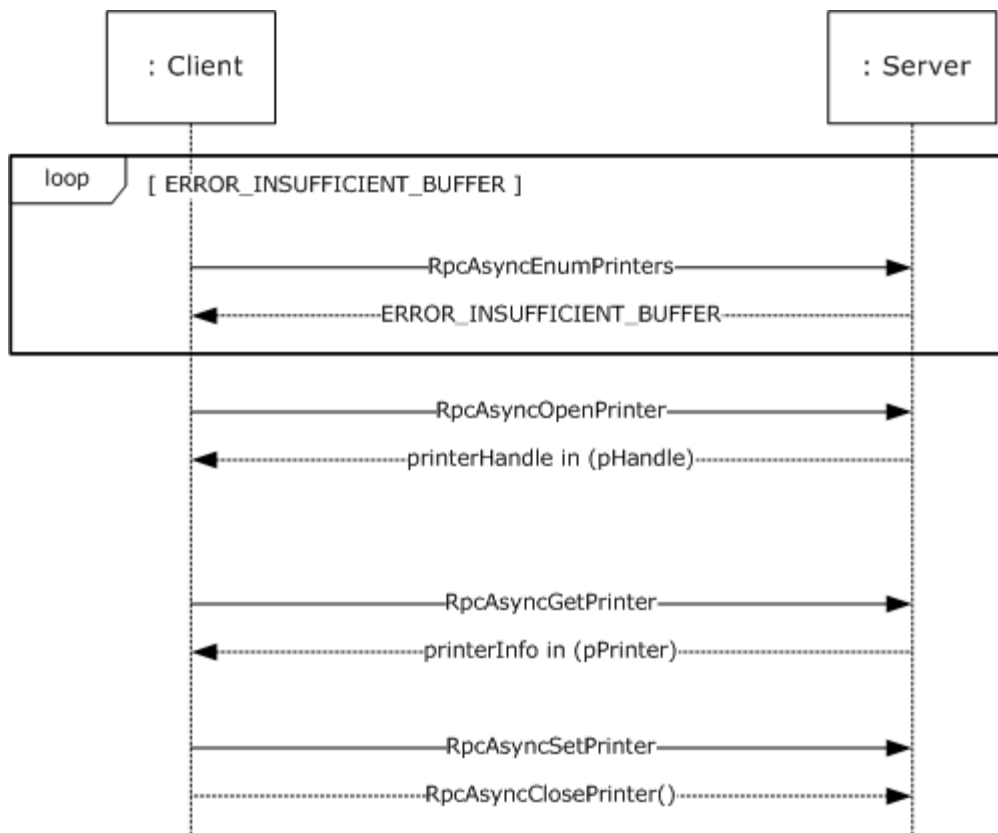

Figure 7: Enumerating printers on a server and accessing information about one of them

4.4 Enumerating Print Jobs on a Server

The client enumerates print jobs on a server by following the steps shown below, which are described in [\[MS-RPRN\]](#) section 4.4; and by applying the parameter substitutions that are specified in [\[MS-RPRN\]](#) section 3.1.4.1.

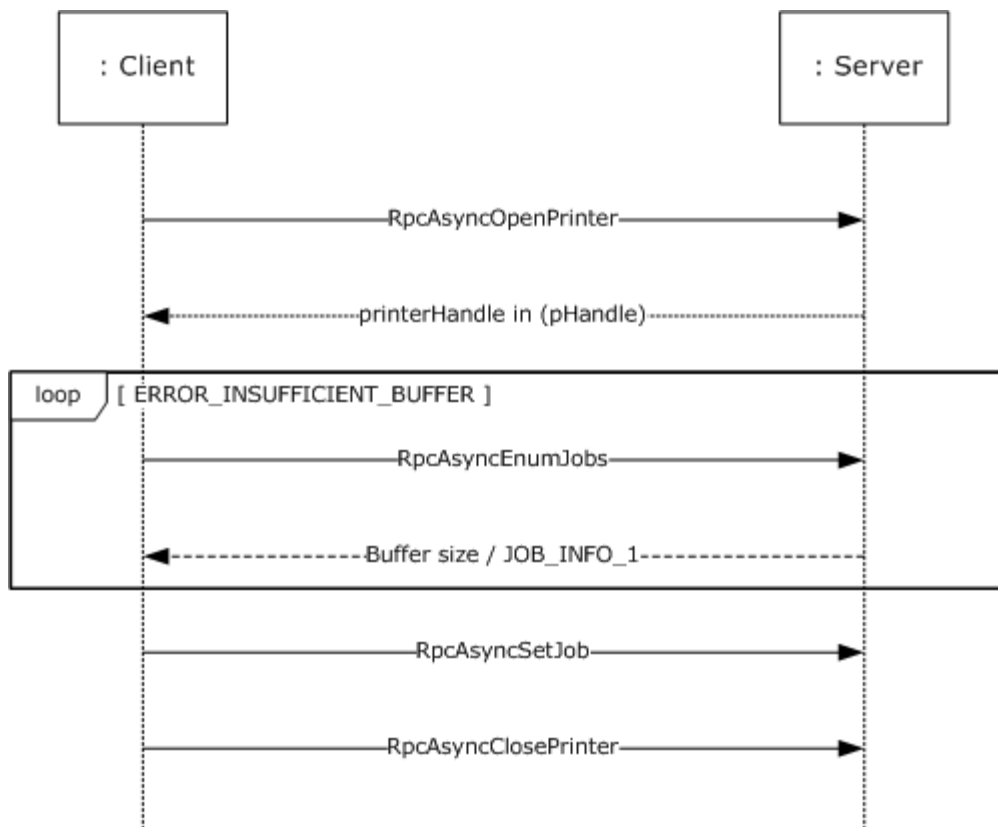

Figure 8: Enumerating jobs on a server and modifying one of them

4.5 Receiving Notifications from a Server

A client ("TESTCLT") receives notifications from a server ("CORPSERV") about changes in the states of printers, print servers, and print jobs by following these steps:

1. The client opens the print server or printer using [RpcAsyncOpenPrinter](#).

```

RpcAsyncOpenPrinter( L"\\\\CORPSERV\\My Printer", &hPrinter, L"RAW",
&devmodeContainer, PRINTER_ACCESS_USE );
  
```

The server allocates the printer handle, writes it to hPrinter, and returns 0 (success).

2. The client registers for change notifications using [RpcSyncRegisterForRemoteNotifications](#) and specifies the type of notifications the client is interested in.

- The client allocates and initializes an [RpcPrintPropertiesCollection](#) structure as follows:

```

RpcPrintPropertiesCollection notifyFilter;
RpcPrintNamedProperty property[4];

WORD notifyFieldsJob[] = { 0x000A /*JOB_NOTIFY_FIELD_STATUS*/, 0x000D
/*JOB_NOTIFY_FIELD_DOCUMENT*/ };
RPC_V2_NOTIFY_OPTIONS_TYPE notifyTypes[1] = {{1 /*JOB_NOTIFY_TYPE*/, 0, 0, 0, 2,
notifyFieldsJob }};
  
```

```

RPC_V2_NOTIFY_OPTIONS notifyOptions = {0x00000002,0x00000000,1,notifyTypes};

notifyFilter.numberOfProperties = 4;
notifyFilter.propertiesCollection = property;

property[0].propertyName = L"RemoteNotifyFilter Flags";
property[0].propertyValue.ePropertyType = kPropertyTypeInt32;
property[0].propertyValue.propertyInt32 = 0x00000100; /* PRINTER_CHANGE_ADD_JOB */

property[1].propertyName = L"RemoteNotifyFilter Options";
property[1].propertyValue.ePropertyType = kPropertyTypeInt32;
property[1].propertyValue.propertyInt32 = 0;

property[2].propertyName = L"RemoteNotifyFilter NotifyOptions";
property[2].propertyValue.ePropertyType = kPropertyTypeNotificationOptions;
property[2].propertyValue.propertyOptionsContainer.pOptions = &notifyOptions;

property[3].propertyName = L"RemoteNotifyFilter Color";
property[3].propertyValue.ePropertyType = kPropertyTypeInt32;
property[3].propertyValue.propertyInt32 = 1; /* Pass a unique, monotonically
incremented value so that later on we can understand order of notifications */

```

- The client registers for change notifications.

```
RpcSyncRegisterForRemoteNotifications( hPrinter, &notifyFilter, &hNotifyHandle );
```

- The server creates a notification context to keep track of the filter settings, writes the handle to hNotifyHandle, and returns 0 (success).

3. To receive state change notifications, the client calls the server's [RpcAsyncGetRemoteNotifications](#) method. That method call will not return until there is a new state change notification.

- Client registers for state change notifications.

```
RpcPrintPropertiesCollection *pNotifyData = NULL;
RpcAsyncGetRemoteNotifications( hNotifyHandle, &pNotifyData);
```

- The server responds when a change occurs that matches a filter condition that was specified by the client when the client registered for notifications.
- The server allocates and initializes an **RpcPrintPropertiesCollection**, returns the address in **pNotifyData**, and returns 0 (success).
- The server initializes **pNotifyData** as follows (note that memory allocations are not spelled out in this example):

```

notifyFilter.numberOfProperties = 3;
notifyFilter.propertiesCollection = property;

RPC_V2_NOTIFY_INFO notifyInfo; /* Note: Pseudo-code only, assumes sufficient
memory has been allocated for aData[] array at end of structure */
notifyInfo.Version = 2;
notifyInfo.Flags = 0;

```

```

notifyInfo.Count = 1;
notifyInfo.aData[0].Type = 1; /* JOB_NOTIFY_TYPE */
notifyInfo.aData[0].Field = 0xD; /* JOB_NOTIFY_FIELD_DOCUMENT */
notifyInfo.aData[0].String.pszString = L"My Test Print Job Name";
notifyInfo.aData[0].Id = 12; /* This is print job with ID 12 */

property[0].propertyName = L"RemoteNotifyData Flags";
property[0].propertyValue.ePropertyType = kPropertyTypeInt32;
property[0].propertyValue.propertyInt32 = 0x00000100; /* PRINTER_CHANGE_ADD_JOB */

property[1].propertyName = L"RemoteNotifyData Info";
property[1].propertyValue.ePropertyType = kPropertyTypeNotificationReply;
property[1].propertyValue.propertyOptionsReplyContainer.pInfo = &notifyInfo;

property[2].propertyName = L"RemoteNotifyData Color";
property[2].propertyValue.ePropertyType = kPropertyTypeInt32;
property[2].propertyValue.propertyInt32 = 1; /* Passes back the value passed in by
the client */

```

- The client inspects **pNotifyData** and notifies any applications of the state change.
 - The client repeats as necessary for the implementation; for example, until shutdown or the user specifies a different printer.
4. If the server sets the **PRINTER_NOTIFY_INFO_DISCARDED** flag in the data returned from **RpcAsyncGetRemoteNotifications**, the client calls [RpcSyncRefreshRemoteNotifications](#) to obtain updated state information.

- The client allocates and initializes an **RpcPrintPropertiesCollection** notifyFilter structure. This can be identical to the filter used in initial registration, or it can specify different settings. The client should increase the value of the "RemoteNotifyFilter Color" property.
- The client calls **RpcSyncRefreshRemoteNotifications** to get updated state information.

```

RpcSyncRefreshRemoteNotification( hNotifyHandle, &notifyFilter, &pNotifyData );

```

- The server prepares notification data as it would from **RpcAsyncGetRemoteNotifications**, returns the data, and returns 0 (success).
5. To stop receiving state notifications, the client cancels any outstanding **RpcAsyncGetRemoteNotifications** calls and then unregisters from change notifications by calling [RpcSyncUnregisterForRemoteNotifications](#) with the handle previously obtained from **RpcSyncRegisterForRemoteNotifications**.

- The client cancels outstanding **RpcAsyncGetRemoteNotifications** calls on hNotifyHandle using the RPC-provided cancel call method.
- The client unregisters from change notifications on hNotifyHandle.

```

RpcSyncUnregisterForRemoteNotifications( &hNotifyHandle );

```

- The server frees the notification context, writes NULL to hNotifyHandle, and returns 0 (success).

6. The client closes the printer or print server handle by calling [RpcAsyncClosePrinter](#).

```
RpcAsyncClosePrinter( &hPrinter );
```

The server frees the memory associated with the print queue handle, sets hPrinter to NULL, and returns 0 (success).

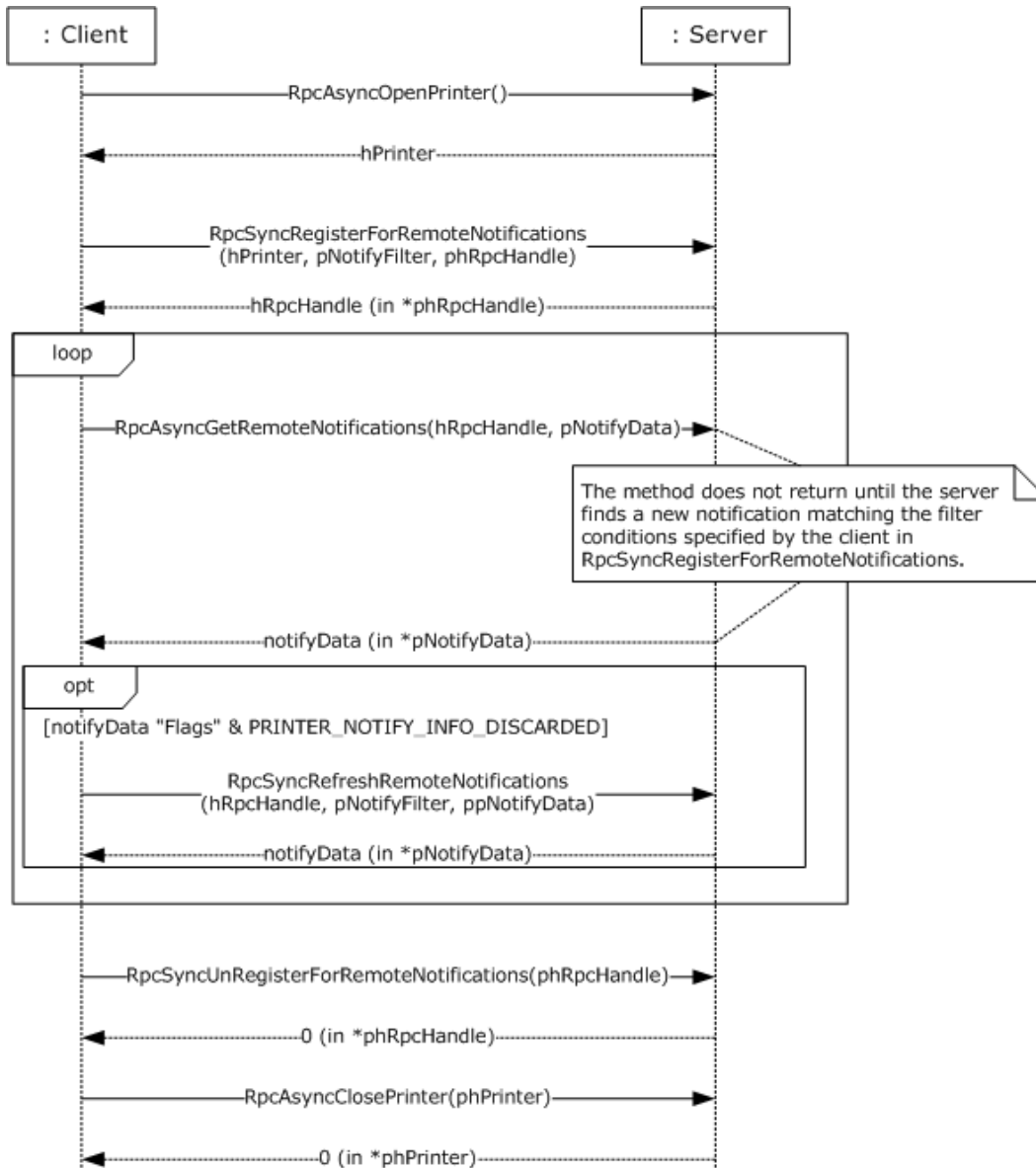

Figure 9: Receiving notifications from a server

5 Security

5.1 Security Considerations for Implementers

Security considerations for implementers of this protocol have been covered in preceding sections.

5.2 Index of Security Parameters

Security considerations for both authenticated and unauthenticated RPC are specified in [\[C706\]](#) chapters [Introduction to the RPC API](#) and [Security](#).

A Print System Asynchronous Remote Protocol client can **failover** to unauthenticated RPC by using the [\[MS-RPRN\]](#) protocol when authenticated RPC fails for backward compatibility. [<38>](#) Unauthenticated RPC is not as secure as authenticated RPC; the client either audits or supports this automatic failover only when it is explicitly specified.

6 Appendix A: Full IDL

For ease of implementation the full IDL for the [IRemoteWinspool interface \(section 3.1.4\)](#) is provided below. The syntax uses IDL syntax extensions defined in [\[MS-RPCE\]](#). Some of the data types and structures used by this interface are defined in other specifications, including [\[MS-DTYP\]](#) and [\[MS-RPRN\]](#).

```
// [MS-PAR] interface
[
    uuid(76F03F96-CDFD-44fc-A22C-64950A001209),
    version(1.0),
#ifdef __midl
    ms_union,
#endif // __midl
    pointer_default(unique)
]
interface IRemoteWinspool {

import "ms-dtyp.idl";

#ifdef __midl < 700
#define disable_consistency_check
#endif

// [MS-RPRN] common constants
#define TABLE_DWORD          0x1
#define TABLE_STRING        0x2
#define TABLE_DEVMODE       0x3
#define TABLE_TIME          0x4
#define TABLE_SECURITYDESCRIPTOR 0x5

#define SPLFILE_CONTENT_TYPE_PROP_NAME L"Spool File Contents"

// [MS-RPRN] common enumerations
typedef enum {
    BIDI_NULL    = 0,
    BIDI_INT     = 1,
    BIDI_FLOAT   = 2,
    BIDI_BOOL    = 3,
    BIDI_STRING  = 4,
    BIDI_TEXT    = 5,
    BIDI_ENUM    = 6,
    BIDI_BLOB    = 7
} BIDI_TYPE;

typedef enum {
    kRpcPropertyTypeString = 1,
    kRpcPropertyTypeInt32,
    kRpcPropertyTypeInt64,
    kRpcPropertyTypeByte,
    kRpcPropertyTypeBuffer
} RPC_EPrintPropertyType;

typedef enum {
    kInvalidJobState = 0,
    kLogJobPrinted,
    kLogJobRendered,
    kLogJobError,

```



```

        kLogJobPipelineError,
        kLogOfflineFileFull
    } EBranchOfficeJobEventType;

// [MS-RPRN] common data types
typedef unsigned short LANGID;
typedef [context_handle] void* GDI_HANDLE;
typedef [context_handle] void* PRINTER_HANDLE;
typedef [handle] wchar_t* STRING_HANDLE;

// [MS-RPRN] common utility structures
typedef struct {
    long cx;
    long cy;
} SIZE;

typedef struct {
    long left;
    long top;
    long right;
    long bottom;
} RECTL;

// [MS-RPRN] common device state structure
typedef struct _devicemode {
    wchar_t  dmDeviceName[32];

    unsigned short dmSpecVersion;
    unsigned short dmDriverVersion;
    unsigned short dmSize;
    unsigned short dmDriverExtra;

    DWORD dmFields;

    short dmOrientation;
    short dmPaperSize;
    short dmPaperLength;
    short dmPaperWidth;
    short dmScale;
    short dmCopies;
    short dmDefaultSource;
    short dmPrintQuality;
    short dmColor;
    short dmDuplex;
    short dmYResolution;
    short dmTTOption;
    short dmCollate;

    wchar_t  dmFormName[32];

    unsigned short reserved0;

    DWORD reserved1;
    DWORD reserved2;
    DWORD reserved3;
    DWORD dmNup;
    DWORD reserved4;
    DWORD dmICMMethod;
    DWORD dmICMIntent;

```

```

        DWORD dmMediaType;
        DWORD dmDitherType;
        DWORD reserved5;
        DWORD reserved6;
        DWORD reserved7;
        DWORD reserved8;
    } DEVMODE;

// [MS-RPRN] common info structures
typedef struct _DOC_INFO_1 {
    [string] wchar_t* pDocName;
    [string] wchar_t* pOutputFile;
    [string] wchar_t* pDatatype;
} DOC_INFO_1;

typedef struct _DRIVER_INFO_1 {
    [string] wchar_t* pName;
} DRIVER_INFO_1;

typedef struct _DRIVER_INFO_2 {
    DWORD cVersion;
    [string] wchar_t* pName;
    [string] wchar_t* pEnvironment;
    [string] wchar_t* pDriverPath;
    [string] wchar_t* pDataFile;
    [string] wchar_t* pConfigFile;
} DRIVER_INFO_2;

typedef struct _RPC_DRIVER_INFO_3 {
    DWORD cVersion;
    [string] wchar_t* pName;
    [string] wchar_t* pEnvironment;
    [string] wchar_t* pDriverPath;
    [string] wchar_t* pDataFile;
    [string] wchar_t* pConfigFile;
    [string] wchar_t* pHelpFile;
    [string] wchar_t* pMonitorName;
    [string] wchar_t* pDefaultDataType;
    DWORD cchDependentFiles;
    [size_is(cchDependentFiles), unique]
    wchar_t* pDependentFiles;
} RPC_DRIVER_INFO_3;

typedef struct _RPC_DRIVER_INFO_4 {
    DWORD cVersion;
    [string] wchar_t* pName;
    [string] wchar_t* pEnvironment;
    [string] wchar_t* pDriverPath;
    [string] wchar_t* pDataFile;
    [string] wchar_t* pConfigFile;
    [string] wchar_t* pHelpFile;
    [string] wchar_t* pMonitorName;
    [string] wchar_t* pDefaultDataType;
    DWORD cchDependentFiles;
    [size_is(cchDependentFiles), unique]
    wchar_t* pDependentFiles;
    DWORD cchPreviousNames;
    [size_is(cchPreviousNames), unique]
    wchar_t* pszPreviousNames;
}

```

```

} RPC_DRIVER_INFO_4;

typedef struct _RPC_DRIVER_INFO_6 {
    DWORD cVersion;
    [string] wchar_t* pName;
    [string] wchar_t* pEnvironment;
    [string] wchar_t* pDriverPath;
    [string] wchar_t* pDataFile;
    [string] wchar_t* pConfigFile;
    [string] wchar_t* pHelpFile;
    [string] wchar_t* pMonitorName;
    [string] wchar_t* pDefaultDataType;
    DWORD cchDependentFiles;
    [size_is(cchDependentFiles), unique]
    wchar_t* pDependentFiles;
    DWORD cchPreviousNames;
    [size_is(cchPreviousNames), unique]
    wchar_t* pszPreviousNames;
    FILETIME ftDriverDate;
    DWORDLONG dwlDriverVersion;
    [string] wchar_t* pMfgName;
    [string] wchar_t* pOEMUrl;
    [string] wchar_t* pHardwareID;
    [string] wchar_t* pProvider;
} RPC_DRIVER_INFO_6;

typedef struct _RPC_DRIVER_INFO_8 {
    DWORD cVersion;
    [string] wchar_t* pName;
    [string] wchar_t* pEnvironment;
    [string] wchar_t* pDriverPath;
    [string] wchar_t* pDataFile;
    [string] wchar_t* pConfigFile;
    [string] wchar_t* pHelpFile;
    [string] wchar_t* pMonitorName;
    [string] wchar_t* pDefaultDataType;
    DWORD cchDependentFiles;
    [size_is(cchDependentFiles), unique]
    wchar_t* pDependentFiles;
    DWORD cchPreviousNames;
    [size_is(cchPreviousNames), unique]
    wchar_t* pszPreviousNames;
    FILETIME ftDriverDate;
    DWORDLONG dwlDriverVersion;
    [string] wchar_t* pMfgName;
    [string] wchar_t* pOEMUrl;
    [string] wchar_t* pHardwareID;
    [string] wchar_t* pProvider;
    [string] wchar_t* pPrintProcessor;
    [string] wchar_t* pVendorSetup;
    DWORD cchColorProfiles;
    [size_is(cchColorProfiles), unique]
    wchar_t* pszColorProfiles;
    [string] wchar_t* pInfPath;
    DWORD dwPrinterDriverAttributes;
    DWORD cchCoreDependencies;
    [size_is(cchCoreDependencies), unique]
    wchar_t* pszCoreDriverDependencies;
    FILETIME ftMinInboxDriverVerDate;
}

```

```

        DWORDLONG dwlMinInboxDriverVerVersion;
    } RPC_DRIVER_INFO_8;

typedef struct _FORM_INFO_1 {
    DWORD Flags;
    [string] wchar_t* pName;
    SIZE Size;
    RECTL ImageableArea;
} FORM_INFO_1;

typedef struct _RPC_FORM_INFO_2 {
    DWORD Flags;
    [string, unique] const wchar_t* pName;
    SIZE Size;
    RECTL ImageableArea;
    [string, unique] const char* pKeyword;
    DWORD StringType;
    [string, unique] const wchar_t* pMuiDll;
    DWORD dwResourceId;
    [string, unique] const wchar_t* pDisplayName;
    LANGID wLangID;
} RPC_FORM_INFO_2;

typedef struct _JOB_INFO_1 {
    DWORD JobId;
    [string] wchar_t* pPrinterName;
    [string] wchar_t* pMachineName;
    [string] wchar_t* pUserName;
    [string] wchar_t* pDocument;
    [string] wchar_t* pDatatype;
    [string] wchar_t* pStatus;
    DWORD Status;
    DWORD Priority;
    DWORD Position;
    DWORD TotalPages;
    DWORD PagesPrinted;
    SYSTEMTIME Submitted;
} JOB_INFO_1;

typedef struct _JOB_INFO_2 {
    DWORD JobId;
    [string] wchar_t* pPrinterName;
    [string] wchar_t* pMachineName;
    [string] wchar_t* pUserName;
    [string] wchar_t* pDocument;
    [string] wchar_t* pNotifyName;
    [string] wchar_t* pDatatype;
    [string] wchar_t* pPrintProcessor;
    [string] wchar_t* pParameters;
    [string] wchar_t* pDriverName;
    DEVMODE* pDevMode;
    [string] wchar_t* pStatus;
    SECURITY_DESCRIPTOR* pSecurityDescriptor;
    DWORD Status;
    DWORD Priority;
    DWORD Position;
    DWORD StartTime;
    DWORD UntilTime;
    DWORD TotalPages;
}

```

```

        DWORD Size;
        SYSTEMTIME Submitted;
        DWORD Time;
        DWORD PagesPrinted;
    } JOB_INFO_2;

typedef struct _JOB_INFO_3 {
    DWORD JobId;
    DWORD NextJobId;
    DWORD Reserved;
} JOB_INFO_3;

typedef struct _JOB_INFO_4 {
    DWORD JobId;
    [string] wchar_t* pPrinterName;
    [string] wchar_t* pMachineName;
    [string] wchar_t* pUserName;
    [string] wchar_t* pDocument;
    [string] wchar_t* pNotifyName;
    [string] wchar_t* pDatatype;
    [string] wchar_t* pPrintProcessor;
    [string] wchar_t* pParameters;
    [string] wchar_t* pDriverName;
    DEVMODE* pDevMode;
    [string] wchar_t* pStatus;
    SECURITY_DESCRIPTOR* pSecurityDescriptor;
    DWORD Status;
    DWORD Priority;
    DWORD Position;
    DWORD StartTime;
    DWORD UntilTime;
    DWORD TotalPages;
    DWORD Size;
    SYSTEMTIME Submitted;
    DWORD Time;
    DWORD PagesPrinted;
    long SizeHigh;
} JOB_INFO_4;

typedef struct _MONITOR_INFO_1 {
    [string] wchar_t* pName;
} MONITOR_INFO_1;

typedef struct _MONITOR_INFO_2 {
    [string] wchar_t* pName;
    [string] wchar_t* pEnvironment;
    [string] wchar_t* pDLLName;
} MONITOR_INFO_2;

typedef struct _PORT_INFO_1 {
    [string] wchar_t* pPortName;
} PORT_INFO_1;

typedef struct _PORT_INFO_2 {
    [string] wchar_t* pPortName;
    [string] wchar_t* pMonitorName;
    [string] wchar_t* pDescription;
    DWORD fPortType;
    DWORD Reserved;
}

```

```

} PORT_INFO_2;

typedef struct _PORT_INFO_3 {
    DWORD dwStatus;
    [string] wchar_t* pszStatus;
    DWORD dwSeverity;
} PORT_INFO_3;

typedef struct _PORT_INFO_FF {
    [string] wchar_t* pPortName;
    DWORD cbMonitorData;
    BYTE* pMonitorData;
} PORT_INFO_FF;

typedef struct _PRINTER_INFO_STRESS {
    [string] wchar_t* pPrinterName;
    [string] wchar_t* pServerName;
    DWORD cJobs;
    DWORD cTotalJobs;
    DWORD cTotalBytes;
    SYSTEMTIME stUpTime;
    DWORD MaxcRef;
    DWORD cTotalPagesPrinted;
    DWORD dwGetVersion;
    DWORD fFreeBuild;
    DWORD cSpooling;
    DWORD cMaxSpooling;
    DWORD cRef;
    DWORD cErrorOutOfPaper;
    DWORD cErrorNotReady;
    DWORD cJobError;
    DWORD dwNumberOfProcessors;
    DWORD dwProcessorType;
    DWORD dwHighPartTotalBytes;
    DWORD cChangeID;
    DWORD dwLastError;
    DWORD Status;
    DWORD cEnumerateNetworkPrinters;
    DWORD cAddNetPrinters;
    unsigned short wProcessorArchitecture;
    unsigned short wProcessorLevel;
    DWORD cRefIC;
    DWORD dwReserved2;
    DWORD dwReserved3;
} PRINTER_INFO_STRESS;

typedef struct _PRINTER_INFO_1 {
    DWORD Flags;
    [string] wchar_t* pDescription;
    [string] wchar_t* pName;
    [string] wchar_t* pComment;
} PRINTER_INFO_1;

typedef struct _PRINTER_INFO_2 {
    [string] wchar_t* pServerName;
    [string] wchar_t* pPrinterName;
    [string] wchar_t* pShareName;
    [string] wchar_t* pPortName;
    [string] wchar_t* pDriverName;

```

```

    [string] wchar_t* pComment;
    [string] wchar_t* pLocation;
    DEVMODE* pDevMode;
    [string] wchar_t* pSepFile;
    [string] wchar_t* pPrintProcessor;
    [string] wchar_t* pDatatype;
    [string] wchar_t* pParameters;
    SECURITY_DESCRIPTOR* pSecurityDescriptor;
    DWORD Attributes;
    DWORD Priority;
    DWORD DefaultPriority;
    DWORD StartTime;
    DWORD UntilTime;
    DWORD Status;
    DWORD cJobs;
    DWORD AveragePPM;
} PRINTER_INFO_2;

typedef struct _PRINTER_INFO_3 {
    SECURITY_DESCRIPTOR* pSecurityDescriptor;
} PRINTER_INFO_3;

typedef struct _PRINTER_INFO_4 {
    [string] wchar_t* pPrinterName;
    [string] wchar_t* pServerName;
    DWORD Attributes;
} PRINTER_INFO_4;

typedef struct _PRINTER_INFO_5 {
    [string] wchar_t* pPrinterName;
    [string] wchar_t* pPortName;
    DWORD Attributes;
    DWORD DeviceNotSelectedTimeout;
    DWORD TransmissionRetryTimeout;
} PRINTER_INFO_5;

typedef struct _PRINTER_INFO_6 {
    DWORD dwStatus;
} PRINTER_INFO_6;

typedef struct _PRINTER_INFO_7 {
    [string] wchar_t* pszObjectGUID;
    DWORD dwAction;
} PRINTER_INFO_7;

typedef struct _PRINTER_INFO_8 {
    DEVMODE* pDevMode;
} PRINTER_INFO_8;

typedef struct _PRINTER_INFO_9 {
    DEVMODE* pDevMode;
} PRINTER_INFO_9;

typedef struct _SPLCLIENT_INFO_1 {
    DWORD dwSize;
    [string] wchar_t* pMachineName;
    [string] wchar_t* pUserName;
    DWORD dwBuildNum;
    DWORD dwMajorVersion;
}

```

```

        DWORD dwMinorVersion;
        unsigned short wProcessorArchitecture;
    } SPLCLIENT_INFO_1;

typedef struct _SPLCLIENT_INFO_2 {
    LONG_PTR notUsed;
} SPLCLIENT_INFO_2;

typedef struct _SPLCLIENT_INFO_3 {
    unsigned int cbSize;
    DWORD dwFlags;
    DWORD dwSize;
    [string] wchar_t* pMachineName;
    [string] wchar_t* pUserName;
    DWORD dwBuildNum;
    DWORD dwMajorVersion;
    DWORD dwMinorVersion;
    unsigned short wProcessorArchitecture;
    unsigned __int64 hSplPrinter;
} SPLCLIENT_INFO_3;

// [MS-RPRN] common info container structures
typedef struct _DEVMODE_CONTAINER {
    DWORD cbBuf;
    [size_is(cbBuf), unique] BYTE* pDevMode;
} DEVMODE_CONTAINER;

typedef struct _DOC_INFO_CONTAINER {
    DWORD Level;
    [switch_is(Level)] union {
        [case(1)]
            DOC_INFO_1* pDocInfo1;
    } DocInfo;
} DOC_INFO_CONTAINER;

typedef struct _DRIVER_CONTAINER {
    DWORD Level;
    [switch_is(Level)] union {
        [case(1)]
            DRIVER_INFO_1* Level1;
        [case(2)]
            DRIVER_INFO_2* Level2;
        [case(3)]
            RPC_DRIVER_INFO_3* Level3;
        [case(4)]
            RPC_DRIVER_INFO_4* Level4;
        [case(6)]
            RPC_DRIVER_INFO_6* Level6;
        [case(8)]
            RPC_DRIVER_INFO_8* Level8;
    } DriverInfo;
} DRIVER_CONTAINER;

typedef struct _FORM_CONTAINER {
    DWORD Level;
    [switch_is(Level)] union {
        [case(1)]
            FORM_INFO_1* pFormInfo1;
        [case(2)]

```



```

        RPC_FORM_INFO_2* pFormInfo2;
    } FormInfo;
} FORM_CONTAINER;

typedef struct _JOB_CONTAINER {
    DWORD Level;
    [switch_is(Level)] union {
        [case(1)]
            JOB_INFO_1* Level1;
        [case(2)]
            JOB_INFO_2* Level2;
        [case(3)]
            JOB_INFO_3* Level3;
        [case(4)]
            JOB_INFO_4* Level4;
    } JobInfo;
} JOB_CONTAINER;

typedef struct _MONITOR_CONTAINER {
    DWORD Level;
    [switch_is(Level)] union {
        [case(1)]
            MONITOR_INFO_1* pMonitorInfo1;
        [case(2)]
            MONITOR_INFO_2* pMonitorInfo2;
    } MonitorInfo;
} MONITOR_CONTAINER;

typedef struct _PORT_CONTAINER {
    DWORD Level;
    [switch_is(0x00FFFFFF & Level)]
    union {
        [case(1)]
            PORT_INFO_1* pPortInfo1;
        [case(2)]
            PORT_INFO_2* pPortInfo2;
        [case(3)]
            PORT_INFO_3* pPortInfo3;
        [case(0x00FFFFFF)]
            PORT_INFO_FF* pPortInfoFF;
    } PortInfo;
} PORT_CONTAINER;

typedef struct _PORT_VAR_CONTAINER {
    DWORD cbMonitorData;
    [size_is(cbMonitorData), unique, disable_consistency_check]
    BYTE* pMonitorData;
} PORT_VAR_CONTAINER;

typedef struct _PRINTER_CONTAINER {
    DWORD Level;
    [switch_is(Level)] union {
        [case(0)]
            PRINTER_INFO_STRESS* pPrinterInfoStress;
        [case(1)]
            PRINTER_INFO_1* pPrinterInfo1;
        [case(2)]
            PRINTER_INFO_2* pPrinterInfo2;
        [case(3)]

```

```

        PRINTER_INFO_3* pPrinterInfo3;
    [case(4)]
        PRINTER_INFO_4* pPrinterInfo4;
    [case(5)]
        PRINTER_INFO_5* pPrinterInfo5;
    [case(6)]
        PRINTER_INFO_6* pPrinterInfo6;
    [case(7)]
        PRINTER_INFO_7* pPrinterInfo7;
    [case(8)]
        PRINTER_INFO_8* pPrinterInfo8;
    [case(9)]
        PRINTER_INFO_9* pPrinterInfo9;
    } PrinterInfo;
} PRINTER_CONTAINER;

typedef struct _RPC_BINARY_CONTAINER {
    DWORD cbBuf;
    [size_is(cbBuf), unique] BYTE* pszString;
} RPC_BINARY_CONTAINER;

typedef struct _RPC_BIDI_DATA {
    DWORD dwBidiType;
    [switch_is(dwBidiType)] union {
    [case(BIDI_NULL, BIDI_BOOL)]
        int bData;
    [case(BIDI_INT)]
        long iData;
    [case(BIDI_STRING, BIDI_TEXT, BIDI_ENUM)]
        [string,unique] wchar_t* sData;
    [case(BIDI_FLOAT)]
        float fData;
    [case(BIDI_BLOB)]
        RPC_BINARY_CONTAINER biData;
    } u;
} RPC_BIDI_DATA;

typedef struct _RPC_BIDI_REQUEST_DATA {
    DWORD dwReqNumber;
    [string, unique] wchar_t* pSchema;
    RPC_BIDI_DATA data;
} RPC_BIDI_REQUEST_DATA;

typedef struct _RPC_BIDI_RESPONSE_DATA {
    DWORD dwResult;
    DWORD dwReqNumber;
    [string, unique] wchar_t* pSchema;
    RPC_BIDI_DATA data;
} RPC_BIDI_RESPONSE_DATA;

typedef struct _RPC_BIDI_REQUEST_CONTAINER {
    DWORD Version;
    DWORD Flags;
    DWORD Count;
    [size_is(Count), unique] RPC_BIDI_REQUEST_DATA aData[];
} RPC_BIDI_REQUEST_CONTAINER;

typedef struct _RPC_BIDI_RESPONSE_CONTAINER {
    DWORD Version;

```

```

    DWORD Flags;
    DWORD Count;
    [size_is(Count), unique] RPC_BIDI_RESPONSE_DATA aData[];
} RPC_BIDI_RESPONSE_CONTAINER;

typedef struct SECURITY_CONTAINER {
    DWORD cbBuf;
    [size_is(cbBuf), unique] BYTE* pSecurity;
} SECURITY_CONTAINER;

typedef struct _SPLCLIENT_CONTAINER {
    DWORD Level;
    [switch_is(Level)] union {
        [case(1)]
            SPLCLIENT_INFO_1* pClientInfo1;
        [case(2)]
            SPLCLIENT_INFO_2* pNotUsed;
        [case(3)]
            SPLCLIENT_INFO_3* pClientInfo3;
    } ClientInfo;
} SPLCLIENT_CONTAINER;

typedef struct _STRING_CONTAINER {
    DWORD cbBuf;
    [size_is(cbBuf/2), unique] WCHAR* pszString;
} STRING_CONTAINER;

typedef struct _SYSTEMTIME_CONTAINER {
    DWORD cbBuf;
    SYSTEMTIME* pSystemTime;
} SYSTEMTIME_CONTAINER;

typedef struct _RPC_V2_NOTIFY_OPTIONS_TYPE {
    unsigned short Type;
    unsigned short Reserved0;
    DWORD Reserved1;
    DWORD Reserved2;
    DWORD Count;
    [size_is(Count), unique] unsigned short* pFields;
} RPC_V2_NOTIFY_OPTIONS_TYPE;

typedef struct _RPC_V2_NOTIFY_OPTIONS {
    DWORD Version;
    DWORD Reserved;
    DWORD Count;
    [size_is(Count), unique] RPC_V2_NOTIFY_OPTIONS_TYPE* pTypes;
} RPC_V2_NOTIFY_OPTIONS;

typedef
[switch_type (DWORD)]
union _RPC_V2_NOTIFY_INFO_DATA_DATA {
    [case(TABLE_STRING)]
        STRING_CONTAINER String;
    [case(TABLE_DWORD)]
        DWORD dwData[2];
    [case(TABLE_TIME)]
        SYSTEMTIME_CONTAINER SystemTime;
    [case(TABLE_DEVMODE)]
        DEVMODE_CONTAINER DevMode;
}

```

```

        [case(TABLE_SECURITYDESCRIPTOR)]
            SECURITY_CONTAINER SecurityDescriptor;
    } RPC_V2_NOTIFY_INFO_DATA_DATA;

typedef struct _RPC_V2_NOTIFY_INFO_DATA {
    unsigned short Type;
    unsigned short Field;
    DWORD Reserved;
    DWORD Id;
    [switch_is(Reserved & 0xffff)]
        RPC_V2_NOTIFY_INFO_DATA_DATA Data;
} RPC_V2_NOTIFY_INFO_DATA;

typedef struct _RPC_V2_NOTIFY_INFO {
    DWORD Version;
    DWORD Flags;
    DWORD Count;
    [size_is(Count), unique] RPC_V2_NOTIFY_INFO_DATA aData[];
} RPC_V2_NOTIFY_INFO;

typedef [switch_type(DWORD)] union _RPC_V2_UREPLY_PRINTER {
    [case (0)]
        RPC_V2_NOTIFY_INFO* pInfo;
} RPC_V2_UREPLY_PRINTER;

typedef struct {
    DWORD Status;
    [string] wchar_t* pDocumentName;
    [string] wchar_t* pUserName;
    [string] wchar_t* pMachineName;
    [string] wchar_t* pPrinterName;
    [string] wchar_t* pPortName;
    LONGLONG Size;
    DWORD TotalPages;
} RPC_BranchOfficeJobDataPrinted;

typedef struct {
    LONGLONG Size;
    DWORD ICMMethod;
    short Color;
    short PrintQuality;
    short YResolution;
    short Copies;
    short TTOption;
} RPC_BranchOfficeJobDataRendered;

typedef struct {
    DWORD LastError;
    [string] wchar_t* pDocumentName;
    [string] wchar_t* pUserName;
    [string] wchar_t* pPrinterName;
    [string] wchar_t* pDataTypes;
    LONGLONG TotalSize;
    LONGLONG PrintedSize;
    DWORD TotalPages;
    DWORD PrintedPages;
    [string] wchar_t* pMachineName;
    [string] wchar_t* pJobError;
    [string] wchar_t* pErrorDescription;
}

```

```

} RPC_BranchOfficeJobDataError;

typedef struct {
    [string] wchar_t* pDocumentName;
    [string] wchar_t* pPrinterName;
    [string] wchar_t* pExtraErrorInfo;
} RPC_BranchOfficeJobDataPipelineFailed;

typedef struct {
    [string] wchar_t* pMachineName;
} RPC_BranchOfficeLogOfflineFileFull;

typedef struct {
    EBranchOfficeJobEventType eEventType;
    DWORD JobId;

    [switch_type(EBranchOfficeJobEventType), switch_is(eEventType)]
    union {
        [case(kLogJobPrinted)]
            RPC_BranchOfficeJobDataPrinted LogJobPrinted;
        [case(kLogJobRendered)]
            RPC_BranchOfficeJobDataRendered LogJobRendered;
        [case(kLogJobError)]
            RPC_BranchOfficeJobDataError LogJobError;
        [case(kLogJobPipelineError)]
            RPC_BranchOfficeJobDataPipelineFailed LogPipelineFailed;
        [case(kLogOfflineFileFull)]
            RPC_BranchOfficeLogOfflineFileFull LogOfflineFileFull;
    } JobInfo;
} RPC_BranchOfficeJobData;

typedef struct {
    DWORD cJobDataEntries;
    [size_is(cJobDataEntries), unique] RPC_BranchOfficeJobData JobData[];
} RPC_BranchOfficeJobDataContainer;

// [MS-PAR] enumerations
typedef enum {
    kPropertyTypeString = 1,
    kPropertyTypeInt32,
    kPropertyTypeInt64,
    kPropertyTypeByte,
    kPropertyTypeTime,
    kPropertyTypeDevMode,
    kPropertyTypeSD,
    kPropertyTypeNotificationReply,
    kPropertyTypeNotificationOptions,
} EPrintPropertyType;

// [MS-PAR] data types
typedef [context_handle] void *RMTNTFY_HANDLE;

// [MS-PAR] structures
typedef struct _NOTIFY_REPLY_CONTAINER {
    RPC_V2_NOTIFY_INFO* pInfo;
} NOTIFY_REPLY_CONTAINER;

typedef struct _NOTIFY_OPTIONS_CONTAINER {
    RPC_V2_NOTIFY_OPTIONS* pOptions;
}

```

```

} NOTIFY_OPTIONS_CONTAINER;

typedef struct {
    EPrintPropertyType ePropertyType;

    [switch_type(EPrintPropertyType), switch_is(ePropertyType)]
    union {
        [case(kPropertyTypeString)]
            [string] wchar_t* propertyString;
        [case(kPropertyTypeInt32)]
            long propertyInt32;
        [case(kPropertyTypeInt64)]
            __int64 propertyInt64;
        [case(kPropertyTypeByte)]
            BYTE propertyByte;
        [case(kPropertyTypeTime)]
            SYSTEMTIME_CONTAINER propertyTimeContainer;
        [case(kPropertyTypeDevMode)]
            DEVMODE_CONTAINER propertyDevModeContainer;
        [case(kPropertyTypeSD)]
            SECURITY_CONTAINER propertySDContainer;
        [case(kPropertyTypeNotificationReply)]
            NOTIFY_REPLY_CONTAINER propertyReplyContainer;
        [case(kPropertyTypeNotificationOptions)]
            NOTIFY_OPTIONS_CONTAINER propertyOptionsContainer;
    } value;
} RpcPrintPropertyValue;

typedef struct {
    [string] wchar_t* propertyName;
    RpcPrintPropertyValue propertyValue;
} RpcPrintNamedProperty;

typedef struct {
    [range(0, 50)]
    unsigned long numberOfProperties;

    [size_is(numberOfProperties), unique]
    RpcPrintNamedProperty* propertiesCollection;
}RpcPrintPropertiesCollection;

typedef struct _CORE_PRINTER_DRIVER {
    GUID CoreDriverGUID;
    FILETIME ftDriverDate;
    DWORDLONG dwlDriverVersion;
    wchar_t szPackageID[260];
} CORE_PRINTER_DRIVER;

typedef struct {
    RPC_EPrintPropertyType ePropertyType;
    [switch_is(ePropertyType)] union {
        [case(kRpcPropertyTypeString)] [string] wchar_t *propertyString;
        [case(kRpcPropertyTypeInt32)] LONG propertyInt32;
        [case(kRpcPropertyTypeInt64)] LONGLONG propertyInt64;
        [case(kRpcPropertyTypeByte)] BYTE propertyByte;
        [case(kRpcPropertyTypeBuffer)]
            struct {
                DWORD cbBuf;
                [size_is(cbBuf)] BYTE *pBuf;
            }
    }
}

```

```

        } propertyBlob;
    } value;
} RPC_PrintPropertyValue;

typedef struct {
    [string] wchar_t          *propertyName;
    RPC_PrintPropertyValue propertyValue;
} RPC_PrintNamedProperty;

// [MS-PAR] methods
DWORD
RpcAsyncOpenPrinter(
    [in] handle_t hRemoteBinding,
    [in, string, unique] wchar_t* pPrinterName,
    [out] PRINTER_HANDLE* pHandle,
    [in, string, unique] wchar_t* pDataatype,
    [in] DEVMODE_CONTAINER* pDevModeContainer,
    [in] DWORD AccessRequired,
    [in] SPLCLIENT_CONTAINER* pClientInfo
);

DWORD
RpcAsyncAddPrinter(
    [in] handle_t hRemoteBinding,
    [in, string, unique] wchar_t* pName,
    [in] PRINTER_CONTAINER* pPrinterContainer,
    [in] DEVMODE_CONTAINER* pDevModeContainer,
    [in] SECURITY_CONTAINER* pSecurityContainer,
    [in] SPLCLIENT_CONTAINER* pClientInfo,
    [out] PRINTER_HANDLE* pHandle
);

DWORD
RpcAsyncSetJob(
    [in] PRINTER_HANDLE hPrinter,
    [in] DWORD JobId,
    [in, unique] JOB_CONTAINER* pJobContainer,
    [in] DWORD Command
);

DWORD
RpcAsyncGetJob(
    [in] PRINTER_HANDLE hPrinter,
    [in] DWORD JobId,
    [in] DWORD Level,
    [in, out, unique, size_is(cbBuf)] unsigned char* pJob,
    [in] DWORD cbBuf,
    [out] DWORD* pcbNeeded
);

DWORD
RpcAsyncEnumJobs(
    [in] PRINTER_HANDLE hPrinter,
    [in] DWORD FirstJob,
    [in] DWORD NoJobs,
    [in] DWORD Level,
    [in, out, unique, size_is(cbBuf)] unsigned char* pJob,
    [in] DWORD cbBuf,
    [out] DWORD* pcbNeeded,

```

```

    [out] DWORD* pcReturned
);

DWORD
RpcAsyncAddJob(
    [in] PRINTER_HANDLE hPrinter,
    [in] DWORD Level,
    [in, out, unique, size_is(cbBuf)] unsigned char* pAddJob,
    [in] DWORD cbBuf,
    [out] DWORD* pcbNeeded
);

DWORD
RpcAsyncScheduleJob(
    [in] PRINTER_HANDLE hPrinter,
    [in] DWORD JobId
);

DWORD
RpcAsyncDeletePrinter(
    [in] PRINTER_HANDLE hPrinter
);

DWORD
RpcAsyncSetPrinter(
    [in] PRINTER_HANDLE hPrinter,
    [in] PRINTER_CONTAINER* pPrinterContainer,
    [in] DEVMODE_CONTAINER* pDevModeContainer,
    [in] SECURITY_CONTAINER* pSecurityContainer,
    [in] DWORD Command
);

DWORD
RpcAsyncGetPrinter(
    [in] PRINTER_HANDLE hPrinter,
    [in] DWORD Level,
    [in, out, unique, size_is(cbBuf)] unsigned char* pPrinter,
    [in] DWORD cbBuf,
    [out] DWORD* pcbNeeded
);

DWORD
RpcAsyncStartDocPrinter(
    [in] PRINTER_HANDLE hPrinter,
    [in] DOC_INFO_CONTAINER* pDocInfoContainer,
    [out] DWORD* pJobId
);

DWORD
RpcAsyncStartPagePrinter(
    [in] PRINTER_HANDLE hPrinter
);

DWORD
RpcAsyncWritePrinter(
    [in] PRINTER_HANDLE hPrinter,
    [in, size_is(cbBuf)] unsigned char* pBuf,
    [in] DWORD cbBuf,
    [out] DWORD* pcWritten
);

```



```

);

DWORD
RpcAsyncEndPagePrinter(
    [in] PRINTER_HANDLE hPrinter
);

DWORD
RpcAsyncEndDocPrinter(
    [in] PRINTER_HANDLE hPrinter
);

DWORD
RpcAsyncAbortPrinter(
    [in] PRINTER_HANDLE hPrinter
);

DWORD
RpcAsyncGetPrinterData(
    [in] PRINTER_HANDLE hPrinter,
    [in, string] wchar_t* pValueName,
    [out] DWORD* pType,
    [out, size_is(nSize)] unsigned char* pData,
    [in] DWORD nSize,
    [out] DWORD* pcbNeeded
);

DWORD
RpcAsyncGetPrinterDataEx(
    [in] PRINTER_HANDLE hPrinter,
    [in, string] const wchar_t* pKeyName,
    [in, string] const wchar_t* pValueName,
    [out] DWORD* pType,
    [out, size_is(nSize)] unsigned char* pData,
    [in] DWORD nSize,
    [out] DWORD* pcbNeeded
);

DWORD
RpcAsyncSetPrinterData(
    [in] PRINTER_HANDLE hPrinter,
    [in, string] wchar_t* pValueName,
    [in] DWORD Type,
    [in, size_is(cbData)] unsigned char* pData,
    [in] DWORD cbData
);

DWORD
RpcAsyncSetPrinterDataEx(
    [in] PRINTER_HANDLE hPrinter,
    [in, string] const wchar_t* pKeyName,
    [in, string] const wchar_t* pValueName,
    [in] DWORD Type,
    [in, size_is(cbData)] unsigned char* pData,
    [in] DWORD cbData
);

DWORD
RpcAsyncClosePrinter(

```

```

    [in, out] PRINTER_HANDLE* phPrinter
);

DWORD
RpcAsyncAddForm(
    [in] PRINTER_HANDLE hPrinter,
    [in] FORM_CONTAINER* pFormInfoContainer
);

DWORD
RpcAsyncDeleteForm(
    [in] PRINTER_HANDLE hPrinter,
    [in, string] wchar_t* pFormName
);

DWORD
RpcAsyncGetForm(
    [in] PRINTER_HANDLE hPrinter,
    [in, string] wchar_t* pFormName,
    [in] DWORD Level,
    [in, out, unique, size_is(cbBuf)] unsigned char* pForm,
    [in] DWORD cbBuf,
    [out] DWORD* pcbNeeded
);

DWORD
RpcAsyncSetForm(
    [in] PRINTER_HANDLE hPrinter,
    [in, string] wchar_t* pFormName,
    [in] FORM_CONTAINER* pFormInfoContainer
);

DWORD
RpcAsyncEnumForms(
    [in] PRINTER_HANDLE hPrinter,
    [in] DWORD Level,
    [in, out, unique, size_is(cbBuf)] unsigned char* pForm,
    [in] DWORD cbBuf,
    [out] DWORD* pcbNeeded,
    [out] DWORD* pcReturned
);

DWORD
RpcAsyncGetPrinterDriver(
    [in] PRINTER_HANDLE hPrinter,
    [in, unique, string] wchar_t* pEnvironment,
    [in] DWORD Level,
    [in, out, unique, size_is(cbBuf)] unsigned char* pDriver,
    [in] DWORD cbBuf,
    [out] DWORD* pcbNeeded,
    [in] DWORD dwClientMajorVersion,
    [in] DWORD dwClientMinorVersion,
    [out] DWORD* pdwServerMaxVersion,
    [out] DWORD* pdwServerMinVersion
);

DWORD
RpcAsyncEnumPrinterData(
    [in] PRINTER_HANDLE hPrinter,

```

```

[in] DWORD dwIndex,
[out, size_is(cbValueName/sizeof(wchar_t))] wchar_t* pValueName,
[in] DWORD cbValueName,
[out] DWORD* pcbValueName,
[out] DWORD* pType,
[out, size_is(cbData)] unsigned char* pData,
[in] DWORD cbData,
[out] DWORD* pcbData
);

DWORD
RpcAsyncEnumPrinterDataEx(
[in] PRINTER_HANDLE hPrinter,
[in, string] const wchar_t* pKeyName,
[out, size_is(cbEnumValues)] unsigned char* pEnumValues,
[in] DWORD cbEnumValues,
[out] DWORD* pcbEnumValues,
[out] DWORD* pnEnumValues
);

DWORD
RpcAsyncEnumPrinterKey(
[in] PRINTER_HANDLE hPrinter,
[in, string] const wchar_t* pKeyName,
[out, size_is(cbSubkey/sizeof(wchar_t))] wchar_t* pSubkey,
[in] DWORD cbSubkey,
[out] DWORD* pcbSubkey
);

DWORD
RpcAsyncDeletePrinterData(
[in] PRINTER_HANDLE hPrinter,
[in, string] wchar_t* pValueName
);

DWORD
RpcAsyncDeletePrinterDataEx(
[in] PRINTER_HANDLE hPrinter,
[in, string] const wchar_t* pKeyName,
[in, string] const wchar_t* pValueName
);

DWORD
RpcAsyncDeletePrinterKey(
[in] PRINTER_HANDLE hPrinter,
[in, string] const wchar_t* pKeyName
);

DWORD
RpcAsyncXcvData(
[in] PRINTER_HANDLE hXcv,
[in, string] const wchar_t* pszDataName,
[in, size_is(cbInputData)] unsigned char* pInputData,
[in] DWORD cbInputData,
[out, size_is(cbOutputData)] unsigned char* pOutputData,
[in] DWORD cbOutputData,
[out] DWORD* pcbOutputNeeded,
[in, out] DWORD* pdwStatus
);

```

```

DWORD
RpcAsyncSendRecvBidiData (
    [in] PRINTER_HANDLE hPrinter,
    [in, string, unique] const wchar_t* pAction,
    [in] RPC_BIDI_REQUEST_CONTAINER* pReqData,
    [out] RPC_BIDI_RESPONSE_CONTAINER** ppRespData);

DWORD
RpcAsyncCreatePrinterIC(
    [in] PRINTER_HANDLE hPrinter,
    [out] GDI_HANDLE *pHandle,
    [in] DEVMODE_CONTAINER* pDevModeContainer
);

DWORD
RpcAsyncPlayGdiScriptOnPrinterIC(
    [in] GDI_HANDLE hPrinterIC,
    [in, size_is(cIn)] unsigned char* pIn,
    [in] DWORD cIn,
    [out, size_is(cOut)] unsigned char* pOut,
    [in] DWORD cOut,
    [in] DWORD ul
);

DWORD
RpcAsyncDeletePrinterIC(
    [in, out] GDI_HANDLE* phPrinterIC
);

DWORD
RpcAsyncEnumPrinters(
    [in] handle_t hRemoteBinding,
    [in] DWORD Flags,
    [in, string, unique] wchar_t* Name,
    [in] DWORD Level,
    [in, out, unique, size_is(cbBuf)] unsigned char* pPrinterEnum,
    [in] DWORD cbBuf,
    [out] DWORD* pcbNeeded,
    [out] DWORD* pcReturned
);

DWORD
RpcAsyncAddPrinterDriver(
    [in] handle_t hRemoteBinding,
    [in, string, unique] wchar_t* pName,
    [in] DRIVER_CONTAINER* pDriverContainer,
    [in] DWORD dwFileCopyFlags
);

DWORD
RpcAsyncEnumPrinterDrivers(
    [in] handle_t hRemoteBinding,
    [in, string, unique] wchar_t* pName,
    [in, unique, string] wchar_t* pEnvironment,
    [in] DWORD Level,
    [in, out, unique, size_is(cbBuf)] unsigned char* pDrivers,
    [in] DWORD cbBuf,
    [out] DWORD* pcbNeeded,

```

```

    [out] DWORD* pcReturned
);

DWORD
RpcAsyncGetPrinterDriverDirectory(
    [in] handle_t hRemoteBinding,
    [in, string, unique] wchar_t* pName,
    [in, unique, string] wchar_t* pEnvironment,
    [in] DWORD Level,
    [in, out, unique, size_is(cbBuf)] unsigned char* pDriverDirectory,
    [in] DWORD cbBuf,
    [out] DWORD* pcbNeeded
);

DWORD
RpcAsyncDeletePrinterDriver(
    [in] handle_t hRemoteBinding,
    [in, string, unique] wchar_t* pName,
    [in, string] wchar_t* pEnvironment,
    [in, string] wchar_t* pDriverName
);

DWORD
RpcAsyncDeletePrinterDriverEx(
    [in] handle_t hRemoteBinding,
    [in, string, unique] wchar_t* pName,
    [in, string] wchar_t* pEnvironment,
    [in, string] wchar_t* pDriverName,
    [in] DWORD dwDeleteFlag,
    [in] DWORD dwVersionNum
);

DWORD
RpcAsyncAddPrintProcessor(
    [in] handle_t hRemoteBinding,
    [in, string, unique] wchar_t* pName,
    [in, string] wchar_t* pEnvironment,
    [in, string] wchar_t* pPathName,
    [in, string] wchar_t* pPrintProcessorName
);

DWORD
RpcAsyncEnumPrintProcessors(
    [in] handle_t hRemoteBinding,
    [in, string, unique] wchar_t* pName,
    [in, unique, string] wchar_t* pEnvironment,
    [in] DWORD Level,
    [in, out, unique, size_is(cbBuf)] unsigned char*
        pPrintProcessorInfo,
    [in] DWORD cbBuf,
    [out] DWORD* pcbNeeded,
    [out] DWORD* pcReturned
);

DWORD
RpcAsyncGetPrintProcessorDirectory(
    [in] handle_t hRemoteBinding,
    [in, string, unique] wchar_t* pName,
    [in, unique, string] wchar_t* pEnvironment,

```

```

    [in] DWORD Level,
    [in, out, unique, size_is(cbBuf)] unsigned char*
        pPrintProcessorDirectory,
    [in] DWORD cbBuf,
    [out] DWORD* pcbNeeded
);

DWORD
RpcAsyncEnumPorts(
    [in] handle_t hRemoteBinding,
    [in, string, unique] wchar_t* pName,
    [in] DWORD Level,
    [in, out, unique, size_is(cbBuf)] unsigned char* pPort,
    [in] DWORD cbBuf,
    [out] DWORD* pcbNeeded,
    [out] DWORD* pcReturned
);

DWORD
RpcAsyncEnumMonitors(
    [in] handle_t hRemoteBinding,
    [in, string, unique] wchar_t* pName,
    [in] DWORD Level,
    [in, out, unique, size_is(cbBuf)] unsigned char* pMonitor,
    [in] DWORD cbBuf,
    [out] DWORD* pcbNeeded,
    [out] DWORD* pcReturned
);

DWORD
RpcAsyncAddPort(
    [in] handle_t hRemoteBinding,
    [in, string, unique] wchar_t* pName,
    [in] PORT_CONTAINER* pPortContainer,
    [in] PORT_VAR_CONTAINER* pPortVarContainer,
    [in, string] wchar_t* pMonitorName
);

DWORD
RpcAsyncSetPort(
    [in] handle_t hRemoteBinding,
    [in, string, unique] wchar_t* pName,
    [in, string, unique] wchar_t* pPortName,
    [in] PORT_CONTAINER* pPortContainer
);

DWORD
RpcAsyncAddMonitor(
    [in] handle_t hRemoteBinding,
    [in, string, unique] wchar_t* Name,
    [in] MONITOR_CONTAINER* pMonitorContainer
);

DWORD
RpcAsyncDeleteMonitor(
    [in] handle_t hRemoteBinding,
    [in, string, unique] wchar_t* Name,
    [in, unique, string] wchar_t* pEnvironment,
    [in, string] wchar_t* pMonitorName
);

```

```

);

DWORD
RpcAsyncDeletePrintProcessor(
    [in] handle_t hRemoteBinding,
    [in, string, unique] wchar_t* Name,
    [in, unique, string] wchar_t* pEnvironment,
    [in, string] wchar_t*pPrintProcessorName
);

DWORD
RpcAsyncEnumPrintProcessorDatatypes(
    [in] handle_t hRemoteBinding,
    [in, string, unique] wchar_t* pName,
    [in, unique, string] wchar_t* pPrintProcessorName,
    [in] DWORD Level,
    [in, out, unique, size_is(cbBuf)] unsigned char* pDatatypes,
    [in] DWORD cbBuf,
    [out] DWORD* pcbNeeded,
    [out] DWORD* pcReturned
);

DWORD
RpcAsyncAddPerMachineConnection(
    [in] handle_t hRemoteBinding,
    [in, string, unique] wchar_t* pServer,
    [in, string] const wchar_t* pPrinterName,
    [in, string] const wchar_t* pPrintServer,
    [in, string] const wchar_t* pProvider
);

DWORD
RpcAsyncDeletePerMachineConnection(
    [in] handle_t hRemoteBinding,
    [in, string, unique] wchar_t* pServer,
    [in, string] const wchar_t* pPrinterName
);

DWORD
RpcAsyncEnumPerMachineConnections(
    [in] handle_t hRemoteBinding,
    [in, string, unique] wchar_t* pServer,
    [in, out, unique, size_is(cbBuf)] unsigned char* pPrinterEnum,
    [in] DWORD cbBuf,
    [out] DWORD* pcbNeeded,
    [out] DWORD* pcReturned
);

HRESULT
RpcSyncRegisterForRemoteNotifications(
    [in] PRINTER_HANDLE hPrinter,
    [in] RpcPrintPropertiesCollection* pNotifyFilter,
    [out] RMTNTFY_HANDLE* phRpcHandle
);

HRESULT
RpcSyncUnRegisterForRemoteNotifications(
    [in, out] RMTNTFY_HANDLE* phRpcHandle
);

```

```

HRESULT
RpcSyncRefreshRemoteNotifications(
    [in]      RMTNTFY_HANDLE          hRpcHandle,
    [in]      RpcPrintPropertiesCollection* pNotifyFilter,
    [out]     RpcPrintPropertiesCollection** ppNotifyData
);

HRESULT
RpcAsyncGetRemoteNotifications(
    [in]      RMTNTFY_HANDLE          hRpcHandle,
    [out]     RpcPrintPropertiesCollection** ppNotifyData
);

HRESULT
RpcAsyncInstallPrinterDriverFromPackage(
    [in]      handle_t                hRemoteBinding,
    [in, string, unique] const wchar_t* pszServer,
    [in, string, unique] const wchar_t* pszInfPath,
    [in, string]         const wchar_t* pszDriverName,
    [in, string]         const wchar_t* pszEnvironment,
    [in]              DWORD           dwFlags
);

HRESULT
RpcAsyncUploadPrinterDriverPackage(
    [in]      handle_t                hRemoteBinding,
    [in, string, unique] const wchar_t* pszServer,
    [in, string]         const wchar_t* pszInfPath,
    [in, string]         const wchar_t* pszEnvironment,
    [in]              DWORD           dwFlags,
    [in, out, unique, size_is(*pcchDestInfPath)]
    wchar_t* pszDestInfPath,
    [in, out]          DWORD* pcchDestInfPath
);

HRESULT
RpcAsyncGetCorePrinterDrivers(
    [in]      handle_t                hRemoteBinding,
    [in, string, unique] const wchar_t* pszServer,
    [in, string]         const wchar_t* pszEnvironment,
    [in]              DWORD           cchCoreDrivers,
    [in, size_is(cchCoreDrivers)]
    const wchar_t* pszCoreDriverDependencies,
    [in]              DWORD           cCorePrinterDrivers,
    [out, size_is(cCorePrinterDrivers)]
    CORE_PRINTER_DRIVER* pCorePrinterDrivers
);

HRESULT
RpcAsyncCorePrinterDriverInstalled(
    [in]      handle_t                hRemoteBinding,
    [in, string, unique] const wchar_t* pszServer,
    [in, string]         const wchar_t* pszEnvironment,
    [in]              GUID           CoreDriverGUID,
    [in]              FILETIME       ftDriverDate,
    [in]              DWORDLONG      dwlDriverVersion,
    [out]          int*pbDriverInstalled
);

```



```

HRESULT
RpcAsyncGetPrinterDriverPackagePath(
    [in] handle_t hRemoteBinding,
    [in, string, unique] const wchar_t* pszServer,
    [in, string] const wchar_t* pszEnvironment,
    [in, string, unique] const wchar_t* pszLanguage,
    [in, string] const wchar_t* pszPackageID,
    [in, out, unique, size_is(cchDriverPackageCab)]
        wchar_t* pszDriverPackageCab,
    [in] DWORD cchDriverPackageCab,
    [out] DWORD* pcchRequiredSize
);

HRESULT
RpcAsyncDeletePrinterDriverPackage(
    [in] handle_t hRemoteBinding,
    [in, string, unique] const wchar_t* pszServer,
    [in, string] const wchar_t* pszInfPath,
    [in, string] const wchar_t* pszEnvironment
);

DWORD
RpcAsyncReadPrinter(
    [in] PRINTER_HANDLE hPrinter,
    [out, size_is(cbBuf)] unsigned char* pBuf,
    [in] DWORD cbBuf,
    [out] DWORD* pcNoBytesRead
);

DWORD
RpcAsyncResetPrinter(
    [in] PRINTER_HANDLE hPrinter,
    [in, string, unique] wchar_t* pDatatype,
    [in] DEVMODE_CONTAINER* pDevModeContainer
);
}

DWORD
RpcAsyncGetJobNamedPropertyValue(
    [in] PRINTER_HANDLE hPrinter,
    [in] DWORD JobId,
    [in, string] const wchar_t *pszName,
    [out] RPC_PrintPropertyValue *pValue
);

DWORD
RpcAsyncSetJobNamedProperty(
    [in] PRINTER_HANDLE hPrinter,
    [in] DWORD JobId,
    [in] RPC_PrintNamedProperty *pProperty
);

DWORD
RpcAsyncDeleteJobNamedProperty(
    [in] PRINTER_HANDLE hPrinter,
    [in] DWORD JobId,
    [in, string] const wchar_t *pszName
);

```

```
DWORD
RpcAsyncEnumJobNamedProperties(
    [in]          PRINTER_HANDLE      hPrinter,
    [in]          DWORD                JobId,
    [out]         DWORD                *pcProperties,
    [out, size_is(*pcProperties)] RPC_PrintNamedProperty **ppProperties
);
```

```
DWORD
RpcAsyncLogJobInfoForBranchOffice(
    [in]          PRINTER_HANDLE      hPrinter,
    [in, ref] RPC_BranchOfficeJobDataContainer *pBranchOfficeJobDataContainer
);
```

7 Appendix B: Product Behavior

The information in this specification is applicable to the following Microsoft products or supplemental software. References to product versions include released service packs:

- Windows Vista operating system
- Windows Server 2008 operating system
- Windows 7 operating system
- Windows Server 2008 R2 operating system
- Windows 8 operating system
- Windows Server 2012 operating system
- Windows 8.1 operating system
- Windows Server 2012 R2 operating system

Exceptions, if any, are noted below. If a service pack or Quick Fix Engineering (QFE) number appears with the product version, behavior changed in that service pack or QFE. The new behavior also applies to subsequent service packs of the product unless otherwise specified. If a product edition appears with the product version, behavior is different in that product edition.

Unless otherwise specified, any statement of optional behavior in this specification that is prescribed using the terms SHOULD or SHOULD NOT implies product behavior in accordance with the SHOULD or SHOULD NOT prescription. Unless otherwise specified, the term MAY implies that the product does not follow the prescription.

[<1> Section 1.3.2:](#) All Windows versions: Windows uses various spool file formats, such as **enhanced metafile spool format (EMFSPPOOL)** or **RAW format**. On Windows Vista, Windows 7, Windows 8, and Windows 8.1, the XML Paper Specification format can also be used. The XML Paper Specification format can also be used on Windows XP and Windows Server 2003 with the optional Essentials Pack (see [\[MSFT-XMLSpecPaperEssPk\]](#)). For more information about these formats, see [\[MS-EMFSPPOOL\]](#), [\[MSDN-SPOOL\]](#), and [\[MSDN-XMLP\]](#), respectively.

[<2> Section 1.8:](#) All Windows versions: Windows implementations of this protocol use only the values that are specified in [\[MS-ERREF\]](#) section 2.3.

[<3> Section 2.1:](#) For information concerning Windows authentication-service constants, see [\[MSDN-AUTHN\]](#).

[<4> Section 2.1:](#) Windows Vista, Windows Server 2008, Windows 7, Windows Server 2008 R2, Windows 8, Windows Server 2012, Windows 8.1, and Windows Server 2012 R2 print servers impersonate clients when processing methods, and they register SPNEGO [\[MS-SPNG\]](#) security providers.

[<5> Section 2.2.8:](#) For Windows implementations, the driver version is matched to the version portion of the **INF file** DriverVer member. For information about INF file syntax, see [\[MSDN-UINF\]](#).

[<6> Section 3.1.1:](#) **Job Named Properties** are supported by the following Windows versions:

- Windows 8
- Windows Server 2012

- Windows 8.1
- Windows Server 2012 R2

<7> [Section 3.1.1:](#) **Branch Office Print Remote Log Entries** are supported by the following Windows versions:

- Windows 8.1
- Windows Server 2012 R2

<8> [Section 3.1.4:](#) The job named property management methods are supported on the following Windows versions:

- Windows 8
- Windows Server 2012
- Windows 8.1
- Windows Server 2012 R2

<9> [Section 3.1.4:](#) Branch office print remote logging methods are supported on the following Windows versions:

- Windows 8.1
- Windows Server 2012 R2

<10> [Section 3.1.4.2.7:](#) All Windows versions: **pszInfPath** points to an INF file. For more information on INF file structure, see [\[MSDN-UINF\]](#).

<11> [Section 3.1.4.2.7:](#) These validation steps are performed on the following Windows versions:

- Windows 8
- Windows Server 2012
- Windows 8.1
- Windows Server 2012 R2

<12> [Section 3.1.4.2.7:](#) Windows print servers attempt to locate driver packages containing class printer drivers using the Windows Update protocol described in [\[MS-WUSP\]](#).

<13> [Section 3.1.4.2.7:](#) These validation steps are performed on the following Windows versions:

- Windows 8
- Windows Server 2012
- Windows 8.1
- Windows Server 2012 R2

<14> [Section 3.1.4.2.7:](#) These validation steps are performed on the following Windows versions:

- Windows 8

- Windows Server 2012
- Windows 8.1
- Windows Server 2012 R2

<15> [Section 3.1.4.2.7](#): When a print client installs a printer driver to a print server using Windows **RpcAsyncInstallPrinterDriverFromPackage (section 3.1.4.2.7)**, the print server determines how to set the Boolean values representing each of the printer driver's attributes based on data that the print server reads from the printer driver manifest (if present) and the driver installation control file.

<16> [Section 3.1.4.2.7](#): Windows print servers attempt to locate driver packages containing class printer drivers using the Windows Update protocol described in [\[MS-WUSP\]](#).

<17> [Section 3.1.4.2.7](#): Class printer drivers and derived printer drivers are supported on the following Windows versions:

- Windows 8
- Windows Server 2012
- Windows 8.1
- Windows Server 2012 R2

<18> [Section 3.1.4.2.8](#): All Windows versions: *pszInfPath* points to an INF file. For more information on INF file structure, see [\[MSDN-UINF\]](#).

<19> [Section 3.1.4.2.8](#): Windows servers impersonate the client when processing this call, but the impersonation token does not have delegation permission and therefore cannot be used to access files not located on the server itself. Therefore, Windows clients create a unique directory under the server's "print\$" share and copy the driver files to that directory before invoking this method. The server will copy the files from there to the final location in the driver store.

<20> [Section 3.1.4.2.8](#): All Windows versions: Printer drivers are described by INF files. For more information, see [\[MSDN-UINF\]](#).

<21> [Section 3.1.4.2.9](#): All Windows versions: The IDs are the **GUIDString** representations of 128-bit GUIDs.

<22> [Section 3.1.4.2.10](#): All Windows versions: The driver date is matched to the date portion of the INF DriverVer member. For information on INF file syntax, see [\[MSDN-UINF\]](#).

<23> [Section 3.1.4.2.10](#): All Windows versions: The driver version is matched to the version portion of the INF DriverVer member. For information on INF file syntax, see [\[MSDN-UINF\]](#).

<24> [Section 3.1.4.2.11](#): All Windows versions: The Language string is specified using the identifiers specified for the "Locale Name" in [\[MSDN-MUI\]](#).

<25> [Section 3.1.4.2.11](#): All Windows versions: **pszDriverPackageCab** points to a string containing the path name of a **cabinet file** for the driver package; for more information, see [\[MSDN-CAB\]](#).

<26> [Section 3.1.4.2.11](#): All Windows versions: If the parameter is zero, Windows fills in the variable pointed to by **pchRequiredSize** with the valid size.

<27> [Section 3.1.4.2.12](#): In Windows implementations, **pszInfPath** points to a string containing the path of an INF file. For more information on INF file structure, see [\[MSDN-UINF\]](#).

<28> [Section 3.1.4.2.12](#): Windows verifies that the specified driver package is not a printer driver package that ships with Windows. If this validation fails, the server returns `ERROR_ACCESS_DENIED`, meaning that deletion of printer driver packages that ship with Windows is not allowed

<29> [Section 3.1.4.9.1](#): In Windows, the server verifies that printer object handles have been opened with an access level that includes **PRINTER_ACCESS_USE** ([\[MS-RPRN\]](#) section 2.2.3.1). No such authorization check is performed on server object handles.

<30> [Section 3.1.4.10.1](#): The **RpcAsyncGetJobNamedPropertyValue** method is supported by the following Windows versions:

- Windows 8
- Windows Server 2012
- Windows 8.1
- Windows Server 2012 R2

<31> [Section 3.1.4.10.2](#): The **RpcAsyncSetJobNamedProperty** method is supported by the following Windows versions:

- Windows 8
- Windows Server 2012
- Windows 8.1
- Windows Server 2012 R2

<32> [Section 3.1.4.10.3](#): The **RpcAsyncDeleteJobNamedProperty** method is supported by the following Windows versions:

- Windows 8
- Windows Server 2012
- Windows 8.1
- Windows Server 2012 R2

<33> [Section 3.1.4.10.4](#): The **RpcAsyncEnumJobNamedProperties** method is supported by the following Windows versions:

- Windows 8
- Windows Server 2012
- Windows 8.1
- Windows Server 2012 R2

<34> [Section 3.1.4.11.1](#): The **RpcAsyncLogJobInfoForBranchOffice (section 3.1.4.11.1)** method is supported on the following Windows versions:

- Windows 8.1
- Windows Server 2012 R2

<35> [Section 3.2.3](#): All Windows client implementations derive the RPC binding directly from the respective server name or printer name parameter.

No Windows server implementations support RPC binding handles that are not derived from the respective server name or printer name parameter, and the behavior resulting from receiving such an RPC binding handle is undefined.

<36> [Section 3.2.3](#): In the Windows implementation, the client creates the binding handle, verifies the security capability of the remote server, and invokes the Print System Asynchronous Remote method.

To verify the security capability of the server, the client invokes the **rpc_mgmt_inq_princ_name** method of the **Remote Management Interface** ([\[C706\]](#) appendix Q and [\[MS-RPCE\]](#) section 2.2.1.3.4) to retrieve the principal name "princ_name" for the SPNEGO authentication service. This invocation is done prior to every Print System Asynchronous Remote method call.

If this invocation succeeds, authentication with the remote peer is deemed possible, and the RPC runtime is configured to use the SPNEGO security provider with the **RPC_C_AUTHN_GSS_NEGOTIATE** and **RPC_C_AUTHN_LEVEL_PKT_PRIVACY** flags and the retrieved principal name for subsequent RPC method calls to the server.

Because this protocol is only supported on Windows Vista, Windows Server 2008, Windows 7, Windows Server 2008 R2, Windows 8, Windows Server 2012, Windows 8.1, and Windows Server 2012 R2 print servers, Windows Vista, Windows 7, Windows 8, and Windows 8.1 print clients first attempt to connect using this protocol. If the connection fails, clients revert to using the Print System Remote Protocol as specified in [\[MS-RPRN\]](#).

<37> [Section 3.2.4](#): All Windows versions: Clients ignore errors and pass them back to the invoker.

<38> [Section 5.2](#): All Windows versions: The Windows print server follows a security model where the print server, print queue, and print job are securable resources. Each of the previously mentioned resources has an associated **SECURITY_DESCRIPTOR** structure ([\[MS-DTYP\]](#) section 2.4.6), which contains the security information that is associated with a resource on the print server. The print server checks the RPC client's access to resources by comparing the security information that is associated with the caller against the security information that is represented by the resource's **security descriptor**.

Each RPC client has an associated access token containing the **security identifier** of the user making the RPC call. The security descriptor identifies the printing resource's owner and contains a **discretionary access control list (DACL)**. The DACL contains **access control entries (ACEs)** that specify the security identifier (SID) that identifies a user or a group of users and the access rights allowed, denied, or audited. For resources on a print server, the ACEs specify operations such as print, manage printers, and manage documents in a print queue.

The security descriptor that is associated with the print server or print queue controls the creation of the context handle that represents a **PRINTER_HANDLE** structure ([\[MS-RPRN\]](#) section 2.2.1.1.4). It also controls the outcome of operations that use the **PRINTER_HANDLE**, from printing management to listening for notifications.

The security descriptor of a Windows print server is used to control the creation and deletion of print queues on the server and the installation of print system components, such as the printer driver, print processors, port monitors, or resources on the print server. The Windows print server security descriptor is not accessible to be modified by callers. In addition to being used to control the caller's

access to resources, the Windows print server security descriptor is also used as "parent" in the creation of the print queue's security descriptor.

Note: The security descriptor of a Windows print server is different from the security descriptor that is applied on the **spoolss named pipe**. The **spoolss** named pipe security descriptor controls the RPC client's access to make RPC calls to the print server. The Windows print server security descriptor is used to control the caller's permissions to perform various operations on the print server.

The print queue's security descriptor controls the setting of properties for the print queue, such as the port and driver that are used for printing, device settings, sharing, and security. The user is allowed to manage, print, and so on. The printer security descriptor allows auditing operations, such as print, manage printers and documents, read and change permissions, and take ownership.

Each print job has an associated security descriptor, which is created by using the print queue's security descriptor as parent. The user who submitted the document for printing is the owner for the print job and has permissions to manage the print job during its lifetime.

When the caller opens a **PRINTER_HANDLE** structure for a specific printing resource, it specifies the access that is needed for the operations for which the handle is being opened, such as "administrate printer or server"; "use printer or print server for printing"; or "read, write, or administrate job". If the caller has the requested permissions, the print handle is created and can be used in subsequent calls.

Besides handle-based operations, the security descriptor is used for access checks when enumerations, driver package installation, or other non-handle-based operations are performed. The access checks are primarily about testing whether the initiator of the operation has enough use or administer privileges on the resource that is being targeted by that operation. For example, an access check might be whether the initiator of the operation has the privilege to pause a printer.

8 Change Tracking

No table of changes is available. The document is either new or has had no changes since its last release.

9 Index

A

Abstract data model
 [client](#) 94
 [server](#) 26
[Adding printer driver to server example](#) 97
[Adding printer to server example](#) 96
[Applicability](#) 17

C

[Capability negotiation](#) 17
[Change notification](#) 14
[Change tracking](#) 137
Client
 [abstract data model](#) 94
 [initialization](#) 94
 [local events](#) 95
 [message processing](#) 94
 [sequencing rules](#) 94
 [timer events](#) 95
 [timers](#) 94
[Communicating print job data](#) 13
[CORE_PRINTER_DRIVER structure](#) 24

D

Data model - abstract
 [client](#) 94
 [server](#) 26
[Data types](#) 19

E

[Enumerating and managing printers example](#) 97
[Enumerating jobs and modifying job settings example](#) 98
[EPrintPropertyType enumeration](#) 20
Examples
 [adding printer driver to server](#) 97
 [adding printer to server](#) 96
 [enumerating and managing printers](#) 97
 [enumerating jobs and modifying job settings](#) 98
 [overview](#) 96
 [receiving notifications from server](#) 99

F

[Fields - vendor-extensible](#) 17
[Form management methods](#) 75
[Full IDL](#) 104

G

[Glossary](#) 8

I

[IDL](#) 104

[Implementer - security considerations](#) 103
[Index of security parameters](#) 103
[Informative references](#) 11
Initialization
 [client](#) 94
 [server](#) 27
[Introduction](#) 8

J

[Job management methods](#) 78
[Job named property management methods](#) 90
[Job printing methods](#) 81

L

Local events
 [client](#) 95
 [server](#) 93

M

[Managing print system](#) 12
Message processing
 [client](#) 94
 [server](#) 27
Messages
 [data types](#) 19
 [transport](#) 19

N

[Normative references](#) 10
[NOTIFY_OPTIONS_CONTAINER structure](#) 24
[NOTIFY_REPLY_CONTAINER structure](#) 24

O

[Overview \(synopsis\)](#) 12

P

[Parameter index - security](#) 103
[Port-monitor management methods](#) 73
[Preconditions](#) 16
[Prerequisites](#) 16
[Print job data](#) 13
[Print server change notification](#) 14
[Print system - managing](#) 12
[Printer management methods](#) 35
[Printer-driver management methods](#) 52
[Printer-port management methods](#) 67
[Printing-related notification methods](#) 85
[Print-processor management methods](#) 69
[Product behavior](#) 131

R

[Receiving notifications from server example](#) 99

References

- [informative](#) 11
- [normative](#) 10
- [Relationship to other protocols](#) 16
- [RpcAsyncAbortPrinter method](#) 84
- [RpcAsyncAddForm method](#) 75
- [RpcAsyncAddJob method](#) 80
- [RpcAsyncAddMonitor method](#) 74
- [RpcAsyncAddPerMachineConnection method](#) 50
- [RpcAsyncAddPort method](#) 68
- [RpcAsyncAddPrinter method](#) 39
- [RpcAsyncAddPrinterDriver method](#) 54
- [RpcAsyncAddPrintProcessor method](#) 70
- [RpcAsyncClosePrinter method](#) 43
- [RpcAsyncCorePrinterDriverInstalled method](#) 63
- [RpcAsyncCreatePrinterIC method](#) 48
- [RpcAsyncDeleteForm method](#) 76
- [RpcAsyncDeleteJobNamedProperty method](#) 91
- [RpcAsyncDeleteMonitor method](#) 74
- [RpcAsyncDeletePerMachineConnection method](#) 50
- [RpcAsyncDeletePrinter method](#) 40
- [RpcAsyncDeletePrinterData method](#) 46
- [RpcAsyncDeletePrinterDataEx method](#) 46
- [RpcAsyncDeletePrinterDriver method](#) 56
- [RpcAsyncDeletePrinterDriverEx method](#) 56
- [RpcAsyncDeletePrinterDriverPackage method](#) 65
- [RpcAsyncDeletePrinterIC method](#) 49
- [RpcAsyncDeletePrinterKey method](#) 47
- [RpcAsyncDeletePrintProcessor method](#) 72
- [RpcAsyncEndDocPrinter method](#) 84
- [RpcAsyncEndPagePrinter method](#) 83
- [RpcAsyncEnumForms method](#) 77
- [RpcAsyncEnumJobNamedProperties method](#) 92
- [RpcAsyncEnumJobs method](#) 80
- [RpcAsyncEnumMonitors method](#) 73
- [RpcAsyncEnumPerMachineConnections method](#) 51
- [RpcAsyncEnumPorts method](#) 68
- [RpcAsyncEnumPrinterData method](#) 44
- [RpcAsyncEnumPrinterDataEx method](#) 45
- [RpcAsyncEnumPrinterDrivers method](#) 54
- [RpcAsyncEnumPrinterKey method](#) 45
- [RpcAsyncEnumPrinters method](#) 49
- [RpcAsyncEnumPrintProcessorDatatypes method](#) 72
- [RpcAsyncEnumPrintProcessors method](#) 71
- [RpcAsyncGetCorePrinterDrivers method](#) 61
- [RpcAsyncGetForm method](#) 76
- [RpcAsyncGetJob method](#) 79
- [RpcAsyncGetJobNamedPropertyValue method](#) 90
- [RpcAsyncGetPrinter method](#) 41
- [RpcAsyncGetPrinterData method](#) 41
- [RpcAsyncGetPrinterDataEx method](#) 42
- [RpcAsyncGetPrinterDriver method](#) 53
- [RpcAsyncGetPrinterDriverDirectory method](#) 55
- [RpcAsyncGetPrinterDriverPackagePath method](#) 64
- [RpcAsyncGetPrintProcessorDirectory method](#) 71
- [RpcAsyncGetRemoteNotifications method](#) 89
- [RpcAsyncInstallPrinterDriverFromPackage method](#) 57
- [RpcAsyncLogJobInfoForBranchOffice method](#) 93
- [RpcAsyncOpenPrinter method](#) 39
- [RpcAsyncPlayGdiScriptOnPrinterIC method](#) 48
- [RpcAsyncReadPrinter method](#) 85
- [RpcAsyncResetPrinter method](#) 51
- [RpcAsyncScheduleJob method](#) 81
- [RpcAsyncSendRecvBidiData method](#) 47
- [RpcAsyncSetForm method](#) 77
- [RpcAsyncSetJob method](#) 79
- [RpcAsyncSetJobNamedProperty method](#) 91
- [RpcAsyncSetPort method](#) 69
- [RpcAsyncSetPrinter method](#) 40
- [RpcAsyncSetPrinterData method](#) 42
- [RpcAsyncSetPrinterDataEx method](#) 43
- [RpcAsyncStartDocPrinter method](#) 82
- [RpcAsyncStartPagePrinter method](#) 82
- [RpcAsyncUploadPrinterDriverPackage method](#) 59
- [RpcAsyncWritePrinter method](#) 83
- [RpcAsyncXcvData method](#) 67
- [RpcPrintNamedProperty structure](#) 22
- [RpcPrintPropertiesCollection structure](#) 23
- [RpcPrintPropertyValue structure](#) 21
- [RpcSyncRefreshRemoteNotifications method](#) 88
- [RpcSyncRegisterForRemoteNotifications method](#) 86
- [RpcSyncUnRegisterForRemoteNotifications method](#) 87

S

Security

- [implementer considerations](#) 103
- [parameter index](#) 103

Sequencing rules

- [client](#) 94
- [server](#) 27

Server

- [abstract data model](#) 26
- [initialization](#) 27
- [local events](#) 93
- [message processing](#) 27
- [overview](#) 26
- [sequencing rules](#) 27
- [timer events](#) 93
- [timers](#) 27

Standards assignments

T

Timer events

- [client](#) 95
- [server](#) 93

Timers

- [client](#) 94
- [server](#) 27
- [Tracking changes](#) 137
- [Transport](#) 19

V

Vendor-extensible fields

- [Versioning](#) 17