

# [MS-NRLS]: .NET Remoting: Lifetime Services Extension

---

## Intellectual Property Rights Notice for Open Specifications Documentation

- **Technical Documentation.** Microsoft publishes Open Specifications documentation for protocols, file formats, languages, standards as well as overviews of the interaction among each of these technologies.
- **Copyrights.** This documentation is covered by Microsoft copyrights. Regardless of any other terms that are contained in the terms of use for the Microsoft website that hosts this documentation, you may make copies of it in order to develop implementations of the technologies described in the Open Specifications and may distribute portions of it in your implementations using these technologies or your documentation as necessary to properly document the implementation. You may also distribute in your implementation, with or without modification, any schema, IDL's, or code samples that are included in the documentation. This permission also applies to any documents that are referenced in the Open Specifications.
- **No Trade Secrets.** Microsoft does not claim any trade secret rights in this documentation.
- **Patents.** Microsoft has patents that may cover your implementations of the technologies described in the Open Specifications. Neither this notice nor Microsoft's delivery of the documentation grants any licenses under those or any other Microsoft patents. However, a given Open Specification may be covered by Microsoft [Open Specification Promise](#) or the [Community Promise](#). If you would prefer a written license, or if the technologies described in the Open Specifications are not covered by the Open Specifications Promise or Community Promise, as applicable, patent licenses are available by contacting [iplg@microsoft.com](mailto:iplg@microsoft.com).
- **Trademarks.** The names of companies and products contained in this documentation may be covered by trademarks or similar intellectual property rights. This notice does not grant any licenses under those rights. For a list of Microsoft trademarks, visit [www.microsoft.com/trademarks](http://www.microsoft.com/trademarks).
- **Fictitious Names.** The example companies, organizations, products, domain names, email addresses, logos, people, places, and events depicted in this documentation are fictitious. No association with any real company, organization, product, domain name, email address, logo, person, place, or event is intended or should be inferred.

**Reservation of Rights.** All other rights are reserved, and this notice does not grant any rights other than specifically described above, whether by implication, estoppel, or otherwise.

**Tools.** The Open Specifications do not require the use of Microsoft programming tools or programming environments in order for you to develop an implementation. If you have access to Microsoft programming tools and environments you are free to take advantage of them. Certain Open Specifications are intended for use in conjunction with publicly available standard specifications and network programming art, and assumes that the reader either is familiar with the aforementioned material or has immediate access to it.

## Revision Summary

Date	Revision History	Revision Class	Comments
07/20/2007	0.1	Major	MCPP Milestone 5 Initial Availability
09/28/2007	1.0	Major	Updated and revised the technical content.
10/23/2007	1.0.1	Editorial	Revised and edited the technical content.
11/30/2007	1.0.2	Editorial	Revised and edited the technical content.
01/25/2008	1.1	Minor	Updated the technical content.
03/14/2008	1.1.1	Editorial	Revised and edited the technical content.
05/16/2008	1.1.2	Editorial	Revised and edited the technical content.
06/20/2008	2.0	Major	Updated and revised the technical content.
07/25/2008	3.0	Major	Updated and revised the technical content.
08/29/2008	3.1	Minor	Updated the technical content.
10/24/2008	4.0	Major	Updated and revised the technical content.
12/05/2008	4.1	Minor	Updated the technical content.
01/16/2009	5.0	Major	Updated and revised the technical content.
02/27/2009	6.0	Major	Updated and revised the technical content.
04/10/2009	6.1	Minor	Updated the technical content.
05/22/2009	6.1.1	Editorial	Revised and edited the technical content.
07/02/2009	6.1.2	Editorial	Revised and edited the technical content.
08/14/2009	6.1.3	Editorial	Revised and edited the technical content.
09/25/2009	6.2	Minor	Updated the technical content.
11/06/2009	6.2.1	Editorial	Revised and edited the technical content.
12/18/2009	6.2.2	Editorial	Revised and edited the technical content.
01/29/2010	6.3	Minor	Updated the technical content.
03/12/2010	6.3.1	Editorial	Revised and edited the technical content.
04/23/2010	6.3.2	Editorial	Revised and edited the technical content.
06/04/2010	7.0	Major	Updated and revised the technical content.
07/16/2010	8.0	Major	Significantly changed the technical content.

<b>Date</b>	<b>Revision History</b>	<b>Revision Class</b>	<b>Comments</b>
08/27/2010	8.0	No change	No changes to the meaning, language, or formatting of the technical content.
10/08/2010	8.0	No change	No changes to the meaning, language, or formatting of the technical content.
11/19/2010	8.0	No change	No changes to the meaning, language, or formatting of the technical content.
01/07/2011	8.0	No change	No changes to the meaning, language, or formatting of the technical content.
02/11/2011	8.0	No change	No changes to the meaning, language, or formatting of the technical content.
03/25/2011	8.0	No change	No changes to the meaning, language, or formatting of the technical content.
05/06/2011	8.0	No change	No changes to the meaning, language, or formatting of the technical content.
06/17/2011	8.1	Minor	Clarified the meaning of the technical content.
09/23/2011	8.1	No change	No changes to the meaning, language, or formatting of the technical content.
12/16/2011	8.1	No change	No changes to the meaning, language, or formatting of the technical content.
03/30/2012	8.1	No change	No changes to the meaning, language, or formatting of the technical content.
07/12/2012	8.1	No change	No changes to the meaning, language, or formatting of the technical content.
10/25/2012	8.1	No change	No changes to the meaning, language, or formatting of the technical content.
01/31/2013	8.1	No change	No changes to the meaning, language, or formatting of the technical content.
08/08/2013	8.1	No change	No changes to the meaning, language, or formatting of the technical content.
11/14/2013	8.1	No change	No changes to the meaning, language, or formatting of the technical content.

# Contents

<b>1 Introduction</b>	<b>7</b>
1.1 Glossary	7
1.2 References	8
1.2.1 Normative References	8
1.2.2 Informative References	8
1.3 Overview	8
1.3.1 Client Activation	9
1.3.2 Lifetime Management	9
1.3.3 Sponsor	10
1.3.4 Notational Conventions	12
1.4 Relationship to Other Protocols	13
1.5 Prerequisites/Preconditions	13
1.6 Applicability Statement	13
1.7 Versioning and Capability Negotiation	13
1.8 Vendor-Extensible Fields	14
1.9 Standards Assignments	14
<b>2 Messages</b>	<b>15</b>
2.1 Transport	15
2.2 Common Data Types	15
2.2.1 ArrayList	15
2.2.2 ConstructionCall	15
2.2.3 ContextLevelActivator	16
2.2.4 ConstructionLevelActivator	17
2.2.5 ConstructionResponse	17
2.2.6 LeaseState	18
2.2.7 ArgumentException	18
2.2.8 ArgumentNullException	18
<b>3 Protocol Details</b>	<b>20</b>
3.1 IActivator	20
3.1.1 Abstract Data Model	20
3.1.2 Timers	21
3.1.3 Initialization	21
3.1.4 Message Processing Events and Sequencing Rules	21
3.1.4.1 Activate	21
3.1.5 Timer Events	22
3.1.6 Other Local Events	22
3.1.6.1 Register Activatable Server Type	22
3.2 MarshalByRefObject	22
3.2.1 Abstract Data Model	23
3.2.2 Timers	23
3.2.3 Initialization	23
3.2.4 Message Processing Events and Sequencing Rules	23
3.2.4.1 GetLifetimeService	23
3.2.5 Timer Events	23
3.2.6 Other Local Events	23
3.3 ILease	24
3.3.1 Abstract Data Model	24
3.3.2 Timers	24

3.3.3	Initialization .....	24
3.3.4	Message Processing Events and Sequencing Rules.....	24
3.3.4.1	Renew.....	26
3.3.4.2	Register .....	27
3.3.4.3	Register(Overload) .....	27
3.3.4.4	Unregister .....	28
3.3.4.5	get_InitialLeaseTime .....	28
3.3.4.6	set_InitialLeaseTime .....	28
3.3.4.7	get_RenewOnCallTime.....	29
3.3.4.8	set_RenewOnCallTime.....	29
3.3.4.9	get_SponsorshipTimeout .....	29
3.3.4.10	set_SponsorshipTimeout.....	30
3.3.4.11	get_CurrentLeaseTime.....	30
3.3.4.12	get_CurrentState.....	30
3.3.5	Timer Events .....	30
3.3.5.1	Lease TTL Timer .....	30
3.3.5.2	Sponsorship Timer.....	31
3.3.6	Other Local Events .....	31
3.3.6.1	Binding to Server Object.....	31
3.3.6.2	Marshal Server Object.....	32
3.3.6.3	Unmarshal Server Object.....	32
3.4	ISponsor .....	32
3.4.1	Abstract Data Model .....	32
3.4.2	Timers .....	32
3.4.3	Initialization .....	32
3.4.4	Message Processing Events and Sequencing Rules.....	32
3.4.4.1	Renewal .....	32
3.4.5	Timer Events .....	33
3.4.6	Other Local Events .....	33
3.5	Object.....	33
3.5.1	Abstract Data Model .....	33
3.5.2	Timers.....	33
3.5.3	Initialization .....	33
3.5.4	Message Processing Events and Sequencing Rules.....	33
3.5.4.1	FieldGetter.....	33
3.5.4.2	FieldSetter.....	34
3.5.5	Timer Events .....	34
3.5.6	Other Local Events .....	34
<b>4</b>	<b>Protocol Examples.....</b>	<b>35</b>
4.1	CAO Activation Request/Response Message. ....	35
4.1.1	Activation Request Message.....	35
4.1.2	Activation Response Message.....	39
4.2	Registering a Sponsor for a CAO Object.....	44
4.3	Incrementing TTL of a Server Object.....	45
<b>5</b>	<b>Security.....</b>	<b>47</b>
5.1	Security Considerations for Implementers.....	47
5.2	Index of Security Parameters .....	47
<b>6</b>	<b>Appendix A: Full Definitions .....</b>	<b>48</b>
<b>7</b>	<b>Appendix B: Product Behavior.....</b>	<b>50</b>

<b>8</b>	<b>Change Tracking</b> .....	<b>52</b>
<b>9</b>	<b>Index</b> .....	<b>53</b>

# 1 Introduction

This document specifies the .NET Remoting: Lifetime Services Extension protocol. This protocol adds lifetime and remote **activation** capabilities to the [.NET Remoting Protocol](#) (specified in [MS-NRTP]). This protocol builds on the [MS-NRTP] specification, and readers must be familiar with its terms and concepts.

Sections 1.8, 2, and 3 of this specification are normative and can contain the terms MAY, SHOULD, MUST, MUST NOT, and SHOULD NOT as defined in RFC 2119. Sections 1.5 and 1.9 are also normative but cannot contain those terms. All other sections and examples in this specification are informative.

## 1.1 Glossary

The following terms are defined in [\[MS-NRTP\]](#):

- Array**
- Class**
- Data Value**
- Exception**
- Library**
- Marshaled Server Object (MSO)**
- .NET Framework**
- Null Object**
- Primitive Type**
- Proxy**
- Remote Field**
- Remote Method**
- Remoting Type**
- Server-Activated Object (SAO)**
- Server Object**
- Server Object Reference**
- Server Object Table**
- Server Object URI**
- Server Type**
- Singleton SAO**
- System Library**

The following terms are specific to this document:

**activation:** The process of creating a **Server Object**.

**Client-Activated Object (CAO):** A **Marshaled Server Object (MSO)** that requires an explicit **activation** message to create the **Server Object**.

**Lease Object:** A Lease Object is a type of **MSO**. Every **Singleton SAO** and **MSO** has an associated Lease Object that contains methods that control the lifetime of the **Server Object**. It must be noted that although a Lease Object is an **MSO**, it does not have a Lease Object of its own. The lifetime of the Lease Object is bound by the lifetime of the associated **Server Object**.

**Sponsor:** An **MSO** that is implemented by clients to participate in the renewal process of a **Server Object's** lifetime.

**Time-To-Live (TTL):** The time duration for which a **Server Object** is available.

**MAY, SHOULD, MUST, SHOULD NOT, MUST NOT:** These terms (in all caps) are used as specified in [RFC2119](#). All statements of optional behavior use either MAY, SHOULD, or SHOULD NOT.

## 1.2 References

References to Microsoft Open Specifications documentation do not include a publishing year because links are to the latest version of the documents, which are updated frequently. References to other documents include a publishing year when one is available.

A reference marked "(Archived)" means that the reference document was either retired and is no longer being maintained or was replaced with a new document that provides current implementation details. We archive our documents online [\[Windows Protocol\]](#).

### 1.2.1 Normative References

We conduct frequent surveys of the normative references to assure their continued availability. If you have any issue with finding a normative reference, please contact [dochelp@microsoft.com](mailto:dochelp@microsoft.com). We will assist you in finding the relevant information. Please check the archive site, <http://msdn2.microsoft.com/en-us/library/E4BD6494-06AD-4aed-9823-445E921C9624>, as an additional source.

[MS-NRTP] Microsoft Corporation, "[.NET Remoting: Core Protocol](#)".

[RFC2119] Bradner, S., "Key words for use in RFCs to Indicate Requirement Levels", BCP 14, RFC 2119, March 1997, <http://www.rfc-editor.org/rfc/rfc2119.txt>

### 1.2.2 Informative References

[MS-GLOS] Microsoft Corporation, "[Windows Protocols Master Glossary](#)".

[MS-NRBF] Microsoft Corporation, "[.NET Remoting: Binary Format Data Structure](#)".

[MSDN-RemotingLifetime] Microsoft Corporation, "Managing the Lifetime of Remote .NET Objects with Leasing and Sponsorship", <http://msdn.microsoft.com/msdnmag/issues/03/12/LeaseManager/default.aspx>

## 1.3 Overview

The [.NET Remoting Protocol](#) (specified in [MS-NRTP]) defines mechanisms for the creation of **Server Objects** and the invocation of **Remote Methods** on those Server Objects.

This protocol extends the .NET Remoting Protocol to add a mechanism allowing clients to explicitly create Server Objects and adds another mechanism allowing clients and servers to control the lifetime of Server Objects. Additionally, this protocol is a .NET Remoting-based protocol, using the .NET Remoting Protocol as a transport.

Additional overview information for the .NET Remoting: Lifetime Services Extension is available in the following sections:

- Section [1.3.1](#) — Activating a server from a client
- Section [1.3.2](#) — Managing the connection lifetime between a client and a server



- Section [1.3.3](#) — Managing the **sponsors** (clients) associated with a server

Much of the basic information and terminology used in this document is also common to the .NET Remoting Protocol. For more information, see [\[MS-NRTP\]](#) section 2.2.5.

### 1.3.1 Client Activation

This protocol introduces a new type of Server Object called a **Client-Activated Object (CAO)**. A CAO can be remotely activated by a client by invoking the **Activate** Remote Method on a well-known **Server-Activated Object (SAO)**, passing the **Server Type**. The implementation of the SAO creates a new instance of the Server Type, registers it in the **Server Object Table**, and sends back to the client a **Server Object Reference** to the instance. The client receives the Server Object Reference and can use it to create a **Proxy** to invoke methods on the CAO.

An example of a client activating an instance and invoking a Remote Method, **increment()**, is shown in the following figure.

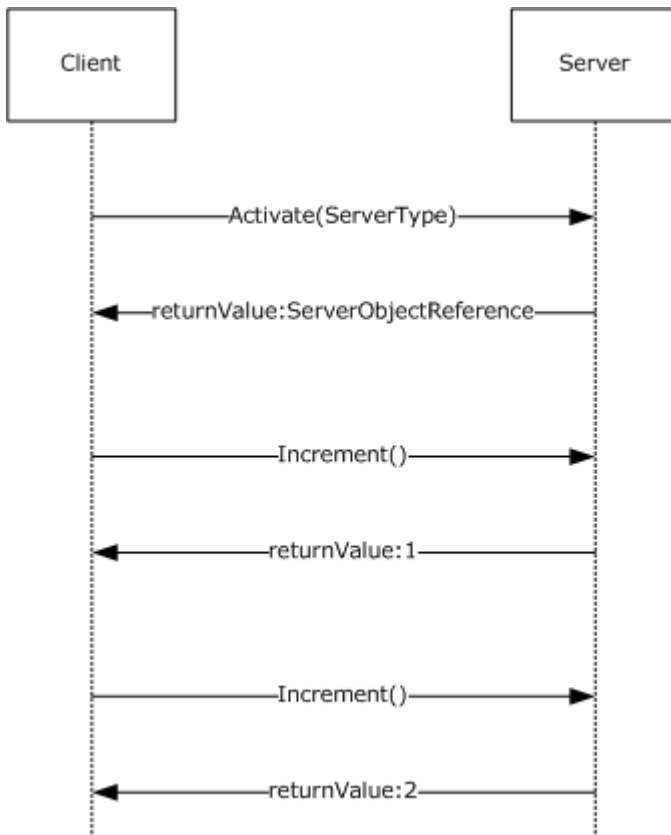

**Figure 1: Client activating a server object**

### 1.3.2 Lifetime Management

This protocol specifies a lease-based model for lifetime management of **Marshaled Server Objects (MSOs)** and the **Singleton SAO**.

A **Lease Object** is associated with each Server Object. Each Lease Object has an initial **Time-To-Live (TTL)** for the Server Object. For every Remote Method invocation on the Server Object, the

TTL is extended. If no calls are made to the Server Object for the duration of the TTL, the Server Object is considered for removal from the Server Object Table.

A client can explicitly control the Server Object's lifetime through Remote Method invocations on the Server Object's Lease Object. The client gets a Server Object Reference to the Lease Object for a Server Object by calling the Server Object's [GetLifetimeService](#) Remote Method. The client can then invoke the [Renew](#) Remote Method on the Lease Object to extend the TTL by a desired amount.

### 1.3.3 Sponsor

A Lease Object for a given Server Object maintains a list of Sponsors that are called when the TTL of the Server Object expires. Each Sponsor can specify whether the Server Object's TTL must be extended, and can specify the duration of the extension. If there are no associated Sponsors or if none of the associated Sponsors extend the lifetime of the Server Object, then the Server Object is removed from the Server Object Table, making it unavailable to clients.

An example of a client managing the lifetime of a Server Object is shown in the following examples.

The client invokes a Remote Method on the Server Object, as follows.

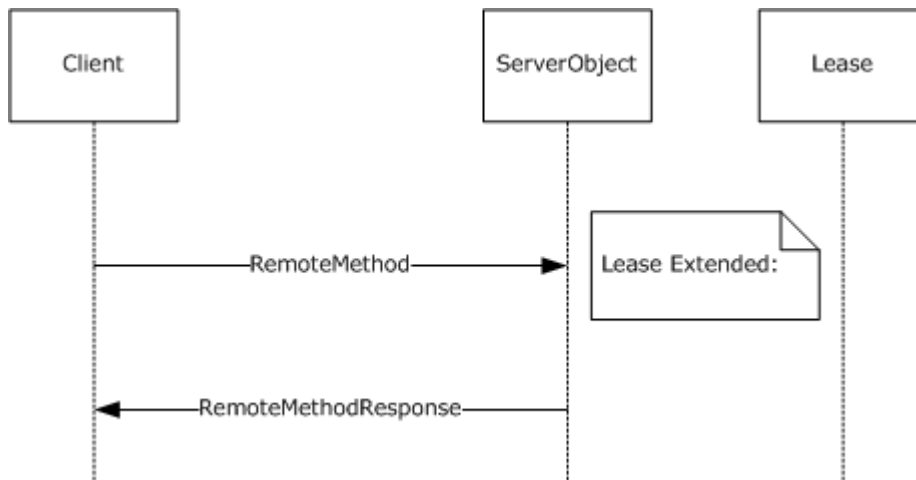

**Figure 2: Invoking a Remote Method on the Server Object**

The client uses the Lease Object to extend the lease time, as follows.

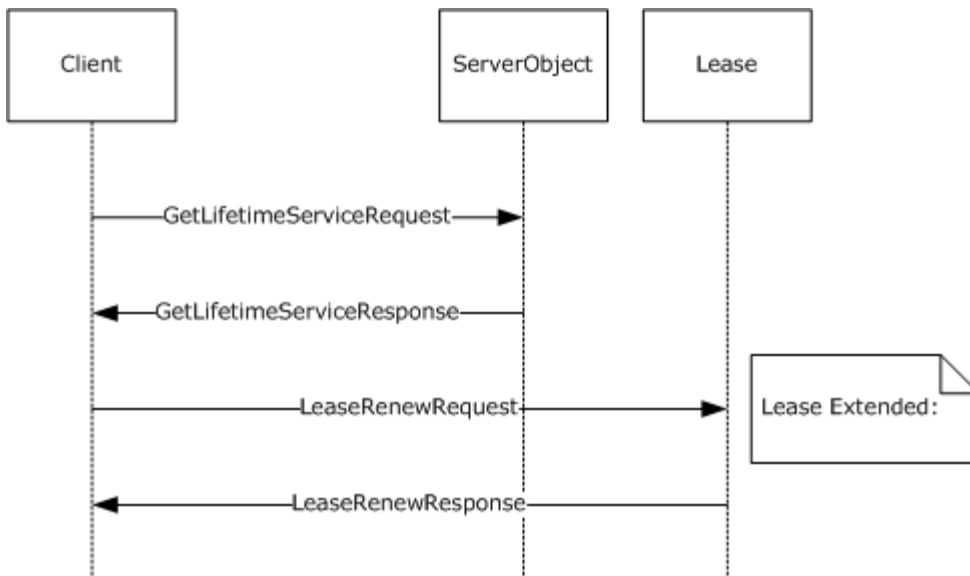

**Figure 3: Extending lease time**

The client registers a Sponsor that is invoked when the Lease Object's TTL expires, as follows.

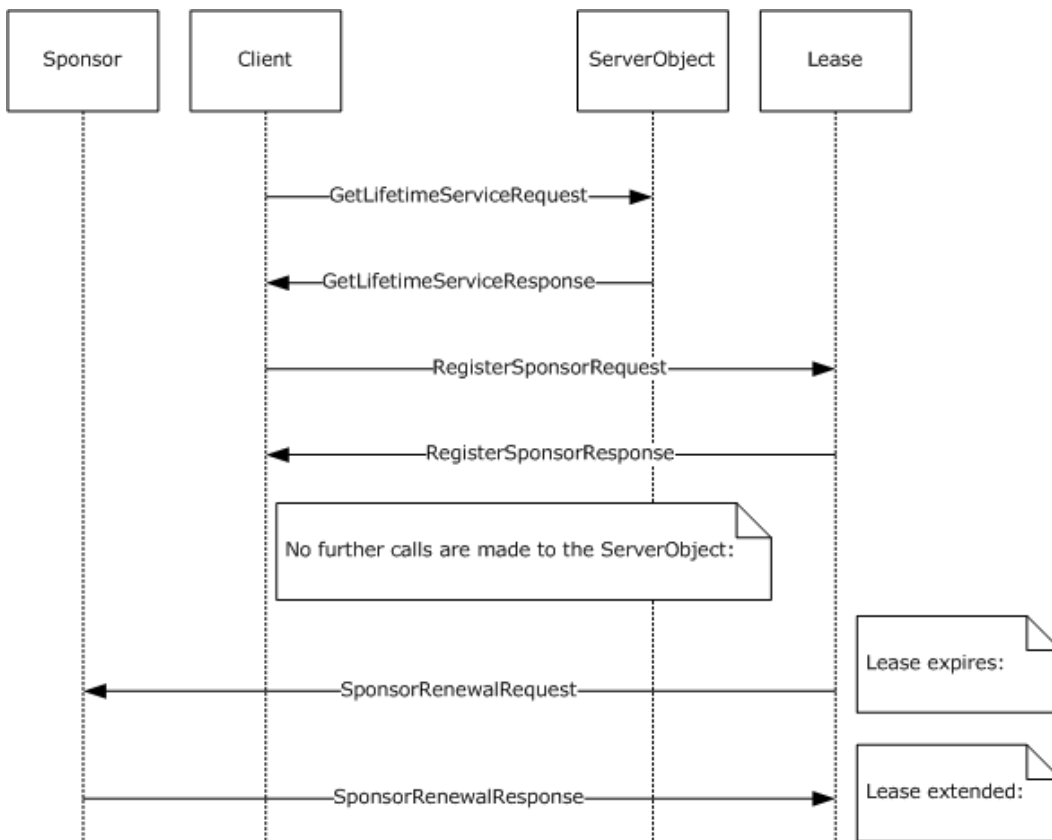

**Figure 4: Registering a Sponsor**

For more information about how leases and Sponsors are exposed in Windows, see [\[MSDN-RemotingLifetime\]](#).

If the **client** times out and there are no sponsors left in the SponsorList, the Lease expires. The Server Lease Object and the Server Object MUST be unmarshaled as per [section \(section 3.3.5.1\)](#) Lease TTL Timer.

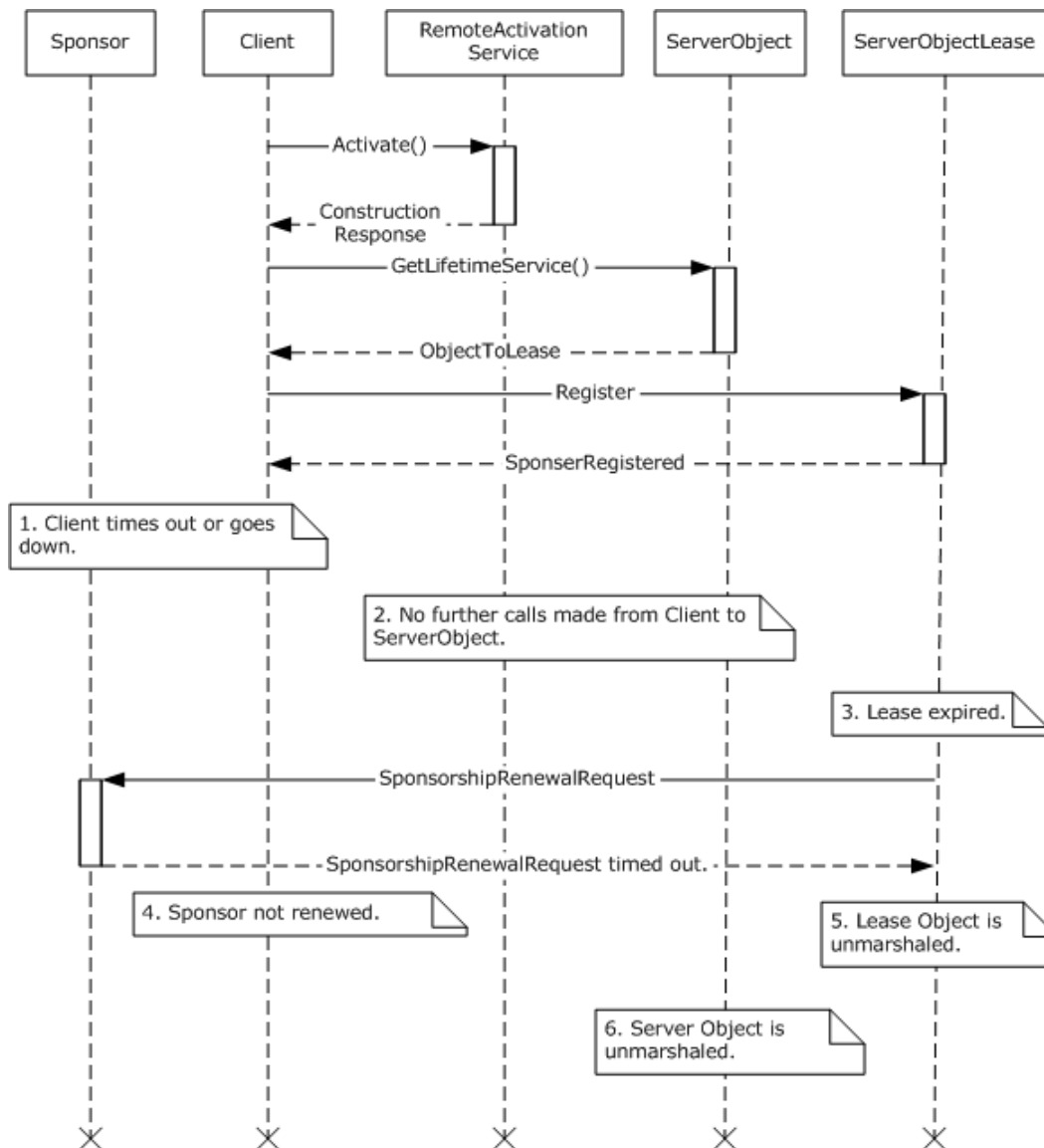

**Figure 5: Client timed out or unresponsive**

### 1.3.4 Notational Conventions

All **Remoting Type** and Remoting Interface definitions in this specification use the .NET Remoting Description Notation defined in [\[MS-NRTP\]](#) section 2.2.5. This notation is specific to .NET Remoting-based protocols and is provided to facilitate explanation of the protocol. This document does not mandate that implementations adhere to a particular Application Programming Interface or

programming language as long as their external behavior is consistent with that described in this document.

## 1.4 Relationship to Other Protocols

This protocol is a .NET Remoting-based protocol, using the .NET Remoting Protocol as a transport. Additionally, this protocol extends the [.NET Remoting Protocol](#), adding new methods for activation and lifetime management.

The protocol layering of the related protocols is as follows.

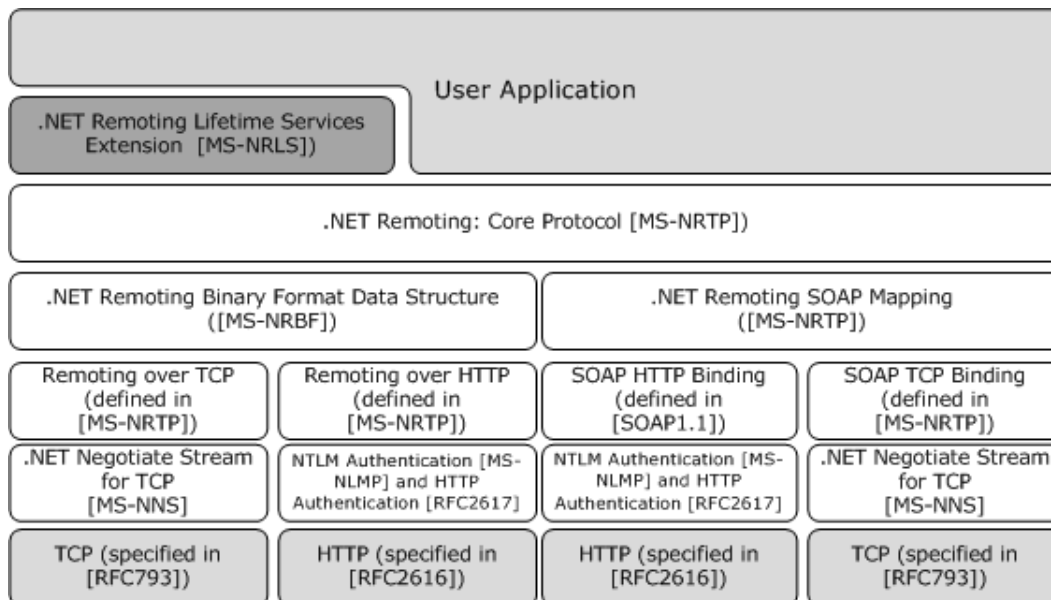

**Figure 6: NRLS protocol stack**

## 1.5 Prerequisites/Preconditions

This protocol layers on top of the [.NET Remoting Protocol](#) and, as a result, has the prerequisites specified in [MS-NRTP]. In addition, for a CAO, the client application must be configured with enough information about the Server Type to construct the activation message.

## 1.6 Applicability Statement

The protocol described in this specification is applicable to users of the [.NET Remoting Protocol](#) in environments that require distributed activation and lifetime management of Server Objects.

CAOs require a server to maintain references to each client object created, which might not scale to large numbers of clients.

The Sponsor mechanism requires that references be maintained from each server to all registered Sponsors. In addition, the server must individually contact each client with a Sponsor, which does not scale for large numbers of clients holding Sponsors.

## 1.7 Versioning and Capability Negotiation

This protocol has no versioning or capability negotiation.

## **1.8 Vendor-Extensible Fields**

This protocol has no vendor-extensible fields.

## **1.9 Standards Assignments**

There are no standards assignments made by this protocol.

## 2 Messages

The following sections specify message relationships to the [.NET Remoting Protocol](#), as well as common .NET Remoting: Lifetime Services Extension Remoting Types.

### 2.1 Transport

This protocol can be bound to any transport supported by the [.NET Remoting Protocol](#), as specified in [\[MS-NRTP\]](#) section 2.1.

### 2.2 Common Data Types

#### 2.2.1 ArrayList

ArrayList is a **Class**. The **Library** name of the Class is "mscorlib". It represents a collection of **Data Values**. The capacity of the collection is increased dynamically as required.

```
namespace System.Collections
{
    class ArrayList
    {
        System.Object[]    _items;
        Int32               _size;
        Int32               _version;
    }
}
```

**\_items:** An **Array** that holds Data Values. The size of the Array MUST be greater than or equal to the value of the **\_size** field.

**\_size:** An Int32 value that indicates the number of items present in the ArrayList.

**\_version:** An Int32 value that is unused by this protocol. It MAY contain any value and the value MUST be ignored.[<1>](#)

**Note** The Array is resized as new items are added to the collection. To accommodate adding items in a performant way, the size of the Array MAY be more than the number of items in the collection. If an element of the **\_items** Array has an index greater than or equal to the value of the **\_size** field, it is not considered part of the ArrayList. The element MAY contain any value and the value MUST be ignored.[<2>](#)

#### 2.2.2 ConstructionCall

ConstructionCall is a Class. The Library name of the Class is "mscorlib". It is used to activate a Server Object.

```
namespace System.Runtime.Remoting.Messaging
{
    class ConstructionCall
    {
        String                __Uri;
        String                __MethodName;
        System.Type[]        __MethodSignature;
        String                __TypeName;
    }
}
```

```

    System.Object[]           ___Args;
    System.Object             ___CallContext;
    System.Type               ___ActivationType;
    System.Object             ___Activator;
    String                    ___ActivationTypeName;
    System.Collections.ArrayList ___ContextProperties;
    System.Object[]           ___CallSiteActivationAttributes;
}
}

```

\_\_\_**Uri**: A string value that is unused by this protocol. It MAY contain any value and the value MUST be ignored. <3>

\_\_\_**MethodName**: A string value that specifies the name of the Remote Method. Its value MUST be ".ctor".

\_\_\_**MethodSignature**: An Array of type System.Type. Each item in the Array contains information about the Remoting Type of the arguments that are needed to create an instance of the Server Object. System.Type is defined in [MS-NRTP] section 2.2.2.11.

\_\_\_**TypeName**: A string value that contains the name of the Server Type to activate.

\_\_\_**Args**: An Array of objects that contains the parameters required to create an instance of the Server Object.

\_\_\_**CallContext**: A **Null Object**. This field is reserved in this protocol. The value of this field MUST be NullObject.

\_\_\_**ActivationType**: A Null Object, or an instance **Assignable** to System.Type that contains information about the Server Type that is being activated. Its value SHOULD be a Null Object.

\_\_\_**Activator**: An object field that is unused in the protocol. This field MAY contain any value and the value MUST be ignored. <4>

\_\_\_**ActivationTypeName**: A String value that contains the name of the Server Type. This field MUST have the same value as the field \_\_\_**TypeName**.

\_\_\_**ContextProperties**: An [ArrayList](#) that contains additional values required for the activation of the Server Type. The interpretation of the values is higher-layer-defined. If there are no properties, this value MUST be an empty ArrayList (that is, an ArrayList with a value of 0 for the **\_size** field). <5>

\_\_\_**CallSiteActivationAttributes**: A Null Object, or an Array of any Data Values. The interpretation of the values is higher-layer-defined. If there are no values, then this value MUST be a Null Object. <6>

### 2.2.3 ContextLevelActivator

ContextLevelActivator is a Class. The Library name of the Class is "mscorlib". It is used in the \_\_\_Activator field of a [ConstructionCall](#) instance.

```

namespace System.Runtime.Remoting.Activation
{
    class ContextLevelActivator
    {

```



```

        System.Runtime.Remoting.Activation.ConstructionLevelActivator
    m_NextActivator;
    }
}

```

**m\_NextActivator:** An instance of [ConstructionLevelActivator](#).

## 2.2.4 ConstructionLevelActivator

ConstructionLevelActivator is a Class. The Library name of the Class is "mscorlib". It is used in the **m\_NextActivator** field of a [ContextLevelActivator](#) instance.

```

namespace System.Runtime.Remoting.Activation
{
    class ConstructionLevelActivator
    {
    }
}

```

This Class has no members.

## 2.2.5 ConstructionResponse

ConstructionResponse is a Class. The Library name of the Class is "mscorlib". It is used to contain the activated Server Object.

```

namespace System.Runtime.Remoting.Messaging
{
    class ConstructionResponse
    {
        String                __Uri;
        String                __MethodName;
        String                __TypeName;
        System.Object         __Return;
        System.Object[]       __OutArgs;
        System.Object         __CallContext;
    }
}

```

**\_\_Uri:** The field MAY contain any value and the value MUST be ignored. [<7>](#)

**\_\_MethodName:** A string value that specifies the name of the Remote Method. Its value MUST be ".ctor".

**\_\_TypeName:** A string value that contains the name of the Server Type that was activated.

**\_\_Return:** This field contains the activated Server Object.

**\_\_OutArgs:** The value of this field MUST be an Array of System.Object. The length of the Array MUST be 0.

**\_\_CallContext:** The value of this field MUST be NullObject.

## 2.2.6 LeaseState

The LeaseState enumeration provides state information about a Lease Object. The size of this enumeration is an Int32.

```
namespace System.Runtime.Remoting.Lifetime
{
    enum LeaseState : Int32
    {
        Null      = 0,
        Initial   = 1,
        Active    = 2,
        Renewing  = 3,
        Expired   = 4
    }
}
```

**Null:** The Lease Object is in an error state.

**Initial:** This is the initial state when the Lease Object is created.

**Active:** The Lease Object is actively maintaining the lifetime of Server Object.

**Renewing:** The TTL has expired and is in the process of renewing.

**Expired:** The Lease Object has expired.

## 2.2.7 ArgumentException

ArgumentException is a Derived Class of [SystemException](#). The Library name of the Class is "mscorlib". When thrown from a Remote Method, it indicates that one of the arguments to the Remote Method was invalid. Other than the **Members** inherited from the [System.SystemException](#) Class, it contains information about the name of an invalid argument. This Class has an additional constraint: the **HResult** member MUST be hex value 0x80070057.

```
namespace System
{
    class ArgumentException : System.SystemException
    {
        String      ParamName;
    }
}
```

**ParamName:** A string value that contains the name of an invalid argument.

## 2.2.8 ArgumentNullException

ArgumentNullException is a Derived Class of [ArgumentException](#). The Library name of the Class is "mscorlib". When thrown from a Remote Method, it indicates that a required argument of the Remote Method was a Null Object. There are no Members other than the Members inherited from

the `System.ArgumentException` Class. This Class has an additional constraint: the **HResult** member MUST be hex value `0x80004003`.

```
namespace System
{
    class ArgumentNullException : System.ArgumentException
    {
    }
}
```

## 3 Protocol Details

This protocol extends the server and client roles defined in the .NET Remoting Protocol [\[MS-NRTP\]](#) by defining Remoting Interfaces to be implemented by each role. For each Remoting Interface, the client side is simply a pass-through. That is, no additional timers or other state information are required on the client side. Calls made by the higher-layer protocol or application are passed directly to the transport, and the results returned by the transport are passed directly back to the higher-layer protocol or application.

This protocol extends the server role defined in the .NET Remoting Protocol Server Details ([\[MS-NRTP\]](#) section 3.2) in the following ways:

- The server implementation MUST register a Server-Activated Object (SAO) that implements the [IActivator \(section 3.1\)](#) interface. The **Server Object URI** of the SAO MUST be "RemoteActivationService.rem".
- Each Server Object that participates in the lifetime management MUST implement [MarshalByRefObject \(section 3.2\)](#).
- Each Server Object that defines one or more **Remote Fields** MUST implement [Object \(section 3.5\)](#).
- The [ILease](#) Abstract Data Model (section [3.3.1](#)) extends the .NET Remoting Protocol Server Abstract Data Model ([\[MS-NRTP\]](#) section 3.2.1) in the following ways:
  - Associates a Lease Object with each Server Object in the Server Object Table.
  - Updates the TTL of the Lease Object on each invocation of an application-defined Remote Method.

This protocol extends the client role defined in [\[MS-NRTP\]](#) section 3.3 in the following way:

- The client MAY implement the [ISponsor \(section 3.4\)](#) interface to participate in the lifetime management of the Server Object. [<8>](#) By implementing the **ISponsor** interface, the client is also acting in the server role defined in [\[MS-NRTP\]](#) section 3.2.

### 3.1 IActivator

The **RemotingTypeName** of the interface is "System.Runtime.Remoting.Activation.IActivator".

#### 3.1.1 Abstract Data Model

This section describes a conceptual model of possible data organization that an implementation maintains to participate in this protocol. The described organization is provided to facilitate the explanation of how the protocol behaves. This document does not mandate that implementations adhere to this model as long as their external behavior is consistent with that described in this document.

#### Activatable Types Table

This table contains the set of Server Types that can be activated by a client using the [IActivator \(section 3.1\)](#) interface. The table associates a Server Type by name with the following information:

- A list of Constructor Method Signatures that a client can target in the [Activate \(section 3.1.4.1\)](#) request.

- Any other implementation-specific information required to service the Activate request.

### 3.1.2 Timers

There are no timers associated with this interface.

### 3.1.3 Initialization

A Singleton SAO MUST be registered as specified in [MS-NRTP] section 3.2.4.1. The Server Object MUST implement the [IActivator \(section 3.1\)](#) interface. The Server Object URI MUST be "RemoteActivationService.rem".

The **Activatable Types Table** MUST be populated with the initial set of activatable Server Types and their Constructor Method Signatures specified by the higher layer in an implementation-specific way.

### 3.1.4 Message Processing Events and Sequencing Rules

This interface includes the following method.

Method	Description
<a href="#">Activate</a>	Activates the specified Server Object

#### 3.1.4.1 Activate

The **Activate** method activates a Server Object. The parameter specifies the Server Type of the Server Object.

```
System.Runtime.Remoting.Messaging.ConstructionResponse
Activate(
    System.Runtime.Remoting.Messaging.ConstructionCall callMessage);
```

**callMessage:** An instance of [ConstructionCall](#) that contains information that is required to activate the Server Object.

**Return Values:** An instance of [ConstructionResponse](#) that contains the activated Server Object.

**Exceptions:** If the Server Object cannot be activated, a [RemotingException](#) (as specified in [MS-NRTP] section 2.2.2.9) MUST be thrown. If the *callMessage* parameter does not fulfill the constraints (as specified in [ConstructionCall](#), section 2.2.2), then a [RemotingException](#) MUST be constructed (as specified in [MS-NRTP] section 3.2.5.1.7.2). The **Exception** MUST be sent back to the client.

The implementation MUST look up the target Server Type in the **Activatable Types Table**. The implementation SHOULD use the **\_\_TypeName** field of the *callMessage* parameter as a key, but MAY use other information instead or in addition. If no matching entry is found in the table, a [RemotingException](#) MUST be constructed (as specified in [MS-NRTP] section 3.2.5.1.7.2) and sent back to the client. <9>

Once the Server Type information is obtained, the implementation MUST select the Constructor Method Signature for the activation as follows:

- If there is exactly one Constructor Method Signature associated with the Server Type in the **Activatable Types Table**, then that is the Constructor Method Signature for the activation.
- If there is more than one Constructor Method Signature associated with the Server Type, then the Constructor Method Signature that matches exactly the **\_\_MethodSignature** field of the *callMessage* parameter is selected. Two arrays match exactly if they have the same number of elements and each member of the one array has the same value as the corresponding member of the other array.

If the implementation is unable to select a Constructor Method Signature to match the incoming Activate request, a *RemotingException* MUST be constructed (as specified in [\[MS-NRTP\]](#) section 3.2.5.1.7.2) and sent back to the client.

Once the Constructor Method Signature is selected, the implementation SHOULD validate that the incoming argument data in the **\_\_Args** field of the *callMessage* argument is assignable to the arguments specified in the Constructor Method Signature using the rules specified in [\[MS-NRTP\]](#) section 3.1.1 in the definition of Remote Method.

If the incoming argument data fails validation, the implementation SHOULD construct a *RemotingException* (as specified in [\[MS-NRTP\]](#) section 3.2.5.1.7.2) and send it back to the client.

The implementation then MUST create an instance of the Server Type in an implementation-specific manner.

The implementation MUST construct a *ConstructionResponse* as specified in section [2.2.5](#), with the following additional constraints:

- The **\_\_Return** field of the *ConstructionResponse* MUST be set to the newly created Server Object.
- The **\_\_MethodName** MUST match the **\_\_MethodName** field of the incoming *ConstructionCall* instance.
- The **\_\_TypeName** MUST match the **\_\_TypeName** field of the incoming *ConstructionCall* instance.

The *ConstructionResponse* instance MUST be sent back as the return value of the method.

### 3.1.5 Timer Events

There are no timer events associated with this interface.

### 3.1.6 Other Local Events

#### 3.1.6.1 Register Activatable Server Type

The implementation SHOULD provide an implementation-specific way for the higher layer to register a Server Type for activation after initialization has completed. When a Server Type is registered for activation, the implementation MUST add the Server Type and its Constructor Method Signatures to the **Activatable Types Table**. This protocol does not provide a mechanism for unregistering a Server Type once it has been registered for activation.

## 3.2 MarshalByRefObject

The **RemotingTypeName** of the interface is "System.MarshalByRefObject".

### 3.2.1 Abstract Data Model

This protocol extends the [.NET Remoting: Core Protocol Specification](#) Abstract Data Model (as specified in [MS-NRTP]sections [3.1.1](#) and [3.2.1](#)) to associate a Lease Object with every active Server Object. The Lease Object MUST be a valid Server Object (as specified in [MS-NRTP] [3.1.1](#)) that implements the [ILease \(section 3.3\)](#) interface.

### 3.2.2 Timers

There are no timers associated with this interface.

### 3.2.3 Initialization

A Lease Object and Lease Object Data MUST be created and associated with a Singleton SAO or MSO during initialization.

### 3.2.4 Message Processing Events and Sequencing Rules

This interface includes the following method.

Method	Description
<a href="#">GetLifetimeService</a>	Returns the Lease Object associated with the target Server Object.

#### 3.2.4.1 GetLifetimeService

**GetLifetimeService** retrieves a reference to the Lease Object associated with the target Server Object.

```
System.Runtime.Remoting.Lifetime.ILease GetLifetimeService();
```

**Return Values:** The Lease Object associated with the target Server Object.

**Exceptions:** No Exceptions are specified for this method other than the Exceptions common to all Remote Methods in .NET Remoting (as specified in [\[MS-NRTP\]](#) section 3.2.5.1.7.2).

On the first call to **GetLifetimeService**, the implementation MUST do the following:

- Set the CurrentState of the Lease Object associated with the target Server Object to Active.
- Set the CurrentState of the associated Lease Data to Active.

The Server Object Reference MUST be returned as the **Return Value** for the method.

### 3.2.5 Timer Events

There are no timer events associated with this interface.

### 3.2.6 Other Local Events

There are no other local events.

### 3.3 ILease

The **RemotingTypeName** of the interface is "System.Runtime.Remoting.Lifetime.ILease".

#### 3.3.1 Abstract Data Model

This section describes a conceptual model of possible data organization that an implementation maintains to participate in this protocol. The described organization is provided to facilitate the explanation of how the protocol behaves. This document does not mandate that implementations adhere to this model as long as their external behavior is consistent with that described in this document.

##### Sponsor Info

Sponsor Info contains the following information about a Sponsor:

- **Proxy:** A Proxy to a Sponsor that was registered by a client.
- **RenewalTime:** The TimeSpan value that was passed when the Sponsor was registered.

##### Lease Data

Lease data extends the Server Object Table defined in [\[MS-NRTP\]](#) section 3.2.1. Lease Data is associated with the Lease Object of a Server Object. Lease Data contains the following values:

- **InitialLeaseTime:** The initial TTL of a Server Object when it is marshaled.
- **RenewOnCallTime:** The duration by which to extend the TTL when a method is called in the associated Server Object.
- **SponsorshipTimeout:** The duration to wait for a Sponsor to respond.
- **CurrentState:** A [LeaseState](#) value that indicates the current state of the Lease Object.
- **SponsorList:** A list of Sponsor Info. The list is sorted in decreasing order of the Sponsor Info's **RenewalTime** field values.

#### 3.3.2 Timers

**Lease TTL Timer:** Tracks the TTL of a Server Object. Each Lease Object is associated with a Lease TTL Timer that fires when its TTL expires.

**Sponsorship Timer:** Tracks the duration of each Renewal call to a Sponsor.

#### 3.3.3 Initialization

An implementation MUST set the initial values of InitialLeaseTime, RenewOnCallTime and SponsorshipTimeout to a nonzero positive value. The initial value of the CurrentState MUST be *Initial*.<10>

#### 3.3.4 Message Processing Events and Sequencing Rules

This interface includes the following methods.



Method	Description
<a href="#">Renew</a>	Increases the TTL by the specified amount.
<a href="#">Register</a> <a href="#">Register(Overload)</a>	Registers the specified Sponsor in a Lease Object's SponsorList. Two forms of this method exist.
<a href="#">Unregister</a>	Unregisters a Sponsor from the Lease Object's SponsorTable.
<a href="#">get_InitialLeaseTime</a>	Returns the Lease Object's InitialLeaseTime.
<a href="#">set_InitialLeaseTime</a>	Updates the Lease Object's InitialLeaseTime with the specified amount.
<a href="#">get_RenewOnCallTime</a>	Returns the Lease Object's RenewOnCallTime.
<a href="#">set_RenewOnCallTime</a>	Updates the Lease Object's RenewOnCallTime.
<a href="#">get_SponsorshipTimeout</a>	Returns the Lease Object's SponsorshipTimeout.
<a href="#">set_SponsorshipTimeout</a>	Updates the Lease Object's SponsorshipTimeout.
<a href="#">get_CurrentLeaseTime</a>	Returns the time when the Lease Object expires.
<a href="#">get_CurrentState</a>	Returns the Lease Object's current state.

Lease Data's CurrentState determines whether a method can be called. Calling the preceding operations takes the Lease Object through various [LeaseStates](#). The state machine that captures the LeaseState transitions is specified in the following diagram.

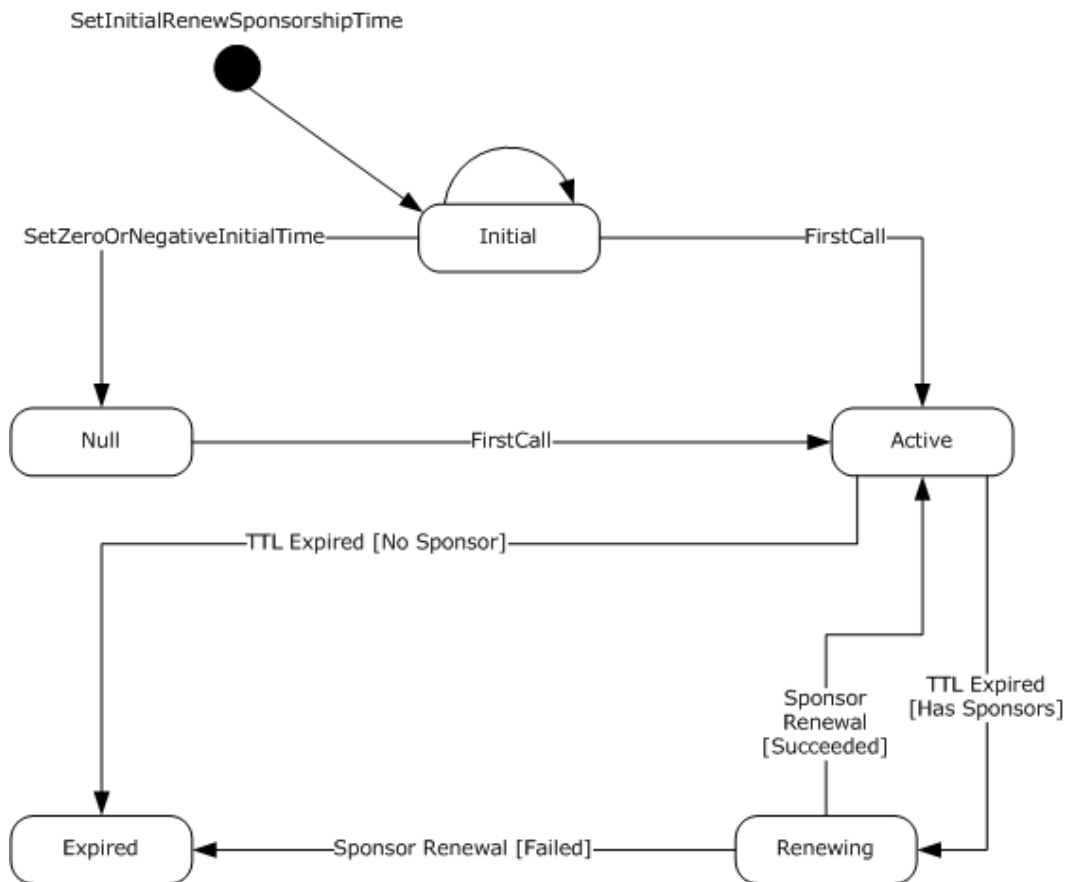

**Figure 7: Lease state machine**

### 3.3.4.1 Renew

**Renew** extends the TTL of a Server Object.

```

TimeSpan Renew(
    TimeSpan renewalTime
);
  
```

**renewalTime:** A TimeSpan value that specifies the required TTL for the Server Object.

**Return Value:** A TimeSpan value that specifies the new TTL for the Server Object.

**Exceptions:** In addition to the Exceptions common to all Remote Methods in .NET Remoting (as specified in [\[MS-NRTP\]](#) section 3.2.5.1.7.2), if the CurrentState value of the associated Lease Data is "Expired", a [RemotingException](#) (as specified in [\[MS-NRTP\]](#) section 3.2.5.1.7.2) MUST be sent back.

If the CurrentState value of the associated Lease Data is "Expired", then the implementation MUST NOT modify the TTL; instead, the implementation MUST construct a RemotingException ([\[MS-NRTP\]](#) section 2.2.2.9) as specified in [\[MS-NRTP\]](#) section 3.2.5.1.7.2, Constructing a Remoting Exception. The Exception MUST be sent back to the client.

Otherwise, if the `CurrentState` is valid, the new TTL for the Server Object is the **renewalTime** or the current value of the [Lease TTL Timer](#), whichever is greater. The implementation MUST reset the Lease TTL Timer to the new TTL value and return it as the return value of the **Renew** method.

### 3.3.4.2 Register

**Register** registers a Sponsor with the Lease Object associated with the Server Object.

```
void Register(  
    System.Runtime.Remoting.Lifetime.ISponsor sponsor  
);
```

**sponsor:** A Proxy to a Server Object that implements the [ISponsor](#) interface.

**Return Values:** There are no return values for this method.

**Exceptions:** In addition to the Exceptions common to all Remote Methods in .NET Remoting (as specified in [\[MS-NRTP\]](#) section 3.2.5.1.7.2), if the Sponsor specified in the `sponsor` argument is a Null Object, an [ArgumentNullException](#) (as specified in section [2.2.8](#)) MUST be sent back.

The implementation of the method MUST create a new Sponsor Info by using a Sponsor instance referenced by the argument `sponsor`, and a `TimeSpan` value of 0. The Sponsor Info MUST be added to the end of the `SponsorList` of the associated Lease Data.

### 3.3.4.3 Register(Overload)

**Register(Overload)** registers a Sponsor with the Lease Object associated with the Server Object. This implementation of the method includes a second parameter, `renewalTime`.

```
void Register (  
    System.Runtime.Remoting.Lifetime.ISponsor sponsor,  
    TimeSpan renewalTime  
);
```

**sponsor:** A Proxy to a Server Object that implements the [ISponsor](#) interface.

**renewalTime:** A `TimeSpan` value that specifies the required TTL for the Server Object.

**Return Values:** There are no return values for this method.

**Exceptions:** In addition to the Exceptions common to all Remote Methods in .NET Remoting (as specified in [\[MS-NRTP\]](#) section 3.2.5.1.7.2), if the Sponsor specified in the `sponsor` argument is a Null Object, an [ArgumentNullException](#) (as specified in section [2.2.8](#)) MUST be sent back.

The implementation of the method MUST add the Sponsor to the end of the `SponsorList` of the associated Lease Data.

The implementation of the method MUST:

- Create a new Sponsor Info by using the Sponsor instance referenced by the argument `sponsor`, and the `TimeSpan` value of the `renewalTime` argument. The Sponsor Info MUST be inserted in the `SponsorList` of the associated Lease Data such that the items in the list continue to be sorted in decreasing order of the Sponsor Info's `renewalTime`.

- Extend the `CurrentLeaseTime` of the associated Lease Data with the renewal `TimeSpan` as specified in the [Renew](#) method.

#### 3.3.4.4 Unregister

**Unregister** removes the specified Sponsor from the Sponsor List.

```
void Unregister(  
    System.Runtime.Remoting.Lifetime.ISponsor sponsor  
);
```

**sponsor:** A registered Sponsor that needs to be unregistered.

**Return Values:** There are no return values for this method.

**Exceptions:** No Exceptions are specified for this method other than the Exceptions common to all Remote Methods in .NET Remoting (as specified in [\[MS-NRTP\]](#) section 3.2.5.1.7.2).

Two Sponsor Proxies are considered identical if their Server Object URIs match. The Server Object URI can be looked up for a given Proxy in the Proxy Table, as specified in [\[MS-NRTP\]](#) section 3.3.1.

If the `SponsorList` of the associated Lease Data contains a Sponsor Info with Sponsor Proxy identical to the one referenced by the `sponsor` argument, the implementation **MUST** remove the Sponsor Info from the `SponsorList`.

#### 3.3.4.5 get\_InitialLeaseTime

**get\_InitialLeaseTime** returns the Lease Object's `InitialLeaseTime`.

```
TimeSpan get_InitialLeaseTime();
```

**Return Values:** A `TimeSpan` value that is the `InitialLeaseTime` in the associated Lease Data.

**Exceptions:** No Exceptions are specified for this method other than the Exceptions common to all Remote Methods in .NET Remoting (as specified in [\[MS-NRTP\]](#) section 3.2.5.1.7.2).

The method has no arguments. The implementation of the method **MUST** return the `InitialLeaseTime` of the associated Lease Data.

#### 3.3.4.6 set\_InitialLeaseTime

**set\_InitialLeaseTime** updates the Lease Object's `InitialLeaseTime` with a specified value.

```
void set_InitialLeaseTime(TimeSpan value);
```

**value:** A `TimeSpan` value that has to be set as the `InitialLeaseTime` in the associated Lease Data.

**Return Values:** There are no return values for this method.

**Exceptions:** No Exceptions are specified for this method other than the Exceptions common to all Remote Methods in .NET Remoting (as specified in [\[MS-NRTP\]](#) section 3.2.5.1.7.2).

If the associated Lease Data's CurrentState is not "Initial", then a RemotingException MUST be constructed (as specified in [\[MS-NRTP\]](#) section 3.2.5.1.7.2), and the Exception MUST be sent back to the client; otherwise, the InitialLeaseTime MUST be set to the value of the argument *value*.

If the new TimeSpan value is negative, the CurrentState MUST be set to Null state.

### 3.3.4.7 get\_RenewOnCallTime

**get\_RenewOnCallTime** returns the Lease Object's RenewOnCallTime.

```
TimeSpan get_RenewOnCallTime();
```

**Return Values:** A TimeSpan value that is the RenewOnCallTime in the associated Lease Data.

**Exceptions:** No Exceptions are specified for this method other than the Exceptions common to all Remote Methods in .NET Remoting (as specified in [\[MS-NRTP\]](#) section 3.2.5.1.7.2).

The method has no arguments. The implementation of the method MUST return the RenewOnCallTime of the associated Lease Data.

### 3.3.4.8 set\_RenewOnCallTime

**set\_RenewOnCallTime** updates the Lease Object's RenewOnCallTime.

```
void set_RenewOnCallTime(TimeSpan value);
```

**value:** A TimeSpan value that has to be set as the RenewOnCallTime in the associated Lease Data.

**Return Values:** There are no return values for this method.

**Exceptions:** No Exceptions are specified for this method other than the Exceptions common to all Remote Methods in .NET Remoting (as specified in [\[MS-NRTP\]](#) section 3.2.5.1.7.2).

If the associated Lease Data's CurrentState is not "Initial", then a RemotingException MUST be constructed (as specified in [\[MS-NRTP\]](#) section 3.2.5.1.7.2), and the exception MUST be sent back to the client; otherwise, the argument *value* MUST be set as the new value of RenewOnCallTime.

### 3.3.4.9 get\_SponsorshipTimeout

**get\_SponsorshipTimeout** returns the Lease Object's SponsorshipTimeout.

```
TimeSpan get_SponsorshipTimeout();
```

**Return Values:** A TimeSpan value that is the SponsorshipTimeout in the associated Lease Data.

**Exceptions:** No Exceptions are specified for this method other than the Exceptions common to all Remote Methods in .NET Remoting (as specified in [\[MS-NRTP\]](#) section 3.2.5.1.7.2).

The method has no arguments. The implementation of the method MUST return the SponsorshipTimeout of the associated Lease Data.

### 3.3.4.10 set\_SponsorshipTimeout

**set\_SponsorshipTimeout** updates the Lease Object's SponsorshipTimeout.

```
void set_SponsorshipTimeout(System.TimeSpan value);
```

**value:** A TimeSpan value that has to be set as the SponsorshipTimeout in the associated Lease Data.

**Return Values:** There are no return values for this method.

**Exceptions:** No Exceptions are specified for this method other than the Exceptions common to all Remote Methods in .NET Remoting (as specified in [\[MS-NRTP\]](#) section 3.2.5.1.7).

If the associated Lease Data's CurrentState is not "Initial", then a RemotingException MUST be constructed (as specified in [\[MS-NRTP\]](#) section 3.2.5.1.7.2), and the Exception MUST be sent back to the client; otherwise, the argument *value* MUST be set as the new value of SponsorshipTimeout.

### 3.3.4.11 get\_CurrentLeaseTime

**get\_CurrentLeaseTime** returns the expiration time of the Lease Object.

```
TimeSpan get_CurrentLeaseTime();
```

**Return Values:** A TimeSpan value that is the TTL of the associated Server Object.

**Exceptions:** No Exceptions are specified for this method other than the Exceptions common to all Remote Methods in .NET Remoting (as specified in [\[MS-NRTP\]](#) section 3.2.5.1.7.2).

The method has no arguments. The implementation of the method MUST return the current value of the [Lease TTL Timer](#).

### 3.3.4.12 get\_CurrentState

**get\_CurrentState** returns the current [LeaseState](#) value of the Lease Object.

```
System.Runtime.Remoting.Lifetime.LeaseState get_CurrentState();
```

**Return Values:** A LeaseState value that is the CurrentState of the associated Lease Data.

**Exceptions:** No Exceptions are specified for this method other than the Exceptions common to all Remote Methods in .NET Remoting (as specified in [\[MS-NRTP\]](#) section 3.2.5.1.7.2).

The method has no arguments. The implementation of the method MUST return the CurrentState of the associated Lease Data.

## 3.3.5 Timer Events

### 3.3.5.1 Lease TTL Timer

When the Lease TTL Timer is fired, an implementation of the protocol MUST evaluate lease renewal as specified below.

If there are no Sponsor Info instances in the Lease Data's SponsorList, the implementation MUST set the CurrentState of the associated Lease Data to "Expired", and MUST unmarshal the Server Object, as specified in [\[MS-NRTP\]](#) section 3.2.4.3.

If there are Sponsor Info instances in the Lease Data's SponsorList, then the [Renewal](#) method of the first Sponsor Info's Proxy MUST be called. The Sponsorship Timer MUST be set to fire after the duration indicated by SponsorshipTimeout. If the method returns successfully and the Return Value is a time duration greater than 0, the implementation MUST do the following:

- Extend the TTL of the Server Object by that TimeSpan.
- Reset the timer to fire after the new TTL.
- Set the Sponsor Info's RenewalTime field to the time duration that was returned.
- Reposition the Sponsor Info with the new RenewalTime in the SponsorList, such that the list is sorted in decreasing order of RenewalTime.

If any of the following conditions occur, the renewal call is considered unsuccessful, and the implementation MUST remove the Sponsor Info from the SponsorList.

- The SponsorshipTimer fired before the **Renewal** method completed.
- The **Renewal** method did not return within the duration specified in SponsorshipTimeout.
- The **Renewal** method threw an Exception.
- The **Renewal** method returned a TimeSpan of 0.

If the renewal call was unsuccessful, the implementation MUST repeat the renewal process with the next Sponsor Info in the SponsorList.

If there are no Sponsor Info instances left in the SponsorList, the implementation MUST do the following:

- Set the CurrentState of the Lease Data to "Expired".
- Unmarshal the associated Server Object as specified in [\[MS-NRTP\]](#) section 3.2.4.3.
- Unmarshal the Lease Object as specified in [\[MS-NRTP\]](#) section 3.2.4.3.

### 3.3.5.2 Sponsorship Timer

If the Sponsorship Timer fires before the pending [Renewal](#) method has completed, the implementation MUST remove the Sponsor Info from the SponsorList and move to the next Sponsor Info in the SponsorList, as specified in section [3.3.5.1](#).

### 3.3.6 Other Local Events

#### 3.3.6.1 Binding to Server Object

This protocol augments [\[MS-NRTP\]](#) section 3.2.5.1.2 to specify additional processing for lifetime management. When a request is bound to a Server Object, the Lease Object associated with that Server Object MUST be renewed as specified in the [ILease Renew](#) method using the current value of the Lease Data RenewOnCallTime as the value for the **renewalTime** argument.

### 3.3.6.2 Marshal Server Object

This protocol augments [\[MS-NRTP\]](#) section 3.5.4.1 to specify additional processing for [lifetime management](#). When a Server Object is marshaled, the Lease Object associated with that Server Object MUST be renewed as specified in the [ILease Renew](#) method using the current value of the Lease Data RenewOnCallTime as the value for the **renewalTime** argument.

### 3.3.6.3 Unmarshal Server Object

This protocol augments [\[MS-NRTP\]](#) section 3.5.4.1 to specify additional processing for [lifetime management](#). When a Server Object is unmarshaled, the implementation MAY expire the Lease Object associated with that Server Object as specified in [Lease TTL Timer \(section 3.3.5.1\)](#). <11>

## 3.4 ISponsor

The **RemotingTypeName** of the interface is "System.Runtime.Remoting.Lifetime.ISponsor".

### 3.4.1 Abstract Data Model

There is no data model for this interface.

### 3.4.2 Timers

There are no timers beyond those provided by the underlying transport layers.

### 3.4.3 Initialization

There is no initialization required by the implementation of this interface.

### 3.4.4 Message Processing Events and Sequencing Rules

This interface includes the following method.

Method	Description
<a href="#">Renewal</a>	Extends the TTL of the associated Server Object

#### 3.4.4.1 Renewal

**Renewal** extends the TTL of the associated Server Object.

```
TimeSpan Renewal(ILease lease);
```

**lease:** The expiring [ILease](#) object.

**Return Value:** A TimeSpan value that indicates the new TTL for the Server Object.

**Exceptions:** No Exceptions are specified for this method other than the Exceptions common to all Remote Methods in .NET Remoting (as specified in [\[MS-NRTP\]](#) section 3.2.5.1.7.2).

An implementation of this method MUST return a TimeSpan that is the new TTL. The implementation MUST return a valid TimeSpan value greater than or equal to 0. The meaning of the return value is specified in the following table.



Value	Meaning
0	Lease need not be renewed, and this Sponsor can be dropped from the Lease SponsorList.
>0	Lease needs to be renewed, and this Sponsor needs to be kept in the Lease SponsorList.

The implementation SHOULD NOT call methods on the lease argument but instead rely on the return value to indicate **renewal**.

### 3.4.5 Timer Events

There are no timer events.

### 3.4.6 Other Local Events

There are no other events.

## 3.5 Object

The **RemotingTypeName** of the interface is "System.Object".

### 3.5.1 Abstract Data Model

This protocol extends the .NET Remoting: Core Protocol Specification Abstract Data Model (as specified in [\[MS-NRTP\]](#) sections [3.1.1](#) and [3.2.1](#)) to associate zero or more Remote Fields with every active Server Object. For more information about Remote Fields, see [\[MS-NRTP\]](#) sections [3.1.5.1.3](#) and [3.1.5.2.3](#).

### 3.5.2 Timers

There are no timers associated with this interface.

### 3.5.3 Initialization

Each Remote Field defined for the Server Object MUST be initialized as required by the application or higher-layer in an implementation-specific way.

### 3.5.4 Message Processing Events and Sequencing Rules

This interface includes the following methods.

Method	Description
<a href="#">FieldGetter</a>	Returns the value of the specified field.
<a href="#">FieldSetter</a>	Sets the value of the specified field to the specified value.

#### 3.5.4.1 FieldGetter

**FieldGetter** returns the value of the specified Remote Field. For more information about how this method is used for Remote Fields, see [\[MS-NRTP\]](#) sections [3.1.5.1.3](#) and [3.1.5.2.3](#).

```
void FieldGetter(String typeName, String fieldName, ref
System.Object val);
```

**typeName:** A string value that specifies the name of the **Server Interface** containing the Remote Field. The Server Interface MUST be the Server Type of the Server Object.

**fieldName:** A string value that specifies the name of the Remote Field whose value is to be retrieved. The Remote Field MUST be defined in the Server Interface specified by the **typeName** field.

**val:** The value of the Remote Field. This is a ref argument. Its value on input MUST be ignored. An implementation MUST set the argument to the value of the Remote Field.

**Exceptions:** In addition to the Exceptions common to all Remote Methods in .NET Remoting (as specified in [\[MS-NRTP\]](#) section 3.2.5.1.7), if the Remote Field specified in the **fieldName** argument is not defined in the Server Interface specified by the **typeName** argument, a RemotingException (as specified in [\[MS-NRTP\]](#) section 2.2.2.8) MUST be sent back.

### 3.5.4.2 FieldSetter

**FieldSetter** sets the value of the specified Remote Field to the specified value. For more information about how this method is used for Remote Fields, see [\[MS-NRTP\]](#) sections [3.1.5.1.4](#) and [3.1.5.2.4](#).

```
void FieldSetter(String typeName, String fieldName,  
System.Object val);
```

**typeName:** A string value that specifies the name of the Type containing the Remote Field. The Type MUST be the Type or base Type of the Server Object.

**fieldName:** A string value that specifies the name of the Remote Field whose value is to be set. The Remote Field MUST be defined in the Type specified by the **typeName** field.

**val:** The value of the field. An implementation MUST set the value of the Remote Field to the value of this argument.

**Exceptions:** In addition to the Exceptions common to all Remote Methods in .NET Remoting (as specified in [\[MS-NRTP\]](#) section 3.2.5.1.7.2), if the Remote Field specified in the **fieldName** argument is not defined in the Type specified by the **typeName** argument, a RemotingException (as specified in [\[MS-NRTP\]](#) section 2.2.2.8) MUST be sent back.

### 3.5.5 Timer Events

There are no timer events associated with this interface.

### 3.5.6 Other Local Events

There are no other local events.

## 4 Protocol Examples

The following sections provide common scenarios to illustrate the function of the .NET Remoting: Lifetime Services Extension.

### 4.1 CAO Activation Request/Response Message.

This sample shows the messages involved when the client sends an activation request for a CAO where the transport is TCP and the format is binary.

The client is requesting the server to activate an instance of ServerType "DOJRemotingMetadata.MyServer". The Server Type is defined in the Library "DOJRemotingMetadata". This is done by calling the [Activate](#) method in [System.Runtime.Remoting.Activation.IActivator](#) Server Type. The Server Object URI is "RemoteServiceActivation.rem". The server is hosted on machine "maheshdev2".

The server is configured to support TCP on port 8080 and the messages are expected to be encoded in the .NET Remoting Binary Format, as specified in [\[MS-NRBF\]](#).

The sequence diagram for an activation process is shown in the following figure.

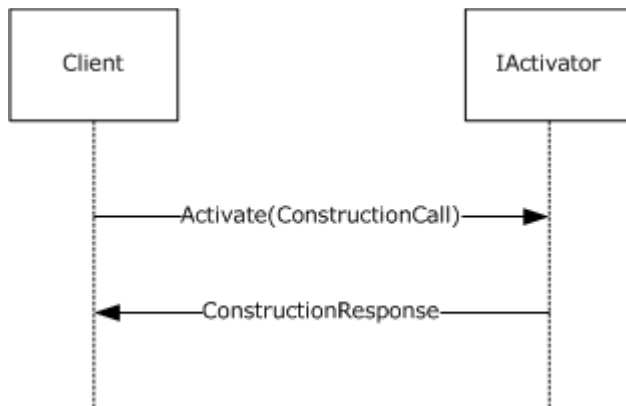

**Figure 8: Activation process**

#### 4.1.1 Activation Request Message

The client passes a [ConstructionCall \(section 2.2.2\)](#) instance as an argument to the [Activate](#) method of the [IActivator](#) interface.

The sample message structure of the activation request is as follows.

```
ProtocolIdentifier: 0x54454E2E
MajorVersion: 1 (0x1)
MinorVersion: 0 (0x0)
Operation: Request (0x00)
Content Length
  Content Distribution: Content Length (0x00)
  Content Length: 1013 (0x03F5)
Header 1:
  RequestUriHeader
  HeaderToken: RequestUri (0x04)
  DataType: CountedString (0x01)
```

```

    StringEncoding: UTF8 (0x01)
    UriValue: tcp://maheshdev2:8080/RemoteActivationService.rem
Header 2:
  ContentTypeHeader:
    HeaderToken: ContentType (0x06)
    DataType: CountedString (0x01)
    ContentTypeValue: application/octet-stream
Header 3:
  EndHeader:
    HeaderToken: EndOfHeaders(0x00)

Binary Serialization Format
  SerializationHeaderRecord:
    BinaryHeaderEnum: SerializedStreamHeader (0x00)
    TopId: 1 (0x1)
    HeaderId: -1 (0xFFFFFFFF)
    MajorVersion: 1 (0x1)
    MinorVersion: 0 (0x0)
  BinaryMethodCall:
    BinaryHeaderEnum: BinaryMethodCall (0x15)
    MessageEnum: 00000012
    NoArgs: (.....0)
    ArgsInline: (.....0.)
    ArgsIsArray: (.....1..)
    ArgsInArray: (.....0...)
    NoContext: (.....1....)
    ContextInline: (.....0.....)
    ContextInArray: (.....0.....)
    MethodSignatureInArray: (.....0.....)
    PropertyInArray: (.....0.....)
    NoReturnValue: (.....0.....)
    ReturnValueVoid: (.....0.....)
    ReturnValueInline: (.....0.....)
    ReturnValueInArray: (.....0.....)
    ExceptionInArray: (.....0.....)
    Reserved: (00000000000000000000.....)
  MethodName:
    PrimitiveTypeEnum: String (0x12)
    Data: Activate
  TypeName:
    PrimitiveTypeEnum: String (0x12)
    Data: System.Runtime.Remoting.Activation.IActivator,
      mscorlib, Version=2.0.0.0, Culture=neutral,
      PublicKeyToken=b77a5c561934e089
  ArgsCount: 0 (0x0)

CallArray:
  ArraySingleObject:
    ObjectId: 1 (0x1)
    Length: 1 (0x1)
  MemberReference:
    IdRef: 2
    SystemClassWithMembersAndTypes:
      BinaryHeaderEnum: SystemClassWithMembersAndTypes (0x04)
      ObjectId: 2
      Name: System.Runtime.Remoting.Messaging.ConstructionCall
      NumMembers: 11 (0x0B)
      MemberNames:
        Data: __Uri

```

```

MemberNames:
  Data: __MethodName
MemberNames:
  Data: __MethodSignature
MemberNames:
  Data: __TypeName
MemberNames:
  Data: __Args
MemberNames:
  Data: __CallContext
MemberNames:
  Data: __CallSiteActivationAttributes
MemberNames:
  Data: __ActivationType
MemberNames:
  Data: __ContextProperties
MemberNames:
  Data: __Activator
MemberNames:
  Data: __ActivationTypeName
BinaryTypeEnumA:
  Object (0x02)
  String (0x01)
  SystemClass (0x03)
  String (0x01)
  ObjectArray (0x05)
  Object (0x02)
  Object (0x02)
  Object (0x02)
  SystemClass (0x03)
  SystemClass (0x03)
  String (0x01)
AdditionalTypeInfoArray:
  SystemClass:
    Length: 13 (0x0D)
    Data: System.Type[]
  SystemClass:
    Length: 28 (0x1C)
    Data: System.Collections.ArrayList
  SystemClass:
    Length: 56 (0x38)
    Data: System.Runtime.Remoting.Activation.
      ContextLevelActivator
ObjectNull:
  BinaryHeaderEnum: ObjectNull (0x0A)
BinaryObjectString:
  BinaryHeaderEnum: BinaryObjectString (0x06)
  ObjectId: 3 (0x03)
  Length: 5 (0x05)
  Value: .ctor
MemberReference:
  BinaryHeaderEnum: MemberReference (0x09)
  IdRef: 4 (0x04)
BinaryObjectString:
  BinaryHeaderEnum: BinaryObjectString (0x06)
  ObjectId: 5 (0x05)
  Length: 111 (0x06F)
  Value: DOJRemotingMetadata.MyServer, DOJRemotingMetadata,
    Version=1.0.2616.21414, Culture=neutral,

```

```

        PublicKeyToken=null
MemberReference:
    BinaryHeaderEnum: MemberReference (0x09)
    IdRef: 6 (0x06)
ObjectNull:
    BinaryHeaderEnum: ObjectNull (0x0A)
ObjectNull:
    BinaryHeaderEnum: ObjectNull (0x0A)
ObjectNull:
    BinaryHeaderEnum: ObjectNull (0x0A)
MemberReference:
    BinaryHeaderEnum: MemberReference (0x09)
    IdRef: 7 (0x07)
MemberReference:
    BinaryHeaderEnum: MemberReference (0x09)
    IdRef: 8 (0x08)
MemberReference:
    BinaryHeaderEnum: MemberReference (0x09)
    IdRef: 5 (0x05)
BinaryArray:
    BinaryHeaderEnum: BinaryArray (0x07)
    ObjectId: 4 (0x04)
    BinaryArrayTypeEnum: 0 (0x0)
    Rank: 1 (0x1)
    LengthA: 0 (0x0)
    BinaryTypeEnumA:
        ObjectUrt (0x03)
        Length: 11 (0x0B)
        Value: System.Type
SystemClassWithMembersAndTypes:
    BinaryHeaderEnum: SystemClassWithMembersAndTypes (0x04)
    ObjectId: 7 (0x07)
    Name: System.Collections.ArrayList
    NumMembers: 3 (0x03)
        MemberNames:
            Data: _items
        MemberNames:
            Data: _size
        MemberNames:
            Data: _version
    BinaryTypeEnumA:
        ObjectArray (0x05)
        Primitive (0x00)
        Primitive (0x00)
    Additional Type Information:
        Primitive Type: Int32 (0x08)
        Primitive Type: Int32 (0x08)
Object Information Array:
    MemberReference:
        BinaryHeaderEnum: MemberReference (0x09)
        IdRef: 10 (0x0A)
    MemberPrimitiveUnTyped:
        Value: 0 (0x00)
    MemberPrimitiveUnTyped:
        Value: 0 (0x00)
SystemClassWithMembersAndTypes:
    BinaryHeaderEnum: SystemClassWithMembersAndTypes (0x04)
    ObjectId: 8
    Name: System.Runtime.Remoting.Activation.ContextLevelActivator

```

```

NumMembers: 1 (0x01)
  MemberNames:
    Data: m_NextActivator
BinaryTypeEnumA:
  ObjectUrt (0x03)
Additional Type Information:
  ObjectUrt:
    Length: 61 (0x3D)
    Data: System.Runtime.Remoting.Activation.
      ConstructionLevelActivator
MemberReference:
  BinaryHeaderEnum: MemberReference (0x09)
  IdRef: 11 (0x0B)
ArraySingleObject:
  BinaryHeaderEnum: ArraySingleObject (0x10)
  ObjectId: 10 (0x0A)
  Length: 0 (0x00)
BinaryObjectWithMapTyped:
  BinaryHeaderEnum: SystemClassWithMembersAndTypes (0x04)
  ObjectId: 11
  Name: System.Runtime.Remoting.Activation.
    ConstructionLevelActivator
  NumMembers: 0 (0x00)
MessageEnd:
  BinaryHeaderEnum: MessageEnd (0x0B)

```

#### 4.1.2 Activation Response Message

The server sends back the ObjRef (as specified in [\[MS-NRTP\]](#) section 2.2.2.1) of the activated object as part of the [ConstructionResponse](#) instance that is the Return Value. The ObjRef that is passed contains the following information.

Data type	Description
URI	/8dabf534_bf0d_4429_a333_d2216f111d90/iLImNXo5ioIkQjrVqx+SkAtj_1.rem
TypeInfo	Type information for the object
ChannelInfo	Contains information about two channels: <ul style="list-style-type: none"> <li>▪ CrossAppDomainData</li> <li>▪ ChannelDataStore [tcp://172.30.184.185:8080]</li> </ul>

The ObjRef in this sample indicates that the Server Object activated is hosted on the relative address of "8dabf534\_bf0d\_4429\_a333\_d2216f111d90/iLImNXo5ioIkQjrVqx+SkAtj\_1.rem". CrossAppDomainData is an intraprocess channel and can be ignored. The ObjRef can be accessed via a TCP connection to port 8080 on IP address "172.30.184.185".

```

ProtocolIdentifier: 0x54454E2E
MajorVersion: 1 (0x1)
MinorVersion: 0 (0x0)
Operation: Response (0x02)
Content Length
  Content Distribution : Content Length (0x00)

```

```

Content Length: 1269 (0x04F5)
Header 1:
  EndHeader:
    HeaderToken: EndOfHeaders(0x00)
Binary Serialization Format
  SerializationHeaderRecord:
    BinaryHeaderEnum: SerializedStreamHeader (0x00)
    TopId: 1 (0x1)
    HeaderId: -1 (0xFFFFFFFF)
    MajorVersion: 1 (0x1)
    MinorVersion: 0 (0x0)
  BinaryMethodReturn:
    BinaryHeaderEnum: BinaryMethodReturn (0x16)
    MessageEnum: 00001011
      NoArgs: (.....1)
      ArgsInline: (.....0.)
      ArgsIsArray: (.....0..)
      ArgsInArray: (.....0...)
      NoContext: (.....1....)
      ContextInline: (.....0.....)
      ContextInArray: (.....0.....)
      MethodSignatureInArray: (.....0.....)
      PropertyInArray: (.....0.....)
      NoReturnValue: (.....0.....)
      ReturnValueVoid: (.....0.....)
      ReturnValueInline: (.....0.....)
      ReturnValueInArray: (.....1.....)
      ExceptionInArray: (.....0.....)
      Reserved: (00000000000000000000.....)
  CallArray:
    ArraySingleObject:
      BinaryHeaderEnum: ArraySingleObject (0x10)
      ObjectId: 1 (0x1)
      Length: 1 (0x1)
    MemberReference:
      IdRef: 2
    SystemClassWithMembersAndTypes:
      BinaryHeaderEnum: SystemClassWithMembersAndTypes (0x04)
      ObjectId: 2
      Name: System.Runtime.Remoting.Messaging.ConstructionResponse
      NumMembers: 6 (0x06)
      MemberNames:
        Data: __Uri
      MemberNames:
        Data: __MethodName
      MemberNames:
        Data: __TypeName
      MemberNames:
        Data: __Return
      MemberNames:
        Data: __OutArgs
      MemberNames:
        Data: __CallContext
    BinaryTypeEnumA:
      Object (0x02)
      String (0x01)
      String (0x01)
      SystemClass (0x03)
      ObjectArray (0x05)

```



```

    Object (0x02)
  AdditionalTypeInfoArray:
    SystemClass:
      Length: 30 (0x1E)
      Data: System.Runtime.Remoting.ObjRef
ObjectNull:
  BinaryHeaderEnum: ObjectNull (0x0A)
BinaryObjectString:
  BinaryHeaderEnum: BinaryObjectString (0x06)
  ObjectId: 3 (0x03)
  Length: 5 (0x05)
  Value: .ctor
BinaryObjectString:
  BinaryHeaderEnum: BinaryObjectString (0x06)
  ObjectId: 4 (0x03)
  Length: 111 (0x6F)
  Value: DOJRemotingMetadata.MyServer, DOJRemotingMetadata,
    Version=1.0.2616.21414, Culture=neutral,
    PublicKeyToken=null
MemberReference:
  BinaryHeaderEnum: MemberReference (0x09)
  IdRef: 5 (0x05)
MemberReference:
  BinaryHeaderEnum: MemberReference (0x09)
  IdRef: 6 (0x06)
ObjectNull:
  BinaryHeaderEnum: ObjectNull (0x0A)
SystemClassWithMembersAndTypes:
  BinaryHeaderEnum: SystemClassWithMembersAndTypes (0x04)
  ObjectId: 5
  Name: System.Runtime.Remoting.ObjRef
  NumMembers: 6 (0x06)
  MemberNames:
    Data: uri
  MemberNames:
    Data: objrefFlags
  MemberNames:
    Data: typeInfo
  MemberNames:
    Data: envoyInfo
  MemberNames:
    Data: channelInfo
  MemberNames:
    Data: fIsMarshalled
BinaryTypeEnumA:
  String (0x01)
  PrimitiveTypeEnum (0x00)
  SystemClass (0x03)
  SystemClass (0x03)
  SystemClass (0x03)
  PrimitiveTypeEnum (0x00)
AdditionalTypeInfoArray:
  SystemClass:
    Length: 32 (0x20)
    Data: System.Runtime.Remoting.TypeInfo
  SystemClass:
    Length: 34 (0x22)
    Data: System.Runtime.Remoting.IEnvoyInfo
  SystemClass:

```

```

        Length: 34 (0x22)
        Data: System.Runtime.Remoting.ChannelInfo
BinaryObjectString:
  BinaryHeaderEnum: BinaryObjectString (0x06)
  ObjectId: 7 (0x07)
  Length: 68 (0x44)
  Value: /8dabf534_bf0d_4429_a333_d2216f111d90/
        iLImNXo5ioIkQjrVqx+SkAtj_1.rem
MemberPrimitiveUnTyped:
  BinaryTypeEnum: Primitive (0x00)
  Int32Value: 0 (0x00)
MemberReference:
  BinaryHeaderEnum: MemberReference (0x09)
  IdRef: 8 (0x08)
ObjectNull:
  BinaryHeaderEnum: ObjectNull (0x0A)
MemberReference:
  BinaryHeaderEnum: MemberReference (0x09)
  IdRef: 9 (0x09)
MemberPrimitiveUnTyped:
  Int32Value: 0 (0x00)
ArraySingleObject:
  BinaryHeaderEnum: ArraySingleObject (0x10)
  ObjectId: 6 (0x06)
  Length: 0 (0x0)
SystemClassWithMembersAndTypes:
  BinaryHeaderEnum: SystemClassWithMembersAndTypes (0x04)
  ObjectId: 8 (0x08)
  Name: System.Runtime.Remoting.TypeInfo
  NumMembers: 3 (0x03)
    MemberNames:
      Data: serverType
    MemberNames:
      Data: serverHierarchy
    MemberNames:
      Data: interfacesImplemented
  BinaryTypeEnumA:
    String (0x01)
    StringArray (0x06)
    StringArray (0x06)
BinaryObjectString:
  BinaryHeaderEnum: BinaryObjectString (0x06)
  ObjectId: 10 (0x0A)
  Length: 111 (0x6F)
  Value: DOJRemotingMetadata.MyServer, DOJRemotingMetadata,
        Version=1.0.2616.21414, Culture=neutral,
        PublicKeyToken=null
BinaryObjectWithMapTyped:
  BinaryHeaderEnum: SystemClassWithMembersAndTypes (0x04)
  ObjectId: 9 (0x09)
  Name: System.Runtime.Remoting.ChannelInfo
  NumMembers: 1 (0x01)
    MemberNames:
      Data: channelData
  BinaryTypeEnumA:
    ObjectArray (0x05)
MemberReference:
  BinaryHeaderEnum: MemberReference (0x09)
  IdRef: 11 (0x0B)

```

```

ArraySingleObject:
  BinaryHeaderEnum: ArraySingleObject (0x10)
  ObjectId: 11 (0x0B)
  Length: 2 (0x2)
MemberReference:
  BinaryHeaderEnum: MemberReference (0x09)
  IdRef: 12 (0x0C)
MemberReference:
  BinaryHeaderEnum: MemberReference (0x09)
  IdRef: 13 (0x0D)
BinaryObjectWithMapTyped:
  BinaryHeaderEnum: SystemClassWithMembersAndTypes (0x04)
  ObjectId: 12 (0x0C)
  Name: System.Runtime.Remoting.Channels.CrossAppDomainData
  NumMembers: 3 (0x03)
  MemberNames:
    Data: _ContextID
  MemberNames:
    Data: _DomainID
  MemberNames:
    Data: _processGuid
  BinaryTypeEnumA:
    PrimitiveTypeEnum (0x00)
    PrimitiveTypeEnum (0x00)
    String (0x01)
  AdditionalTypeInfoArray:
    PrimitiveTypeEnum: Int32 (0x08)
    PrimitiveTypeEnum: Int32 (0x08)
MemberPrimitiveUnTyped:
  BinaryTypeEnum: Primitive (0x00)
  Int32Value: 1363808 (0x14CF60)
MemberPrimitiveUnTyped:
  BinaryTypeEnum: Primitive (0x00)
  Int32Value: 1 (0x01)
BinaryObjectString:
  BinaryHeaderEnum: BinaryObjectString (0x06)
  ObjectId: 14 (0x0E)
  Length: 111 (0x6F)
  Value: ac118c52_2f96_4034_9af2_e924215f659b
SystemClassWithMembersAndTypes:
  BinaryHeaderEnum: BinaryObjectWithMapTyped (0x04)
  ObjectId: 13 (0x0D)
  Name: System.Runtime.Remoting.Channels.ChannelDataStore
  NumMembers: 2 (0x02)
  MemberNames:
    Data: _channelURIs
  MemberNames:
    Data: _extraData
  BinaryTypeEnumA:
    StringArray (0x06)
    ObjectUrt (0x03)
  AdditionalTypeInfoArray:
    ObjectUrt:
      Length: 36 (0x24)
      Data: System.Collections.DictionaryEntry[]
MemberReference:
  BinaryHeaderEnum: MemberReference (0x09)
  IdRef: 15 (0x0F)
ObjectNull:

```

```
BinaryHeaderEnum: ObjectNull (0x0A)
ArraySingleObject:
  BinaryHeaderEnum: ArraySingleObject (0x10)
  ObjectId: 15 (0x0F)
  Length: 1 (0x1)
BinaryObjectString:
  BinaryHeaderEnum: BinaryObjectString (0x06)
  ObjectId: 16 (0x10)
  Length: 25 (0x19)
  Value: tcp://172.30.184.185:8080
MessageEnd:
  BinaryHeaderEnum: MessageEnd (0x0B)
```

## 4.2 Registering a Sponsor for a CAO Object

This sample shows the sequence of steps involved when the client registers a Sponsor to manage the lifetime of the remote CAO Server Object.

1. The client creates a CAO by sending an activation request to the RemoteActivationService, and receives the Proxy to the Server Object in the activation response.
2. After the client has the Proxy, it retrieves the Proxy to the CAO's Lease Object by calling the [GetLifetimeService](#) method.
3. It then registers a Sponsor object by calling the [Register](#) method.
4. When the TTL of the Server Object expires, the [Renewal](#) method is called.

The sequence diagram for the above sample is shown in the following figure.

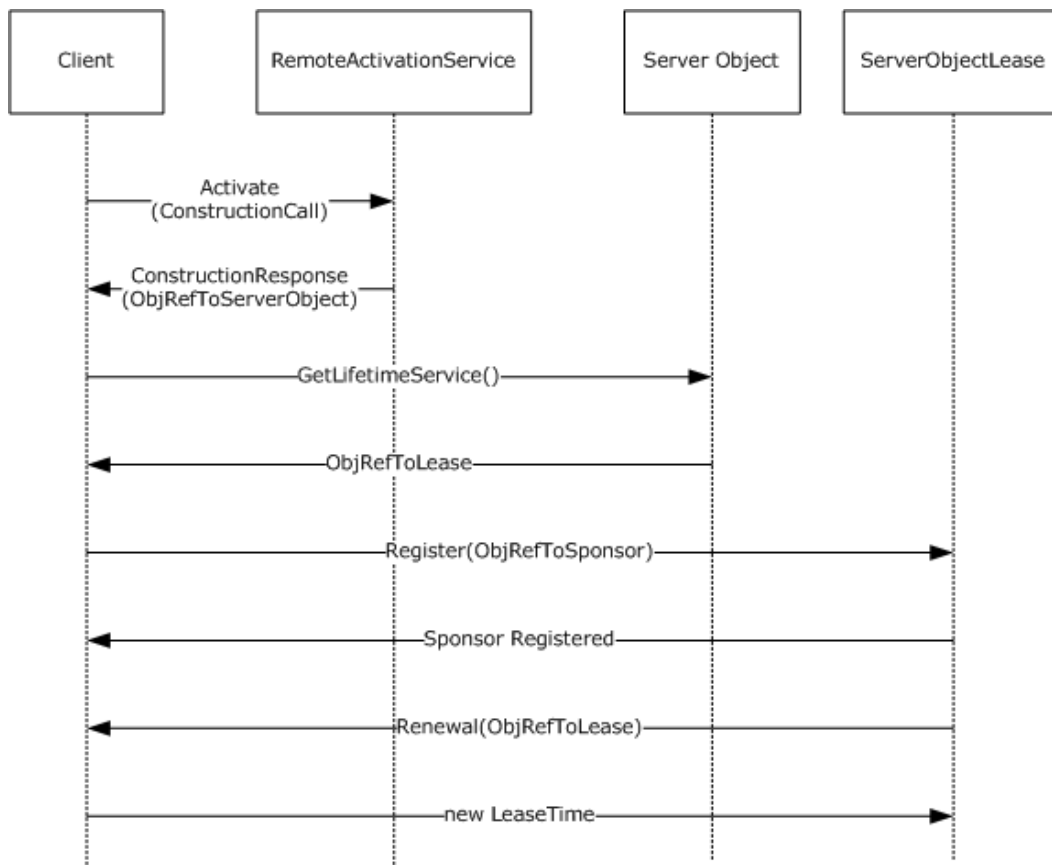
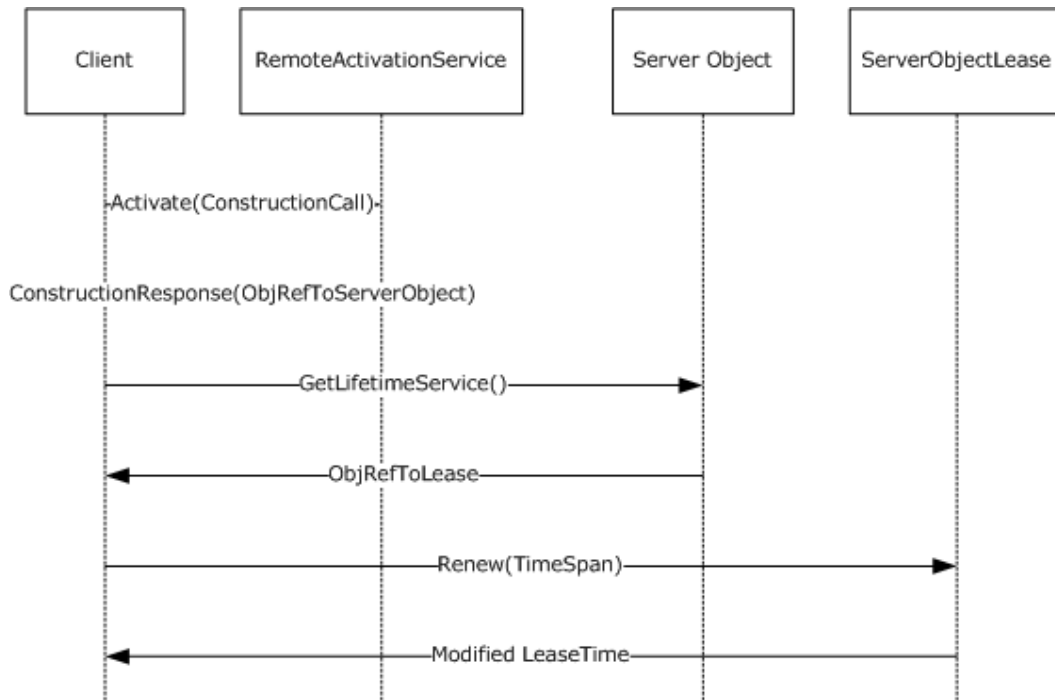

**Figure 9: Registering a Sponsor**

### 4.3 Incrementing TTL of a Server Object

The client does not need to register a Sponsor to manage the lifetime of the remote Server Object. Instead, the client can extend the TTL of the associated Server Object by using the [Renew](#) method of the Lease Object.

The following diagram illustrates the process of extending a lease by using the **Renew** method.



**Figure 10: Extending a lease TTL**

## 5 Security

The following sections specify security considerations for implementers of the .NET Remoting: Lifetime Services Extension.

### 5.1 Security Considerations for Implementers

This protocol allows a client to request that the server activate a local object by name. This could potentially result in the client being able to run arbitrary code on the server.

Implementers can safeguard against this threat by restricting the set of Remoting Types a client can request to those that are known to be safe—for example, by maintaining a list of allowable Remoting Types for the application to configure.

### 5.2 Index of Security Parameters

This protocol has no security parameters.

## 6 Appendix A: Full Definitions

For ease of implementation, the complete definitions of Remoting Types and Server Interfaces are provided below.

The following **Primitive Types** are defined in [\[MS-NRTP\]](#) section 2.2.5 and in the [Windows Protocols Master Glossary](#) ([MS-GLOS]):

- Int32
- Object
- String
- TimeSpan

The remainder of this appendix lists the definitions of the elements that constitute the .NET Remoting: Lifetime Services Extension.

```
namespace System.Collections
{
    class ArrayList
    {
        System.Object[] _items;
        Int32           _size;
        Int32           _version;
    }
}

namespace System.Runtime.Remoting.Lifetime
{
    interface ILease
    {
        TimeSpan Renew(TimeSpan renewalTime);
        void Register(System.Runtime.Remoting.ISponsor sponsor);
        void Register(System.Runtime.Remoting.ISponsor sponsor,
                      TimeSpan renewalTime);
        void Unregister(System.Runtime.Remoting.ISponsor sponsor);
        TimeSpan get_InitialLeaseTime();
        void set_InitialLeaseTime(TimeSpan value);
        TimeSpan get_RenewOnCallTime();
        void set_RenewOnCallTime(TimeSpan value);
        TimeSpan get_SponsorshipTimeout();
        void set_SponsorshipTimeout(System.TimeSpan value);
        TimeSpan get_CurrentLeaseTime();
        System.Runtime.Remoting.LeaseState get_CurrentState();
    }

    interface ISponsor
    {
        TimeSpan Renewal();
    }

    enum LeaseState : Int32
    {
        Null = 0,
        Initial = 1,
        Active = 2,
    }
}
```



```

        Renewing = 3,
        Expired = 4
    }
}

namespace System.Runtime.Remoting.Messaging
{
    class ConstructionCall
    {
        String                __Uri;
        String                __MethodName;
        System.Type[]        __MethodSignature;
        String                __TypeName;
        System.Object[]      __Args;
        System.Object        __CallContext;
        System.Type          __ActivationType;
        System.Object        __Activator;
        String                __ActivationTypeName;
        System.Collections.ArrayList __ContextProperties;
        System.Object[]      __CallSiteActivationAttributes;
    }

    class ConstructionResponse
    {
        String                __Uri;
        String                __MethodName;
        String                __TypeName;
        System.Object        __Return;
        System.Object[]      __OutArgs;
        System.Object        __CallContext;
    }
}

namespace System.Runtime.Remoting.Activation
{
    interface IActivator
    {
        System.Runtime.Remoting.Messaging.ConstructionResponse
        Activate(
            System.Runtime.Remoting.Messaging.ConstructionCall callMessage);
    }
}

namespace System
{
    interface MarshalByRefObject
    {
        System.Runtime.Remoting.ILease GetLifetimeService();
    }

    interface Object
    {
        void FieldGetter(String typeName, String fieldName, ref System.Object val);
        void FieldSetter(String typeName, String fieldName, System.Object val);
    }
}

```

## 7 Appendix B: Product Behavior

This document specifies version-specific details in the Microsoft .NET Framework. For information about which versions of .NET Framework are available in each released Windows product or as supplemental software, see [.NET Framework](#).

The information in this specification is applicable to the following Microsoft products or supplemental software. References to product versions include released service packs:

- Microsoft .NET Framework 1.0
- Microsoft .NET Framework 2.0
- Microsoft .NET Framework 3.0
- Microsoft .NET Framework 3.5
- Microsoft .NET Framework 4.0
- Microsoft .NET Framework 4.5

Exceptions, if any, are noted below. If a service pack or Quick Fix Engineering (QFE) number appears with the product version, behavior changed in that service pack or QFE. The new behavior also applies to subsequent service packs of the product unless otherwise specified. If a product edition appears with the product version, behavior is different in that product edition.

Unless otherwise specified, any statement of optional behavior in this specification that is prescribed using the terms SHOULD or SHOULD NOT implies product behavior in accordance with the SHOULD or SHOULD NOT prescription. Unless otherwise specified, the term MAY implies that the product does not follow the prescription.

[<1> Section 2.2.1:](#) Windows uses this value locally to contain a count of modifications to `_items`.

[<2> Section 2.2.1:](#) Windows writes a Null Object for any elements of the `_items` Array with an index greater than or equal to the value of the `__size` field.

[<3> Section 2.2.2:](#) Windows sets the value of this field to Null Object.

[<4> Section 2.2.2:](#) Windows uses this field locally to hold implementation-specific objects. Windows provides an extension mechanism for the higher layer to provide the value of this field. The default value of this field is an instance of the [ContextLevelActivator \(section 2.2.3\)](#) Class.

[<5> Section 2.2.2:](#) Windows provides an extension mechanism for the higher layer to associate a collection of values with a Server Type that is activated by the client.

[<6> Section 2.2.2:](#) Windows provides an extension mechanism for the higher layer to associate a collection of values with a Server Type that is activated by the client.

[<7> Section 2.2.5:](#) Windows sets the value of this field to Null Object.

[<8> Section 3:](#) In Windows, the higher-layer protocol can provide an implementation of [ISponsor](#) to participate in the lifetime management of the Server Object.

[<9> Section 3.1.4.1:](#) Windows determines the Server Type in the following ways:

- If the `__ActivationType` field is not a Null Object, the value of the `__ActivationType` field is the Server Type.

- If the **\_\_ActivationType** field is a Null Object, the **\_\_ActivationTypeName** field is used to identify the Server Type.

Windows uses the constructor specified by the **\_\_MethodName** and **\_\_MethodSignature** fields to construct a Server Object from the Server Type. Windows throws a RemotingException (specified in [\[MS-NRTP\]](#) section 2.2.2.9) in the following cases:

- The specified Server Type is not available.
- The specified constructor is not available.
- The values in the **\_\_Args** field cannot be used to call the specified constructor.

[<10> Section 3.3.3:](#) Windows allows InitialLeaseTime, RenewOnCallTime and SponsorshipTimeout values to be overridden by the higher layer. The default values are as follows:

Property	Value
InitialLeaseTime	5 minutes
RenewOnCallTime	2 minutes
SponsorshipTimeout	2 minutes

In the case of a Marshaled Server Object, Windows sets the MSO's TTL to double the InitialLeaseTime configured by the higher layer. So, if the InitialLeaseTime was configured as 5 minutes (the default), the MSO's initial TTL would be 10 minutes.

[<11> Section 3.3.6.3:](#) Windows does not modify the Lease when a Server Object is unmarshaled. The Lease will continue its lifetime as specified in [Lease TTL Timer \(section 3.3.5.1\)](#), expiring when the [Lease TTL Timer](#) fires and all registered Sponsor objects fail to respond or return 0.

## 8 Change Tracking

No table of changes is available. The document is either new or has had no changes since its last release.

## 9 Index

### A

Abstract data model  
[IActivator](#) 20  
[ILease](#) 24  
[ISponsor](#) 32  
[MarshalByRefObject](#) 23  
[Activate - IActivator](#) 21  
[Activation Request message](#) 35  
[Activation Response message](#) 39  
[Applicability](#) 13  
[ArrayList](#) 15

### C

[CAO Activation Request/Response message](#)  
  [example](#) 35  
[CAO object - registering a sponsor for](#) 44  
[Capability negotiation](#) 13  
[Change tracking](#) 52  
[Client activation](#) 9  
[Common data types](#) 15  
[ConstructionCall](#) 15  
[ConstructionLevelActivator](#) 17  
[ConstructionResponse](#) 17  
[ContextLevelActivator](#) 16  
[Conventions](#) 12

### D

Data model - abstract  
[IActivator](#) 20  
[ILease](#) 24  
[ISponsor](#) 32  
[MarshalByRefObject](#) 23  
[Data types](#) 15

### E

Examples  
[CAO Activation Request/Response message](#)  
  [example](#) 35  
  [overview](#) 35

### F

[FieldGetter](#) 33  
[Fields - vendor-extensible](#) 14  
[FieldSetter](#) 34  
[Full definitions](#) 48

### G

[get\\_CurrentLeaseTime](#) 30  
[get\\_CurrentState](#) 30  
[get\\_InitialLeaseTime](#) 28  
[get\\_RenewOnCallTime](#) 29  
[get\\_SponsorshipTimeout](#) 29  
[GetLifetimeService](#) 23

[Glossary](#) 7

### I

IActivator  
[abstract data model](#) 20  
[Activate](#) 21  
[initialization](#) 21  
[local events](#) 22  
[message processing](#) 21  
[overview](#) 20  
[sequencing rules](#) 21  
[timer events](#) 22  
[timers](#) 21  
ILease  
[abstract data model](#) 24  
[initialization](#) 24  
[local events](#) 31  
[message processing](#) 24  
[overview](#) 24  
[sequencing rules](#) 24  
[timer events](#) 30  
[timers](#) 24  
[Implementer - security considerations](#) 47  
[Index of security parameters](#) 47  
[Informative references](#) 8  
Initialization  
[IActivator](#) 21  
[ILease](#) 24  
[ISponsor](#) 32  
[MarshalByRefObject](#) 23  
[Introduction](#) 7  
ISponsor  
[abstract data model](#) 32  
[initialization](#) 32  
[local events](#) 33  
[message processing](#) 32  
[overview](#) 32  
[sequencing rules](#) 32  
[timer events](#) 33  
[timers](#) 32

### L

[Lease TTL timer](#) 30  
[LeaseState](#) 18  
[Lifetime management](#) 9  
Local events  
[IActivator](#) 22  
[ILease](#) 31  
[ISponsor](#) 33  
[MarshalByRefObject](#) 23

### M

MarshalByRefObject  
[abstract data model](#) 23  
[initialization](#) 23  
[local events](#) 23

- [message processing](#) 23
- [overview](#) 22
- [sequencing rules](#) 23
- [timer events](#) 23
- [timers](#) 23
- Message processing
  - [IActivator](#) 21
  - [ILease](#) 24
  - [ISponsor](#) 32
  - [MarshalByRefObject](#) 23
- Messages
  - [data types](#) 15
  - [overview](#) 15
  - [transport](#) 15

## N

- [Normative references](#) 8
- [Notational conventions](#) 12

## O

- [Overview \(synopsis\)](#) 8

## P

- [Parameters - security index](#) 47
- [Preconditions](#) 13
- [Prerequisites](#) 13
- [Product behavior](#) 50

## R

- References
  - [informative](#) 8
  - [normative](#) 8
- [Register](#) 27
- [Register\(Overload\)](#) 27
- [Relationship to other protocols](#) 13
- [Renew](#) 26
- [Renewal](#) 32

## S

- Security
  - [implementer considerations](#) 47
  - [overview](#) 47
  - [parameter index](#) 47
- Sequencing rules
  - [IActivator](#) 21
  - [ILease](#) 24
  - [ISponsor](#) 32
  - [MarshalByRefObject](#) 23
- Server
  - [binding to objects](#) 31
  - [incrementing TTL of](#) 45
  - [set\\_InitialLeaseTime](#) 28
  - [set\\_RenewOnCallTime](#) 29
  - [set\\_SponsorshipTimeout](#) 30
  - [Sponsor](#) 10
  - [Standards assignments](#) 14

## T

- Timer events
  - [IActivator](#) 22
  - [ILease](#) 30
  - [ISponsor](#) 33
  - [MarshalByRefObject](#) 23
- Timers
  - [IActivator](#) 21
  - [ILease](#) 24
  - [ISponsor](#) 32
  - [MarshalByRefObject](#) 23
- [Tracking changes](#) 52
- [Transport](#) 15
- [TTL - incrementing](#) 45

## U

- [Unregister](#) 28

## V

- [Vendor-extensible fields](#) 14
- [Versioning](#) 13