

[MS-DTCO-Diff]:

MSDTC Connection Manager: OleTx Transaction Protocol

Intellectual Property Rights Notice for Open Specifications Documentation

- **Technical Documentation.** Microsoft publishes Open Specifications documentation (“this documentation”) for protocols, file formats, data portability, computer languages, and standards support. Additionally, overview documents cover inter-protocol relationships and interactions.
- **Copyrights.** This documentation is covered by Microsoft copyrights. Regardless of any other terms that are contained in the terms of use for the Microsoft website that hosts this documentation, you can make copies of it in order to develop implementations of the technologies that are described in this documentation and can distribute portions of it in your implementations that use these technologies or in your documentation as necessary to properly document the implementation. You can also distribute in your implementation, with or without modification, any schemas, IDLs, or code samples that are included in the documentation. This permission also applies to any documents that are referenced in the Open Specifications documentation.
- **No Trade Secrets.** Microsoft does not claim any trade secret rights in this documentation.
- **Patents.** Microsoft has patents that might cover your implementations of the technologies described in the Open Specifications documentation. Neither this notice nor Microsoft's delivery of this documentation grants any licenses under those patents or any other Microsoft patents. However, a given Open Specifications document might be covered by the Microsoft [Open Specifications Promise](#) or the [Microsoft Community Promise](#). If you would prefer a written license, or if the technologies described in this documentation are not covered by the Open Specifications Promise or Community Promise, as applicable, patent licenses are available by contacting iplg@microsoft.com.
- **License Programs.** To see all of the protocols in scope under a specific license program and the associated patents, visit the [Patent Map](#).
- **Trademarks.** The names of companies and products contained in this documentation might be covered by trademarks or similar intellectual property rights. This notice does not grant any licenses under those rights. For a list of Microsoft trademarks, visit www.microsoft.com/trademarks.
- **Fictitious Names.** The example companies, organizations, products, domain names, email addresses, logos, people, places, and events that are depicted in this documentation are fictitious. No association with any real company, organization, product, domain name, email address, logo, person, place, or event is intended or should be inferred.

Reservation of Rights. All other rights are reserved, and this notice does not grant any rights other than as specifically described above, whether by implication, estoppel, or otherwise.

Tools. The Open Specifications documentation does not require the use of Microsoft programming tools or programming environments in order for you to develop an implementation. If you have access to Microsoft programming tools and environments, you are free to take advantage of them. Certain Open Specifications documents are intended for use in conjunction with publicly available standards specifications and network programming art and, as such, assume that the reader either is familiar with the aforementioned material or has immediate access to it.

Support. For questions and support, please contact dochelp@microsoft.com.

Revision Summary

Date	Revision History	Revision Class	Comments
4/3/2007	0.01	New	Version 0.01 release
7/3/2007	1.0	Major	MLonghorn+90
7/20/2007	1.1	Minor	Minor work due to other OleTx protocols shipping.
8/10/2007	1.1.1	Editorial	Changed language and formatting in the technical content.
9/28/2007	1.2	Minor	Clarified the meaning of the technical content.
10/23/2007	2.0	Major	Updated and revised the technical content.
11/30/2007	2.1	Minor	Clarified the meaning of the technical content.
1/25/2008	2.1.1	Editorial	Changed language and formatting in the technical content.
3/14/2008	2.1.2	Editorial	Changed language and formatting in the technical content.
5/16/2008	2.1.3	Editorial	Changed language and formatting in the technical content.
6/20/2008	3.0	Major	Updated and revised the technical content.
7/25/2008	3.1	Minor	Clarified the meaning of the technical content.
8/29/2008	4.0	Major	Updated and revised the technical content.
10/24/2008	4.1	Minor	Clarified the meaning of the technical content.
12/5/2008	5.0	Major	Updated and revised the technical content.
1/16/2009	6.0	Major	Updated and revised the technical content.
2/27/2009	6.1	Minor	Clarified the meaning of the technical content.
4/10/2009	7.0	Major	Updated and revised the technical content.
5/22/2009	8.0	Major	Updated and revised the technical content.
7/2/2009	9.0	Major	Updated and revised the technical content.
8/14/2009	10.0	Major	Updated and revised the technical content.
9/25/2009	11.0	Major	Updated and revised the technical content.
11/6/2009	12.0	Major	Updated and revised the technical content.
12/18/2009	13.0	Major	Updated and revised the technical content.
1/29/2010	14.0	Major	Updated and revised the technical content.
3/12/2010	15.0	Major	Updated and revised the technical content.
4/23/2010	15.1	Minor	Clarified the meaning of the technical content.
6/4/2010	16.0	Major	Updated and revised the technical content.
7/16/2010	17.0	Major	Updated and revised the technical content.
8/27/2010	18.0	Major	Updated and revised the technical content.

Date	Revision History	Revision Class	Comments
10/8/2010	18.0	None	No changes to the meaning, language, or formatting of the technical content.
11/19/2010	19.0	Major	Updated and revised the technical content.
1/7/2011	20.0	Major	Updated and revised the technical content.
2/11/2011	21.0	Major	Updated and revised the technical content.
3/25/2011	22.0	Major	Updated and revised the technical content.
5/6/2011	22.0	None	No changes to the meaning, language, or formatting of the technical content.
6/17/2011	22.1	Minor	Clarified the meaning of the technical content.
9/23/2011	22.1	None	No changes to the meaning, language, or formatting of the technical content.
12/16/2011	23.0	Major	Updated and revised the technical content.
3/30/2012	23.0	None	No changes to the meaning, language, or formatting of the technical content.
7/12/2012	23.1	Minor	Clarified the meaning of the technical content.
10/25/2012	23.1	None	No changes to the meaning, language, or formatting of the technical content.
1/31/2013	23.1	None	No changes to the meaning, language, or formatting of the technical content.
8/8/2013	23.2	Minor	Clarified the meaning of the technical content.
11/14/2013	23.2	None	No changes to the meaning, language, or formatting of the technical content.
2/13/2014	23.2	None	No changes to the meaning, language, or formatting of the technical content.
5/15/2014	23.2	None	No changes to the meaning, language, or formatting of the technical content.
6/30/2015	24.0	Major	Significantly changed the technical content.
10/16/2015	24.0	None	No changes to the meaning, language, or formatting of the technical content.
7/14/2016	24.0	None	No changes to the meaning, language, or formatting of the technical content.
<u>6/1/2017</u>	<u>24.0</u>	<u>None</u>	<u>No changes to the meaning, language, or formatting of the technical content.</u>

Table of Contents

1	Introduction	27
1.1	Glossary	28
1.2	References	32
1.2.1	Normative References	33
1.2.2	Informative References	34
1.3	Overview	34
1.3.1	Transaction Lifetime.....	34
1.3.1.1	Phase Zero.....	35
1.3.1.2	Phase One.....	36
1.3.1.3	Phase Two	38
1.3.2	Additional Considerations.....	39
1.3.2.1	Unilateral Abort	40
1.3.2.2	Single-Phase Commit	40
1.3.3	Transaction Roles	41
1.3.3.1	Application Role	42
1.3.3.2	Resource Manager Role.....	43
1.3.3.3	Transaction Manager Role	43
1.3.3.3.1	Core Transaction Manager Facet.....	45
1.3.3.3.2	Transaction Manager Communication with an Application Facet.....	45
1.3.3.3.3	Transaction Manager Communication with a Resource Manager Facet	46
1.3.3.3.4	Superior Transaction Manager Facet	46
1.3.3.3.5	Subordinate Transaction Manager Facet	46
1.3.4	Transaction Recovery	46
1.3.4.1	Relationship Between Recovery and Durability.....	47
1.3.4.2	Resource Manager Recovery	47
1.3.4.3	Transaction Manager Recovery	48
1.3.5	Transaction Propagation	48
1.3.5.1	Pull Propagation.....	49
1.3.5.2	Push Propagation	50
1.4	Relationship to Other Protocols	51
1.5	Prerequisites/Preconditions	52
1.6	Applicability Statement	52
1.7	Versioning and Capability Negotiation	53
1.7.1	Versioning Mechanisms	53
1.7.2	Versioning Negotiation Mechanisms	53
1.7.3	Capability Negotiation Mechanisms	54
1.8	Vendor-Extensible Fields	54
1.9	Standards Assignments.....	55
2	Messages.....	56
2.1	Transport.....	56
2.1.1	Messages, Connections, and Sessions	56
2.1.2	MS-CMP and MS-CMPO Initialization.....	56
2.1.2.1	Computing a Security Level.....	57
2.1.2.2	Computing Protocol Version Values	57
2.1.2.3	Computing a Name Object	57
2.2	Message Syntax.....	57
2.2.1	Protocol Versioning	57
2.2.1.1	Protocol Version Numbers as a Versioning Mechanism	57
2.2.1.1.1	Version-Specific Aspects of Connection Types Relevant to an Application	58
2.2.1.1.2	Version-Specific Aspects of Connection Types Relevant to a Transaction Manager.....	60
2.2.1.1.3	Version-Specific Aspects of Connection Types Relevant to a Resource Manager.....	60
2.2.2	Structures with Fields Containing Version Numbers as Versioning Mechanism.....	60

2.2.3	Structures with a Format-Specifying Field as Versioning Mechanism.....	61
2.2.4	Common Structures	61
2.2.4.1	MESSAGE_PACKET	61
2.2.4.2	OLETX_TM_ADDR	62
2.2.4.3	OLETX_VARLEN_STRING.....	62
2.2.5	Transaction Propagation Structures.....	63
2.2.5.1	Associate_Msg_Version2	63
2.2.5.2	Associate_Msg_Version3	63
2.2.5.3	NAMEOBJECTBLOB	64
2.2.5.4	Propagation-Token	65
2.2.5.5	SDtcCmEndpointInfoV1.....	66
2.2.5.6	SDtcCmEndpointInfoV2.....	67
2.2.5.7	SOleTxInfoForTip	67
2.2.5.8	SExtendedEndpointInfo.....	68
2.2.5.9	STmToTmProtocol	68
2.2.5.10	STxInfo	69
2.2.5.11	SWhereabouts	70
2.2.6	Transaction Enumerations.....	71
2.2.6.1	Connection Types.....	71
2.2.6.2	TM_Protocol	73
2.2.6.3	TXUSER_ENLISTMENT_PREPAREREQDONE_RESPONSE	73
2.2.6.4	PARTNERTM_PROPAGATE_PREPAREREQDONE_RESPONSE	74
2.2.6.5	TXUSER_VOTER_VOTERREQDONE_RESPONSE.....	74
2.2.6.6	TRUN_TXBEGIN_ERRORS	74
2.2.6.7	TRUN_TXIMPORT_ERRORS.....	75
2.2.6.8	OLETX_ISOLATION_FLAGS.....	75
2.2.6.9	OLETX_ISOLATION_LEVEL	77
2.2.7	Transaction Constants	77
2.2.7.1	GRFRM	77
2.2.7.2	DTCADVCONFIG	77
2.2.7.3	DTCADVCONFIG_OPTIONS.....	77
2.2.8	Connection Types Relevant to Applications.....	80
2.2.8.1	Transaction Initiation and Completion.....	80
2.2.8.1.1	CONNTYPE_TXUSER_BEGINNER	80
2.2.8.1.1.1	TXUSER_BEGINNER_MTAG_ABORT	80
2.2.8.1.1.2	TXUSER_BEGINNER_MTAG_BEGIN	80
2.2.8.1.1.3	TXUSER_BEGINNER_MTAG_BEGIN_LOG_FULL.....	81
2.2.8.1.1.4	TXUSER_BEGINNER_MTAG_BEGIN_NO_MEM	81
2.2.8.1.1.5	TXUSER_BEGINNER_MTAG_BEGUN	82
2.2.8.1.1.6	TXUSER_BEGINNER_MTAG_COMMIT	82
2.2.8.1.1.7	TXUSER_BEGINNER_MTAG_COMMIT_INDOUBT	83
2.2.8.1.1.8	TXUSER_BEGINNER_MTAG_COMMIT_TOO_LATE	83
2.2.8.1.1.9	TXUSER_BEGINNER_MTAG_REQUEST_COMPLETED.....	84
2.2.8.1.2	CONNTYPE_TXUSER_BEGIN2	84
2.2.8.1.2.1	TXUSER_BEGIN2_MTAG_ABORT	84
2.2.8.1.2.2	TXUSER_BEGIN2_MTAG_BEGIN.....	84
2.2.8.1.2.3	TXUSER_BEGIN2_MTAG_COMMIT	85
2.2.8.1.2.4	TXUSER_BEGIN2_MTAG_SINK_BEGUN	86
2.2.8.1.2.5	TXUSER_BEGIN2_MTAG_SINK_ERROR	86
2.2.8.1.2.6	TXUSER_SETTXTIMEOUT_MTAG_REQUEST_COMPLETE.....	87
2.2.8.1.2.7	TXUSER_SETTXTIMEOUT_MTAG_SETTXTIMEOUT	87
2.2.8.1.2.8	TXUSER_SETTXTIMEOUT_MTAG_TOO_LATE	88
2.2.8.1.3	CONNTYPE_TXUSER_PROMOTE	88
2.2.8.1.3.1	TXUSER_BEGINNER_MTAG_PROMOTE	89
2.2.8.2	Transaction Propagation	90
2.2.8.2.1	Pull Propagation	90
2.2.8.2.1.1	CONNTYPE_TXUSER_ASSOCIATE	90
2.2.8.2.1.1.1	TXUSER_ASSOCIATE_MTAG_ASSOCIATE	90

2.2.8.2.1.1.2	TXUSER_ASSOCIATE_MTAG_ASSOCIATED	91
2.2.8.2.1.1.3	TXUSER_ASSOCIATE_MTAG_COMM_FAILED	91
2.2.8.2.1.1.4	TXUSER_ASSOCIATE_MTAG_CREATE_BAD_TMADDR	92
2.2.8.2.1.1.5	TXUSER_ASSOCIATE_MTAG_LOG_FULL_LOCAL	92
2.2.8.2.1.1.6	TXUSER_ASSOCIATE_MTAG_LOG_FULL_REMOTE	92
2.2.8.2.1.1.7	TXUSER_ASSOCIATE_MTAG_NO_MEM_LOCAL	93
2.2.8.2.1.1.8	TXUSER_ASSOCIATE_MTAG_NO_MEM_REMOTE	93
2.2.8.2.1.1.9	TXUSER_ASSOCIATE_MTAG_TOO_LATE	93
2.2.8.2.1.1.10	TXUSER_ASSOCIATE_MTAG_TOO_MANY_LOCAL	94
2.2.8.2.1.1.11	TXUSER_ASSOCIATE_MTAG_TOO_MANY_REMOTE	94
2.2.8.2.1.1.12	TXUSER_ASSOCIATE_MTAG_TX_NOT_FOUND.....	95
2.2.8.2.2	Push Propagation	95
2.2.8.2.2.1	CONNTYPE_TXUSER_EXTENDEDWHEREABOUTS	95
2.2.8.2.2.1.1	TXUSER_EXTENDEDWHEREABOUTS_MTAG_GET	95
2.2.8.2.2.1.2	TXUSER_EXTENDEDWHEREABOUTS_MTAG_GOT	96
2.2.8.2.2.1.3	TXUSER_EXTENDEDWHEREABOUTS_MTAG_NOMEM	96
2.2.8.2.2.2	CONNTYPE_TXUSER_EXPORT	97
2.2.8.2.2.2.1	TXUSER_EXPORT_MTAG_CREATE	97
2.2.8.2.2.2.2	TXUSER_EXPORT_MTAG_CREATE2	97
2.2.8.2.2.2.3	TXUSER_EXPORT_MTAG_CREATE_BAD_TMADDR	98
2.2.8.2.2.2.4	TXUSER_EXPORT_MTAG_CREATE_NET_TX_DISABLED	98
2.2.8.2.2.2.5	TXUSER_EXPORT_MTAG_CREATED	99
2.2.8.2.2.2.6	TXUSER_EXPORT_MTAG_EXPORT	99
2.2.8.2.2.2.7	TXUSER_EXPORT_MTAG_EXPORT_LOG_FULL.....	100
2.2.8.2.2.2.8	TXUSER_EXPORT_MTAG_EXPORT_NO_MEM.....	100
2.2.8.2.2.2.9	TXUSER_EXPORT_MTAG_EXPORT_TOO_LATE	100
2.2.8.2.2.2.10	TXUSER_EXPORT_MTAG_EXPORT_TOO_MANY	101
2.2.8.2.2.2.11	TXUSER_EXPORT_MTAG_EXPORT_TX_NOT_FOUND	101
2.2.8.2.2.2.12	TXUSER_EXPORT_MTAG_EXPORTED	101
2.2.8.2.2.3	CONNTYPE_TXUSER_EXPORT2	102
2.2.8.2.2.3.1	TXUSER_EXPORT_MTAG_EXPORT_COMM_FAILED	102
2.2.8.2.2.4	CONNTYPE_TXUSER_IMPORT	103
2.2.8.2.2.4.1	TXUSER_IMPORT_MTAG_ABORT	103
2.2.8.2.2.4.2	TXUSER_IMPORT_MTAG_ABORT_TOO_LATE	103
2.2.8.2.2.4.3	TXUSER_IMPORT_MTAG_IMPORT	104
2.2.8.2.2.4.4	TXUSER_IMPORT_MTAG_IMPORT_TX_NOT_FOUND	104
2.2.8.2.2.4.5	TXUSER_IMPORT_MTAG_IMPORTED	105
2.2.8.2.2.4.6	TXUSER_IMPORT_MTAG_REQUEST_COMPLETED	105
2.2.8.2.2.5	CONNTYPE_TXUSER_IMPORT2.....	106
2.2.8.2.2.5.1	TXUSER_IMPORT2_MTAG_ABORT.....	106
2.2.8.2.2.5.2	TXUSER_IMPORT2_MTAG_IMPORT	106
2.2.8.2.2.5.3	TXUSER_IMPORT2_MTAG_IMPORT_WITH_SET.....	107
2.2.8.2.2.5.4	TXUSER_IMPORT2_MTAG_SINK_ERROR.....	107
2.2.8.2.2.5.5	TXUSER_IMPORT2_MTAG_SINK_IMPORTED.....	108
2.2.8.3	Transaction Administration	108
2.2.8.3.1	CONNTYPE_TXUSER_GETTXDETAILS	108
2.2.8.3.1.1	TXUSER_GETTXDETAILS_MTAG_GET.....	109
2.2.8.3.1.2	TXUSER_GETTXDETAILS_MTAG_GOTIT	109
2.2.8.3.1.3	TXUSER_GETTXDETAILS_MTAG_TX_NOT_FOUND	110
2.2.8.3.2	CONNTYPE_TXUSER_RESOLVE	111
2.2.8.3.2.1	TXUSER_RESOLVE_MTAG_ACCESSDENIED	111
2.2.8.3.2.2	TXUSER_RESOLVE_MTAG_CHILD_ABORT	111
2.2.8.3.2.3	TXUSER_RESOLVE_MTAG_CHILD_COMMIT	112
2.2.8.3.2.4	TXUSER_RESOLVE_MTAG_CHILD_NOT_PREPARED	112
2.2.8.3.2.5	TXUSER_RESOLVE_MTAG_FORGET_COMMITTED	113
2.2.8.3.2.6	TXUSER_RESOLVE_MTAG_FORGET_TX_NOT_COMMITTED	113
2.2.8.3.2.7	TXUSER_RESOLVE_MTAG_REQUEST_COMPLETE.....	114
2.2.8.3.2.8	TXUSER_RESOLVE_MTAG_NOT_CHILD	114

2.2.8.3.2.9	TXUSER_RESOLVE_MTAG_TX_NOT_FOUND	114
2.2.8.3.3	CONNTYPE_TXUSER_SETTXXTIMEOUT	115
2.2.8.3.3.1	TXUSER_SETTXXTIMEOUT_MTAG_TX_NOT_FOUND	115
2.2.8.3.4	CONNTYPE_TXUSER_SETTXXTIMEOUT2	115
2.2.8.3.5	CONNTYPE_TXUSER_TRACE.....	115
2.2.8.3.5.1	TXUSER_TRACE_MTAG_DUMP_TRANSACTION.....	116
2.2.8.3.5.2	TXUSER_TRACE_MTAG_REQUEST_COMPLETE	116
2.2.8.3.5.3	TXUSER_TRACE_MTAG_REQUEST_FAILED	116
2.2.8.3.5.4	TXUSER_TRACE_MTAG_TX_NOT_FOUND	117
2.2.8.4	Transaction Manager Administration.....	117
2.2.8.4.1	CONNTYPE_TXUSER_GETSECURITYFLAGS	117
2.2.8.4.1.1	TXUSER_GETSECURITYFLAGS_MTAG_FETCHED.....	117
2.2.8.4.1.2	TXUSER_GETSECURITYFLAGS_MTAG_GETSECURITYFLAGS.....	118
2.2.9	Connection Types Relevant to Transaction Managers.....	118
2.2.9.1	Transaction Propagation and Coordination.....	118
2.2.9.1.1	Push Propagation	118
2.2.9.1.1.1	CONNTYPE_PARTNERTM_PROPAGATE.....	119
2.2.9.1.1.1.1	PARTNERTM_PROPAGATE_MTAG_PROPAGATE.....	119
2.2.9.1.1.1.2	PARTNERTM_PROPAGATE_MTAG_PROPAGATED	119
2.2.9.1.1.1.3	PARTNERTM_PROPAGATE_MTAG_DUPLICATE.....	120
2.2.9.1.1.1.4	PARTNERTM_PROPAGATE_MTAG_NO_MEM	120
2.2.9.1.1.1.5	PARTNERTM_PROPAGATE_MTAG_LOG_FULL	121
2.2.9.1.1.1.6	PARTNERTM_PROPAGATE_MTAG_PREPAREREQ	121
2.2.9.1.1.1.7	PARTNERTM_PROPAGATE_MTAG_PREPAREREQDONE.....	121
2.2.9.1.1.1.8	PARTNERTM_PROPAGATE_MTAG_PROTOCOL_ERROR.....	122
2.2.9.1.1.1.9	PARTNERTM_PROPAGATE_MTAG_COMMITREQ	122
2.2.9.1.1.1.10	PARTNERTM_PROPAGATE_MTAG_COMMITREQDONE.....	123
2.2.9.1.1.1.11	PARTNERTM_PROPAGATE_MTAG_ABORTREQ	123
2.2.9.1.1.1.12	PARTNERTM_PROPAGATE_MTAG_ABORTREQDONE.....	124
2.2.9.1.1.1.13	PARTNERTM_PROPAGATE_MTAG_ABORTNOTIFY	124
2.2.9.1.1.1.14	PARTNERTM_PROPAGATE_MTAG_PHASE0REGISTER	124
2.2.9.1.1.1.15	PARTNERTM_PROPAGATE_MTAG_PHASE0REGISTERED	125
2.2.9.1.1.1.16	PARTNERTM_PROPAGATE_MTAG_PHASE0REGISTRATIONREJECTED 125	
2.2.9.1.1.1.17	PARTNERTM_PROPAGATE_MTAG_PHASE0	125
2.2.9.1.1.1.18	PARTNERTM_PROPAGATE_MTAG_PHASE0COMPLETE	126
2.2.9.1.2	Pull Propagation	126
2.2.9.1.2.1	CONNTYPE_PARTNERTM_BRANCH.....	126
2.2.9.1.2.1.1	PARTNERTM_BRANCH_MTAG_BRANCH_LOG_FULL	126
2.2.9.1.2.1.2	PARTNERTM_BRANCH_MTAG_BRANCH_NO_MEM	127
2.2.9.1.2.1.3	PARTNERTM_BRANCH_MTAG_BRANCH_TOO_LATE	127
2.2.9.1.2.1.4	PARTNERTM_BRANCH_MTAG_BRANCH_TOO_MANY	128
2.2.9.1.2.1.5	PARTNERTM_BRANCH_MTAG_BRANCH_TX_NOT_FOUND.....	128
2.2.9.1.2.1.6	PARTNERTM_BRANCH_MTAG_BRANCHED.....	128
2.2.9.1.2.1.7	PARTNERTM_BRANCH_MTAG_BRANCHING	129
2.2.9.2	Transaction Recovery	129
2.2.9.2.1	Subordinate-Driven	129
2.2.9.2.1.1	CONNTYPE_PARTNERTM_CHECKABORT	129
2.2.9.2.1.1.1	PARTNERTM_CHECKABORT_MTAG_CHECK	129
2.2.9.2.1.1.2	PARTNERTM_CHECKABORT_MTAG_ABORTED	130
2.2.9.2.1.1.3	PARTNERTM_CHECKABORT_MTAG_RETRY	130
2.2.9.2.2	Superior-Driven	131
2.2.9.2.2.1	CONNTYPE_PARTNERTM_REDELIVERCOMMIT	131
2.2.9.2.2.1.1	PARTNERTM_REDELIVERCOMMIT_MTAG_COMMITREQ	131
2.2.9.2.2.1.2	PARTNERTM_REDELIVERCOMMIT_MTAG_COMMITREQDONE	131
2.2.9.2.2.1.3	PARTNERTM_REDELIVERCOMMIT_MTAG_RETRY	132
2.2.10	Connection Types Relevant to Resource Managers	132
2.2.10.1	Resource Manager Registration.....	132

2.2.10.1.1	CONNTYPE_TXUSER_RESOURCEMANAGER	132
2.2.10.1.1.1	TXUSER_RESOURCEMANAGER_MTAG_CREATE	132
2.2.10.1.1.2	TXUSER_RESOURCEMANAGER_MTAG_DUPLICATE	133
2.2.10.1.1.3	TXUSER_RESOURCEMANAGER_MTAG_REENLISTMENTCOMPLETE ...	133
2.2.10.1.1.4	TXUSER_RESOURCEMANAGER_MTAG_REQUEST_COMPLETE	134
2.2.10.1.2	CONNTYPE_TXUSER_RESOURCEMANAGERINTERNAL	134
2.2.10.1.2.1	TXUSER_RESOURCEMANAGERINTERNAL_MTAG_DUPLICATEDETECTED	134
2.2.10.2	Transaction Coordination	135
2.2.10.2.1	CONNTYPE_TXUSER_PHASE0	135
2.2.10.2.1.1	TXUSER_PHASE0_MTAG_CREATE	135
2.2.10.2.1.2	TXUSER_PHASE0_MTAG_CREATE_TOO_LATE	136
2.2.10.2.1.3	TXUSER_PHASE0_MTAG_CREATE_TX_NOT_FOUND	136
2.2.10.2.1.4	TXUSER_PHASE0_MTAG_CREATED	136
2.2.10.2.1.5	TXUSER_PHASE0_MTAG_PHASE0REQ	137
2.2.10.2.1.6	TXUSER_PHASE0_MTAG_PHASE0REQ_ABORT	137
2.2.10.2.1.7	TXUSER_PHASE0_MTAG_PHASE0REQDONE	137
2.2.10.2.1.8	TXUSER_PHASE0_MTAG_UNENLIST	138
2.2.10.2.2	CONNTYPE_TXUSER_ENLISTMENT	138
2.2.10.2.2.1	TXUSER_ENLISTMENT_MTAG_ABORTREQ	138
2.2.10.2.2.2	TXUSER_ENLISTMENT_MTAG_ABORTREQDONE	139
2.2.10.2.2.3	TXUSER_ENLISTMENT_MTAG_COMMITREQ	139
2.2.10.2.2.4	TXUSER_ENLISTMENT_MTAG_COMMITREQDONE	139
2.2.10.2.2.5	TXUSER_ENLISTMENT_MTAG_ENLIST	140
2.2.10.2.2.6	TXUSER_ENLISTMENT_MTAG_ENLIST_LOG_FULL	141
2.2.10.2.2.7	TXUSER_ENLISTMENT_MTAG_ENLIST_TOO_LATE	141
2.2.10.2.2.8	TXUSER_ENLISTMENT_MTAG_ENLIST_TOO_MANY	141
2.2.10.2.2.9	TXUSER_ENLISTMENT_MTAG_ENLIST_TX_NOT_FOUND	142
2.2.10.2.2.10	TXUSER_ENLISTMENT_MTAG_ENLISTED	142
2.2.10.2.2.11	TXUSER_ENLISTMENT_MTAG_PREPAREREQ	143
2.2.10.2.2.12	TXUSER_ENLISTMENT_MTAG_PREPAREREQDONE	143
2.2.10.3	Transaction Recovery	144
2.2.10.3.1	CONNTYPE_TXUSER_REENLIST	144
2.2.10.3.1.1	TXUSER_REENLIST_MTAG_REENLIST	144
2.2.10.3.1.2	TXUSER_REENLIST_MTAG_REENLIST_ABORTED	145
2.2.10.3.1.3	TXUSER_REENLIST_MTAG_REENLIST_COMMITTED	145
2.2.10.3.1.4	TXUSER_REENLIST_MTAG_REENLIST_TIMEOUT	145
2.2.10.4	Voting	146
2.2.10.4.1	CONNTYPE_TXUSER_VOTER	146
2.2.10.4.1.1	TXUSER_STATUS_MTAG_ABORTED	146
2.2.10.4.1.2	TXUSER_STATUS_MTAG_COMMITTED	146
2.2.10.4.1.3	TXUSER_STATUS_MTAG_INDOUBT	147
2.2.10.4.1.4	TXUSER_VOTER_MTAG_CREATE	147
2.2.10.4.1.5	TXUSER_VOTER_MTAG_CREATE_TOO_LATE	148
2.2.10.4.1.6	TXUSER_VOTER_MTAG_CREATE_TX_NOT_FOUND	148
2.2.10.4.1.7	TXUSER_VOTER_MTAG_CREATED	148
2.2.10.4.1.8	TXUSER_VOTER_MTAG_VOTEREQ	149
2.2.10.4.1.9	TXUSER_VOTER_MTAG_VOTEREQDONE	149

3 Protocol Details 151

3.1	Common Details	151
3.1.1	Abstract Data Model	151
3.1.1.1	Converting a Name Object to an OLETX_TM_ADDR Structure	152
3.1.1.2	Converting an OLETX_TM_ADDR Structure to a Name Object	152
3.1.1.3	Converting a Name Object to a NAMEOBJECTBLOB Structure	153
3.1.1.4	Converting a NAMEOBJECTBLOB Structure to a Name Object	153
3.1.2	Timers	153
3.1.3	Initialization	153

3.1.3.1	Enlistment Object Initialization	154
3.1.4	Protocol Versioning Details.....	154
3.1.4.1	Supporting a Protocol Version.....	154
3.1.4.2	Negotiating a Common Protocol Version.....	154
3.1.4.3	Using the Negotiated Protocol Version	155
3.1.5	Higher-Layer Triggered Events	155
3.1.6	Processing Events and Sequencing Rules	155
3.1.7	Timer Events.....	156
3.1.8	Other Local Events.....	156
3.1.8.1	Initiate Connection	156
3.1.8.2	Disconnect Connection.....	156
3.1.8.3	Connection Disconnected	157
3.1.8.4	Receiving a Message	157
3.2	Core Transaction Manager Facet Details	157
3.2.1	Abstract Data Model.....	157
3.2.1.1	Versioning.....	160
3.2.1.2	Transaction Logging	161
3.2.1.3	Transaction States	161
3.2.1.3.1	Idle	163
3.2.1.3.2	Active	163
3.2.1.3.3	Phase Zero	164
3.2.1.3.4	Phase Zero Complete	164
3.2.1.3.5	Voting.....	165
3.2.1.3.6	Voting Complete.....	165
3.2.1.3.7	Phase One	165
3.2.1.3.8	Phase One Complete.....	166
3.2.1.3.9	Single Phase Commit	166
3.2.1.3.10	Committing.....	166
3.2.1.3.11	Aborting	166
3.2.1.3.12	In Doubt	166
3.2.1.3.13	Failed to Notify.....	167
3.2.1.3.14	Ended	167
3.2.1.4	Transaction Manager Facets	167
3.2.1.5	Protocol Extension Objects	167
3.2.2	Timers	168
3.2.2.1	Transaction Timeout Timer	168
3.2.3	Initialization.....	169
3.2.3.1	Transaction Object Initialization	170
3.2.3.2	Durable Log	171
3.2.3.3	Transaction Recovery	171
3.2.4	Higher-Layer Triggered Events	171
3.2.5	Processing Events and Sequencing Rules	172
3.2.6	Timer Events.....	172
3.2.6.1	Transaction Timeout Timer	172
3.2.7	Other Local Events.....	172
3.2.7.1	Associate Transaction	172
3.2.7.2	Begin Commit.....	173
3.2.7.3	Begin In Doubt	174
3.2.7.4	Begin Phase One.....	174
3.2.7.5	Begin Phase Zero	174
3.2.7.6	Begin Rollback.....	175
3.2.7.7	Begin Voting.....	175
3.2.7.8	Branch Transaction Failure	176
3.2.7.9	Branch Transaction Success	176
3.2.7.10	Create Phase Zero Enlistment.....	176
3.2.7.11	Create Subordinate Enlistment	177
3.2.7.12	Create Superior Enlistment	178
3.2.7.13	Create Transaction	179

3.2.7.14	Create Voter Enlistment	180
3.2.7.15	Enlistment Commit Complete	180
3.2.7.16	Enlistment Phase One Complete.....	181
3.2.7.17	Enlistment Phase Zero Complete.....	182
3.2.7.18	Enlistment Rollback Complete.....	183
3.2.7.19	Enlistment Unilaterally Aborted.....	184
3.2.7.20	Enlistment Vote Complete	185
3.2.7.21	Export Transaction	186
3.2.7.22	Forget Transaction	187
3.2.7.23	Notify Aborted	187
3.2.7.24	Notify Recovered Transaction Committed	188
3.2.7.25	Phase One Completed.....	188
3.2.7.26	Propagate Transaction Failure.....	189
3.2.7.27	Propagate Transaction Success	189
3.2.7.28	Register Phase Zero Failure	190
3.2.7.29	Register Phase Zero Success	190
3.2.7.30	Resolve Transaction	191
3.2.7.31	Set Transaction Attributes.....	192
3.2.7.32	Set Transaction Timeout	192
3.2.7.33	Request Transaction Outcome	193
3.2.7.34	Unenlist Phase Zero Enlistment.....	193
3.2.7.35	Voting Complete	194
3.3	Application Details.....	195
3.3.1	Abstract Data Model.....	195
3.3.1.1	CONNTYPE_TXUSER_BEGINNER Initiator States.....	195
3.3.1.1.1	Idle	196
3.3.1.1.2	Awaiting Begin Response.....	197
3.3.1.1.3	Processing Transaction.....	197
3.3.1.1.4	Awaiting Commit Response.....	197
3.3.1.1.5	Awaiting Abort Response	197
3.3.1.1.6	Ended	197
3.3.1.2	CONNTYPE_TXUSER_BEGIN2 Initiator States.....	197
3.3.1.2.1	Idle	198
3.3.1.2.2	Awaiting Begin Response.....	198
3.3.1.2.3	Processing Transaction.....	198
3.3.1.2.4	Awaiting Set Timeout Response.....	199
3.3.1.2.5	Awaiting Commit Response.....	199
3.3.1.2.6	Awaiting Abort Response	199
3.3.1.2.7	Ended	199
3.3.1.3	CONNTYPE_TXUSER_PROMOTE Initiator States.....	199
3.3.1.3.1	Idle	200
3.3.1.3.2	Awaiting Promote Response.....	200
3.3.1.3.3	Processing Transaction.....	200
3.3.1.3.4	Awaiting Set Timeout Response.....	201
3.3.1.3.5	Awaiting Commit Response.....	201
3.3.1.3.6	Awaiting Abort Response	201
3.3.1.3.7	Ended	201
3.3.1.4	CONNTYPE_TXUSER_ASSOCIATE Initiator States	201
3.3.1.4.1	Idle	202
3.3.1.4.2	Awaiting Associate Response	202
3.3.1.4.3	Active	202
3.3.1.4.4	Ended	202
3.3.1.5	CONNTYPE_TXUSER_EXTENDWHEREABOUTS Initiator States	203
3.3.1.5.1	Idle	203
3.3.1.5.2	Awaiting Get Response.....	204
3.3.1.5.3	Ended	204
3.3.1.6	CONNTYPE_TXUSER_IMPORT Initiator States	204
3.3.1.6.1	Idle	205

3.3.1.6.2	Awaiting Import Response	205
3.3.1.6.3	Transaction Import Successful	205
3.3.1.6.4	Awaiting Abort Response	206
3.3.1.6.5	Ended	206
3.3.1.7	CONNTYPE_TXUSER_IMPORT2 Initiator States.....	206
3.3.1.7.1	Idle	207
3.3.1.7.2	Awaiting Import Response	207
3.3.1.7.3	Transaction Import Successful	207
3.3.1.7.4	Awaiting Abort Response	208
3.3.1.7.5	Ended	208
3.3.1.8	CONNTYPE_TXUSER_EXPORT Initiator States	208
3.3.1.8.1	Idle	209
3.3.1.8.2	Awaiting Create Response	209
3.3.1.8.3	Connection Active.....	209
3.3.1.8.4	Awaiting Export Response	210
3.3.1.8.5	Ended	210
3.3.1.9	CONNTYPE_TXUSER_EXPORT2 Initiator States	210
3.3.1.9.1	Idle	211
3.3.1.9.2	Awaiting Create Response	211
3.3.1.9.3	Connection Active.....	211
3.3.1.9.4	Awaiting Export Response	211
3.3.1.9.5	Ended	212
3.3.1.10	CONNTYPE_TXUSER_GETTXDETAILS Initiator States	212
3.3.1.10.1	Idle	213
3.3.1.10.2	Awaiting Response.....	213
3.3.1.10.3	Ended	213
3.3.1.11	CONNTYPE_TXUSER_RESOLVE Initiator States	214
3.3.1.11.1	Idle	215
3.3.1.11.2	Awaiting Abort Response	215
3.3.1.11.3	Awaiting Forget Response.....	216
3.3.1.11.4	Awaiting Commit Response.....	216
3.3.1.11.5	Ended	216
3.3.1.12	CONNTYPE_TXUSER_SETTXTIMEOUT Initiator States	216
3.3.1.12.1	Idle	217
3.3.1.12.2	Awaiting Set Timeout Response.....	217
3.3.1.12.3	Ended	217
3.3.1.13	CONNTYPE_TXUSER_SETTXTIMEOUT2 Initiator States.....	218
3.3.1.13.1	Idle	218
3.3.1.13.2	Awaiting Set Timeout Response.....	219
3.3.1.13.3	Ended	219
3.3.1.14	CONNTYPE_TXUSER_TRACE Initiator States	219
3.3.1.14.1	Idle	220
3.3.1.14.2	Awaiting Trace Response.....	220
3.3.1.14.3	Ended	220
3.3.1.15	CONNTYPE_TXUSER_GETSECURITYFLAGS Initiator States.....	221
3.3.1.15.1	Idle	222
3.3.1.15.2	Awaiting Get Response.....	222
3.3.1.15.3	Ended	222
3.3.2	Timers	222
3.3.3	Initialization.....	222
3.3.4	Higher-Layer Triggered Events	222
3.3.4.1	Beginning a Transaction.....	223
3.3.4.1.1	Beginning a Transaction Using CONNTYPE_TXUSER_BEGIN2.....	223
3.3.4.1.2	Beginning a Transaction Using CONNTYPE_TXUSER_BEGINNER.....	223
3.3.4.1.3	Beginning a Transaction Using CONNTYPE_TXUSER_PROMOTE.....	224
3.3.4.2	Changing a Transaction Timeout	224
3.3.4.2.1	Changing a Transaction Timeout Using CONNTYPE_TXUSER_SETTXTIMEOUT	224

3.3.4.2.2	Querying Transaction Manager's Support for Modifying a Transaction Timeout Using CONNTYPE_TXUSER_SETTXTIMEOUT2	225
3.3.4.3	Obtaining a Propagation Token for a Transaction.....	226
3.3.4.4	Creating an Export Connection.....	226
3.3.4.5	Generating Trace Records for a Transaction Using CONNTYPE_TXUSER_TRACE	228
3.3.4.6	Importing a Transaction.....	228
3.3.4.6.1	Importing a Transaction Using CONNTYPE_TXUSER_IMPORT.....	228
3.3.4.6.2	Importing a Transaction Using CONNTYPE_TXUSER_IMPORT2.....	229
3.3.4.7	Importing a Transaction with Additional Transaction Attributes	229
3.3.4.8	Initiating Transaction Commit.....	230
3.3.4.8.1	Commit a Transaction Using CONNTYPE_TXUSER_BEGIN2.....	230
3.3.4.8.2	Commit a Transaction Using CONNTYPE_TXUSER_BEGINNER.....	230
3.3.4.8.3	Commit a Transaction Using CONNTYPE_TXUSER_PROMOTE.....	231
3.3.4.9	Initiating Transaction Rollback.....	231
3.3.4.9.1	Abort a Transaction Using CONNTYPE_TXUSER_BEGIN2	232
3.3.4.9.2	Abort a Transaction Using CONNTYPE_TXUSER_BEGINNER	232
3.3.4.9.3	Abort a Transaction Using CONNTYPE_TXUSER_IMPORT	232
3.3.4.9.4	Abort a Transaction Using CONNTYPE_TXUSER_IMPORT2	232
3.3.4.9.5	Roll Back a Transaction Using CONNTYPE_TXUSER_PROMOTE.....	233
3.3.4.10	Obtaining Extended Whereabouts Using CONNTYPE_TXUSER_EXTENDEDWHEREABOUTS	233
3.3.4.11	Obtaining the Security Configuration of the Transaction Manager Using CONNTYPE_TXUSER_GETSECURITYFLAGS	233
3.3.4.11.1	Obtaining the Details for a Transaction.....	233
3.3.4.12	Pulling a Transaction	234
3.3.4.13	Push a Transaction Using an Existing Export Connection	235
3.3.4.14	Obtaining a Transaction Cookie Using an Existing Export Connection	235
3.3.4.15	Resolving a Transaction	235
3.3.5	Processing Events and Sequencing Rules	236
3.3.5.1	Transaction Initiation and Completion.....	236
3.3.5.1.1	CONNTYPE_TXUSER_BEGINNER as Initiator.....	236
3.3.5.1.1.1	Receiving a TXUSER_BEGINNER_MTAG_BEGUN Message	236
3.3.5.1.1.2	Receiving a TXUSER_BEGINNER_MTAG_BEGIN_NO_MEM or TXUSER_BEGINNER_MTAG_BEGIN_LOG_FULL Message.....	237
3.3.5.1.1.3	Receiving a TXUSER_BEGINNER_MTAG_REQUEST_COMPLETED Message	237
3.3.5.1.1.4	Receiving a TXUSER_BEGINNER_MTAG_COMMIT_TOO_LATE Message	237
3.3.5.1.1.5	Receiving a TXUSER_BEGINNER_MTAG_COMMIT_INDOUBT Message.....	238
3.3.5.1.1.6	Connection Disconnected	238
3.3.5.1.2	CONNTYPE_TXUSER_BEGIN2 as Initiator.....	238
3.3.5.1.2.1	Receiving a TXUSER_BEGIN2_MTAG_SINK_BEGUN Message	238
3.3.5.1.2.2	Receiving a TXUSER_SETTXTIMEOUT_MTAG_REQUEST_COMPLETE Message	239
3.3.5.1.2.3	Receiving a TXUSER_SETTXTIMEOUT_MTAG_TOO_LATE Message	239
3.3.5.1.2.4	Receiving a TXUSER_SETTXTIMEOUT_MTAG_TX_NOT_FOUND Message	239
3.3.5.1.2.5	Receiving a TXUSER_BEGIN2_MTAG_SINK_ERROR Message	239
3.3.5.1.2.6	Connection Disconnected	240
3.3.5.1.3	CONNTYPE_TXUSER_PROMOTE as Initiator.....	241
3.3.5.1.3.1	Receiving a TXUSER_BEGIN2_MTAG_SINK_BEGUN Message	241
3.3.5.1.3.2	Receiving a TXUSER_BEGIN2_MTAG_SINK_ERROR Message	241
3.3.5.2	Transaction Propagation	242
3.3.5.2.1	Pull Propagation	242
3.3.5.2.1.1	CONNTYPE_TXUSER_ASSOCIATE as Initiator.....	242
3.3.5.2.1.1.1	Receiving a TXUSER_ASSOCIATE_MTAG_ASSOCIATED Message.....	242
3.3.5.2.1.1.2	Receiving Other TXUSER_ASSOCIATE_MTAG Messages	242

3.3.5.2.1.1.3	Receiving a TXUSER_IMPORT2_MTAG_SINK_ERROR Message ...	243
3.3.5.2.1.1.4	Connection Disconnected.....	243
3.3.5.2.2	Push Propagation	243
3.3.5.2.2.1	CONNTYPE_TXUSER_EXTENDEDWHEREABOUTS as Initiator.....	243
3.3.5.2.2.1.1	Receiving a TXUSER_EXTENDEDWHEREABOUTS_MTAG_GOT Message.....	243
3.3.5.2.2.1.2	Receiving a TXUSER_EXTENDEDWHEREABOUTS_MTAG_NOMEM Message.....	244
3.3.5.2.2.1.3	CONNTYPE_TXUSER_EXTENDEDWHEREABOUTS Connection Disconnected	244
3.3.5.2.2.2	CONNTYPE_TXUSER_EXPORT as Initiator.....	244
3.3.5.2.2.2.1	Receiving a TXUSER_EXPORT_MTAG_CREATED Message	244
3.3.5.2.2.2.2	Receiving a TXUSER_EXPORT_MTAG_CREATE_BAD_TMADDR or TXUSER_EXPORT_MTAG_CREATE_NET_TX_DISABLED Message	244
3.3.5.2.2.2.3	Receiving a TXUSER_EXPORT_MTAG_EXPORTED Message	244
3.3.5.2.2.2.4	Receiving a TXUSER_EXPORT_MTAG_EXPORT_LOG_FULL, TXUSER_EXPORT_MTAG_EXPORT_NO_MEM, TXUSER_EXPORT_MTAG_EXPORT_TOO_LATE, TXUSER_EXPORT_MTAG_EXPORT_TOO_MANY, or TXUSER_EXPORT_MTAG_EXPORT_NOT_FOUND Message	245
3.3.5.2.2.2.5	CONNTYPE_TXUSER_EXPORT Connection Disconnected.....	245
3.3.5.2.2.3	CONNTYPE_TXUSER_EXPORT2 as Initiator	245
3.3.5.2.2.3.1	Receiving a TXUSER_EXPORT_MTAG_CREATED Message	245
3.3.5.2.2.3.2	Receiving a TXUSER_EXPORT_MTAG_CREATE_BAD_TMADDR or TXUSER_EXPORT_MTAG_CREATE_NET_TX_DISABLED Message	246
3.3.5.2.2.3.3	Receiving a TXUSER_EXPORT_MTAG_EXPORTED Message	246
3.3.5.2.2.3.4	Receiving a TXUSER_EXPORT_MTAG_EXPORT_LOG_FULL, TXUSER_EXPORT_MTAG_EXPORT_NO_MEM, TXUSER_EXPORT_MTAG_EXPORT_TOO_LATE, TXUSER_EXPORT_MTAG_EXPORT_TOO_MANY, TXUSER_EXPORT_MTAG_EXPORT_NOT_FOUND, or TXUSER_EXPORT_MTAG_EXPORT_COMM_FAILED Message	246
3.3.5.2.2.3.5	CONNTYPE_TXUSER_EXPORT2 Connection Disconnected	246
3.3.5.2.2.4	CONNTYPE_TXUSER_IMPORT as Initiator	246
3.3.5.2.2.4.1	Receiving a TXUSER_IMPORT_MTAG_IMPORTED Message	246
3.3.5.2.2.4.2	Receiving a TXUSER_IMPORT_MTAG_IMPORT_TX_NOT_FOUND Message.....	246
3.3.5.2.2.4.3	Receiving a TXUSER_IMPORT_MTAG_ABORT_TOO_LATE Message. 247	
3.3.5.2.2.4.4	Receiving a TXUSER_IMPORT_MTAG_REQUEST_COMPLETED Message.....	247
3.3.5.2.2.4.5	Connection Disconnected.....	247
3.3.5.2.2.5	CONNTYPE_TXUSER_IMPORT2 as Initiator	247
3.3.5.2.2.5.1	Receiving a TXUSER_IMPORT2_MTAG_SINK_IMPORTED Message 247	
3.3.5.2.2.5.2	Receiving a TXUSER_IMPORT2_MTAG_SINK_ERROR Message ...	248
3.3.5.2.2.5.3	CONNTYPE_TXUSER_IMPORT2 Connection Disconnected	248
3.3.5.3	Transaction Administration.....	249
3.3.5.3.1	CONNTYPE_TXUSER_GETTXDETAILS as Initiator	249
3.3.5.3.1.1	Receiving a TXUSER_GETTXDETAILS_MTAG_GOTIT Message	249
3.3.5.3.1.2	Receiving a TXUSER_GETTXDETAILS_MTAG_TX_NOT_FOUND Message	249
3.3.5.3.1.3	CONNTYPE_TXUSER_GETTXDETAILS Connection Disconnected	249
3.3.5.3.2	CONNTYPE_TXUSER_RESOLVE as Initiator.....	249
3.3.5.3.2.1	Receiving a TXUSER_RESOLVE_MTAG_REQUEST_COMPLETE Message	250
3.3.5.3.2.2	Receiving a TXUSER_RESOLVE_MTAG_ACCESSDENIED or TXUSER_RESOLVE_MTAG_TX_NOT_FOUND Message	250

3.3.5.3.2.3	Receiving a TXUSER_RESOLVE_MTAG_CHILD_NOT_PREPARED or TXUSER_RESOLVE_MTAG_NOT_CHILD Message	250
3.3.5.3.2.4	Receiving a TXUSER_RESOLVE_MTAG_FORGET_TX_NOT_COMMITTED Message	250
3.3.5.3.2.5	Connection Disconnected	251
3.3.5.3.3	CONNTYPE_TXUSER_SETTXTIMEOUT as Initiator.....	251
3.3.5.3.3.1	Receiving a TXUSER_SETTXTIMEOUT_MTAG_REQUEST_COMPLETE Message	251
3.3.5.3.3.2	Receiving a TXUSER_SETTXTIMEOUT_MTAG_TOO_LATE or TXUSER_SETTXTIMEOUT_MTAG_TX_NOT_FOUND Message	251
3.3.5.3.3.3	Connection Disconnected	251
3.3.5.3.4	CONNTYPE_TXUSER_SETTXTIMEOUT2 as Initiator	251
3.3.5.3.4.1	Receiving a TXUSER_SETTXTIMEOUT_MTAG_TX_NOT_FOUND Message	252
3.3.5.3.4.2	Connection Disconnected	252
3.3.5.3.5	CONNTYPE_TXUSER_TRACE as Initiator	252
3.3.5.3.5.1	Receiving a TXUSER_TRACE_MTAG_REQUEST_COMPLETE Message	252
3.3.5.3.5.2	Receiving a TXUSER_TRACE_MTAG_REQUEST_FAILED or TXUSER_TRACE_MTAG_TX_NOT_FOUND Message	253
3.3.5.3.5.3	Connection Disconnected	253
3.3.5.4	Transaction Manager Administration	253
3.3.5.4.1	CONNTYPE_TXUSER_GETSECURITYFLAGS as Initiator.....	253
3.3.5.4.1.1	Receiving a TXUSER_GETSECURITYFLAGS_MTAG_FETCHED Message	253
3.3.5.4.1.2	CONNTYPE_TXUSER_GETSECURITYFLAGS Connection Disconnected.....	253
3.3.6	Timer Events.....	254
3.3.7	Other Local Events.....	254
3.4	Transaction Manager Communicating with Application Details	254
3.4.1	Abstract Data Model.....	254
3.4.1.1	CONNTYPE_TXUSER_BEGINNER Acceptor States.....	254
3.4.1.1.1	Idle	255
3.4.1.1.2	Beginning Transaction.....	256
3.4.1.1.3	Active	256
3.4.1.1.4	Aborting Transaction.....	256
3.4.1.1.5	Committing Transaction	256
3.4.1.1.6	Ended	256
3.4.1.2	CONNTYPE_TXUSER_BEGIN2 Acceptor States.....	256
3.4.1.2.1	Idle	257
3.4.1.2.2	Beginning Transaction.....	257
3.4.1.2.3	Active	257
3.4.1.2.4	Modifying Timeout	258
3.4.1.2.5	Aborting Transaction.....	258
3.4.1.2.6	Committing Transaction	258
3.4.1.2.7	Ended	258
3.4.1.3	CONNTYPE_TXUSER_PROMOTE Acceptor States.....	258
3.4.1.3.1	Idle	259
3.4.1.3.2	Beginning Transaction.....	259
3.4.1.3.3	Active	259
3.4.1.3.4	Modifying Timeout	259
3.4.1.3.5	Aborting Transaction.....	260
3.4.1.3.6	Committing Transaction	260
3.4.1.3.7	Ended	260
3.4.1.4	CONNTYPE_TXUSER_ASSOCIATE Acceptor States	260
3.4.1.4.1	Idle	261
3.4.1.4.2	Processing Associate Request.....	261
3.4.1.4.3	Active	262
3.4.1.4.4	Ended	262
3.4.1.5	CONNTYPE_TXUSER_EXTENDEDWHEREABOUTS Acceptor States	262

3.4.1.5.1	Idle	263
3.4.1.5.2	Processing Inquiry	263
3.4.1.5.3	Ended	263
3.4.1.6	CONNTYPE_TXUSER_IMPORT Acceptor States	263
3.4.1.6.1	Idle	264
3.4.1.6.2	Processing Import Request	265
3.4.1.6.3	Active	265
3.4.1.6.4	Too Late to Abort	265
3.4.1.6.5	Processing Abort Request	265
3.4.1.6.6	Ended	265
3.4.1.7	CONNTYPE_TXUSER_IMPORT2 Acceptor States	265
3.4.1.7.1	Idle	266
3.4.1.7.2	Processing Import Request	266
3.4.1.7.3	Active	267
3.4.1.7.4	Too Late to Abort	267
3.4.1.7.5	Processing Abort Request	267
3.4.1.7.6	Ended	267
3.4.1.8	CONNTYPE_TXUSER_EXPORT Acceptor States	267
3.4.1.8.1	Idle	268
3.4.1.8.2	Processing Connection Request	268
3.4.1.8.3	Connection Active	268
3.4.1.8.4	Processing Push Operation Request	268
3.4.1.8.5	Ended	269
3.4.1.9	CONNTYPE_TXUSER_EXPORT2 Acceptor States	269
3.4.1.9.1	Idle	270
3.4.1.9.2	Processing Connection Request	270
3.4.1.9.3	Connection Active	270
3.4.1.9.4	Processing Push Operation Request	270
3.4.1.9.5	Ended	271
3.4.1.10	CONNTYPE_TXUSER_GETTXDETAILS Acceptor States	271
3.4.1.10.1	Idle	272
3.4.1.10.2	Processing Inquiry	272
3.4.1.10.3	Ended	272
3.4.1.11	CONNTYPE_TXUSER_RESOLVE Acceptor States	272
3.4.1.11.1	Idle	274
3.4.1.11.2	Processing Abort Request	274
3.4.1.11.3	Processing Forget Request	274
3.4.1.11.4	Processing Commit Request	274
3.4.1.11.5	Ended	274
3.4.1.12	CONNTYPE_TXUSER_SETTXTIMEOUT Acceptor States	274
3.4.1.12.1	Idle	275
3.4.1.12.2	Processing Request	275
3.4.1.12.3	Ended	275
3.4.1.13	CONNTYPE_TXUSER_SETTXTIMEOUT2 Acceptor States	276
3.4.1.13.1	Idle	277
3.4.1.13.2	Processing Request	277
3.4.1.13.3	Ended	278
3.4.1.14	CONNTYPE_TXUSER_TRACE Acceptor States	278
3.4.1.14.1	Idle	278
3.4.1.14.2	Processing Trace Request	279
3.4.1.14.3	Ended	279
3.4.1.15	CONNTYPE_TXUSER_GETSECURITYFLAGS Acceptor States	279
3.4.1.15.1	Idle	280
3.4.1.15.2	Processing Request	280
3.4.1.15.3	Ended	280
3.4.2	Timers	281
3.4.3	Initialization	281
3.4.4	Higher-Layer Triggered Events	282

3.4.5	Processing Events and Sequencing Rules	282
3.4.5.1	Transaction Initiation and Completion	282
3.4.5.1.1	CONNTYPE_TXUSER_BEGINNER as Acceptor	282
3.4.5.1.1.1	Receiving a TXUSER_BEGINNER_MTAG_BEGIN Message	282
3.4.5.1.1.2	Receiving a TXUSER_BEGINNER_MTAG_COMMIT Message	283
3.4.5.1.1.3	Receiving a TXUSER_BEGINNER_MTAG_ABORT Message	283
3.4.5.1.1.4	Connection Disconnected	283
3.4.5.1.2	CONNTYPE_TXUSER_BEGIN2 as Acceptor	284
3.4.5.1.2.1	Receiving a TXUSER_BEGIN2_MTAG_BEGIN Message	284
3.4.5.1.2.2	Receiving a TXUSER_SETTETIMEOUT_MTAG_SETTETIMEOUT Message	285
3.4.5.1.2.3	Receiving a TXUSER_BEGIN2_MTAG_COMMIT Message	285
3.4.5.1.2.4	Receiving a TXUSER_BEGIN2_MTAG_ABORT Message	285
3.4.5.1.2.5	Connection Disconnected	285
3.4.5.1.3	CONNTYPE_TXUSER_PROMOTE as Acceptor	286
3.4.5.1.3.1	Receiving a TXUSER_BEGINNER_MTAG_PROMOTE Message	286
3.4.5.1.3.2	Receiving a TXUSER_SETTETIMEOUT_MTAG_SETTETIMEOUT, TXUSER_BEGIN2_MTAG_COMMIT, or TXUSER_BEGIN2_MTAG_ABORT Message	287
3.4.5.1.3.3	Connection Disconnected	287
3.4.5.2	Transaction Propagation	287
3.4.5.2.1	Pull Propagation	287
3.4.5.2.1.1	CONNTYPE_TXUSER_ASSOCIATE as Acceptor	287
3.4.5.2.1.1.1	Receiving a TXUSER_ASSOCIATE_MTAG_ASSOCIATE Message	287
3.4.5.2.1.1.2	Connection Disconnected	289
3.4.5.2.2	Push Propagation	289
3.4.5.2.2.1	CONNTYPE_TXUSER_EXTENDEDWHEREABOUTS as Acceptor	289
3.4.5.2.2.1.1	Receiving a TXUSER_EXTENDEDWHEREABOUTS_MTAG_GET Message	289
3.4.5.2.2.1.2	Connection Disconnected	290
3.4.5.2.2.2	CONNTYPE_TXUSER_EXPORT as Acceptor	290
3.4.5.2.2.2.1	Receiving a TXUSER_EXPORT_MTAG_CREATE Message	290
3.4.5.2.2.2.2	Receiving a TXUSER_EXPORT_MTAG_CREATE2 Message	291
3.4.5.2.2.2.3	Receiving a TXUSER_EXPORT_MTAG_EXPORT Message	291
3.4.5.2.2.2.4	Connection Disconnected	292
3.4.5.2.2.3	CONNTYPE_TXUSER_EXPORT2 as Acceptor	292
3.4.5.2.2.3.1	Receiving a TXUSER_EXPORT_MTAG_CREATE Message	292
3.4.5.2.2.3.2	Receiving a TXUSER_EXPORT_MTAG_CREATE2 Message	292
3.4.5.2.2.3.3	Receiving a TXUSER_EXPORT_MTAG_EXPORT Message	292
3.4.5.2.2.3.4	Connection Disconnected	292
3.4.5.2.2.4	CONNTYPE_TXUSER_IMPORT as Acceptor	293
3.4.5.2.2.4.1	Receiving a TXUSER_IMPORT_MTAG_IMPORT Message	293
3.4.5.2.2.4.2	Receiving a TXUSER_IMPORT_MTAG_ABORT Message	293
3.4.5.2.2.4.3	Connection Disconnected	294
3.4.5.2.2.5	CONNTYPE_TXUSER_IMPORT2 as Acceptor	294
3.4.5.2.2.5.1	Receiving a TXUSER_IMPORT2_MTAG_IMPORT Message	294
3.4.5.2.2.5.2	Receiving a TXUSER_IMPORT2_MTAG_IMPORT_WITH_SET Message	295
3.4.5.2.2.5.3	Receiving a TXUSER_IMPORT2_MTAG_ABORT Message	295
3.4.5.2.2.5.4	Connection Disconnected	296
3.4.5.3	Transaction Administration	296
3.4.5.3.1	CONNTYPE_TXUSER_GETTXDETAILS as Acceptor	296
3.4.5.3.1.1	Receiving a TXUSER_GETTXDETAILS_MTAG_GET Message	296
3.4.5.3.1.2	Connection Disconnected	297
3.4.5.3.2	CONNTYPE_TXUSER_RESOLVE as Acceptor	297
3.4.5.3.2.1	Receiving a TXUSER_RESOLVE_MTAG_CHILD_ABORT Message	297
3.4.5.3.2.2	Receiving a TXUSER_RESOLVE_MTAG_CHILD_COMMIT Message	298

3.4.5.3.2.3	Receiving a TXUSER_RESOLVE_MTAG_FORGET_COMMITTED Message	298
3.4.5.3.2.4	Connection Disconnected	299
3.4.5.3.3	CONNTYPE_TXUSER_SETTXTIMEOUT as Acceptor	299
3.4.5.3.3.1	Receiving a TXUSER_SETTXTIMEOUT_MTAG_SETTXTIMEOUT Message	299
3.4.5.3.3.2	Connection Disconnected	300
3.4.5.3.4	CONNTYPE_TXUSER_SETTXTIMEOUT2 as Acceptor	300
3.4.5.3.4.1	Receiving a TXUSER_SETTXTIMEOUT_MTAG_SETTXTIMEOUT Message	300
3.4.5.3.4.2	Connection Disconnected	300
3.4.5.3.5	CONNTYPE_TXUSER_TRACE as Acceptor	300
3.4.5.3.5.1	Receiving a TXUSER_TRACE_MTAG_DUMP_TRANSACTION Message	300
3.4.5.3.5.2	Connection Disconnected	301
3.4.5.4	Transaction Manager Administration	301
3.4.5.4.1	CONNTYPE_TXUSER_GETSECURITYFLAGS as Acceptor	301
3.4.5.4.1.1	Receiving a TXUSER_GETSECURITYFLAGS_MTAG_GETSECURITYFLAGS Message	301
3.4.5.4.1.2	Connection Disconnected	302
3.4.6	Timer Events	303
3.4.7	Other Local Events	303
3.4.7.1	Associate Transaction Failure	303
3.4.7.2	Associate Transaction Success	304
3.4.7.3	Begin Commit	304
3.4.7.4	Begin In Doubt	305
3.4.7.5	Begin Rollback	305
3.4.7.6	Begin Voting	305
3.4.7.7	Create Transaction Failure	306
3.4.7.8	Create Transaction Success	307
3.4.7.9	Create Voter Enlistment Failure	307
3.4.7.10	Create Voter Enlistment Success	308
3.4.7.11	Export Transaction Failure	308
3.4.7.12	Export Transaction Success	309
3.4.7.13	Phase One Complete	310
3.4.7.14	Phase Zero Complete	311
3.4.7.15	Register Phase Zero	311
3.4.7.16	Resolve Transaction Complete	312
3.4.7.17	Resolve Transaction Access Denied	312
3.4.7.18	Rollback Complete	313
3.4.7.19	Set Transaction Attributes Failure	313
3.4.7.20	Set Transaction Attributes Success	314
3.4.7.21	Set Transaction Timeout Failure	314
3.4.7.22	Set Transaction Timeout Success	315
3.4.7.23	Unilaterally Aborted	315
3.5	Resource Manager Details	316
3.5.1	Abstract Data Model	316
3.5.1.1	CONNTYPE_TXUSER_RESOURCEMANAGER Initiator States	316
3.5.1.1.1	Idle	317
3.5.1.1.2	Awaiting Create Response	318
3.5.1.1.3	Recovering	318
3.5.1.1.4	Awaiting Completion Confirmation	318
3.5.1.1.5	Active	318
3.5.1.1.6	Ended	318
3.5.1.2	CONNTYPE_TXUSER_RESOURCEMANAGERINTERNAL Initiator States	318
3.5.1.2.1	Idle	319
3.5.1.2.2	Awaiting Create Response	319
3.5.1.2.3	Recovering	319
3.5.1.2.4	Awaiting Completion Confirmation	320

3.5.1.2.5	Active	320
3.5.1.2.6	Ended	320
3.5.1.3	CONNTYPE_TXUSER_PHASE0 Initiator States	320
3.5.1.3.1	Idle	321
3.5.1.3.2	Awaiting Create Response	321
3.5.1.3.3	Active	321
3.5.1.3.4	Processing Phase Zero Request	322
3.5.1.3.5	Ended	322
3.5.1.4	CONNTYPE_TXUSER_ENLISTMENT Initiator States	322
3.5.1.4.1	Idle	323
3.5.1.4.2	Awaiting Enlistment Response	323
3.5.1.4.3	Active	324
3.5.1.4.4	Single Phase Committing	324
3.5.1.4.5	Preparing for Transaction Commit	324
3.5.1.4.6	Finalizing Abort Operations	324
3.5.1.4.7	Awaiting Transaction Outcome	324
3.5.1.4.8	Finalizing Commit Operations	324
3.5.1.4.9	Ended	324
3.5.1.5	CONNTYPE_TXUSER_REENLIST Initiator States	324
3.5.1.5.1	Idle	325
3.5.1.5.2	Awaiting Reenlist Response	325
3.5.1.5.3	Ended	326
3.5.1.6	CONNTYPE_TXUSER_VOTER Initiator States	326
3.5.1.6.1	Idle	327
3.5.1.6.2	Awaiting Creation Response	327
3.5.1.6.3	Active	328
3.5.1.6.4	Performing Transaction Operations	328
3.5.1.6.5	Awaiting Outcome	328
3.5.1.6.6	Ended	328
3.5.2	Timers	328
3.5.3	Initialization	328
3.5.4	Higher-Layer Triggered Events	329
3.5.4.1	Canceling Enlistment as a Phase Zero Participant on a Specific Transaction	329
3.5.4.2	Enlisting as a Phase Zero Participant on a Specific Transaction	329
3.5.4.3	Enlisting on a Specific Transaction	329
3.5.4.4	Enlistment Abort Request Completed	330
3.5.4.5	Enlistment Commit Request Completed	330
3.5.4.6	Enlistment Prepare Request Completed	331
3.5.4.7	Enlistment Single-Phase Commit Request Completed	332
3.5.4.8	Phase Zero Request Completed	333
3.5.4.9	Registering as a Voter on a Specific Transaction	333
3.5.4.10	Registering with Transaction Manager	333
3.5.4.10.1	Registering with Transaction Manager Using CONNTYPE_TXUSER_RESOURCEMANAGER	334
3.5.4.10.2	Registering with Transaction Manager Using CONNTYPE_TXUSER_RESOURCEMANAGERINTERNAL	334
3.5.4.11	Voter Vote Request Completed	334
3.5.5	Processing Events and Sequencing Rules	335
3.5.5.1	Resource Manager Registration	335
3.5.5.1.1	CONNTYPE_TXUSER_RESOURCEMANAGER as Initiator	335
3.5.5.1.1.1	Receiving a TXUSER_RESOURCEMANAGER_MTAG_DUPLICATE Message	335
3.5.5.1.1.2	Receiving a TXUSER_RESOURCEMANAGER_MTAG_REQUEST_COMPLETE Message	335
3.5.5.1.1.3	Connection Disconnected	336
3.5.5.1.2	CONNTYPE_TXUSER_RESOURCEMANAGERINTERNAL as Initiator	336

3.5.5.1.2.1	Receiving a TXUSER_RESOURCEMANAGER_MTAG_DUPLICATE or TXUSER_RESOURCEMANAGER_MTAG_REQUEST_COMPLETE Message	336
3.5.5.1.2.2	Receiving a TXUSER_RESOURCEMANAGERINTERNAL_MTAG_DUPLICATEDETECTED Message	336
3.5.5.1.2.3	Connection Disconnected	336
3.5.5.2	Transaction Coordination	337
3.5.5.2.1	CONNTYPE_TXUSER_PHASE0 as Initiator	337
3.5.5.2.1.1	Receiving a TXUSER_PHASE0_MTAG_CREATED Message	337
3.5.5.2.1.2	Receiving a TXUSER_PHASE0_MTAG_CREATE_TX_NOT_FOUND or TXUSER_PHASE0_MTAG_CREATE_TOO_LATE Message	337
3.5.5.2.1.3	Receiving a TXUSER_PHASE0_MTAG_PHASE0REQ Message	337
3.5.5.2.1.4	Receiving a TXUSER_PHASE0_MTAG_PHASE0REQ_ABORT Message	337
3.5.5.2.1.5	Connection Disconnected	338
3.5.5.2.2	CONNTYPE_TXUSER_ENLISTMENT as Initiator	338
3.5.5.2.2.1	Receiving a TXUSER_ENLISTMENT_MTAG_ENLISTED Message	338
3.5.5.2.2.2	Receiving a TXUSER_ENLISTMENT_MTAG_ENLIST_TX_NOT_FOUND, TXUSER_ENLISTMENT_MTAG_ENLIST_TOO_LATE, TXUSER_ENLISTMENT_MTAG_ENLIST_LOG_FULL, or TXUSER_ENLISTMENT_MTAG_ENLIST_TOO_MANY Message	338
3.5.5.2.2.3	Receiving a TXUSER_ENLISTMENT_MTAG_PREPAREREQ Message	338
3.5.5.2.2.4	Receiving a TXUSER_ENLISTMENT_MTAG_COMMITREQ Message	339
3.5.5.2.2.5	Receiving a TXUSER_ENLISTMENT_MTAG_ABORTREQ Message	339
3.5.5.2.2.6	Connection Disconnected	339
3.5.5.3	Transaction Recovery	340
3.5.5.3.1	CONNTYPE_TXUSER_REENLIST as Initiator	340
3.5.5.3.1.1	Receiving a TXUSER_REENLIST_MTAG_REENLIST_COMMITTED Message	340
3.5.5.3.1.2	Receiving a TXUSER_REENLIST_MTAG_REENLIST_ABORTED Message	340
3.5.5.3.1.3	Receiving a TXUSER_REENLIST_MTAG_REENLIST_TIMEOUT Message	340
3.5.5.3.1.4	Connection Disconnected	340
3.5.5.4	Voting	341
3.5.5.4.1	CONNTYPE_TXUSER_VOTER as Initiator	341
3.5.5.4.1.1	Receiving a TXUSER_VOTER_MTAG_CREATED Message	341
3.5.5.4.1.2	Receiving a TXUSER_VOTER_MTAG_CREATE_TX_NOT_FOUND or TXUSER_VOTER_MTAG_CREATE_TOO_LATE Message	341
3.5.5.4.1.3	Receiving a TXUSER_VOTER_MTAG_VOTEREQ Message	341
3.5.5.4.1.4	Receiving a TXUSER_STATUS_MTAG_COMMITTED Message	341
3.5.5.4.1.5	Receiving a TXUSER_STATUS_MTAG_ABORTED Message	342
3.5.5.4.1.6	Receiving a TXUSER_STATUS_MTAG_INDOUBT Message	342
3.5.5.4.1.7	Connection Disconnected	342
3.5.6	Timer Events	342
3.5.7	Other Local Events	342
3.5.7.1	Recover Transaction	342
3.5.7.2	Recover Transactions	343
3.5.7.3	Reenlistment Complete	343
3.5.7.4	Transaction Manager Down	343
3.5.7.5	Reenlistment Timeout	344
3.6	Transaction Manager Communicating with Resource Manager Facet Details	344
3.6.1	Abstract Data Model	344
3.6.1.1	CONNTYPE_TXUSER_RESOURCEMANAGER Acceptor States	345
3.6.1.1.1	Idle	346
3.6.1.1.2	Creating	346
3.6.1.1.3	Reenlisting	346
3.6.1.1.4	Active	346

3.6.1.1.5	Ended	347
3.6.1.2	CONNTYPE_TXUSER_RESOURCEMANAGERINTERNAL Acceptor States	347
3.6.1.2.1	Idle	348
3.6.1.2.2	Creating	348
3.6.1.2.3	Reenlisting	348
3.6.1.2.4	Active	348
3.6.1.2.5	Ended	349
3.6.1.3	CONNTYPE_TXUSER_PHASE0 Acceptor States	349
3.6.1.3.1	Idle	350
3.6.1.3.2	Awaiting Create Response	350
3.6.1.3.3	Active	351
3.6.1.3.4	Awaiting Phase Zero Response	351
3.6.1.3.5	Ended	351
3.6.1.4	CONNTYPE_TXUSER_ENLISTMENT Acceptor States	351
3.6.1.4.1	Idle	353
3.6.1.4.2	Processing Enlistment Request	353
3.6.1.4.3	Active	353
3.6.1.4.4	Awaiting Single-Phase Commit Response.....	354
3.6.1.4.5	Awaiting Prepare Response.....	354
3.6.1.4.6	Awaiting Prepare Response Aborted.....	354
3.6.1.4.7	Prepared	354
3.6.1.4.8	Awaiting Commit Response.....	354
3.6.1.4.9	Awaiting Abort Response	354
3.6.1.4.10	Ended	354
3.6.1.5	CONNTYPE_TXUSER_REENLIST Acceptor States.....	354
3.6.1.5.1	Idle	355
3.6.1.5.2	Processing Reenlist Request.....	355
3.6.1.5.3	Ended	356
3.6.1.6	CONNTYPE_TXUSER_VOTER Acceptor States	356
3.6.1.6.1	Idle	357
3.6.1.6.2	Create Voter	357
3.6.1.6.3	Active	358
3.6.1.6.4	Awaiting Voter Response	358
3.6.1.6.5	Awaiting Outcome	358
3.6.1.6.6	Ended	358
3.6.2	Timers	358
3.6.2.1	Reenlist Time-Out Timer	358
3.6.3	Initialization	358
3.6.4	Higher-Layer Triggered Events	359
3.6.5	Processing Events and Sequencing Rules	359
3.6.5.1	Resource Manager Registration.....	359
3.6.5.1.1	CONNTYPE_TXUSER_RESOURCEMANAGER as Acceptor	359
3.6.5.1.1.1	Receiving a TXUSER_RESOURCEMANAGER_MTAG_CREATE Message	359
3.6.5.1.1.2	Receiving a TXUSER_RESOURCEMANAGER_MTAG_REENLISTMENTCOMPLETE Message	360
3.6.5.1.1.3	Connection Disconnected	360
3.6.5.1.2	CONNTYPE_TXUSER_RESOURCEMANAGERINTERNAL as Acceptor	360
3.6.5.1.2.1	Receiving a TXUSER_RESOURCEMANAGER_MTAG_CREATE Message	360
3.6.5.1.2.2	Receiving a TXUSER_RESOURCEMANAGER_MTAG_REENLISTMENTCOMPLETE Message	361
3.6.5.1.2.3	Connection Disconnected	361
3.6.5.2	Transaction Coordination	361
3.6.5.2.1	CONNTYPE_TXUSER_PHASE0 as Acceptor.....	361
3.6.5.2.1.1	Receiving a TXUSER_PHASE0_MTAG_CREATE Message.....	361
3.6.5.2.1.2	Receiving a TXUSER_PHASE0_MTAG_PHASE0REQDONE Message ...	362
3.6.5.2.1.3	Receiving a TXUSER_PHASE0_MTAG_UNENLIST Message	362

3.6.5.2.1.4	Connection Disconnected	363
3.6.5.2.2	CONNTYPE_TXUSER_ENLISTMENT as Acceptor.....	363
3.6.5.2.2.1	Receiving a TXUSER_ENLISTMENT_MTAG_ENLIST Message	363
3.6.5.2.2.2	Receiving a TXUSER_ENLISTMENT_MTAG_PREPAREREQDONE Message	364
3.6.5.2.2.3	Receiving a TXUSER_ENLISTMENT_MTAG_COMMITREQDONE Message	365
3.6.5.2.2.4	Receiving a TXUSER_ENLISTMENT_MTAG_ABORTREQDONE Message	365
3.6.5.2.2.5	Connection Disconnected	366
3.6.5.3	Transaction Recovery	366
3.6.5.3.1	CONNTYPE_TXUSER_REENLIST as Acceptor.....	366
3.6.5.3.1.1	Receiving a TXUSER_REENLIST_MTAG_REENLIST Message	366
3.6.5.3.1.2	Connection Disconnected	367
3.6.5.4	Voting	368
3.6.5.4.1	CONNTYPE_TXUSER_VOTER as Acceptor	368
3.6.5.4.1.1	Receiving a TXUSER_VOTER_MTAG_CREATE Message	368
3.6.5.4.1.2	Receiving a TXUSER_VOTER_MTAG_VOTEREQDONE Message.....	368
3.6.5.4.1.3	Connection Disconnected	369
3.6.6	Timer Events.....	369
3.6.6.1	Reenlist Timeout Timer	369
3.6.7	Other Local Events.....	369
3.6.7.1	Begin Commit.....	370
3.6.7.2	Begin In Doubt	370
3.6.7.3	Begin Phase One.....	371
3.6.7.4	Begin Phase Zero	371
3.6.7.5	Begin Rollback.....	372
3.6.7.6	Begin Voting.....	372
3.6.7.7	Create Phase Zero Enlistment Failure	373
3.6.7.8	Create Phase Zero Enlistment Success.....	373
3.6.7.9	Create Resource Manager	373
3.6.7.10	Create Subordinate Enlistment Failure	374
3.6.7.11	Create Subordinate Enlistment Success	375
3.6.7.12	Create Voter Enlistment Failure	375
3.6.7.13	Create Voter Enlistment Success.....	376
3.6.7.14	Phase Zero Aborted.....	376
3.6.7.15	Reenlist Complete	376
3.6.7.16	Resource Manager Down.....	377
3.7	Superior Transaction Manager Facet Details	377
3.7.1	Abstract Data Model.....	377
3.7.1.1	CONNTYPE_PARTNERTM_PROPAGATE Initiator States.....	377
3.7.1.1.1	Idle	379
3.7.1.1.2	Awaiting Propagation Response.....	379
3.7.1.1.3	Active	380
3.7.1.1.4	Awaiting Abort Response	380
3.7.1.1.5	Phase Zero Registration	380
3.7.1.1.6	Requesting Phase Zero.....	380
3.7.1.1.7	Phase Zero	380
3.7.1.1.8	Phase Zero Registration During Phase Zero	380
3.7.1.1.9	Phase Zero with Outstanding Registration.....	380
3.7.1.1.10	Awaiting Prepare Response.....	381
3.7.1.1.11	Prepared	381
3.7.1.1.12	Awaiting Commit Response.....	381
3.7.1.1.13	Ended	381
3.7.1.2	CONNTYPE_PARTNERTM_BRANCH Acceptor States.....	381
3.7.1.2.1	Idle	382
3.7.1.2.2	Branching.....	382
3.7.1.2.3	Active	382

3.7.1.2.4	Awaiting Abort Response	383
3.7.1.2.5	Phase Zero Registration	383
3.7.1.2.6	Requesting Phase Zero.....	383
3.7.1.2.7	Phase Zero	383
3.7.1.2.8	Phase Zero Registration During Phase Zero	383
3.7.1.2.9	Phase Zero with Outstanding Registration.....	383
3.7.1.2.10	Awaiting Prepare Response.....	384
3.7.1.2.11	Prepared	384
3.7.1.2.12	Awaiting Commit Response.....	384
3.7.1.2.13	Ended	384
3.7.1.3	CONNTYPE_PARTNERTM_REDELIVERCOMMIT Initiator States	384
3.7.1.3.1	Idle	385
3.7.1.3.2	Awaiting Confirmation.....	385
3.7.1.3.3	Waiting to Rerequest	385
3.7.1.3.4	Ended	385
3.7.1.4	CONNTYPE_PARTNERTM_CHECKABORT Acceptor States	386
3.7.1.4.1	Idle	386
3.7.1.4.2	Processing Abort Inquiry	387
3.7.1.4.3	Ended	387
3.7.2	Timers	387
3.7.2.1	Redeliver Commit Timer	387
3.7.3	Initialization.....	387
3.7.4	Higher-Layer Triggered Events	387
3.7.5	Processing Events and Sequencing Rules	388
3.7.5.1	Transaction Propagation and Coordination.....	388
3.7.5.1.1	Push Propagation	388
3.7.5.1.1.1	CONNTYPE_PARTNERTM_PROPAGATE as Initiator	388
3.7.5.1.1.1.1	Receiving a PARTNERTM_PROPAGATE_MTAG_PROPAGATED Message.....	388
3.7.5.1.1.1.2	Receiving a PARTNERTM_PROPAGATE_MTAG_DUPLICATE, PARTNERTM_PROPAGATE_MTAG_NO_MEM, or PARTNERTM_PROPAGATE_MTAG_LOG_FULL Message	388
3.7.5.1.1.1.3	Receiving a PARTNERTM_PROPAGATE_MTAG_PHASE0REGISTER, PARTNERTM_PROPAGATE_MTAG_PHASE0COMPLETE, PARTNERTM_PROPAGATE_MTAG_PREPAREREQDONE, PARTNERTM_PROPAGATE_MTAG_COMMITREQDONE, PARTNERTM_PROPAGATE_MTAG_ABORTREQDONE, or PARTNERTM_PROPAGATE_MTAG_ABORTNOTIFY Message	389
3.7.5.1.1.1.4	Receiving a PARTNERTM_PROPAGATE_MTAG_PROTOCOL_ERROR Message.....	389
3.7.5.1.1.1.5	Connection Disconnected.....	389
3.7.5.1.2	Pull Propagation	390
3.7.5.1.2.1	CONNTYPE_PARTNERTM_BRANCH as Acceptor	390
3.7.5.1.2.1.1	Receiving a PARTNERTM_BRANCH_MTAG_BRANCHING Message.....	390
3.7.5.1.2.1.2	Receiving a PARTNERTM_PROPAGATE_MTAG_PHASE0REGISTER Message.....	391
3.7.5.1.2.1.3	Receiving a PARTNERTM_PROPAGATE_MTAG_PHASE0COMPLETE Message.....	391
3.7.5.1.2.1.4	Receiving a PARTNERTM_PROPAGATE_MTAG_ABORTNOTIFY Message.....	391
3.7.5.1.2.1.5	Receiving a PARTNERTM_PROPAGATE_MTAG_ABORTREQDONE Message.....	392
3.7.5.1.2.1.6	Receiving a PARTNERTM_PROPAGATE_MTAG_PREPAREREQDONE Message.....	392
3.7.5.1.2.1.7	Receiving a PARTNERTM_PROPAGATE_MTAG_COMMITREQDONE Message.....	393
3.7.5.1.2.1.8	Receiving a PARTNERTM_PROPAGATE_MTAG_PROTOCOL_ERROR Message.....	393

3.7.5.1.2.1.9	Connection Disconnected.....	393
3.7.5.2	Transaction Recovery	394
3.7.5.2.1	Subordinate-Driven Recovery	394
3.7.5.2.1.1	CONNTYPE_PARTNERTM_CHECKABORT as Acceptor	394
3.7.5.2.1.1.1	Receiving a PARTNERTM_CHECKABORT_MTAG_CHECK Message.....	395
3.7.5.2.1.1.2	Connection Disconnected.....	395
3.7.5.2.2	Superior-Driven Recovery.....	395
3.7.5.2.2.1	CONNTYPE_PARTNERTM_REDELIVERCOMMIT as Initiator.....	395
3.7.5.2.2.1.1	Receiving a PARTNERTM_REDELIVERCOMMIT_MTAG_COMMITREQDONE Message.....	395
3.7.5.2.2.1.2	Receiving a PARTNERTM_REDELIVERCOMMIT_MTAG_RETRY Message.....	395
3.7.5.2.2.1.3	Connection Disconnected.....	396
3.7.6	Timer Events.....	396
3.7.6.1	Redeliver Commit Timer	396
3.7.7	Other Local Events.....	397
3.7.7.1	Begin Commit.....	397
3.7.7.2	Begin Phase One.....	397
3.7.7.3	Begin Phase Zero	398
3.7.7.4	Begin Rollback.....	398
3.7.7.5	Create Phase Zero Enlistment Failure	399
3.7.7.6	Create Phase Zero Enlistment Success.....	399
3.7.7.7	Create Subordinate Enlistment Failure	399
3.7.7.8	Create Subordinate Enlistment Success	400
3.7.7.9	Phase Zero Aborted.....	400
3.7.7.10	Propagate Transaction	400
3.8	Subordinate Transaction Manager Facet Details	401
3.8.1	Abstract Data Model.....	401
3.8.1.1	CONNTYPE_PARTNERTM_PROPAGATE Acceptor States.....	401
3.8.1.1.1	Idle	403
3.8.1.1.2	Propagating	403
3.8.1.1.3	Active	403
3.8.1.1.4	Aborting	404
3.8.1.1.5	Awaiting Registration Response.....	404
3.8.1.1.6	Awaiting Phase Zero	404
3.8.1.1.7	Awaiting Phase Zero Outcome.....	404
3.8.1.1.8	Awaiting Registration Response During Phase Zero	404
3.8.1.1.9	Awaiting Phase Zero Outcome with Outstanding Registration	404
3.8.1.1.10	Preparing	405
3.8.1.1.11	Prepared	405
3.8.1.1.12	Committing.....	405
3.8.1.1.13	Ended	405
3.8.1.2	CONNTYPE_PARTNERTM_BRANCH Initiator States.....	405
3.8.1.2.1	Idle	406
3.8.1.2.2	Awaiting Branch Response.....	406
3.8.1.2.3	Active	407
3.8.1.2.4	Aborting.....	407
3.8.1.2.5	Awaiting Registration Response.....	407
3.8.1.2.6	Awaiting Phase Zero	407
3.8.1.2.7	Awaiting Phase Zero Outcome.....	407
3.8.1.2.8	Awaiting Registration Response During Phase Zero	407
3.8.1.2.9	Awaiting Phase Zero Outcome with Outstanding Registration	408
3.8.1.2.10	Preparing	408
3.8.1.2.11	Prepared	408
3.8.1.2.12	Committing.....	408
3.8.1.2.13	Ended	408
3.8.1.3	CONNTYPE_PARTNERTM_REDELIVERCOMMIT Acceptor States	408

3.8.1.3.1	Idle	409
3.8.1.3.2	Processing Commit Inquiry	409
3.8.1.3.3	Ended	409
3.8.1.4	CONNTYPE_PARTNERTM_CHECKABORT Initiator States	410
3.8.1.4.1	Idle	410
3.8.1.4.2	Awaiting Confirmation	410
3.8.1.4.3	Waiting to ReRequest	411
3.8.1.4.4	Ended	411
3.8.2	Timers	411
3.8.2.1	Check Abort Timer	411
3.8.3	Initialization	411
3.8.4	Higher-Layer Triggered Events	412
3.8.5	Processing Events and Sequencing Rules	412
3.8.5.1	Transaction Propagation and Coordination	412
3.8.5.1.1	Push Propagation	412
3.8.5.1.1.1	CONNTYPE_PARTNERTM_PROPAGATE as Acceptor	412
3.8.5.1.1.1.1	Receiving a PARTNERTM_PROPAGATE_MTAG_PROPAGATE Message 412	
3.8.5.1.1.1.2	Receiving Other PARTNERTM_PROPAGATE_MTAG Messages.....	413
3.8.5.1.1.1.3	Receiving a PARTNERTM_PROPAGATE_MTAG_PROTOCOL_ERROR Message	413
3.8.5.1.1.1.4	CONNTYPE_PARTNERTM_PROPAGATE Connection Disconnected ..	413
3.8.5.1.2	Pull Propagation	414
3.8.5.1.2.1	CONNTYPE_PARTNERTM_BRANCH as Initiator	414
3.8.5.1.2.1.1	Receiving a PARTNERTM_BRANCH_MTAG_BRANCHED Message	414
3.8.5.1.2.1.2	Receiving a PARTNERTM_BRANCH_MTAG_BRANCH_LOG_FULL, PARTNERTM_BRANCH_MTAG_BRANCH_NO_MEM, PARTNERTM_BRANCH_MTAG_BRANCH_TOO_LATE, PARTNERTM_BRANCH_MTAG_BRANCH_TOO_MANY, or PARTNERTM_BRANCH_MTAG_BRANCH_TX_NOT_FOUND Message 414	
3.8.5.1.2.1.3	Receiving a PARTNERTM_PROPAGATE_MTAG_PHASE0REGISTERED Message	415
3.8.5.1.2.1.4	Receiving a PARTNERTM_PROPAGATE_MTAG_PHASE0REGISTRATIONREJECTED Message	415
3.8.5.1.2.1.5	Receiving a PARTNERTM_PROPAGATE_MTAG_ABORTREQ Message 416	
3.8.5.1.2.1.6	Receiving a PARTNERTM_PROPAGATE_MTAG_PHASE0 Message	416
3.8.5.1.2.1.7	Receiving a PARTNERTM_PROPAGATE_MTAG_PREPAREREQ Message 416	
3.8.5.1.2.1.8	Receiving a PARTNERTM_PROPAGATE_MTAG_COMMITREQ Message 417	
3.8.5.1.2.1.9	Receiving a PARTNERTM_PROPAGATE_MTAG_PROTOCOL_ERROR Message	417
3.8.5.1.2.1.10	Connection Disconnected.....	417
3.8.5.2	Transaction Recovery	418
3.8.5.2.1	Subordinate-Driven Recovery	418
3.8.5.2.1.1	CONNTYPE_PARTNERTM_CHECKABORT as Initiator	418
3.8.5.2.1.1.1	Receiving a PARTNERTM_CHECKABORT_MTAG_ABORTED Message 418	
3.8.5.2.1.1.2	Receiving a PARTNERTM_CHECKABORT_MTAG_RETRY Message	418
3.8.5.2.1.1.3	CONNTYPE_PARTNERTM_CHECKABORT Connection Disconnected 419	
3.8.5.2.2	Superior-Driven Recovery.....	419
3.8.5.2.2.1	CONNTYPE_PARTNERTM_REDELIVERCOMMIT as Acceptor.....	419
3.8.5.2.2.1.1	Receiving a PARTNERTM_REDELIVERCOMMIT_MTAG_COMMITREQ Message	419

3.8.5.2.2.1.2	Connection Disconnected.....	420
3.8.6	Timer Events.....	420
3.8.6.1	Check Abort Timer	420
3.8.7	Other Local Events.....	420
3.8.7.1	Branch Transaction	420
3.8.7.2	Cancel Check Abort	421
3.8.7.3	Commit Complete	421
3.8.7.4	Create Superior Enlistment Success	422
3.8.7.5	Create Superior Enlistment Failure	422
3.8.7.6	Phase Zero Complete	422
3.8.7.7	Phase One Complete	423
3.8.7.8	Recover In Doubt Transaction.....	424
3.8.7.9	Register Phase Zero	424
3.8.7.10	Rollback Complete	425
3.8.7.11	Unilaterally Aborted.....	425
4	Protocol Examples	426
4.1	Simple Transaction Scenario.....	426
4.1.1	Beginning a Transaction	426
4.1.2	Completing a Transaction	427
4.1.2.1	Committing the Transaction	428
4.2	Transaction Marshaling Scenario (Pull Propagation)	428
4.2.1	Marshaling the Transaction	429
4.2.2	Unmarshaling the Transaction	430
4.2.3	Branching the Transaction	432
4.3	Transaction Marshaling Scenario (Push Propagation)	434
4.3.1	Obtaining the Whereabouts of the Receiver's Transaction Manager	434
4.3.2	Exporting the Transaction	435
4.3.3	Propagating the Transaction.....	437
4.3.4	Importing the Transaction	439
4.4	Simple Enlistment Scenario	440
4.4.1	Registering with the Transaction Manager as a Resource Manager	440
4.4.2	Enlisting in an Existing Transaction	441
4.4.3	Responding to Enlistment Notifications	443
4.4.3.1	Responding to a Prepare Request Message	443
4.4.3.2	Responding to a Commit Request Message.....	444
4.5	Transaction Manager Two-Phase Commit Scenario	444
4.5.1	Phase One	445
4.5.1.1	Phase One - Subordinate Resource Managers	445
4.5.1.2	Phase One - Subordinate Transaction Manager Facets	446
4.5.1.3	Phase One - The Root Transaction Manager.....	447
4.5.2	Phase Two	448
4.5.2.1	Phase Two - Subordinate Resource Managers	448
4.5.2.2	Phase Two - Subordinate Transaction Manager Facets	448
4.5.2.3	Phase Two - The Root Transaction Manager.....	449
4.6	Resource Manager Recovery Scenario	449
4.6.1	Initializing the Recovery Process.....	450
4.6.2	Reenlisting in In-Doubt Transactions	450
4.6.3	Completing Recovery	452
5	Security.....	453
5.1	Security Considerations for Implementers	453
5.2	Index of Security Parameters	454
6	Appendix A: Product Behavior	455
7	Change Tracking.....	460
8	Index.....	461

1 Introduction

This document specifies a comprehensive distributed transaction processing protocol that is referred to in this document as OleTx.

The MSDTC Connection Manager: OleTx Transaction Protocol is a concrete manifestation of the Two-Phase Commit protocol for coordinating the work of multiple parties in a distributed system. This document specifies the syntax and semantics of the protocol but does not attempt to provide a primer on transaction processing in general.

The Two-Phase Commit protocol ensures that work associated with a transaction is atomic across multiple participating resources. Each resource is controlled by a resource manager. A resource manager has the responsibility of interacting with a transaction manager to perform the steps necessary to implement the Two-Phase Commit protocol.

In the first phase of the Two-Phase Commit protocol, the transaction manager asks each participating resource manager to "prepare" for transaction commit. Each resource manager then decides if it can allow the transaction commit to continue or if the transaction will be aborted. Each resource manager informs the transaction manager of its decision through either a "prepared" notification or a "rollback" notification. If all participating resource managers respond with "prepared", thus agreeing that the transaction commit can continue, the transaction manager makes the outcome decision permanent and moves on to the second phase of the Two-Phase Commit protocol.

In the second phase of the Two-Phase Commit protocol, the transaction manager informs all the resource managers of the final outcome decision for the transaction. This step is necessary because when a resource manager provides a "prepared" vote in the first phase, it is in an "in-doubt" state, pending the outcome of the transaction. The resource manager has promised to commit its work on the transaction, but because the final outcome of the transaction is unknown, it cannot yet treat the updates as permanent. The transaction manager informs each resource manager that the transaction either committed or aborted during this second phase. In the case of a commit decision, the resource managers are responsible for acknowledging to the transaction manager that they have received the commit notification. This step is required because the transaction manager has the responsibility of retaining the committed outcome of the transaction until all resource managers have acknowledged that they have received the outcome and have confirmed that they will not request them again.

The Two-Phase Commit protocol is also used between two transaction managers when a transaction is distributed between them. The originating transaction manager is considered the superior, while the receiving transaction manager is considered subordinate. With respect to the Two-Phase Commit protocol, the superior transaction manager asks the subordinate transaction manager to "prepare" in the first phase, and the subordinate transaction manager then performs the Two-Phase Commit protocol with its resource managers and subordinate transaction managers, if any, before responding "prepared" back to the superior transaction manager. In the second phase, the outcome of the transaction is communicated from the superior to the subordinate, and the subordinate acknowledges its receipt.

This commit coordination ensures that either all of the resource managers end up committing their work on a transaction, or none of them does, thereby guaranteeing atomicity of the data updated by a single transaction.

Section 1.3.1, covering the transaction lifetime, provides a more complete description of the Two-Phase Commit protocol. Section 10.4 of [GRAY] also provides an excellent description.

The MSDTC Connection Manager: OleTx Transaction Protocol uses the transports protocol described in [MS-CMPO], and the multiplexing protocol described in [MS-CMP], as a transport layer. This protocol provides concrete mechanisms for beginning, propagating, and completing atomic transactions. It also provides mechanisms for coordinating agreement on a single atomic outcome for each transaction and for reliably distributing that outcome to all participants in the transaction.

This protocol is applicable to application scenarios where atomic transaction processing is a requirement. This protocol is usable in network topologies where the transports protocol, together with the multiplexing protocol, are a viable network transport for establishing long-lived session relationships between the participants in an atomic transaction.

Sections 1.5, 1.8, 1.9, 2, and 3 of this specification are normative. All other sections and examples in this specification are informative.

1.1 Glossary

This document uses the following terms:

abort outcome: A possible outcome of an atomic transaction that indicates that the work performed during the lifetime of the transaction is discarded after the transaction completes. An abort outcome is reached when at least one transaction participant does not agree to commit the transaction.

abort request: An action that a participant performs to force a transaction to reach an abort outcome.

acceptor: A participant that receives a session or connection request. This role is also known as the "subordinate".

ACID: A term that refers to the four properties that any database system must achieve in order to be considered transactional: Atomicity, Consistency, Isolation, and Durability [GRAY].

active phase: The time during the lifetime of an atomic transaction before the commit request when the participants in the transaction (applications and resource managers) perform all their intended work operations inside the transaction.

application: A participant that is responsible for beginning, propagating, and completing an atomic transaction. An application communicates with a transaction manager in order to begin and complete transactions. An application communicates with a transaction manager in order to marshal transactions to and from other applications. An application also communicates in application-specific ways with a resource manager in order to submit requests for work on resources.

atomic transaction: A shared activity that provides mechanisms for achieving the atomicity, consistency, isolation, and durability (ACID) properties when state changes occur inside participating resource managers.

begin request: The action that is performed by a root application in order to create a new atomic transaction.

client: A computer on which the remote procedure call (RPC) client is executing.

commit outcome: One of the outcomes of an atomic transaction. The commit outcome indicates that the work performed during the lifetime of the transaction will be retained after the transaction has completed, as specified by the ACID properties. A commit outcome is reached when all transaction participants agree to commit the transaction.

commit request: The action that is performed by a root application to initiate the Two-Phase Commit Protocol for an atomic transaction.

connection: In OleTx, an ordered set of logically related messages. The relationship between the messages is defined by the higher-layer protocol, but they are guaranteed to be delivered exactly one time and in order relative to other messages in the connection.

connection type: A specific set of interactions between participants in an OleTx protocol that accomplishes a specific set of state changes. A connection type consists of a bidirectional

sequence of messages that are conveyed by using the MSDTC Connection Manager: OleTx Transports Protocol and the MSDTC Connection Manager: OleTx Multiplexing Protocol transport protocol, as described in [MS-CMPO] and [MS-CMP]. A specified transaction typically involves many different connection types during its lifetime.

contact identifier: A universally unique identifier (UUID) that identifies a partner in the MSDTC Connection Manager: OleTx Transports Protocol. These UUIDs are frequently converted to and from string representations. This string representation must follow the format specified in [C706] Appendix A. In addition, the UUIDs must be compared, as specified in [C706] Appendix A.

core transaction manager facet: The facet that acts as the internal coordinator of each transaction that is inside the transaction manager. The core transaction manager facet communicates with other facets in its transaction manager to ensure that each transaction is processed correctly. To accomplish this, the core transaction manager facet maintains critical transaction state, in both volatile memory and in a durable store, such as in a log file.

distributed transaction: A transaction that updates data on two or more networked computer systems. Distributed transactions extend the benefits of transactions to applications that must update distributed data.

durable resource: A resource whose state is expected to be retained beyond the lifetime of a particular resource manager connection. Durable resources are managed by durable resource managers.

durable resource manager: A resource manager that manages resources whose states are expected to be maintained beyond the lifetime of a particular resource manager connection.

endpoint: A network-specific address of a remote procedure call (RPC) server process for remote procedure calls. The actual name and type of the endpoint depends on the RPC protocol sequence that is being used. For example, for RPC over TCP (RPC Protocol Sequence `ncacn_ip_tcp`), an endpoint might be TCP port 1025. For RPC over Server Message Block (RPC Protocol Sequence `ncacn_np`), an endpoint might be the name of a named pipe. For more information, see [C706].

enlistment: The relationship between a participant and a transaction manager in an atomic transaction. The term typically refers to the relationship between a resource manager and its transaction manager, or between a subordinate transaction manager facet and its superior transaction manager facet.

extended whereabouts: The data that is provided by a protocol extension and that indicates its network endpoint location and other information that is relevant to the protocol extension.

facet: In OleTx, a subsystem in a transaction manager that maintains its own per-transaction state and responds to intra-transaction manager events from other facets. A facet can also be responsible for communicating with other participants of a transaction.

globally unique identifier (GUID): A term used interchangeably with universally unique identifier (UUID) in Microsoft protocol technical documents (TDs). Interchanging the usage of these terms does not imply or require a specific algorithm or mechanism to generate the value. Specifically, the use of this term does not imply or require that the algorithms described in [RFC4122] or [C706] must be used for generating the GUID. See also universally unique identifier (UUID).

In Doubt outcome: One of the outcomes of an atomic transaction. The In Doubt outcome indicates that a commit request was issued by the root application but that the transaction manager cannot ascertain the actual commit or abort decision.

initiator: A participant that originates a session or connection request.

message tag (MTAG): A message that is sent between participants in the context of connections.

NULL GUID: A GUID of all zeros.

OleTx: A comprehensive distributed transaction manager processing protocol that uses the protocols specified in the following document(s): [MS-CMPO], [MS-CMP], [MS-DTCLU], [MS-DTCM], [MS-DTCO], [MC-DTCXA], [MS-TIPP], and [MS-CMOM].

outcome: One of the three possible results (Commit, Abort, In Doubt) reachable at the end of a life cycle for an atomic transaction.

participant: Any of the parties that are involved in an atomic transaction and that have a stake in the operations that are performed under the transaction or in the outcome of the transaction ([WSAT10], [WSAT11]).

Phase One enlistment: An enlistment that indicates that the subordinate participant participates in Phase One.

Phase One participant: A participant in a Phase One enlistment.

Phase Two enlistment: An enlistment that indicates that the subordinate participant participates in Phase Two.

Phase Zero: A phase in distributed transaction processing that is composed of one or more Phase Zero waves. At the beginning of a Phase Zero wave, all Phase Zero participants are notified that the transaction has entered Phase Zero. While the participants process the Phase Zero notification, they can continue to marshal the transaction to new participants. Consequently, participating transaction managers can still accept new enlistments during Phase Zero.

Phase Zero enlistment: An enlistment that indicates that the subordinate participant participates in Phase Zero.

Phase Zero participant: A participant with a Phase Zero enlistment.

Phase Zero wave: A discrete stage inside Phase Zero processing in which Phase Zero notifications are sent to all known Phase Zero enlistments. New Phase Zero enlistments that appear during a Phase Zero wave are processed during the next Phase Zero wave. The process is repeated until a Phase Zero wave is processed without the creation of new Phase Zero enlistments.

presumed abort: An optimization of the Two-Phase Commit Protocol in which a transaction manager omits persisting transaction abort outcomes from a durable store.

protocol extension: An addition of new integrated behavior to an existing protocol.

pull propagation: An operation that enables the untargeted marshaling of a transaction from one application or resource manager to another. Pull propagation allows the source participant to marshal the transaction without the prior knowledge of the contact information of the transaction manager of the destination participant.

push propagation: An operation that enables the targeted marshaling of a transaction from one application or resource manager to another. For marshaling the transaction, push propagation requires the source participant to have prior knowledge about the contact information of the transaction manager of the destination participant.

recovery: The process of reestablishing connectivity and synchronizing views on the outcome of transactions between two participants after a transient failure. Recovery occurs either between a resource manager and a transaction manager, or between a Superior Transaction Manager Facet and a Subordinate Transaction Manager Facet.

resource: A logical entity or unit of data whose state changes in accordance with the outcome of an atomic transaction. Resources are either durable or volatile.

resource manager (RM): The participant that is responsible for coordinating the state of a resource with the outcome of atomic transactions. For a specified transaction, a resource manager enlists with exactly one transaction manager to vote on that transaction outcome and to obtain the final outcome. A resource manager is either durable or volatile, depending on its resource.

resource manager identifier: The GUID that uniquely identifies the resource manager.

resource manager session identifier: The GUID that uniquely identifies a particular session between the resource manager and a transaction manager.

rollback: Synonymous with abort.

root application: The application that is responsible for beginning and completing an atomic transaction. The root application communicates with a root transaction manager in order to begin and complete transactions.

root transaction manager: The specific transaction manager that processes both the Begin Request and the Commit Request for a specified transaction. A specified transaction has exactly one root transaction manager.

server: A computer on which the remote procedure call (RPC) server is executing.

session: In OleTx, a transport-level connection between a Transaction Manager and another Distributed Transaction participant over which multiplexed logical connections and messages flow. A session remains active so long as there are logical connections using it.

single-phase commit: An optimization of the Two-Phase Commit Protocol in which a transaction manager delegates the right to decide the outcome of a transaction to its only subordinate participant. This optimization can result in an In Doubt outcome.

subordinate participant: A role that is taken by a participant that is responsible for voting on the outcome of an atomic transaction. For a specified transaction, the set of subordinate participants is the set of all resource managers and the set of all subordinate transaction managers.

subordinate transaction manager: A role taken by a transaction manager that is responsible for voting on the outcome of an atomic transaction. A subordinate transaction manager coordinates the voting and notification of its subordinate participants on behalf of its superior transaction manager. When communicating with those subordinate participants, the subordinate transaction manager acts in the role of superior transaction manager. The root transaction manager is never a subordinate transaction manager. A subordinate transaction manager has exactly one superior transaction manager.

superior transaction manager: A role taken by a transaction manager that is responsible for gathering outcome votes and providing the final transaction outcome. A root transaction manager can act as a superior transaction manager to a number of subordinate transaction managers. A transaction manager can act as both a subordinate transaction manager and a superior transaction manager on the same transaction.

transaction: In OleTx, an atomic transaction.

transaction description: An implementation-specific string that is associated with an atomic transaction and is often used to provide human-readable information about the transaction. Description strings are typically provided by the higher-layer software.

transaction identifier: The GUID that uniquely identifies an atomic transaction.

transaction lifetime: The lifetime of an atomic transaction. The transaction lifetime extends from the time when the root transaction manager processes a begin request to the time when all participants have forgotten the transaction.

transaction manager: The party that is responsible for managing and distributing the outcome of atomic transactions. A transaction manager is either a root transaction manager or a subordinate transaction manager for a specified transaction.

transaction marshaling: The act of serializing and deserializing the information that is needed to carry out a transaction propagation action on a specified transaction.

transaction propagation: The act of coordinating two transaction managers to work together on a single atomic transaction. When propagating a transaction to a transaction manager that is not already a participant in the transaction, that transaction manager plays the role of subordinate transaction manager to the originating transaction manager, which will play the role of superior transaction manager. When propagating a transaction to a transaction manager that is already a participant in the transaction, no new superior or subordinate relationship is established.

transient failure: Any event that could result in a loss of transport connectivity between participants, such as a software crash, a software restart, or a temporary problem with network connections.

two-phase commit: An agreement protocol that is used to resolve the outcome of an atomic transaction in response to a commit request from the root application. Phase One and Phase Two are the distinct phases of the Two-Phase Commit Protocol.

Unicode: A character encoding standard developed by the Unicode Consortium that represents almost all of the written languages of the world. The Unicode standard [UNICODE5.0.0/2007] provides three forms (UTF-8, UTF-16, and UTF-32) and seven schemes (UTF-8, UTF-16, UTF-16 BE, UTF-16 LE, UTF-32, UTF-32 LE, and UTF-32 BE).

volatile resource: A resource whose value is not expected to be retained beyond the lifetime of a particular resource manager connection.

volatile resource manager: A resource manager that manages volatile resources. A volatile resource manager does not perform recovery operations.

voter: A participant in an atomic transaction that contributes to the final outcome of the transaction but does not manage access to durable resources or require recovery services. A voter votes on the outcome of the transaction, but it is provided with only best-effort outcome notifications by the transaction manager. A volatile resource manager typically acts as a voter.

voter enlistment: An enlistment that indicates that the voter participates in Phase One.

whereabouts: Data that indicates the network endpoint location and properties of a transaction manager.

work: The set of state changes that are applied to resources inside an atomic transaction.

MAY, SHOULD, MUST, SHOULD NOT, MUST NOT: These terms (in all caps) are used as defined in [RFC2119]. All statements of optional behavior use either MAY, SHOULD, or SHOULD NOT.

1.2 References

Links to a document in the Microsoft Open Specifications library point to the correct section in the most recently published version of the referenced document. However, because individual documents in the library are not updated at the same time, the section numbers in the documents may not match. You can confirm the correct section numbering by checking the Errata.

1.2.1 Normative References

We conduct frequent surveys of the normative references to assure their continued availability. If you have any issue with finding a normative reference, please contact dochelp@microsoft.com. We will assist you in finding the relevant information.

[C193] The Open Group, "Distributed TP: The XA Specification", February 1992, <https://www2.opengroup.org/ogsys/catalog/c193>

[C706] The Open Group, "DCE 1.1: Remote Procedure Call", C706, August 1997, <https://www2.opengroup.org/ogsys/catalog/c706>

[ISO/IEC-8859-1] International Organization for Standardization, "Information Technology -- 8-Bit Single-Byte Coded Graphic Character Sets -- Part 1: Latin Alphabet No. 1", ISO/IEC 8859-1, 1998, http://www.iso.org/iso/home/store/catalogue_tc/catalogue_detail.htm?csnumber=28245

Note There is a charge to download the specification.

[MS-CMOM] Microsoft Corporation, "MSDTC Connection Manager: OleTx Management Protocol".

[MS-CMPO] Microsoft Corporation, "MSDTC Connection Manager: OleTx Transports Protocol".

[MS-CMP] Microsoft Corporation, "MSDTC Connection Manager: OleTx Multiplexing Protocol".

[MS-CMRP] Microsoft Corporation, "Failover Cluster: Management API (ClusAPI) Protocol".

[MS-DTYP] Microsoft Corporation, "Windows Data Types".

[MS-RRP] Microsoft Corporation, "Windows Remote Registry Protocol".

[MS-TIPP] Microsoft Corporation, "Transaction Internet Protocol (TIP) Extensions".

[MS-WKST] Microsoft Corporation, "Workstation Service Remote Protocol".

[MS-WSRVCAT] Microsoft Corporation, "WS-AtomicTransaction (WS-AT) Version 1.0 Protocol Extensions".

[NETBEUI] IBM Corporation, "LAN Technical Reference: 802.2 and NetBIOS APIs", 1986, http://publibz.boulder.ibm.com/cgi-bin/bookmgr_OS390/BOOKS/BK8P7001/CCONTENTS

[RFC1001] Network Working Group, "Protocol Standard for a NetBIOS Service on a TCP/UDP Transport: Concepts and Methods", RFC 1001, March 1987, <http://www.ietf.org/rfc/rfc1001.txt>

[RFC1002] Network Working Group, "Protocol Standard for a NetBIOS Service on a TCP/UDP Transport: Detailed Specifications", STD 19, RFC 1002, March 1987, <http://www.rfc-editor.org/rfc/rfc1002.txt>

[RFC2119] Bradner, S., "Key words for use in RFCs to Indicate Requirement Levels", BCP 14, RFC 2119, March 1997, <http://www.rfc-editor.org/rfc/rfc2119.txt>

[RFC2371] Lyon, J., Evans, K., and Klein, J., "Transaction Internet Protocol Version 3.0", RFC 2371, July 1998, <http://www.ietf.org/rfc/rfc2371.txt>

[RFC4122] Leach, P., Mealling, M., and Salz, R., "A Universally Unique Identifier (UUID) URN Namespace", RFC 4122, July 2005, <http://www.ietf.org/rfc/rfc4122.txt>

1.2.2 Informative References

[GRAY] Gray, J., and Reuter, A., "Transaction Processing: Concepts and Techniques", [San Mateo, CA: The Morgan Kaufmann Series in Data Management Systems, San Francisco](#): Morgan Kaufmann Publishers, [1993,1992, Hardcover](#) ISBN: [1558601902,9781558601901..](#)

[MC-DTCXA] Microsoft Corporation, "MSDTC Connection Manager: OleTx XA Protocol".

[MS-COM] Microsoft Corporation, "Component Object Model Plus (COM+) Protocol".

[MS-DTCLU] Microsoft Corporation, "MSDTC Connection Manager: OleTx Transaction Protocol Logical Unit Mainframe Extension".

[MS-DTCM] Microsoft Corporation, "MSDTC Connection Manager: OleTx Transaction Internet Protocol".

[MS-MQMP] Microsoft Corporation, "Message Queuing (MSMQ): Queue Manager Client Protocol".

[MS-MQRR] Microsoft Corporation, "Message Queuing (MSMQ): Queue Manager Remote Read Protocol".

[MSDN-ANSI] Microsoft Corporation, "Unicode and Character Sets", <http://msdn.microsoft.com/en-us/library/dd374083.aspx>

1.3 Overview

This section presents a brief overview of the following topics:

- The life cycle of a transaction, including the Two-Phase Commit protocol
- The distinct roles that are played by participants in transaction processing
- Transaction recovery details
- Transaction marshaling and propagation details

1.3.1 Transaction Lifetime

At a general level, a transaction consists of a set of operations that an application or a set of applications treats as an atomic unit. These applications typically use one or more resource managers to modify and store the state that is affected by the transaction. The applications and resource managers make use of transaction managers to obtain a set of services. These roles are described further in section 1.3.3.

The lifetime of a transaction begins when an application determines that it needs a new transaction. The application assumes the role of root application and issues a Begin request to the root transaction manager. When a new transaction is created, either the root application or the root transaction manager assigns it an identifier that is unique in both time and space.

After the transaction is created, it enters the active phase. In the active phase, applications and resource managers perform all their intended actions inside the transaction.

Resource managers that perform work inside an atomic transaction contact their transaction manager to enlist on the transaction. By enlisting in a transaction, the resource manager is agreeing to participate in the Two-Phase Commit Protocol.

Applications and resource managers often share a transaction with a participant that is not located in the same operating system process or execution context. In this case, the application marshals the transaction to the other participant over an implementation-specific communication mechanism. If the receiving participant does not share a transaction manager with the sending participant, a transaction

propagation handshake occurs to coordinate the transaction managers at both the sender and receiver of the transaction. After the transaction is successfully marshaled and (if needed) propagated, the receiving participant can perform operations on the transaction with its own transaction manager and also marshal the transaction to further participants.

As transaction enlistment and propagation occurs, the collection of resource managers and transaction managers relate to each other in a hierarchy known as a transaction tree.

The following figure depicts the transaction tree.

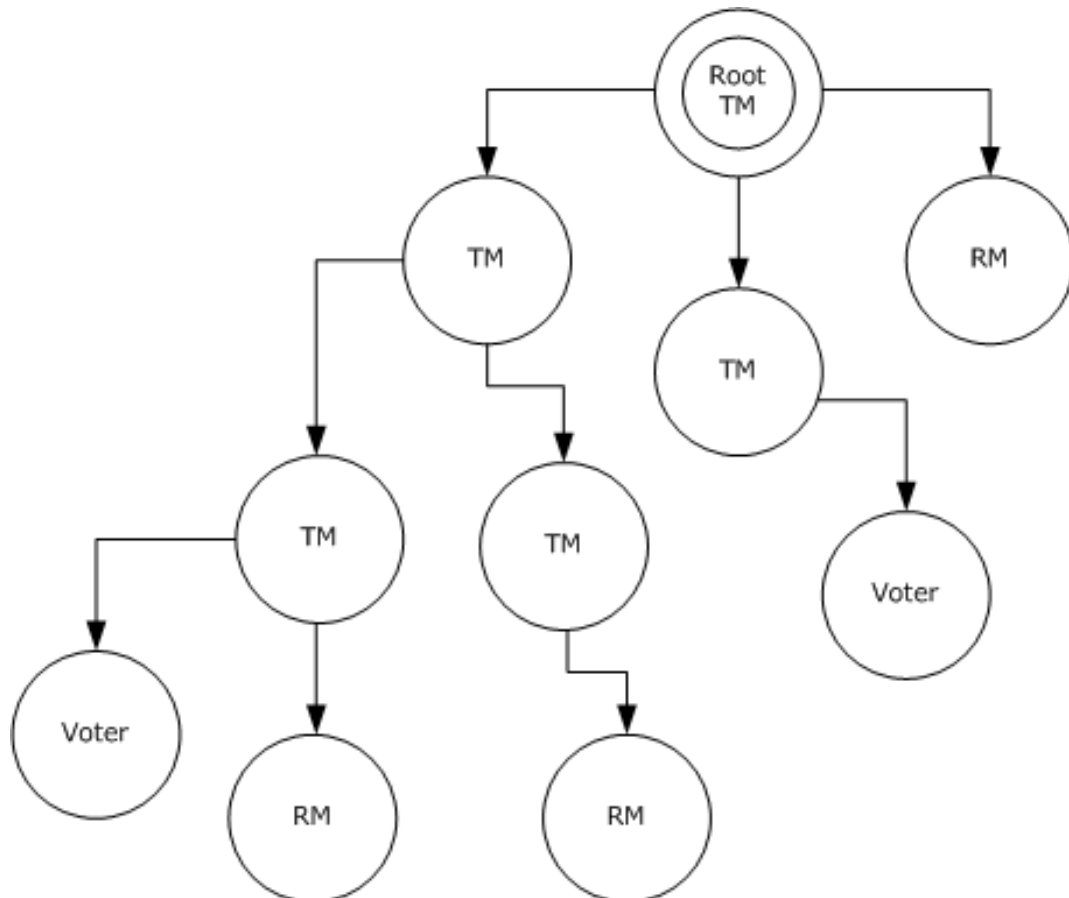

Figure 1: Transaction tree

Eventually, the root application that began the transaction determines that no more work is to be performed under the transaction. When that occurs, the application sends a Commit request to the root transaction manager to begin the process of completing the transaction.

When the root transaction manager receives the Commit request, it begins the process of determining the transaction outcome and communicating that outcome to all interested participants. That process begins with zero or more Phase Zero waves followed by Phase One and Phase Two of the Two-Phase Commit sequence.

1.3.1.1 Phase Zero

When a Commit request is issued by the root application, the transaction first enters Phase Zero. If there are no Phase Zero participants, the transaction leaves Phase Zero and proceeds to Phase One.

Phase Zero is composed of one or more Phase Zero waves. At the beginning of a Phase Zero wave, all Phase Zero participants are notified that the transaction has entered Phase Zero. While the participants process the Phase Zero notification, they can continue to marshal the transaction to new participants. Consequently, participating transaction managers can still accept new enlistments during Phase Zero.

When a Phase Zero participant completes its Phase Zero processing, it sends a Phase Zero completion notification back to the transaction manager.

If any of the Phase Zero participants fail or issue an Abort request during the Phase Zero wave, the current Phase Zero wave is terminated and the transaction immediately moves to the aborting state, which is discussed in section 1.3.2.1.

Otherwise, after completion notifications are received from all Phase Zero participants:

- If no new Phase Zero enlistments were created during the current Phase Zero wave, the transaction proceeds to Phase One.
- If one or more new Phase Zero enlistments were created during the current Phase Zero wave, the transaction executes another Phase Zero wave with the new Phase Zero participants.

The following figure shows the overall Phase Zero flow.

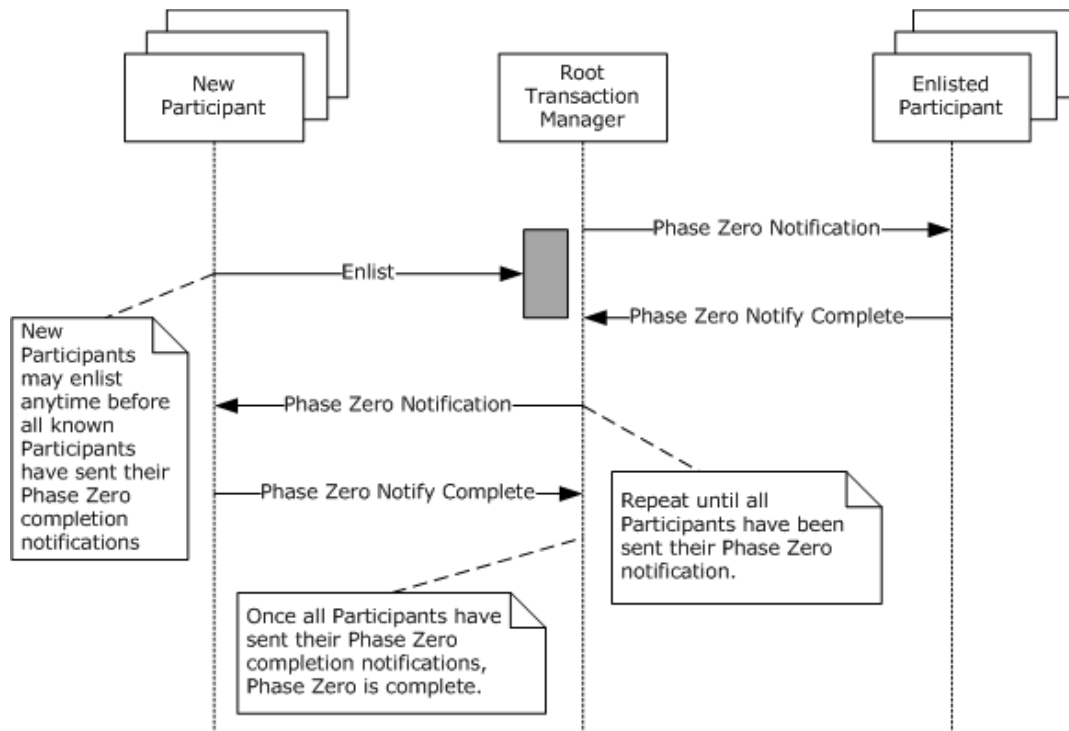

Figure 2: Transaction manager Phase Zero flow

1.3.1.2 Phase One

When Phase One begins, all transaction participants are now presumed to have completed their work inside the transaction.

During Phase One, each Phase One participant is asked to vote on the outcome of the transaction. Each participant vote can have one of three possible results:

- Read Only: The participant agrees for the transaction to Commit but does not require an outcome notification.
- Prepared: The participant agrees for the transaction to Commit and requires an outcome notification.
- Aborted: The participant requires that the transaction abort.

Before a participant can vote Prepared, it performs whatever actions are necessary to be able to process an order to Commit or an order to Abort at some point in the future. Note that the request for a vote polls the transaction tree from the root transaction manager down to the leaf participants. When a subordinate transaction manager receives a request for a vote, it will first issue that request to all its immediate subordinates and process their votes before voting itself.

When all votes are collected by the root transaction manager, a decision about the transaction outcome is made. If every vote was either Read Only or Prepared, the root transaction manager attempts to record a Commit outcome decision. If successful, the Commit outcome decision is officially made.

Otherwise, if one or more of the votes is Aborted or if a Commit outcome decision cannot be successfully recorded, the transaction manager makes an Abort outcome decision.

After an outcome decision is made, the root transaction manager proceeds to Phase Two in order to distribute outcome notification messages throughout the transaction tree.

The following figure depicts the Phase One flow.

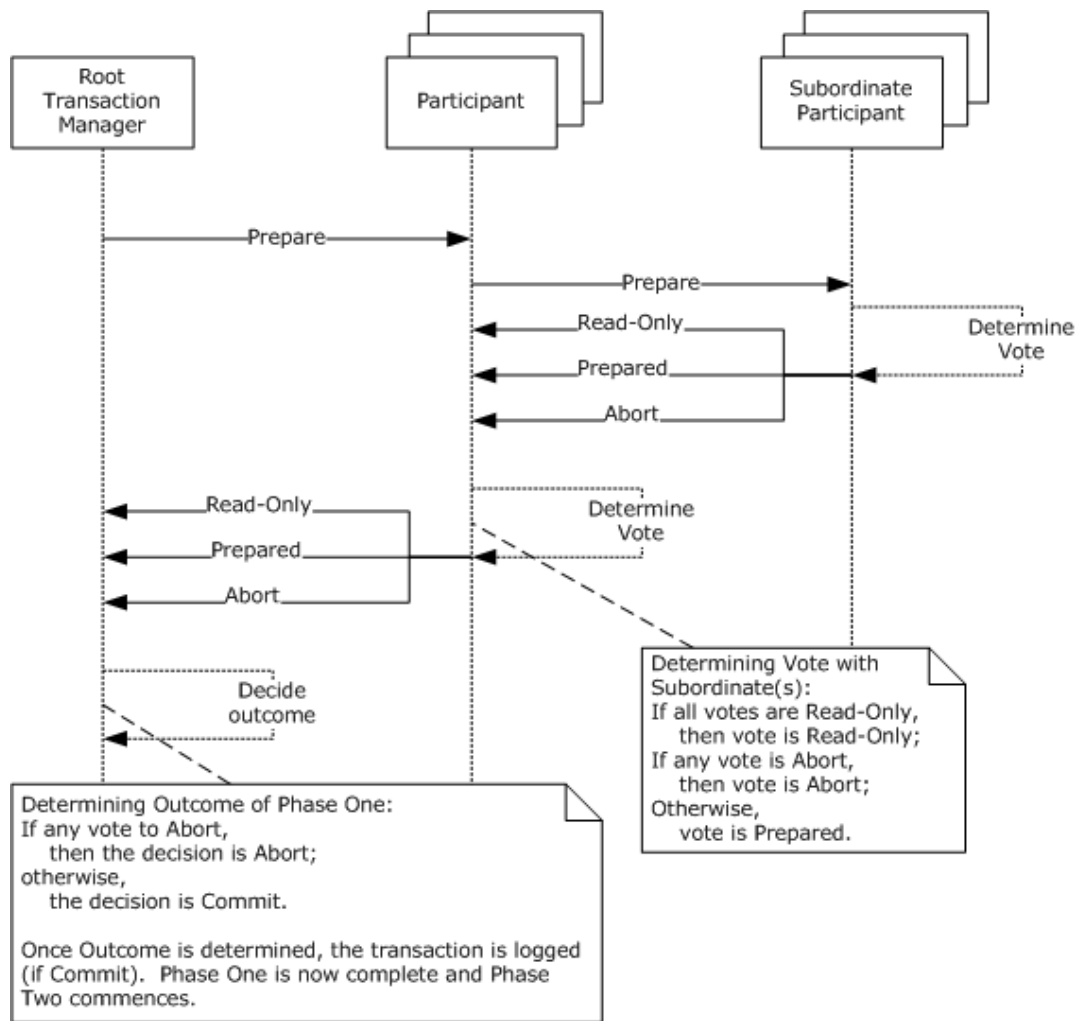

Figure 3: Transaction manager Phase One flow

1.3.1.3 Phase Two

When Phase Two begins, the root transaction manager has determined the transaction outcome.

If the transaction outcome is a Commit outcome, the transaction enters the committing state. Each participant that voted Prepared is sent an order to commit. The participants perform any necessary commit processing and respond with a committed notification.

If the transaction outcome is an Abort outcome, the transaction enters the Aborting state. Each participant that voted Prepared is sent an order to abort. The participants perform any necessary abort processing, and respond with an Aborted notification.

If a Prepared participant loses contact with its transaction manager, it is said to be In Doubt. If it is a durable resource manager, it attempts to reconnect to the transaction manager and perform recovery in order to learn the outcome of the transaction. See section 1.3.4 for recovery details.

In general, participants (including the root application) are sent the outcome decision notification in parallel.

Phase Two is complete when the root transaction manager sends the outcome decision notification to all the subordinate participants, the root transaction manager receives the reply notifications from all

the subordinate participants, and the root transaction manager does the necessary work to forget the transaction.

The following figure shows the Phase Two flow.

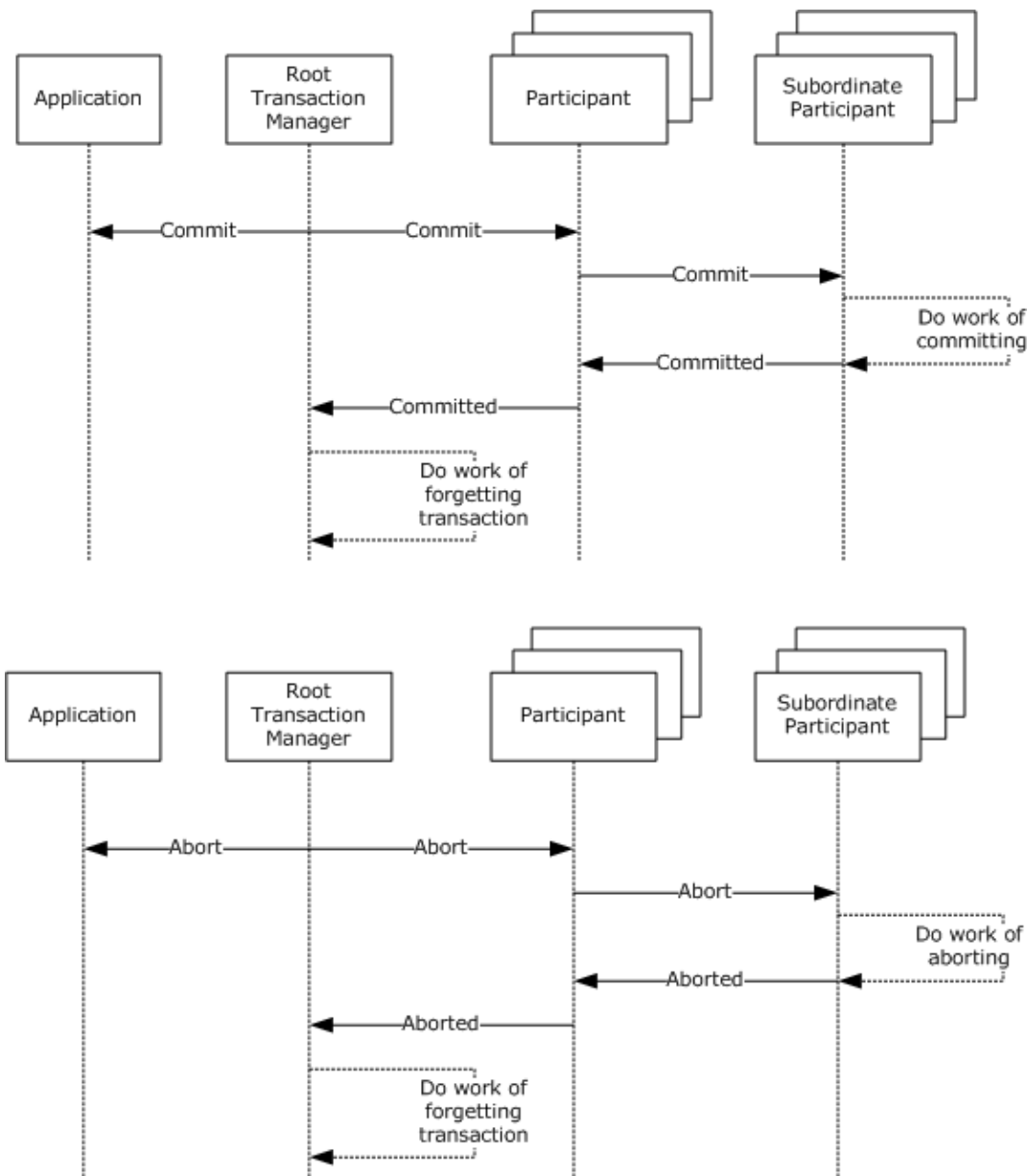

Figure 4: Transaction manager Phase Two flow

1.3.2 Additional Considerations

In addition to the two-phase commit processing described in the previous section, there are two more cases to consider:

- Unilateral abort

- Single-phase commit

1.3.2.1 Unilateral Abort

Until a participant votes on the outcome of the transaction, any participant can decide to unilaterally stop the transaction by issuing an Abort request to its transaction manager. This ability is known as a Unilateral Abort.

After a transaction manager receives an Abort request from one of its participants, it immediately transitions the transaction to the Aborting state, which guarantees an Abort outcome. All other participants will be notified of the Abort outcome, although it is possible that the root application does not discover the Abort outcome until it attempts to complete the transaction or perform some other operation involving the transaction manager or another participant.

After a specified transaction manager enters the Aborting state, it does not issue any further Phase Zero notifications or Phase One requests to vote. For a transaction that spans two or more transaction managers due to propagation, it is possible for the Abort outcome decision to race with other Phase Zero or Phase One activity as it is communicated between the transaction managers.

The following figure shows the Unilateral Abort flow.

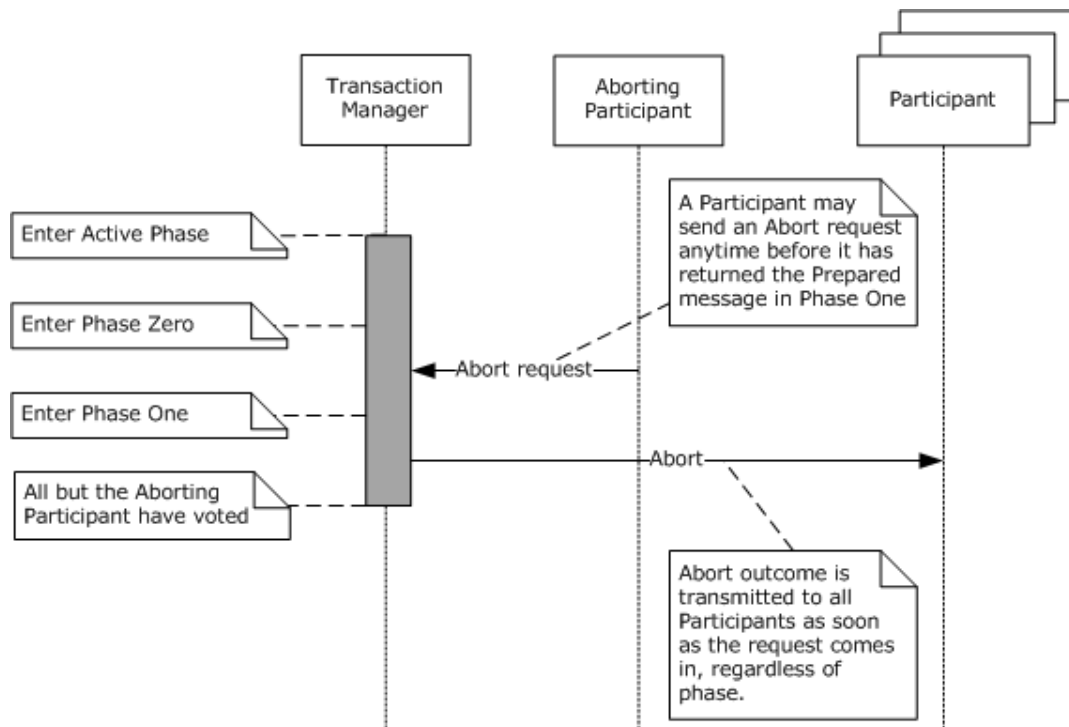

Figure 5: Unilateral Abort flow

1.3.2.2 Single-Phase Commit

If a transaction manager has exactly one subordinate Phase One enlistment, the transaction manager attempts to perform the single-phase commit optimization. In this case, the transaction manager sends the subordinate participant a request to perform a single-phase commit, instead of the standard Phase One Prepare request. This optimization delegates the right to decide the transaction outcome to the subordinate.

The subordinate accepts this delegation by making an outcome decision and eventually notifying the transaction manager; or it rejects the Single-Phase Commit request by responding Prepared. In the latter case, the transaction manager makes its own outcome decision and then engages in a standard Phase Two exchange with the participant.

There is a possible disadvantage to this optimization: if the transaction manager loses contact with the subordinate participant after sending the Single-Phase Commit request but before receiving an outcome notification, it has no reliable mechanism for recovering the actual outcome of the transaction. Consequently, the transaction manager sends an In Doubt outcome to any applications or voters awaiting informational outcome notification.

The single-phase commit optimization can be used by any transaction manager that has exactly one Phase One subordinate enlistment, not just the root transaction manager. For example, if transaction manager A has only transaction manager B as a subordinate enlistment, then A can use the single-phase commit optimization with B. If in the same transaction, B has only transaction manager C as a subordinate enlistment, it too can use the single-phase commit optimization with C. This is true regardless of the number of subordinate enlistments that are registered with C.

Note that a nonroot transaction manager performs only the single-phase Commit optimization if its own superior transaction manager has sent it a Single-Phase Commit request.

The following figure shows the Single-Phase Commit flow.

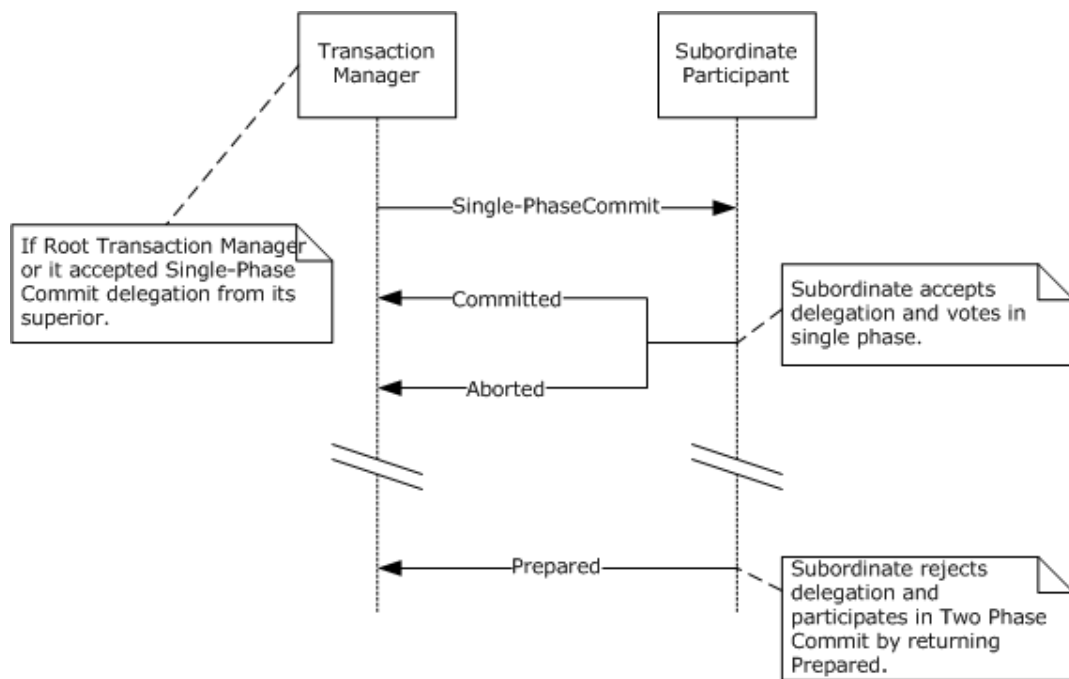

Figure 6: Single-Phase Commit flow

1.3.3 Transaction Roles

This protocol enables transaction processing to be distributed among two or more distinct participants. These participants are categorized according to three specialized roles that perform specific functions inside the transaction:

- Application role

- Resource manager role
- Transaction manager role

Each role is functionally independent of the other two. It is possible to implement the protocol functions that are required by any of these three roles without implementing the protocol functions that are required by the other two. For example, it is possible to implement a transactional resource manager without building a transaction manager or a transaction-aware application.

The following graphic depicts the transaction roles.

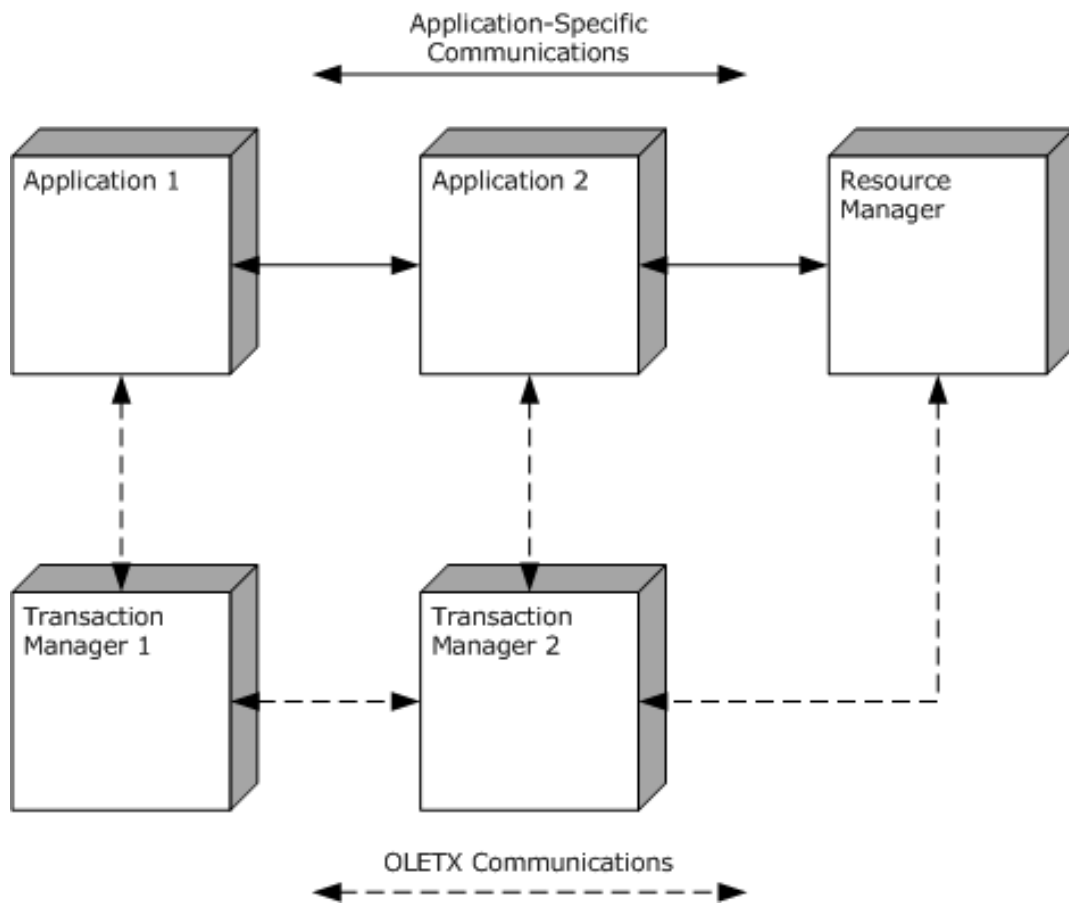

Figure 7: Transaction roles

1.3.3.1 Application Role

The application role is generally performed by user software programs that make use of transaction processing services in order to obtain greater reliability or reduce the complexity of error-handling tasks.

The application role is typically responsible for performing the following tasks:

- Determining when to begin a transaction
- Marshaling the transaction to other applications and to resource managers

- Propagating the transaction from one transaction manager to another
- Determining when to complete a transaction
- Performing administrative operations against a specific transaction
- Performing administrative operations against the transaction manager

In general, the motivations behind these tasks are application-specific. The protocol mechanisms by which these tasks can be accomplished are discussed in sections 2 and 3.

1.3.3.2 Resource Manager Role

The resource manager role is generally performed by software programs that manage transactional resources. Databases and queues are the most common examples of such programs.

This protocol supports three types of enlistments: Phase Zero enlistments, Phase One enlistments, and voter enlistments. These enlistment types correspond to three common categories of resource manager:

- Caching resource managers appear like a durable resource manager to an application, but they actually delegate their durable state changes to another resource manager that provides true durability. Caching resource managers typically use Phase Zero enlistments.
- Durable resource managers manage access to durable resources. They are expected to support recovery. Durable resource managers typically use Phase One enlistments.
- Volatile resource managers manage access to volatile resources whose state does not persist beyond the lifetime of the resource manager process. Volatile resource managers typically use voter enlistments.

The resource manager role is typically responsible for the following tasks:

- Providing applications with access to data in a transactional manner. This function is specific to the implementation of a resource manager.
- Registering with a transaction manager and performing recovery operations for all In Doubt transactions.
- Enlisting for various two-phase Commit notifications.
- Voting on transaction outcomes in accord with the implementation-specific policies of the resource manager.

In general, the motivations behind these tasks are application-specific. The specific protocol mechanisms by which these tasks are accomplished are discussed in sections 2 and 3.

1.3.3.3 Transaction Manager Role

The Transaction Manager Role is generally performed by specialized middleware software programs that provide transactional services to applications and resource managers.

The transaction manager role is typically responsible for the following tasks:

- Providing the following services to applications and resource managers:
 - Beginning transactions
 - Completing transactions

- Coordinating agreement with participants on the outcome of the transaction
- Reaching the decision to commit
- Ensuring the outcome decision is reliably distributed
- Coordinating the process of recovery if failures occur
- Coordinating the outcome of individual transactions by using the Two-Phase Commit protocol.
- Coordinating recovery with other participants after a process or communication failure. See section 1.3.4 for recovery details.

A transaction manager is best understood as the aggregation of several cooperating software modules that work together to provide the services previously mentioned. This document calls these software modules facets, and assumes the presence of the following five facets:

- A facet that acts as a core transaction manager
- A facet that communicates with applications
- A facet that communicates with resource managers
- A facet that acts as a superior transaction manager
- A facet that acts as a subordinate transaction manager

A transaction manager provides implementation-specific mechanisms to allow the facets to communicate with one another within the transaction manager itself.

In contrast, the transaction manager facets use the MSDTC Connection Manager: OleTx Transports Protocol as specified in [MS-CMPO], and the MSDTC Connection Manager: OleTx Multiplexing Protocol as specified in [MS-CMP], as transports for this protocol when they communicate with other participants (for example, applications, resource managers, and remote transaction managers). The subprotocols that are used to provide services to these participants are known as connection types. The specific connection types that are used in this protocol are specified in detail in section 3.

These facets are functionally dependent upon each other. A general-purpose transaction manager is composed of all five of these facets.

The following figure shows the transaction manager facets.

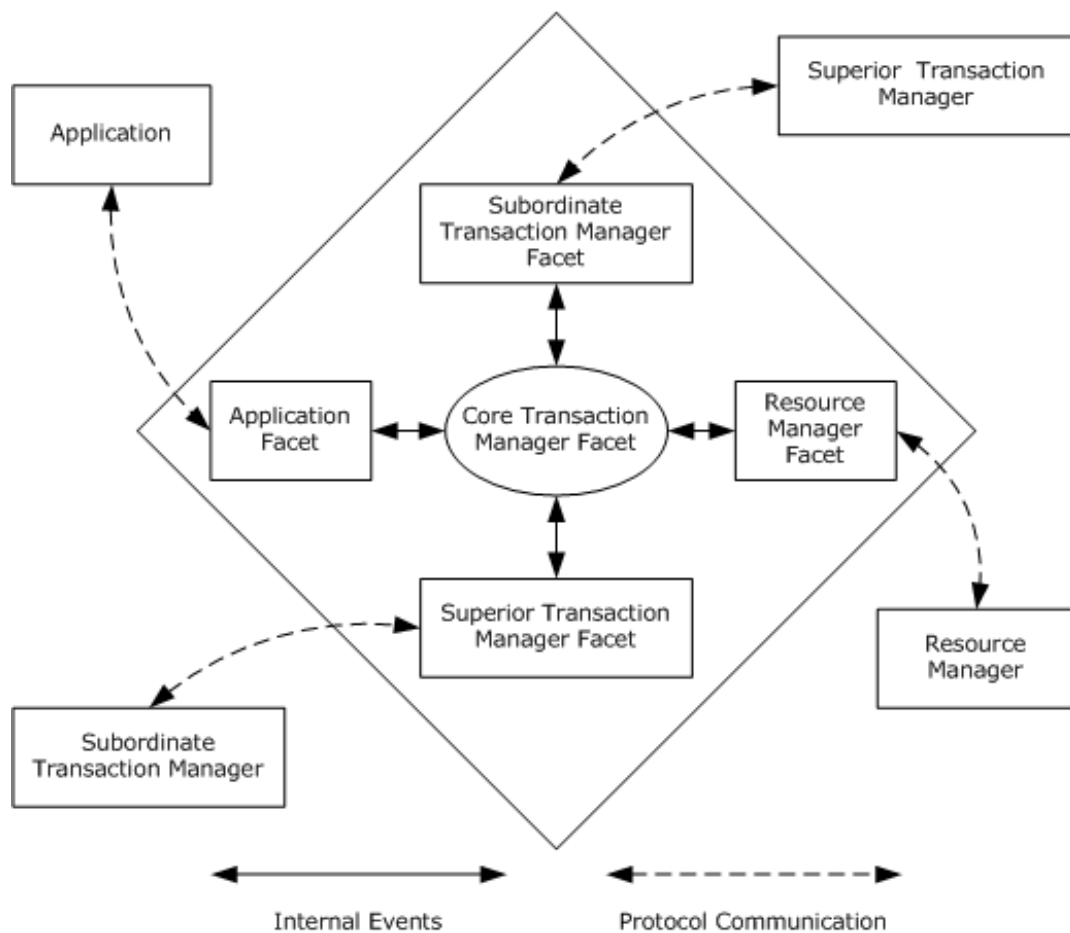

Figure 8: Transaction manager facets

1.3.3.3.1 Core Transaction Manager Facet

The Core Transaction Manager Facet is a logical construct in the context of this protocol. It never establishes network communication with any other transaction participant. It communicates with the other transaction manager facets through implementation-specific mechanisms.

1.3.3.3.2 Transaction Manager Communication with an Application Facet

When the transaction manager is communicating with an application facet, it provides the following services to applications:

- Transaction creation.
- Transaction propagation to a remote transaction manager.
- Transaction propagation by providing an existing transaction to the subordinate transaction manager facet for propagation.
- Transaction completion.
- Administrative operations against a specific transaction. These operations include:
 - Setting the time-out on a transaction.

- Obtaining transaction details, such as information about the superior transaction manager facet and the list of subordinate participants.
- Manually resolving the outcome of a transaction.
- Requesting that the transaction manager provide details of the transaction in its implementation-specific trace log.
- Administrative operations against the transaction manager. These operations include the ability to obtain information about the security configuration of the transaction manager.

1.3.3.3.3 Transaction Manager Communication with a Resource Manager Facet

When the transaction manager is communicating with a resource manager facet, it provides the following services to resource managers:

- Resource manager registration
- Recovery and outcome notification for In Doubt transactions
- Transaction enlistment for Phase Zero, Phase One, and voter participants
- Phase Zero, Phase One, and Phase Two notifications inside the Two-Phase Commit protocol

1.3.3.3.4 Superior Transaction Manager Facet

The Superior Transaction Manager Facet provides the following services to subordinate transaction manager facets:

- Acts as Superior Transaction Manager Facet to a number of subordinate transaction manager facets in the Two-Phase Commit protocol.
- Provides recovery and outcome notification for transactions that are left in the Failed to Notify state after a failure.

1.3.3.3.5 Subordinate Transaction Manager Facet

The Subordinate Transaction Manager Facet provides the following services to superior transaction manager facets:

- Acts as a Subordinate Transaction Manager Facet to a superior transaction manager facet in the Two-Phase Commit protocol.
- Provides recovery and outcome notification for transactions that are left in the In Doubt state after a failure.

1.3.4 Transaction Recovery

The atomicity property of a transaction guarantees that all participants in the transaction receive the same outcome. This guarantee is relaxed in the case of volatile resources such as voters but is strictly honored for durable resource managers and transaction managers.

To honor this guarantee, transaction managers and durable resource managers have to be capable of recovering from transient failures that can occur, such as loss of transport connectivity or a software crash. The process of recovery involves reestablishing connectivity with other transaction participants and exchanging the protocol messages that are required to synchronize all parties on the actual outcome of the transaction.

After a transient failure, the transaction manager reestablishes connectivity with the following parties:

- The superior transaction manager for each transaction for which the transaction manager was In Doubt at the time of the failure
- The subordinate transaction managers for which the transaction manager was in the Failed to Notify state at the time of the failure

After a transient failure, the resource manager reestablishes connectivity with the following parties:

- The superior transaction manager for each transaction for which the resource manager was In Doubt at the time of the failure

The following sections describe in more detail the recovery process for each participant.

1.3.4.1 Relationship Between Recovery and Durability

Transaction managers and durable resource managers can use any mechanism they choose to implement the durability guarantees of an atomic transaction.

At minimum:

- Before a durable resource manager or subordinate transaction manager sends a Prepared notification to its superior transaction manager, it needs to first ensure that it can derive the information that is needed to contact its superior transaction manager and to inquire about the outcome of the transaction after a transient failure. This requirement is needed for the subordinate to perform recovery on In Doubt transactions.
- Before a transaction manager can communicate the transaction outcome to a subordinate participant or the root application, it has to first ensure that it can derive the transaction outcome for as long as at least one durable subordinate has not acknowledged receipt of the transaction outcome. This requirement is needed for the superior to perform recovery on Failed to Commit transactions.
- Before a durable resource manager or subordinate transaction manager acknowledges a Commit notification from its superior transaction manager, it has to first ensure that it will not perform recovery on the transaction after a transient failure. This requirement allows the superior transaction manager to implement the Presumed Abort optimization.

The information that is needed in order to be able to contact another participant is identical to the information that was needed to establish the initial transport session with that participant, as specified in [MS-CMPO] section 1.3.3.1.

1.3.4.2 Resource Manager Recovery

Resource manager recovery is unidirectional: the resource manager is always responsible for initiating recovery with its transaction manager. A resource manager always performs recovery on startup, even when it has not detected any transactions remaining in the In Doubt state. This is because the transaction manager cannot determine when it has Failed to Notify the resource manager of specific transaction outcomes.

The typical sequence for recovery of a resource manager is as follows:

1. The resource manager determines the list of transactions for which it is In Doubt. These are the transactions for which it previously voted Prepared but has not yet learned the outcome.
2. The resource manager registers with its transaction manager.
3. For each In Doubt transaction, the resource manager attempts to contact the transaction manager in order to determine the transaction outcome.

4. When the resource manager receives the outcome from the transaction manager, it performs any implementation-specific actions that are required to honor the ACID properties. Also, this process can take some time because the transaction manager can be acting as a subordinate transaction manager and it too might still be In Doubt about the actual transaction outcome.
5. After the resource manager ensures that there are no transactions for which it is still In Doubt, it informs the transaction manager that its recovery is complete. This allows the transaction manager to clean up any pending transactions for which it considered that the resource manager was in the Failed to Notify state.

1.3.4.3 Transaction Manager Recovery

Transaction manager recovery is dual-faceted. The recovering transaction manager will attempt to recover those transactions for which it is acting as a superior transaction manager facet and those for which it is acting as a subordinate transaction manager facet.

The typical sequence for a superior transaction manager facet to perform recovery is the following:

1. The superior transaction manager determines the list of transactions for which it is in the Failed to Notify state. These are the transactions whose outcome has been decided but for which there exists at least one durable subordinate participant whose receipt of that outcome cannot be verified.
2. For each of these transactions, the superior transaction manager attempts to perform recovery by contacting all subordinate transaction managers whose receipt of outcome cannot be verified in order to redeliver the transaction outcome.

The typical sequence for a subordinate transaction manager facet to perform recovery is the following:

1. The subordinate transaction manager determines the list of transactions for which it is in the In Doubt state.
2. For each of these transactions, the subordinate transaction manager attempts to contact the superior transaction manager in order to determine the transaction outcome.
3. For each In Doubt transaction whose transaction outcome is now known, the subordinate transaction manager proceeds to communicate the outcome to its own subordinate transaction managers.

1.3.5 Transaction Propagation

A single transaction typically requires work to be performed by one or more resource managers for one or more applications. Each of these applications and resource managers is typically associated with exactly one transaction manager.

When two participants share a common transaction manager, all that is needed to share a transaction is agreement on the transaction's unique identifier. How this unique identifier is communicated among the applications and resource managers is implementation-specific.

However, when two participants do not share a common transaction manager, this protocol defines a propagation mechanism that enables the two participants to notify their respective transaction managers that a specified transaction will span the two transaction managers. Transaction propagation allows applications and resource managers to freely marshal transactions across process and host machine boundaries by using whatever communication mechanisms and formats they chose.

When a participant (the source) determines that it marshals a transaction to a second participant (the destination), the participant chooses between two distinct propagation techniques:

- Push propagation

- Pull propagation

Push propagation requires the source participant to have a prior knowledge about which transaction manager the destination participant is associated with (as specified in section 1.3.5.2). In contrast, pull propagation allows the source participant to marshal the transaction without any awareness of the transaction manager of the destination participant (as specified in section 1.3.5.1).

Independent of the choice of push or pull propagation, after the propagation is complete, the destination transaction manager will have enlisted with the source transaction manager to coordinate the outcome of the transaction. In this enlistment, the source transaction manager plays the role of superior transaction manager, and the destination transaction manager plays the role of subordinate transaction manager.

1.3.5.1 Pull Propagation

Pull propagation enables the untargeted marshaling of a transaction from one application or resource manager to another. Contact information for the destination transaction manager is not required to be known by the source in advance.

The following sequence of events represents a complete pull propagation operation between two participants:

1. When the source determines that it possesses a transaction that it wants to share with the destination, it provides the destination with marshaling information about the transaction being shared in an implementation-specific manner. The marshaling information needs to be sufficient for the destination to create a Propagation Token structure, as specified in section 2.2.5.4, that corresponds to the transaction being shared.
2. The destination contacts its own transaction manager and requests that it join the transaction by using the marshaling information that is provided by the source application.
3. If the destination transaction manager is not already a participant in the transaction, the destination transaction manager uses the marshaling information to contact the source transaction manager to enlist in the transaction as a subordinate transaction manager. This inter-transaction manager handshake is called pull propagation.
4. If the operation is successful, the destination transaction manager reports success to the destination. The destination performs further operations on the transaction with its associated transaction manager or marshals the transaction further to other participants.

The following figure shows a typical pull propagation.

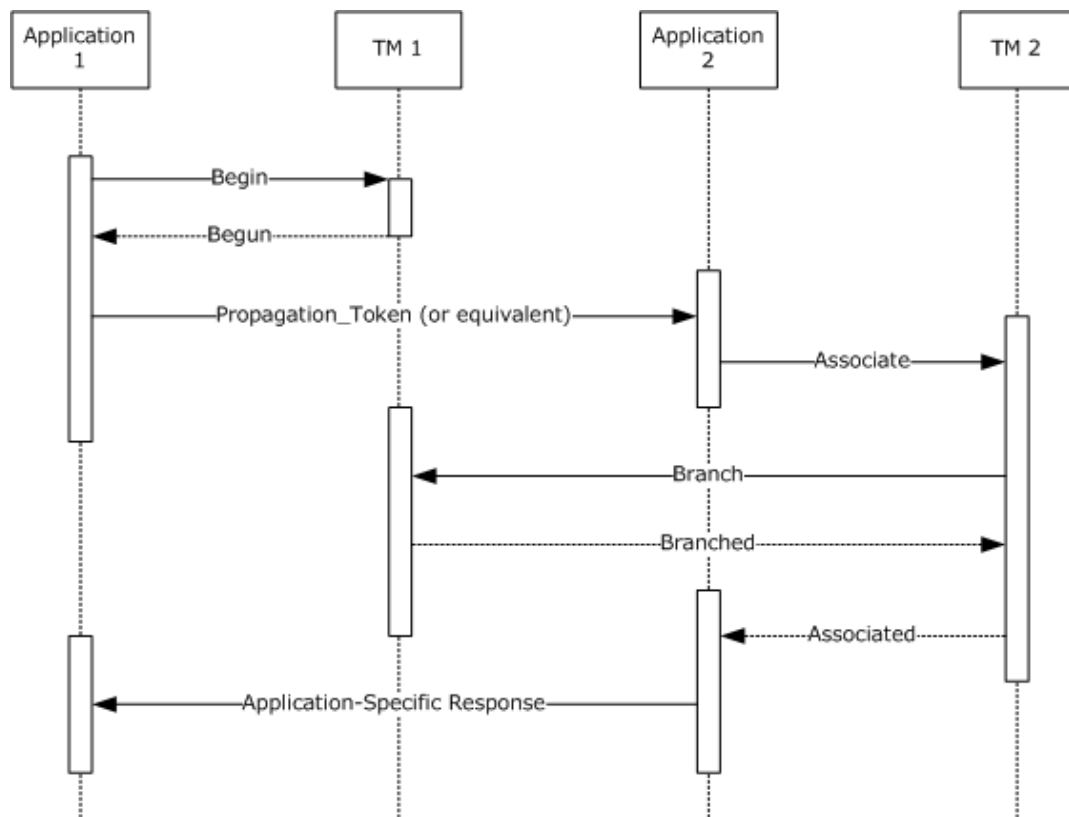

Figure 9: Transaction manager pull propagation

1.3.5.2 Push Propagation

Push propagation enables the targeted marshaling of a transaction from one participant to another. Push propagation is available only when the source knows the contact information for the destination transaction manager in advance.

Push propagation consists of two distinct logical operations: an export operation and an import operation.

The following sequence of events represents a complete push propagation operation between two participants:

1. The source obtains contact information for the destination transaction manager by using implementation-specific means. The contact information consists of whatever the source needs to construct an SWhereabouts structure, as specified in section 2.2.5.11. This step need be performed only one time per destination, because the contact information is not specific to a specified transaction or propagation.
2. When the source determines that it possesses a transaction that it wants to share with the destination, the source asks its transaction manager to export the transaction to the destination transaction manager by using the contact information it obtained in the previous step.
3. The source transaction manager contacts the destination transaction manager by using the provided contact information and informs it of the existence and details of the transaction. This inter-transaction manager handshake is the export operation of push propagation.
4. When the source transaction manager receives acknowledgment from the destination transaction manager, the export operation is complete. If the destination transaction manager was not

already a participant in the transaction, the destination transaction manager is now enlisted as a subordinate transaction manager at the source transaction manager, which acts as the superior transaction manager.

5. After the source transaction manager informs the source that the transaction was successfully exported, the source then uses an implementation-specific mechanism to marshal the exported transaction to the destination. The marshaled information can take any form that the source and destination agree on but is sufficient for the source to construct an STxInfo structure as specified in section 2.2.5.10.
6. The destination uses the marshaled information that is provided by the source to request an import operation from its transaction manager. The import operation is typically a simple confirmation that the transaction exists and was correctly exported to the destination.
7. If the import operation is successful, the destination transaction manager reports success to the destination. The destination performs further operations on the transaction with its associated transaction manager or marshals the transaction further to other participants.

The following figure depicts a typical push propagation.

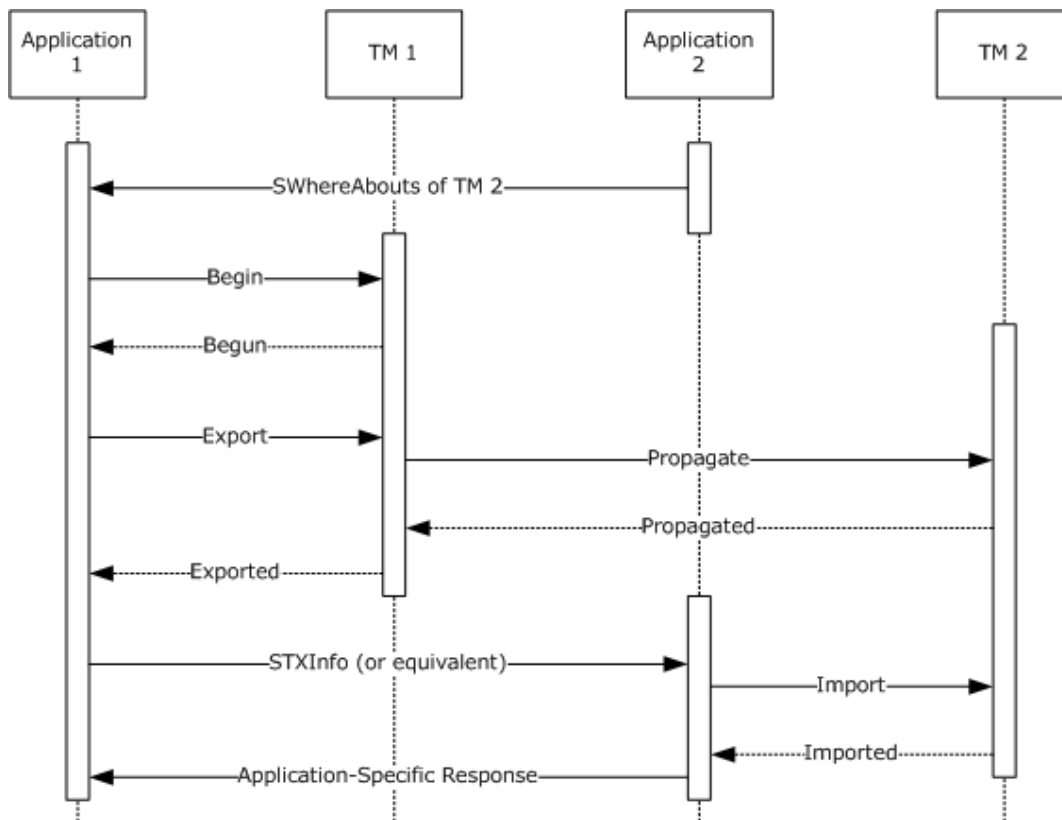

Figure 10: Transaction manager push propagation

1.4 Relationship to Other Protocols

The following figure illustrates the relationship between the MSDTC Connection Manager: OleTx Transaction Protocol and the underlying protocols on which it depends.

MSDTC Connection Manager: OleTx Transaction Protocol
MSDTC Connection Manager: Connection Multiplexing Protocol
MSDTC Connection Manager: OleTx Transports Protocol

Figure 11: Protocol relationships

This protocol provides extensibility elements that are used by the following specifications:

- [MS-DTCM]
- [MS-TIPP]
- [MS-DTCLU]
- [MC-DTCXA]
- [MS-WSRVCAT]

The following protocols perform transaction marshaling by using the structures specified in section 2.2.5 and its subsections of [MS-DTCO]:

- [MS-COM]
- [MS-MQRR]
- [MS-MQMP]

1.5 Prerequisites/Preconditions

This protocol requires that all participating roles possess implementations of MSDTC Connection Manager: OleTx Transports Protocol as specified in [MS-CMPO], and MSDTC Connection Manager: OleTx Multiplexing Protocol as specified in [MS-CMP].

1.6 Applicability Statement

This protocol applies to scenarios where distributed atomic transaction processing is required.

Distributed transactions are generally required in scenarios where a number of applications and resource managers cooperate to perform a set of related work items that require the ACID properties of a distributed transaction. These properties are needed in order to make changes to persistent state in a deterministic, correct, and highly reliable manner. Although distributed transactions are one of several mechanisms for accomplishing this goal, they are the most efficient and understood general-purpose solution.

This particular distributed transaction protocol requires network topologies where the MSDTC Connection Manager: OleTx Transports Protocol as specified in [MS-CMPO], and the MSDTC Connection Manager: OleTx Multiplexing Protocol as specified in [MS-CMP], constitute a viable network transport for establishing long-lived session relationships between different parties supporting many short-lived connection exchanges that accomplish specific tasks.

1.7 Versioning and Capability Negotiation

This document covers versioning aspects in the following areas:

- Protocol versions

This protocol provides five different versions: 1, 2, 4, 5, and 6 (version 3 is reserved and not used). More details on the protocol elements supported in each version are provided in Protocol Versioning (section 2.2.1).
- Capability negotiation

This protocol performs explicit versioning and capability negotiation, as specified in sections 1.7.2 and section 1.7.3.

1.7.1 Versioning Mechanisms

This protocol uses various mechanisms for versioning that are introduced as follows:

- Protocol Version numbers as versioning mechanism:

This protocol provides five different versions. The following are the implications of supporting a particular protocol version:

 - Support for connection types is version-specific and is either required, optional, or not allowed for a given Protocol Version.
 - For a version-specific supported connection type, support for all messages defined for that connection type is required.
 - The layout of data associated with specific messages is version-specific and is determined by the Protocol Version.

Protocol Version Numbers as a Versioning Mechanism (section 2.2.1.1) specifies details of what it means to support a certain Protocol Version Number. Protocol Versioning Details (section 3.1.4) specifies how the Protocol Version numbers are negotiated during communication initiation.

- Structures with fields containing version numbers as versioning mechanism: Certain structures have fields containing version numbers that specify how to interpret other parts of the structure. As an example, the `Propagation-Token` (section 2.2.5.4) structure has the fields **`dwVersionMin`** and **`dwVersionMax`** the values of which are used to indicate whether certain other fields are present or not.

Structures with Fields Containing Version Numbers as Versioning Mechanism (section 2.2.2) provides a list of the structures that fall in this category and links to information regarding each.

- Structures with complex fields using specific values to indicate the type of the complex field. Certain structures have a field that specifies how to interpret other parts of the structure. As an example, the `STmToTmProtocol` structure (section 2.2.5.9) uses the value of the **`tmprotDescribed`** field to specify how to interpret the rest of the fields in that structure.

Structures with a Format-Specifying Field as Versioning Mechanism (section 2.2.3) provides a list of the structures that fall in this category and links to information regarding each.

1.7.2 Versioning Negotiation Mechanisms

This protocol uses the following versioning negotiation mechanisms for each of the versioning mechanisms discussed above.

- Protocol Version Numbers as versioning mechanism

This protocol makes use of the explicit versioning negotiation mechanism as specified in [MS-CMPO], BuildContext Primary, section 3.3.4.2.1. An implementation of this protocol uses this mechanism to specify which versions of the protocol it supports and to negotiate a mutually agreeable version with its partners (see Protocol Versioning Details, (section 3.1.4)).

- Structures with fields containing version numbers as versioning mechanism

There is no versioning negotiation mechanism for this case. The version numbers are passed in each structure by the sender, and interpreted by the receiver.

- Structures with a field containing a value that identifies the structure format as versioning mechanism

There is no versioning negotiation mechanism for this case. The values of the field specifying the format are passed in each structure by the sender, and interpreted by the receiver.

1.7.3 Capability Negotiation Mechanisms

This protocol uses the following capability negotiation mechanisms for each of the versioning mechanisms discussed previously.

- Protocol Version numbers as versioning mechanism

- Support for certain connection types is optional for a specific protocol version. A connection initiator can determine whether the acceptor supports these connection types by sending the first message for the connection and determining the acceptor's level of support from the response. If the acceptor rejects the connection with a MTAG_CONNECTION_REQ_DENIED as specified in [MS-CMP] section 2.2.5, the connection type is not supported.
- Support for a message type is never optional for a specific connection type, with one exception: TXUSER_RESOLVE_MTAG_ACCESSDENIED (section 2.2.8.3.2.1). However, there is no negotiation process to determine support for this message, and the message is sent by a sender that supports it in all cases.
- Some specific data fields inside certain message types were added in specific protocol versions as additional data fields that appear after the fields that are defined by previous protocol versions. The receivers examine the size of the incoming MESSAGE_PACKET (section 2.2.4.1) structure to determine which additional data fields, if any, were included in the message by the sender.

- Structures with fields containing version numbers as a versioning mechanism

The structures using version numbers as a versioning mechanism do not have any optional elements for a particular version. Therefore, there are no capability negotiation mechanisms associated with them.

- Structures with a field containing a value that identifies the structure format as a versioning mechanism

In this case, the format of the structure is completely determined by the respective format-specifying field. There are no capability negotiation mechanisms associated with these structures.

1.8 Vendor-Extensible Fields

MSDTC Connection Manager: OleTx Transaction Protocol gives vendors the ability to provide implementation-specific protocol extensions to the Core Transaction Manager Facet. This protocol provides the following vendor-extensible fields and data elements:

- A protocol extension can augment the default set of transaction manager facets that are implemented inside an implementation of the transaction manager role, as specified in section 3.2.1.4. A protocol extension provides a set of services, as specified in section 3.2.1.5.
- A protocol extension also includes the contribution of extended whereabouts information to the Core Transaction Manager Facet, as specified in section 3.2.3.
- Each vendor-supplied transaction manager facet has the option to use the local events that are provided by the Core Transaction Manager Facet that is specified in section 3.2.7.

1.9 Standards Assignments

This protocol has no standards assignments.

2 Messages

2.1 Transport

This protocol uses implementations of MSDTC Connection Manager: OleTx Transports Protocol as specified in [MS-CMPO], and MSDTC Connection Manager: OleTx Multiplexing Protocol as specified in [MS-CMP], as the transport layer for sending and receiving protocol messages.

2.1.1 Messages, Connections, and Sessions

The layout of each message that is defined by this protocol MUST extend the MESSAGE_PACKET structure, as specified in section 2.2.4.1. The general mechanisms that are used to send and receive messages are as specified in [MS-CMP] sections 3.1.4.1 and 3.1.7.4.

Each message MUST be sent by using an active [MS-CMP] connection that has been established between an initiator and an acceptor. The mechanisms that are used to initiate and accept connections are as specified in [MS-CMP] sections 3.1.4.2 and 3.1.5.5.

Each connection MUST be initiated inside an active [MS-CMPO] session that has been established between two OleTx participants. The mechanisms that are used to establish sessions are as specified in [MS-CMPO] section 1.3.3.

The session creation is handled by MSDTC Connection Manager: OleTx Multiplexing Protocol, when a new connection is initiated, as specified in [MS-CMP] section 3.1.4.2.

When a new connection is initiated as specified in [MS-CMP] section 3.1.4.2, the OleTx participant MUST provide the following:

- The **Name Object** of the partner computed from implementation-specific configuration (section 2.1.2.3).
- The connection type.
- An Incoming Message Notification Interface object (as specified in [MS-CMP] section 3.1.1.1) with local events (section 3.1.8) to receive incoming message notifications from MSDTC Connection Manager: OleTx Multiplexing Protocol layer.

2.1.2 MS-CMP and MS-CMPO Initialization

In order to establish a transports protocol session as specified in [MS-CMPO] Local Partner State (section 3.2.1.1), the following values MUST be provided to the lower-layer multiplexing protocol as specified in [MS-CMP], which initializes the transports protocol with the provided values:

- A security-level value that indicates the requested RPC authentication level. The possible values for this element are specified in [MS-CMPO] section 3.2.1.1. The **Security Level** field ([MS-CMPO] section 3.2.1.1) is initialized with the security-level value.
- The minimum and maximum protocol version values as computed in section 2.1.2.2. The **Minimum Level 3 Version Number** and **Maximum Level 3 Version Number** fields ([MS-CMPO] section 3.2.1.1) are initialized with the computed minimum and maximum protocol version values.
- A local Name object that indicates the host name, the contact identifier, and the supported RPC network protocols of the local partner endpoint. Name objects are specified in [MS-CMPO] section 3.2.1.4. The **Local Name Object** field ([MS-CMPO] section 3.2.1.1) is initialized with the local Name Object value.

If the initialization of the underlying MSDTC Connection Manager: OleTx Multiplexing protocol instance fails as specified in [MS-CMP] section 3.1.3.2, then the implementation-specific failure result MUST be returned to the higher-layer business logic.

2.1.2.1 Computing a Security Level

When an application or resource manager initiates a connection to its transaction manager, the application or resource manager MUST use an implementation-specific way to compute the Security Level.

2.1.2.2 Computing Protocol Version Values

The process for computing the minimum and maximum protocol version numbers used in initializing the underlying transport specified in [MS-CMPO] is defined in Protocol Versioning Details (section 3.1.4).

2.1.2.3 Computing a Name Object

The Name object that is used to initiate a session is obtained in a variety of ways. This section defines how to obtain the appropriate Name object for several common situations. The specific transaction processing roles mentioned in these sections (applications, resource managers, and transaction managers) are defined as specified in section 1.3.3.

When an application or resource manager initiates a connection to its transaction manager, the application or resource manager MUST use implementation-specific configuration information to compute a Name object that represents the transaction manager:

1. For pull propagation of transactions, the source application MUST include the Name object representing its transaction manager in the marshaling information that is sent to the destination application. The Propagation Token (section 2.2.5.4) structure SHOULD be used for marshaling this information.
2. For pull propagation of transactions, the subordinate transaction manager (the transaction manager of the destination) MUST communicate its own Name object to the superior transaction manager (the source transaction manager) using a CONNTYPE_PARTNERTM_BRANCH connection.
3. For push propagation of transactions, the destination application MUST make the Name object that represents its transaction manager available to the source application. The SWhereabouts (section 2.2.5.11) structure SHOULD be used for marshaling this information. Alternatively, the NAMEOBJECTBLOB (section 2.2.5.3) structure MAY be used for the same purpose.<1>
4. For push propagation of transactions, the superior transaction manager MUST communicate its own Name object to the subordinate transaction manager using a CONNTYPE_PARTNERTM_PROPAGATE (section 2.2.9.1.1.1) connection.

2.2 Message Syntax

2.2.1 Protocol Versioning

2.2.1.1 Protocol Version Numbers as a Versioning Mechanism

This protocol has five versions: 1, 2, 4, 5, and 6 (version 3 is reserved and not used).<2> For each version, there is a set of protocol elements that MUST be supported (called version-required elements), a set of optional protocol elements that SHOULD be supported (called version-optional elements), and a set of protocol elements that MUST NOT be supported. The following sections

provide versioning tables that specify the scope of each protocol version with respect to the three mentioned sets.

The tables contain the following values.

Value	Description
Yes	The protocol element MUST be supported in the respective protocol version.
No	The protocol element MUST NOT be supported in the respective protocol version.
Optional	The protocol element SHOULD be supported in the respective protocol version.

2.2.1.1.1 Version-Specific Aspects of Connection Types Relevant to an Application

The following table shows version-specific aspects for connection types that are relevant to applications. This table includes connection types and messages that are supported on certain versions as well as messages whose size is version specific. If a connection type or message that is relevant to applications is omitted from this table, it is not version specific and MUST be supported on all versions.

Version-specific aspect	V1	V2	V4	V5	V6
Version supports connection type CONNTYPE_TXUSER_BEGIN2 (section 2.2.8.1.2).	No	Yes	Yes	Yes	Yes
Version supports connection type CONNTYPE_TXUSER_EXTENDEDWHEREABOUTS (section 2.2.8.2.2.1).	No	No	No	Optional <3>	Optional <4>
Version supports connection type CONNTYPE_TXUSER_GETSECURITYFLAGS (section 2.2.8.4.1).	No	No	Yes	Yes	Yes
Version supports connection type CONNTYPE_TXUSER_IMPORT2 (section 2.2.8.2.2.5).	No	Yes	Yes	Yes	Yes
Version supports connection type CONNTYPE_TXUSER_PROMOTE (section 2.2.8.1.3).	No	No	No	Optional <5>	Optional <6>
Version supports connection type CONNTYPE_TXUSER_SETTXTIMEOUT (section 2.2.8.3.3).	No	Optional <7>	No	No	No
Version supports connection type CONNTYPE_TXUSER_SETTXTIMEOUT2 (section 2.2.8.3.4).	No	No	Optional	Optional <8>	Optional <9>
Version supports connection type CONNTYPE_TXUSER_TRACE (section 2.2.8.3.5).	No	No	Yes	Yes	Yes
Version supports messages TXUSER_EXPORT_MTAG_CREATE2 (section 2.2.8.2.2.2.2) and TXUSER_EXPORT_MTAG_CREATE_NET_TX_DISABLED (section 2.2.8.2.2.2.4).	No	No	Yes	Yes	Yes
Version supports message TXUSER_RESOLVE_MTAG_ACCESSDENIED (section 2.2.8.3.2.1).	No	No	Optional	Yes	Yes

Version-specific aspect	V1	V2	V4	V5	V6
			<10>		
The SourceTmAddress field is described by the structure NAMEOBJECTBLOB (section 2.2.5.3) in message TXUSER_ASSOCIATE_MTAG_ASSOCIATE (section 2.2.8.2.1.1.1).	Yes	No	No	No	No
The SourceTmAddress field is described by the structure OLETX_TM_ADDR (section 2.2.4.2) in message TXUSER_ASSOCIATE_MTAG_ASSOCIATE (section 2.2.8.2.1.1.1).	No	Yes	Yes	Yes	Yes
The SourceTmAddress field is described by the structure NAMEOBJECTBLOB (section 2.2.5.3) in message TXUSER_EXPORT_MTAG_CREATE (section 2.2.8.2.2.1).	Yes	No	No	No	No
The SourceTmAddress field is described by the structure OLETX_TM_ADDR (section 2.2.4.2) in message TXUSER_EXPORT_MTAG_CREATE (section 2.2.8.2.2.1).	No	Yes	Yes	Yes	Yes
The grfNetworkDtcAccess field of the TXUSER_GETSECURITYFLAGS_MTAG_FETCHED message supports (uses) the following DTCADVCONFIG bits: DTCADVCONFIG_NETWORKDTCACCESS_ENABLE DTCADVCONFIG_NETWORKDTCACCESS_ADMIN DTCADVCONFIG_NETWORKDTCACCESS_TX DTCADVCONFIG_NETWORKDTCACCESS_CLIENTS DTCADVCONFIG_NETWORKDTCACCESS_TIP	No	No	Yes	Yes	Yes
The grfNetworkDtcAccess field of the TXUSER_GETSECURITYFLAGS_MTAG_FETCHED message supports (uses) the following DTCADVCONFIG bits: DTCADVCONFIG_INBOUNDNETWORK_TX DTCADVCONFIG_OUTBOUNDNETWORK_TX DTCADVCONFIG_SECURITYLEVEL_NOSECURITY DTCADVCONFIG_SECURITYLEVEL_AUTHENTICATEDONLY DTCADVCONFIG_SECURITYLEVEL_MUTUALAUTH	No	No	No	Yes	Yes
The grfOptions field of the TXUSER_GETSECURITYFLAGS_MTAG_FETCHED message supports (uses) the following DTCADVCONFIG_OPTIONS bits: DTCADVCONFIG_OPTIONS_LUTRANSACTIONS_DISABLE	No	No	No	No	Yes
The guidSignature field in the STxInfo structure present in propagation-related messages uses a reserved GUID with the binary value representation of {2adb4463-bd41-11d0-b12e-00c04fc2f3ef}. A GUID ([MS-DTYP] section 2.3.4.2) in this protocol is a 16-byte structure that is a unique identifier for an object.	No	Yes	Yes	Yes	Yes
The STxInfo structure supports versioning based on its guidSignature field.	No	Yes	Yes	Yes	Yes
Version supports connection type CONNTYPE_TXUSER_EXPORT2	No	No	No	No	Yes
Version supports message TXUSER_EXPORT_MTAG_EXPORT_COMM_FAILED	No	No	No	No	Yes

2.2.1.1.2 Version-Specific Aspects of Connection Types Relevant to a Transaction Manager

The following table shows version-specific aspects for connection types that are relevant to transaction managers. This table includes connection types and messages that are supported on certain versions as well as messages whose size is version specific. If a connection type or message that is relevant to transaction managers is omitted from this table, it is not version specific and MUST be supported on all versions.

Version-specific aspect	V1	V2	V4	V5	V6
PARTNERTM_PROPAGATE_MTAG_PHASE0, PARTNERTM_PROPAGATE_MTAG_PHASE0COMPLETE, PARTNERTM_PROPAGATE_MTAG_PHASE0REGISTER, PARTNERTM_PROPAGATE_MTAG_PHASE0REGISTERED, and PARTNERTM_PROPAGATE_MTAG_PHASE0REGISTRATIONREJECTED	No	Yes	Yes	Yes	Yes

2.2.1.1.3 Version-Specific Aspects of Connection Types Relevant to a Resource Manager

The following table shows version-specific aspects for connection types that are relevant to resource managers. These include connection types and messages that are supported on certain MSDTC Connection Manager: OleTx Multiplexing Protocol versions as well as messages whose size is version specific. If a connection type or message that is relevant to resource managers is omitted from this table, then it is not version specific and MUST be supported on all versions.

Version-specific aspect	V1	V2	V4	V5	V6
Version supports connection type CONNTYPE_TXUSER_PHASE0.	No	Yes	Yes	Yes	Yes
Version supports connection type CONNTYPE_TXUSER_RESOURCEMANAGERINTERNAL.	No	No	No	Optional<11>	Optional<12>

2.2.2 Structures with Fields Containing Version Numbers as Versioning Mechanism

Currently, only one structure has fields that specify the version (and therefore the format) of the structure.

Structure	Fields containing version numbers
Propagation-Token	dwVersionMin dwVersionMax

2.2.3 Structures with a Format-Specifying Field as Versioning Mechanism

The following table contains the structures that have a field whose value indicates the format of the structure.

Structure	Format-specifying field
STmToTmProtocol	tmprotDescribed
STxInfo	guidSignature

2.2.4 Common Structures

2.2.4.1 MESSAGE_PACKET

The MESSAGE_PACKET structure defines the initial message fields that are contained by all message tags (MTAG)s in this protocol, as specified in [MS-CMP] section 2.2.2.

0	1	2	3	4	5	6	7	8	9	10	11	12	13	14	15	16	17	18	19	20	21	22	23	24	25	26	27	28	29	30	31
MsgTag																															
fIsMaster																															
dwConnectionId																															
dwUserMsgType																															
dwcbVarLenData																															
dwReserved1																															

MsgTag (4 bytes): A 4-byte integer value that describes the OLE transaction message type. For all uses in this document, this value MUST be 0x00000FFF, which indicates MTAG_USER_MESSAGE, as specified in [MS-CMP] section 2.2.8.

fIsMaster (4 bytes): A 4-byte value indicating the direction of the message in the conversation.

This value MUST be one of the following values.

Value	Meaning
0x00000000	The message is sent by the party that accepted the connection.
0x00000001	The message is sent by the party that initiated the connection.

dwConnectionId (4 bytes): A 4-byte integer value that MUST contain the unique identifier for the associated connection.

dwUserMsgType (4 bytes): This field contains the message type identifier. Each MTAG that is defined in this section MUST specify a distinct value for this field for a specified connection type.

dwcbVarLenData (4 bytes): An unsigned 4-byte integer value that MUST contain the size, in bytes, of the message buffer that contains the MESSAGE_PACKET structure, minus the size, in bytes, of the MESSAGE_PACKET structure itself.

dwReserved1 (4 bytes): Reserved. This value MAY be set to any implementation-specific value and MUST be ignored on receipt.<13>

2.2.4.2 OLETX_TM_ADDR

The OLETX_TM_ADDR structure is used to represent the address of a transaction manager.

0	1	2	3	4	5	6	7	8	9	10	11	12	13	14	15	16	17	18	19	20	21	22	23	24	25	26	27	28	29	30	31
guidSignature (16 bytes)																															
...																															
...																															
guidEndpoint (16 bytes)																															
...																															
...																															
grbComProtsSupported																															
wszHostName (variable)																															
...																															

guidSignature (16 bytes): This field contains a signature value for this structure. The value MUST be the binary representation of the GUID {DC85CB48-D8A5-11d2-828B-00805F0DF75A}.

guidEndpoint (16 bytes): This field MUST contain a GUID that specifies the contact identifier of the transaction manager.

grbComProtsSupported (4 bytes): Indicates the RPC transports for which the transaction manager is listening. The value MUST be the result of the bitwise OR combination of one or more flags as specified in [MS-CMPO] section 2.2.4.

wszHostName (variable): This field MUST contain a null-terminated, little-endian UTF-16 encoded string that specifies the NetBIOS host name of the transaction manager. This field MUST NOT contain a Unicode byte-order-mark (BOM) character. The length of this field MUST be 2 to 32 bytes, inclusive. For details about Unicode and character sets, see [MSDN-ANSI].

For specific information on NetBIOS, see [NETBEUI], [RFC1001], and [RFC1002].

2.2.4.3 OLETX_VARLEN_STRING

The OLETX_VARLEN_STRING structure is used to represent a byte-counted variable-length string.

0	1	2	3	4	5	6	7	8	9	0	1	2	3	4	5	6	7	8	9	0	1	2	3	4	5	6	7	8	9	0	1
cbLength																															
szString (variable)																															
...																															

cbLength (4 bytes): An unsigned integer that MUST contain the number of bytes in the **szString** field.

szString (variable): A Latin-1 string as specified in [ISO/IEC-8859-1] without a final null-terminating character. This field MUST be **cbLength** bytes in length. If **cbLength** is zero, this field MUST NOT be present.

2.2.5 Transaction Propagation Structures

2.2.5.1 Associate_Msg_Version2

The Associate_Msg_Version2 structure contains the NetBIOS host name of a transaction manager.

0	1	2	3	4	5	6	7	8	9	0	1	2	3	4	5	6	7	8	9	0	1	2	3	4	5	6	7	8	9	0	1
cbHostNameW																															
wszHostName (variable)																															
...																															

cbHostNameW (4 bytes): The size, in bytes, of **wszHostName**, including the null terminator. The value of this field MUST be in the range 2 to 32 bytes, inclusive.

wszHostName (variable): A null-terminated, little-endian UTF-16 encoded string that contains a NetBIOS host name. This string MUST have the length that is specified by **cbHostNameW** and MUST NOT contain a Unicode BOM character.

2.2.5.2 Associate_Msg_Version3

The Associate_Msg_Version3 structure contains information about the transaction protocol support of a transaction manager.<14>

0	1	2	3	4	5	6	7	8	9	0	1	2	3	4	5	6	7	8	9	0	1	2	3	4	5	6	7	8	9	0	1
fNetworkTxEnabled																															
fTipEnabled																															
cbTipTmUrl																															
szTipTmUrl (variable)																															

...

fNetworkTxEnabled (4 bytes): This field indicates if network access is enabled or disabled on the transaction manager. If network access is disabled, this field MUST be set to zero. If network access is enabled, this field MUST be set to a nonzero value.

fTipEnabled (4 bytes): This field indicates if the transaction Internet Protocol (TIP) is enabled or disabled on the transaction manager, as specified in [RFC2371]. If TIP is disabled, this field MUST be set to zero. If TIP is enabled, this field MUST be set to a nonzero value. For more information about the TIP protocol, see [RFC2371] for details.

cbTipTmUrl (4 bytes): This field MUST contain the size, in bytes, of **szTipTmUrl**, including the null terminator. The value of this field MUST be greater than or equal to 0.

szTipTmUrl (variable): A null-terminated Latin-1 ANSI string, as specified in [ISO/IEC-8859-1], that MUST contain the URL of the TIP transaction manager on the node that created this propagation token. If cbTipTmUrl is zero, this field MUST NOT be present. Otherwise, this field MUST have the length specified by **cbTipTmUrl**.

2.2.5.3 NAMEOBJECTBLOB

The NAMEOBJECTBLOB structure contains information to identify and locate a transaction manager.

0	1	2	3	4	5	6	7	8	9	10	11	12	13	14	15	16	17	18	19	20	21	22	23	24	25	26	27	28	29	30	31
szGuid (40 bytes)																															
...																															
...																															
dwcbHostName																															
dwReserved1																															
grbComProtsSupported																															
szHostName (variable)																															
...																															

szGuid (40 bytes): A fixed-size array containing a null-terminated Latin-1 ANSI string, as specified in [ISO/IEC-8859-1], that contains a GUID that is formatted into a string, as specified in [C706], Appendix A, UUID. This string MUST identify the contact identifier for the transaction manager instance that is located at the node that is identified by the host name. Storage after the initial null MUST be ignored on receipt.

dwcbHostName (4 bytes): This field MUST contain the size, in bytes, of the **szHostName** field, including the null terminator. The value of this field MUST be in the range 1 to 16, inclusive.

dwReserved1 (4 bytes): Reserved. This field MUST be set to an implementation-specific value and MUST be ignored on receipt. The default value of this field is 0xCD64CD64.<15>

grbComProtsSupported (4 bytes): Indicates which RPC transports the transaction manager is able to use to communicate. The value MUST be the result of a bitwise OR operation of one or more flags, as specified in [MS-CMPO]. The COM_PROTOCOL data type is implemented as specified in [MS-CMPO] section 2.2.4.

szHostName (variable): A null-terminated Latin-1 ANSI string, as specified in [ISO/IEC-8859-1], that MUST specify the host name of the transaction manager instance. It MUST have the length specified by **dwcbHostName**.

2.2.5.4 Propagation-Token

The Propagation Token structure is used for performing pull-based transaction propagation. This structure contains information about a transaction and about a superior transaction manager that is available for use by participants to enlist on the transaction.

0	1	2	3	4	5	6	7	8	9	0	1	2	3	4	5	6	7	8	9	0	1	2	3	4	5	6	7	8	9	0	1
dwVersionMin																															
dwVersionMax																															
guidTx (16 bytes)																															
...																															
...																															
isoLevel																															
isoFlags																															
cbSourceTmAddr																															
szDesc (40 bytes)																															
...																															
...																															
NameObject (variable)																															
...																															
AssociateMsgVersion2 (variable)																															
...																															
AssociateMsgVersion3 (variable)																															
...																															

dwVersionMin (4 bytes): The minimum version of the transaction information structure that accompanies the Propagation Token. The value MUST be set to 1.

dwVersionMax (4 bytes): The maximum version of the transaction information structure that accompanies the Propagation Token. The value MUST be 1, 2, or 3.<16>

guidTx (16 bytes): This field MUST contain a GUID that specifies the transaction identifier.

isoLevel (4 bytes): The isolation level of the transaction. This field MUST contain one value from the OLETX_ISOLATION_LEVEL enumeration.

isoFlags (4 bytes): The isolation flags for the transaction. This field MUST contain the result of a bitwise OR operation of zero or more OLETX_ISOLATION_FLAGS flags, as specified in section 2.2.6.8.

cbSourceTmAddr (4 bytes): This field MUST contain the total size, in bytes, of the space that is used by the **NameObject**, **AssociateMsgVersion2**, and **AssociateMsgVersion3** fields.

szDesc (40 bytes): The description of the transaction, as a fixed-size array of 40 bytes containing a null-terminated Latin-1 ANSI string, as specified in [ISO/IEC-8859-1]. This field MUST be set to an implementation-specific value. Any bytes that follow the first null-terminator character SHOULD be ignored on receipt.

NameObject (variable): This field MUST be a NAMEOBJECTBLOB structure that contains contact information about the transaction manager that is referenced by the Propagation Token.

AssociateMsgVersion2 (variable): This field MUST be an Associate_Msg_Version2 structure that contains the NetBIOS host name for the transaction manager that is referenced by the Propagation Token. If **dwVersionMax** is 1, then this field MUST NOT be present; otherwise, it MUST be present. If this field is present, the contents MUST override the **szHostName** value in the **NameObject** field.

AssociateMsgVersion3 (variable): This field MUST be an Associate_Msg_Version3 structure that contains information about the transaction protocol support for the transaction manager that is referenced by the Propagation Token. If **dwVersionMax** is 3, then this field MUST be present; otherwise, it MUST NOT be present.

2.2.5.5 SDtcCmEndpointInfoV1

The SDtcCmEndpointInfoV1 structure contains data used to connect to a transaction manager that supports the OleTx protocol.

0	1	2	3	4	5	6	7	8	9	10	11	12	13	14	15	16	17	18	19	20	21	22	23	24	25	26	27	28	29	30	31
comprotSupported																															
guidEndpointID (16 bytes)																															
...																															
...																															
szHostname (variable)																															
...																															

comprotSupported (4 bytes): Indicates which RPC transports the transaction manager supports for communication. The value MUST be the result of the bitwise OR combination of one or more flags as specified in [MS-CMPO]. The COM_PROTOCOL data type is implemented as specified in [MS-CMPO] section 2.2.4.

guidEndpointID (16 bytes): This field MUST be a GUID that specifies the contact identifier of the transaction manager.

szHostname (variable): A null-terminated Latin-1 ANSI character string, as specified in [ISO/IEC-8859-1], that MUST specify the host name for the transaction manager endpoint. This field MUST be between 1 and 16 bytes in length, inclusive.

2.2.5.6 SDtcCmEndpointInfoV2

The SDtcCmEndpointInfoV2 structure contains extended information that is used, along with the contents of the SDtcCmEndpointInfoV1 (section 2.2.5.5) structure, to connect to a transaction manager that supports the OleTx protocol.

0	1	2	3	4	5	6	7	8	9	10	11	12	13	14	15	16	17	18	19	20	21	22	23	24	25	26	27	28	29	30	31
wszHostname (variable)																															
...																															

wszHostname (variable): A null-terminated little-endian UTF-16 character string that specifies the NetBIOS host name for the transaction manager endpoint. This field MUST be between 2 and 32 bytes in length, inclusive, and MUST NOT contain a Unicode BOM character.

2.2.5.7 SOleTxInfoForTip

The SOleTxInfoForTip structure contains data that is specific to the Transaction Internet Protocol (TIP) for an exported transaction.

0	1	2	3	4	5	6	7	8	9	10	11	12	13	14	15	16	17	18	19	20	21	22	23	24	25	26	27	28	29	30	31
szDescription (40 bytes)																															
...																															
...																															
isoLevel																															
isoFlags																															
szTipTmUrl (variable)																															
...																															

szDescription (40 bytes): See the **szDesc** field in Propagation Token (section 2.2.5.4) for details.

isoLevel (4 bytes): The isolation level of the transaction. The value MUST be one as specified in the OLETX_ISOLATION_LEVEL (section 2.2.6.9) enumeration.

isoFlags (4 bytes): The isolation flags for the transaction. The value MUST be a legal combination of values from the OLETX_ISOLATION_FLAGS (section 2.2.6.8) enumeration.

szTipTmUrl (variable): A null-terminated Latin-1 ANSI string, as specified in [ISO/IEC-8859-1], that MUST specify the TIP URL of the transaction manager, as specified in [RFC2371].

2.2.5.8 SExtendedEndpointInfo

The SExtendedEndpointInfo packet contains data to represent endpoint information that is available for use to connect to a protocol extension that is hosted by a transaction manager. This structure does not specify its own length. Therefore, it MUST be used in a context that specifies the actual length.

0	1	2	3	4	5	6	7	8	9	10	11	12	13	14	15	16	17	18	19	20	21	22	23	24	25	26	27	28	29	30	31
guidProtocolExtension (16 bytes)																															
...																															
...																															
rgbProtocolExtensionData (variable)																															
...																															

guidProtocolExtension (16 bytes): This field MUST contain a GUID that specifies the protocol extension that contributed this extended endpoint information.

rgbProtocolExtensionData (variable): This field MUST contain data that is contributed by a protocol extension that represents protocol extension-specific endpoint information. The format and size of this data is specific to the respective extension protocol. This data MUST NOT be interpreted by an application or other transaction participant unless it recognizes the **guidProtocolExtension** field.

2.2.5.9 STmToTmProtocol

The STmToTmProtocol structure contains protocol-specific endpoint information for the transaction manager.

0	1	2	3	4	5	6	7	8	9	10	11	12	13	14	15	16	17	18	19	20	21	22	23	24	25	26	27	28	29	30	31
tmprotDescribed																															
cbTmProtocolData																															
rgbTmProtocolData (variable)																															
...																															

tmprotDescribed (4 bytes): This field specifies the type of transaction manager-to-transaction manager protocol-specific data for this transaction. This MUST be one of the values specified in TM_Protocol (section 2.2.6.2).<17>

cbTmProtocolData (4 bytes): This field MUST specify the length, in bytes, of the **rgbTmProtocolData** field.

rgbTmProtocolData (variable): The transaction manager protocol-specific data for this transaction. If the **cbTmProtocolData** field is 0x00000000, this field MUST NOT be present. Otherwise, the format of this field depends on the value of the **tmprotDescribed** field, which MUST be one of the following values.

tmprotDescribed name/value	Meaning
TmProtocolMsdtcV1 0x00000002	This field MUST contain an SDtcCmEndpointInfoV1 (section 2.2.5.5) structure that contains data that is used to connect to an OleTx transaction manager. The cbTmProtocolData field MUST be at least 21.
TmProtocolMsdtcV2 0x00000003	This field MUST contain an SDtcCmEndpointInfoV2 (section 2.2.5.6) structure that contains additional data that is used to connect to an OleTx transaction manager. The cbTmProtocolData field MUST be at least 2.
TmProtocolExtended 0x00000004	This field MUST contain an SExtendedEndpointInfo (section 2.2.5.8) structure for an extension protocol. The cbTmProtocolData field MUST be at least 16.

2.2.5.10 STxInfo

The STxInfo structure represents an exported transaction during push-based transaction propagation. The information in this structure is passed to a transaction manager in order to import a transaction.

0	1	2	3	4	5	6	7	8	9	10	11	12	13	14	15	16	17	18	19	20	21	22	23	24	25	26	27	28	29	30	31
guidSignature (16 bytes)																															
...																															
...																															
uowTx (16 bytes, optional)																															
...																															
...																															
tmprotUsed (optional)																															
cbProtocolSpecificTxInfo (optional)																															
protocolSpecificTxInfo (variable)																															
...																															

guidSignature (16 bytes): This field MUST be a GUID that either specifies the transaction identifier or specifies a signature value that indicates that the fields following this field are present in the structure. If the field contains the binary value representation of the GUID {2adb4463-bd41-11d0-b12e-00c04fc2f3ef}, the fields **uowTx**, **tmprotUsed**, and **cbProtocolSpecificTxInfo** MUST be present. For all other values, this field MUST specify the GUID of the transaction to be imported, and all other fields MUST NOT be present. This field MUST be set to the binary value representation of the GUID {2adb4463-bd41-11d0-b12e-00c04fc2f3ef} or to the GUID of the transaction based on the protocol version as specified in section 2.2.1.1.1.

uowTx (16 bytes): If present, this field MUST be a GUID that specifies the transaction identifier.

tmprotUsed (4 bytes): If present, this field MUST specify the format of the data in the **protocolSpecificTxInfo** field. The value MUST be one that is as specified in **TM_PROTOCOL** (section 2.2.6.2).

cbProtocolSpecificTxInfo (4 bytes): If present, this field MUST contain the size of the protocol-specific data. This value MUST be zero, unless **tmprotUsed** contains the value **TmProtocolTip**, in which case the value MUST be determined by adding the size of the **SOleTxInfoForTip** (section 2.2.5.7) structure and the size, in bytes, of the **szTipTmUrl** field in the **SOleTxInfoForTip** structure, including the null terminator.

protocolSpecificTxInfo (variable): If present, this field MUST contain a **SOleTxInfoForTip** (section 2.2.5.7) structure. If the **cbProtocolSpecificTxInfo** field is present and has a nonzero value, this field MUST be present. Otherwise, this field MUST not be present.

2.2.5.11 SWhereabouts

The SWhereabouts structure describes the location of a transaction manager and the protocols that MUST be used to contact it.

0	1	2	3	4	5	6	7	8	9	0	1	2	3	4	5	6	7	8	9	0	1	2	3	4	5	6	7	8	9	0	1
guidSignature (16 bytes)																															
...																															
...																															
cTmToTmProtocols																															
rgtmprotUsableList (variable)																															
...																															

guidSignature (16 bytes): This field contains a signature value for this structure. The value MUST be the binary representation of the GUID {2adb4462-bd41-11d0-b12e-00c04fc2f3ef}.

cTmToTmProtocols (4 bytes): This field MUST contain the number of **STmToTmProtocol** (section 2.2.5.9) structures present in the **rgtmprotUsableList** field. This value MUST be at least 1.

rgtmprotUsableList (variable): This field MUST contain an unordered list of **STmToTmProtocol** structures with protocol-specific connection information for this transaction manager. Each entry MUST be aligned on a 4-byte boundary by padding with arbitrary values that MUST be ignored on receipt. A list that contains an **STmToTmProtocol** structure with a **tmprotDescribed** value of **TmProtocolMsdtcV2** MUST also contain an **STmToTmProtocol** structure with a **tmprotDescribed**

value of TmProtocolMsdtcV1. In this case, the **wszHostName** value in the SDtcCmEndpointV2 structure MUST be used in place of the **szHostName** value in the SDtcCmEndpointV1 structure.

2.2.6 Transaction Enumerations

2.2.6.1 Connection Types

The CONNTYPE enumeration defines the connection types that are used by MSDTC Connection Manager: OleTx Multiplexing Protocol Specification.

```
typedef enum
{
    CONNTYPE_TXUSER_BEGINNER = 0x00000001,
    CONNTYPE_TXUSER_IMPORT = 0x00000002,
    CONNTYPE_TXUSER_ENLISTMENT = 0x00000003,
    CONNTYPE_TXUSER_EXPORT = 0x00000004,
    CONNTYPE_TXUSER_RESOURCEMANAGER = 0x00000005,
    CONNTYPE_TXUSER_REENLIST = 0x00000006,
    CONNTYPE_TXUSER_RESOLVE = 0x00000007,
    CONNTYPE_TXUSER_VOTER = 0x00000009,
    CONNTYPE_TXUSER_ASSOCIATE = 0x00000011,
    CONNTYPE_TXUSER_GETTXDETAILS = 0x00000022,
    CONNTYPE_TXUSER_PHASE0 = 0x00000024,
    CONNTYPE_TXUSER_BEGIN2 = 0x00000028,
    CONNTYPE_TXUSER_IMPORT2 = 0x00000033,
    CONNTYPE_TXUSER_GETSECURITYFLAGS = 0x00000035,
    CONNTYPE_TXUSER_TRACE = 0x00000036,
    CONNTYPE_TXUSER_SETTXTIMEOUT = 0x00000037,
    CONNTYPE_TXUSER_SETTXTIMEOUT2 = 0x00000038,
    CONNTYPE_TXUSER_PROMOTE = 0x00000039,
    CONNTYPE_TXUSER_EXTENDEDWHEREABOUTS = 0x0000003D,
    CONNTYPE_TXUSER_RESOURCEMANAGERINTERNAL = 0x00000046,
    CONNTYPE_TXUSER_EXPORT2 = 0x00000048,
    CONNTYPE_PARTNERTM_PROPAGATE = 0x00000101,
    CONNTYPE_PARTNERTM_REDELIVERCOMMIT = 0x00000102,
    CONNTYPE_PARTNERTM_CHECKABORT = 0x00000103,
    CONNTYPE_PARTNERTM_BRANCH = 0x00000104
} CONNTYPE;
```

CONNTYPE_TXUSER_BEGINNER: This connection type is used by applications that begin, commit, and roll back transactions.

CONNTYPE_TXUSER_IMPORT: This connection type is used by a destination application to complete a push propagation that is initiated by a source application.

CONNTYPE_TXUSER_ENLISTMENT: This connection type is used by a durable resource manager to establish an enlistment with its transaction manager.

CONNTYPE_TXUSER_EXPORT: This connection type is used by a source application to initiate a push propagation to a destination application.

CONNTYPE_TXUSER_RESOURCEMANAGER: This connection type is used by a durable resource manager to register with its transaction manager.

CONNTYPE_TXUSER_REENLIST: This connection type is used by a durable resource manager to determine the outcome of an In Doubt transaction.

CONNTYPE_TXUSER_RESOLVE: This connection type is used by an application either to manually resolve the outcome of an In Doubt transaction or to cause its transaction manager to forget a transaction that is in the Failed to Notify state.

CONNTYPE_TXUSER_VOTER: This connection type is used by a volatile resource manager to establish a voter enlistment with its transaction manager.

CONNTYPE_TXUSER_ASSOCIATE: This connection type is used by a destination application to complete the pull propagation of a transaction from a source application.

CONNTYPE_TXUSER_GETTXDETAILS: This connection type is used by an application to retrieve details about a transaction from its transaction manager.

CONNTYPE_TXUSER_PHASE0: This connection type is used by a resource manager to enlist for Phase Zero notifications from its transaction manager.

CONNTYPE_TXUSER_BEGIN2: This connection type is used by an application to begin, commit, or roll back a transaction or to change the time-out of a transaction. This connection type supersedes CONNTYPE_TXUSER_BEGINNER and CONNTYPE_TXUSER_SETTXTIMEOUT2.

CONNTYPE_TXUSER_IMPORT2: This connection type is used by a destination application to complete a Push Propagation that is initiated by a source application. This connection type supersedes CONNTYPE_TXUSER_IMPORT.

CONNTYPE_TXUSER_GETSECURITYFLAGS: This connection type is used by an application to obtain the security configuration of its transaction manager.

CONNTYPE_TXUSER_TRACE: This connection type is used by an application to ask its transaction manager to trace the status of a transaction by using an implementation-specific mechanism.

CONNTYPE_TXUSER_SETTXTIMEOUT: This connection type is used by an application to modify the time-out of a transaction.

CONNTYPE_TXUSER_SETTXTIMEOUT2: This connection type is used by an application to query the transaction manager's support for modifying the time-out of a transaction.

CONNTYPE_TXUSER_PROMOTE: This connection type is used by an application to:

- Begin a transaction using an application-specified transaction identity
- Commit or rollback a transaction
- Change the time-out of a transaction

This connection type supersedes CONNTYPE_TXUSER_SETTXTIMEOUT2.

CONNTYPE_TXUSER_EXTENDEDWHEREABOUTS: This connection type is used by an application to obtain Extended Whereabouts from its transaction manager.

CONNTYPE_TXUSER_RESOURCEMANAGERINTERNAL: This connection type is used by a durable resource manager to register with a transaction manager and to detect duplicate registrations. This connection type supersedes CONNTYPE_TXUSER_RESOURCEMANAGER.

CONNTYPE_TXUSER_EXPORT2: This connection type is used by a source application to initiate a push propagation to a destination application. This connection type supersedes CONNTYPE_TXUSER_EXPORT.

CONNTYPE_PARTNERTM_PROPAGATE: This connection type is used by a superior transaction manager to do a push propagation of a transaction to its subordinate transaction manager and to execute the Two-Phase Commit Protocol.

CONNTYPE_PARTNERTM_REDELIVERCOMMIT: This connection type is used by a superior transaction manager to redeliver a Commit notification for a transaction to its subordinate transaction manager.

CONNTYPE_PARTNERTM_CHECKABORT: This connection type is used by a subordinate transaction manager to query the outcome of a transaction from its superior transaction manager.

CONNTYPE_PARTNERTM_BRANCH: A subordinate transaction manager uses this connection type to register a new subordinate enlistment with a superior transaction manager.

2.2.6.2 TM_Protocol

The TM_PROTOCOL enumeration defines types of transaction manager-to-transaction manager protocols that are available for use.

```
typedef enum
{
    TmProtocolNone = 0,
    TmProtocolTip = 1,
    TmProtocolMsdtcV1 = 2,
    TmProtocolMsdtcV2 = 3,
    TmProtocolExtended = 4
} TM_PROTOCOL;
```

TmProtocolNone: No transaction manager-to-transaction manager protocol is available.

TmProtocolTip: The Transaction Internet Protocol (TIP) protocol is available.

TmProtocolMsdtcV1: The OleTx protocol is available with information contained in SDtcCmEndpointInfoV1 structure.

TmProtocolMsdtcV2: The OleTx protocol is available with extended information contained in SDtcCmEndpointInfoV2 structure along with SDtcCmEndpointInfoV1 structure.

TmProtocolExtended: An extension protocol is available.

2.2.6.3 TXUSER_ENLISTMENT_PREPAREREQDONE_RESPONSE

The TXUSER_ENLISTMENT_PREPAREREQDONE_RESPONSE enumeration defines the status values for a prepare request from a subordinate resource manager.

```
typedef enum
{
    TXUSER_ENLISTMENT_PREPAREREQDONE_OK = 0,
    TXUSER_ENLISTMENT_PREPAREREQDONE_ABORT = 1,
    TXUSER_ENLISTMENT_PREPAREREQDONE_READONLY = 2,
    TXUSER_ENLISTMENT_PREPAREREQDONE_SINGLEPHASE_COMMIT = 3
} TXUSER_ENLISTMENT_PREPAREREQDONE_RESPONSE;
```

TXUSER_ENLISTMENT_PREPAREREQDONE_OK: The prepare request was successful, and the enlistment requires the transaction outcome.

TXUSER_ENLISTMENT_PREPAREREQDONE_ABORT: The prepare request was unsuccessful, and the transaction MUST be aborted.

TXUSER_ENLISTMENT_PREPAREREQDONE_READONLY: The request to prepare the transaction for commitment was successful, and no further involvement in the transaction is required.

TXUSER_ENLISTMENT_PREPAREREQDONE_SINGLEPHASE_COMMIT: The sender chose the single-phase commit option and committed the transaction.

2.2.6.4 PARTNERTM_PROPAGATE_PREPAREREQDONE_RESPONSE

The PARTNERTM_PROPAGATE_PREPAREREQDONE_RESPONSE enumeration defines the status values for a prepare request from a subordinate transaction manager.

```
typedef enum
{
    PARTNERTM_PROPAGATE_PREPAREREQDONE_OK = 0,
    PARTNERTM_PROPAGATE_PREPAREREQDONE_ABORT = 1,
    PARTNERTM_PROPAGATE_PREPAREREQDONE_READ_ONLY = 2,
    PARTNERTM_PROPAGATE_PREPAREREQDONE_SINGLEPHASE_COMMIT = 3,
    PARTNERTM_PROPAGATE_PREPAREREQDONE_SINGLEPHASE_INDOUBT = 4
} PARTNERTM_PROPAGATE_PREPAREREQDONE_RESPONSE;
```

PARTNERTM_PROPAGATE_PREPAREREQDONE_OK: The prepare request was successful, and the enlistment requires the transaction outcome.

PARTNERTM_PROPAGATE_PREPAREREQDONE_ABORT: The prepare request was unsuccessful, and the transaction MUST be aborted.

PARTNERTM_PROPAGATE_PREPAREREQDONE_READ_ONLY: The request to prepare the transaction for commitment was successful, and no further involvement in the transaction is required.

PARTNERTM_PROPAGATE_PREPAREREQDONE_SINGLEPHASE_COMMIT: The sender chose the single-phase commit option and committed the transaction.

PARTNERTM_PROPAGATE_PREPAREREQDONE_SINGLEPHASE_INDOUBT: The prepare request was unsuccessful, and the transaction outcome is no longer determinable.

2.2.6.5 TXUSER_VOTER_VOTERREQDONE_RESPONSE

The TXUSER_VOTER_VOTERREQDONE_RESPONSE enumeration defines the status values for a prepare request from a subordinate resource manager.

```
typedef enum
{
    TXUSER_VOTER_VOTERREQDONE_OK = 0,
    TXUSER_VOTER_VOTERREQDONE_OK_NONOTIFY = 1,
    TXUSER_VOTER_VOTERREQDONE_ABORT = 2
} TXUSER_VOTER_VOTERREQDONE_RESPONSE;
```

TXUSER_VOTER_VOTERREQDONE_OK: The prepare request was successful, and the voter requires the transaction outcome.

TXUSER_VOTER_VOTERREQDONE_OK_NONOTIFY: The prepare request was successful, and the voter does not require the transaction outcome.

TXUSER_VOTER_VOTERREQDONE_ABORT: The prepare request was unsuccessful, and the transaction MUST be aborted.

2.2.6.6 TRUN_TXBEGIN_ERRORS

The TRUN_TXBEGIN_ERRORS enumeration defines the completion status values for requests from an application to perform the following steps in a transaction: begin, set time-out, commit, or abort a transaction.

```
typedef enum
```

```

{
    TRUN_TXBEGIN_ERROR_NO_MEM = 1,
    TRUN_TXBEGIN_ERROR_BEGIN_LOG_FULL = 20,
    TRUN_TXBEGIN_ERROR_NOTIFY_ABORTED = 30,
    TRUN_TXBEGIN_ERROR_NOTIFY_COMMITTED = 31,
    TRUN_TXBEGIN_ERROR_NOTIFY_INDOUBT = 32,
    TRUN_TXBEGIN_ERROR_DUPLICATE_GUID = 33
} TRUN_TXBEGIN_ERRORS;

```

TRUN_TXBEGIN_ERROR_NO_MEM: There was insufficient memory to allocate the data structures necessary to create the new transaction.

TRUN_TXBEGIN_ERROR_BEGIN_LOG_FULL: There was insufficient space in the transaction manager log to accommodate a new transaction.

TRUN_TXBEGIN_ERROR_NOTIFY_ABORTED: The transaction has aborted.

TRUN_TXBEGIN_ERROR_NOTIFY_COMMITTED: The transaction has committed.

TRUN_TXBEGIN_ERROR_NOTIFY_INDOUBT: The transaction has completed, but the outcome is no longer determinable. This occurs if the transaction manager delegated the commit decision to a subordinate through the single-phase commit protocol and if the connection to that subordinate terminated before the result could be reported.

TRUN_TXBEGIN_ERROR_DUPLICATE_GUID: An attempt was made to create or promote a transaction, but a transaction with the specified transaction identifier already exists.

2.2.6.7 TRUN_TXIMPORT_ERRORS

The TRUN_TXIMPORT_ERRORS enumeration defines the completion status values for requests to import a transaction or to abort a transaction that was previously imported.

```

typedef enum
{
    TRUN_TXIMPORT_ERROR_NO_MEM = 1,
    TRUN_TXIMPORT_ERROR_IMPORT_TX_NOT_FOUND = 20,
    TRUN_TXIMPORT_ERROR_NOTIFY_ABORTED = 30,
    TRUN_TXIMPORT_ERROR_NOTIFY_COMMITTED = 31,
    TRUN_TXIMPORT_ERROR_NOTIFY_INDOUBT = 32
} TRUN_TXIMPORT_ERRORS;

```

TRUN_TXIMPORT_ERROR_NO_MEM: There was not enough memory to complete the operation.

TRUN_TXIMPORT_ERROR_IMPORT_TX_NOT_FOUND: The specified transaction was not found.

TRUN_TXIMPORT_ERROR_NOTIFY_ABORTED: The transaction aborted.

TRUN_TXIMPORT_ERROR_NOTIFY_COMMITTED: The transaction committed.

TRUN_TXIMPORT_ERROR_NOTIFY_INDOUBT: The transaction completed, but the outcome could not be determined.

2.2.6.8 OLETX_ISOLATION_FLAGS

The OLETX_ISOLATION_FLAGS bitfield enumeration values specify isolation flags for a transaction.

```

typedef enum
{
    ISOFLAG_RETAIN_DEFAULT = 0x00000000,

```

```

ISOFLAG_RETAIN_COMMIT_DC = 0x00000001,
ISOFLAG_RETAIN_COMMIT = 0x00000002,
ISOFLAG_RETAIN_COMMIT_NO = 0x00000003,
ISOFLAG_RETAIN_ABORT_DC = 0x00000004,
ISOFLAG_RETAIN_ABORT = 0x00000008,
ISOFLAG_RETAIN_ABORT_NO = 0x0000000C,
ISOFLAG_RETAIN_DONTCARE = 0x00000005,
ISOFLAG_RETAIN_BOTH = 0x0000000A,
ISOFLAG_RETAIN_NONE = 0x0000000F,
ISOFLAG_OPTIMISTIC = 0x00000010,
ISOFLAG_READONLY = 0x00000020
} OLETX_ISOLATION_FLAGS;

```

ISOFLAG_RETAIN_DEFAULT: Default value if no other value has been set.

ISOFLAG_RETAIN_COMMIT_DC: Retain locks on transaction commit, regardless of the success or failure of that commit request.

If this value is set, then ISOFLAG_RETAIN_COMMIT and ISOFLAG_RETAIN_COMMIT_NO MUST NOT be set.

ISOFLAG_RETAIN_COMMIT: Retain locks on a successful transaction commit.

If this value is set, then ISOFLAG_RETAIN_COMMIT_DC and ISOFLAG_RETAIN_COMMIT_NO MUST NOT be set.

ISOFLAG_RETAIN_COMMIT_NO: Do not retain locks on a transaction commit.

If this value is set, then ISOFLAG_RETAIN_COMMIT_DC and ISOFLAG_RETAIN_COMMIT MUST NOT be set.

ISOFLAG_RETAIN_ABORT_DC: Retain locks on transaction abort, regardless of the success or failure of that Abort request.

If this value is set, then ISOFLAG_RETAIN_ABORT and ISOFLAG_RETAIN_ABORT_NO MUST NOT be set.

ISOFLAG_RETAIN_ABORT: Retain locks on a successful transaction abort.

If this value is set, then ISOFLAG_RETAIN_ABORT_DC and ISOFLAG_RETAIN_ABORT_NO MUST NOT be set.

ISOFLAG_RETAIN_ABORT_NO: Do not retain locks on a transaction abort.

If this value is set, then ISOFLAG_RETAIN_ABORT and ISOFLAG_RETAIN_ABORT_DC MUST NOT be set.

ISOFLAG_RETAIN_DONTCARE: Retain locks on all transaction termination requests, regardless of whether the request was to abort or commit.

This is a synonym for selecting ISOFLAG_RETAIN_COMMIT_DC and ISOFLAG_RETAIN_ABORT_DC.

ISOFLAG_RETAIN_BOTH: Retain locks on all successful transaction termination requests, regardless of whether or not the request was to abort or commit.

This is a synonym for selecting ISOFLAG_RETAIN_COMMIT and ISOFLAG_RETAIN_ABORT.

ISOFLAG_RETAIN_NONE: Do not retain locks on any transaction termination requests.

This is a synonym for selecting ISOFLAG_RETAIN_COMMIT_NO and ISOFLAG_RETAIN_ABORT_NO.

ISOFLAG_OPTIMISTIC: Optimistic locking is allowed.

ISOFLAG_READONLY: The transaction is not expected to modify data.

2.2.6.9 OLETX_ISOLATION_LEVEL

The OLETX_ISOLATION_LEVEL enumeration values specify the isolation levels of a transaction. The values of the OLETX_ISOLATION_LEVEL enumeration are not interpreted by the transaction manager. They are typically interpreted by resource managers that implement data isolation. These values are transported by the transaction manager from the root application to the resource managers.

```
typedef enum
{
    ISOLATIONLEVEL_UNSPECIFIED = 0xffffffff,
    ISOLATIONLEVEL_CHAOS = 0x00000010,
    ISOLATIONLEVEL_READUNCOMMITTED = 0x00000100,
    ISOLATIONLEVEL_READCOMMITTED = 0x00001000,
    ISOLATIONLEVEL_REPEATABLEREAD = 0x00010000,
    ISOLATIONLEVEL_SERIALIZABLE = 0x00100000
} OLETX_ISOLATION_LEVEL;
```

ISOLATIONLEVEL_UNSPECIFIED: No isolation level was specified.

ISOLATIONLEVEL_CHAOS: Data is not isolated.

ISOLATIONLEVEL_READUNCOMMITTED: A transaction can read any data, even if it is being modified by another transaction. Any type of new data can be inserted during a transaction.

ISOLATIONLEVEL_READCOMMITTED: A transaction MUST NOT read data that is being modified by another transaction that has not committed. Any type of new data can be inserted during a transaction.

ISOLATIONLEVEL_REPEATABLEREAD: Data read by a current transaction MUST NOT be changed by another transaction until the current transaction finishes. Any type of new data can be inserted during a transaction.

ISOLATIONLEVEL_SERIALIZABLE: Data read by a current transaction MUST NOT be changed by another transaction until the current transaction finishes. New data MUST NOT be inserted by another transaction that would affect the current transaction.

2.2.7 Transaction Constants

2.2.7.1 GRFRM

This MUST be a 32-bit unsigned integer that contains an implementation-defined value. This value SHOULD be ignored on receipt.

2.2.7.2 DTCADVCONFIG

2.2.7.3 DTCADVCONFIG_OPTIONS

These flags indicate the support for various miscellaneous options supported by the Core Transaction Manager Facet (section 1.3.3.3.1).

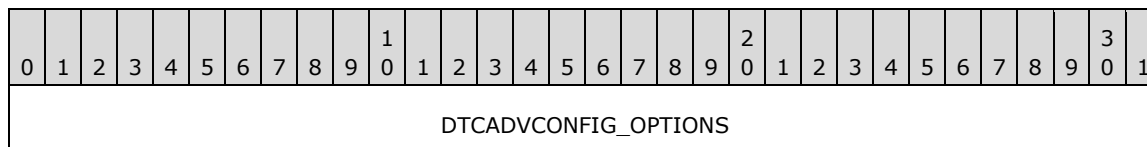

Value	Description
X	SHOULD be set to zero, and MUST be ignored when read.
X	SHOULD be set to zero, and MUST be ignored when read.
X	SHOULD be set to zero, and MUST be ignored when read.
X	SHOULD be set to zero, and MUST be ignored when read.
X	SHOULD be set to zero, and MUST be ignored when read.
X	SHOULD be set to zero, and MUST be ignored when read.
X	SHOULD be set to zero, and MUST be ignored when read.
X	SHOULD be set to zero, and MUST be ignored when read.
X	SHOULD be set to zero, and MUST be ignored when read.
X	SHOULD be set to zero, and MUST be ignored when read.
X	SHOULD be set to zero, and MUST be ignored when read.
X	SHOULD be set to zero, and MUST be ignored when read.
X	SHOULD be set to zero, and MUST be ignored when read.
X	SHOULD be set to zero, and MUST be ignored when read.
X	SHOULD be set to zero, and MUST be ignored when read.
X	SHOULD be set to zero, and MUST be ignored when read.
X	SHOULD be set to zero, and MUST be ignored when read.
X	SHOULD be set to zero, and MUST be ignored when read.
X	SHOULD be set to zero, and MUST be ignored when read.
X	SHOULD be set to zero, and MUST be ignored when read.
X	SHOULD be set to zero, and MUST be ignored when read.
X	SHOULD be set to zero, and MUST be ignored when read.

2.2.8 Connection Types Relevant to Applications

2.2.8.1 Transaction Initiation and Completion

2.2.8.1.1 CONNTYPE_TXUSER_BEGINNER

This connection type is used by applications that begin, commit, and roll back transactions.

For more information about CONNTYPE_TXUSER_BEGINNER as an initiator, see section 3.3.5.1.1, and as an acceptor, see section 3.4.5.1.1.

2.2.8.1.1.1 TXUSER_BEGINNER_MTAG_ABORT

This message requests an attempt to abort the transaction that was begun on this connection.

0	1	2	3	4	5	6	7	8	9	10	11	12	13	14	15	16	17	18	19	20	21	22	23	24	25	26	27	28	29	30	31
MsgHeader (24 bytes)																															
...																															
...																															
guidReason (16 bytes)																															
...																															
...																															

MsgHeader (24 bytes): This field MUST contain a MESSAGE_PACKET structure.

- The **dwUserMsgType** field MUST be 0x00001013.
- The **dwcbVarLenData** field MUST be 16.

guidReason (16 bytes): The value MUST be set to an implementation-specific GUID that specifies the reason for aborting the transaction and SHOULD be ignored on receipt.

2.2.8.1.1.2 TXUSER_BEGINNER_MTAG_BEGIN

This message requests the creation of a transaction.

0	1	2	3	4	5	6	7	8	9	10	11	12	13	14	15	16	17	18	19	20	21	22	23	24	25	26	27	28	29	30	31
MsgHeader (24 bytes)																															
...																															
...																															
isoLevel																															

dwTimeout
szDesc (40 bytes)
...
...
isoFlags

MsgHeader (24 bytes): This field MUST contain a MESSAGE_PACKET structure.

- The **dwUserMsgType** field MUST be 0x00001011.
- The **dwcbVarLenData** field MUST be 52.

isoLevel (4 bytes): The OLETX_ISOLATION_LEVEL enumeration that is defined for the transaction.

dwTimeout (4 bytes): A 32-bit unsigned integer that MUST contain the time-out value, in milliseconds, for the transaction. The value zero MUST be interpreted as an infinite time-out. A transaction SHOULD NOT abort due to time-out before the time-out that is specified by this value has expired.

szDesc (40 bytes): The description of the transaction, as a fixed-size array of 40 bytes that contains a null-terminated Latin-1 ANSI string, as specified in [ISO/IEC-8859-1]. See section 2.2.5.4 for details.

isoFlags (4 bytes): The OLETX_ISOLATION_FLAGS enumeration that is defined for the transaction.

2.2.8.1.1.3 TXUSER_BEGINNER_MTAG_BEGIN_LOG_FULL

This message indicates that the transaction was not created because the transaction recovery log had insufficient space to accommodate the new transaction.

0	1	2	3	4	5	6	7	8	9	10	11	12	13	14	15	16	17	18	19	20	21	22	23	24	25	26	27	28	29	30	31
MsgHeader (24 bytes)																															
...																															
...																															

MsgHeader (24 bytes): This field MUST contain a MESSAGE_PACKET structure.

- The **dwUserMsgType** field MUST be 0x00001018.
- The **dwcbVarLenData** field MUST be 0.

2.2.8.1.1.4 TXUSER_BEGINNER_MTAG_BEGIN_NO_MEM

This message indicates that the transaction was not created because of insufficient memory.

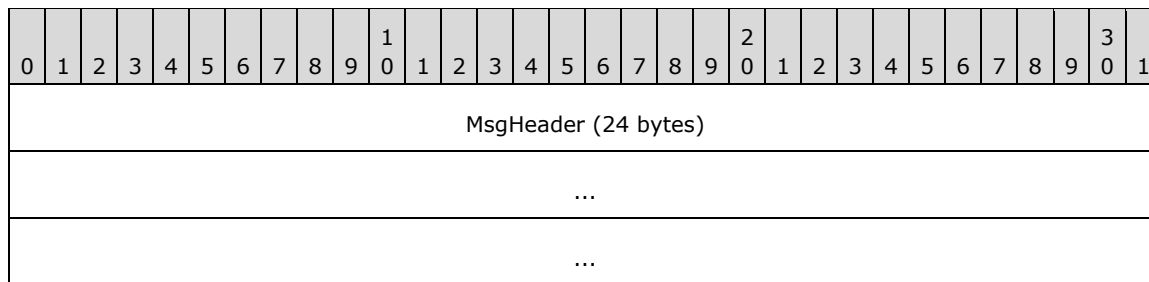

MsgHeader (24 bytes): This field MUST contain a MESSAGE_PACKET structure.

- The **dwUserMsgType** field MUST be 0x00001019.
- The **dwcbVarLenData** field MUST be 0.

2.2.8.1.1.5 TXUSER_BEGINNER_MTAG_BEGUN

This message indicates that the request to begin a transaction was successful.

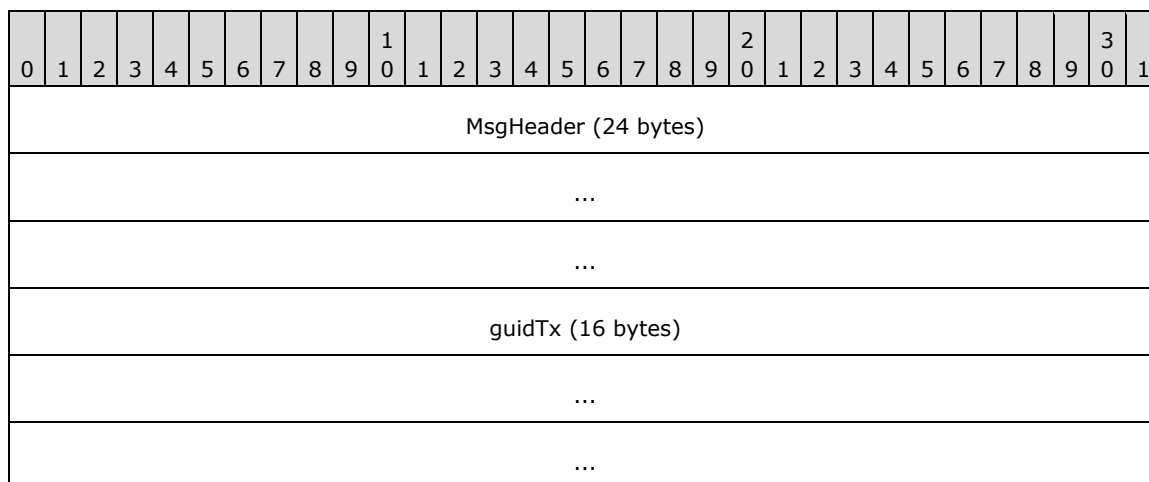

MsgHeader (24 bytes): This field MUST contain a MESSAGE_PACKET structure.

- The **dwUserMsgType** field MUST be 0x00001012.
- The **dwcbVarLenData** field MUST be 16.

guidTx (16 bytes): This field MUST contain a GUID that specifies the transaction identifier. The value MUST NOT be set to a NULL GUID.

2.2.8.1.1.6 TXUSER_BEGINNER_MTAG_COMMIT

This message requests an attempt to commit the transaction that was begun on this connection.

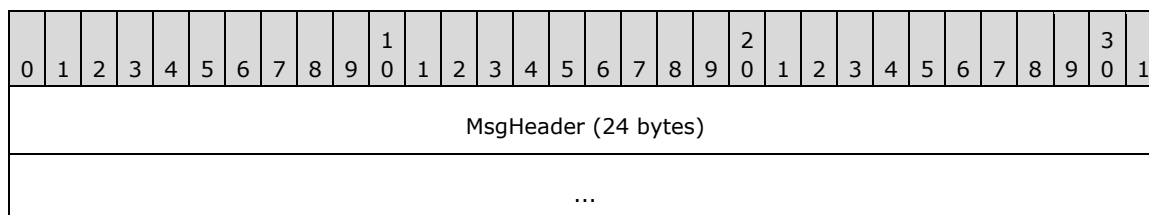

...
grfRM
fAsyncFull

MsgHeader (24 bytes): This field MUST contain a MESSAGE_PACKET structure.

- The **dwUserMsgType** field MUST be 0x00001014.
- The **dwcbVarLenData** field MUST be 8.

grfRM (4 bytes): The value of this field MUST be as specified in GRFRM (section 2.2.7.1).

fAsyncFull (4 bytes): Reserved. This value MUST be set to zero and MUST be ignored on receipt.

2.2.8.1.1.7 TXUSER_BEGINNER_MTAG_COMMIT_INDOUBT

This message indicates that the transaction manager is unable to determine, and will never be able to determine, the outcome of the transaction.

0	1	2	3	4	5	6	7	8	9	10	11	12	13	14	15	16	17	18	19	20	21	22	23	24	25	26	27	28	29	30	31
MsgHeader (24 bytes)																															
...																															
...																															

MsgHeader (24 bytes): This field MUST contain a MESSAGE_PACKET structure.

- The **dwUserMsgType** field MUST be 0x00001990.
- The **dwcbVarLenData** field MUST be 0.

2.2.8.1.1.8 TXUSER_BEGINNER_MTAG_COMMIT_TOO_LATE

This message indicates that the commit request cannot be completed successfully because it is too late in the lifetime of the transaction to commit it.

0	1	2	3	4	5	6	7	8	9	10	11	12	13	14	15	16	17	18	19	20	21	22	23	24	25	26	27	28	29	30	31
MsgHeader (24 bytes)																															
...																															
...																															

MsgHeader (24 bytes): This field MUST contain a MESSAGE_PACKET structure.

- The **dwUserMsgType** field MUST be 0x00001016.
- The **dwcbVarLenData** field MUST be 0.

2.2.8.1.1.9 TXUSER_BEGINNER_MTAG_REQUEST_COMPLETED

This message is sent to indicate that the request to commit or abort the transaction was completed successfully.

0	1	2	3	4	5	6	7	8	9	0	1	2	3	4	5	6	7	8	9	0	1	2	3	4	5	6	7	8	9	0	1
MsgHeader (24 bytes)																															
...																															
...																															

MsgHeader (24 bytes): This field MUST contain a MESSAGE_PACKET structure.

- The **dwUserMsgType** field MUST be 0x00001015.
- The **dwcbVarLenData** field MUST be 0.

2.2.8.1.2 CONNTYPE_TXUSER_BEGIN2

This connection type is used by an application to begin, commit, or roll back a transaction or to change the time-out of a transaction. This connection type supersedes CONNTYPE_TXUSER_BEGINNER and CONNTYPE_TXUSER_SETTETIMEOUT2.

For more information about CONNTYPE_TXUSER_BEGIN2 as an initiator, see 3.3.5.1.2, and as an acceptor, see 3.4.5.1.2.

This connection type also uses the following message:

- TXUSER_SETTETIMEOUT_MTAG_TX_NOT_FOUND (section 2.2.8.3.3.1)

2.2.8.1.2.1 TXUSER_BEGIN2_MTAG_ABORT

The TXUSER_BEGIN2_MTAG_ABORT message requests an attempt to abort the transaction that was begun on this connection.

0	1	2	3	4	5	6	7	8	9	0	1	2	3	4	5	6	7	8	9	0	1	2	3	4	5	6	7	8	9	0	1
MsgHeader (24 bytes)																															
...																															
...																															

MsgHeader (24 bytes): This field MUST contain a MESSAGE_PACKET structure.

- The **dwUserMsgType** field MUST be 0x00006001.
- The **dwcbVarLenData** field MUST be 0.

2.2.8.1.2.2 TXUSER_BEGIN2_MTAG_BEGIN

This message is used to request the creation of a transaction.

0	1	2	3	4	5	6	7	8	9	10	11	12	13	14	15	16	17	18	19	20	21	22	23	24	25	26	27	28	29	30	31
MsgHeader (24 bytes)																															
...																															
...																															
isoLevel																															
dwTimeout																															
szDesc (40 bytes)																															
...																															
...																															
isoFlags																															

MsgHeader (24 bytes): This field MUST contain a MESSAGE_PACKET structure:

- The **dwUserMsgType** field MUST be 0x00006002.
- The **dwcbVarLenData** field MUST be 52.

isoLevel (4 bytes): See the **isoLevel** field in section 2.2.8.1.1.2 for details.

dwTimeout (4 bytes): See the **dwTimeout** field in section 2.2.8.1.1.2 for details.

szDesc (40 bytes): See the **szDesc** field in section 2.2.8.1.1.2 for details.

isoFlags (4 bytes): See the **isoFlags** field in section 2.2.8.1.1.2 for details.

2.2.8.1.2.3 TXUSER_BEGIN2_MTAG_COMMIT

The TXUSER_BEGIN2_MTAG_COMMIT message requests an attempt to commit the transaction that was begun on this connection.

0	1	2	3	4	5	6	7	8	9	10	11	12	13	14	15	16	17	18	19	20	21	22	23	24	25	26	27	28	29	30	31
MsgHeader (24 bytes)																															
...																															
...																															
grfRM																															

MsgHeader (24 bytes): This field MUST contain a MESSAGE_PACKET structure:

- The **dwUserMsgType** field MUST be 0x00006003.

- The **dwcbVarLenData** field MUST be 4.

grFRM (4 bytes): The value of this field MUST be as specified in GRFRM.

2.2.8.1.2.4 TXUSER_BEGIN2_MTAG_SINK_BEGUN

This message indicates that the request to begin a transaction was successful.

0	1	2	3	4	5	6	7	8	9	10	11	12	13	14	15	16	17	18	19	20	21	22	23	24	25	26	27	28	29	30	31
MsgHeader (24 bytes)																															
...																															
...																															
guidTx (16 bytes)																															
...																															
...																															

MsgHeader (24 bytes): This field MUST contain a MESSAGE_PACKET structure:

- The **dwUserMsgType** field MUST be 0x00006006.
- The **dwcbVarLenData** field MUST be 16.

guidTx (16 bytes): This field MUST contain a GUID that specifies the transaction identifier. This value MUST NOT be a NULL GUID.

2.2.8.1.2.5 TXUSER_BEGIN2_MTAG_SINK_ERROR

The content of this message provides information about the outcome of a request.

0	1	2	3	4	5	6	7	8	9	10	11	12	13	14	15	16	17	18	19	20	21	22	23	24	25	26	27	28	29	30	31
MsgHeader (24 bytes)																															
...																															
...																															
Error																															

MsgHeader (24 bytes): This field MUST contain a MESSAGE_PACKET structure:

- The **dwUserMsgType** field MUST be 0x00006005.
- The **dwcbVarLenData** field MUST be 4.

Error (4 bytes): This field MUST contain the status for the previous request. The value MUST be a member of the TRUN_TXBEGIN_ERRORS enumeration.

2.2.8.1.2.6 TXUSER_SETTXTIMEOUT_MTAG_REQUEST_COMPLETE

This message indicates that the transaction time-out was successfully modified.

This message is also used for CONNTYPE_TXUSER_SETTXTIMEOUT.

0	1	2	3	4	5	6	7	8	9	10	11	12	13	14	15	16	17	18	19	20	21	22	23	24	25	26	27	28	29	30	31
MsgHeader (24 bytes)																															
...																															
...																															

MsgHeader (24 bytes): This field MUST contain a MESSAGE_PACKET structure:

- The **dwUserMsgType** field MUST be 0x0000107C.
- The **dwcbVarLenData** field MUST be 0.

2.2.8.1.2.7 TXUSER_SETTXTIMEOUT_MTAG_SETTXTIMEOUT

This message modifies the transaction time-out when it is used in CONNTYPE_TXUSER_BEGIN2 (section 2.2.8.1.2) and CONNTYPE_TXUSER_SETTXTIMEOUT (section 2.2.8.3.3), or queries if the transaction manager supports the capability to do so when used in CONNTYPE_TXUSER_SETTXTIMEOUT2 (section 2.2.8.3.4).

This message is also used for CONNTYPE_TXUSER_SETTXTIMEOUT (section 2.2.8.3.3) and CONNTYPE_TXUSER_SETTXTIMEOUT2 (section 2.2.8.3.4).

0	1	2	3	4	5	6	7	8	9	10	11	12	13	14	15	16	17	18	19	20	21	22	23	24	25	26	27	28	29	30	31
MsgHeader (24 bytes)																															
...																															
...																															
guidTx (16 bytes)																															
...																															
...																															
dwTxTimeout																															

MsgHeader (24 bytes): This field MUST contain a MESSAGE_PACKET structure:

- The **dwUserMsgType** field MUST be 0x0000107B.
- The **dwcbVarLenData** field MUST be 20.

guidTx (16 bytes): This field MUST contain a GUID that specifies the transaction identifier. When this message is sent on a CONNTYPE_TXUSER_SETTXTIMEOUT2 (section 2.2.8.3.4) connection to query the capability of the transaction manager, this value SHOULD be set to a NULL GUID and MUST be ignored on receipt.

dwTxTimeout (4 bytes): A 32-bit unsigned integer that contains the new time-out value, in milliseconds, for the transaction. When used with a CONNTYPE_TXUSER_BEGIN2 (section 2.2.8.1.2) connection, a transaction MUST NOT abort due to time-out before the number of milliseconds that is specified by the value has expired. The value zero MUST be interpreted as an infinite time-out. When used with a CONNTYPE_TXUSER_SETTXTIMEOUT2 (section 2.2.8.3.4) connection, this value SHOULD be set to zero and MUST be ignored on receipt.

2.2.8.1.2.8 TXUSER_SETTXTIMEOUT_MTAG_TOO_LATE

This message indicates that it is too late to modify the time-out of the transaction.

This message is also in the CONNTYPE_TXUSER_SETTXTIMEOUT connection type.

0	1	2	3	4	5	6	7	8	9	10	11	12	13	14	15	16	17	18	19	20	21	22	23	24	25	26	27	28	29	30	31
MsgHeader (24 bytes)																															
...																															
...																															

MsgHeader (24 bytes): This field MUST contain a MESSAGE_PACKET structure:

- The **dwUserMsgType** field MUST be 0x0000107E.
- The **dwcbVarLenData** field MUST be 0.

2.2.8.1.3 CONNTYPE_TXUSER_PROMOTE

This connection type is used by an application to do the following:

- Begin a transaction using an application-specified transaction identity
- Commit or roll back a transaction
- Change the time-out of a transaction

This connection type supersedes CONNTYPE_TXUSER_SETTXTIMEOUT2.

For more information about CONNTYPE_TXUSER_PROMOTE as an initiator, see section 3.3.5.1.3, and as an acceptor, see section 3.4.5.1.3.

This connection type also uses the following messages:

- TXUSER_BEGIN2_MTAG_COMMIT (section 2.2.8.1.2.3)
- TXUSER_BEGIN2_MTAG_ABORT (section 2.2.8.1.2.1)
- TXUSER_BEGIN2_MTAG_SINK_BEGUN (section 2.2.8.1.2.4)
- TXUSER_BEGIN2_MTAG_SINK_ERROR (section 2.2.8.1.2.5)
- TXUSER_SETTXTIMEOUT_MTAG_SETTXTIMEOUT (section 2.2.8.1.2.7)

- TXUSER_SETTXTIMEOUT_MTAG_TOO_LATE (section 2.2.8.1.2.8)
- TXUSER_SETTXTIMEOUT_MTAG_REQUEST_COMPLETE (section 2.2.8.1.2.6)

2.2.8.1.3.1 TXUSER_BEGINNER_MTAG_PROMOTE

This message is used to request the creation of a transaction that specifies a predetermined transaction identifier.

0	1	2	3	4	5	6	7	8	9	0	1	2	3	4	5	6	7	8	9	0	1	2	3	4	5	6	7	8	9	0	1
MsgHeader (24 bytes)																															
...																															
...																															
isoLevel																															
dwTimeout																															
szDesc (40 bytes)																															
...																															
...																															
isoFlags																															
guidTx (16 bytes)																															
...																															
...																															

MsgHeader (24 bytes): This field MUST contain a MESSAGE_PACKET structure:

- The **dwUserMsgType** field MUST be 0x00001010.
- The **dwcbVarLenData** field MUST be 68.

isoLevel (4 bytes): See the **isoLevel** field in section 2.2.8.1.1.2 for details.

dwTimeout (4 bytes): See the **dwTimeout** field in section 2.2.8.1.1.2 for details.

szDesc (40 bytes): See the **szDesc** field in section 2.2.8.1.1.2 for details.

isoFlags (4 bytes): See the **isoFlags** field in section 2.2.8.1.1.2 for details.

guidTx (16 bytes): This field MUST contain a GUID that specifies the transaction identifier.

2.2.8.2 Transaction Propagation

2.2.8.2.1 Pull Propagation

2.2.8.2.1.1 CONNTYPE_TXUSER_ASSOCIATE

This connection type is used by a destination application to complete the pull propagation of a transaction from a source application.

For more information about CONNTYPE_TXUSER_ASSOCIATE as an initiator, see section 3.3.5.2.1.1, and as an acceptor, see section 3.4.5.2.1.1.

2.2.8.2.1.1.1 TXUSER_ASSOCIATE_MTAG_ASSOCIATE

This message requests that the transaction manager perform pull propagation of an existing transaction. This is also known as an associate request.

0	1	2	3	4	5	6	7	8	9	10	11	12	13	14	15	16	17	18	19	20	21	22	23	24	25	26	27	28	29	30	31
MsgHeader (24 bytes)																															
...																															
...																															
guidTx (16 bytes)																															
...																															
...																															
isoLevel																															
isoFlags																															
cbSourceTmAddr																															
szDesc (40 bytes)																															
...																															
...																															
SourceTmAddr (variable)																															
...																															

MsgHeader (24 bytes): This field MUST contain a MESSAGE_PACKET structure.

- The **dwUserMsgType** field MUST be 0x00002031.
- The **dwcbVarLenData** field MUST be equal to the value of **cbSourceTmAddr** plus 68.

guidTx (16 bytes): This field MUST contain a GUID that specifies the transaction identifier.

isoLevel (4 bytes): See the **isoLevel** field in section 2.2.8.1.1.2 for details.

isoFlags (4 bytes): See the **isoFlags** field in section 2.2.8.1.1.2 for details.

cbSourceTmAddr (4 bytes): A 4-byte integer value that MUST contain the length, in bytes, of the **SourceTmAddr** field. The length MUST include the padding bytes used in the **SourceTmAddr** field.

szDesc (40 bytes): See the **szDesc** field in section 2.2.8.1.1.2 for details.

SourceTmAddr (variable): This field is used for identifying the address of the superior transaction manager against which the pull propagation operation is requested. This field MUST contain either a NAMEOBJECTBLOB (section 2.2.5.3) structure or an OLETX_TM_ADDR (section 2.2.4.2) structure in a version-specific manner as specified in Version-Specific Aspects of Connection Types Relevant to an Application (section 2.2.1.1.1). The **SourceTmAddr** field MUST be aligned on a 4-byte boundary by padding with arbitrary values.

2.2.8.2.1.1.2 TXUSER_ASSOCIATE_MTAG_ASSOCIATED

This message indicates that the associate request was successful.

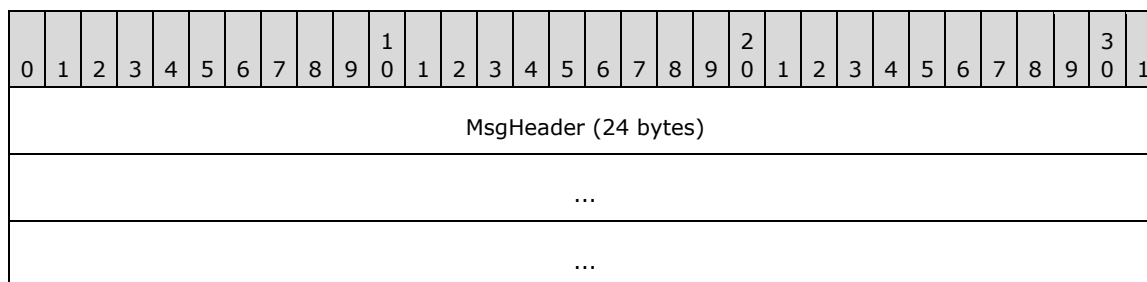

MsgHeader (24 bytes): This field MUST contain a MESSAGE_PACKET structure.

- The **dwUserMsgType** field MUST be 0x00002032.
- The **dwcbVarLenData** field MUST be 0.

2.2.8.2.1.1.3 TXUSER_ASSOCIATE_MTAG_COMM_FAILED

This message indicates that the associated request failed because the sender of this message encountered a communication failure with the Superior Transaction Manager specified in the **SourceTmAddr** field of the TXUSER_ASSOCIATE_MTAG_ASSOCIATE (section 2.2.8.2.1.1.1) message.

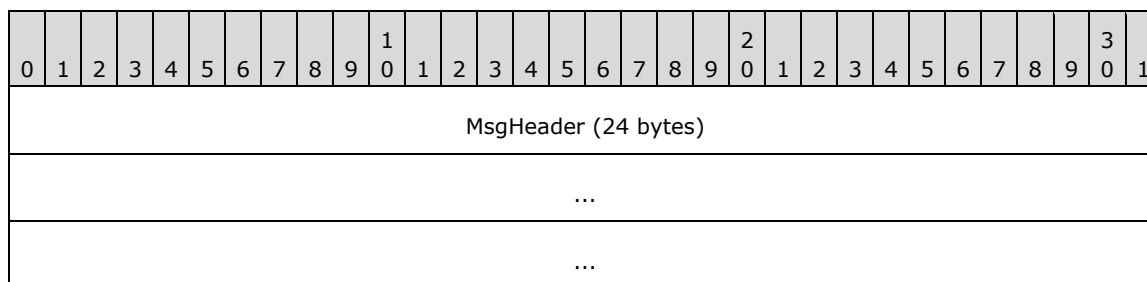

MsgHeader (24 bytes): This field MUST contain a MESSAGE_PACKET structure.

- The **dwUserMsgType** field MUST be 0x00002034.

- The **dwcbVarLenData** field MUST be 0.

2.2.8.2.1.1.4 TXUSER_ASSOCIATE_MTAG_CREATE_BAD_TMADDR

This message indicates that the associate request failed because of failures during interpretation and processing of the **SourceTmAddr** field in the TXUSER_ASSOCIATE_MTAG_ASSOCIATE (section 2.2.8.2.1.1.1) message.

0	1	2	3	4	5	6	7	8	9	10	11	12	13	14	15	16	17	18	19	20	21	22	23	24	25	26	27	28	29	30	31
MsgHeader (24 bytes)																															
...																															
...																															

MsgHeader (24 bytes): This field MUST contain a MESSAGE_PACKET structure.

- The **dwUserMsgType** field MUST be 0x00002044.
- The **dwcbVarLenData** field MUST be 0.

2.2.8.2.1.1.5 TXUSER_ASSOCIATE_MTAG_LOG_FULL_LOCAL

This message indicates that the associate request failed because the transaction recovery log was full at the transaction manager sending this message.

0	1	2	3	4	5	6	7	8	9	10	11	12	13	14	15	16	17	18	19	20	21	22	23	24	25	26	27	28	29	30	31
MsgHeader (24 bytes)																															
...																															
...																															

MsgHeader (24 bytes): This field MUST contain a MESSAGE_PACKET structure.

- The **dwUserMsgType** field MUST be 0x00002035.
- The **dwcbVarLenData** field MUST be 0.

2.2.8.2.1.1.6 TXUSER_ASSOCIATE_MTAG_LOG_FULL_REMOTE

This message indicates first that the associated request failed because of a full transaction recovery log at the superior transaction manager specified in the **SourceTmAddr** field of the TXUSER_ASSOCIATE_MTAG_ASSOCIATE (section 2.2.8.2.1.1.1) message.

0	1	2	3	4	5	6	7	8	9	10	11	12	13	14	15	16	17	18	19	20	21	22	23	24	25	26	27	28	29	30	31
MsgHeader (24 bytes)																															
...																															

...

MsgHeader (24 bytes): This field MUST contain a MESSAGE_PACKET structure.

- The **dwUserMsgType** field MUST be 0x00002037.
- The **dwcbVarLenData** field MUST be 0.

2.2.8.2.1.1.7 TXUSER_ASSOCIATE_MTAG_NO_MEM_LOCAL

This message indicates that the associate request failed because of a failure to allocate dynamic memory by the transaction manager sending this message while processing the TXUSER_ASSOCIATE_MTAG_ASSOCIATE (section 2.2.8.2.1.1.1) message.

0	1	2	3	4	5	6	7	8	9	10	11	12	13	14	15	16	17	18	19	20	21	22	23	24	25	26	27	28	29	30	31
MsgHeader (24 bytes)																															
...																															
...																															

MsgHeader (24 bytes): This field MUST contain a MESSAGE_PACKET structure.

- The **dwUserMsgType** field MUST be 0x00002036.
- The **dwcbVarLenData** field MUST be 0.

2.2.8.2.1.1.8 TXUSER_ASSOCIATE_MTAG_NO_MEM_REMOTE

This message indicates that the associate request failed because of a failure to allocate dynamic memory by the Superior Transaction Manager specified in the **SourceTmAddr** field of the TXUSER_ASSOCIATE_MTAG_ASSOCIATE (section 2.2.8.2.1.1.1) message.

0	1	2	3	4	5	6	7	8	9	10	11	12	13	14	15	16	17	18	19	20	21	22	23	24	25	26	27	28	29	30	31
MsgHeader (24 bytes)																															
...																															
...																															

MsgHeader (24 bytes): This field MUST contain a MESSAGE_PACKET structure.

- The **dwUserMsgType** field MUST be 0x00002038.
- The **dwcbVarLenData** field MUST be 0.

2.2.8.2.1.1.9 TXUSER_ASSOCIATE_MTAG_TOO_LATE

This message is sent in response to a TXUSER_ASSOCIATE_MTAG_ASSOCIATE (section 2.2.8.2.1.1.1) message. It indicates that the associate request failed because the transaction specified by the

guidTx field in the TXUSER_ASSOCIATE_MTAG_ASSOCIATE message is neither in the Active, Phase Zero, nor Phase Zero Complete state.

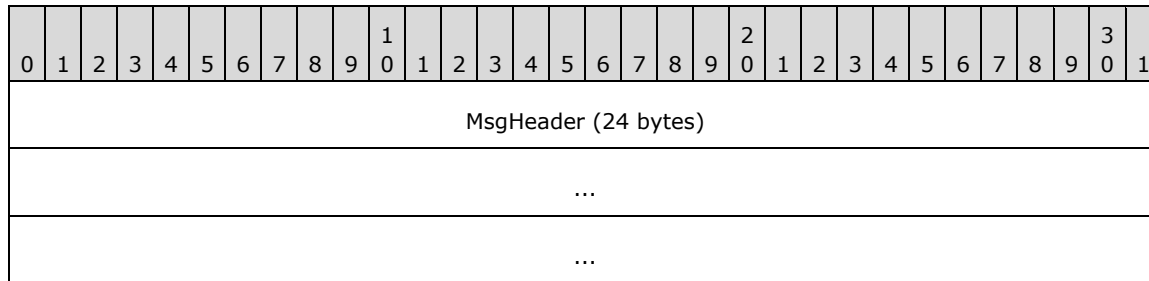

MsgHeader (24 bytes): This field MUST contain a MESSAGE_PACKET structure.

- The **dwUserMsgType** field MUST be 0x00002040.
- The **dwcbVarLenData** field MUST be 0.

2.2.8.2.1.1.10 TXUSER_ASSOCIATE_MTAG_TOO_MANY_LOCAL

This message indicates that the associate request failed because the number of direct participants for the transaction specified by the **guidTx** field in the TXUSER_ASSOCIATE_MTAG_ASSOCIATE (section 2.2.8.2.1.1.1) message exceeded an implementation-specific limit by the transaction manager sending this message while processing the TXUSER_ASSOCIATE_MTAG_ASSOCIATE message.<18>

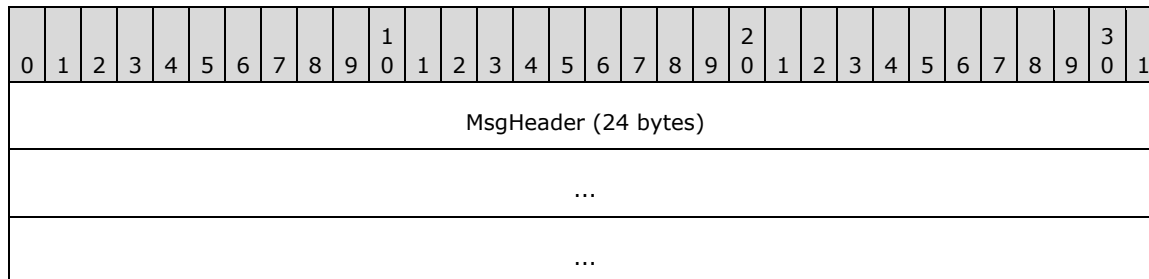

MsgHeader (24 bytes): This field MUST contain a MESSAGE_PACKET structure.

- The **dwUserMsgType** field MUST be 0x00002041.
- The **dwcbVarLenData** field MUST be 0.

2.2.8.2.1.1.11 TXUSER_ASSOCIATE_MTAG_TOO_MANY_REMOTE

This message indicates a failure by the associate request. The number of direct participants for the transaction that is specified by the **guidTx** field in the TXUSER_ASSOCIATE_MTAG_ASSOCIATE (section 2.2.8.2.1.1.1) message exceeded the limit at the Superior Transaction Manager referenced in the **SourceTmAddr** field of the TXUSER_ASSOCIATE_MTAG_ASSOCIATE message.

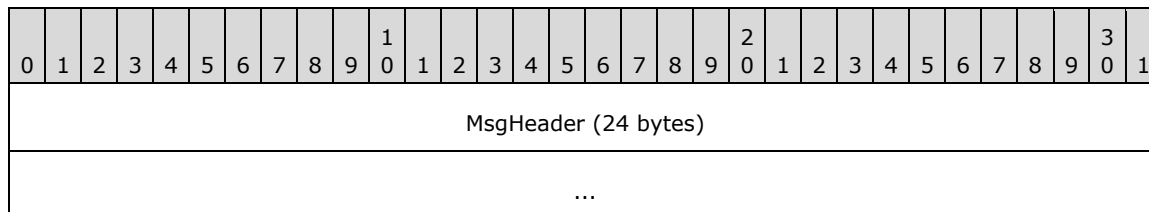

...

MsgHeader (24 bytes): This field MUST contain a MESSAGE_PACKET structure.

- The **dwUserMsgType** field MUST be 0x00002042.
- The **dwcbVarLenData** field MUST be 0.

2.2.8.2.1.1.12 TXUSER_ASSOCIATE_MTAG_TX_NOT_FOUND

This message indicates that the associate request failed because the transaction specified by the **guidTx** field in the TXUSER_ASSOCIATE_MTAG_ASSOCIATE (section 2.2.8.2.1.1.1) message was not found.

0	1	2	3	4	5	6	7	8	9	10	11	12	13	14	15	16	17	18	19	20	21	22	23	24	25	26	27	28	29	30	31
MsgHeader (24 bytes)																															
...																															
...																															

MsgHeader (24 bytes): This field MUST contain a MESSAGE_PACKET structure.

- The **dwUserMsgType** field MUST be 0x00002043.
- The **dwcbVarLenData** field MUST be 0.

2.2.8.2.2 Push Propagation

2.2.8.2.2.1 CONNTYPE_TXUSER_EXTENDEDDHEREABOUTS

This connection type is used by an application to obtain Extended Whereabouts from its transaction manager.

For more information about CONNTYPE_TXUSER_EXTENDEDDHEREABOUTS as an initiator, see section 3.3.5.2.2.1, and as an acceptor, see section 3.4.5.2.2.1.

2.2.8.2.2.1.1 TXUSER_EXTENDEDDHEREABOUTS_MTAG_GET

This message is sent by the application to the transaction manager to obtain the Extended Whereabouts of the transaction manager.

0	1	2	3	4	5	6	7	8	9	10	11	12	13	14	15	16	17	18	19	20	21	22	23	24	25	26	27	28	29	30	31
MsgHeader (24 bytes)																															
...																															
...																															

MsgHeader (24 bytes): This field MUST contain a MESSAGE_PACKET structure.

- The **dwUserMsgType** field MUST be 0x00005A01.
- The **dwcbVarLenData** field MUST be 0.

2.2.8.2.2.1.2 TXUSER_EXTENDEDWHEREABOUTS_MTAG_GOT

This message returns the set of extended whereabouts elements.

0	1	2	3	4	5	6	7	8	9	10	11	12	13	14	15	16	17	18	19	20	21	22	23	24	25	26	27	28	29	30	31
MsgHeader (24 bytes)																															
...																															
...																															
dwProtocolCount																															
rgtmprotUsableList (variable)																															
...																															

MsgHeader (24 bytes): This field MUST contain a MESSAGE_PACKET structure.

- The **dwUserMsgType** field MUST be 0x00005A02.
- The **dwcbVarLenData** field MUST be the number of bytes used by the **rgtmprotUsableList** field plus 4.

dwProtocolCount (4 bytes): An unsigned 32-bit value that MUST contain the number of elements in the **rgtmprotUsableList** array. If this value is zero, the **rgtmprotUsableList** field MUST be omitted.

rgtmprotUsableList (variable): Array of STmToTmProtocol (section 2.2.5.9) elements, each of which MUST be of type TmProtocolExtended. Each element defines the location information for an extension protocol. Each element MUST be aligned on a 4-byte boundary.

2.2.8.2.2.1.3 TXUSER_EXTENDEDWHEREABOUTS_MTAG_NOMEM

This message is sent by the transaction manager to the client in response to a TXUSER_EXTENDEDWHEREABOUTS_MTAG_GET (section 2.2.8.2.2.1.1) message to indicate that there is not enough memory to process the request.

0	1	2	3	4	5	6	7	8	9	10	11	12	13	14	15	16	17	18	19	20	21	22	23	24	25	26	27	28	29	30	31
MsgHeader (24 bytes)																															
...																															
...																															

MsgHeader (24 bytes): This field MUST contain a MESSAGE_PACKET structure.

- The **dwUserMsgType** field MUST be 0x00005A03.
- The **dwcbVarLenData** field MUST be 0.

2.2.8.2.2.2 CONNTYPE_TXUSER_EXPORT

This connection type is used by a source application to initiate a push propagation to a destination application.

For more information about CONNTYPE_TXUSER_EXPORT as an initiator, see section 3.3.5.2.2.2, and as an acceptor, see section 3.4.5.2.2.2.

2.2.8.2.2.2.1 TXUSER_EXPORT_MTAG_CREATE

This message is used by applications to establish a connection with the transaction manager in order to export transactions to a destination transaction manager.

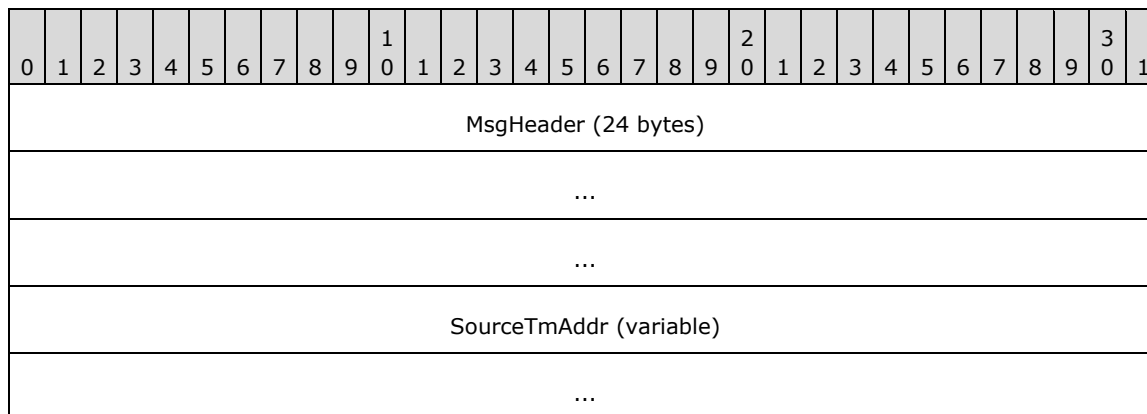

MsgHeader (24 bytes): This field MUST contain a MESSAGE_PACKET structure.

- The **dwUserMsgType** field MUST be 0x00001041.
- The **dwcbVarLenData** field MUST be the number of bytes used for the **SourceTmAddr** field, and the value MUST be at least 40.

SourceTmAddr (variable): This field specifies the network address and identification information for the destination transaction manager. This field MUST contain either a NAMEOBJECTBLOB (section 2.2.5.3) structure or an OLETX_TM_ADDR (section 2.2.4.2) structure in a version-specific manner as described in Version-Specific Aspects of Connection Types Relevant to an Application (section 2.2.1.1.1). This transaction manager receives push propagation operations from the source transaction manager, which is the recipient of this message. CONNTYPE_PARTNERTM_PROPAGATE (section 2.2.9.1.1.1) defines the protocol that is used between the two transaction managers as a result of the export operation.

2.2.8.2.2.2.2 TXUSER_EXPORT_MTAG_CREATE2

This message is used by applications to establish a connection with the transaction manager in preparation to export transactions to a destination transaction manager.

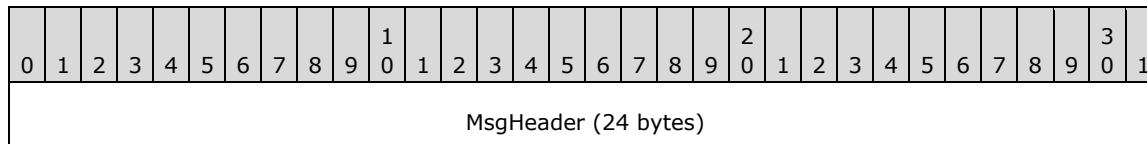

...
...
SourceTmAddr (variable)
...

MsgHeader (24 bytes): This field MUST contain a MESSAGE_PACKET structure.

- The **dwUserMsgType** field MUST be 0x00001804.
- The **dwcbVarLenData** field MUST be the number of bytes used for the **SourceTmAddr** field, and the value MUST be at least 40.

SourceTmAddr (variable): This field MUST contain an OLETX_TM_ADDR structure that specifies the network address and identification information for the destination transaction manager. This transaction manager receives push propagation operations from the source transaction manager, which is the recipient of this message. CONNTYPE_PARTNERTM_PROPAGATE (section 2.2.9.1.1.1) defines the protocol that is used between the two transaction managers as a result of the export operation.

2.2.8.2.2.2.3 TXUSER_EXPORT_MTAG_CREATE_BAD_TMADDR

This message indicates that the create request failed because of errors encountered during the interpretation and processing of the **SourceTmAddr** field in the connection's initial TXUSER_EXPORT_MTAG_CREATE (section 2.2.8.2.2.2.1) or TXUSER_EXPORT_MTAG_CREATE2 (section 2.2.8.2.2.2.2) message.

0	1	2	3	4	5	6	7	8	9	10	11	12	13	14	15	16	17	18	19	20	21	22	23	24	25	26	27	28	29	30	31
MsgHeader (24 bytes)																															
...																															
...																															

MsgHeader (24 bytes): This field MUST contain a MESSAGE_PACKET structure.

- The **dwUserMsgType** field MUST be 0x00001046.
- The **dwcbVarLenData** field MUST be 0.

2.2.8.2.2.2.4 TXUSER_EXPORT_MTAG_CREATE_NET_TX_DISABLED

This message indicates that the create request failed because the transaction manager that received the request has disabled the ability to export transactions to other transaction managers. See the Allow Outbound Transaction flag in Abstract Data Model (section 3.2.1) for more details.

0	1	2	3	4	5	6	7	8	9	10	11	12	13	14	15	16	17	18	19	20	21	22	23	24	25	26	27	28	29	30	31
MsgHeader (24 bytes)																															

...
...

MsgHeader (24 bytes): This field MUST contain a MESSAGE_PACKET structure.

- The **dwUserMsgType** field MUST be 0x00001805.
- The **dwcbVarLenData** field MUST be 0.

2.2.8.2.2.2.5 TXUSER_EXPORT_MTAG_CREATED

This message indicates that the create request succeeded and the connection is now ready to process export requests.

0	1	2	3	4	5	6	7	8	9	10	11	12	13	14	15	16	17	18	19	20	21	22	23	24	25	26	27	28	29	30	31
MsgHeader (24 bytes)																															
...																															
...																															

MsgHeader (24 bytes): This field MUST contain a MESSAGE_PACKET structure.

- The **dwUserMsgType** field MUST be 0x00001042.
- The **dwcbVarLenData** field MUST be 0.

2.2.8.2.2.2.6 TXUSER_EXPORT_MTAG_EXPORT

This message is used to export a transaction to the destination transaction manager that is identified by **SourceTmAddr** in the connection's initial TXUSER_EXPORT_MTAG_CREATE (section 2.2.8.2.2.2.1) or TXUSER_EXPORT_MTAG_CREATE2 (section 2.2.8.2.2.2.2) message.

0	1	2	3	4	5	6	7	8	9	10	11	12	13	14	15	16	17	18	19	20	21	22	23	24	25	26	27	28	29	30	31
MsgHeader (24 bytes)																															
...																															
...																															
guidTX (16 bytes)																															
...																															
...																															

MsgHeader (24 bytes): This field MUST contain a MESSAGE_PACKET structure.

- The **dwUserMsgType** field MUST be 0x00001043.

- The **dwcbVarLenData** field MUST be 16.

guidTX (16 bytes): This field MUST contain a GUID that specifies the transaction identifier.

2.2.8.2.2.2.7 TXUSER_EXPORT_MTAG_EXPORT_LOG_FULL

This message indicates that the export request failed because the transaction recovery log was full at the source transaction manager.

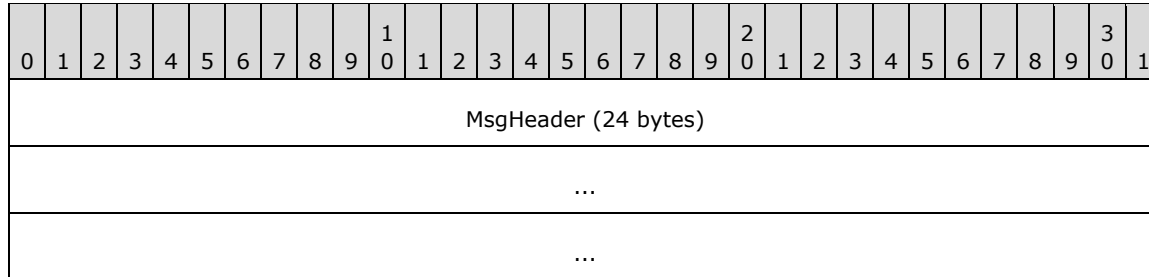

MsgHeader (24 bytes): This field MUST contain a MESSAGE_PACKET structure.

- The **dwUserMsgType** field MUST be 0x00001050.
- The **dwcbVarLenData** field MUST be 0.

2.2.8.2.2.2.8 TXUSER_EXPORT_MTAG_EXPORT_NO_MEM

This message indicates that the export request failed because the source transaction manager was unable to allocate sufficient dynamic memory for the request.

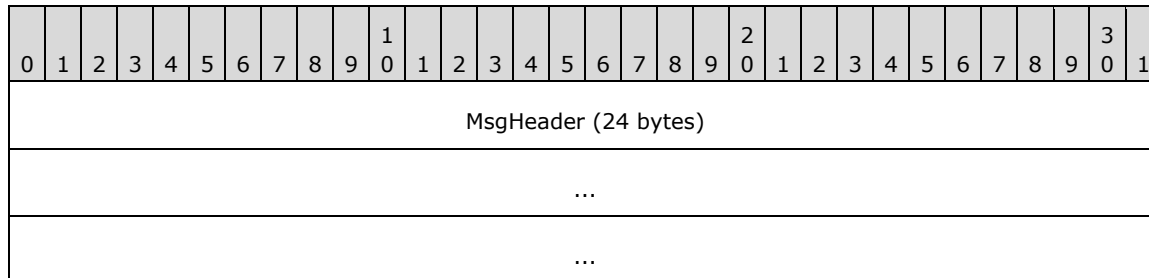

MsgHeader (24 bytes): This field MUST contain a MESSAGE_PACKET structure.

- The **dwUserMsgType** field MUST be 0x00001802.
- The **dwcbVarLenData** field MUST be 0.

2.2.8.2.2.2.9 TXUSER_EXPORT_MTAG_EXPORT_TOO_LATE

This message indicates that the export request failed because it was too late to process the export request for the current state of the transaction. See Export Transaction (section 3.2.7.21) and Export Transaction Failure (section 3.4.7.11) for more information.

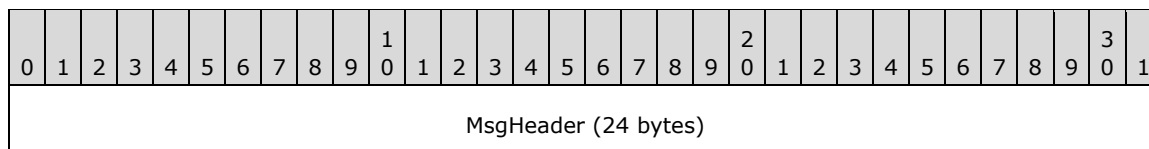

...
...

MsgHeader (24 bytes): This field MUST contain a MESSAGE_PACKET structure.

- The **dwUserMsgType** field MUST be 0x00001049.
- The **dwcbVarLenData** field MUST be 0.

2.2.8.2.2.2.10 TXUSER_EXPORT_MTAG_EXPORT_TOO_MANY

This message indicates that the export request failed because the number of direct participants for the transaction specified by the **guidTX** field in the TXUSER_EXPORT_MTAG_EXPORT (section 2.2.8.2.2.2.6) message exceeded the allowed number of remote transaction manager enlistments. For more information, see Export Transaction (section 3.2.7.21).

0	1	2	3	4	5	6	7	8	9	10	11	12	13	14	15	16	17	18	19	20	21	22	23	24	25	26	27	28	29	30	31
MsgHeader (24 bytes)																															
...																															
...																															

MsgHeader (24 bytes): This field MUST contain a MESSAGE_PACKET structure.

- The **dwUserMsgType** field MUST be 0x00001801.
- The **dwcbVarLenData** field MUST be 0.

2.2.8.2.2.2.11 TXUSER_EXPORT_MTAG_EXPORT_TX_NOT_FOUND

This message indicates that the export request failed because the transaction specified by the **guidTX** field in the TXUSER_EXPORT_MTAG_EXPORT (section 2.2.8.2.2.2.6) message was not found by the source transaction manager.

0	1	2	3	4	5	6	7	8	9	10	11	12	13	14	15	16	17	18	19	20	21	22	23	24	25	26	27	28	29	30	31
MsgHeader (24 bytes)																															
...																															
...																															

MsgHeader (24 bytes): This field MUST contain a MESSAGE_PACKET structure.

- The **dwUserMsgType** field MUST be 0x00001048.
- The **dwcbVarLenData** field MUST be 0.

2.2.8.2.2.2.12 TXUSER_EXPORT_MTAG_EXPORTED

This message indicates that the export request was successful.

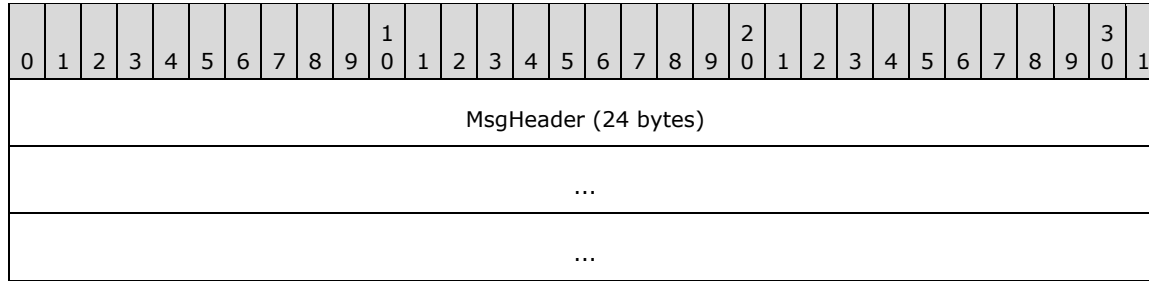

MsgHeader (24 bytes): This field MUST contain a MESSAGE_PACKET structure.

- The **dwUserMsgType** field MUST be 0x00001044.
- The **dwcbVarLenData** field MUST be 0.

2.2.8.2.2.3 CONNTYPE_TXUSER_EXPORT2

This connection type is used by a source application to initiate a push propagation to a destination application. This connection type supersedes CONNTYPE_TXUSER_EXPORT.

For more information about CONNTYPE_TXUSER_EXPORT2 as an initiator, see section 3.3.5.2.2.3, and as an acceptor, see section 3.4.1.9.

This connection type also uses the following messages:

- TXUSER_EXPORT_MTAG_CREATE
- TXUSER_EXPORT_MTAG_CREATE2
- TXUSER_EXPORT_MTAG_CREATE_BAD_TMADDR
- TXUSER_EXPORT_MTAG_CREATE_NET_TX_DISABLED
- TXUSER_EXPORT_MTAG_CREATED
- TXUSER_EXPORT_MTAG_EXPORT
- TXUSER_EXPORT_MTAG_EXPORT_LOG_FULL
- TXUSER_EXPORT_MTAG_EXPORT_NO_MEM
- TXUSER_EXPORT_MTAG_EXPORT_TOO_LATE
- TXUSER_EXPORT_MTAG_EXPORT_TOO_MANY
- TXUSER_EXPORT_MTAG_EXPORT_TX_NOT_FOUND
- TXUSER_EXPORT_MTAG_EXPORTED

2.2.8.2.2.3.1 TXUSER_EXPORT_MTAG_EXPORT_COMM_FAILED

This message indicates that the export request failed because the sender of this message encountered a communication failure with the source transaction manager.

0	1	2	3	4	5	6	7	8	9	10	11	12	13	14	15	16	17	18	19	20	21	22	23	24	25	26	27	28	29	30	31
MsgHeader (24 bytes)																															
...																															
...																															

MsgHeader (24 bytes): This field MUST contain a MESSAGE_PACKET structure.

- The **dwUserMsgType** field MUST be 0x00001806.
- The **dwcbVarLenData** field MUST be 0x00000000.

2.2.8.2.2.4 CONNTYPE_TXUSER_IMPORT

This connection type is used by a destination application to complete a push propagation that is initiated by a source application.

For more information about CONNTYPE_TXUSER_IMPORT as an initiator, see section 3.3.5.2.2.4, and as an acceptor, see section 3.4.5.2.2.4.

2.2.8.2.2.4.1 TXUSER_IMPORT_MTAG_ABORT

This message is a request for the transaction manager to abort the transaction.

0	1	2	3	4	5	6	7	8	9	10	11	12	13	14	15	16	17	18	19	20	21	22	23	24	25	26	27	28	29	30	31
MsgHeader (24 bytes)																															
...																															
...																															
guidReason (16 bytes)																															
...																															
...																															

MsgHeader (24 bytes): This field MUST contain a MESSAGE_PACKET structure.

- The **dwUserMsgType** field MUST be 0x00001023.
- The **dwcbVarLenData** field MUST be 16.

guidReason (16 bytes): The value MUST be set to an implementation-specific GUID that specifies the reason for aborting the transaction and SHOULD be ignored on receipt.

2.2.8.2.2.4.2 TXUSER_IMPORT_MTAG_ABORT_TOO_LATE

This message is sent to the application in the connection type that was created for the originating TXUSER_IMPORT_MTAG_IMPORT (section 2.2.8.2.2.4.3) message.

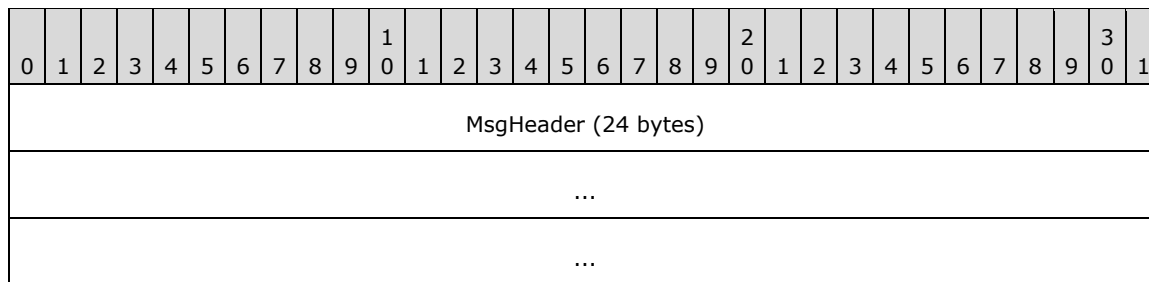

MsgHeader (24 bytes): This field MUST contain a MESSAGE_PACKET structure.

- The **dwUserMsgType** field MUST be 0x00001025.
- The **dwcbVarLenData** field MUST be 0.

2.2.8.2.2.4.3 TXUSER_IMPORT_MTAG_IMPORT

This message is used by a destination application to complete a push propagation operation that is initiated by a source application.

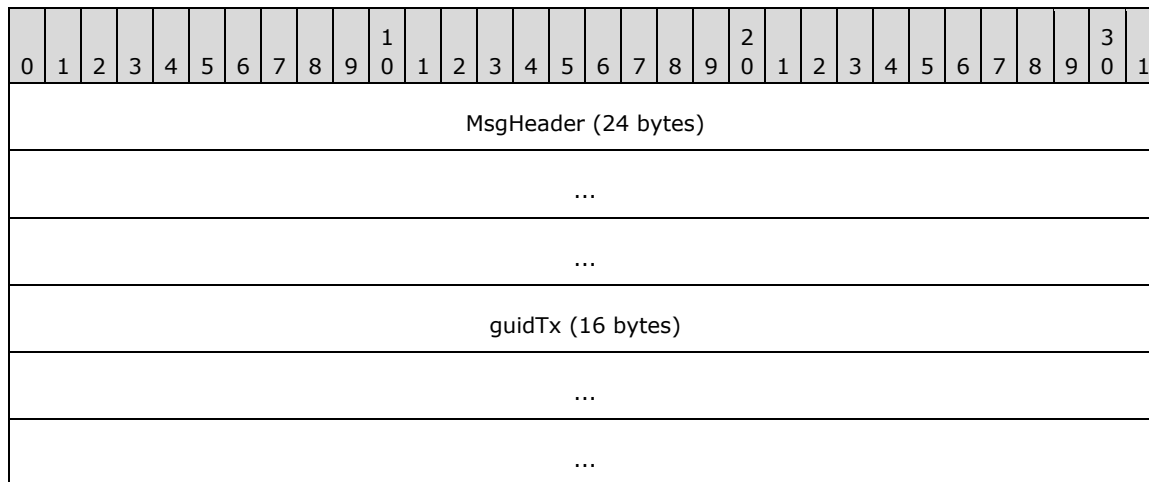

MsgHeader (24 bytes): This field MUST contain a MESSAGE_PACKET structure.

- The **dwUserMsgType** field MUST be 0x00001021.
- The **dwcbVarLenData** field MUST be 16.

guidTx (16 bytes): This field MUST contain a GUID that specifies the transaction identifier.

2.2.8.2.2.4.4 TXUSER_IMPORT_MTAG_IMPORT_TX_NOT_FOUND

This message is sent if the attempt to import the transaction is unsuccessful because the transaction that is specified in the TXUSER_IMPORT_MTAG_IMPORT (section 2.2.8.2.2.4.3) message cannot be found.

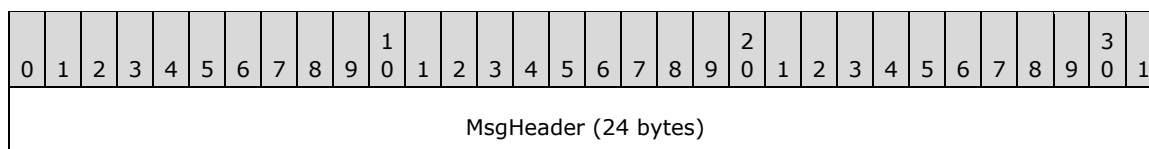

...
...

MsgHeader (24 bytes): This field MUST contain a MESSAGE_PACKET structure.

- The **dwUserMsgType** field MUST be 0x00001026.
- The **dwcbVarLenData** field MUST be 0.

2.2.8.2.2.4.5 TXUSER_IMPORT_MTAG_IMPORTED

This message indicates that the import operation completed successfully.

0	1	2	3	4	5	6	7	8	9	10	11	12	13	14	15	16	17	18	19	20	21	22	23	24	25	26	27	28	29	30	31
MsgHeader (24 bytes)																															
...																															
...																															
isoLevel																															
isoFlags																															

MsgHeader (24 bytes): This field MUST contain a MESSAGE_PACKET structure.

- The **dwUserMsgType** field MUST be 0x00001022.
- The **dwcbVarLenData** field MUST be 8.

isoLevel (4 bytes): See the **isoLevel** field in section 2.2.8.1.1.2 for details.

isoFlags (4 bytes): See the **isoFlags** field in section 2.2.8.1.1.2 for details.

2.2.8.2.2.4.6 TXUSER_IMPORT_MTAG_REQUEST_COMPLETED

This message indicates that the attempt to abort the transaction was successful.

0	1	2	3	4	5	6	7	8	9	10	11	12	13	14	15	16	17	18	19	20	21	22	23	24	25	26	27	28	29	30	31
MsgHeader (24 bytes)																															
...																															
...																															

MsgHeader (24 bytes): This field MUST contain a MESSAGE_PACKET structure.

- The **dwUserMsgType** field MUST be 0x00001024.
- The **dwcbVarLenData** field MUST be 0.

2.2.8.2.2.5 CONNTYPE_TXUSER_IMPORT2

This connection type is used by a destination application to complete a push propagation that is initiated by a source application. This connection type supersedes CONNTYPE_TXUSER_IMPORT.

For more information about CONNTYPE_TXUSER_IMPORT2 as an initiator, see section 3.3.5.2.2.5, and as an acceptor, see section 3.4.5.2.2.5.

2.2.8.2.2.5.1 TXUSER_IMPORT2_MTAG_ABORT

This message is used to abort a transaction that was previously successfully imported by using either the TXUSER_IMPORT2_MTAG_IMPORT (section 2.2.8.2.2.5.2) or TXUSER_IMPORT2_MTAG_IMPORT_WITH_SET (section 2.2.8.2.2.5.3) message.

0	1	2	3	4	5	6	7	8	9	10	11	12	13	14	15	16	17	18	19	20	21	22	23	24	25	26	27	28	29	30	31
MsgHeader (24 bytes)																															
...																															
...																															

MsgHeader (24 bytes): This field MUST contain a MESSAGE_PACKET structure.

- The **dwUserMsgType** field MUST be 0x00006101.
- The **dwcbVarLenData** field MUST be 0.

2.2.8.2.2.5.2 TXUSER_IMPORT2_MTAG_IMPORT

This message is used by resource managers or server processes to establish a transaction connection with their transaction manager. The transaction identifier for which the connection is wanted is identified by the **guidTX** member of the message structure.

0	1	2	3	4	5	6	7	8	9	10	11	12	13	14	15	16	17	18	19	20	21	22	23	24	25	26	27	28	29	30	31
MsgHeader (24 bytes)																															
...																															
...																															
guidTX (16 bytes)																															
...																															
...																															

MsgHeader (24 bytes): This field MUST contain a MESSAGE_PACKET structure.

- The **dwUserMsgType** field MUST be 0x00006102.
- The **dwcbVarLenData** field MUST be 16.

guidTX (16 bytes): This field MUST be a GUID that specifies the transaction identifier.

2.2.8.2.2.5.3 TXUSER_IMPORT2_MTAG_IMPORT_WITH_SET

This message is used by a destination application to complete a push propagation operation that is initiated by a source application. It is similar to the TXUSER_IMPORT2_MTAG_IMPORT (section 2.2.8.2.2.5.2) message, except that it allows the application to specify the isolation level, isolation flags, and description of the transaction, in addition to the identifier.

0	1	2	3	4	5	6	7	8	9	0	1	2	3	4	5	6	7	8	9	0	1	2	3	4	5	6	7	8	9	0	1
MsgHeader (24 bytes)																															
...																															
...																															
guidTX (16 bytes)																															
...																															
...																															
isoLevel																															
isoFlags																															
szDesc (40 bytes)																															
...																															
...																															

MsgHeader (24 bytes): This field MUST contain a MESSAGE_PACKET structure.

- The **dwUserMsgType** field MUST be 0x00006107.
- The **dwcbVarLenData** field MUST be 64.

guidTX (16 bytes): This field MUST contain a GUID that specifies the transaction identifier.

isoLevel (4 bytes): See the **isoLevel** field in section 2.2.8.1.1.2 for details.

isoFlags (4 bytes): See the **isoFlags** field in section 2.2.8.1.1.2 for details.

szDesc (40 bytes): See the **szDesc** field in section 2.2.8.1.1.2 for details.

2.2.8.2.2.5.4 TXUSER_IMPORT2_MTAG_SINK_ERROR

This message is sent if the attempt to import the transaction was unsuccessful or to indicate the success or failure of the abort operation.

0	1	2	3	4	5	6	7	8	9	10	11	12	13	14	15	16	17	18	19	20	21	22	23	24	25	26	27	28	29	30	31
MsgHeader (24 bytes)																															
...																															
...																															
Error																															

MsgHeader (24 bytes): This field MUST contain a MESSAGE_PACKET structure.

- The **dwUserMsgType** field MUST be 0x00006105.
- The **dwcbVarLenData** field MUST be 4.

Error (4 bytes): This field MUST contain the status for the previous request. The value MUST be a member of the TRUN_TXIMPORT_ERRORS enumeration.

2.2.8.2.2.5.5 TXUSER_IMPORT2_MTAG_SINK_IMPORTED

This message provides the isolation level and isolation flags for the specified transaction.

0	1	2	3	4	5	6	7	8	9	10	11	12	13	14	15	16	17	18	19	20	21	22	23	24	25	26	27	28	29	30	31
MsgHeader (24 bytes)																															
...																															
...																															
isoLevel																															
isoFlags																															

MsgHeader (24 bytes): This field MUST contain a MESSAGE_PACKET structure.

- The **dwUserMsgType** field MUST be 0x00006106.
- The **dwcbVarLenData** field MUST be 8.

isoLevel (4 bytes): See the **isoLevel** field in section 2.2.8.1.1.2 for details.

isoFlags (4 bytes): See the **isoFlags** field in section 2.2.8.1.1.2 for details.

2.2.8.3 Transaction Administration

2.2.8.3.1 CONNTYPE_TXUSER_GETTXDETAILS

This connection type is used by an application to retrieve details about a transaction from its transaction manager.

For more information about CONNTYPE_TXUSER_GETTXDETAILS as an initiator, see section 3.3.5.3.1, and as an acceptor, see section 3.4.5.3.1.

2.2.8.3.1.1 TXUSER_GETTXDETAILS_MTAG_GET

This message is used to request details about a transaction from the transaction manager.

0	1	2	3	4	5	6	7	8	9	10	11	12	13	14	15	16	17	18	19	20	21	22	23	24	25	26	27	28	29	30	31
MsgHeader (24 bytes)																															
...																															
...																															
guidTx (16 bytes)																															
...																															
...																															

MsgHeader (24 bytes): This field MUST contain a MESSAGE_PACKET structure.

- The **dwUserMsgType** field MUST be 0x00004701.
- The **dwcbVarLenData** field MUST be 16.

guidTx (16 bytes): This field MUST contain a GUID that specifies the transaction identifier.

2.2.8.3.1.2 TXUSER_GETTXDETAILS_MTAG_GOTIT

This message provides the client with name and identifier details for the transaction superior and all enlisted subordinates.

0	1	2	3	4	5	6	7	8	9	10	11	12	13	14	15	16	17	18	19	20	21	22	23	24	25	26	27	28	29	30	31
MsgHeader (24 bytes)																															
...																															
...																															
ISubordinateCount																															
Reserved																															
vszSuperiorName (variable)																															
...																															
vszSuperiorID (variable)																															

...
rgSubordinates (variable)
...

MsgHeader (24 bytes): This field MUST contain a MESSAGE_PACKET structure.

- The **dwUserMsgType** field MUST be 0x00004702.
- The **dwcbVarLenData** field MUST be at least 16 bytes.

ISubordinateCount (4 bytes): This field MUST contain the number of subordinates in the **rgSubordinates** array that follows.

Reserved (4 bytes): Reserved. This value MUST be set to zero and MUST be ignored on receipt.

vszSuperiorName (variable): This field MUST contain an OLETX_VARLEN_STRING structure. The structure specifies an implementation-specific name for the **Name** property of the **Superior Enlistment** object (see section 3.2.1) that is maintained by the Core Transaction Manager Facet (section 1.3.3.3.1). The Core Transaction Manager Facet is initialized as specified in Initialization (section 3.2.3).

If the transaction manager is the root transaction manager for the transaction, the value MUST be a zero-length OLETX_VARLEN_STRING. If the transaction manager is not acting as the root transaction manager for the transaction, the value MUST NOT be a zero-length OLETX_VARLEN_STRING. This field MUST be aligned on a 4-byte boundary by padding with arbitrary values that MUST be ignored on receipt.

vszSuperiorID (variable): This field contains an OLETX_VARLEN_STRING structure. The structure MUST contain an implementation-specific identifier that corresponds to the **Enlistment Object.Identifier** property of the **Superior Enlistment** object (see section 3.2.1) that is maintained by the Core Transaction Manager Facet (section 1.3.3.3.1) as described for Enlistment objects (see section 3.1.1). The Core Transaction Manager Facet is initialized as specified in Initialization. If the transaction manager is the root transaction manager for the transaction, the value MUST be a zero-length OLETX_VARLEN_STRING. This field MUST be aligned on a 4-byte boundary by padding with arbitrary values that MUST be ignored on receipt.

rgSubordinates (variable): An array of OLETX_VARLEN_STRING structure pairs. Each pair MUST specify an implementation-specific name, followed by an implementation-specific identifier. The array MUST contain **ISubordinateCount** pairs of OLETX_VARLEN_STRING structures, representing the collection of subordinates enlisted on the transaction. If **ISubordinateCount** contains zero, this field MUST NOT be present.

This field MUST be aligned on a 4-byte boundary by padding with arbitrary values that MUST be ignored on receipt. The name and identifier correspond to the **Name** and **Enlistment Object.Identifier** properties (see section 3.1.1) respectively, of the Phase One Enlistment list that is maintained by the core transaction manager facet (see section 3.2.1) and initialized as specified in Enlistment Object Initialization (section 3.1.3.1).

2.2.8.3.1.3 TXUSER_GETTXDETAILS_MTAG_TX_NOT_FOUND

This message is sent to indicate that the transaction details cannot be found.

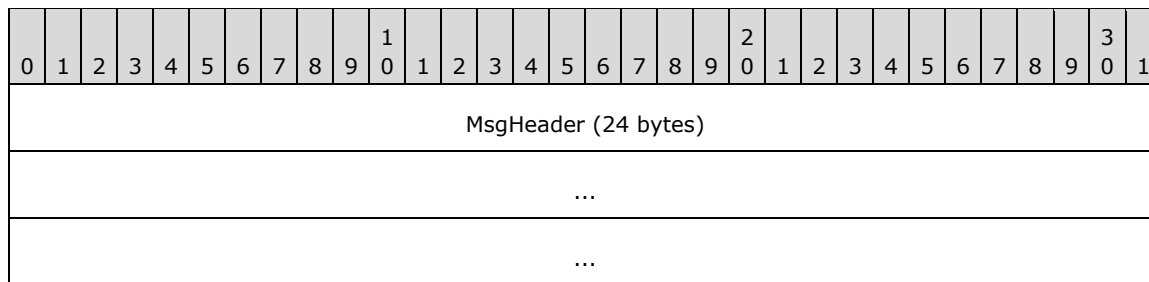

MsgHeader (24 bytes): This field MUST contain a MESSAGE_PACKET structure.

- The **dwUserMsgType** field MUST be 0x00004703.
- The **dwcbVarLenData** field MUST be 0.

2.2.8.3.2 CONNTYPE_TXUSER_RESOLVE

This connection type is used by an application either to manually resolve the outcome of an In Doubt transaction or cause its transaction manager to forget a transaction that is in the Failed to Notify state.

For more information about CONNTYPE_TXUSER_RESOLVE as an initiator, see section 3.3.5.3.2, and as an acceptor, see section 3.4.5.3.2.

2.2.8.3.2.1 TXUSER_RESOLVE_MTAG_ACCESSDENIED

This message indicates that the principal that sent the previous TXUSER_RESOLVE_MTAG_CHILD_ABORT, TXUSER_RESOLVE_MTAG_CHILD_COMMIT, or TXUSER_RESOLVE_MTAG_FORGET_COMMITTED is not authorized to perform the requested action.<19>

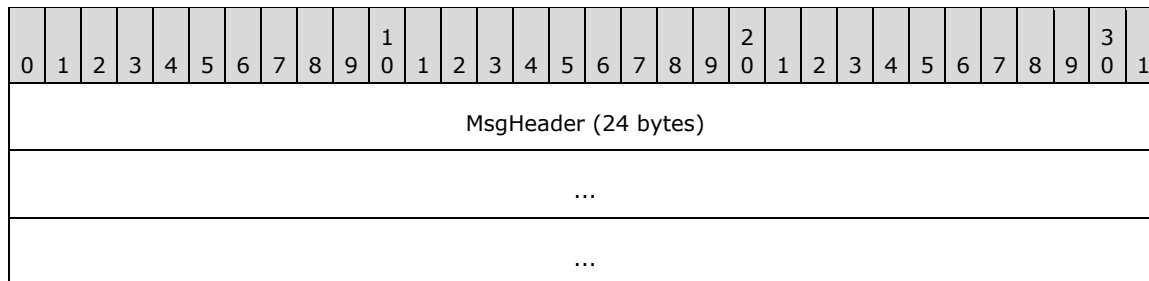

MsgHeader (24 bytes): This field MUST contain a MESSAGE_PACKET structure.

- The **dwUserMsgType** field MUST be 0x0000107F.
- The **dwcbVarLenData** field MUST be 0x00000000.

2.2.8.3.2.2 TXUSER_RESOLVE_MTAG_CHILD_ABORT

This message is sent by the application to manually resolve the outcome of an in-doubt transaction as aborted.

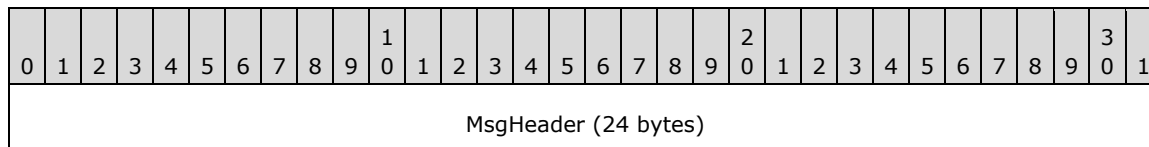

...
...
guidTx (16 bytes)
...
...

MsgHeader (24 bytes): This field MUST contain a MESSAGE_PACKET structure.

- The **dwUserMsgType** field MUST be 0x00001071.
- The **dwcbVarLenData** field MUST be 16.

guidTx (16 bytes): This field MUST contain a GUID that specifies the transaction identifier.

2.2.8.3.2.3 TXUSER_RESOLVE_MTAG_CHILD_COMMIT

This message is sent by an application to manually resolve an in-doubt transaction as committed.

0	1	2	3	4	5	6	7	8	9	10	11	12	13	14	15	16	17	18	19	20	21	22	23	24	25	26	27	28	29	30	31
MsgHeader (24 bytes)																															
...																															
...																															
guidTx (16 bytes)																															
...																															
...																															

MsgHeader (24 bytes): This field MUST contain a MESSAGE_PACKET structure.

- The **dwUserMsgType** field MUST be 0x00001072.
- The **dwcbVarLenData** field MUST be 16.

guidTx (16 bytes): This field MUST contain a GUID that specifies the transaction identifier.

2.2.8.3.2.4 TXUSER_RESOLVE_MTAG_CHILD_NOT_PREPARED

This message indicates that the specified transaction is not in the In Doubt state.

0	1	2	3	4	5	6	7	8	9	10	11	12	13	14	15	16	17	18	19	20	21	22	23	24	25	26	27	28	29	30	31
MsgHeader (24 bytes)																															

...
...

MsgHeader (24 bytes): This field MUST contain a MESSAGE_PACKET structure.

- The **dwUserMsgType** field MUST be 0x00001077.
- The **dwcbVarLenData** field MUST be 0.

2.2.8.3.2.5 TXUSER_RESOLVE_MTAG_FORGET_COMMITTED

This message is sent by an application to request that the transaction manager issue a Forget Transaction event for a transaction that is in the Failed to Notify state.

0	1	2	3	4	5	6	7	8	9	10	11	12	13	14	15	16	17	18	19	20	21	22	23	24	25	26	27	28	29	30	31
MsgHeader (24 bytes)																															
...																															
...																															
guidTx (16 bytes)																															
...																															
...																															

MsgHeader (24 bytes): This field MUST contain a MESSAGE_PACKET structure.

- The **dwUserMsgType** field MUST be 0x00001073.
- The **dwcbVarLenData** field MUST be 16.

guidTx (16 bytes): This field MUST contain a GUID that specifies the transaction identifier.

2.2.8.3.2.6 TXUSER_RESOLVE_MTAG_FORGET_TX_NOT_COMMITTED

This message indicates that the specified transaction is not in the Failed to Notify state.

0	1	2	3	4	5	6	7	8	9	10	11	12	13	14	15	16	17	18	19	20	21	22	23	24	25	26	27	28	29	30	31
MsgHeader (24 bytes)																															
...																															
...																															

MsgHeader (24 bytes): This field MUST contain a MESSAGE_PACKET structure.

- The **dwUserMsgType** field MUST be 0x00001078.

- The **dwcbVarLenData** field MUST be 0.

2.2.8.3.2.7 TXUSER_RESOLVE_MTAG_REQUEST_COMPLETE

This message is sent by the transaction manager to indicate that the request completed successfully.

0	1	2	3	4	5	6	7	8	9	0	1	2	3	4	5	6	7	8	9	0	1	2	3	4	5	6	7	8	9	0	1
MsgHeader (24 bytes)																															
...																															
...																															

MsgHeader (24 bytes): This field MUST contain a MESSAGE_PACKET structure.

- The **dwUserMsgType** field MUST be 0x00001074.
- The **dwcbVarLenData** field MUST be 0.

2.2.8.3.2.8 TXUSER_RESOLVE_MTAG_NOT_CHILD

This message indicates that the transaction manager is not a subordinate for the specified transaction.<20>

0	1	2	3	4	5	6	7	8	9	0	1	2	3	4	5	6	7	8	9	0	1	2	3	4	5	6	7	8	9	0	1
MsgHeader (24 bytes)																															
...																															
...																															

MsgHeader (24 bytes): This field MUST contain a MESSAGE_PACKET structure.

- The **dwUserMsgType** field MUST be 0x00001076.
- The **dwcbVarLenData** field MUST be 0.

2.2.8.3.2.9 TXUSER_RESOLVE_MTAG_TX_NOT_FOUND

This message is sent by the transaction manager to indicate that the specified transaction does not exist.

0	1	2	3	4	5	6	7	8	9	0	1	2	3	4	5	6	7	8	9	0	1	2	3	4	5	6	7	8	9	0	1
MsgHeader (24 bytes)																															
...																															
...																															

MsgHeader (24 bytes): This field MUST contain a MESSAGE_PACKET structure.

- The **dwUserMsgType** field MUST be 0x00001075.
- The **dwcbVarLenData** field MUST be 0.

2.2.8.3.3 CONNTYPE_TXUSER_SETTXTIMEOUT

This connection type is used by an application to modify the time-out of a transaction that has been initiated on a CONNTYPE_TXUSER_BEGINNER connection.

For more information about CONNTYPE_TXUSER_SETTXTIMEOUT as an initiator, see section 3.3.5.3.3, and as an acceptor, see section 3.4.5.3.3.

This connection type also uses the TXUSER_SETTXTIMEOUT_MTAG_REQUEST_COMPLETE (as specified in section 2.2.8.1.2.6), TXUSER_SETTXTIMEOUT_MTAG_SETTXTIMEOUT (as specified in section 2.2.8.1.2.7), and TXUSER_SETTXTIMEOUT_MTAG_TOO_LATE (as specified in section 2.2.8.1.2.8) messages.

2.2.8.3.3.1 TXUSER_SETTXTIMEOUT_MTAG_TX_NOT_FOUND

This message is optionally sent by the transaction manager as part of the CONNTYPE_TXUSER_SETTXTIMEOUT (section 2.2.8.3.3) connection type to indicate that the specified transaction does not exist. This message is optionally also sent by the transaction manager as part of the CONNTYPE_TXUSER_SETTXTIMEOUT2 (section 2.2.8.3.4) connection type to indicate that the transaction manager supports the capability to modify the time-out of a transaction. For more information, see CONNTYPE_TXUSER_SETTXTIMEOUT2.

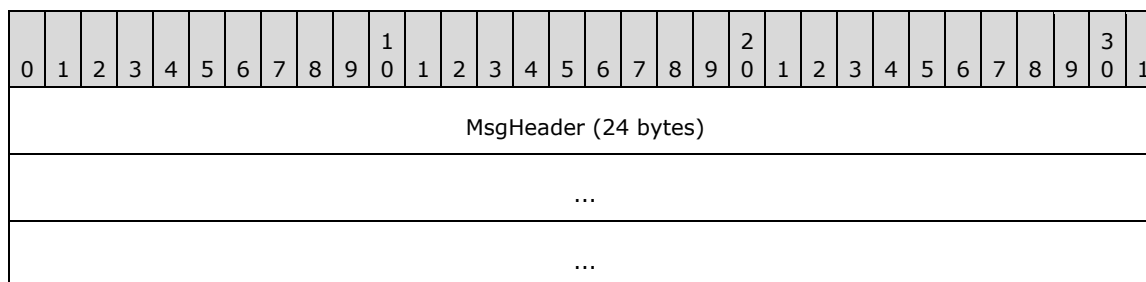

MsgHeader (24 bytes): This field MUST contain a MESSAGE_PACKET structure.

- The **dwUserMsgType** field MUST be 0x0000107D.
- The **dwcbVarLenData** field MUST be 0.

2.2.8.3.4 CONNTYPE_TXUSER_SETTXTIMEOUT2

This connection type is used by an application to query the transaction manager's support for modifying the time-out of a transaction that has been initiated on a CONNTYPE_TXUSER_BEGIN2 or CONNTYPE_TXUSER_PROMOTE connection.

For more information about CONNTYPE_TXUSER_SETTXTIMEOUT2 as an initiator, see section 3.3.5.3.4, and as an acceptor, see section 3.4.5.3.4.

This connection type also uses the TXUSER_SETTXTIMEOUT_MTAG_SETTXTIMEOUT (see section 2.2.8.1.2.7 and TXUSER_SETTXTIMEOUT_MTAG_TX_NOT_FOUND (see section 2.2.8.3.3.1) messages.

2.2.8.3.5 CONNTYPE_TXUSER_TRACE

This connection type is used by an application to ask its transaction manager to trace the status of a transaction by using an implementation-specific mechanism.

For more information about CONNTYPE_TXUSER_TRACE as an initiator, see section 3.3.5.3.5, and as an acceptor, see section 3.4.5.3.5.

2.2.8.3.5.1 TXUSER_TRACE_MTAG_DUMP_TRANSACTION

This message requests that the transaction manager write the status of a transaction to a local trace file in an implementation-specific manner.

0	1	2	3	4	5	6	7	8	9	10	11	12	13	14	15	16	17	18	19	20	21	22	23	24	25	26	27	28	29	30	31
MsgHeader (24 bytes)																															
...																															
...																															
guidTx (16 bytes)																															
...																															
...																															

MsgHeader (24 bytes): This field MUST contain a MESSAGE_PACKET structure.

- The **dwUserMsgType** field MUST be 0x00002100.
- The **dwcbVarLenData** field MUST be 16.

guidTx (16 bytes): This field MUST contain a GUID that specifies the transaction identifier.

2.2.8.3.5.2 TXUSER_TRACE_MTAG_REQUEST_COMPLETE

This message indicates the transaction was successfully traced.

0	1	2	3	4	5	6	7	8	9	10	11	12	13	14	15	16	17	18	19	20	21	22	23	24	25	26	27	28	29	30	31
MsgHeader (24 bytes)																															
...																															
...																															

MsgHeader (24 bytes): This field MUST contain a MESSAGE_PACKET structure.

- The **dwUserMsgType** field MUST be 0x00002101.
- The **dwcbVarLenData** field MUST be 0.

2.2.8.3.5.3 TXUSER_TRACE_MTAG_REQUEST_FAILED

This message indicates that the trace request failed.

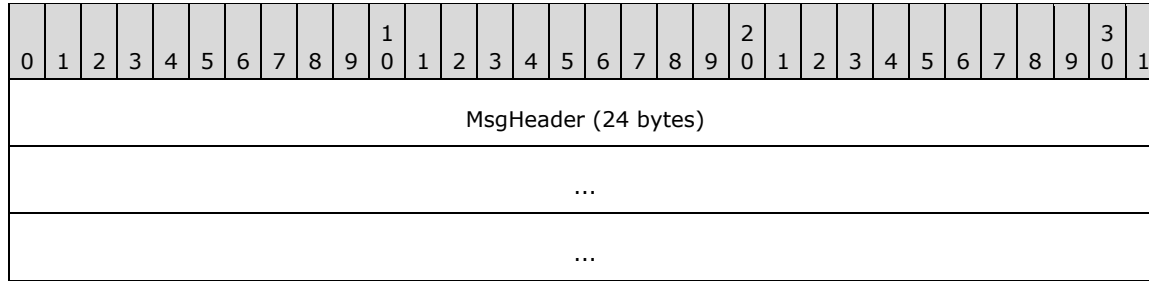

MsgHeader (24 bytes): This field MUST contain a MESSAGE_PACKET structure.

- The **dwUserMsgType** field MUST be 0x00002103.
- The **dwcbVarLenData** field MUST be 0.

2.2.8.3.5.4 TXUSER_TRACE_MTAG_TX_NOT_FOUND

This message is sent by the transaction manager to indicate that the trace request failed because the transaction does not exist.

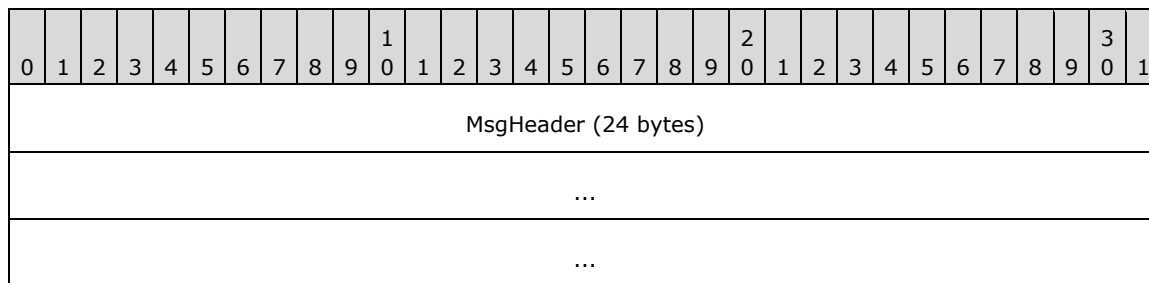

MsgHeader (24 bytes): This field MUST contain a MESSAGE_PACKET structure.

- The **dwUserMsgType** field MUST be 0x00002102.
- The **dwcbVarLenData** field MUST be 0.

2.2.8.4 Transaction Manager Administration

2.2.8.4.1 CONNTYPE_TXUSER_GETSECURITYFLAGS

This connection type is used by an application to obtain the security configuration of its transaction manager.

For more information about CONNTYPE_TXUSER_GETSECURITYFLAGS as an initiator, see section 3.3.5.4.1, and as an acceptor, see section 3.4.5.3.5.

2.2.8.4.1.1 TXUSER_GETSECURITYFLAGS_MTAG_FETCHED

This message indicates that the request to obtain security configuration flags was successful.

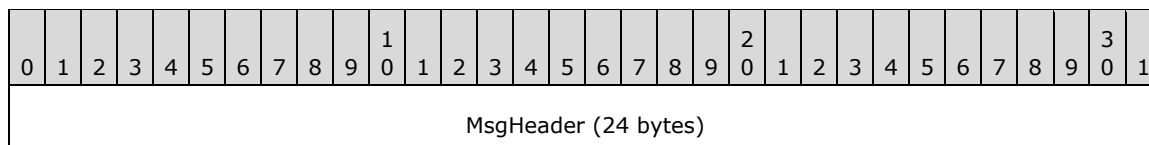

...
...
grfNetworkDtcAccess
grfXaTransactions
grfOptions

MsgHeader (24 bytes): This field MUST contain a MESSAGE_PACKET structure.

- The **dwUserMsgType** field MUST be 0x00005502.
- The **dwcbVarLenData** field MUST be 12.

grfNetworkDtcAccess (4 bytes): This field contains a DTCADVCONFIG bitfield enumeration. See DTCADVCONFIG for details.

grfXaTransactions (4 bytes): This field indicates whether the transaction manager supports the local use of the XA standard API in an implementation-specific manner as specified in Receiving a TXUSER_GETSECURITYFLAGS_MTAG_GETSECURITYFLAGS Message (section 3.4.5.4.1.1). For more information about XA, see [C193]. The field SHOULD have a value of zero if the use of the XA standard API is not supported, or it SHOULD have a value of one if the use of the XA standard API is supported.

grfOptions (4 bytes): This field contains a DTCADVCONFIG_OPTIONS bitfield enumeration. See section 2.2.7.3 for details.

2.2.8.4.1.2 TXUSER_GETSECURITYFLAGS_MTAG_GETSECURITYFLAGS

This message is used by an application to obtain the configuration flags that are associated with the security settings of a transaction manager.

0	1	2	3	4	5	6	7	8	9	10	11	12	13	14	15	16	17	18	19	20	21	22	23	24	25	26	27	28	29	30	31
MsgHeader (24 bytes)																											

MsgHeader (24 bytes): This field MUST contain a MESSAGE_PACKET structure.

- The **dwUserMsgType** field MUST be 0x00005501.
- The **dwcbVarLenData** field MUST be 0.

2.2.9 Connection Types Relevant to Transaction Managers

2.2.9.1 Transaction Propagation and Coordination

2.2.9.1.1 Push Propagation

2.2.9.1.1.1 CONNTYPE_PARTNERTM_PROPAGATE

This connection type is used by a superior transaction manager to do a push propagation of a transaction to its subordinate transaction manager and to execute the Two-Phase Commit protocol.

For more information about CONNTYPE_PARTNERTM_PROPAGATE as Initiator, see section 3.7.5.1.1.1, and as an acceptor, see section CONNTYPE_PARTNERTM_PROPAGATE as Acceptor (section 3.8.5.1.1.1).

2.2.9.1.1.1.1 PARTNERTM_PROPAGATE_MTAG_PROPAGATE

This message is used to propagate a transaction to a subordinate transaction manager.

0	1	2	3	4	5	6	7	8	9	10	11	12	13	14	15	16	17	18	19	20	21	22	23	24	25	26	27	28	29	30	31
MsgHeader (24 bytes)																															
...																															
...																															
guidTX (16 bytes)																															
...																															
...																															
isoLevel																															
szDesc (40 bytes)																															
...																															
...																															

MsgHeader (24 bytes): This field MUST contain a MESSAGE_PACKET structure.

- The **dwUserMsgType** field MUST be 0x00002001.
- The **dwcbVarLenData** field MUST be 60.

guidTX (16 bytes): This field MUST contain a GUID that specifies the transaction identifier.

isoLevel (4 bytes): See the **isoLevel** field in section 2.2.8.1.1.2 for details.

szDesc (40 bytes): See the **szDesc** field in section 2.2.8.1.1.2 for details.

2.2.9.1.1.1.2 PARTNERTM_PROPAGATE_MTAG_PROPAGATED

This message indicates that the transaction was successfully propagated to the subordinate transaction manager.

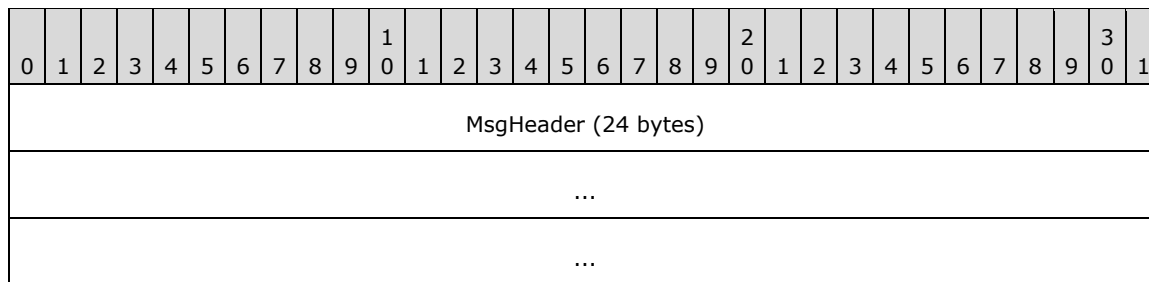

MsgHeader (24 bytes): This field MUST contain a MESSAGE_PACKET structure.

- The **dwUserMsgType** field MUST be 0x00002002.
- The **dwcbVarLenData** field MUST be 0.

2.2.9.1.1.1.3 PARTNERTM_PROPAGATE_MTAG_DUPLICATE

This message indicates that the transaction was already propagated to the subordinate transaction manager.

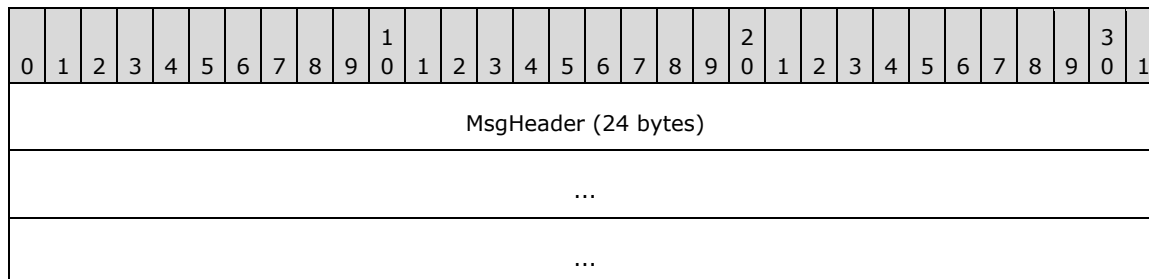

MsgHeader (24 bytes): This field MUST contain a MESSAGE_PACKET structure.

- The **dwUserMsgType** field MUST be 0x00002010.
- The **dwcbVarLenData** field MUST be 0.

2.2.9.1.1.1.4 PARTNERTM_PROPAGATE_MTAG_NO_MEM

This message indicates that transaction propagation failed because the subordinate transaction manager was out of memory.

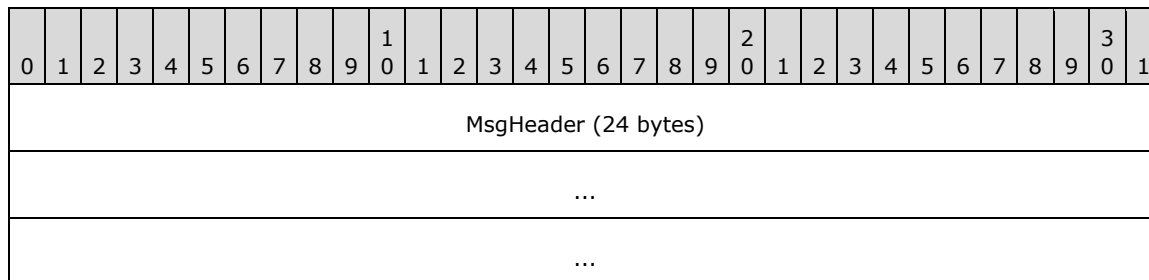

MsgHeader (24 bytes): This field MUST contain a MESSAGE_PACKET structure.

- The **dwUserMsgType** field MUST be 0x00002901.
- The **dwcbVarLenData** field MUST be 0.

2.2.9.1.1.1.5 PARTNERTM_PROPAGATE_MTAG_LOG_FULL

This message indicates that transaction propagation failed because the transaction recovery log of the subordinate transaction manager is full.

0	1	2	3	4	5	6	7	8	9	10	11	12	13	14	15	16	17	18	19	20	21	22	23	24	25	26	27	28	29	30	31
MsgHeader (24 bytes)																															
...																															
...																															

MsgHeader (24 bytes): This field MUST contain a MESSAGE_PACKET structure.

- The **dwUserMsgType** field MUST be 0x00002902.
- The **dwcbVarLenData** field MUST be 0.

2.2.9.1.1.1.6 PARTNERTM_PROPAGATE_MTAG_PREPAREREQ

This message is used to request that the subordinate transaction manager perform the actions that are needed to prepare the transaction to be committed.

This message is also used for CONNTYPE_PARTNERTM_BRANCH.

0	1	2	3	4	5	6	7	8	9	10	11	12	13	14	15	16	17	18	19	20	21	22	23	24	25	26	27	28	29	30	31
MsgHeader (24 bytes)																															
...																															
...																															
grfRM																															
fSinglePhase																															

MsgHeader (24 bytes): This field MUST contain a MESSAGE_PACKET structure.

- The **dwUserMsgType** field MUST be 0x00002003.
- The **dwcbVarLenData** field MUST be 8.

grfRM (4 bytes): The value of this field MUST be a 32-bit unsigned integer. This value SHOULD be ignored on receipt.

fSinglePhase (4 bytes): Indicates whether the sending transaction manager will allow the single-phase commit optimization. If the value is zero, the receiver of the message MUST NOT perform a single-phase commit for its superior transaction manager. If the value is nonzero, the receiver SHOULD perform a single-phase commit for its superior transaction manager.

2.2.9.1.1.1.7 PARTNERTM_PROPAGATE_MTAG_PREPAREREQDONE

This message indicates that the subordinate transaction manager has processed the Prepare request from the superior transaction manager.

0	1	2	3	4	5	6	7	8	9	10	11	12	13	14	15	16	17	18	19	20	21	22	23	24	25	26	27	28	29	30	31
MsgHeader (24 bytes)																															
...																															
...																															
prepareReqDone																															
guidReason (16 bytes)																															
...																															
...																															

MsgHeader (24 bytes): This field MUST contain a MESSAGE_PACKET structure.

- The **dwUserMsgType** field MUST be 0x00002006.
- The **dwcbVarLenData** field MUST be 20.

prepareReqDone (4 bytes): Indicates the status of the Prepare request as specified in the PARTNERTM_PROPAGATE_PREPAREREQDONE_RESPONSE (section 2.2.6.4) enumeration.

guidReason (16 bytes): Reserved. This value SHOULD be set to a NULL GUID and MUST be ignored on receipt.

2.2.9.1.1.1.8 PARTNERTM_PROPAGATE_MTAG_PROTOCOL_ERROR

This message indicates that the sender detected a violation of the Two-Phase Commit protocol and is unable to perform the previous request it received over the connection.

0	1	2	3	4	5	6	7	8	9	10	11	12	13	14	15	16	17	18	19	20	21	22	23	24	25	26	27	28	29	30	31
MsgHeader (24 bytes)																															
...																															
...																															

MsgHeader (24 bytes): This field MUST contain a MESSAGE_PACKET structure.

- The **dwUserMsgType** field MUST be 0x00002009.
- The **dwcbVarLenData** field MUST be 0.

2.2.9.1.1.1.9 PARTNERTM_PROPAGATE_MTAG_COMMITREQ

This message is sent by the superior transaction manager to request that the transaction be committed.

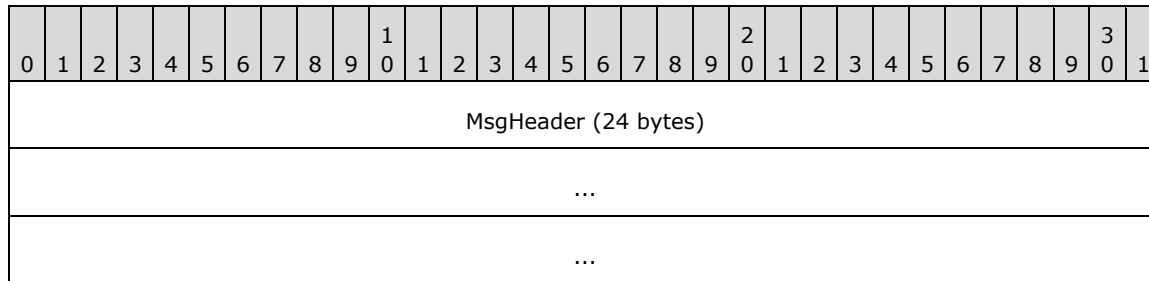

MsgHeader (24 bytes): This field MUST contain a MESSAGE_PACKET structure.

- The **dwUserMsgType** field MUST be 0x00002005.
- The **dwcbVarLenData** field MUST be 0.

2.2.9.1.1.1.10 PARTNERTM_PROPAGATE_MTAG_COMMITREQDONE

This message indicates that the transaction was successfully committed by the subordinate transaction manager.

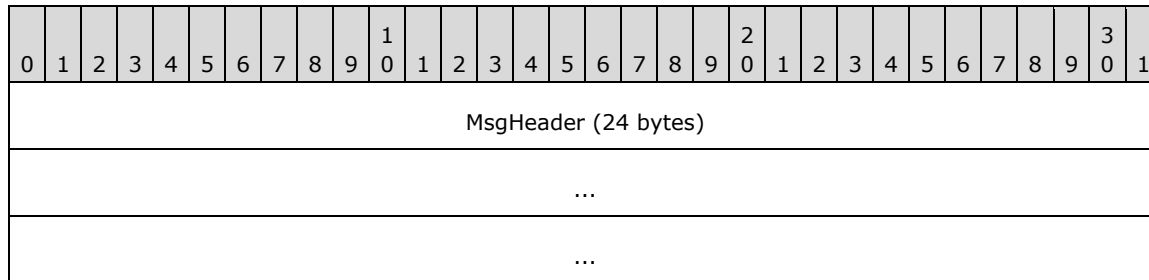

MsgHeader (24 bytes): This field MUST contain a MESSAGE_PACKET structure.

- The **dwUserMsgType** field MUST be 0x00002008.
- The **dwcbVarLenData** field MUST be 0.

2.2.9.1.1.1.11 PARTNERTM_PROPAGATE_MTAG_ABORTREQ

This message is sent by the superior transaction manager to request that the transaction be aborted.

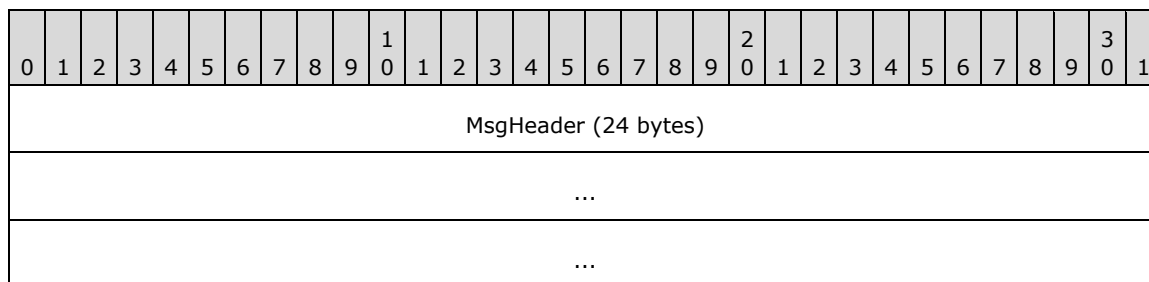

MsgHeader (24 bytes): This field MUST contain a MESSAGE_PACKET structure.

- The **dwUserMsgType** field MUST be 0x00002004.

- The **dwcbVarLenData** field MUST be 0.

2.2.9.1.1.1.12 PARTNERTM_PROPAGATE_MTAG_ABORTREQDONE

This message is sent by the subordinate transaction manager to indicate that the transaction was successfully aborted.

0	1	2	3	4	5	6	7	8	9	0	1	2	3	4	5	6	7	8	9	0	1	2	3	4	5	6	7	8	9	0	1
MsgHeader (24 bytes)																															
...																															
...																															

MsgHeader (24 bytes): This field MUST contain a MESSAGE_PACKET structure.

- The **dwUserMsgType** field MUST be 0x00002007.
- The **dwcbVarLenData** field MUST be 0.

2.2.9.1.1.1.13 PARTNERTM_PROPAGATE_MTAG_ABORTNOTIFY

This message is sent to abort a transaction before the PARTNERTM_PROPAGATE_MTAG_PREPAREREQ (section 2.2.9.1.1.1.6) message is received.

0	1	2	3	4	5	6	7	8	9	0	1	2	3	4	5	6	7	8	9	0	1	2	3	4	5	6	7	8	9	0	1
MsgHeader (24 bytes)																															
...																															
...																															

MsgHeader (24 bytes): This field MUST contain a MESSAGE_PACKET structure.

- The **dwUserMsgType** field MUST be 0x00002903.
- The **dwcbVarLenData** field MUST be 0.

2.2.9.1.1.1.14 PARTNERTM_PROPAGATE_MTAG_PHASE0REGISTER

This message is sent by the subordinate transaction manager to register for a Phase Zero notification.

0	1	2	3	4	5	6	7	8	9	0	1	2	3	4	5	6	7	8	9	0	1	2	3	4	5	6	7	8	9	0	1
MsgHeader (24 bytes)																															
...																															
...																															

MsgHeader (24 bytes): This field MUST contain a MESSAGE_PACKET structure.

- The **dwUserMsgType** field MUST be 0x00002906.
- The **dwcbVarLenData** field MUST be 0.

2.2.9.1.1.1.15 PARTNERTM_PROPAGATE_MTAG_PHASE0REGISTERED

This message is sent by the superior transaction manager to indicate that the subordinate transaction manager was successfully registered for Phase Zero notifications.

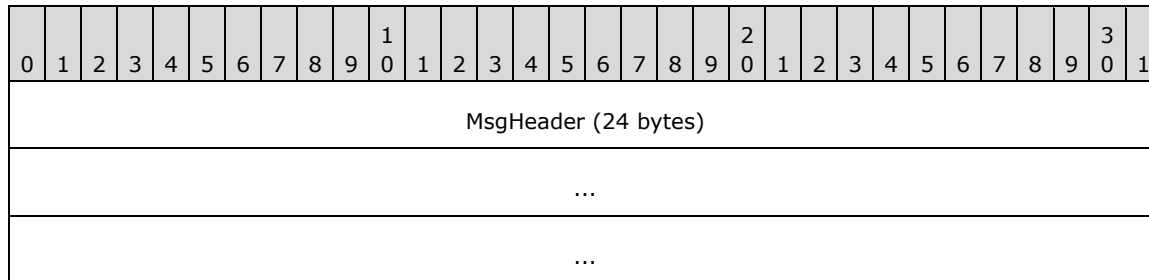

MsgHeader (24 bytes): This field MUST contain a MESSAGE_PACKET structure.

- The **dwUserMsgType** field MUST be 0x00002907.
- The **dwcbVarLenData** field MUST be 0.

2.2.9.1.1.1.16 PARTNERTM_PROPAGATE_MTAG_PHASE0REGISTRATIONREJECTED

This message is sent by the superior transaction manager to indicate that it was unable to register the subordinate transaction manager for Phase Zero notifications.

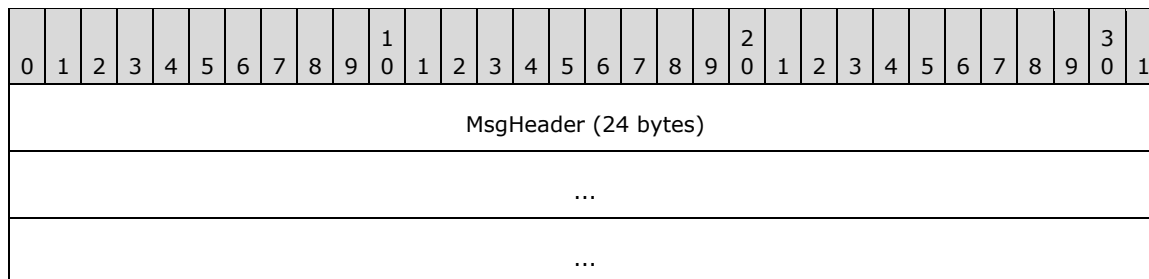

MsgHeader (24 bytes): This field MUST contain a MESSAGE_PACKET structure.

- The **dwUserMsgType** field MUST be 0x00002910.
- The **dwcbVarLenData** field MUST be 0.

2.2.9.1.1.1.17 PARTNERTM_PROPAGATE_MTAG_PHASE0

This message is sent by the superior transaction manager to request that the subordinate transaction manager begin Phase Zero.

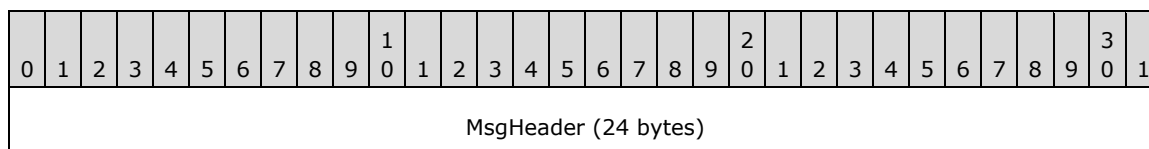

...
...

MsgHeader (24 bytes): This field MUST contain a MESSAGE_PACKET structure.

- The **dwUserMsgType** field MUST be 0x00002908.
- The **dwcbVarLenData** field MUST be 0.

2.2.9.1.1.1.18 PARTNERTM_PROPAGATE_MTAG_PHASE0COMPLETE

This message indicates that the subordinate transaction manager successfully completed Phase Zero.

0	1	2	3	4	5	6	7	8	9	10	11	12	13	14	15	16	17	18	19	20	21	22	23	24	25	26	27	28	29	30	31
MsgHeader (24 bytes)																															
...																															
...																															

MsgHeader (24 bytes): This field MUST contain a MESSAGE_PACKET structure.

- The **dwUserMsgType** field MUST be 0x00002909.
- The **dwcbVarLenData** field MUST be 0.

2.2.9.1.2 Pull Propagation

2.2.9.1.2.1 CONNTYPE_PARTNERTM_BRANCH

A subordinate transaction manager uses this connection type to register a new subordinate enlistment with a superior transaction manager. The two transaction managers also use this connection type to execute the Two-Phase Commit protocol. This connection type is initiated as a result of a TXUSER_ASSOCIATE_MTAG_ASSOCIATE message that is sent by an application to the subordinate transaction manager to request a pull propagation operation.

For more information about CONNTYPE_PARTNERTM_BRANCH as an initiator, see section 3.8.5.1.2.1, and as an acceptor, see section 3.7.5.1.2.1.

This connection type also uses PARTNERTM_PROPAGATE_MTAG_PREPAREREQ, PARTNERTM_PROPAGATE_MTAG_PREPAREREQDONE, PARTNERTM_PROPAGATE_MTAG_COMMITREQ, PARTNERTM_PROPAGATE_MTAG_COMMITREQDONE, PARTNERTM_PROPAGATE_MTAG_ABORTREQ, PARTNERTM_PROPAGATE_MTAG_ABORTREQDONE, PARTNERTM_PROPAGATE_MTAG_ABORTNOTIFY, PARTNERTM_PROPAGATE_MTAG_PHASE0REGISTER, PARTNERTM_PROPAGATE_MTAG_PHASE0REGISTERED, PARTNERTM_PROPAGATE_MTAG_PHASE0REGISTRATIONREJECTED, PARTNERTM_PROPAGATE_MTAG_PHASE0, and PARTNERTM_PROPAGATE_MTAG_PHASE0COMPLETE messages.

2.2.9.1.2.1.1 PARTNERTM_BRANCH_MTAG_BRANCH_LOG_FULL

This message indicates that the branch request failed because the transaction recovery log of the superior transaction manager is full.

0	1	2	3	4	5	6	7	8	9	1	0	1	2	3	4	5	6	7	8	9	2	0	1	2	3	4	5	6	7	8	9	3	0	1
MsgHeader (24 bytes)																																		
...																																		
...																																		

MsgHeader (24 bytes): This field MUST contain a MESSAGE_PACKET structure.

- The **dwUserMsgType** field MUST be 0x00002056.
- The **dwcbVarLenData** field MUST be 0.

2.2.9.1.2.1.2 PARTNERTM_BRANCH_MTAG_BRANCH_NO_MEM

This message indicates that the branch request failed because the superior transaction manager was unable to allocate sufficient memory.

0	1	2	3	4	5	6	7	8	9	1	0	1	2	3	4	5	6	7	8	9	2	0	1	2	3	4	5	6	7	8	9	3	0	1
MsgHeader (24 bytes)																																		
...																																		
...																																		

MsgHeader (24 bytes): This field MUST contain a MESSAGE_PACKET structure.

- The **dwUserMsgType** field MUST be 0x00002057.
- The **dwcbVarLenData** field MUST be 0.

2.2.9.1.2.1.3 PARTNERTM_BRANCH_MTAG_BRANCH_TOO_LATE

This message indicates that the branch request failed because it was too late in the transaction life cycle. For more information, see Create Subordinate Enlistment (section 3.2.7.11) and Create Subordinate Enlistment Failure (section 3.7.7.7).

0	1	2	3	4	5	6	7	8	9	1	0	1	2	3	4	5	6	7	8	9	2	0	1	2	3	4	5	6	7	8	9	3	0	1
MsgHeader (24 bytes)																																		
...																																		
...																																		

MsgHeader (24 bytes): This field MUST contain a MESSAGE_PACKET structure.

- The **dwUserMsgType** field MUST be 0x00002055.
- The **dwcbVarLenData** field MUST be 0.

2.2.9.1.2.1.4 PARTNERTM_BRANCH_MTAG_BRANCH_TOO_MANY

This message indicates that the branch request failed because the superior transaction manager has reached the maximum number of subordinates allowed on a transaction.

0	1	2	3	4	5	6	7	8	9	10	11	12	13	14	15	16	17	18	19	20	21	22	23	24	25	26	27	28	29	30	31
MsgHeader (24 bytes)																															
...																															
...																															

MsgHeader (24 bytes): This field MUST contain a MESSAGE_PACKET structure.

- The **dwUserMsgType** field MUST be 0x00002059.
- The **dwcbVarLenData** field MUST be 0.

2.2.9.1.2.1.5 PARTNERTM_BRANCH_MTAG_BRANCH_TX_NOT_FOUND

This message indicates that the branch request failed because the superior transaction manager was unaware of the transaction.

0	1	2	3	4	5	6	7	8	9	10	11	12	13	14	15	16	17	18	19	20	21	22	23	24	25	26	27	28	29	30	31
MsgHeader (24 bytes)																															
...																															
...																															

MsgHeader (24 bytes): This field MUST contain a MESSAGE_PACKET structure.

- The **dwUserMsgType** field MUST be 0x00002054.
- The **dwcbVarLenData** field MUST be 0.

2.2.9.1.2.1.6 PARTNERTM_BRANCH_MTAG_BRANCHED

This message is sent by the superior transaction manager to indicate that the branch request was successful.

0	1	2	3	4	5	6	7	8	9	10	11	12	13	14	15	16	17	18	19	20	21	22	23	24	25	26	27	28	29	30	31
MsgHeader (24 bytes)																															
...																															
...																															

MsgHeader (24 bytes): This field MUST contain a MESSAGE_PACKET structure.

- The **dwUserMsgType** field MUST be 0x00002052.
- The **dwcbVarLenData** field MUST be 0.

2.2.9.1.2.1.7 PARTNERTM_BRANCH_MTAG_BRANCHING

This message is sent by a subordinate transaction manager to register a new subordinate enlistment with a superior transaction manager.

0	1	2	3	4	5	6	7	8	9	10	11	12	13	14	15	16	17	18	19	20	21	22	23	24	25	26	27	28	29	30	31
MsgHeader (24 bytes)																															
...																															
...																															
guidTX (16 bytes)																															
...																															
...																															

MsgHeader (24 bytes): This field MUST contain a MESSAGE_PACKET structure.

- The **dwUserMsgType** field MUST be 0x00002051.
- The **dwcbVarLenData** field MUST be 16.

guidTX (16 bytes): This field MUST contain a GUID that specifies the transaction identifier.

2.2.9.2 Transaction Recovery

2.2.9.2.1 Subordinate-Driven

2.2.9.2.1.1 CONNTYPE_PARTNERTM_CHECKABORT

This connection type is used by a subordinate transaction manager to query the outcome of a transaction from its superior transaction manager.

For more information about CONNTYPE_PARTNERTM_CHECKABORT as an initiator, see section 3.8.5.2.1.1, and as an acceptor, see section 3.7.5.2.1.1.

2.2.9.2.1.1.1 PARTNERTM_CHECKABORT_MTAG_CHECK

This message is used by a subordinate transaction manager to check if the superior transaction manager aborted a specific transaction.

0	1	2	3	4	5	6	7	8	9	10	11	12	13	14	15	16	17	18	19	20	21	22	23	24	25	26	27	28	29	30	31
MsgHeader (24 bytes)																															
...																															

...
guidTX (16 bytes)
...
...

MsgHeader (24 bytes): This field MUST contain a MESSAGE_PACKET structure.

- The **dwUserMsgType** field MUST be 0x00002021.
- The **dwcbVarLenData** field MUST be 16.

guidTX (16 bytes): This field MUST contain a GUID that specifies the transaction identifier.

2.2.9.2.1.1.2 PARTNERTM_CHECKABORT_MTAG_ABORTED

This message indicates that the transaction was successfully aborted.

0	1	2	3	4	5	6	7	8	9	10	11	12	13	14	15	16	17	18	19	20	21	22	23	24	25	26	27	28	29	30	31
MsgHeader (24 bytes)																															
...																															
...																															

MsgHeader (24 bytes): This field MUST contain a MESSAGE_PACKET structure.

- The **dwUserMsgType** field MUST be 0x00002022.
- The **dwcbVarLenData** field MUST be 0.

2.2.9.2.1.1.3 PARTNERTM_CHECKABORT_MTAG_RETRY

This message indicates the superior transaction manager is unable to declare that the transaction aborted, either because the superior transaction manager has not yet determined the final outcome of the transaction, or because the transaction has already committed.

0	1	2	3	4	5	6	7	8	9	10	11	12	13	14	15	16	17	18	19	20	21	22	23	24	25	26	27	28	29	30	31
MsgHeader (24 bytes)																															
...																															
...																															

MsgHeader (24 bytes): This field MUST contain a MESSAGE_PACKET structure.

- The **dwUserMsgType** field MUST be 0x00002023.

- The **dwcbVarLenData** field MUST be 0.

2.2.9.2.2 Superior-Driven

2.2.9.2.2.1 CONNTYPE_PARTNERTM_REDELIVERCOMMIT

This connection type is used by a superior transaction manager to redeliver a Commit notification for a transaction to its subordinate transaction manager.

For more information about CONNTYPE_PARTNERTM_REDELIVERCOMMIT as an initiator, see section 3.7.5.2.2.1, and as an acceptor, see section 3.8.5.2.2.1.

2.2.9.2.2.1.1 PARTNERTM_REDELIVERCOMMIT_MTAG_COMMITREQ

The superior transaction manager sends this message to begin Phase Two commit processing.

0	1	2	3	4	5	6	7	8	9	10	11	12	13	14	15	16	17	18	19	20	21	22	23	24	25	26	27	28	29	30	31
MsgHeader (24 bytes)																															
...																															
...																															
guidTx (16 bytes)																															
...																															
...																															

MsgHeader (24 bytes): This field MUST contain a MESSAGE_PACKET structure.

- The **dwUserMsgType** field MUST be 0x00002011.
- The **dwcbVarLenData** field MUST be 16.

guidTx (16 bytes): This field MUST contain a GUID that specifies the transaction identifier.

2.2.9.2.2.1.2 PARTNERTM_REDELIVERCOMMIT_MTAG_COMMITREQDONE

This message indicates that the subordinate transaction manager has successfully committed the transaction.

0	1	2	3	4	5	6	7	8	9	10	11	12	13	14	15	16	17	18	19	20	21	22	23	24	25	26	27	28	29	30	31
MsgHeader (24 bytes)																															
...																															
...																															

MsgHeader (24 bytes): This field MUST contain a MESSAGE_PACKET structure.

- The **dwUserMsgType** field MUST be 0x00002012.
- The **dwcbVarLenData** field MUST be 0.

2.2.9.2.2.1.3 PARTNERTM_REDELIVERCOMMIT_MTAG_RETRY

This message is sent by the subordinate transaction manager to indicate that it is in a state in which it is temporarily unable to process the commit request.

0	1	2	3	4	5	6	7	8	9	10	11	12	13	14	15	16	17	18	19	20	21	22	23	24	25	26	27	28	29	30	31
MsgHeader (24 bytes)																															
...																															
...																															

MsgHeader (24 bytes): This field MUST contain a MESSAGE_PACKET structure.

- The **dwUserMsgType** field MUST be 0x00002013.
- The **dwcbVarLenData** field MUST be 0.

2.2.10 Connection Types Relevant to Resource Managers

2.2.10.1 Resource Manager Registration

2.2.10.1.1 CONNTYPE_TXUSER_RESOURCEMANAGER

The CONNTYPE_TXUSER_RESOURCEMANAGER connection type is used by a durable resource manager to register with its transaction manager.

For more details about CONNTYPE_TXUSER_RESOURCEMANAGER as an initiator, see section 3.5.5.1.1, and as an acceptor, see section 3.6.5.1.1.

2.2.10.1.1.1 TXUSER_RESOURCEMANAGER_MTAG_CREATE

The TXUSER_RESOURCEMANAGER_MTAG_CREATE message is used by resource managers to register with a transaction manager.

0	1	2	3	4	5	6	7	8	9	10	11	12	13	14	15	16	17	18	19	20	21	22	23	24	25	26	27	28	29	30	31
MsgHeader (24 bytes)																															
...																															
...																															
guidRM (16 bytes)																															
...																															

...
guidSession (16 bytes)
...
...

MsgHeader (24 bytes): This field MUST contain a MESSAGE_PACKET structure.

- The **dwUserMsgType** field MUST be 0x00001051.
- The **dwcbVarLenData** field MUST be 32.

guidRM (16 bytes): This field MUST contain a GUID that specifies the resource manager identifier.

guidSession (16 bytes): This field MUST contain a GUID that specifies the session identifier of the resource manager.

2.2.10.1.1.2 TXUSER_RESOURCEMANAGER_MTAG_DUPLICATE

The TXUSER_RESOURCEMANAGER_MTAG_DUPLICATE message is sent from the transaction manager when there is already a resource manager that is registered with the same **guidRM** value.

0	1	2	3	4	5	6	7	8	9	10	11	12	13	14	15	16	17	18	19	20	21	22	23	24	25	26	27	28	29	30	31
MsgHeader (24 bytes)																															
...																															
...																															

MsgHeader (24 bytes): This field MUST contain a MESSAGE_PACKET structure.

- The **dwUserMsgType** field MUST be 0x00001054.
- The **dwcbVarLenData** field MUST be 0.

2.2.10.1.1.3 TXUSER_RESOURCEMANAGER_MTAG_REENLISTMENTCOMPLETE

The TXUSER_RESOURCEMANAGER_MTAG_REENLISTMENTCOMPLETE message is used by resource managers to inform the transaction manager that it has no outstanding in-doubt transactions for which the resource manager required an outcome.

This message is used in the following scenarios:

- Recover Transactions (section 3.5.7.2)
- Recover Transaction (section 3.5.7.1)
- Reenlistment Complete (section 3.5.7.3)
- Enlistment Commit Request Completed (section 3.5.4.5)
- Enlistment Abort Request Completed (section 3.5.4.4)

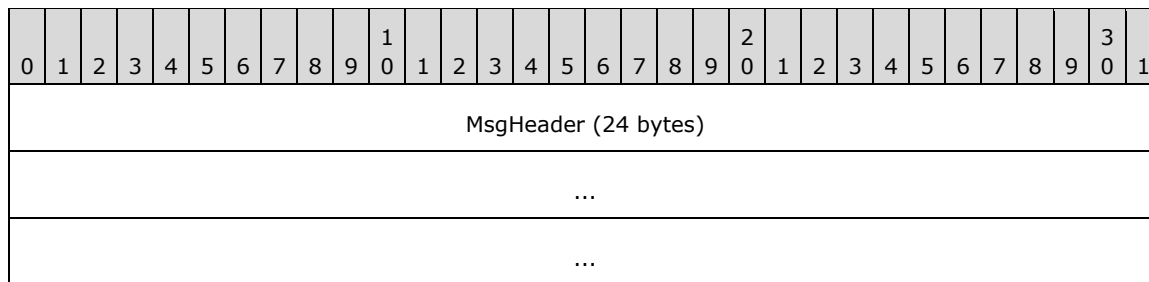

MsgHeader (24 bytes): This field MUST contain a MESSAGE_PACKET structure.

- The **dwUserMsgType** field MUST be 0x00001052.
- The **dwcbVarLenData** field MUST be 0.

2.2.10.1.1.4 TXUSER_RESOURCEMANAGER_MTAG_REQUEST_COMPLETE

The TXUSER_RESOURCEMANAGER_MTAG_REQUEST_COMPLETE message is used by transaction managers to indicate that the previous request that was sent by the resource manager on the connection was successfully completed.

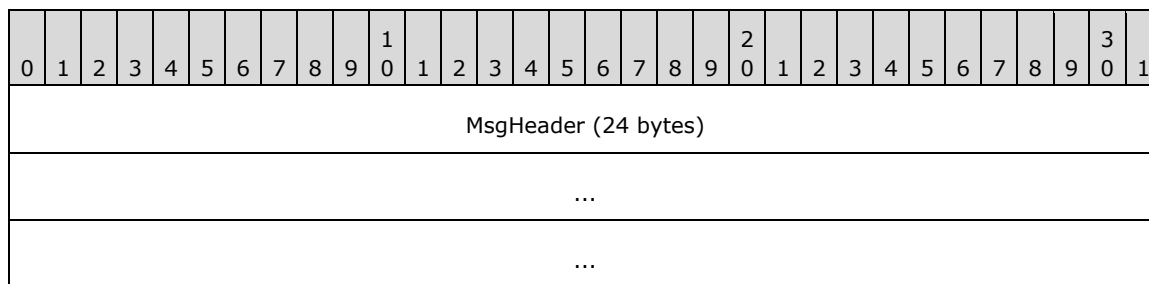

MsgHeader (24 bytes): This field MUST contain a MESSAGE_PACKET structure.

- The **dwUserMsgType** field MUST be 0x00001053.
- The **dwcbVarLenData** field MUST be 0.

2.2.10.1.2 CONNTYPE_TXUSER_RESOURCEMANAGERINTERNAL

This connection type is used by a durable resource manager to register with a transaction manager as well as to detect duplicate registrations. This connection type supersedes CONNTYPE_TXUSER_RESOURCEMANAGER.

This connection type also uses the following messages:

- TXUSER_RESOURCEMANAGER_MTAG_CREATE (section 2.2.10.1.1.1)
- TXUSER_RESOURCEMANAGER_MTAG_DUPLICATE (section 2.2.10.1.1.2)
- TXUSER_RESOURCEMANAGER_MTAG_REENLISTMENTCOMPLETE (section 2.2.10.1.1.3)
- TXUSER_RESOURCEMANAGER_MTAG_REQUEST_COMPLETE (section 2.2.10.1.1.4)

For more information about CONNTYPE_TXUSER_RESOURCEMANAGERINTERNAL as an initiator, see section 3.5.5.1.2, and as an acceptor, see section 3.6.5.1.2.

2.2.10.1.2.1 TXUSER_RESOURCEMANAGERINTERNAL_MTAG_DUPLICATEDETECTED

This message notifies a resource manager that an attempt was made to register another resource manager instance with the unique identifier of this resource manager. See the **guidRM** field in TXUSER_RESOURCEMANAGER_MTAG_CREATE for more information.

0	1	2	3	4	5	6	7	8	9	0	1	2	3	4	5	6	7	8	9	0	1	2	3	4	5	6	7	8	9	0	1
MsgHeader (24 bytes)																															
...																															
...																															

MsgHeader (24 bytes): This field MUST contain a MESSAGE_PACKET structure.

- The **dwUserMsgType** field MUST be 0x00001055.
- The **dwcbVarLenData** field MUST be 0.

2.2.10.2 Transaction Coordination

2.2.10.2.1 CONNTYPE_TXUSER_PHASE0

This CONNTYPE_TXUSER_PHASE0 connection type is used by a resource manager to enlist for Phase Zero notifications from its transaction manager.

The CONNTYPE_TXUSER_PHASE0 connection type is used as either an initiator or as an acceptor:

- For more details about CONNTYPE_TXUSER_PHASE0 as an initiator, see section 3.5.5.2.1.
- For more details about CONNTYPE_TXUSER_PHASE0 as an acceptor, see section 3.6.5.2.1.

2.2.10.2.1.1 TXUSER_PHASE0_MTAG_CREATE

The TXUSER_PHASE0_MTAG_CREATE message is sent by a resource manager to a transaction manager to create a new Phase Zero enlistment on a transaction.

0	1	2	3	4	5	6	7	8	9	0	1	2	3	4	5	6	7	8	9	0	1	2	3	4	5	6	7	8	9	0	1
MsgHeader (24 bytes)																															
...																															
...																															
guidTx (16 bytes)																															
...																															
...																															

MsgHeader (24 bytes): This field MUST contain a MESSAGE_PACKET structure.

- The **dwUserMsgType** field MUST be 0x00004901.

- The **dwcbVarLenData** field MUST be 16.

guidTx (16 bytes): This field MUST contain a GUID that specifies the transaction identifier.

2.2.10.2.1.2 TXUSER_PHASE0_MTAG_CREATE_TOO_LATE

The TXUSER_PHASE0_MTAG_CREATE_TOO_LATE message is sent by the transaction manager if the creation of the Phase Zero failed because the enlistment request was made too late in the specified transaction lifetime. See Create Phase Zero Enlistment Failure (section 3.6.7.7) and Register Phase Zero Failure (section 3.2.7.28) for more information.

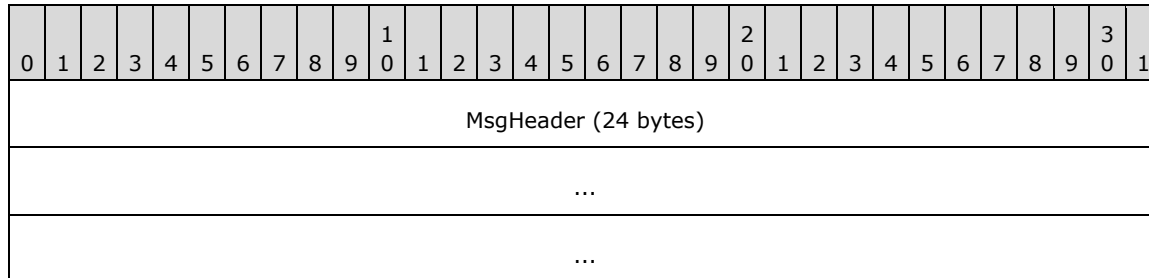

MsgHeader (24 bytes): This field MUST contain a MESSAGE_PACKET structure.

- The **dwUserMsgType** field MUST be 0x00004907.
- The **dwcbVarLenData** field MUST be 0.

2.2.10.2.1.3 TXUSER_PHASE0_MTAG_CREATE_TX_NOT_FOUND

The TXUSER_PHASE0_MTAG_CREATE_TX_NOT_FOUND message is sent by the transaction manager if the creation of the Phase Zero enlistment failed because the specified transaction could not be found.

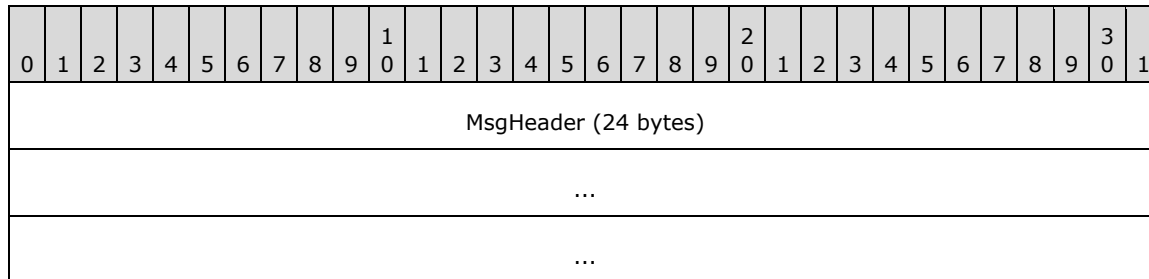

MsgHeader (24 bytes): This field MUST contain a MESSAGE_PACKET structure.

- The **dwUserMsgType** field MUST be 0x00004906.
- The **dwcbVarLenData** field MUST be 0.

2.2.10.2.1.4 TXUSER_PHASE0_MTAG_CREATED

The TXUSER_PHASE0_MTAG_CREATED message is sent by the transaction manager if the creation of the Phase Zero enlistment was successful.

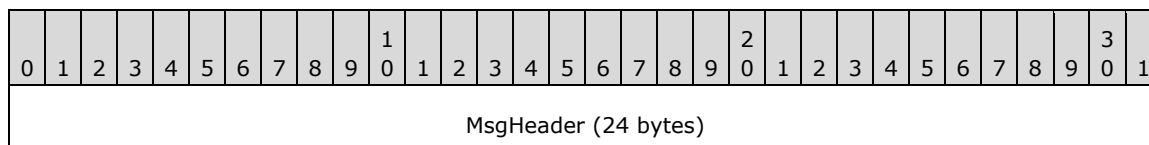

...
...

MsgHeader (24 bytes): This field MUST contain a MESSAGE_PACKET structure.

- The **dwUserMsgType** field MUST be 0x00004902.
- The **dwcbVarLenData** field MUST be 0.

2.2.10.2.1.5 TXUSER_PHASE0_MTAG_PHASE0REQ

The TXUSER_PHASE0_MTAG_PHASE0REQ message indicates a Phase Zero request from the transaction manager to the Phase Zero enlistment.

0	1	2	3	4	5	6	7	8	9	10	11	12	13	14	15	16	17	18	19	20	21	22	23	24	25	26	27	28	29	30	31
MsgHeader (24 bytes)																															
...																															
...																															

MsgHeader (24 bytes): This field MUST contain a MESSAGE_PACKET structure.

- The **dwUserMsgType** field MUST be 0x00004903.
- The **dwcbVarLenData** field MUST be 0.

2.2.10.2.1.6 TXUSER_PHASE0_MTAG_PHASE0REQ_ABORT

The TXUSER_PHASE0_MTAG_PHASE0REQ_ABORT message is sent by the transaction manager to notify the Phase Zero enlistment that the transaction aborted.

0	1	2	3	4	5	6	7	8	9	10	11	12	13	14	15	16	17	18	19	20	21	22	23	24	25	26	27	28	29	30	31
MsgHeader (24 bytes)																															
...																															
...																															

MsgHeader (24 bytes): This field MUST contain a MESSAGE_PACKET structure.

- The **dwUserMsgType** field MUST be 0x00004909.
- The **dwcbVarLenData** field MUST be 0.

2.2.10.2.1.7 TXUSER_PHASE0_MTAG_PHASE0REQDONE

The TXUSER_PHASE0_MTAG_PHASE0REQDONE message is sent by the resource manager to notify the transaction manager that the Phase Zero enlistment has completed the Phase Zero processing request.

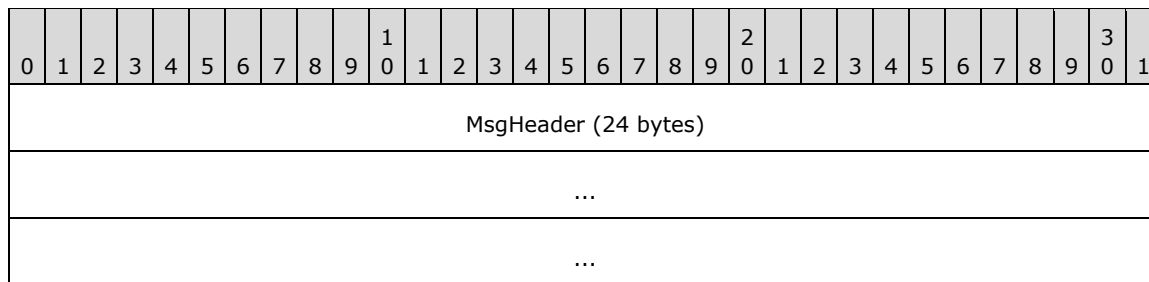

MsgHeader (24 bytes): This field MUST contain a MESSAGE_PACKET structure.

- The **dwUserMsgType** field MUST be 0x00004904.
- The **dwcbVarLenData** field MUST be 0.

2.2.10.2.1.8 TXUSER_PHASE0_MTAG_UNENLIST

The TXUSER_PHASE0_MTAG_UNENLIST message is sent by the resource manager to notify the transaction manager that the Phase Zero enlistment is to be removed and is no longer part of the transaction.

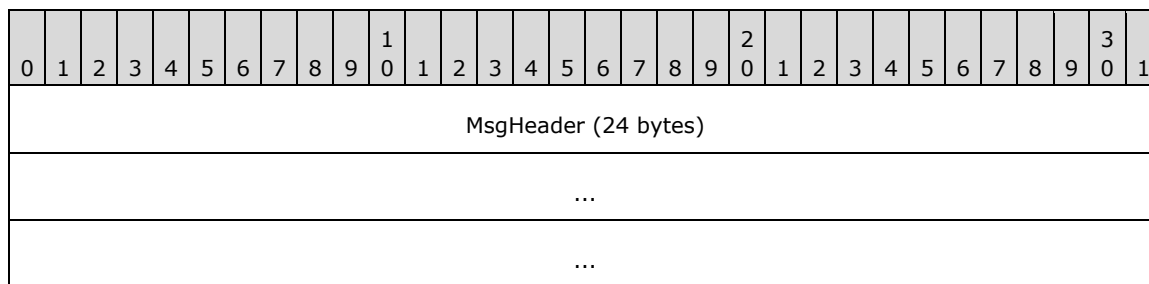

MsgHeader (24 bytes): This field MUST contain a MESSAGE_PACKET structure.

- The **dwUserMsgType** field MUST be 0x00004905.
- The **dwcbVarLenData** field MUST be 0.

2.2.10.2.2 CONNTYPE_TXUSER_ENLISTMENT

The CONNTYPE_TXUSER_ENLISTMENT connection type is used by a durable resource manager to establish an enlistment with its transaction manager.

For more details about CONNTYPE_TXUSER_ENLISTMENT as an initiator, see section 3.5.5.2.2, and as an acceptor, see section 3.6.5.2.2.

2.2.10.2.2.1 TXUSER_ENLISTMENT_MTAG_ABORTREQ

The TXUSER_ENLISTMENT_MTAG_ABORTREQ message is sent by the transaction manager (TM) to the resource manager (RM) to inform the RM that the transaction has aborted.

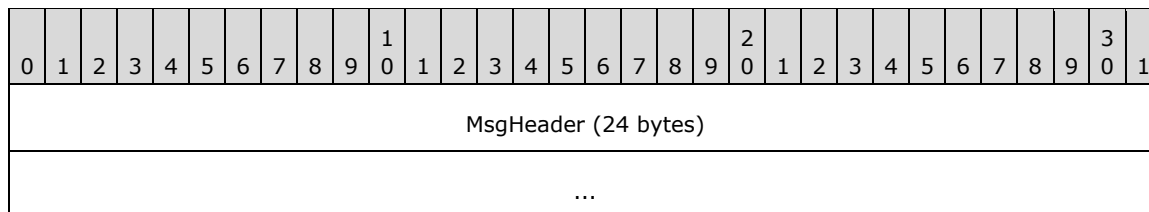

...

MsgHeader (24 bytes): This field MUST contain a MESSAGE_PACKET structure.

- The **dwUserMsgType** field MUST be 0x00001034.
- The **dwcbVarLenData** field MUST be 0.

2.2.10.2.2.2 TXUSER_ENLISTMENT_MTAG_ABORTREQDONE

The TXUSER_ENLISTMENT_MTAG_ABORTREQDONE message acknowledges that the resource manager processed the abort and the transaction manager is no longer obligated to retain the outcome of the transaction.

0	1	2	3	4	5	6	7	8	9	10	11	12	13	14	15	16	17	18	19	20	21	22	23	24	25	26	27	28	29	30	31
MsgHeader (24 bytes)																															
...																															
...																															

MsgHeader (24 bytes): This field MUST contain a MESSAGE_PACKET structure.

- The **dwUserMsgType** field MUST be 0x00001037.
- The **dwcbVarLenData** field MUST be 0.

2.2.10.2.2.3 TXUSER_ENLISTMENT_MTAG_COMMITREQ

The TXUSER_ENLISTMENT_MTAG_COMMITREQ message is sent by the transaction manager to notify the resource manager that the transaction has committed and that the resource manager MUST carry out the operations that are necessary to commit the work that is performed under the transaction.

0	1	2	3	4	5	6	7	8	9	10	11	12	13	14	15	16	17	18	19	20	21	22	23	24	25	26	27	28	29	30	31
MsgHeader (24 bytes)																															
...																															
...																															

MsgHeader (24 bytes): This field MUST contain a MESSAGE_PACKET structure.

- The **dwUserMsgType** field MUST be 0x00001035.
- The **dwcbVarLenData** field MUST be 0.

2.2.10.2.2.4 TXUSER_ENLISTMENT_MTAG_COMMITREQDONE

The TXUSER_ENLISTMENT_MTAG_COMMITREQDONE message is sent by the resource manager to indicate that it has carried out the necessary operations to commit the transaction, and that the

transaction manager is no longer obligated to retain the outcome of the transaction for the resource manager.

0	1	2	3	4	5	6	7	8	9	10	11	12	13	14	15	16	17	18	19	20	21	22	23	24	25	26	27	28	29	30	31
MsgHeader (24 bytes)																															
...																															
...																															

MsgHeader (24 bytes): This field MUST contain a MESSAGE_PACKET structure.

- The **dwUserMsgType** field MUST be 0x00001038.
- The **dwcbVarLenData** field MUST be 0.

2.2.10.2.2.5 TXUSER_ENLISTMENT_MTAG_ENLIST

The TXUSER_ENLISTMENT_MTAG_ENLIST message is sent by the resource manager to request the creation of a new enlistment on a transaction.

0	1	2	3	4	5	6	7	8	9	10	11	12	13	14	15	16	17	18	19	20	21	22	23	24	25	26	27	28	29	30	31
MsgHeader (24 bytes)																															
...																															
...																															
guidTX (16 bytes)																															
...																															
...																															
guidRM (16 bytes)																															
...																															
...																															
guidSession (16 bytes)																															
...																															
...																															

MsgHeader (24 bytes): This field MUST contain a MESSAGE_PACKET structure.

- The **dwUserMsgType** field MUST be 0x00001031.

- The **dwcbVarLenData** field MUST be 48.

guidTX (16 bytes): This field MUST contain a GUID that specifies the transaction identifier.

guidRM (16 bytes): This field MUST contain a GUID that specifies the resource manager identifier.

guidSession (16 bytes): This field MUST contain a GUID that specifies the session identifier of the resource manager.

2.2.10.2.2.6 TXUSER_ENLISTMENT_MTAG_ENLIST_LOG_FULL

The TXUSER_ENLISTMENT_MTAG_ENLIST_LOG_FULL message is sent by the transaction manager to indicate that the creation of the new enlistment failed because insufficient space exists in the recovery log of the transaction manager to be able to account for the new enlistment.

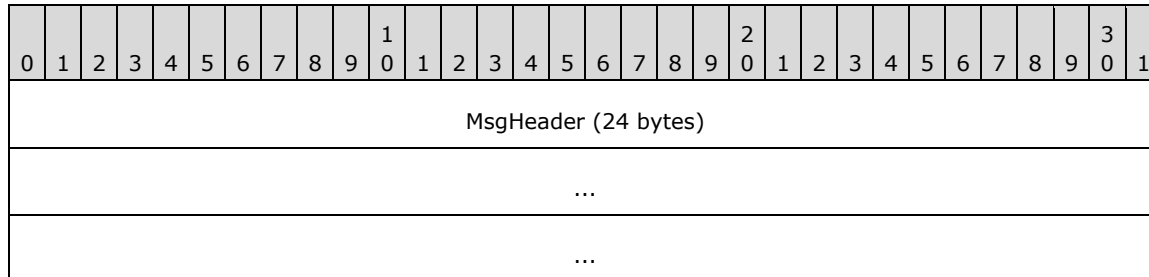

MsgHeader (24 bytes): This field MUST contain a MESSAGE_PACKET structure.

- The **dwUserMsgType** field MUST be 0x00001903.
- The **dwcbVarLenData** field MUST be 0.

2.2.10.2.2.7 TXUSER_ENLISTMENT_MTAG_ENLIST_TOO_LATE

The TXUSER_ENLISTMENT_MTAG_ENLIST_TOO_LATE message is sent by the transaction manager to indicate that the creation of that enlistment failed because it is too late in the lifetime of the specified transaction. See Create Subordinate Enlistment Failure and Create Subordinate Enlistment for more information.

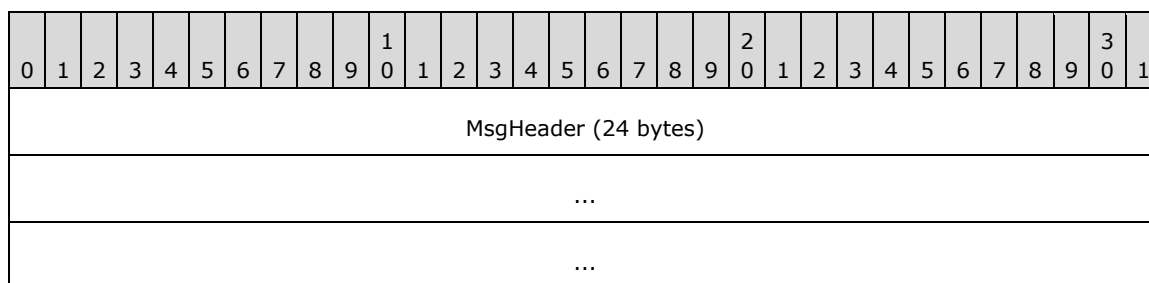

MsgHeader (24 bytes): This field MUST contain a MESSAGE_PACKET structure.

- The **dwUserMsgType** field MUST be 0x00001902.
- The **dwcbVarLenData** field MUST be 0.

2.2.10.2.2.8 TXUSER_ENLISTMENT_MTAG_ENLIST_TOO_MANY

The TXUSER_ENLISTMENT_MTAG_ENLIST_TOO_MANY message is sent by the transaction manager to indicate that the creation of the new enlistment failed because the implementation-specific maximum number of enlistments for the transaction has been reached. <21>

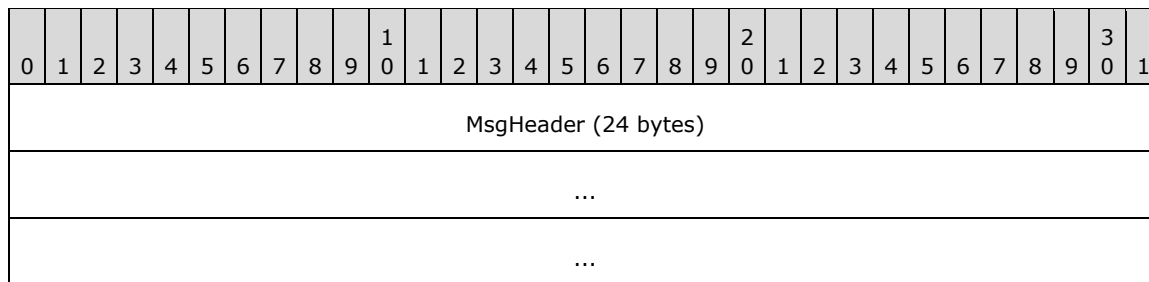

MsgHeader (24 bytes): This field MUST contain a MESSAGE_PACKET structure.

- The **dwUserMsgType** field MUST be 0x00001905.
- The **dwcbVarLenData** field MUST be 0.

2.2.10.2.2.9 TXUSER_ENLISTMENT_MTAG_ENLIST_TX_NOT_FOUND

The TXUSER_ENLISTMENT_MTAG_ENLIST_TX_NOT_FOUND message is sent by the transaction manager to indicate that the creation of the new enlistment failed because the specified transaction does not exist.

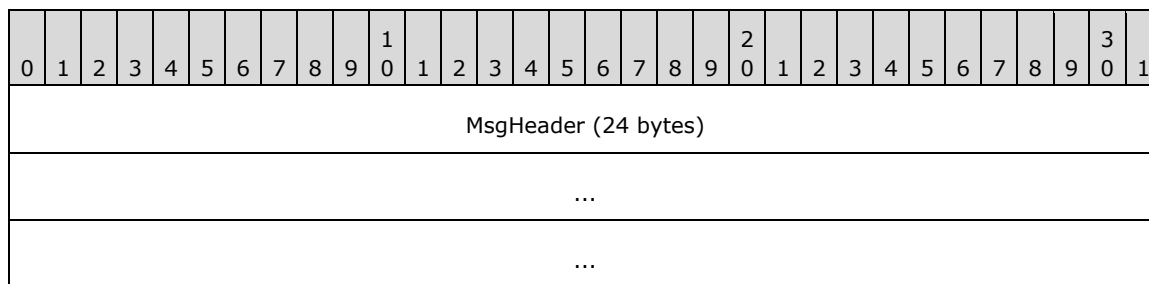

MsgHeader (24 bytes): This field MUST contain a MESSAGE_PACKET structure.

- The **dwUserMsgType** field MUST be 0x00001901.
- The **dwcbVarLenData** field MUST be 0.

2.2.10.2.2.10 TXUSER_ENLISTMENT_MTAG_ENLISTED

The TXUSER_ENLISTMENT_MTAG_ENLISTED message is sent by the transaction manager to indicate that the creation of the new enlistment was successful.

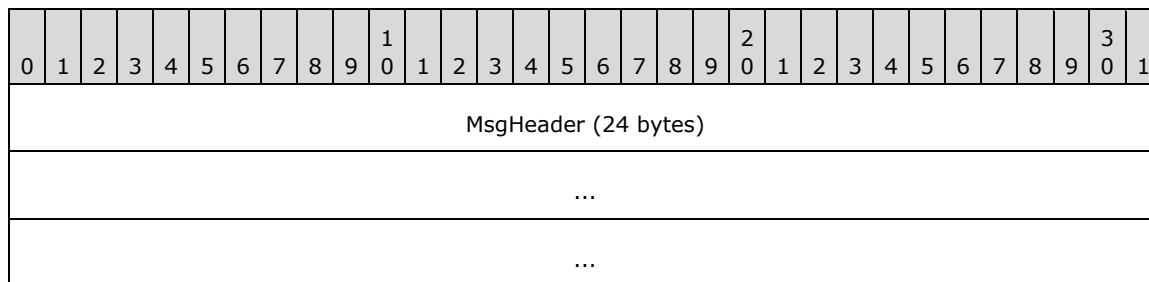

MsgHeader (24 bytes): This field MUST contain a MESSAGE_PACKET structure.

- The **dwUserMsgType** field MUST be 0x00001032.
- The **dwcbVarLenData** field MUST be 0.

2.2.10.2.2.11 TXUSER_ENLISTMENT_MTAG_PREPAREREQ

The TXUSER_ENLISTMENT_MTAG_PREPAREREQ message is used to request that the resource manager perform the actions that are needed to prepare the transaction to be committed.

0	1	2	3	4	5	6	7	8	9	10	11	12	13	14	15	16	17	18	19	20	21	22	23	24	25	26	27	28	29	30	31
MsgHeader (24 bytes)																															
...																															
...																															
grfRM																															
fSinglePhase																															

MsgHeader (24 bytes): This field MUST contain a MESSAGE_PACKET structure.

- The **dwUserMsgType** field MUST be 0x00001033.
- The **dwcbVarLenData** field MUST be 8.

grfRM (4 bytes): The value of this field MUST be a 32-bit unsigned integer. This value SHOULD be ignored on receipt.

fSinglePhase (4 bytes): Indicates whether the sending transaction manager is willing to allow the single-phase commit optimization. If the value is zero, the resource manager receiving this message MUST NOT perform a single-phase commit. If the value is nonzero, the resource manager receiving this message SHOULD perform a single-phase commit.

2.2.10.2.2.12 TXUSER_ENLISTMENT_MTAG_PREPAREREQDONE

The TXUSER_ENLISTMENT_MTAG_PREPAREREQDONE message is sent by the resource manager to indicate either success or failure of the prepare operation, depending on the value of the **prepareReqDone** field.

0	1	2	3	4	5	6	7	8	9	10	11	12	13	14	15	16	17	18	19	20	21	22	23	24	25	26	27	28	29	30	31
MsgHeader (24 bytes)																															
...																															
...																															
prepareReqDone																															
guidReason (16 bytes)																															
...																															
...																															

MsgHeader (24 bytes): This field MUST contain a MESSAGE_PACKET structure.

- The **dwUserMsgType** field MUST be 0x00001036.
- The **dwcbVarLenData** field MUST be 20.

prepareReqDone (4 bytes): A value indicating the result of the prepare operations that are performed by the resource manager. The value MUST be one that is as specified by the TXUSER_ENLISTMENT_PREPAREREQDONE_RESPONSE enumeration.

guidReason (16 bytes): This field MUST contain a GUID that contains an implementation-specific value that MUST be ignored on receipt.

2.2.10.3 Transaction Recovery

2.2.10.3.1 CONNTYPE_TXUSER_REENLIST

This connection type is used by a durable resource manager to determine the outcome of an In Doubt transaction.

For more information about CONNTYPE_TXUSER_REENLIST as an initiator, see section 3.5.5.3.1, and as an acceptor, see section 3.6.5.3.1.

2.2.10.3.1.1 TXUSER_REENLIST_MTAG_REENLIST

The TXUSER_REENLIST_MTAG_REENLIST message indicates that the resource manager wants to obtain the outcome of an In Doubt transaction from the transaction manager.

0	1	2	3	4	5	6	7	8	9	10	11	12	13	14	15	16	17	18	19	20	21	22	23	24	25	26	27	28	29	30	31
MsgHeader (24 bytes)																															
...																															
...																															
guidTx (16 bytes)																															
...																															
...																															
ulTimeout																															
guidRm (16 bytes)																															
...																															
...																															

MsgHeader (24 bytes): This field MUST contain a MESSAGE_PACKET structure.

- The **dwUserMsgType** field MUST be 0x00001061.

- The **dwcbVarLenData** field MUST be 36.

guidTx (16 bytes): This field MUST contain a GUID that specifies the transaction identifier.

ulTimeout (4 bytes): This field MUST specify the time, in milliseconds, that the resource manager will wait for a decision. A value of zero MUST represent an infinite timeout. The recipient SHOULD NOT send a TXUSER_REENLIST_MTAG_REENLIST_TIMEOUT message until the time span that is specified by this value has elapsed.

guidRm (16 bytes): This field MUST be a GUID that specifies the resource manager identifier.

2.2.10.3.1.2 TXUSER_REENLIST_MTAG_REENLIST_ABORTED

The TXUSER_REENLIST_MTAG_REENLIST_ABORTED message indicates that the transaction that is supplied by the TXUSER_REENLIST_MTAG_REENLIST has aborted.

0	1	2	3	4	5	6	7	8	9	10	11	12	13	14	15	16	17	18	19	20	21	22	23	24	25	26	27	28	29	30	31
MsgHeader (24 bytes)																															
...																															
...																															

MsgHeader (24 bytes): This field MUST contain a MESSAGE_PACKET structure.

- The **dwUserMsgType** field MUST be 0x00001062.
- The **dwcbVarLenData** field MUST be 0.

2.2.10.3.1.3 TXUSER_REENLIST_MTAG_REENLIST_COMMITTED

The TXUSER_REENLIST_MTAG_REENLIST_COMMITTED message indicates that the transaction that is supplied by the TXUSER_REENLIST_MTAG_REENLIST has committed.

0	1	2	3	4	5	6	7	8	9	10	11	12	13	14	15	16	17	18	19	20	21	22	23	24	25	26	27	28	29	30	31
MsgHeader (24 bytes)																															
...																															
...																															

MsgHeader (24 bytes): This field MUST contain a MESSAGE_PACKET structure.

- The **dwUserMsgType** field MUST be 0x00001063.
- The **dwcbVarLenData** field MUST be 0.

2.2.10.3.1.4 TXUSER_REENLIST_MTAG_REENLIST_TIMEOUT

The TXUSER_REENLIST_MTAG_REENLIST_TIMEOUT message indicates that the TXUSER_REENLIST_MTAG_REENLIST request has exceeded the time span that is specified by its **ulTimeout** field and therefore has failed.

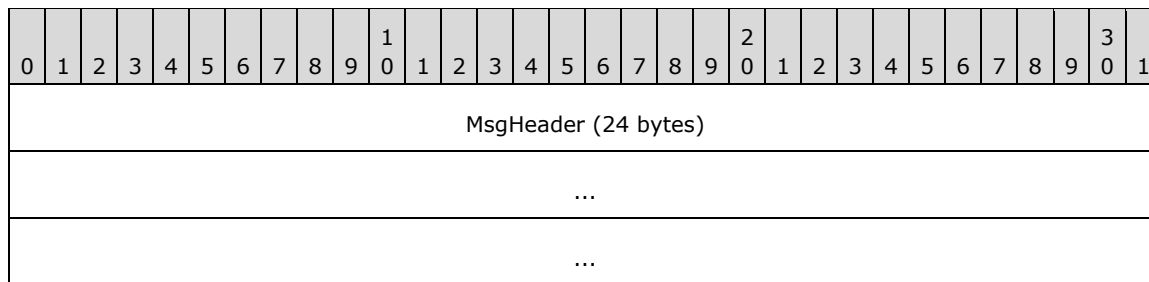

MsgHeader (24 bytes): This field MUST contain a MESSAGE_PACKET structure.

- The **dwUserMsgType** field MUST be 0x00001064.
- The **dwcbVarLenData** field MUST be 0.

2.2.10.4 Voting

2.2.10.4.1 CONNTYPE_TXUSER_VOTER

This connection type is used by a volatile resource manager to establish a voter enlistment with its transaction manager.

For more details on CONNTYPE_TXUSER_VOTER as an initiator, see section 3.5.5.4.1, and as an acceptor, see section 3.6.5.4.1.

2.2.10.4.1.1 TXUSER_STATUS_MTAG_ABORTED

The TXUSER_STATUS_MTAG_ABORTED message is sent by the transaction manager to notify the resource manager that the transaction has aborted.

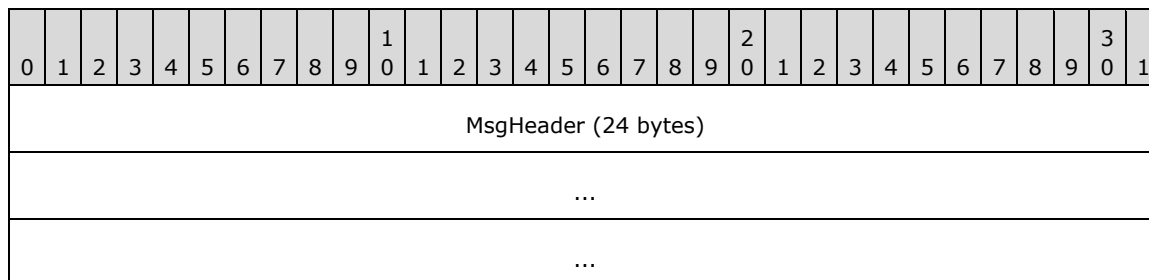

MsgHeader (24 bytes): This field MUST contain a MESSAGE_PACKET structure.

- The **dwUserMsgType** field MUST be 0x00001093.
- The **dwcbVarLenData** field MUST be 0.

2.2.10.4.1.2 TXUSER_STATUS_MTAG_COMMITTED

The TXUSER_STATUS_MTAG_COMMITTED message is sent by the transaction manager to notify the resource manager that the transaction has committed.

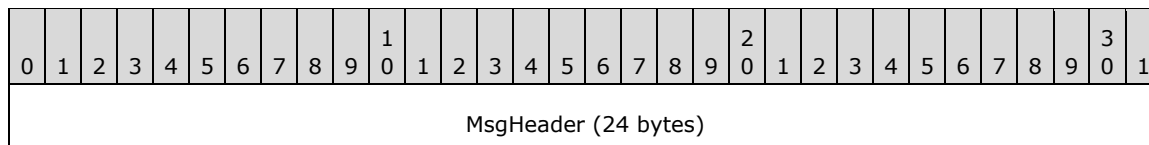

...
...

MsgHeader (24 bytes): This field MUST contain a MESSAGE_PACKET structure.

- The **dwUserMsgType** field MUST be 0x00001094.
- The **dwcbVarLenData** field MUST be 0.

2.2.10.4.1.3 TXUSER_STATUS_MTAG_INDOUBT

The TXUSER_STATUS_MTAG_INDOUBT message is sent by the transaction manager to notify the resource manager that the outcome of the transaction is In Doubt.

0	1	2	3	4	5	6	7	8	9	10	11	12	13	14	15	16	17	18	19	20	21	22	23	24	25	26	27	28	29	30	31
MsgHeader (24 bytes)																															
...																															
...																															

MsgHeader (24 bytes): This field MUST contain a MESSAGE_PACKET structure.

- The **dwUserMsgType** field MUST be 0x00001095.
- The **dwcbVarLenData** field MUST be 0.

2.2.10.4.1.4 TXUSER_VOTER_MTAG_CREATE

The TXUSER_VOTER_MTAG_CREATE message is sent by the resource manager to create a new voter enlistment on a transaction.

0	1	2	3	4	5	6	7	8	9	10	11	12	13	14	15	16	17	18	19	20	21	22	23	24	25	26	27	28	29	30	31
MsgHeader (24 bytes)																															
...																															
...																															
guidTx (16 bytes)																															
...																															
...																															

MsgHeader (24 bytes): This field MUST contain a MESSAGE_PACKET structure.

- The **dwUserMsgType** field MUST be 0x00002091.

- The **dwcbVarLenData** field MUST be 16.

guidTx (16 bytes): This field MUST contain a GUID that specifies the transaction identifier.

2.2.10.4.1.5 TXUSER_VOTER_MTAG_CREATE_TOO_LATE

The TXUSER_VOTER_MTAG_CREATE_TOO_LATE message is sent by the transaction manager to indicate that the creation of the new voter enlistment was unsuccessful because it was too late in the lifetime of the transaction to create new enlistments. See Create Voter Enlistment Failure (section 3.6.7.12) and Create Voter Enlistment (section 3.2.7.14) for more information.

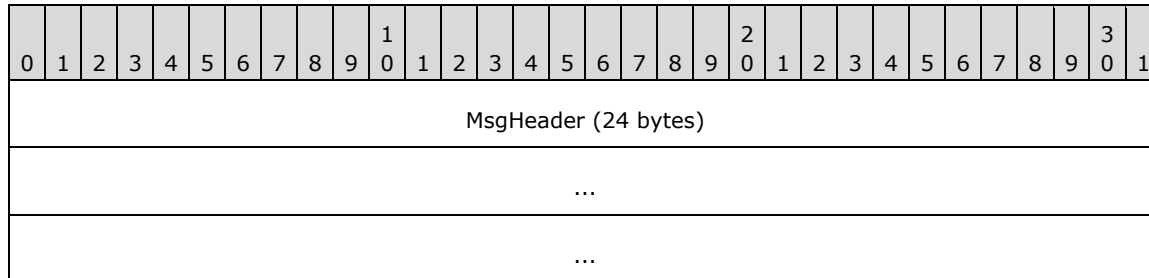

MsgHeader (24 bytes): This field MUST contain a MESSAGE_PACKET structure.

- The **dwUserMsgType** field MUST be 0x00002096.
- The **dwcbVarLenData** field MUST be 0.

2.2.10.4.1.6 TXUSER_VOTER_MTAG_CREATE_TX_NOT_FOUND

The TXUSER_VOTER_MTAG_CREATE_TX_NOT_FOUND message is sent by the transaction manager to indicate that creation of the new voter enlistment was unsuccessful because the specified transaction does not exist.

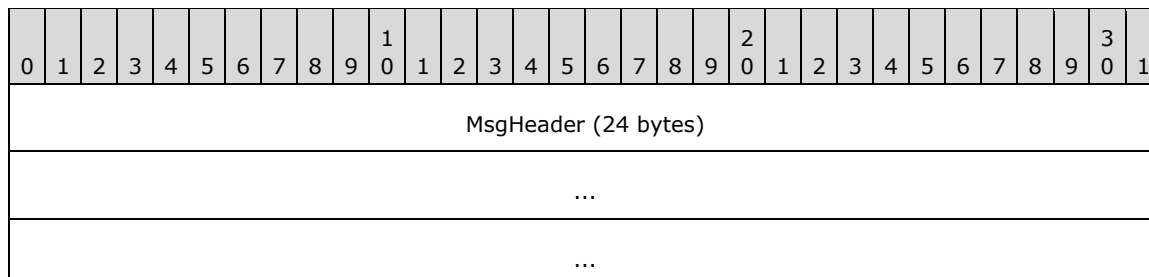

MsgHeader (24 bytes): This field MUST contain a MESSAGE_PACKET structure.

- The **dwUserMsgType** field MUST be 0x00002095.
- The **dwcbVarLenData** field MUST be 0.

2.2.10.4.1.7 TXUSER_VOTER_MTAG_CREATED

The TXUSER_VOTER_MTAG_CREATED message is sent by the transaction manager to indicate that creation of the new voter enlistment was successful.

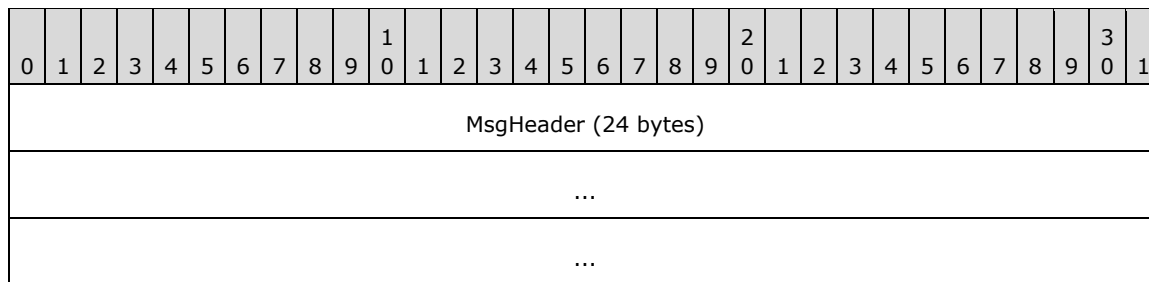

MsgHeader (24 bytes): This field MUST contain a MESSAGE_PACKET structure.

- The **dwUserMsgType** field MUST be 0x00002092.
- The **dwcbVarLenData** field MUST be 0.

2.2.10.4.1.8 TXUSER_VOTER_MTAG_VOTEREQ

The TXUSER_VOTER_MTAG_VOTEREQ message is sent by the transaction manager to request that the resource manager perform any operations it needs to during Phase One and to vote on the outcome of the transaction.

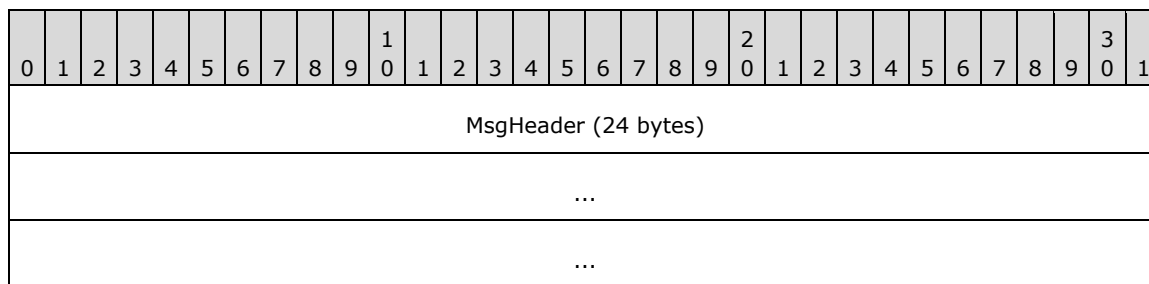

MsgHeader (24 bytes): This field MUST contain a MESSAGE_PACKET structure.

- The **dwUserMsgType** field MUST be 0x00002093.
- The **dwcbVarLenData** field MUST be 0.

2.2.10.4.1.9 TXUSER_VOTER_MTAG_VOTEREQDONE

The TXUSER_VOTER_MTAG_VOTEREQDONE message is sent by a voter to indicate whether it agrees to a decision to commit the transaction for which it had previously created a voter enlistment.

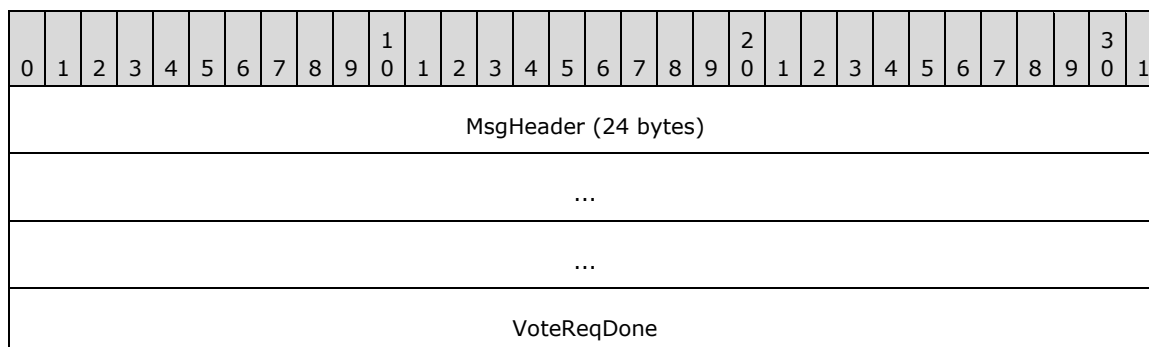

MsgHeader (24 bytes): This field MUST contain a MESSAGE_PACKET structure.

- The **dwUserMsgType** field MUST be 0x00002094.

- The **dwcbVarLenData** field MUST be 4.

VoteReqDone (4 bytes): The resource manager votes to commit or abort the transaction. The value MUST be one that is defined by the TXUSER_VOTER_VOTERREQDONE_RESPONSE enumeration.

3 Protocol Details

3.1 Common Details

This section defines common details for the transaction participants, as specified in sections 3.2 through 3.8. Each participant **MUST** conform to the details as specified in this section.

3.1.1 Abstract Data Model

This section describes a conceptual model of possible data organization that an implementation maintains to participate in this protocol. The described organization is provided to facilitate the explanation of how the protocol behaves. This document does not mandate that implementations adhere to this model as long as their external behavior is consistent with the behavior that is described in this document.

Note that the abstract data model can be implemented in a variety of ways. This protocol does not prescribe or advocate any specific implementation technique.

Participants **MUST** use the multiplexing protocol connections specified in [MS-CMP] section 3.1.1.1 as a transport protocol for sending messages. The Transport section defines the mechanisms by which this protocol initializes and makes use of the multiplexing protocol.

A participant **MUST** also maintain the following data elements:

- **Transaction table:** A table of entries to transaction objects, keyed by transaction identifier.
- **Session Table:** A table of Session objects, as maintained by the multiplexing protocol specified in [MS-CMP] section 3.1.1. The MSDTC Connection Manager: OleTx Transaction Protocol reads the Session table data elements provided by [MS-CMPO] but does not extend or modify the table.

Each transaction object **MUST** contain the following data structures:

- **Transaction Object.Identifier:** This field contains a GUID that specifies the transaction identifier.
- **Connection list:** A list of multiplexing protocol connection objects, as specified in [MS-CMP] section 3.1.1.1, that are associated with the transaction.

A transaction object is extended by various participants. When this extension includes enlistment details, then each discrete enlistment is represented in this model as an enlistment object. In this description, the enlistment object represents a set of fields that are always associated with each enlistment. As a group, these fields are referred to in the processing rules as the enlistment object. In the processing rules, a set of fields comprising an enlistment object are always added or removed as a group. Depending on the participant, there can be more than one enlistment object as part of the transaction object (**Core Transaction Manager Facet**, as specified in section 3.2.1, is an example of this).

An Enlistment object **MUST** contain the following data structures:

- **Transaction Manager Facet:** A reference to the specific facet in the transaction manager that created the Enlistment object. A single facet creates zero or more Enlistment objects. Transaction manager facets are as specified in section 3.2.1.4.
- **Transaction:** A reference to a transaction object.
- **Enlistment Object.Connection:** A reference to a connection object.

- **Resource Manager Identifier:** A GUID that uniquely identifies the resource manager. Each transaction manager facet MUST set this field if the transaction manager facet is communicating with a durable resource manager.
- **Recovery Information:** An extensibility point that allows transaction manager facets to contribute information to the durable log that is returned to them when recovery occurs. This field MUST be interpreted only by the transaction manager facet that created the Enlistment object.
- **Name:** A string providing a name for the enlistment. Each transaction manager facet MUST define the contents of this field for the Enlistment objects that are created by that facet.
- **Enlistment Object.Identifier:** A string providing an identifier for the enlistment. Each transaction manager facet MUST provide the contents of this field for Enlistment objects that are created by that facet.

Furthermore, a participant MUST extend the definition of a connection object to include the following data elements:

- **Transaction:** A reference to the transaction object that is associated with the connection.
- **State:** A state enumeration that represents the current state of the connection.
- **Connection-Specific Data:** An opaque reference to an object. This field is used during the execution of a connection to associate connection-specific objects with the connection. Some connections do not use this field.

A state enumeration MUST contain a set of values that represent specific states in a logical state machine. For a connection type, these values represent the different states to which the connection's logical state machine is set during the lifetime of the connection.

When a participant initiates or accepts a connection, the **State** field of the connection MUST be set initially to the Idle state. When the connection is disconnected, the connection state MUST be set to the Ended state.

For a participant initiating a connection, once the connection's state machine enters the Ended state, the connection that is associated with the state machine MUST be disconnected, if it is not already disconnected, as specified in section 3.1.8.2.

3.1.1.1 Converting a Name Object to an OLETX_TM_ADDR Structure

A Name object MUST be converted to an OLETX_TM_ADDR (section 2.2.4.2) structure in the following manner:

- The **guidSignature** field of OLETX_TM_ADDR MUST be set as specified in section 2.2.4.2.
- The **guidEndpoint** field of OLETX_TM_ADDR MUST be set to the **CID** field of the Name object.
- The **grbComProtsSupported** field of OLETX_TM_ADDR MUST be set to the **Protocols** field of the Name object.
- The **wszHostName** field of OLETX_TM_ADDR MUST be set to the **Hostname** field of the Name object.

3.1.1.2 Converting an OLETX_TM_ADDR Structure to a Name Object

An OLETX_TM_ADDR (section 2.2.4.2) structure MUST be converted to a Name object in the following manner:

- The **CID** field of the Name object MUST be set to the **guidEndpoint** field of OLETX_TM_ADDR.

- The **Protocols** field of the Name object MUST be set to the **grbComProtsSupported** field of OLETX_TM_ADDR.
- The **Hostname** field of the Name object MUST be set to the **wszHostName** field of OLETX_TM_ADDR.

3.1.1.3 Converting a Name Object to a NAMEOBJECTBLOB Structure

A Name object MUST be converted to a NAMEOBJECTBLOB (section 2.2.5.3) structure in the following manner:

- The **szGuid** field of NAMEOBJECTBLOB MUST be set to the **CID** field of the Name object and formatted as a string, as specified in [C706] Appendix A.
- The **grbComProtsSupported** field of NAMEOBJECTBLOB MUST be set to the **Protocols** field of the Name object.
- The **szHostName** field of NAMEOBJECTBLOB MUST be set to the **Hostname** field of the Name object and formatted as a null-terminated Latin-1 ANSI string, as specified in [ISO/IEC-8859-1].
- The **dwcbHostName** and **dwReserved1** fields MUST be set as specified in section 2.2.5.3.

3.1.1.4 Converting a NAMEOBJECTBLOB Structure to a Name Object

A NAMEOBJECTBLOB (section 2.2.5.3) structure MUST be converted to a Name object in the following manner:

- The **CID** field of the Name object MUST be set to the **szGuid** field of NAMEOBJECTBLOB, converted from a string to a GUID as specified in [C706] Appendix A.
- The **Protocols** field of the Name object MUST be set to the **grbComProtsSupported** field of NAMEOBJECTBLOB.
- The **Hostname** field of the Name object MUST be set to the **szHostName** field of NAMEOBJECTBLOB.

3.1.2 Timers

None.

3.1.3 Initialization

The initialization process of this protocol MUST initialize the underlying instance of the MSDTC Connection Manager: OleTx Multiplexing ([MS-CMP]) and MSDTC Connection Manager: OleTx Transports ([MS-CMPO]) protocols as specified in section 2.1.2.

If initialization fails for the underlying [MS-CMP] protocol as specified in [MS-CMP] section 3.1.3.1, or for the underlying [MS-CMPO] protocol as specified in [MS-CMPO] section 3.2.3.1, then the initialization of the [MS-DTCO] protocol MUST also fail and an implementation-specific failure result MUST be returned to the higher-layer business logic.

To establish an OleTx connection between an initiator and an acceptor both the initiator and the acceptor MUST follow the processing steps as specified in [MS-CMP] section 3.1.4.2.

To initiate a connection, a session MUST already be established between the initiator and the acceptor.

For the use of MSDTC Connection Manager: OleTx Transports Protocol sessions ([MS-CMPO] section 3.2.1.2) and MSDTC Connection Manager: OleTx Multiplexing Protocol connections ([MS-CMP] section 3.1.1.1) in this protocol, see section 2.1.

3.1.3.1 Enlistment Object Initialization

A participant MUST initialize each new Enlistment object that is created by the participant with the following default values:

- The **transaction manager facet** field MUST default to an empty value.
- The **transaction** field MUST default to an empty value.
- The **Enlistment Object.Connection** field MUST default to an empty value.
- The **resource manager identifier** field MUST default to NULL_GUID.
- The **recovery information** field MUST default to an empty value.
- The **name** field MUST default to an empty string.
- The **Enlistment Object.Identifier** field MUST default to an empty string.

3.1.4 Protocol Versioning Details

3.1.4.1 Supporting a Protocol Version

A protocol role implementation that claims support for a protocol version MUST implement all the protocol elements required by that version for the respective role, as specified in section 2.2.1.

A protocol role implementation that claims a version as the maximum supported protocol version MUST support that version, and it MUST NOT implement any protocol elements that are neither required nor optional for that version (see section 2.2.1).

3.1.4.2 Negotiating a Common Protocol Version

Before exchanging any protocol messages, two protocol participants MUST agree on what protocol version to use for their communication. To negotiate a common protocol version, the two protocol participants MUST use the version negotiation mechanism provided by the MSDTC Connection Manager: OleTx Transports Protocol transport (see [MS-CMPO] section 3.3.4.2.1 BuildContext-Primary) as follows:

- When a protocol participant (application, resource manager, transaction manager) initializes its underlying MSDTC Connection Manager: OleTx Transports Protocol transport, it MUST do the following:
 - Set the Minimum Level 3 Version Number data field of the underlying MSDTC Connection Manager: OleTx Transports Protocol implementation to 0x00000001 (see also [MS-CMPO] section 3.2.1.1). Note that the MSDTC Connection Manager: OleTx Transaction Protocol is layered on top of MSDTC Connection Manager: OleTx Multiplexing Protocol (specified in [MS-CMP]), which is layered on top of the MSDTC Connection Manager: OleTx Transports Protocol (specified in [MS-CMPO]). Therefore, it is a level-three protocol for the MSDTC Connection Manager: OleTx Transports Protocol (as defined in [MS-CMPO] section 2.2.2).
 - Set the Maximum Level 3 Version Number data field of the underlying MSDTC Connection Manager: OleTx Transports Protocol implementation to the value of the maximum supported MSDTC Connection Manager: OleTx Transaction Protocol version (defined in section 3.1.4.1).

When an MSDTC Connection Manager: OleTx Transports Protocol session is successfully established between the two protocol participants, the value of the **dwLevelThreeAccepted** field of the session object's **Version** field (see [MS-CMPO] section 3.2.1.2, Session State) indicates the negotiated protocol version (for example, if the value of the **dwLevelThreeAccepted** field is 5, the negotiated protocol version is 5).

3.1.4.3 Using the Negotiated Protocol Version

Once a protocol version is negotiated, the session partners SHOULD use in their communication only the protocol elements that are either required or optional for that version (see section 2.2.1 for a definition of version-required and version-optional elements), as follows:

- When a partner makes a connection request, it SHOULD use only a connection type that is either required or optional for the negotiated protocol version. If the connection type is optional for the negotiated protocol version, it MUST handle the MTAG_CONNECTION_REQ_DENIED ([MS-CMP] section 2.2.5) response and return the failure result to the higher business layer.<22>
- When a partner receives a connection request, it MUST accept as valid only a connection type that is either required or optional for the negotiated protocol version. Invalid connections MUST be rejected, as specified in [MS-CMP] section 2.2.5.
- When a partner sends a message over an established connection, it SHOULD use only message types and formats that are supported by the negotiated protocol version in the context of the connection type of the respective connection.<23>
- When a partner receives a message over an established connection, it SHOULD accept as valid only message types and formats that are supported by the negotiated protocol version in the context of the connection type of the respective connection. An invalid message MUST be rejected, as specified in section 3.1.6.

3.1.5 Higher-Layer Triggered Events

None.

3.1.6 Processing Events and Sequencing Rules

When an OleTx connection partner receives an incoming message on a connection, it MUST perform the following actions in order to verify the validity of the message:

- Schema validation
 - The participant MUST validate the message content in accord with the message schema and constraints specified in section 2.2 for the specific incoming message type. If a message type is not determinable, the message MUST be considered invalid.
- State validation
 - The participant MUST verify the current state of the connection by using the State field of the connection as follows:
 - If the connection is in the Ended state, the message MUST be considered invalid.
 - If the connection type has not defined a specific processing rule in section 3 for the processing of the specific message in the current connection state, then the message MUST be considered invalid.

If an incoming message is considered invalid, the participant MUST ignore the contents of the message. Furthermore, the connection on which the message was received MUST transition to the

Ended state, and return a failure result to the higher-layer business logic. The participant MAY also tear down the session with which the connection was established.<24>

If the connection type defines specific actions that MUST be performed when an invalid message is received, the connection partner MUST also perform those actions. These actions are specified in the Message Processing Events and Sequencing Rules section that specifies the behavior of the connection type.

The various failure results returned to the higher-layer business logic are implementation-specific. Failure results SHOULD include implementation-specific context around valid error messages and invalid incoming messages.

3.1.7 Timer Events

None.

3.1.8 Other Local Events

An OleTx connection participant MUST be able to handle the following events at any time during the lifetime of an OleTx connection.

3.1.8.1 Initiate Connection

The Initiate Connection event MUST be signaled with the following parameters:

- Name Object of the partner to create the connection.
- The connection type of the outgoing connection.

On Initiate Connection event signal, an OleTx connection participant MUST perform the following:

- Create a new Incoming Message Notification Interface object with the event fields set to local events **Receiving a Message** (section 3.1.8.4) and **Connection Disconnected** (section 3.1.8.3) respectively.
- Signal Create Connection event as specified in [MS-CMP] section 3.1.4.2 by passing the following parameters:
 - The provided Name Object of the partner to create the connection.
 - The provided connection type of the outgoing connection.
 - The new Incoming Message Notification Interface object to receive incoming message notifications from MSDTC Connection Manager: OleTx Multiplexing Protocol layer.

3.1.8.2 Disconnect Connection

The Disconnect Connection event MUST be signaled with the following argument:

- A Connection object

When a Disconnect Connection event is signaled, an OleTx connection participant MUST perform the following:

- Perform all the actions that are required for a valid disconnection as specified in [MS-CMP] section 3.1.4.3.

3.1.8.3 Connection Disconnected

The Connection Disconnected event MUST be signaled with the following argument:

- A Connection object

When a Connection Disconnected event is signaled, an OleTx connection participant MUST perform the following:

- If the connection type defines specific additional actions that MUST be performed when a connection is disconnected, the OleTx participant MUST also perform those actions. These actions are specified in the specific Message Processing Events and Sequencing Rules section that defines the behavior of a specified connection type when receiving incoming messages.
- The connection MUST be removed from the connection list that belongs to the transaction that is associated with the connection.
- If the connection state is not already Ended, the state MUST be set to Ended.

3.1.8.4 Receiving a Message

The Receiving a Message event MUST be signaled with the following arguments:

- A protocol message extending the MESSAGE_PACKET structure
- A Connection object

If the Receiving a Message event is signaled, an OleTx connection participant MUST perform the following actions:

- Verify the validity of the received protocol message as specified in section 3.1.6.
- When a partner receives a connection request, it MUST accept as valid only a connection type that is either required or optional for the negotiated protocol version. Invalid connections MUST be rejected by sending an MTAG_CONNECTION_REQ_DENIED [MS-CMP] (section 2.2.5) message with the **Reason** field set to 0x80070057.
- If the incoming message is MTAG_CONNECTION_REQ_DENIED [MS-CMP] (section 2.2.5) message:
 - If the connection state is not already Ended, the state MUST be set to Ended.
 - Return the failure reason code from the **Reason** field to higher-layer business logic.
- If the connection type defines specific additional actions that MUST be performed when a connection is requested or when a valid user message is processed, the OleTx participant MUST also perform those actions. These actions are specified in the specific Message Processing Events and Sequencing Rules section that defines the behavior of a specified connection type and the user message type when receiving incoming messages.

3.2 Core Transaction Manager Facet Details

3.2.1 Abstract Data Model

This section describes a conceptual model of possible data organization that an implementation maintains to participate in this protocol. The described organization is provided to facilitate the explanation of how the protocol behaves. This document does not mandate that implementations adhere to this model as long as their external behavior is consistent with the behavior that is described in this document.

Note that the abstract data model can be implemented in a variety of ways. This protocol does not prescribe or advocate any specific implementation technique.

The Core Transaction Manager Facet MUST maintain all the data elements described in section 3.1.1.

The Core Transaction Manager Facet MUST also maintain the following data elements:

- **Core Transaction Manager Facet.Durable Log:** A durable list of transaction objects. The contents of the log MUST persist across software restarts or transient failures.
- **Protocol Extension List:** A list of protocol extensions, as specified in section 3.2.1.5.
- **Extended Whereabouts:** A memory buffer that represents the extended whereabouts information of the transaction manager, contributed by protocol extension objects as specified in section 3.2.1.5.
- **Extended Whereabouts Size:** The size of the extended whereabouts buffer, in bytes.
- **Extended Whereabouts Protocol Count:** The number of protocol extension objects that contributed to the extended whereabouts information.
- **Security Level:** An enumeration that indicates the security level at which the transaction manager initializes communication by using the transports protocol as specified in [MS-CMPO] and the multiplexing protocol as specified in [MS-CMP] section 3.2.1.1. This element MUST be set to one of the following values:
 - **No Security:** This value is set to indicate that the RPC communications MUST NOT require validation of the identity for an incoming message.
 - **Incoming Authentication:** This value is set to indicate that the RPC communication SHOULD validate the identity for an incoming message.
 - **Mutual Authentication:** This value is set to indicate that the RPC communication SHOULD validate that there is a known identity for an incoming connection. The incoming connection is refused if the identity is not established. The incoming identity MUST match the pattern "<domain>\<incoming-MSDTC-name>\$", where <incoming-MSDTC-name> is the source hostname for the connection, and <domain> is the name of the domain in which the host is a member.
- The Core Transaction Manager Facet MUST maintain the following security flags and MUST set each flag to either TRUE or FALSE:
 - **Allow Network Access:** A Boolean flag that indicates whether the transaction manager will communicate with an OleTx participant that is located on a remote machine. If this flag is not set, network access MUST NOT be enabled for the OleTx protocol, regardless of the settings of the other flags.
 - **Allow Network Transactions:** A Boolean flag that indicates whether the transaction manager will perform a distributed transaction with an OleTx participant that is located on a remote machine. If the Allow Network Access flag is set to false, this flag MUST be ignored.
 - **Allow Inbound Transactions:** A Boolean flag that indicates whether the transaction manager will act as subordinate to a superior transaction manager facet that is located on a remote machine. If either the Allow Network Access flag or the Allow Network Transactions flags are set to false, this flag MUST be ignored.
 - **Allow Outbound Transactions:** A Boolean flag that indicates whether the transaction manager will act as superior to a subordinate transaction manager facet that is located on a remote machine. If either the Allow Network Access flag or the Allow Network Transactions flag is set to false, this flag MUST be ignored.

- **Allow Remote Administration:** A Boolean flag that indicates whether the transaction manager will be administered by an application that is located on a remote machine. If the Allow Network Access flag is set to false, this flag MUST be ignored.
- **Allow Remote Clients:** A Boolean flag that indicates whether the transaction manager will communicate with an application or a resource manager that is located on a remote machine. If the Allow Network Access flag is set to false, this flag MUST be ignored.
- **Allow TIP:** A Boolean flag that indicates whether the transaction manager has enabled the TIP protocol, as specified in [RFC2371]. For information on the transaction manager's interaction with [RFC2371], see [MS-DTCM]. If the Allow Network Access flag is set to false, this flag MUST be ignored.
- **Allow XA:** A Boolean flag that indicates whether the transaction manager provides support for the [C193] protocol in an implementation-specific manner.
- **Allow LUTransactions:** A Boolean flag that indicates whether the transaction manager provides support for the MSDTC Connection Manager: OleTx Transaction Protocol Logical Unit Mainframe Extension protocol, as specified in [MS-DTCLU]. A value of TRUE indicates the transaction manager accepts the connection type supported in the MSDTC Connection Manager: OleTx Transaction Protocol Logical Unit Mainframe Extension protocol. A value of FALSE indicates the transaction manager will refuse to accept incoming connections for the connection type supported in the MSDTC Connection Manager: OleTx Transaction Protocol Logical Unit Mainframe Extension protocol. If either the **Allow Network Access** flag or the **Allow Remote Clients** flag is set to FALSE, the transaction manager MUST ignore this flag and MUST refuse to accept incoming connections from remote machines for the connection type supported in the MSDTC Connection Manager: OleTx Transaction Protocol Logical Unit Mainframe Extension protocol.

The Core Transaction Manager Facet MUST extend the definition of a transaction object to include the following data elements:

- **Superior Enlistment:** A reference to an Enlistment object that belongs to either the subordinate transaction manager facet or the transaction manager communicating with an application facet, as specified in 3.1.1.
- **Next Phase Zero Wave Enlistment list:** A list of Enlistment objects that represent the enlistment set of Phase Zero that belongs to the next Phase Zero wave of the transaction.
- **Phase Zero Enlistment list:** A list of Enlistment objects that represent the enlistment set of Phase Zero that belongs to the current Phase Zero wave of the transaction.
- **Phase One Enlistment list:** A list of Enlistment objects that represent the set of Phase One enlistments currently registered on the transaction.
- **Phase One Voter Enlistment list:** A list of Enlistment objects that represent the set of voter enlistments currently registered on the transaction.
- **Phase Two Enlistment list:** A list of Enlistment objects that represent the set of Phase One enlistments who voted Prepared when asked to vote on the outcome of the transaction.
- **Phase Two Voter Enlistment list:** A list of Enlistment objects that represent the set of voter enlistments who voted Prepared when asked to vote on the outcome of the transaction.
- **Root:** A flag set to true if the Core Transaction Manager Facet is the root of the transaction; otherwise, false.
- **Doomed:** A flag set to true if the transaction has been aborted; otherwise, false.

- **Attributes Set:** A flag set to true when the transaction attributes are updated by using the Set Transaction Attributes event.
- **Phase Zero Registered:** A flag set to true if the transaction has successfully registered for the next Phase Zero wave; otherwise, false.
- **Single Phase Commit:** A flag set to true if the Core Transaction Manager Facet was requested to perform a Single Phase Commit on the transaction; otherwise, false.
- **State:** A State enumeration that represents the current state of the transaction. These states are as specified in section 3.2.1.3.
- **Isolation Level:** An Isolation Level value.
- **Isolation Flags:** An Isolation Flags value.
- **Description:** An implementation-specific description string that is provided to the core transaction manager when the transaction is created.
- **Timeout:** A 32-bit unsigned integer that represents the number of milliseconds after which a root transaction MUST time out if an outcome is not reached. This value MUST be used to initialize the Transaction Timeout Timer (section 3.2.2.1).
- **GRFRM:** A 32-bit unsigned integer that contains an implementation-defined value, as defined in section 2.2.7.1.

The Core Transaction Manager Facet MUST extend the definition of a connection object, as specified in [MS-CMP] section 3.1.1.1, to include the following data element:

- **Enlistment:** A reference to the Enlistment object that is associated with the connection. Some connections do not use this field.

3.2.1.1 Versioning

The core transaction manager MUST maintain the data that pertains to the extended whereabouts functionality only on versions where the connection type CONNTYPE_TXUSER_EXTENDEDWHEREABOUTS is supported as specified in section 2.2.1.1.1. The following data elements, as specified in section 3.2.1, are affected:

- Extended Whereabouts
- Extended Whereabouts Size
- Extended Whereabouts Protocol Count
- Extended Whereabouts data structures that are provided by protocol extension objects:
 - Whereabouts
 - Whereabouts Size

The core transaction manager MUST maintain the data that pertains to the Phase Zero functionality only on versions where the connection type CONNTYPE_TXUSER_PHASE0 is supported as specified in section 2.2.1.1.3. The following data elements, as specified in 3.2.1, are affected:

- Next Phase Zero Wave Enlistment list
- Phase Zero Enlistment list
- Phase Zero Registered

3.2.1.2 Transaction Logging

When a transaction object is stored in the **Core Transaction Manager Facet.Durable Log** of the Core Transaction Manager Facet, the Core Transaction Manager Facet MUST record only the following fields:

- The **Transaction Object.Identifier** field.
- The **State** field. When a transaction object is stored in the **Core Transaction Manager Facet.Durable Log**, this field MUST be set to one of the following two states:
 - In Doubt
 - Failed to Notify
- The Phase Two Enlistment list.
- If the **State** field of the transaction is set to In Doubt, the **Superior Enlistment** field MUST be stored.

When an Enlistment object is stored in the **Core Transaction Manager Facet.Durable Log** of the Core Transaction Manager Facet, the Core Transaction Manager Facet MUST record all the object fields.

When a connection object is stored in the **Core Transaction Manager Facet.Durable Log** of the Core Transaction Manager Facet, the Core Transaction Manager Facet MUST record all the object fields.

When a connection object is retrieved from the **Core Transaction Manager Facet.Durable Log** of the Core Transaction Manager Facet, its state MUST be set to Ended.

3.2.1.3 Transaction States

The state field of the transaction object MUST represent the set of different states to which the logical state machine of the transaction MUST be set.

The transaction state machine MUST support the following states:

- Idle
- Active
- Phase Zero
- Phase Zero Complete
- Voting
- Voting Complete
- Phase One
- Phase One Complete
- Single Phase Commit
- Committing
- Aborting
- In Doubt

- Failed to Notify
- Ended

The following diagram reflects states and the events that directly change them. The transaction manager and the transaction can receive more events than those shown, but those events do not affect the state of the transaction.

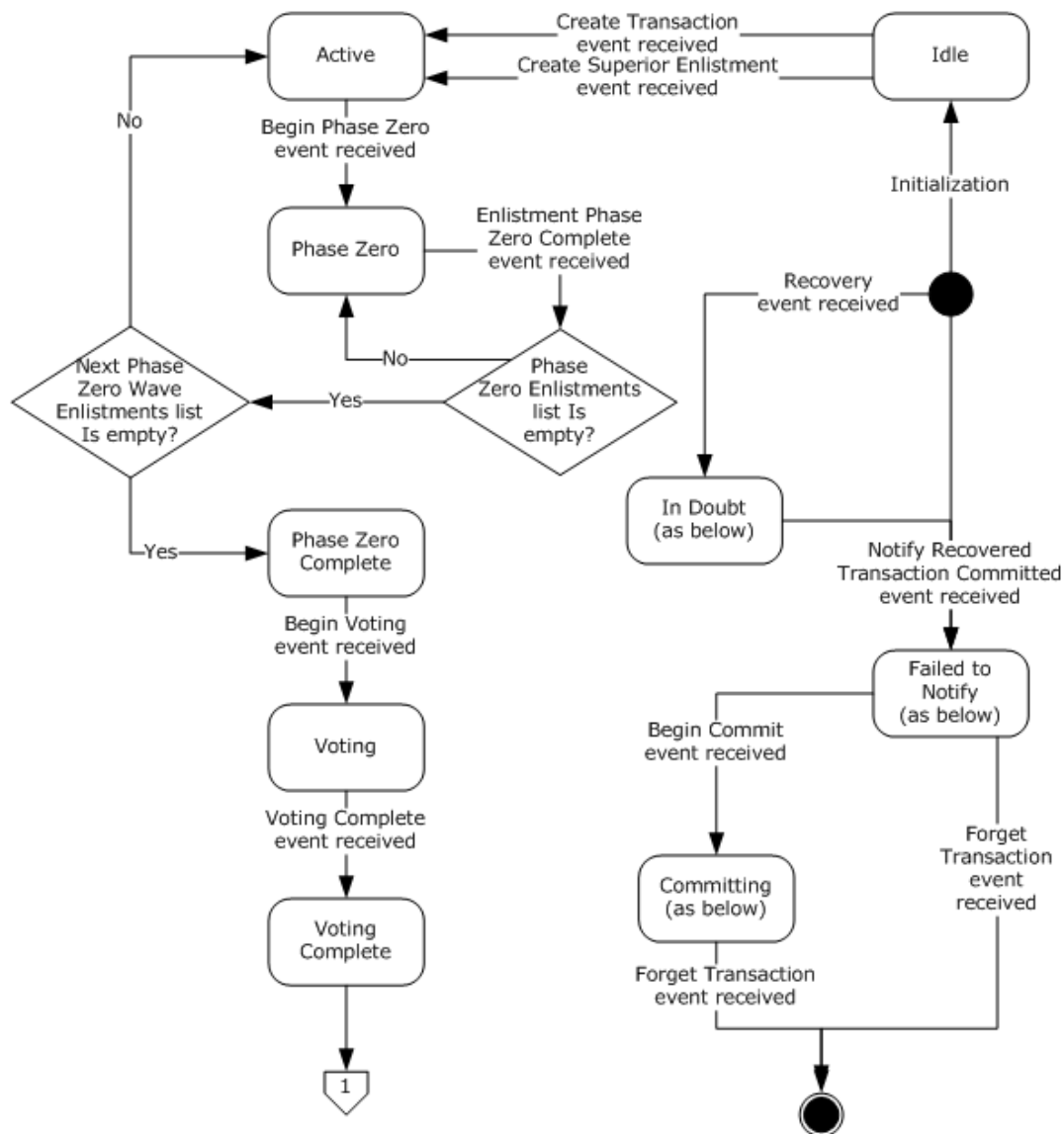

Figure 12: Transaction manager states and events (Phase Zero)

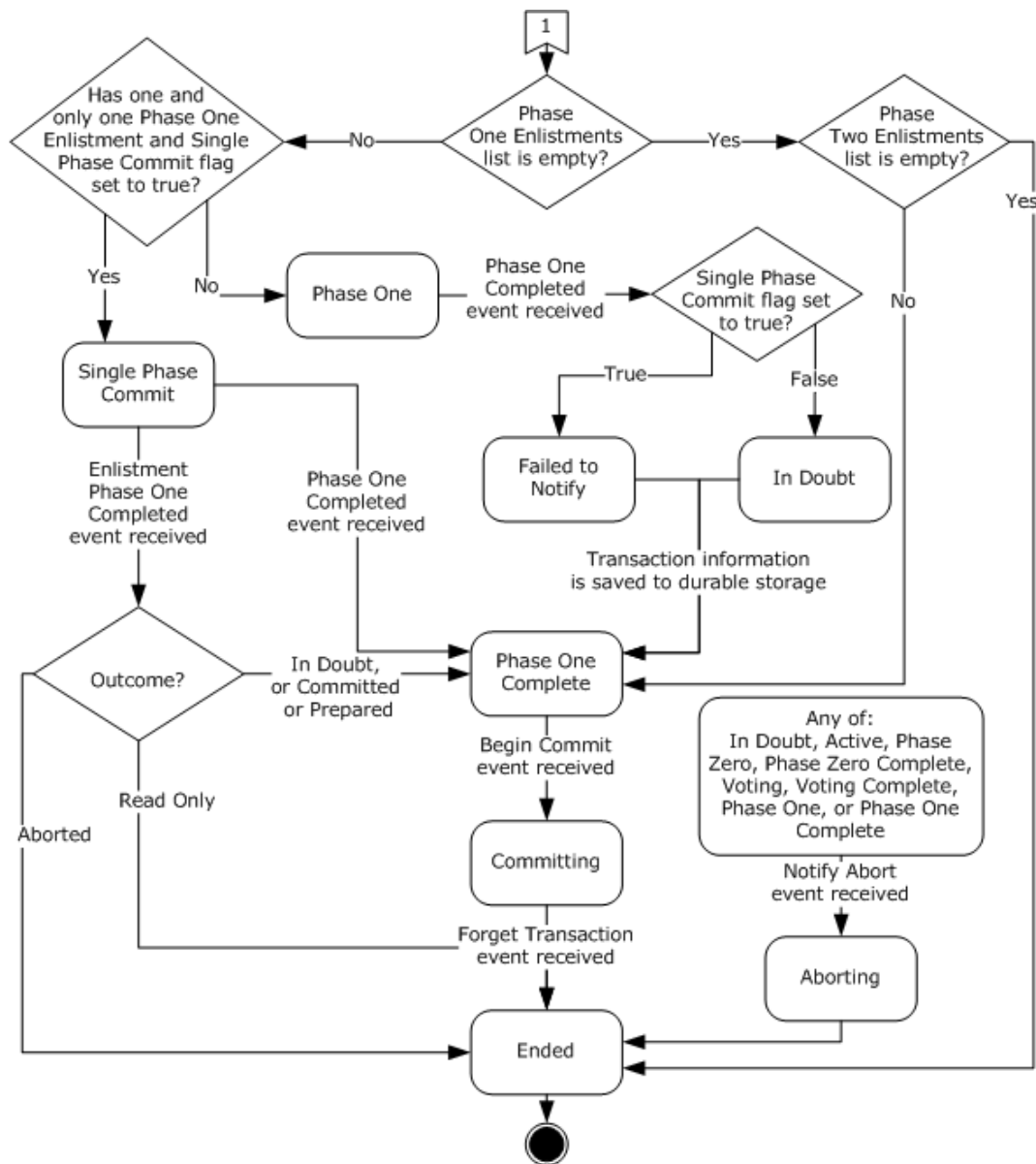

Figure 13: Transaction manager states and events (Phase One)

3.2.1.3.1 Idle

This is the initial state. The following events are processed in the Idle state:

- Create Transaction
- Create Superior Enlistment
- Associate Transaction
- Branch Transaction Success
- Branch Transaction Failure

3.2.1.3.2 Active

The following events are processed in the Active state:

- Create Phase Zero Enlistment
- Create Voter Enlistment
- Create Subordinate Enlistment
- Register Phase Zero Success
- Register Phase Zero Failure
- Export Transaction
- Set Transaction Attributes
- Set Transaction Timeout
- Begin Phase Zero
- Enlistment Unilaterally Aborted
- Notify Aborted
- Unenlist Phase Zero Enlistment
- Transaction Timeout Timer

3.2.1.3.3 Phase Zero

The following events are processed in the Phase Zero state:

- Create Phase Zero Enlistment
- Create Voter Enlistment
- Create Subordinate Enlistment
- Register Phase Zero Success
- Register Phase Zero Failure
- Export Transaction
- Set Transaction Timeout
- Enlistment Phase Zero Complete
- Enlistment Unilaterally Aborted
- Notify Aborted
- Unenlist Phase Zero Enlistment
- Transaction Timeout Timer

3.2.1.3.4 Phase Zero Complete

The following events are processed in the Phase Zero Complete state:

- Create Phase Zero Enlistment

- Create Voter Enlistment
- Create Subordinate Enlistment
- Register Phase Zero Success
- Register Phase Zero Failure
- Export Transaction
- Set Transaction Timeout
- Begin Phase One
- Begin Voting
- Enlistment Unilaterally Aborted
- Notify Aborted
- Transaction Timeout Timer

3.2.1.3.5 Voting

The following events are processed in the Voting state:

- Set Transaction Timeout
- Enlistment Vote Complete
- Voting Complete
- Enlistment Unilaterally Aborted
- Notify Aborted
- Transaction Timeout Timer

3.2.1.3.6 Voting Complete

The following events are processed in the Voting Complete state:

- Set Transaction Timeout
- Begin Commit
- Enlistment Unilaterally Aborted
- Notify Aborted
- Forget Transaction
- Transaction Timeout Timer

3.2.1.3.7 Phase One

The following events are processed in the Phase One state:

- Set Transaction Timeout
- Enlistment Vote Complete

- Enlistment Phase One Complete
- Enlistment Unilaterally Aborted
- Notify Aborted
- Phase One Completed
- Transaction Timeout Timer

3.2.1.3.8 Phase One Complete

The following events are processed in the Phase One Complete state:

- Begin Commit
- Begin In Doubt
- Forget Transaction

3.2.1.3.9 Single Phase Commit

The following events are processed in the Single Phase Commit state:

- Enlistment Phase One Complete
- Phase One Completed

3.2.1.3.10 Committing

The following events are processed in the Committing state:

- Begin Commit
- Enlistment Commit Complete
- Forget Transaction
- Request Transaction Outcome

3.2.1.3.11 Aborting

The following events are processed in the Aborting state:

- Begin Rollback
- Enlistment Rollback Complete
- Forget Transaction
- Request Transaction Outcome

3.2.1.3.12 In Doubt

The following events are processed in the In Doubt state:

- Notify Recovered Transaction Committed
- Forget Transaction
- Resolve Transaction

- Notify Aborted

3.2.1.3.13 Failed to Notify

The following events are processed in the Failed to Notify state:

- Begin Commit
- Notify Recovered Transaction Committed
- Forget Transaction
- Resolve Transaction
- Request Transaction Outcome

3.2.1.3.14 Ended

This is the final state. The following event is processed in the Ended state:

- Request Transaction Outcome

3.2.1.4 Transaction Manager Facets

An OleTx transaction manager is subdivided into the following transaction manager facets:

- Core Transaction Manager Facet
- Transaction Manager Communicating with an Application Facet
- Transaction manager Communicating with a Resource Manager Facet
- Superior Transaction Manager Facet
- Subordinate Transaction Manager Facet

These facets **MUST** communicate with each other by using a set of events. Each facet **MUST** define the set of events that the facet supports.

An event **MUST** consist of the following data elements:

- The name of the event
- The list of arguments with which the event **MUST** be signaled

This protocol assumes the existence of an implementation-specific communication mechanism used to signal events between facets inside a transaction manager. This communication mechanism **MUST NOT** allow man-in-the-middle or other classes of intermediary attacks.

Each facet **MUST** provide a definition for the **Name** and **Enlistment Object.Identifier** fields of an Enlistment object, as specified in section 3.1.1.

The conceptual model that is described here requires that one and only one thread of operation be active inside the facets that make up the transaction manager.

3.2.1.5 Protocol Extension Objects

A protocol extension is an implementation-specific module that represents the ability to perform transaction processing by using a transaction coordination protocol that is not OleTx.

Protocol extension objects MUST leverage the following vendor extensibility points in the Core Transaction Manager Facet:

- The ability to augment the list of transaction manager facets, as specified in section 3.2.1.4, to include additional protocol-specific facets
- The ability to define custom behavior for the **Name** and **Property** fields on Enlistment objects that are created inside these facets
- The ability to contribute whereabouts information to the **extended whereabouts** field of the core transaction manager
- The ability to contribute recovery information to Enlistment objects that are stored in the durable log, as specified in section 3.1.1

A protocol extension object MUST provide the following data structures:

- **Identifier**: A GUID that uniquely identifies the protocol extension
- **Whereabouts**: An array of bytes that represents the protocol extension
- **Whereabouts Size**: The size of the Whereabouts array

3.2.2 Timers

The Core Transaction Manager Facet MUST provide a Transaction Timeout Timer.

3.2.2.1 Transaction Timeout Timer

This timer MUST be set when a new transaction is created. It MUST be canceled when a transaction enters one of the following states:

- Phase One Complete
- Single Phase Commit
- Committing
- Aborting
- Ended

The default value is specified by the **Timeout** field on the transaction object for which the instance of the timer is set. The minimum value of the timer MUST be zero, which means that the timer never generates a timer event.

When the timer is initialized, the initialization MUST provide a transaction object to associate with the timer. When the timer expires, the same transaction object MUST be provided alongside the timer notification. The Core Transaction Manager Facet MUST provide a distinct Transaction Timeout Timer instance for each active transaction. If an implementation sets the value of the timeout timer associated with a transaction object to zero, the Transaction Timeout Timer event (see 3.2.6.1) is never signaled, and therefore the transaction never times out. Examples of negative consequences of transactions that do not time out include resource availability and deadlocks between resources. In the availability example, if an application starts a transaction and accesses a resource, that resource typically blocks access to the specific item until the transaction completes in order to provide isolation. But if the application has an issue and does not complete the transaction within a reasonable amount of time, other applications are prevented from accessing the resource item. In the deadlock example, two resources are accessed by two different applications, but in reverse order. This results in the two applications blocking each other because each has its own transaction that holds a lock that the other

needs to proceed. When transaction timeout values are implemented, these error scenarios resolve themselves by forcing the transactions to rollback after the specified timer period.

3.2.3 Initialization

When the Core Transaction Manager Facet is initialized:

- The MSDTC Connection Manager: OleTx Management Protocol [MS-CMOM] uses the registry to persistently store and retrieve the values for the security settings using Windows Remote Registry Protocol [MS-RRP] and Failover Cluster: Management API (ClusAPI) Protocol [MS-CMRP]. The registry is shared with the MSDTC Connection Manager: OleTx Management Protocol [MS-CMOM].
- The **Security Level** field is loaded directly from the registry key defined in [MS-CMOM] section 3.3.1.2.3.<25>
- The following security flags are loaded directly from the registry keys defined in [MS-CMOM] sections 3.3.1.2.1 and 3.3.1.2.2.
 - **Allow Network Access**
 - **Allow Network Transactions**
 - **Allow Inbound Transactions**
 - **Allow Outbound Transactions**
 - **Allow Remote Administration**
 - **Allow Remote Clients**
 - **Allow TIP**
 - **Allow XA**
 - **Allow LUTransactions**
- The lower-layer transport protocol, the MSDTC Connection Manager: OleTx Multiplexing Protocol (section 2.1) MUST be initialized as specified in [MS-CMP] section 3.1.3, by passing the following parameter values as specified in section 2.1.2. The MSDTC Connection Manager: OleTx Multiplexing Protocol initialization as specified in [MS-CMP] section 3.1.3, initializes the MSDTC Connection Manager: OleTx Transports Protocol layer with additional parameters as specified in [MS-CMPO] section 3.2.3.
 - The **Security Level** field ([MS-CMPO] Local Partner State (section 3.2.1.1)) is initialized with the **Security Level** value in Core Transaction Manager Facet.
 - The **Minimum Level 3 Version Number** and **Maximum Level 3 Version Number** fields ([MS-CMPO] section 3.2.1.1) are initialized with the computed minimum and maximum protocol version values, as specified in section 3.1.4.2.
 - Compute a local name object by initializing the fields of the Name object (see [MS-CMPO] section 3.2.1.4) with following values:
 - **HostName**: The **HostName** field is initialized with the value of the **ComputerName.NetBIOS** element of the machine as specified in [MS-WKST] section 3.2.1.2.
 - **CID**: The CID field is initialized as follows:

- Read the string value from the <MSDTC_GUID> registry key as specified in [MS-CMOM] section 2.2.3.5, for the Description\Default value of "MSDTC" as specified in [MS-CMOM] section 2.2.3.5.1.
- Convert the <MSTDC_GUID> string to GUID as specified in [C706] Appendix A.
- **Protocols:**
 - If the Allow Network Access flag is set to false:
 - The **Protocols** field is initialized to PROT_LRPC flag as described in [MS-CMPO] (section 2.2.4).
 - Otherwise:
 - The **Protocols** field is initialized directly from the "ServiceNetworkProtocols" registry key as specified in [MS-CMOM] section 2.2.3.4.
- The computed local name object is used to initialize the **Local Name Object** field ([MS-CMPO] section 3.2.1.1).
- The protocol extension list MUST be populated with instances that are obtained from an implementation-specific source.
- If the protocol extension list is not empty, the Core Transaction Manager Facet MUST perform the following actions:
 - Query each protocol extension for its extended whereabouts information by using the **Whereabouts** and **Whereabouts Size** fields of the object.
 - Create an array of STmToTmProtocol (section 2.2.5.9) structures and assign it to the **Extended Whereabouts** field of the Core Transaction Manager Facet:
 - The array MUST contain an entry for each protocol extension that contributes extended whereabouts information.
 - The **tmprotDescribed** field of each entry MUST be set to TmProtocolExtended, as specified in section 2.2.6.2.
 - The **rgbTmProtocolData** field of each entry MUST contain an SExtendedEndpointInfo (section 2.2.5.8) structure.
 - The **cbTmProtocolData** field of each entry MUST be set to the length, in bytes, of the **rgbTmProtocolData** field.
 - Assign the size, in bytes, of the STmToTmProtocol array to the **Extended Whereabouts Size** field of the Core Transaction Manager Facet.
 - Assign the number of protocol extensions that contribute extended whereabouts information to the STmToTmProtocol array to the **Extended Whereabouts Protocol Count** field of the Core Transaction Manager Facet.

3.2.3.1 Transaction Object Initialization

The Core Transaction Manager Facet MUST initialize each new transaction object that is created by the facet with the following default values:

- The **Root** field MUST default to false.
- The **Doomed** field MUST default to false.

- The **Attributes Set** field MUST default to false.
- The **Phase Zero Registered** field MUST be set to false.
- The **Single Phase Commit** field MUST default to false.
- The **State** field MUST default to Idle.
- The **Isolation Level** field MUST default to Serializable.
- The **Isolation Flags** field MUST default to zero.
- The **Description** field MUST default to an empty string.
- The **GRFRM** field MUST default to zero.
- The **Timeout** field value MUST default to a value that is obtained in an implementation-specific manner.

3.2.3.2 Durable Log

The **Core Transaction Manager Facet.Durable Log** size is configurable and is stored in the registry. On Windows, it is configured in an implementation-specific manner.

3.2.3.3 Transaction Recovery

If the **Core Transaction Manager Facet.Durable Log** of the Core Transaction Manager Facet is not empty, it MUST perform the following actions:

- For each transaction object in the **Core Transaction Manager Facet.Durable Log** of the Core Transaction Manager Facet:
 - Initialize the transaction object fields which are not durably stored with default values, as specified in Transaction Object Initialization (section 3.2.3.1).
 - Copy the transaction object to the transaction table of the Core Transaction Manager Facet.
- After all transactions in the **Core Transaction Manager Facet.Durable Log** are copied to the transaction table, start accepting new connections.
- For each transaction object in the transaction table of the Core Transaction Manager Facet:
 - If the transaction state is In Doubt (section 3.2.1.3.12):
 - Signal the Recover In Doubt Transaction (section 3.8.7.8) event on the transaction manager facet that is referenced by the transaction object's **Superior Enlistment** field with the value of the transaction object's **Superior Enlistment** field.
 - Otherwise:
 - Signal the Notify Recovered Transaction Committed (section 3.2.7.24) event on the Core Transaction Manager Facet with the transaction object.

3.2.4 Higher-Layer Triggered Events

None.

3.2.5 Processing Events and Sequencing Rules

3.2.6 Timer Events

3.2.6.1 Transaction Timeout Timer

When this timer expires, the core transaction manager MUST perform the following actions:

- If the provided transaction object is in one of the following states, the core transaction manager MUST ignore the timer event:
 - Phase One Complete
 - Single Phase Commit
 - Committing
 - Aborting
 - In Doubt
 - Failed to Notify
 - Ended
- Otherwise, the core transaction manager MUST:
 - Signal the Unilaterally Aborted event on the transaction's superior enlistment's transaction manager facet with the Superior Enlistment object of the transaction.
 - Signal the Notify Aborted event on the Core Transaction Manager Facet using the provided transaction object.

3.2.7 Other Local Events

The core transaction manager MUST be prepared to process the local events that are defined in the following sections.

If the Core Transaction Manager Facet supports the CONNTYPE_TXUSER_PHASE0 connection type, this facet MUST be prepared to process local events that pertain to Phase Zero functionality. The following local events are affected:

- Create Phase Zero Enlistment
- Register Phase Zero Success
- Register Phase Zero Failure
- Begin Phase Zero
- Enlistment Phase Zero Complete
- Unenlist Phase Zero Enlistment

3.2.7.1 Associate Transaction

The Associate Transaction event MUST be signaled with the following arguments:

- A transaction object

- A Name object representing the remote superior transaction manager

If the Associate Transaction event is signaled, the Core Transaction Manager Facet (section 1.3.3.3.1) MUST perform the following actions:

- If the **Core Transaction Manager Facet.Durable Log** is too full (section 3.2.3.2) to accept the provided transaction object:
 - Signal the Associate Transaction Failure (section 3.4.7.1) event on the Transaction Manager Communicating with an Application Facet (section 1.3.3.3.2) with the following arguments:
 - The provided transaction object
 - The Log Full Local reason code
- Otherwise:
 - Signal the Branch Transaction (section 3.8.7.1) event on the Subordinate Transaction Manager Facet (section 1.3.3.3.5) with the following arguments:
 - The provided transaction object
 - The provided Name object

3.2.7.2 Begin Commit

The Begin Commit event MUST be signaled with the following arguments:

- A transaction object

If the Begin Commit event is signaled, the Core Transaction Manager Facet MUST perform the following actions:

- Set the transaction state to Committing (section 3.2.1.3.10).
- If the **Phase Two Voter Enlistment list** of the transaction is not empty:
 - For each Enlistment object in the **Phase Two Voter Enlistment list** of the transaction:
 - Remove the Enlistment object from the **Phase Two Voter Enlistment list** of the transaction.
 - Signal the Begin Commit event (see sections 3.4.7.3, 3.6.7.1, and 3.7.7.1) on the enlistment's transaction manager facet field with the Enlistment object.
- If the **Phase Two Enlistment list** of the transaction is not empty:
 - For each Enlistment object in the **Phase Two Enlistment list** of the transaction:
 - Signal the Begin Commit event (see sections 3.4.7.3, 3.6.7.1, and 3.7.7.1) on the enlistment's transaction manager facet field with the Enlistment object.
- Otherwise, if the **Phase Two Enlistment list** of the transaction is empty:
 - Signal the Commit Complete (section 3.8.7.3) event on the transaction's superior enlistment's transaction manager facet with the transaction's Superior Enlistment object.
 - Signal the Forget Transaction (section 3.2.7.22) event on the Core Transaction Manager Facet with the provided transaction object.

3.2.7.3 Begin In Doubt

The Begin In Doubt event MUST be signaled with the following arguments:

- A transaction object

If the Begin In Doubt event is signaled, the Core Transaction Manager Facet MUST perform the following actions:

- For each Enlistment object in the Phase Two Voter Enlistment list of the transaction:
 - Signal the Begin In Doubt event (see sections 3.4.7.4 and 3.6.7.2) on the Enlistment object's transaction manager facet with the Enlistment object.
- Signal the Forget Transaction (section 3.2.7.22) event on the Core Transaction Manager Facet with the provided transaction object.

3.2.7.4 Begin Phase One

The Begin Phase One event MUST be signaled with the following arguments:

- A transaction object
- A flag indicating whether the transaction SHOULD or MUST NOT attempt to perform a single-phase commit

If the Begin Phase One event is signaled, the Core Transaction Manager Facet MUST perform the following actions:

- Set the **Single Phase Commit** field of the transaction to the value of the provided Single Phase Commit flag (defined in section 3.2.1).
- Signal the Begin Voting (section 3.2.7.7) event on the Core Transaction Manager Facet with the following argument:
 - The provided transaction object

3.2.7.5 Begin Phase Zero

The Begin Phase Zero event MUST be signaled with the following arguments:

- A transaction object

If the Begin Phase Zero event is signaled, the Core Transaction Manager Facet MUST perform the following actions:

- Set the transaction state to Phase Zero (section 3.2.1.3.3).
- Move each Enlistment object in the Next Phase Zero Wave Enlistment list of the transaction to the Phase Zero Enlistment list of the transaction.
- Set the Phase Zero Registered flag of the transaction object to false.
- If the Phase Zero Enlistment list of the transaction is not empty:
 - For each Enlistment object in the Phase Zero Enlistment list of the transaction:
 - Signal the Begin Phase Zero event (see sections 3.6.7.4 and 3.7.7.3) on the Enlistment object's transaction manager facet with the Enlistment object.
- Otherwise:

- Set the transaction state to Phase Zero Complete (section 3.2.1.3.4).
- Signal the Phase Zero Complete event (see sections 3.4.7.14 and 3.8.7.6) on the superior enlistment's transaction manager facet of the transaction with the following arguments:
 - The superior enlistment object of the transaction
 - The success outcome

3.2.7.6 Begin Rollback

The Begin Rollback event MUST be signaled with the following arguments:

- A transaction object.

If the Begin Rollback event is signaled, the Core Transaction Manager Facet (section 1.3.3.3.1) MUST perform the following actions:

- Signal the Rollback Complete event (see sections 3.4.7.18 and 3.8.7.10) on the transaction's superior enlistment's transaction manager facet with the superior enlistment object of the transaction.
- Signal the Notify Aborted (section 3.2.7.23) event on the Core Transaction Manager Facet with the provided transaction object.

3.2.7.7 Begin Voting

The Begin Voting event MUST be signaled with the following arguments:

- A transaction object

If the Begin Voting event is signaled, the Core Transaction Manager Facet (section 1.3.3.3.1) MUST perform the following actions:

- Set the transaction state to Voting (section 3.2.1.3.5).
- If the Phase One (section 1.3.1.2) Voter Enlistment list of the transaction is empty:
 - Signal the Voting Complete (section 3.2.7.35) event on the Core Transaction Manager Facet (section 1.3.3.3.1) with the provided transaction object.
- Otherwise:
 - For each Enlistment object in the Phase One (section 1.3.1.2) Voter Enlistment list of the transaction:
 - Signal the Begin Voting event (see sections 3.4.7.6 and 3.6.7.6) on the enlistment's transaction manager facet field with the Enlistment object.
 - If the Phase One (section 1.3.1.2) Enlistment list of the transaction contains more than one element, or if it contains one element and the Single Phase Commit flag (defined in section 3.2.1) of the transaction is set to false:
 - For each Enlistment object in the Phase One (section 1.3.1.2) Enlistment list of the transaction:
 - Signal the Begin Phase One (see section 3.6.7.3 and section 3.7.7.2) event on the enlistment's transaction manager facet field with the following argument:
 - The Enlistment object

- The Single Phase Commit flag set to false

3.2.7.8 Branch Transaction Failure

The Branch Transaction Failure event MUST be signaled with the following arguments:

- An Enlistment object
- A value indicating the failure reason. The reason MUST be set to one of the following values:
 - Log Full Remote
 - No Mem Remote
 - Too Late
 - Too Many Remote
 - Tx Not Found
 - Comm Failed

If the Branch Transaction Failure (section 3.2.7.8) event is signaled, the Core Transaction Manager Facet (section 1.3.3.3.1) MUST perform the following actions:

- Signal the Associate Transaction Failure (section 3.4.7.1) event on the transaction manager communicating with an application facet with the following arguments:
 - The provided transaction object
 - The provided reason code

3.2.7.9 Branch Transaction Success

The Branch Transaction Success event MUST be signaled with the following arguments:

- An Enlistment object.

If the Branch Transaction Success event is signaled, the Core Transaction Manager Facet (section 1.3.3.3.1) MUST perform the following actions:

- Add the transaction object of the enlistment to the transaction table of the Core Transaction Manager Facet (section 1.3.3.3.1).
- Set the superior enlistment of the transaction to the provided Enlistment object.
- Signal the Associate Transaction Success (section 3.4.7.2) event on the transaction manager communicating with an application facet with the transaction object of the enlistment.

3.2.7.10 Create Phase Zero Enlistment

The Create Phase Zero Enlistment event MUST be signaled with the following arguments:

- An Enlistment object

If the Create Phase Zero Enlistment event is signaled, the Core Transaction Manager Facet (section 1.3.3.3.1) MUST perform the following actions:

- If the transaction state of the transaction object referenced by the provided enlistment object is Phase Zero (section 3.2.1.3.3):

- The Core Transaction Manager Facet (section 1.3.3.3.1) MUST:
 - Signal the Create Phase Zero Enlistment Success (see section 3.6.7.8 and section 3.7.7.6) event on the Enlistment object's transaction manager facet with the provided Enlistment object.
 - Signal the Begin Phase Zero (see section 3.6.7.4 and section 3.7.7.3) event on the provided Enlistment object's transaction manager facet with the provided Enlistment object.
- Otherwise, if the transaction state is Active (section 3.2.1.3.2) or Phase Zero Complete (section 3.2.1.3.4):
 - If the Next Phase Zero Wave Enlistment list of the transaction is empty:
 - Signal the Register Phase Zero (section 3.4.7.15) event on the transaction's superior enlistment's transaction manager facet with the transaction's superior Enlistment object.
 - Otherwise, if the list is nonempty and the Phase Zero Registered flag of the transaction is true:
 - Signal the Create Phase Zero Enlistment Success (see section 3.6.7.8 and section 3.7.7.6) event on the enlistment object's transaction manager facet with the Enlistment object.
 - Add the provided enlistment to the Next Phase Zero Wave Enlistment list of the transaction.
- Otherwise:
 - Signal the Create Phase Zero Enlistment Failure (see section 3.6.7.7 and section 3.7.7.5) event on the Enlistment object's transaction manager facet field with the following arguments:
 - The provided Enlistment object
 - The Too Late reason code

3.2.7.11 Create Subordinate Enlistment

The Create Subordinate Enlistment event MUST be signaled with the following arguments:

- An Enlistment object

If the Create Subordinate Enlistment event is signaled, the Core Transaction Manager Facet MUST perform the following actions:

- If the state of the transaction object referenced by the provided Enlistment object is not Active (section 3.2.1.3.2) and not Phase Zero (section 3.2.1.3.3) and not Phase Zero Complete (section 3.2.1.3.4):
 - Signal the Create Subordinate Enlistment Failure (see sections 3.6.7.10 and 3.7.7.7) event on the Enlistment object's transaction manager facet with the following arguments:
 - The provided Enlistment object
 - The Too Late reason code
- Otherwise, if the **Core Transaction Manager Facet.Durable Log** is too full to accept the transaction object referenced by the provided Enlistment object:
 - Signal the Create Subordinate Enlistment Failure (see sections 3.6.7.10 and 3.7.7.7) event on the Enlistment object's transaction manager facet with the following arguments:

- The provided Enlistment object
- The Log Full reason code
- Otherwise, compute the number of Enlistment objects in the **Phase One Enlistment list** of the transaction object referenced by the provided Enlistment object whose **Transaction Manager Facet** field is set to **Superior Transaction Manager Facet** (section 3.2.1.4).
- If this computed number of Enlistment objects is greater than or equal to an implementation-specific value that indicates the maximum allowed Transaction Manager Enlistments: <29>
 - Signal the Create Subordinate Enlistment Failure (see sections 3.6.7.10 and 3.7.7.7) event on the Enlistment object's transaction manager facet with the following arguments:
 - The provided Enlistment object
 - The Too Many reason code
- Otherwise:
 - Add the provided Enlistment object to the transaction's Phase One Enlistment list.
 - Signal the Create Subordinate Enlistment Success (see sections 3.6.7.11 and 3.7.7.8) event on the Enlistment object's transaction manager facet with the provided Enlistment object.

3.2.7.12 Create Superior Enlistment

The Create Superior Enlistment event MUST be signaled with the following arguments:

- An Enlistment object

If the Create Superior Enlistment event is signaled, the Core Transaction Manager MUST perform the following actions:

- If the transaction referenced by the provided Enlistment object already exists in the transaction table:
 - Signal the Create Superior Enlistment Failure (section 3.8.7.5) event on the Transaction Manager facet referenced by the provided Enlistment object with the following arguments:
 - The provided Enlistment object
 - The Duplicate reason code
- Otherwise, if the **Core Transaction Manager Facet.Durable Log** is too full (section 3.2.3.2) to accept the transaction object referenced by the provided Enlistment object:
 - Signal the Create Superior Enlistment Failure (section 3.8.7.5) event on the Enlistment object's transaction manager facet with the following arguments:
 - The provided Enlistment object
 - The Log Full reason code
- Otherwise:
 - Add the transaction object referenced by the provided Enlistment object to the transaction table, using the **Transaction Object.Identifier** field of the transaction object as the key.
 - Set the transaction's Superior Enlistment field to the provided Enlistment object.

- Set transaction state to Active.
- Set the transaction's Root flag to false.
- Signal the Create Superior Enlistment Success (section 3.8.7.4) event on the transaction manager facet referenced by the provided Enlistment object with the provided Enlistment object.

3.2.7.13 Create Transaction

The Create Transaction event MUST be signaled with the following arguments:

- An Enlistment object

If the Create Transaction event is signaled, the Core Transaction Manager MUST perform the following actions:

- The Core Transaction Manager MUST:
 - Look for an existing entry in the transaction table, using the **Transaction Object.Identifier** field of the transaction object referenced by the provided Enlistment object as the key. <30>
 - If an entry exists:
 - Signal the Create Transaction Failure (section 3.4.7.7) event on the Transaction Manager facet referenced by the provided Enlistment object with the following arguments:
 - The provided transaction object
 - The Duplicate reason code
 - Cease processing the event
 - If the Core Transaction Manager does not have sufficient memory available to process the Create Transaction event:
 - Signal the Create Transaction Failure (section 3.4.7.7) event on the Transaction Manager facet referenced by the provided Enlistment object with the following arguments:
 - The provided transaction object
 - The No Mem reason code
 - Cease processing the event.
 - If the **Core Transaction Manager Facet.Durable Log** is too full (section 3.2.3.2) to accept a new transaction:
 - Signal the Create Transaction Failure (section 3.4.7.7) event on the Transaction Manager facet referenced by the provided Enlistment object with the following arguments:
 - The provided transaction object
 - The Log Full reason code
 - Cease processing the event.
- Add the transaction object referenced by the provided Enlistment object to the transaction table, by using the **Transaction Object.Identifier** field of the transaction object as the key.
- Set the transaction's Superior Enlistment to the provided Enlistment object.

- Set the transaction's Root flag to true.
- Set the transaction's state to Active.
- Initialize the transaction Timeout timer with the following arguments:
 - The transaction object
 - The transaction object's Timeout value
- Signal the Create Transaction Success (section 3.4.7.8) event on the Transaction Manager facet referenced by the provided enlistment with the transaction object referenced by the provided Enlistment object.

3.2.7.14 Create Voter Enlistment

The Create Voter Enlistment event MUST be signaled with the following arguments:

- An Enlistment object

If the Create Voter Enlistment event is signaled, the Core Transaction Manager Facet (section 1.3.3.3.1) MUST perform the following actions:

- If the state of the transaction object referenced by the provided Enlistment object is not Active (section 3.2.1.3.2) and not Phase Zero (section 3.2.1.3.3) and not Phase Zero Complete (section 3.2.1.3.4):
 - Signal the Create Voter Enlistment Failure (see section 3.4.7.9 and section 3.6.7.12) event on the Enlistment object's Transaction Manager facet with the following arguments:
 - The Enlistment object
 - The Too Late reason code
- Otherwise:
 - Add the provided Enlistment to the transaction's Phase One Voter Enlistment list.
 - Signal the Create Voter Enlistment Success (see section 3.4.7.10 and section 3.6.7.13) event on the Enlistment object's Transaction Manager facet with the provided Enlistment object.

3.2.7.15 Enlistment Commit Complete

The Enlistment Commit Complete event MUST be signaled with an Enlistment object.

If the Enlistment Commit Complete event is signaled, the Core Transaction Manager Facet (section 1.3.3.3.1) MUST perform the following actions:

- Remove the enlistment from the transaction's Phase Two Enlistment list.
- If the Phase Two Enlistment list of the transaction object referenced by the provided Enlistment object is now empty:
 - If the transaction's Single Phase Commit flag (defined in section 3.2.1) is false and the transaction state is not Failed to Notify (section 3.2.1.3.13):
 - Signal the Commit Complete (section 3.8.7.3) event on the transaction's Superior Enlistment's Transaction Manager facet with the transaction's Superior Enlistment object.
 - Signal the Forget Transaction (section 3.2.7.22) event on the Core Transaction Manager Facet (section 1.3.3.3.1) with the transaction object of the Enlistment.

3.2.7.16 Enlistment Phase One Complete

The Enlistment Phase One Complete event MUST be signaled with the following arguments:

- An Enlistment object.
- A value indicating the enlistment's outcome for Phase One (section 1.3.1.2). This value MUST be set to one of the following values:
 - Committed
 - Aborted
 - In Doubt
 - Read Only
 - Prepared

If the Enlistment Phase One Complete event is signaled, the Core Transaction Manager Facet (section 1.3.3.3.1) MUST perform the following actions:

- If the transaction's Doomed flag is set to true or the transaction state is Aborting (section 3.2.1.3.11), the Core Transaction Manager Facet (section 1.3.3.3.1) MUST ignore the signal.
- Otherwise:
 - Remove the enlistment from the transaction's Phase One Enlistment list.
 - If the transaction state is Single Phase Commit (section 3.2.1.3.9):
 - If the enlistment's Phase One outcome is Committed:
 - Set the transaction's state to Phase One Complete (section 3.2.1.3.8).
 - Signal the Phase One Complete (section 3.4.7.13) event on the transaction's Superior Enlistment's Transaction Manager facet with the following arguments:
 - The transaction's Superior Enlistment object
 - The Committed outcome
 - Signal the Begin Commit (section 3.2.7.2) event on the Core Transaction Manager Facet with the provided transaction object.
 - Cease processing the event.
 - Otherwise, if the Enlistment's Phase One outcome is Read Only:
 - Signal the Phase One Complete event on the Transaction Manager Facet of the transaction's Superior Enlistment with the following arguments:
 - The transaction's Superior Enlistment object
 - The Read Only outcome
 - Signal the Forget Transaction (section 3.2.7.22) event on the Core Transaction Manager Facet with the provided transaction object.
 - Otherwise, if the enlistment's Phase One outcome is In Doubt (section 3.2.1.3.12):

- Set the transaction's state to Phase One Complete.
- Signal the Phase One Complete event on the transaction's Superior Enlistment's Transaction Manager facet with the following arguments:
 - The transaction's Superior Enlistment object
 - The In Doubt outcome
- Signal the Begin In Doubt (section 3.2.7.3) event on the Core Transaction Manager Facet with the provided transaction object.
- Cease processing the event.
- If the transaction state is Phase One or Single Phase Commit:
 - If the enlistment's Phase One outcome is Aborted:
 - Set the transaction's Doomed flag to true.
 - Signal the Phase One Complete event on the transaction's Superior Enlistment's Transaction Manager facet with the following arguments:
 - The transaction's Superior Enlistment object
 - The Aborted outcome
 - Signal the Notify Aborted (section 3.2.7.23) event on the Core Transaction Manager Facet with the provided transaction object.
 - Cease processing the event.
 - Otherwise, if the Enlistment's Phase One outcome is Prepared:
 - Add the Enlistment to the transaction's Phase Two Enlistment list.
 - Set the transaction's state to Phase One Complete.
- If both the transaction's Phase One Voter Enlistment list and Phase One Enlistment list are now empty:
 - Signal the Phase One Completed (section 3.2.7.25) event on the Core Transaction Manager Facet (section 1.3.3.3.1) with the provided transaction object.

3.2.7.17 Enlistment Phase Zero Complete

The Enlistment Phase Zero Complete event MUST be signaled with the following arguments:

- An Enlistment object.
- A value indicating the enlistment's outcome for Phase Zero (section 1.3.1.1). This value MUST be set to one of the following values:
 - Completed
 - Aborted

If the Enlistment Phase Zero Complete event is signaled, the Core Transaction Manager Facet (section 1.3.3.3.1) MUST perform the following actions:

- Remove the enlistment from the transaction's Phase Zero Enlistments list.

- If the enlistment's Phase Zero outcome is Aborted:
 - Set the transaction's Doomed flag to true.
- If the transaction's Phase Zero Enlistments list is now empty:
 - Set the transaction's state to Phase Zero Complete (section 3.2.1.3.4).
 - If the transaction's Doomed flag is set to true:
 - Signal the Phase Zero Complete (section 3.8.7.6) event on the transaction's Superior Enlistment's Transaction Manager facet with the following arguments:
 - The transaction's Superior Enlistment object
 - The Failure outcome
 - Signal the Notify Aborted (section 3.2.7.23) event on the Core Transaction Manager Facet with the provided transaction object.
 - Otherwise:
 - If the transaction's Root flag is true:
 - If the transaction's Next Phase Zero Wave Enlistment list is not empty:
 - Set the transaction's State to Active (section 3.2.1.3.2).
 - Signal the Begin Phase Zero (section 3.2.7.5) event on the Core Transaction Manager Facet with the provided Enlistment's transaction object.
 - Otherwise:
 - Signal the Phase Zero Complete event on the transaction's Superior Enlistment's Transaction Manager facet with the following arguments:
 - The transaction's Superior Enlistment object
 - The Success outcome
 - Otherwise, if the transaction's Root flag is false:
 - If the transaction's Next Phase Zero Wave Enlistment list is not empty:
 - Set the transaction's state to Active.
 - Signal the Phase Zero Complete event on the transaction's Superior Enlistment's Transaction Manager facet with the following arguments:
 - The transaction's Superior Enlistment object
 - The Success outcome

3.2.7.18 Enlistment Rollback Complete

The Enlistment Rollback Complete event MUST be signaled with an Enlistment object.

If the Enlistment Rollback Complete event is signaled, the Core Transaction Manager Facet (section 1.3.3.3.1) MUST perform the following actions:

- Remove the Enlistment from the transaction's Phase Two Enlistment list.

- If the transaction's Phase Two Enlistment list is now empty:
 - Signal the Forget Transaction (section 3.2.7.22) event on the Core Transaction Manager Facet (section 1.3.3.3.1) with the Enlistment's transaction object.

3.2.7.19 Enlistment Unilaterally Aborted

The Enlistment Unilaterally Aborted event MUST be signaled with the following arguments:

- An Enlistment object

If the Enlistment Unilaterally Aborted event is signaled, the Core Transaction Manager Facet (section 1.3.3.3.1) MUST perform the following actions:

- If the transaction state is Active (section 3.2.1.3.2), Phase Zero (section 3.2.1.3.3), Phase Zero Complete (section 3.2.1.3.4), Voting (section 3.2.1.3.5), Voting Complete (section 3.2.1.3.6) or Phase One (section 3.2.1.3.7):
 - Remove the provided Enlistment object from any of the following transaction lists in which it is present:
 - Next Phase Zero Wave Enlistment list
 - Phase Zero Enlistment list
 - Phase One Enlistment list
 - Phase One Voter Enlistment list
 - If the transaction state is Phase Zero (section 3.2.1.3.3):
 - Signal the Phase Zero Complete (see sections 3.4.7.14 and 3.8.7.6) event on the transaction's Superior Enlistment's Transaction Manager Facet with the following arguments:
 - The transaction's Superior Enlistment object
 - The Failure outcome
 - Otherwise, if the transaction state is Voting (section 3.2.1.3.5) or Phase One (section 3.2.1.3.7):
 - Signal the Phase One Complete (see sections 3.4.7.13 and 3.8.7.7) event on the transaction's Superior Enlistment's Transaction Manager facet with the following arguments:
 - The transaction's Superior Enlistment object
 - The Aborted outcome
 - Otherwise:
 - Signal the Unilaterally Aborted (see sections 3.4.7.23 and 3.8.7.11) event on the transaction's Superior Enlistment's Transaction Manager facet with the transaction's Superior Enlistment object.
 - Signal the Notify Aborted (section 3.2.7.23) event on the Core Transaction Manager Facet (section 1.3.3.3.1) with the transaction object referenced by the **Transaction** field of the provided **Enlistment** object.
- Otherwise, ignore the event.

3.2.7.20 Enlistment Vote Complete

The Enlistment Vote Complete event MUST be signaled with the following arguments:

- An Enlistment object.
- A value indicating the Enlistment's vote. This value MUST be set to one of the following values:
 - Read Only
 - Prepared
 - Aborted

If the Enlistment Vote Complete event is signaled, the Core Transaction Manager Facet (section 1.3.3.3.1) MUST perform the following actions:

- If the transaction's Doomed flag is set to true, the Core Transaction Manager Facet MUST cease processing the event.
- Otherwise:
 - If the Enlistment's Vote outcome is Aborted:
 - Set the transaction's Doomed flag to true.
 - Remove the Enlistment from the transaction's Phase One (section 1.3.1.2) Voter Enlistment list.
 - Signal the Phase One Completed event (section 3.2.7.25) on the transaction's Superior Enlistment's Transaction Manager facet with the following arguments:
 - The transaction's Superior Enlistment object.
 - The Aborted outcome.
 - Signal the Notify Aborted (section 3.2.7.23) event on the Core Transaction Manager Facet (section 1.3.3.3.1) with the provided transaction object.
 - Otherwise:
 - If the enlistment's Vote outcome is Read Only:
 - Remove the Enlistment from the transaction's Phase One Voter Enlistment list.
 - Otherwise:
 - Move the Enlistment from the transaction's Phase One Voter Enlistment list to the transaction's Phase Two (section 1.3.1.3) Voter Enlistment list.
 - If the transaction's Phase One Voter Enlistment list is now empty:
 - If the transaction state is Voting (section 3.2.1.3.5):
 - Signal the Voting Complete (section 3.2.7.35) event on the Core Transaction Manager Facet (section 1.3.3.3.1) with the provided transaction object.
 - Otherwise, if the transaction state is Phase One (section 3.2.1.3.7):
 - If both the transaction's Phase One Voter Enlistment list and Phase One Enlistment list are now empty:

- Signal the Phase One Completed (section 3.2.7.25) event on the Core Transaction Manager Facet (section 1.3.3.3.1) with the provided transaction object.

3.2.7.21 Export Transaction

The Export Transaction event MUST be signaled with the following arguments:

- A transaction object
- A Name object representing the remote subordinate transaction manager

If the Export Transaction event is signaled, the Core Transaction Manager Facet (section 1.3.3.3.1) MUST perform the following actions:

- If the transaction state is not Active (section 3.2.1.3.2), or Phase Zero (section 3.2.1.3.3), or Phase Zero Complete (section 3.2.1.3.4):
 - Signal the Export Transaction Failure (section 3.4.7.11) event on the Transaction Manager communicating with an Application facet with the following arguments:
 - The provided transaction object.
 - The Too Late reason code.
- Otherwise, if the **Core Transaction Manager Facet.Durable Log** is too full (section 3.2.3.2) to accept the provided transaction object:
 - Signal the Export Transaction Failure event on the Transaction Manager Communicating with an Application facet with the following arguments:
 - The provided transaction object.
 - The Log Full reason code.
- Otherwise:
 - Compute the number of Enlistment objects in the transaction's Phase One Enlistment list whose Transaction Manager Facet field is the superior transaction manager.
 - If that number is equal to an implementation-specific value that indicates the maximum allowed Transaction Manager enlistments: <31>
 - Signal the Export Transaction Failure event on the Transaction Manager communicating with an Application facet with the following arguments:
 - The provided transaction object
 - The Too Many reason code
 - Otherwise:
 - Signal the Propagate Transaction (section 3.7.7.10) event on the Superior Transaction Manager facet with the following arguments:
 - The provided transaction object.
 - The provided Name object

3.2.7.22 Forget Transaction

The Forget Transaction event MUST be signaled with the following arguments:

- A transaction object

If the Forget Transaction event is signaled, the Core Transaction Manager Facet (section 1.3.3.3.1) MUST perform the following actions:

- Remove the provided transaction object from the transaction table.
- If the transaction was added to the **Core Transaction Manager Facet.Durable Log** of the Core Transaction Manager Facet (section 1.3.3.3.1):
 - Remove the transaction from the **Core Transaction Manager Facet.Durable Log**.
- Set the transaction's state to Ended.

3.2.7.23 Notify Aborted

The Notify Aborted event MUST be signaled with the following arguments:

- A transaction object

If the Notify Aborted event is signaled, the Core Transaction Manager Facet (section 1.3.3.3.1) MUST perform the following actions:

- Set the transaction's state to Aborting (section 3.2.1.3.11).
- Move each Enlistment object in the transaction's **Next Phase Zero Wave Enlistment list** to the transaction's Phase Zero Enlistment list.
- For each Enlistment object in the transaction's Phase Zero Enlistment list:
 - Signal the Phase Zero Aborted event (see sections 3.6.7.14 and 3.7.7.9) on the Enlistment's Transaction Manager facet field with the Enlistment object.
- Move each Enlistment object in the transaction's Phase One (section 1.3.1.2) Voter Enlistment list to the transaction's Phase Two (section 1.3.1.3) Voter Enlistment list
- For each Enlistment object in the transaction's Phase Two Voter Enlistment list:
 - Signal the Begin Rollback event (sections 3.4.7.5, 3.6.7.5 and 3.7.7.4) on the Enlistment's Transaction Manager facet field with the Enlistment object.
- Move each Enlistment object in the transaction's Phase One Enlistment list to the transaction's Phase Two Enlistment list.
- If the transaction's Phase Two Enlistment list is not empty:
 - For each Enlistment object in the transaction's Phase Two Enlistment list:
 - Signal the Begin Rollback event (sections 3.4.7.5, 3.6.7.5 and 3.7.7.4) on the enlistment's Transaction Manager facet field with the Enlistment object.
- Otherwise, if the transaction's Phase Two Enlistment list is empty:
 - Signal the Forget Transaction (section 3.2.7.22) event on the Core Transaction Manager Facet (section 1.3.3.3.1) with the provided transaction object.

3.2.7.24 Notify Recovered Transaction Committed

The Notify Recovered Transaction Committed event MUST be signaled with the following arguments:

- A transaction object

If the Notify Recovered Transaction Committed event is signaled, the Core Transaction Manager Facet (section 1.3.3.3.1) MUST perform the following actions:

- Set the transaction's state to Failed to Notify (section 3.2.1.3.13).
- If the Phase Two Enlistment list of the transaction is not empty:
 - For each Enlistment object in the Phase Two Enlistment list of the transaction:
 - Signal the Begin Commit event (see sections 3.4.7.3, 3.6.7.1, and 3.7.7.1) on the enlistment's transaction manager facet field with the Enlistment object.
- Otherwise:
 - Signal the Forget Transaction (section 3.2.7.22) event on the Core Transaction Manager Facet with the provided transaction object.

3.2.7.25 Phase One Completed

The Phase One Completed event MUST be signaled by using the following arguments:

- A transaction object

If the Phase One Completed event is signaled, the Core Transaction Manager MUST perform the following actions:

- Set the state of the transaction to Phase One Complete (section 3.2.1.3.8).
- If both the transaction's Phase Two Enlistment list and the transaction's Phase Two (section 1.3.1.3) Voter Enlistment list are empty:
 - Signal the Phase One Complete (see sections 3.4.7.13 and 3.8.7.7) event on the transaction's Superior Enlistment's Transaction Manager facet with the following arguments:
 - The transaction's Superior Enlistment object
 - The Read Only outcome
 - Signal the Forget Transaction (section 3.2.7.22) event on the Core Transaction Manager Facet's (section 1.3.3.3.1) with the provided transaction object.
- If the Single Phase Commit flag (defined in section 3.2.1) of the transaction is set to true:
 - Set the transaction state to Failed to Notify (section 3.2.1.3.13).
 - Save the transaction to the **Core Transaction Manager Facet.Durable Log** of the Core Transaction Manager.
 - Signal the Phase One Complete event on the Transaction Manager facet of the transaction's Superior Enlistment using the following arguments:
 - The Superior Enlistment object of the transaction.
 - The Committed outcome.
 - Set the transaction state to Phase One Complete.

- Signal the Begin Commit (section 3.2.7.2) event on the Core Transaction Manager Facet's with the provided transaction object.
- Otherwise, if the Single Phase Commit flag of the transaction is set to false:
 - Set the transaction state to In Doubt (section 3.2.1.3.12).
 - Save the transaction to the **Core Transaction Manager Facet.Durable Log** of the Core Transaction Manager.
 - Set the transaction state to Phase One Complete.
 - Signal the Phase One Complete event on the Superior Enlistment of the transaction Transaction Manager Facet using the following arguments:
 - The Superior Enlistment object of the transaction
 - The Prepared outcome

3.2.7.26 Propagate Transaction Failure

The Propagate Transaction Failure event MUST be signaled with the following arguments:

- An Enlistment object.
- A value indicating the failure reason. The reason MUST be set to one of the following values:
 - No Mem
 - Log Full
 - Duplicate
 - Comm Failed

If the Propagate Transaction Failure event is signaled, the Core Transaction Manager Facet (section 1.3.3.3.1) MUST perform the following actions:

- If the provided failure reason code is Duplicate:
 - Signal the Export Transaction Success (section 3.4.7.12) event on the transaction manager communicating with an application facet with the enlistment transaction object.
- Otherwise:
 - Signal the Export Transaction Failure (section 3.4.7.11) event on the transaction manager communicating with an application facet with the following arguments:
 - The transaction object referenced by the provided Enlistment object
 - The provided reason code

3.2.7.27 Propagate Transaction Success

The Propagate Transaction Success event MUST be signaled with the following arguments:

- An Enlistment object

If the Propagate Transaction Success event is signaled, the Core Transaction Manager Facet (section 1.3.3.3.1) MUST perform the following actions:

- If the Enlistment's transaction is not Active (section 3.2.1.3.2), Phase Zero (section 3.2.1.3.3), or Phase Zero Complete (section 3.2.1.3.4):
 - Signal the Export Transaction Failure (section 3.4.7.11) event on the Transaction Manager communicating with an Application facet with the following arguments:
 - The transaction object referenced by the provided Enlistment object
 - The Too Late reason code
- Otherwise:
 - Add the Enlistment object to the transaction's Phase One Enlistment list.
 - Signal the Export Transaction Success (section 3.4.7.12) event on the Transaction Manager communicating with an Application facet with the Enlistment's transaction object.

3.2.7.28 Register Phase Zero Failure

The Register Phase Zero Failure event MUST be signaled with the following arguments:

- An Enlistment object.
- A value indicating the failure reason. The reason MUST be set to one of the following values:
 - Too Late
 - Tx Not Found

If the Register Phase Zero Failure event is signaled, the Core Transaction Manager MUST perform the following actions:

- For each Enlistment object in the transaction's Next Phase Zero Wave Enlistment list:
 - Signal the Create Phase Zero Enlistment Failure event (see sections 3.6.7.7 and 3.7.7.5) on the Enlistment object's Transaction Manager facet with the following arguments:
 - The Enlistment object
 - The provided reason code
 - Remove the Enlistment object from the list.

3.2.7.29 Register Phase Zero Success

The Register Phase Zero Success event MUST be signaled with the following arguments:

- An Enlistment object

If the Register Phase Zero Success event is signaled, the Core Transaction Manager MUST perform the following actions:

- For each Enlistment object in the transaction's Next Phase Zero Wave Enlistment list:
 - Signal the Create Phase Zero Enlistment Success event (see sections 3.6.7.8 and 3.7.7.6) on the Enlistment object's Transaction Manager facet with the Enlistment object.
- Set the Phase Zero Registered flag of the transaction object referenced by the Enlistment to true.

3.2.7.30 Resolve Transaction

The Resolve Transaction event MUST be signaled with the following arguments:

- A transaction object.
- A value indicating the desired Resolve Transaction outcome. This value MUST be set to one of the following values:
 - Committed
 - Aborted
 - Forgotten

If the Resolve Transaction event is signaled, the Core Transaction Manager Facet (section 1.3.3.3.1) MUST perform the following actions:

- If the provided Resolve Transaction outcome is Committed or Aborted:
 - If the transaction state is not In Doubt (section 3.2.1.3.12):
 - Signal the Resolve Transaction Complete (section 3.4.7.16) event on the Transaction Manager communicating with an Application facet, with the following arguments:
 - The provided transaction object
 - The Not Prepared result
 - Otherwise:
 - If the provided Resolve Transaction outcome is Committed:
 - Signal the Notify Recovered Transaction Committed (section 3.2.7.24) event on the Core Transaction Manager Facet (section 1.3.3.3.1) with the provided transaction object.
 - Signal the Resolve Transaction Complete (section 3.4.7.16) event on the Transaction Manager communicating with an Application facet with the following arguments:
 - The provided transaction object
 - The Committed result
 - Otherwise, if the provided Resolve Transaction outcome is Aborted:
 - Signal the Notify Aborted (section 3.2.7.23) event on the Core Transaction Manager Facet (section 1.3.3.3.1) with the provided transaction object.
 - Signal the Resolve Transaction Complete (section 3.4.7.16) event on the Transaction Manager communicating with an Application facet with the following arguments:
 - The provided transaction object
 - The Aborted result
- Otherwise:
 - If the transaction state is not Failed to Notify (section 3.2.1.3.13):
 - Signal the Resolve Transaction Complete (section 3.4.7.16) event on the Transaction Manager communicating with an Application facet with the following arguments:

- The provided transaction object
- The Not Committed result
- Otherwise:
 - Set the state of the connection object referenced by each Enlistment object in the transaction's Phase Two Enlistment list to Ended.
 - Signal the Forget Transaction (section 3.2.7.22) event on the Core Transaction Manager Facet (section 1.3.3.3.1) with the provided transaction object.
 - Signal the Resolve Transaction Complete (section 3.4.7.16) event on the Transaction Manager communicating with an Application facet, with the following arguments:
 - The provided transaction object
 - The Forgotten result

3.2.7.31 Set Transaction Attributes

The Set Transaction Attributes event MUST be signaled with the following arguments:

- A transaction object.
- A value indicating the transaction's Isolation Level. The value MUST be one of the isolation level values specified in section 2.2.6.9.
- A value indicating the transaction's Isolation flags. The value MUST be one of the valid isolation flag values specified in section 2.2.6.8
- A string indicating an implementation-specific description of the transaction.

If the Set Transaction Attributes event is signaled, the Core Transaction Manager MUST perform the following actions:

- If the transaction state is not Active:
 - Signal the Set Transaction Attributes Failure (section 3.4.7.19) event on the Transaction Manager communicating with an Application Facet with the transaction object.
- Otherwise
 - If the transaction object's Attributes Set flag is set to false:
 - Set the transaction object's **Isolation Level** field with the Isolation Level argument.
 - Set the transaction object's **Isolation Flags** field with the Isolation Flags argument.
 - Set the transaction object's **Description** field with the Description Argument.
 - Set the transaction object's Attributes Set flag to true.
 - Signal the Set Transaction Attributes Success (section 3.4.7.20) event on the Transaction Manager communicating with an Application facet with the transaction object.

3.2.7.32 Set Transaction Timeout

The Set Transaction Timeout event MUST be signaled with the following arguments:

- A transaction object

- A time span

If the Set Transaction Timeout event is signaled, the Core Transaction Manager Facet (section 1.3.3.3.1) MUST perform the following actions:

- If the transaction state is not **Active**:
 - Signal the Set Transaction Timeout Failure (section 3.4.7.21) event on the Transaction Manager communicating with an Application facet with the provided transaction object.
- Otherwise:
 - Cancel the Transaction Timeout Timer (section 3.2.2.1).
 - Set the transaction **Timeout** field to the provided value.
 - Update the transaction timer's timeout value to the provided timespan value.
 - Signal the Set Transaction Timeout Success (section 3.4.7.22) event on the Transaction Manager communicating with an Application facet with the transaction object.

3.2.7.33 Request Transaction Outcome

Request Transaction Outcome MUST be signaled with the following arguments:

- An Enlistment object

If the Request Transaction Outcome event is signaled, the core transaction manager MUST perform the following actions:

- If the state of the transaction object referenced by the provided Enlistment object is Committing (section 3.2.1.3.10) or Failed to Notify (section 3.2.1.3.13):
 - Signal the Begin Commit (section 3.6.7.1) event on the provided Enlistment object's Transaction Manager facet with the provided Enlistment object.
- Otherwise, if the provided enlistment's transaction state is Aborting (section 3.2.1.3.11) or Ended (section 3.2.1.3.14):
 - Signal the Begin Rollback (section 3.6.7.5) event on the provided Enlistment object's Transaction Manager facet with the provided Enlistment object.
- Otherwise, ignore the event.

3.2.7.34 Unenlist Phase Zero Enlistment

The Unenlist Phase Zero Enlistment event MUST be signaled with the following arguments:

- An Enlistment object

If the Unenlist Phase Zero Enlistment event is signaled, the core transaction manager MUST perform the following actions:

- If the provided Enlistment object is a member of the transaction's next Phase Zero Wave Enlistment list:
 - Remove the Enlistment object from the list.
- Otherwise, if the provided Enlistment object is a member of the transaction's Phase Zero Enlistment list:

- Remove the Enlistment object from the list.

3.2.7.35 Voting Complete

The Voting Complete event MUST be signaled by using the following arguments:

- A transaction object

If the Voting Complete event is signaled, the Core Transaction Manager Facet (section 1.3.3.3.1) MUST perform the following actions:

- Set the transaction state to Voting Complete.
- If the Phase One Enlistment list of the transaction is empty:
 - If the Phase Two (section 1.3.1.3) Voter Enlistment list of the transaction is empty:
 - Signal the Phase One Completed event (section 3.2.7.25) on the transaction's Superior Enlistment's Transaction Manager facet using the following arguments:
 - The Superior Enlistment that is referenced by the provided transaction object
 - The Read Only outcome
 - Set the transaction State to Ended (section 3.2.1.3.14).
 - Otherwise:
 - If the transaction's Single Phase Commit flag (defined in section 3.2.1) is set to true:
 - Signal the Phase One Complete event on the transaction's Superior Enlistment's Transaction Manager facet with the following arguments:
 - The Superior Enlistment referenced by the provided transaction object
 - The Committed outcome
 - Set the transaction's State to Phase One Complete.
 - Signal the Begin Commit (section 3.2.7.2) event on the Core Transaction Manager with the provided transaction object.
 - Otherwise:
 - Set the transaction's state to Phase One Complete.
 - Signal the Phase One Complete event on the transaction's Superior Enlistment's Transaction Manager facet with the following arguments:
 - The Superior Enlistment referenced by the provided transaction object
 - The Prepared outcome
 - Otherwise, if the transaction's Single Phase Commit flag is set to true and the transaction's Phase One Enlistment list contains one element:
 - Set the transaction's state to Single Phase Commit.
 - Signal the Begin Phase One event (see the Resource Manager and Superior Transaction Manager Begin Phase One events in sections 3.6.7.3 and 3.7.7.2, respectively) on the enlistment's **Transaction Manager Facet** field with the following arguments:

- The Enlistment object
- The Single Phase Commit flag set to true
- Otherwise:
 - Set the transaction's State to Phase One.
 - For each Enlistment object in the transaction's Phase One Enlistment list:
 - Signal the Begin Phase One event (see the Resource Manager and Superior Transaction Manager **Begin Phase One** events in sections 3.6.7.3 and 3.7.7.2, respectively) on the enlistment's **Transaction Manager Facet** field with the following arguments:
 - The Enlistment object
 - The Single Phase Commit flag set to false

3.3 Application Details

3.3.1 Abstract Data Model

This section describes a conceptual model of possible data organization that an implementation maintains to participate in this protocol. The described organization is provided to facilitate the explanation of how the protocol behaves. This document does not mandate that implementations adhere to this model as long as their external behavior is consistent with the behavior that is described in this document.

An application **MUST** maintain all the data elements that are specified in section 3.1.1.

An application **MUST** extend the definition of a transaction object to include the following data elements:

- **Root:** A flag set to true if the application is the beginner of the transaction; otherwise, to false.

An application **MUST** also maintain the following data elements:

- **Transaction Manager Name:** A Name object that identifies the transaction manager that is associated with the application.

An application **MUST** provide the states that are defined in the following sections for its supported connection types. Section 2.2.1.1.1 defines the connection types that an application **MUST** provide for each supported protocol version.

3.3.1.1 CONNTYPE_TXUSER_BEGINNER Initiator States

The application **MUST** act as an initiator for the CONNTYPE_TXUSER_BEGINNER (section 2.2.8.1.1) connection type. In this role, the application **MUST** provide support for the following states:

- Idle
- Awaiting Begin Response
- Processing Transaction
- Awaiting Commit Response
- Awaiting Abort Response
- Ended

The following figure shows the relationship between the CONNTYPE_TXUSER_BEGINNER initiator states.

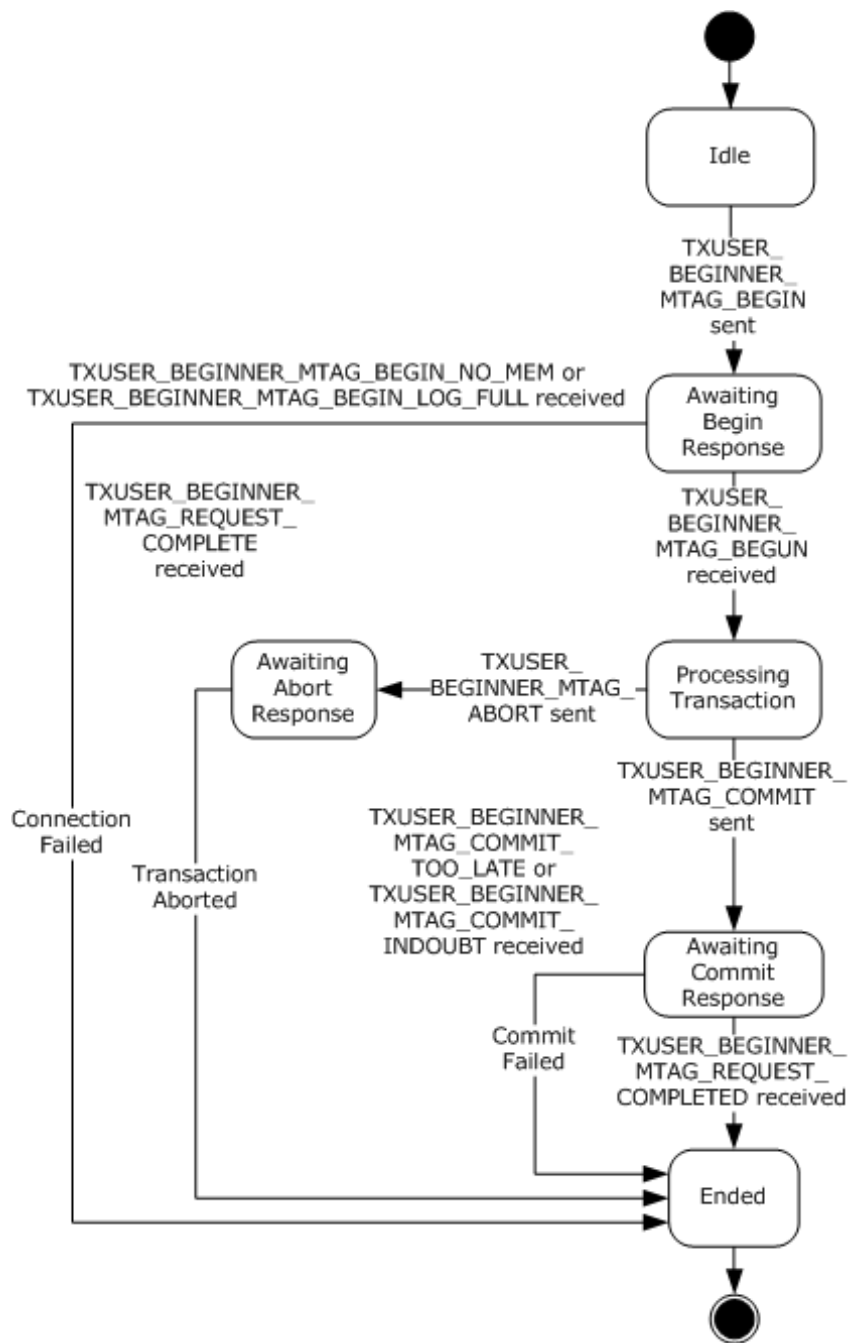

Figure 14: CONNTYPE_TXUSER_BEGINNER initiator states

3.3.1.1.1 Idle

This is the initial state. The following event is processed in this state:

- Beginning a Transaction Using CONNTYPE_TXUSER_BEGINNER (section 3.3.4.1.2)

3.3.1.1.2 Awaiting Begin Response

The following events are processed in this state:

- Receiving a TXUSER_BEGINNER_MTAG_BEGUN Message (section 3.3.5.1.1.1)
- Receiving a TXUSER_BEGINNER_MTAG_BEGIN_NO_MEM or TXUSER_BEGINNER_MTAG_BEGIN_LOG_FULL Message (section 3.3.5.1.1.2)

3.3.1.1.3 Processing Transaction

The following events are processed in this state:

- Initiating Transaction Commit (section 3.3.4.8)
- Initiating Transaction Rollback (section 3.3.4.9)

3.3.1.1.4 Awaiting Commit Response

The following events are processed in this state:

- Receiving a TXUSER_BEGINNER_MTAG_REQUEST_COMPLETED Message (section 3.3.5.1.1.3)
- Receiving a TXUSER_BEGINNER_MTAG_COMMIT_TOO_LATE Message (section 3.3.5.1.1.4)
- Receiving a TXUSER_BEGINNER_MTAG_COMMIT_INDOUBT Message (section 3.3.5.1.1.5)

3.3.1.1.5 Awaiting Abort Response

The following event is processed in this state:

- Receiving a TXUSER_BEGINNER_MTAG_REQUEST_COMPLETED Message (section 3.3.5.1.1.3)

3.3.1.1.6 Ended

This is the final state.

3.3.1.2 CONNTYPE_TXUSER_BEGIN2 Initiator States

The application MUST act as an initiator for the CONNTYPE_TXUSER_BEGIN2 (section 2.2.8.1.2) connection type. In this role, the application MUST provide support for the following states:

- Idle
- Awaiting Begin Response
- Processing Transaction
- Awaiting Set Timeout Response
- Awaiting Commit Response
- Awaiting Abort Response
- Ended

The following figure shows the relationship between the CONNTYPE_TXUSER_BEGIN2 initiator states.

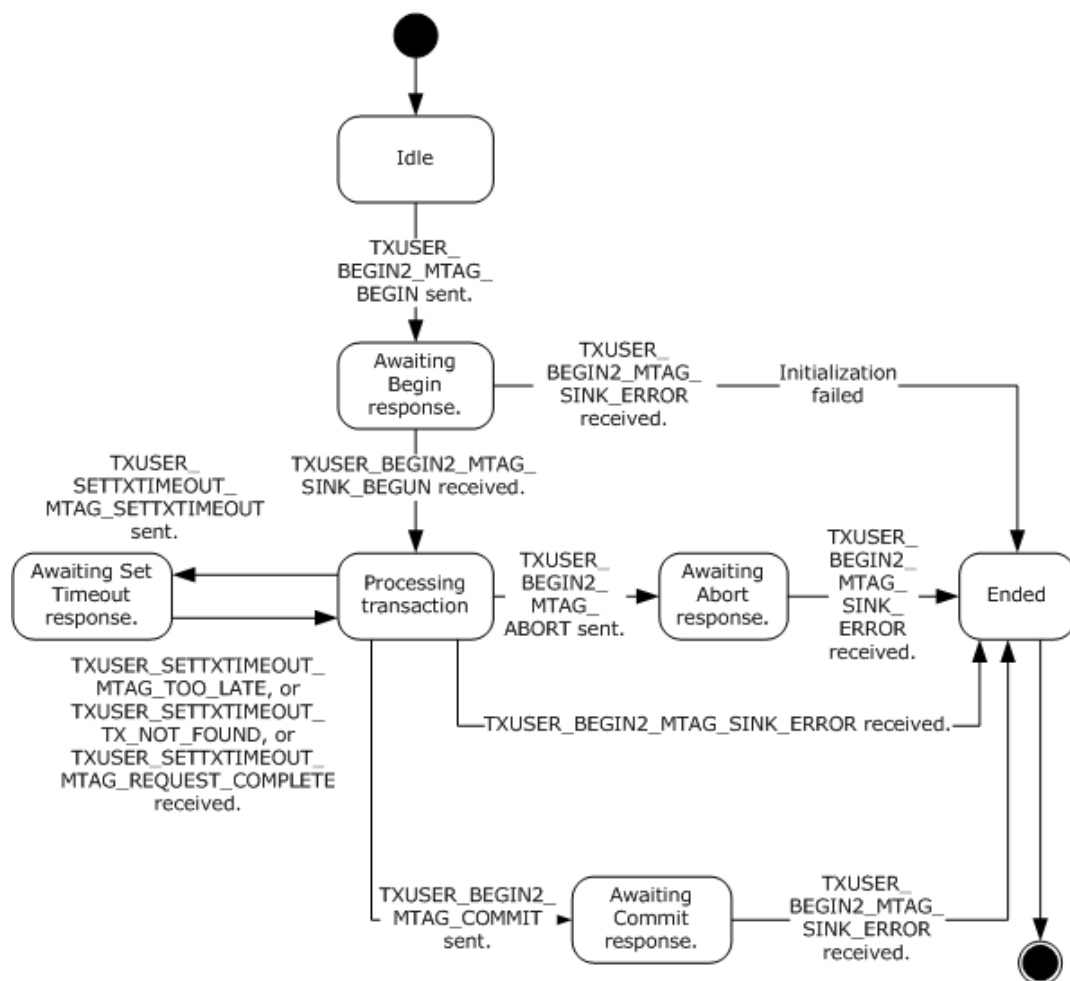

Figure 15: CONNTYPE_TXUSER_BEGIN2 initiator states

3.3.1.2.1 Idle

This is the initial state. The following event is processed in this state:

- Beginning a Transaction Using CONNTYPE_TXUSER_BEGIN2 (section 3.3.4.1.1)

3.3.1.2.2 Awaiting Begin Response

The following events are processed in this state:

- Receiving a TXUSER_BEGIN2_MTAG_SINK_BEGUN Message (section 3.3.5.1.2.1)
- Receiving a TXUSER_BEGIN2_MTAG_SINK_ERROR Message (section 3.3.5.1.2.5)

3.3.1.2.3 Processing Transaction

The following events are processed in this state:

- Querying Transaction Manager's Support for Modifying a Transaction Timeout Using CONNTYPE_TXUSER_SETTETIMEOUT2 (section 3.3.4.2.2)
- Commit a Transaction Using CONNTYPE_TXUSER_BEGIN2 (section 3.3.4.8.1)

- Abort a Transaction Using CONNTYPE_TXUSER_BEGIN2 (section 3.3.4.9.1)
- Receiving a TXUSER_BEGIN2_MTAG_SINK_ERROR Message (section 3.3.5.1.2.5)

3.3.1.2.4 Awaiting Set Timeout Response

The following events are processed in this state:

- Receiving a TXUSER_SETTETIMEOUT_MTAG_REQUEST_COMPLETE Message (section 3.3.5.1.2.2)
- Receiving a TXUSER_SETTETIMEOUT_MTAG_TOO_LATE Message (section 3.3.5.1.2.3)
- Receiving a TXUSER_SETTETIMEOUT_MTAG_TX_NOT_FOUND Message (section 3.3.5.1.2.4)

3.3.1.2.5 Awaiting Commit Response

The following event is processed in this state:

- Receiving a TXUSER_BEGIN2_MTAG_SINK_ERROR Message (section 3.3.5.1.2.5)

3.3.1.2.6 Awaiting Abort Response

The following event is processed in this state:

- Receiving a TXUSER_BEGIN2_MTAG_SINK_ERROR Message (section 3.3.5.1.2.5)

3.3.1.2.7 Ended

This is the final state.

3.3.1.3 CONNTYPE_TXUSER_PROMOTE Initiator States

The application MUST act as an initiator for the CONNTYPE_TXUSER_PROMOTE (section 2.2.8.1.3) connection type. In this role, the application MUST provide support for the following states:

- Idle
- Awaiting Promote Response
- Processing Transaction
- Awaiting Set Timeout Response
- Awaiting Commit Response
- Awaiting Abort Response
- Ended

The following figure shows the relationship between the CONNTYPE_TXUSER_PROMOTE initiator states.

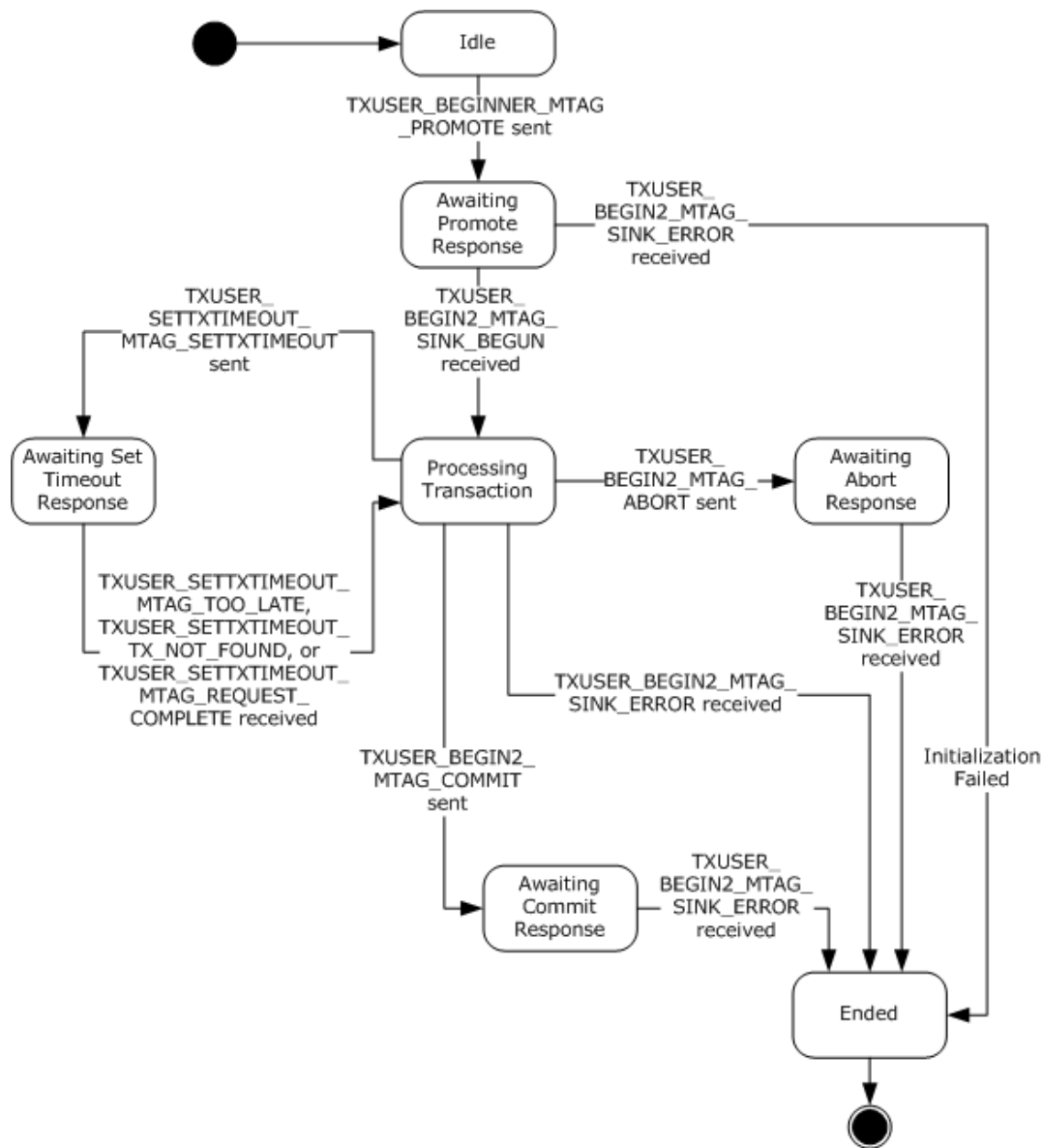

Figure 16: CONNTYPE_TXUSER_PROMOTE initiator states

3.3.1.3.1 Idle

This is the initial state. The following event is processed in this state:

- Beginning a Transaction Using CONNTYPE_TXUSER_PROMOTE (section 3.3.4.1.3)

3.3.1.3.2 Awaiting Promote Response

The following events are processed in this state:

- Receiving a TXUSER_BEGIN2_MTAG_SINK_BEGUN Message (section 3.3.5.1.3.1)
- Receiving a TXUSER_BEGIN2_MTAG_SINK_ERROR Message (section 3.3.5.1.3.2)

3.3.1.3.3 Processing Transaction

The following events are processed in this state:

- Commit a Transaction Using CONNTYPE_TXUSER_PROMOTE (section 3.3.4.8.3)
- Roll Back a Transaction Using CONNTYPE_TXUSER_PROMOTE (section 3.3.4.9.5)
- Querying Transaction Manager's Support for Modifying a Transaction Timeout Using CONNTYPE_TXUSER_SETTXTIMEOUT2 (section 3.3.4.2.2)
- Receiving a TXUSER_BEGIN2_MTAG_SINK_ERROR Message (section 3.3.5.1.3.2)

3.3.1.3.4 Awaiting Set Timeout Response

The following events are processed in this state:

- Receiving a TXUSER_SETTXTIMEOUT_MTAG_REQUEST_COMPLETE Message (section 3.3.5.1.2.2)
- Receiving a TXUSER_SETTXTIMEOUT_MTAG_TOO_LATE Message (section 3.3.5.1.2.3)
- Receiving a TXUSER_SETTXTIMEOUT_MTAG_TX_NOT_FOUND Message (section 3.3.5.1.2.4)

3.3.1.3.5 Awaiting Commit Response

The following event is processed in this state:

- Receiving a TXUSER_BEGIN2_MTAG_SINK_ERROR Message (section 3.3.5.1.3.2)

3.3.1.3.6 Awaiting Abort Response

The following event is processed in this state:

- Receiving a TXUSER_BEGIN2_MTAG_SINK_ERROR Message (section 3.3.5.1.3.2)

3.3.1.3.7 Ended

This is the final state.

3.3.1.4 CONNTYPE_TXUSER_ASSOCIATE Initiator States

The application MUST act as an initiator for the CONNTYPE_TXUSER_ASSOCIATE (section 2.2.8.2.1.1) connection type. In this role, the application MUST provide support for the following states:

- Idle
- Awaiting Associate Response
- Active
- Ended

The following figure shows the relationship between the CONNTYPE_TXUSER_ASSOCIATE initiator states.

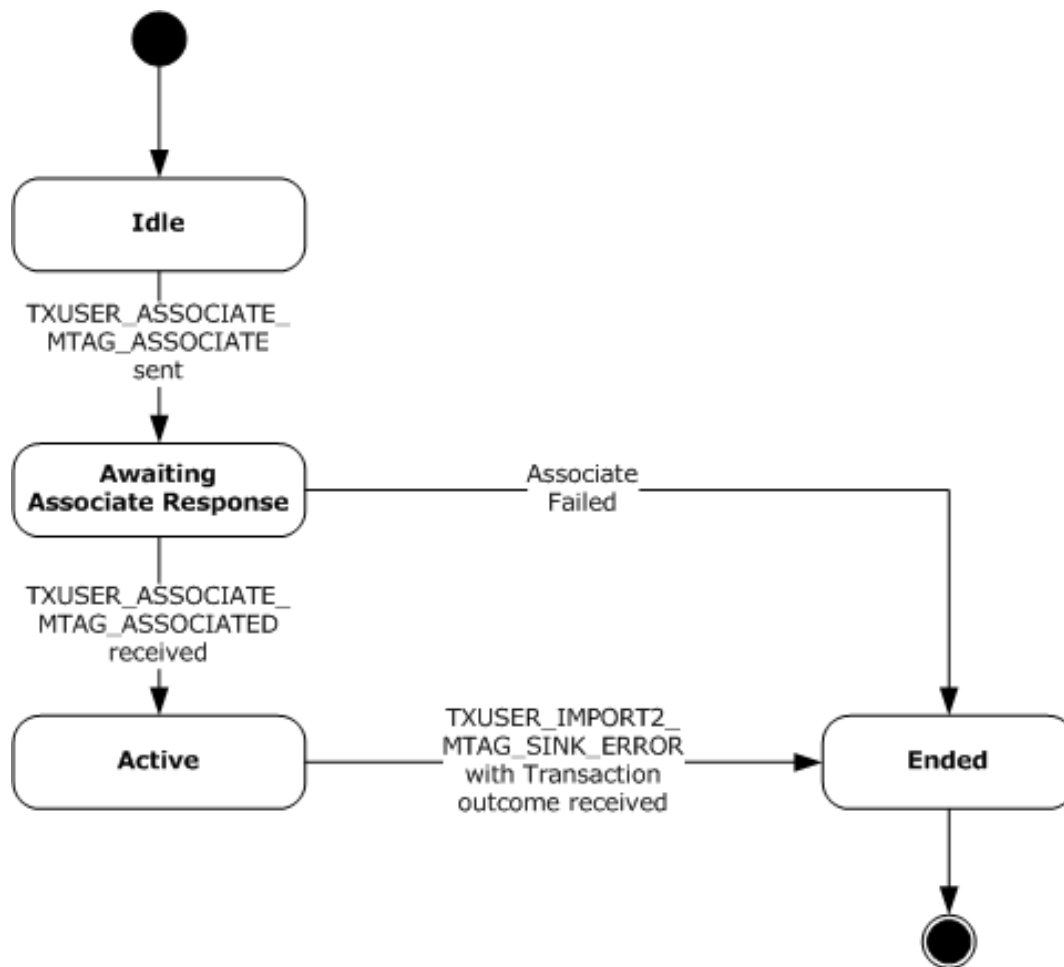

Figure 17: CONNTYPE_TXUSER_ASSOCIATE initiator states

3.3.1.4.1 Idle

This is the initial state. The following event is processed in this state:

- Pulling a Transaction (section 3.3.4.12)

3.3.1.4.2 Awaiting Associate Response

The following events are processed in this state:

- Receiving a TXUSER_ASSOCIATE_MTAG_ASSOCIATED Message (section 3.3.5.2.1.1.1)
- Receiving Other TXUSER_ASSOCIATE_MTAG Messages (section 3.3.5.2.1.1.2)

3.3.1.4.3 Active

The following event is processed in this state:

- Receiving a TXUSER_IMPORT2_MTAG_SINK_ERROR Message (section 3.3.5.2.1.1.3).

3.3.1.4.4 Ended

This is the final state.

3.3.1.5 CONNTYPE_TXUSER_EXTENDWHEREABOUTS Initiator States

The application MUST act as an initiator for the CONNTYPE_TXUSER_EXTENDEDWHEREABOUTS (section 2.2.8.2.2.1) connection type. In this role, the application MUST provide support for the following states:

- Idle
- Awaiting Get Response
- Ended

The following figure shows the relationship between the CONNTYPE_TXUSER_EXTENDWHEREABOUTS initiator states.

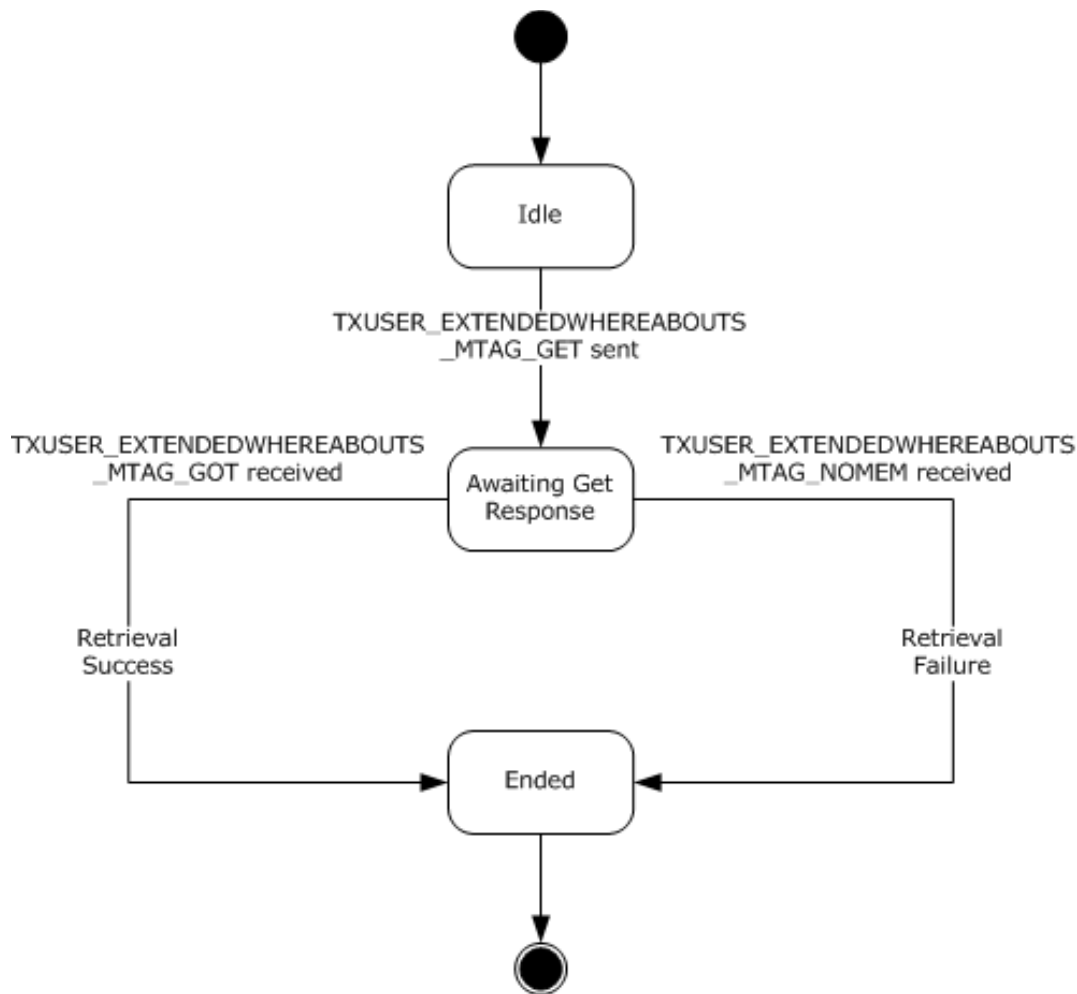

Figure 18: CONNTYPE_TXUSER_EXTENDEDWHEREABOUTS initiator states

3.3.1.5.1 Idle

This is the initial state. The following event is processed in this state:

- Obtaining Extended Whereabouts Using CONNTYPE_TXUSER_EXTENDEDWHEREABOUTS (section 3.3.4.10)

3.3.1.5.2 Awaiting Get Response

The following events are processed in this state:

- Receiving a TXUSER_EXTENDEDWHEREABOUTS_MTAG_GOT Message (section 3.3.5.2.2.1.1)
- Receiving a TXUSER_EXTENDEDWHEREABOUTS_MTAG_NOMEM Message (section 3.3.5.2.2.1.2)

3.3.1.5.3 Ended

This is the final state.

3.3.1.6 CONNTYPE_TXUSER_IMPORT Initiator States

The application MUST act as an initiator for the CONNTYPE_TXUSER_IMPORT (section 2.2.8.2.2.4) connection type. In this role, the application MUST provide support for the following states:

- Idle
- Awaiting Import Response
- Transaction Import Successful
- Awaiting Abort Response
- Ended

The following figure shows the relationship between the CONNTYPE_TXUSER_IMPORT initiator states:

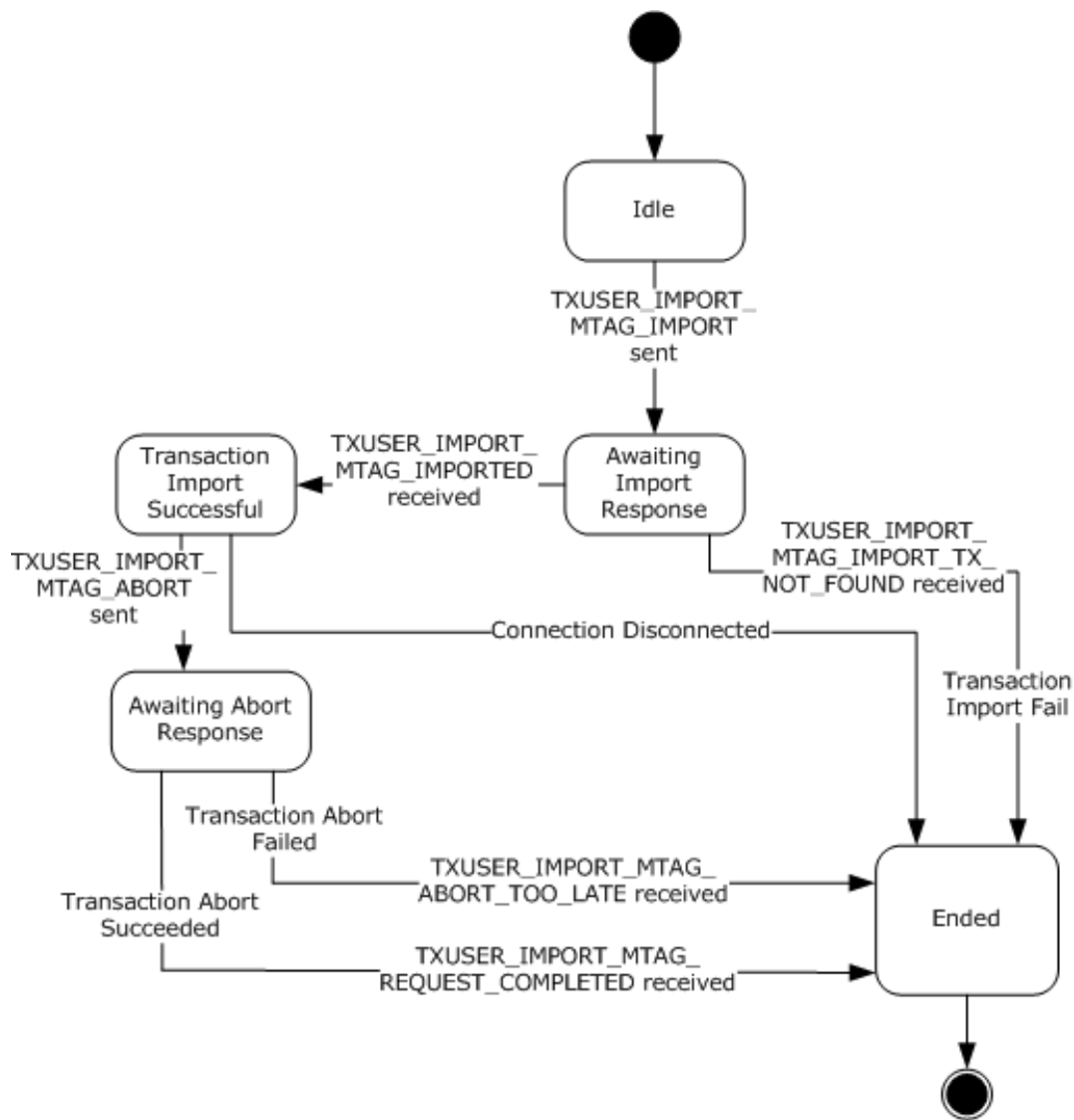

Figure 19: CONNTYPE_TXUSER_IMPORT initiator states

3.3.1.6.1 Idle

This is the initial state. The following event is processed in this state:

- Importing a Transaction Using CONNTYPE_TXUSER_IMPORT (section 3.3.4.6.1)

3.3.1.6.2 Awaiting Import Response

The following events are processed in this state:

- Receiving a TXUSER_IMPORT_MTAG_IMPORTED Message (section 3.3.5.2.2.4.1)
- Receiving a TXUSER_IMPORT_MTAG_IMPORT_TX_NOT_FOUND Message (section 3.3.5.2.2.4.2)

3.3.1.6.3 Transaction Import Successful

The following event is processed in this state:

- Abort a Transaction Using CONNTYPE_TXUSER_IMPORT (section 3.3.4.9.3)

3.3.1.6.4 Awaiting Abort Response

The following events are processed in this state:

- Receiving a TXUSER_IMPORT_MTAG_ABORT_TOO_LATE Message (section 3.3.5.2.2.4.3)
- Receiving a TXUSER_IMPORT_MTAG_REQUEST_COMPLETED Message (section 3.3.5.2.2.4.4)

3.3.1.6.5 Ended

This is the final state.

3.3.1.7 CONNTYPE_TXUSER_IMPORT2 Initiator States

The application MUST act as an initiator for the CONNTYPE_TXUSER_IMPORT2 (section 2.2.8.2.2.5) connection type. In this role, the application MUST provide support for the following states:

- Idle
- Awaiting Import Response
- Transaction Import Successful
- Awaiting Abort Response
- Ended

The following figure shows the relationship between the CONNTYPE_TXUSER_IMPORT2 initiator states.

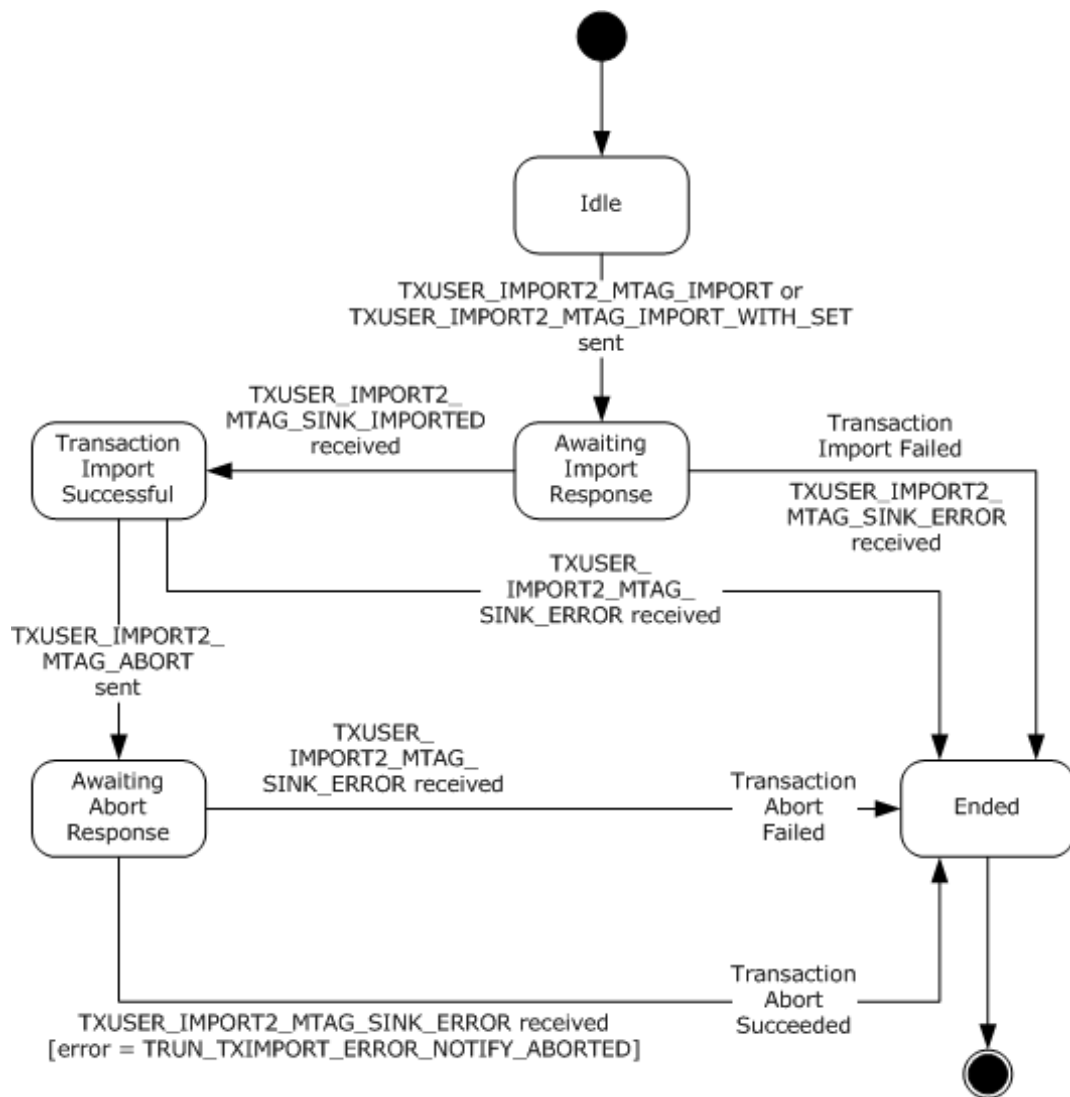

Figure 20: CONNTYPE_TXUSER_IMPORT2 initiator states

3.3.1.7.1 Idle

This is the initial state. The following events are processed in this state:

- Importing a Transaction Using CONNTYPE_TXUSER_IMPORT2 (section 3.3.4.6.2)
- Importing a Transaction with Additional Transaction Attributes (section 3.3.4.7)

3.3.1.7.2 Awaiting Import Response

The following events are processed in this state:

- Receiving a TXUSER_IMPORT2_MTAG_SINK_IMPORTED Message (section 3.3.5.2.2.5.1)
- Receiving a TXUSER_IMPORT2_MTAG_SINK_ERROR Message (section 3.3.5.2.2.5.2)

3.3.1.7.3 Transaction Import Successful

The following events are processed in this state:

- Receiving a TXUSER_IMPORT2_MTAG_SINK_ERROR Message (section 3.3.5.2.2.5.2)
- Abort a Transaction Using CONNTYPE_TXUSER_IMPORT2 (section 3.3.4.9.4)

3.3.1.7.4 Awaiting Abort Response

The following event is processed in this state:

- Receiving a TXUSER_IMPORT2_MTAG_SINK_ERROR Message (section 3.3.5.2.2.5.2)

3.3.1.7.5 Ended

This is the final state.

3.3.1.8 CONNTYPE_TXUSER_EXPORT Initiator States

The application **MUST** act as an initiator for the CONNTYPE_TXUSER_EXPORT (section 2.2.8.2.2.2) connection type. In this role, the application **MUST** provide support for the following states:

- Idle
- Awaiting Create Response
- Connection Active
- Awaiting Export Response
- Ended

The following figure shows the relationship between the CONNTYPE_TXUSER_EXPORT initiator states.

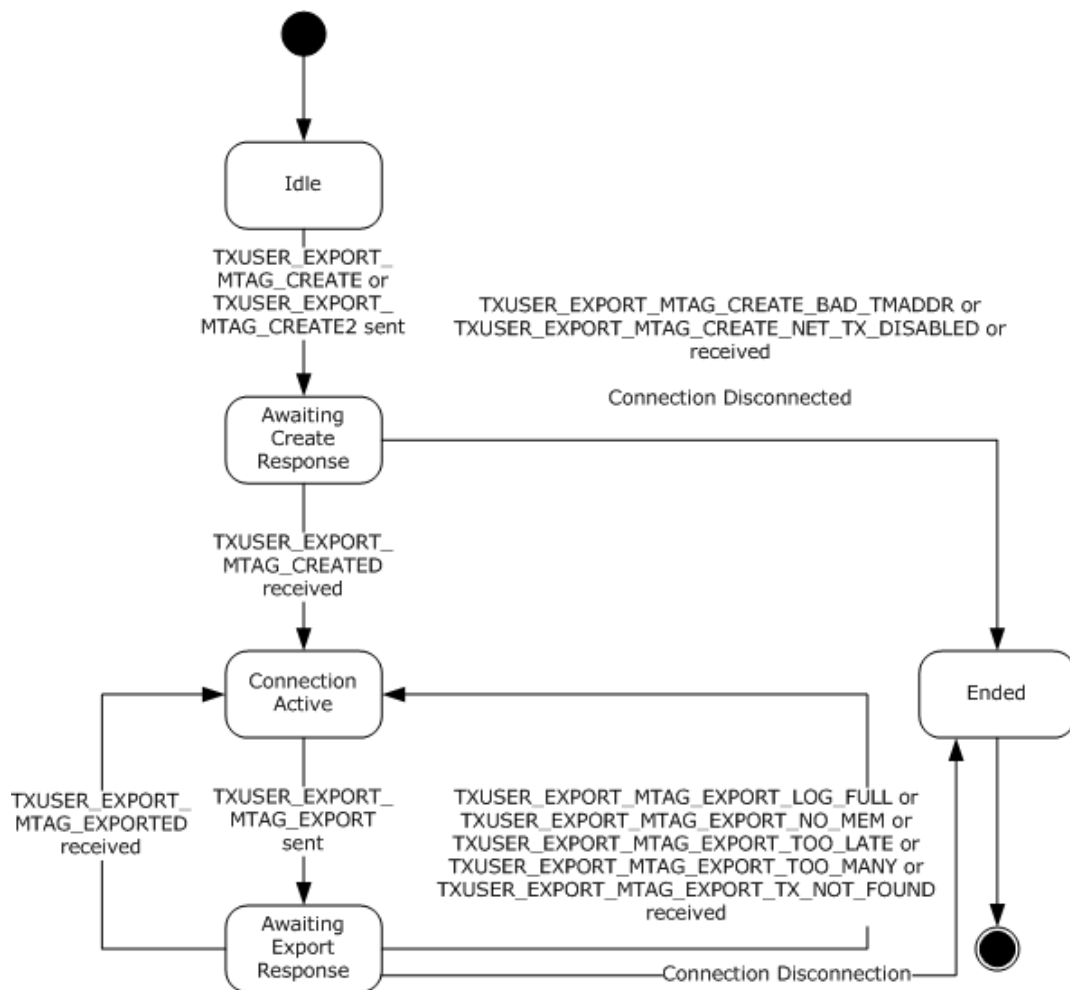

Figure 21: CONNTYPE_TXUSER_EXPORT initiator states

3.3.1.8.1 Idle

This is the initial state. The following event is processed in this state:

- Creating an Export Connection (section 3.3.4.4)

3.3.1.8.2 Awaiting Create Response

The following events are processed in this state:

- Receiving a TXUSER_EXPORT_MTAG_CREATED Message (section 3.3.5.2.2.2.1)
- Receiving a TXUSER_EXPORT_MTAG_CREATE_BAD_TMADDR or TXUSER_EXPORT_MTAG_CREATE_NET_TX_DISABLED Message (section 3.3.5.2.2.2.2)
- CONNTYPE_TXUSER_EXPORT Connection Disconnected (section 3.3.5.2.2.2.5)

3.3.1.8.3 Connection Active

The following event is processed in this state:

- Push a Transaction Using an Existing Export Connection (section 3.3.4.13)

3.3.1.8.4 Awaiting Export Response

The following events are processed in this state:

- Receiving a TXUSER_EXPORT_MTAG_EXPORTED Message (section 3.3.5.2.2.2.3)
- Receiving a TXUSER_EXPORT_MTAG_EXPORT_LOG_FULL, TXUSER_EXPORT_MTAG_EXPORT_NO_MEM, TXUSER_EXPORT_MTAG_EXPORT_TOO_LATE, TXUSER_EXPORT_MTAG_EXPORT_TOO_MANY, or TXUSER_EXPORT_MTAG_EXPORT_NOT_FOUND Message (section 3.3.5.2.2.2.4)
- CONNTYPE_TXUSER_EXPORT Connection Disconnected (section 3.3.5.2.2.2.5)

3.3.1.8.5 Ended

This is the final state.

3.3.1.9 CONNTYPE_TXUSER_EXPORT2 Initiator States

The application MUST act as an initiator for the CONNTYPE_TXUSER_EXPORT2 (section 2.2.8.2.2.3) connection type. In this role, the application MUST provide support for the following states:

- Idle
- Awaiting Create Response
- Connection Active
- Awaiting Export Response
- Ended

The following figure shows the relationship between the CONNTYPE_TXUSER_EXPORT2 initiator states.

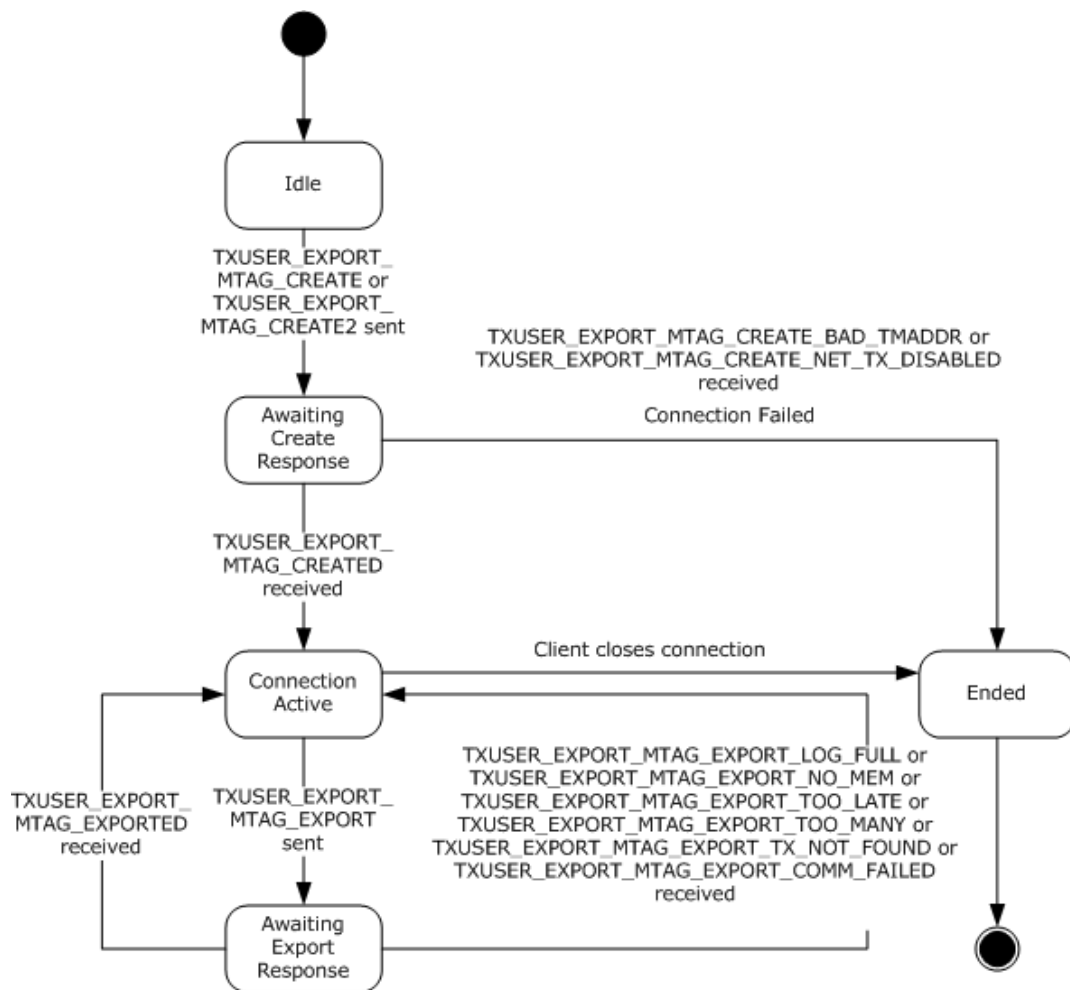

Figure 22: CONNTYPE_TXUSER_EXPORT2 initiator states

3.3.1.9.1 Idle

This is the initial state. The following event is processed in this state:

- Creating an Export Connection (section 3.3.4.4)

3.3.1.9.2 Awaiting Create Response

The following events are processed in this state:

- Receiving a TXUSER_EXPORT_MTAG_CREATED Message (section 3.3.5.2.2.3.1)
- Receiving a TXUSER_EXPORT_MTAG_CREATE_BAD_TMADDR or TXUSER_EXPORT_MTAG_CREATE_NET_TX_DISABLED Message (section 3.3.5.2.2.3.2)

3.3.1.9.3 Connection Active

The following event is processed in this state:

- Push a Transaction Using an Existing Export Connection (section 3.3.4.13)

3.3.1.9.4 Awaiting Export Response

The following events are processed in this state:

- Receiving a TXUSER_EXPORT_MTAG_EXPORTED message (section 3.3.5.2.2.3.3)
- Receiving a TXUSER_EXPORT_MTAG_EXPORT_LOG_FULL, TXUSER_EXPORT_MTAG_EXPORT_NO_MEM, TXUSER_EXPORT_MTAG_EXPORT_TOO_LATE, TXUSER_EXPORT_MTAG_EXPORT_TOO_MANY, TXUSER_EXPORT_MTAG_EXPORT_NOT_FOUND, or TXUSER_EXPORT_MTAG_EXPORT_COMM_FAILED Message (section 3.3.5.2.2.3.4)

3.3.1.9.5 Ended

This is the final state.

3.3.1.10 CONNTYPE_TXUSER_GETTXDETAILS Initiator States

The application MUST act as an initiator for the CONNTYPE_TXUSER_GETTXDETAILS (section 2.2.8.3.1) connection type. In this role, the application MUST provide support for the following states:

- Idle
- Awaiting Response
- Ended

The following figure shows the relationship between the CONNTYPE_TXUSER_GETTXDETAILS initiator states.

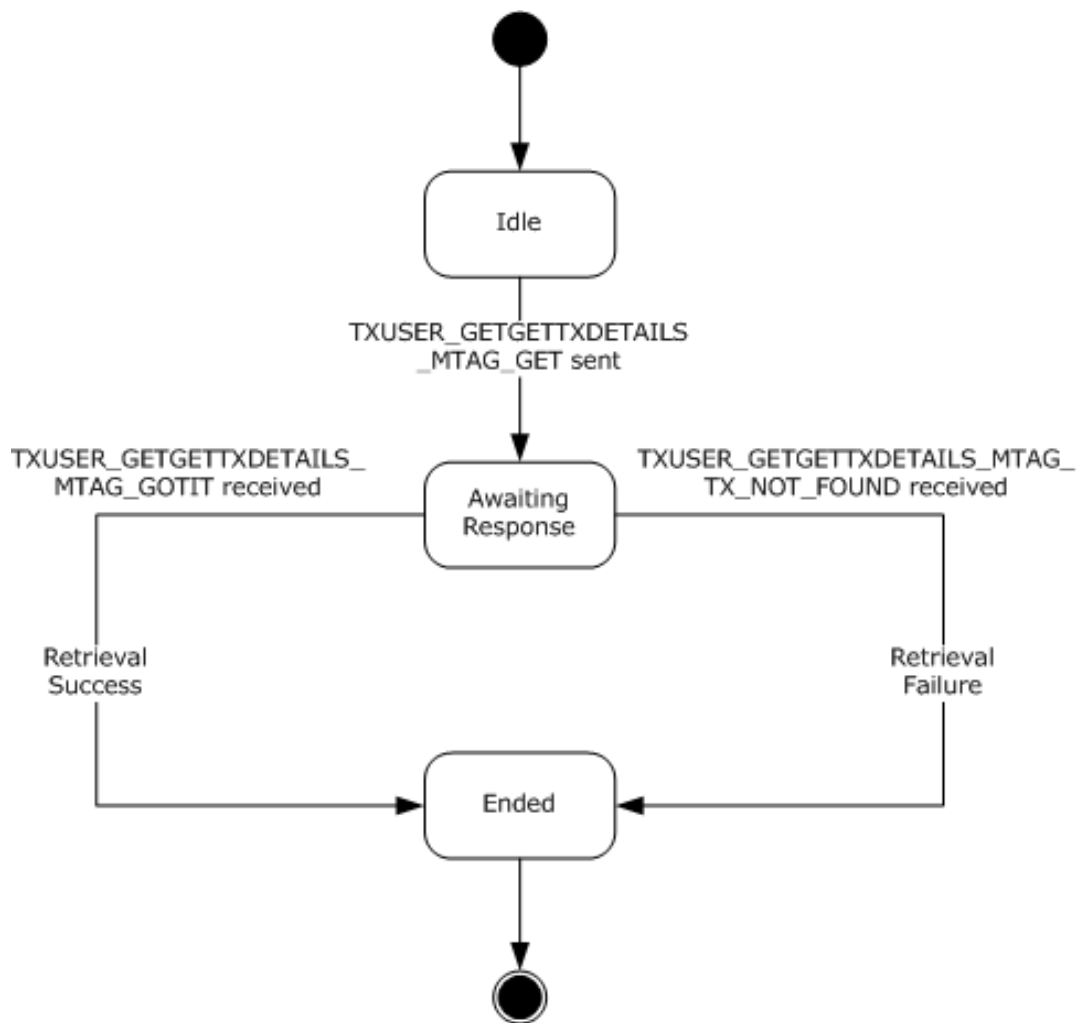

Figure 23: CONNTYPE_TXUSER_GETTXDETAILS initiator states

3.3.1.10.1 Idle

This is the initial state. The following event is processed in this state:

- Obtaining the Details for a Transaction (section 3.3.4.11.1)

3.3.1.10.2 Awaiting Response

The following events are processed in this state:

- Receiving a TXUSER_GETTXDETAILS_MTAG_GOTIT Message (section 3.3.5.3.1.1)
- Receiving a TXUSER_GETTXDETAILS_MTAG_TX_NOT_FOUND Message (section 3.3.5.3.1.2)

3.3.1.10.3 Ended

This is the final state.

3.3.1.11 CONNTYPE_TXUSER_RESOLVE Initiator States

The application MUST act as an initiator for the CONNTYPE_TXUSER_RESOLVE (section 2.2.8.3.2) connection type. In this role, the application MUST provide support for the following states:

- Idle
- Awaiting Abort Response
- Awaiting Forget Response
- Awaiting Commit Response
- Ended

The following figure shows the relationship between the CONNTYPE_TXUSER_RESOLVE initiator states.

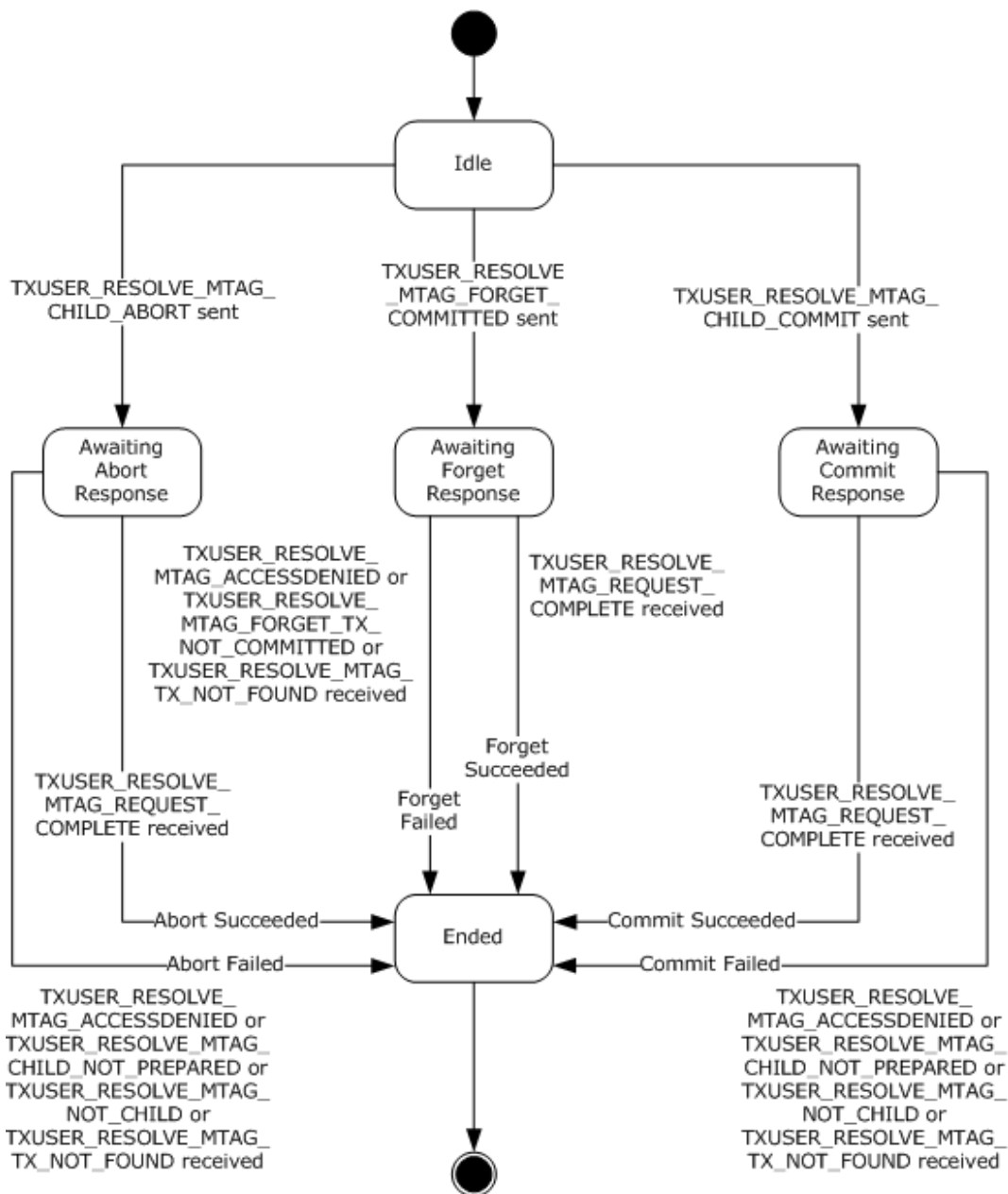

Figure 24: CONNTYPE_TXUSER_RESOLVE initiator states

3.3.1.11.1 Idle

This is the initial state. The following event is processed in this state:

- Resolving a Transaction (section 3.3.4.15)

3.3.1.11.2 Awaiting Abort Response

The following events are processed in this state:

- Receiving a TXUSER_RESOLVE_MTAG_REQUEST_COMPLETE Message (section 3.3.5.3.2.1)

- Receiving a TXUSER_RESOLVE_MTAG_CHILD_NOT_PREPARED or TXUSER_RESOLVE_MTAG_NOT_CHILD Message (section 3.3.5.3.2.3)
- Receiving a TXUSER_RESOLVE_MTAG_ACCESSDENIED or TXUSER_RESOLVE_MTAG_TX_NOT_FOUND Message (section 3.3.5.3.2.2)

3.3.1.11.3 Awaiting Forget Response

The following events are processed in this state:

- Receiving a TXUSER_RESOLVE_MTAG_REQUEST_COMPLETE Message (section 3.3.5.3.2.1)
- Receiving a TXUSER_RESOLVE_MTAG_FORGET_TX_NOT_COMMITTED Message (section 3.3.5.3.2.4)
- Receiving a TXUSER_RESOLVE_MTAG_ACCESSDENIED or TXUSER_RESOLVE_MTAG_TX_NOT_FOUND Message (section 3.3.5.3.2.2)

3.3.1.11.4 Awaiting Commit Response

The following events are processed in this state:

- Receiving a TXUSER_RESOLVE_MTAG_REQUEST_COMPLETE Message (section 3.3.5.3.2.1)
- Receiving a TXUSER_RESOLVE_MTAG_CHILD_NOT_PREPARED or TXUSER_RESOLVE_MTAG_NOT_CHILD Message (section 3.3.5.3.2.3)
- Receiving a TXUSER_RESOLVE_MTAG_ACCESSDENIED or TXUSER_RESOLVE_MTAG_TX_NOT_FOUND Message (section 3.3.5.3.2.2)

3.3.1.11.5 Ended

This is the final state.

3.3.1.12 CONNTYPE_TXUSER_SETTXTIMEOUT Initiator States

The application MUST act as an initiator for the CONNTYPE_TXUSER_SETTXTIMEOUT (section 2.2.8.3.3) connection type. In this role, the application MUST provide support for the following states:

- Idle
- Awaiting Set Timeout Response
- Ended

The following figure shows the relationship between the CONNTYPE_TXUSER_SETTXTIMEOUT initiator states.

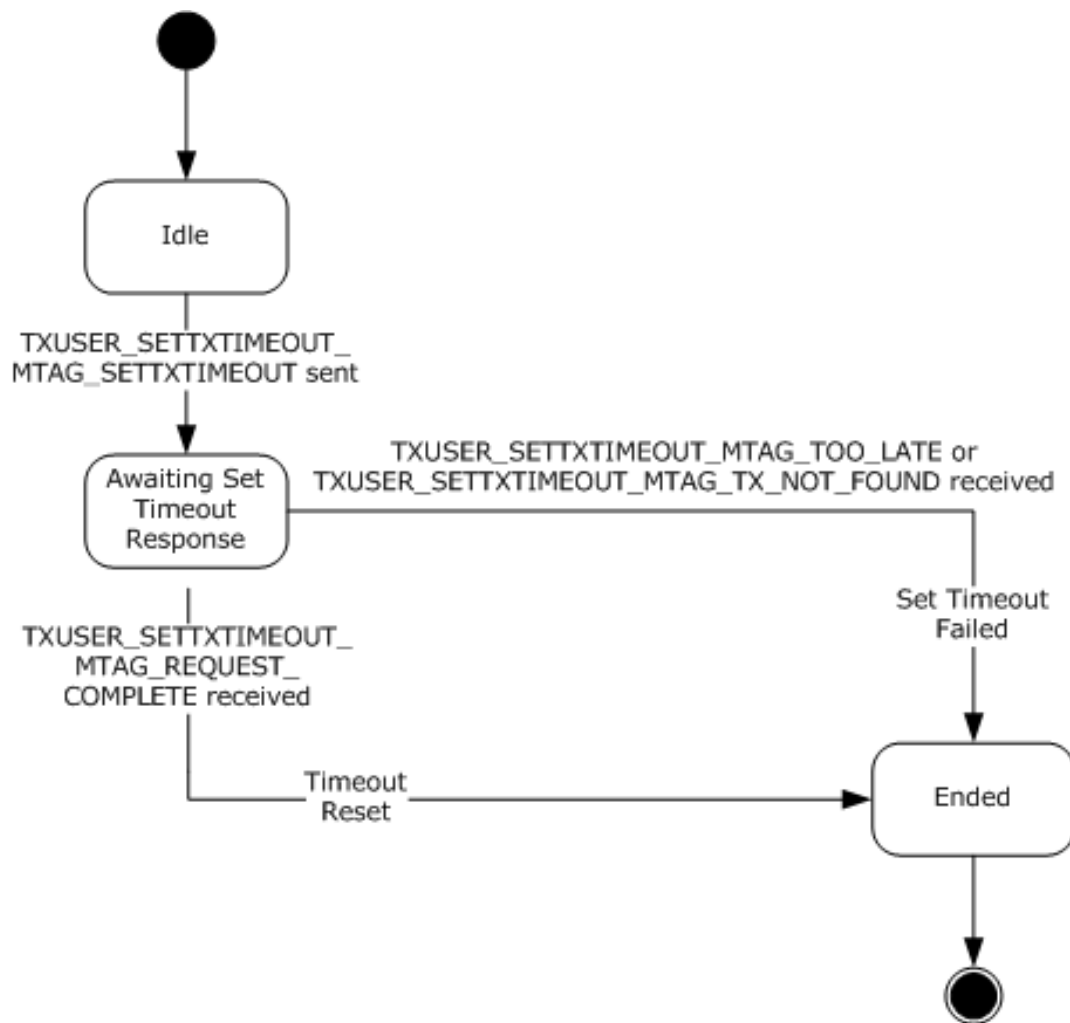

Figure 25: CONNTYPE_TXUSER_SETTXXTIMEOUT initiator states

3.3.1.12.1 Idle

This is the initial state. The following event is processed in this state:

- Changing a Transaction Time-out Using CONNTYPE_TXUSER_SETTXXTIMEOUT (section 3.3.4.2.1)

3.3.1.12.2 Awaiting Set Timeout Response

The following events are processed in the Awaiting Set Timeout Response state:

- Receiving a TXUSER_SETTXXTIMEOUT_MTAG_REQUEST_COMPLETE Message (section 3.3.5.3.3.1)
- Receiving a TXUSER_SETTXXTIMEOUT_MTAG_TOO_LATE or TXUSER_SETTXXTIMEOUT_MTAG_TX_NOT_FOUND Message (section 3.3.5.3.3.2)

3.3.1.12.3 Ended

This is the final state.

3.3.1.13 CONNTYPE_TXUSER_SETTXTIMEOUT2 Initiator States

The application MUST act as an initiator for the CONNTYPE_TXUSER_SETTXTIMEOUT2 (section 2.2.8.3.4) connection type. In this role, the application MUST provide support for the following states:

- Idle
- Awaiting Set Timeout Response
- Ended

The following figure shows the relationship between the CONNTYPE_TXUSER_SETTXTIMEOUT2 initiator states.

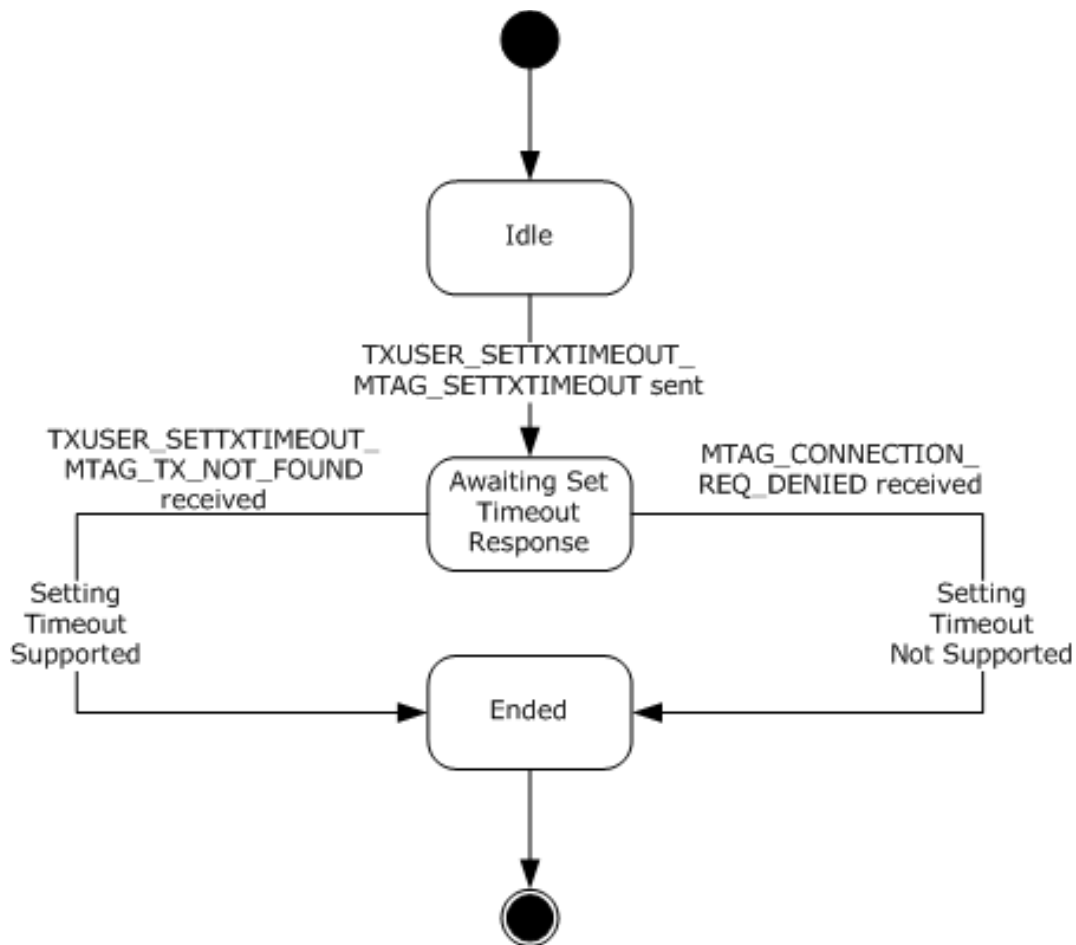

Figure 26: CONNTYPE_TXUSER_SETTXTIMEOUT2 initiator states

3.3.1.13.1 Idle

This is the initial state. The following event is processed in this state:

- Querying Transaction Manager's Support for Modifying a Transaction Timeout Using CONNTYPE_TXUSER_SETTXTIMEOUT2 (section 3.3.4.2.2)

3.3.1.13.2 Awaiting Set Timeout Response

The following event is processed in this state:

- Receiving a TXUSER_SETTXTIMEOUT_MTAG_TX_NOT_FOUND Message (section 3.3.5.3.4.1)
- Receiving an MTAG_CONNECTION_REQ_DENIED message ([MS-CMP] section 2.2.5) as described in section 1.7.3.

3.3.1.13.3 Ended

This is the final state.

3.3.1.14 CONNTYPE_TXUSER_TRACE Initiator States

The application MUST act as an initiator for the CONNTYPE_TXUSER_TRACE (section 2.2.8.3.5) connection type. In this role, the application MUST provide support for the following states:

- Idle
- Awaiting Trace Response
- Ended

The following figure shows the relationship between the CONNTYPE_TXUSER_TRACE initiator states.

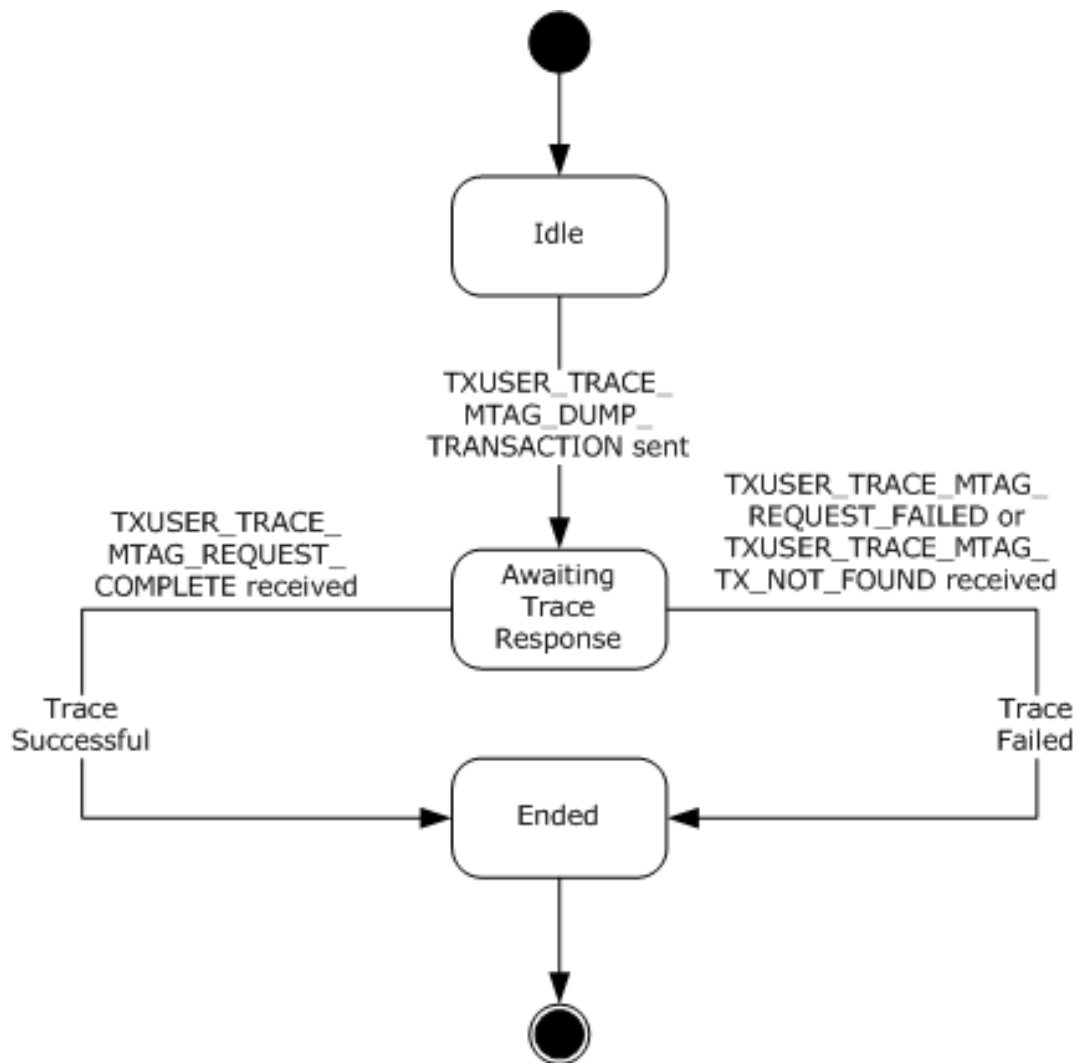

Figure 27: CONNTYPE_TXUSER_TRACE initiator states

3.3.1.14.1 Idle

This is the initial state. The following event is processed in this state:

- Generating Trace Records for a Transaction Using CONNTYPE_TXUSER_TRACE (section 3.3.4.5)

3.3.1.14.2 Awaiting Trace Response

The following events are processed in this state:

- Receiving a TXUSER_TRACE_MTAG_REQUEST_COMPLETE Message (section 3.3.5.3.5.1)
- Receiving a TXUSER_TRACE_MTAG_REQUEST_FAILED or TXUSER_TRACE_MTAG_TX_NOT_FOUND Message (section 3.3.5.3.5.2)

3.3.1.14.3 Ended

This is the final state.

3.3.1.15 CONNTYPE_TXUSER_GETSECURITYFLAGS Initiator States

The application MUST act as an initiator for the CONNTYPE_TXUSER_GETSECURITYFLAGS (section 2.2.8.4.1) connection type. In this role, the application MUST provide support for the following states:

- Idle
- Awaiting Get Response
- Ended

The following figure shows the relationship between the CONNTYPE_TXUSER_GETSECURITYFLAGS initiator states.

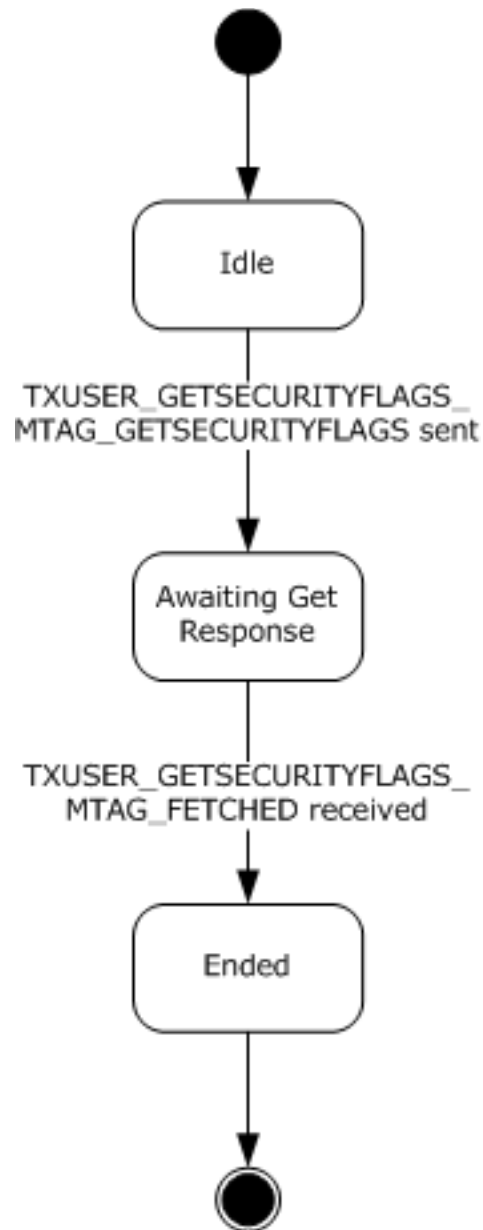

Figure 28: CONNTYPE_TXUSER_GETSECURITYFLAGS initiator states

3.3.1.15.1 Idle

This is the initial state. The following event is processed in this state:

- Obtaining the Security Configuration of the Transaction Manager Using CONNTYPE_TXUSER_GETSECURITYFLAGS (section 3.3.4.11)

3.3.1.15.2 Awaiting Get Response

The following event is processed in this state:

- Receiving a TXUSER_GETSECURITYFLAGS_MTAG_FETCHED Message (section 3.3.5.4.1.1)

3.3.1.15.3 Ended

This is the final state.

3.3.2 Timers

No timers apply here.

3.3.3 Initialization

When an application is initialized:

- The Transaction Manager **Name** field MUST be set to a value that is obtained from an implementation-specific source.
- The application MUST initialize each new transaction object that is created with the following default values:
 - The **Root** field MUST default to false.

3.3.4 Higher-Layer Triggered Events

The application MUST be prepared to process a set of higher-layer events described in this section and in Message Processing Events and Sequencing Rules (section 3.3.5). These events are triggered by decisions that are made by the higher-layer business logic of the application. The motivations and details of the higher-layer business logic are specific to the implementation of the application and the software environment in which it executes.

When the application processes one of the higher-layer events described in this section and section 3.3.5, it MUST communicate one of the following results to the higher-layer business logic:

- Success
- Failure
- Transaction Committed
- Transaction Aborted
- Transaction In Doubt

If the processing of a higher-layer event includes a Message Processing event, the associated Message Processing event MUST communicate one of the above results to the higher-layer business logic.

3.3.4.1 Beginning a Transaction

If the higher-layer business logic begins a transaction with a predetermined transaction identifier<32>:

- If the transaction manager of the application supports the CONNTYPE_TXUSER_PROMOTE (section 2.2.8.1.3) connection type as specified in section 2.2.1.1.1:
 - The application **MUST** attempt to begin a transaction by using the CONNTYPE_TXUSER_PROMOTE connection type.
- Otherwise:
 - The application **MUST** return a Failure result to the higher-layer business logic.

If the higher-layer business logic decides to begin a transaction without using a predetermined transaction identifier, the application **MUST** perform the following actions:

- If the transaction manager supports the CONNTYPE_TXUSER_BEGIN2 (section 2.2.8.1.2) connection type as specified in section 2.2.1.1.1:
 - The application **MUST** attempt to begin a transaction by using CONNTYPE_TXUSER_BEGIN2.
- Otherwise:
 - The application **MUST** attempt to begin a transaction by using CONNTYPE_TXUSER_BEGINNER (section 2.2.8.1.1).

3.3.4.1.1 Beginning a Transaction Using CONNTYPE_TXUSER_BEGIN2

The application **MUST** perform the following actions:

- Initiate a new CONNTYPE_TXUSER_BEGIN2 (section 2.2.8.1.2) connection using the transaction manager **Name** field of the application.
- Send a TXUSER_BEGIN2_MTAG_BEGIN (section 2.2.8.1.2.2) message using the connection and the values that are provided by the higher-layer business logic:
 - The **isoLevel**, **dwTimeout**, **szDesc**, and **isoFlags** fields **MUST** be set as specified in section 2.2.8.
- Set the connection state to Awaiting Begin Response.

3.3.4.1.2 Beginning a Transaction Using CONNTYPE_TXUSER_BEGINNER

The application **MUST** perform the following actions:

- Initiate a new CONNTYPE_TXUSER_BEGINNER (section 2.2.8.1.1) connection by using the transaction manager Name field of the application.
- Send a TXUSER_BEGINNER_MTAG_BEGIN (section 2.2.8.1.1.2) message by using the connection. The following message fields **MUST** be set to values that are provided by the higher-layer business logic:
 - The **isoLevel** field set to the required isolation-level value.
 - The **dwTimeout** field **MUST** be set to the required time-out value.
 - The **szDesc** field **MUST** be set to the required transaction description string.

- The **isoFlags** field MUST be set to the required isolation flags value.
- Set the connection state to Awaiting Begin Response.

3.3.4.1.3 Beginning a Transaction Using CONNTYPE_TXUSER_PROMOTE

The application MUST perform the following actions:

- Initiate a new CONNTYPE_TXUSER_PROMOTE (section 2.2.8.1.3) connection using the transaction manager Name field of the application.
- Send a TXUSER_BEGINNER_MTAG_PROMOTE (section 2.2.8.1.3.1) message using the connection. The following message fields MUST be set to values that are provided by the higher-layer business logic:
 - The **isoLevel** field to the wanted isolation-level value.
 - The **dwTimeout** field to the wanted time-out value.
 - The **szDesc** field to the wanted transaction description string.
 - The **isoFlags** field to the wanted isolation flags value.
 - The **guidTx** field to the wanted predetermined transaction identifier.
- Set the connection state to Awaiting Promote Response.

3.3.4.2 Changing a Transaction Timeout

If the higher-layer business logic changes the time-out of an existing transaction, the application MUST perform the following steps:

- If the **Root** field of the transaction is false:
 - Return a failure result to the higher-layer business logic.
- Otherwise:
 - If the root transaction manager supports the CONNTYPE_TXUSER_SETTXTIMEOUT2 (section 3.3.1.13) connection type, as specified in section 2.2.1.1.1:
 - The application MUST attempt to change the transaction time-out by using CONNTYPE_TXUSER_SETTXTIMEOUT2 (section 3.3.1.13).
 - Otherwise:
 - The application MUST attempt to change the transaction time-out by using CONNTYPE_TXUSER_SETTXTIMEOUT (section 3.3.1.12).

3.3.4.2.1 Changing a Transaction Timeout Using CONNTYPE_TXUSER_SETTXTIMEOUT

The application MUST perform the following actions:

- Find an instance of a CONNTYPE_TXUSER_BEGINNER (section 2.2.8.1.1) connection in the connection list of the transaction.
- If a connection is not found, the application MUST return a failure result to the higher-layer business logic.
- Otherwise, if the connection state is not Processing Transaction (section 3.3.1.1.3):

- The application MUST return a failure result to the higher-layer business logic.
- Otherwise:
 - Initiate a new CONNTYPE_TXUSER_SETTXTIMEOUT (section 2.2.8.3.3) connection using the transaction manager **Name** field of the application.
 - Add the connection to the connection list of the transaction.
 - Send a TXUSER_SETTXTIMEOUT_MTAG_SETTXTIMEOUT (section 2.2.8.1.2.7) message using the CONNTYPE_TXUSER_SETTXTIMEOUT (section 2.2.8.3.3) connection:
 - Set the **guidTx** field to the **Transaction Object.Identifier** for the transaction.
 - Set the **dwTxTimeout** value to the time-out value that is provided by the higher-layer business logic, expressed as a total number of milliseconds.
 - Set the connection state to Awaiting Set Timeout Response (section 3.3.1.12.2).

3.3.4.2.2 Querying Transaction Manager's Support for Modifying a Transaction Timeout Using CONNTYPE_TXUSER_SETTXTIMEOUT2

The application MUST perform the following steps:

- Find an instance of a CONNTYPE_TXUSER_BEGIN2 (section 2.2.8.1.2) or CONNTYPE_TXUSER_PROMOTE (section 2.2.8.1.3) connection in the connection list of the transaction. This connection is referred to as the beginner connection.
- If a connection is not found:
 - The application MUST return a failure result to the higher-layer business logic.
- Otherwise, if the connection state is not Processing Transaction (section 3.3.1.2.3) or Processing Transaction (section 3.3.1.3.3):
 - The application MUST return a failure result to the higher-layer business logic.
- Otherwise:
 - Initiate a new CONNTYPE_TXUSER_SETTXTIMEOUT2 (section 2.2.8.3.4) connection using the **Transaction Manager Name** field of the application. This connection is referred to as the new connection.
 - Add the new connection to the transaction connection list.
 - Assign the transaction object to the **Connection-Specific Data** field of the new connection.
 - Send a TXUSER_SETTXTIMEOUT_MTAG_SETTXTIMEOUT (section 2.2.8.1.2.7) using the new connection:
 - The **guidTx** field MUST be set to a NULL GUID.
 - The **dwTxTimeout** value MUST be set to zero.
 - Set the new connection state to Awaiting Set Timeout Response (section 3.3.1.13.2).
 - Set the beginner connection state to Awaiting Set Timeout Response (section 3.3.1.2.4) if the beginner connection is CONNTYPE_TXUSER_BEGIN2, or to Awaiting Set Timeout Response (section 3.3.1.3.4) if the beginner connection is CONNTYPE_TXUSER_PROMOTE.

3.3.4.3 Obtaining a Propagation Token for a Transaction

If the higher-layer business logic decides to obtain a Propagation Token for a transaction, the application MUST perform the following actions:

- Find a CONNTYPE_TXUSER_PROMOTE, CONNTYPE_TXUSER_BEGINNER, or CONNTYPE_TXUSER_BEGIN2 connection in the transaction connection list.
- If the connection is not found,
 - The application MUST return a failure result to the higher-layer business logic.
- Otherwise,
 - Create a new Propagation Token structure.
 - The **dwVersionMin** field MUST be set to 1.
 - The **dwVersionMax** field MUST be set to the maximum supported protocol version, as specified in section 3.1.4.1.
 - The **guidTx** field MUST be set to the **Transaction Object.Identifier** value of the provided Transaction object.
 - The **isoLevel** field MUST be set to the **Isolation Level** value of the provided Transaction object.
 - The **isoFlags** field MUST be set to the **Isolation Flags** value of the provided Transaction object.
 - The **cbSourceTmAddr** field MUST be set as specified in section 2.2.5.4.
 - The **szDesc** field MUST be set to the **Description** value of the provided Transaction object.
 - The **NameObject** field MUST be set to the **Transaction Manager Name** of the application.
 - The **AssociateMsgVersion2** field MUST be set as specified in section 2.2.5.4.
 - The **AssociateMsgVersion3** field MUST be set as specified in section 2.2.5.4.
 - Return the new Propagation Token structure and the total size of the new Propagation Token structure to the higher-layer business logic.

3.3.4.4 Creating an Export Connection

If the higher-layer business logic initiates a push propagation by using a specified SWhereabouts structure, the application MUST perform the following actions:

- If the transaction manager of the application supports the CONNTYPE_TXUSER_EXPORT2 connection type as specified in section 2.2.1.1.1:
 - Initiate a new CONNTYPE_TXUSER_EXPORT2 (section 2.2.8.2.2.3) connection by using the **Transaction Manager Name** field of the application.
- Otherwise:
 - Initiate a new CONNTYPE_TXUSER_EXPORT (section 2.2.8.2.2.2) connection by using the **Transaction Manager Name** field of the application.

- Add the connection to the transaction connection list.
- If the negotiated protocol version of the previously initiated CONNTYPE_TXUSER_EXPORT connection supports the TXUSER_EXPORT_MTAG_CREATE2 (section 2.2.8.2.2.2.2) MTAG, as specified in 2.2.1.1.1:
 - Send a TXUSER_EXPORT_MTAG_CREATE2 message by using the connection.
- Otherwise:
 - Send a TXUSER_EXPORT_MTAG_CREATE (section 2.2.8.2.2.2.1) message using the connection:
- The **SourceTmAddr** field of the message MUST be set either to an OLETX_TM_ADDR (section 2.2.4.2) structure or a NAMEOBJECTBLOB (section 2.2.5.3) structure, as specified in section 2.2.1.1.1.
 - Find the STmToTmProtocol entries in the SWhereabouts structure corresponding to TmProtocolMsdtcV1 and TmProtocolMsdtcV2. See section 2.2.5.11 for more information.
 - If the **SourceTmAddr** field is an OLETX_TM_ADDR (section 2.2.4.2) structure, the fields of the OLETX_TM_ADDR structure MUST be set as follows:
 - The **guidSignature** field MUST be set as specified in section 2.2.4.2.
 - The **guidEndpoint** field MUST be set to the **guidEndpointID** field of the SDtcCmEndpointInfoV1 structure.
 - The **grbComProtsSupported** field MUST be set to the **comprotSupported** field of the SDtcCmEndpointInfoV1 structure.
 - If a TmProtocolMsdtcV2 entry was found:
 - The **wszHostName** field MUST be set to the **wszHostName** field of the SDtcCmEndpointInfoV2 structure.
 - Otherwise:
 - The **wszHostName** field MUST be set to the **szHostName** field of the SDtcCmEndpointInfoV1 structure and converted to Unicode little-endian UTF-16 encoding. This field MUST NOT contain a Unicode byte-order-mark (BOM) character.
 - Otherwise, if the **SourceTmAddr** field is a NAMEOBJECTBLOB structure, the fields of the NAMEOBJECTBLOB structure MUST be set as follows:
 - The **szGuid** field MUST be set to the **guidEndpointID** field of the SDtcCmEndpointInfoV1 structure and formatted as a string, as specified in [C706] appendix A.
 - The **grbComProtsSupported** field MUST be set to the **comprotSupported** field of the SDtcCmEndpointInfoV1 structure.
 - The **szHostName** field MUST be set to the **szHostName** field of the SDtcCmEndpointInfoV1 structure.
 - The **dwcbHostName** and **dwReserved1** fields MUST be set as specified in section 2.2.5.3.
- Set the connection state to Awaiting Create Response.

3.3.4.5 Generating Trace Records for a Transaction Using CONNTYPE_TXUSER_TRACE

If the higher-layer business logic specifies that transaction trace records are to be generated to the trace file of the transaction manager for the higher-layer business logic specified transaction object, the application MUST perform the following steps:

- Initiate a new CONNTYPE_TXUSER_TRACE (section 2.2.8.3.5) connection by using the **Transaction Manager Name** field of the application.
- Send a TXUSER_TRACE_MTAG_DUMP_TRANSACTION (section 2.2.8.3.5.1) message:
 - The **guidTx** field MUST be set to the **Transaction Object.Identifier** of the provided transaction.
- Set the connection state to Awaiting Trace Response.

3.3.4.6 Importing a Transaction

If the higher-layer business logic specifies that a transaction be imported by using an STxInfo (section 2.2.5.10) structure, the application MUST perform the following steps:

- If the transaction manager of the application supports the CONNTYPE_TXUSER_IMPORT2 connection type as specified in section 2.2.1.1.1:
 - The application MUST attempt to import the transaction by using CONNTYPE_TXUSER_IMPORT2 (section 2.2.8.2.2.5).
- Otherwise:
 - The application MUST attempt to import the transaction by using CONNTYPE_TXUSER_IMPORT (section 2.2.8.2.2.4).

3.3.4.6.1 Importing a Transaction Using CONNTYPE_TXUSER_IMPORT

The application MUST perform the following actions:

- Initiate a new CONNTYPE_TXUSER_IMPORT (section 2.2.8.2.2.4) connection using the **Transaction Manager Name** field of the application.
- Get the transaction identifier from the provided STxInfo (section 2.2.5.10) structure.
 - If the **guidSignature** field of the provided STxInfo structure is set to the binary value representation of the GUID {2adb4463-bd41-11d0-b12e-00c04fc2f3ef}
 - The transaction identifier MUST be set to the **uowTx** field of the provided STxInfo structure.
 - Otherwise,
 - The transaction identifier MUST be set to the **guidSignature** field of the provided STxInfo structure.
- Create a new transaction object that uses the transaction identifier obtained from the provided STxInfo structure.
- Add the connection to the transaction connection list.
- Set the **Connection-Specific Data** field of the connection to reference the new transaction object.
- Send a TXUSER_IMPORT_MTAG_IMPORT (section 2.2.8.2.2.4.3) message using the connection:

- The **guidTx** field MUST be set to the transaction identifier obtained from the provided STxInfo (section 2.2.5.10) structure.
- Set the connection state to Awaiting Import Response.

3.3.4.6.2 Importing a Transaction Using CONNTYPE_TXUSER_IMPORT2

The application MUST perform the following actions:

- Initiate a new CONNTYPE_TXUSER_IMPORT2 (section 2.2.8.2.2.5) connection using the **Transaction Manager Name** field of the application.
- Get the transaction identifier from the provided STxInfo (section 2.2.5.10) structure, as specified in section 3.3.4.6.1.
- Create a new transaction object that uses the transaction identifier obtained from the provided STxInfo structure.
- Add the connection to the transaction connection list.
- Set the **Connection-Specific Data** field of the connection to reference the new transaction object.
- Send a TXUSER_IMPORT2_MTAG_IMPORT (section 2.2.8.2.2.5.2) message using the connection:
 - The **guidTx** field MUST be set to the transaction identifier obtained from the provided STxInfo (section 2.2.5.10) structure.
- Set the connection state to Awaiting Import Response.

3.3.4.7 Importing a Transaction with Additional Transaction Attributes

If the higher-layer business logic specifies that a transaction be imported by using a StxInfo (section 2.2.5.10) structure and that additional transaction attributes be set, the application MUST perform the following steps:

- If the transaction manager of the application does not support the CONNTYPE_TXUSER_IMPORT2 (section 2.2.8.2.2.5) connection type, as specified in section 2.2.1.1.1.
 - Return a failure result to the higher-layer business logic.
- Otherwise:
 - Initiate a new CONNTYPE_TXUSER_IMPORT2 connection using the **Transaction Manager Name** field of the application.
 - Get the transaction identifier from the provided STxInfo structure, as specified in section 3.3.4.6.1.
 - Create a new transaction object that uses the transaction identifier obtained from the provided STxInfo structure.
 - Add the connection to the transaction connection list.
 - Set the **Connection-Specific Data** field of the connection to reference the new transaction object.
 - Send a TXUSER_IMPORT2_MTAG_IMPORT_WITH_SET (section 2.2.8.2.2.5.3) message, using the connection:

- The **guidTx** field MUST be set to the transaction identifier obtained from the provided STxInfo (section 2.2.5.10) structure.
- The **isoLevel** field MUST be set to the provided isolation-level value. The **isoFlags** field MUST be set to the provided isolation flags value. The **szDesc** field MUST be set to the provided description string.
- Set the connection state to Awaiting Import Response (section 3.3.1.7.2).

3.3.4.8 Initiating Transaction Commit

If the higher-layer business logic initiates the commit of an existing transaction, the application MUST perform the following steps:

- Find a CONNTYPE_TXUSER_PROMOTE, CONNTYPE_TXUSER_BEGINNER, or CONNTYPE_TXUSER_BEGIN2 connection in the transaction connection list.
- If a CONNTYPE_TXUSER_PROMOTE is found:
 - The application MUST attempt to complete the transaction by using CONNTYPE_TXUSER_PROMOTE.
- Otherwise, if a CONNTYPE_TXUSER_BEGINNER is found:
 - The application MUST attempt to complete the transaction by using CONNTYPE_TXUSER_BEGINNER.
- Otherwise, if a CONNTYPE_TXUSER_BEGIN2 is found:
 - The application MUST attempt to complete the transaction by using CONNTYPE_TXUSER_BEGIN2.
- Otherwise:
 - The application MUST return a failure result to the higher-layer business logic.

3.3.4.8.1 Commit a Transaction Using CONNTYPE_TXUSER_BEGIN2

The application MUST perform the following actions:

- If the connection state is not Processing Transaction:
 - Return a failure result to the higher-layer business logic.
- Otherwise:
 - Send a TXUSER_BEGIN2_MTAG_COMMIT (section 2.2.8.1.2.3) message using the CONNTYPE_TXUSER_BEGIN2 (section 2.2.8.1.2) connection:
 - Set the connection state to Awaiting Commit Response.

3.3.4.8.2 Commit a Transaction Using CONNTYPE_TXUSER_BEGINNER

The application MUST perform the following actions:

- If the state of the connection is not Processing Transaction:
 - Return a failure result to the higher-layer business logic.
- Otherwise:

- Send a TXUSER_BEGINNER_MTAG_COMMIT (section 2.2.8.1.1.6) message using the CONNTYPE_TXUSER_BEGINNER (section 2.2.8.1.1) connection:
 - The **grfRM** field MUST be set to an implementation-defined GRFRM (section 2.2.7.1) value.
 - The **fAsyncFull** field MUST be set to 0.
- Set the connection state to Awaiting Commit Response.

3.3.4.8.3 Commit a Transaction Using CONNTYPE_TXUSER_PROMOTE

The application MUST perform the following actions:

- If the state of the connection is not Processing Transaction:
 - Return a failure result to the higher-layer business logic.
- Otherwise:
 - Send a TXUSER_BEGIN2_MTAG_COMMIT (section 2.2.8.1.2.3) message using the CONNTYPE_TXUSER_PROMOTE (section 2.2.8.1.3) connection:
 - The **grfRM** field MUST be set to an implementation-defined GRFRM (section 2.2.7.1) value.
 - Set the connection state to Awaiting Commit Response.

3.3.4.9 Initiating Transaction Rollback

If the higher-layer business logic initiates the rollback of an existing transaction, the application MUST perform the following steps:

- Find a CONNTYPE_TXUSER_PROMOTE, CONNTYPE_TXUSER_BEGIN2, CONNTYPE_TXUSER_BEGINNER, CONNTYPE_TXUSER_IMPORT2, or CONNTYPE_TXUSER_IMPORT connection in the transaction connection list.
- If a CONNTYPE_TXUSER_PROMOTE is found:
 - The application MUST attempt to roll back a transaction by using CONNTYPE_TXUSER_PROMOTE.
- Otherwise, if a CONNTYPE_TXUSER_BEGIN2 is found:
 - The application MUST attempt to roll back a transaction by using CONNTYPE_TXUSER_BEGIN2.
- Otherwise, if a CONNTYPE_TXUSER_BEGINNER is found:
 - The application MUST attempt to roll back a transaction by using CONNTYPE_TXUSER_BEGINNER.
- Otherwise, if a CONNTYPE_TXUSER_IMPORT2 is found:
 - The application MUST attempt to roll back a transaction by using CONNTYPE_TXUSER_IMPORT2.
- Otherwise, if a CONNTYPE_TXUSER_IMPORT is found:
 - The application MUST attempt to roll back a transaction by using CONNTYPE_TXUSER_IMPORT.

- Otherwise, the application MUST return a failure result to the higher-layer business logic.

3.3.4.9.1 Abort a Transaction Using CONNTYPE_TXUSER_BEGIN2

The application MUST perform the following actions:

- If the connection state is not Processing Transaction:
 - Return a failure result to the higher-layer business logic.
- Otherwise:
 - Send a TXUSER_BEGIN2_MTAG_ABORT (section 2.2.8.1.2.1) message using the CONNTYPE_TXUSER_BEGIN2 (section 2.2.8.1.2) connection.
 - Set the connection state to Awaiting Abort Response.

3.3.4.9.2 Abort a Transaction Using CONNTYPE_TXUSER_BEGINNER

The application MUST perform the following actions:

- If the connection state is not Processing Transaction:
 - Return a failure result to the higher-layer business logic.
- Otherwise:
 - Send a TXUSER_BEGINNER_MTAG_ABORT (section 2.2.8.1.1.1) message using the CONNTYPE_TXUSER_BEGINNER (section 2.2.8.1.1) connection:
 - The guidReason field MUST be set to the value that is provided by the higher-layer business logic, as specified in section 2.2.8.1.1.1.
 - Set the connection state to Awaiting Abort Response.

3.3.4.9.3 Abort a Transaction Using CONNTYPE_TXUSER_IMPORT

The application MUST perform the following actions:

- If the connection state is not Transaction Import Successful:
 - Return a failure result to the higher-layer business logic.
- Otherwise:
 - Send a TXUSER_IMPORT_MTAG_ABORT (section 2.2.8.2.4.1) message using the CONNTYPE_TXUSER_IMPORT (section 2.2.8.2.4) connection:
 - The **guidReason** field MUST be set to the value that is provided by the higher-layer business logic, as specified in section 2.2.8.2.4.1.
 - Set the connection state to Awaiting Abort Response.

3.3.4.9.4 Abort a Transaction Using CONNTYPE_TXUSER_IMPORT2

The application MUST perform the following actions:

- If the connection state is not Transaction Import Successful:
 - Return a failure result to the higher-layer business logic.

- Otherwise:
 - Send a TXUSER_IMPORT2_MTAG_ABORT (section 2.2.8.2.2.5.1) message using the CONNTYPE_TXUSER_IMPORT2 (section 2.2.8.2.2.5) connection:
 - Set the connection state to Awaiting Abort Response.

3.3.4.9.5 Roll Back a Transaction Using CONNTYPE_TXUSER_PROMOTE

The application MUST perform the following actions:

- If the connection state is not Processing Transaction:
 - Return a failure result to the higher-layer business logic.
- Otherwise:
 - Send a TXUSER_BEGIN2_MTAG_ABORT (section 2.2.8.1.2.1) message using the CONNTYPE_TXUSER_PROMOTE (section 2.2.8.1.3) connection.
 - Set the connection state to Awaiting Abort Response.

3.3.4.10 Obtaining Extended Whereabouts Using CONNTYPE_TXUSER_EXTENDEDCONNECTIONS

If the higher-layer business logic wants to obtain extended whereabouts for a transaction manager, the application MUST perform the following actions:

- Initiate a new CONNTYPE_TXUSER_EXTENDEDCONNECTIONS (section 2.2.8.2.2.1) connection using the **Transaction Manager Name** field of the application.
- Send a TXUSER_EXTENDEDCONNECTIONS_MTAG_GET (section 2.2.8.2.2.1.1) message using the connection.
- Set the connection state to Awaiting Get Response.

3.3.4.11 Obtaining the Security Configuration of the Transaction Manager Using CONNTYPE_TXUSER_GETSECURITYFLAGS

If the higher-layer business logic wants to obtain the security configuration of the transaction manager, the application MUST perform the following steps:

- Initiate a new CONNTYPE_TXUSER_GETSECURITYFLAGS (section 2.2.8.4.1) connection by using the **Transaction Manager Name** field of the application.
- Send a TXUSER_GETSECURITYFLAGS_MTAG_GETSECURITYFLAGS (section 2.2.8.4.1.2) message.
- Set the connection state to Awaiting Get Response.

3.3.4.11.1 Obtaining the Details for a Transaction

If the higher-layer business logic wants to obtain the details for a transaction, the application MUST perform the following steps:

- Initiate a new CONNTYPE_TXUSER_GETTXDETAILS (section 2.2.8.3.1) connection by using the **Transaction Manager Name** field of the application.
- Add the connection to the connection list of the transaction.
- Send a TXUSER_GETTXDETAILS_MTAG_GET (section 2.2.8.3.1.1) message using the connection:

- The **guidTx** field MUST be set to the provided **Transaction Object.Identifier**.
- Set the connection state to Awaiting Response.

3.3.4.12 Pulling a Transaction

If the higher-layer business logic wants to perform pull propagation of a transaction by using a `Propagation-Token` (section 2.2.5.4) structure, the application MUST perform the following actions:

- Initiate a new `CONNTYPE_TXUSER_ASSOCIATE` connection using the **Transaction Manager Name** field of the application.
- Create a new transaction object that uses the **guidTx** field of the `Propagation-Token` as the transaction identifier.
- Add the connection to the connection list of the new transaction object.
- Set the **Connection-Specific Data** field of the connection to the new transaction object.
- Send a `TXUSER_ASSOCIATE_MTAG_ASSOCIATE` message using the connection:
 - The **guidTx** field MUST be set to the **guidTx** field of the `Propagation-Token`.
 - The **isoLevel** field MUST be set to the **isoLevel** field of the `Propagation-Token`.
 - The **isoFlags** field MUST be set to the **isoFlags** field of the `Propagation-Token`.
 - The **szDesc** field MUST be set to the **szDesc** field of the `Propagation-Token`.
 - The **SourceTmAddr** field in the message MUST be set from either an `OLETX_TM_ADDR` structure or a `NAMEOBJECTBLOB` structure, as specified in section 2.2.1.1.1:
 - If the **SourceTmAddr** field is an `OLETX_TM_ADDR` structure, the `OLETX_TM_ADDR` structure fields MUST be set as follows:
 - The **guidSignature** field MUST be set as specified in section 2.2.4.2.
 - The **guidEndpoint** field MUST be set to the `szGuid` field of the `NameObject` field within the `Propagation-Token`, converted from a string to a GUID as specified in [C706] appendix A.
 - The **grbComProtsSupported** field MUST be set to the `Propagation-Token`'s `NameObject` field's **grbComProtsSupported** field.
 - If the **dwVersionMax** field of the `Propagation-Token` is at least 2:
 - The **wszHostName** field MUST be set to the **Propagation-Token.NameObject.szHostName** field.
 - Otherwise:
 - The **wszHostName** field MUST be set to the **Propagation-Token.NameObject.szHostName** field, converted to little-endian UTF-16 encoding. This field MUST NOT contain a Unicode BOM character.
 - Otherwise, if the **SourceTmAddr** field is a `NAMEOBJECTBLOB` structure, the `NAMEOBJECTBLOB` structure fields MUST be set to the same values as the **NameObject** field of the `Propagation-Token`.
 - The **cbSourceTmAddr** field MUST be set as specified in section 2.2.8.2.1.1.1.

- Set the connection state to Awaiting Associate Response.

3.3.4.13 Push a Transaction Using an Existing Export Connection

If the higher-layer business logic decides to export a transaction by using an existing export connection, the application MUST perform the following actions:

- If the provided connection state is not Connection Active:
 - Return a failure result to the higher-layer business logic.
- Otherwise:
 - Send a TXUSER_EXPORT_MTAG_EXPORT (section 2.2.8.2.2.2.6) message using the provided connection:
 - The **guidTX** field MUST be set to the provided **Transaction Object.Identifier** field of the transaction object.
 - Set the connection state to Awaiting Export Response.

3.3.4.14 Obtaining a Transaction Cookie Using an Existing Export Connection

If the higher-layer business logic obtains a transaction cookie by using an existing export connection, the application MUST perform the following actions:

- If the provided connection state is not Connection Active:
 - Return a failure result to the higher-layer business logic.
- Otherwise:
 - If the provided transaction cookie size is equal to the size of **STxInfo** structure:
 - Create a new **STxInfo** structure.
 - The **guidSignature** field MUST be set as specified in section 2.2.4.2.
 - The **uowTx** field MUST be set to the **Transaction Object.Identifier** of the provided Transaction Object.
 - The **tmprotUsed** field MUST be set with the TM_PROTOCOL value specified in the whereabouts data of the export connection.
 - The **cbProtocolSpecificTxInfo** field MUST be set to zero.
 - Return the newly created **STxInfo** structure, the size of the **STxInfo** structure, and the success result to the higher-layer business logic.
 - Otherwise:
 - Return the **Transaction Object.Identifier** of the provided Transaction object, the size of GUID, and the success result to the higher-layer business logic.

3.3.4.15 Resolving a Transaction

If the higher-layer business logic determines that it needs to manually resolve the outcome of a transaction, the application MUST perform the following steps:

- If the transaction is not in either the Failed to Notify (section 3.2.1.3.13) or the In Doubt (section 3.2.1.3.12) state:
 - Return a failure result to the higher-layer business logic.
- Otherwise:
 - Initiate a new CONNTYPE_TXUSER_RESOLVE (section 2.2.8.3.2) connection using the **Transaction Manager Name** field of the application.
 - If the transaction is in the Failed to Notify (section 3.2.1.3.13) state:
 - Send a TXUSER_RESOLVE_MTAG_FORGET_COMMITTED (section 2.2.8.3.2.5) message using the connection:
 - The **guidTx** field MUST be set to the **Transaction Object.Identifier** of the provided transaction.
 - Set the connection state to Awaiting Forget Response (section 3.3.1.11.3).
 - Otherwise, if the transaction is in the In Doubt (section 3.2.1.3.12) state:
 - If the higher-layer business logic wants to manually resolve the transaction outcome as Commit:
 - Send a TXUSER_RESOLVE_MTAG_CHILD_COMMIT (section 2.2.8.3.2.3) message using the connection:
 - The **guidTx** field MUST be set to the **Transaction Object.Identifier** of the provided transaction.
 - Set the connection state to Awaiting Commit Response (section 3.3.1.1.4).
 - Otherwise, if the higher-layer business logic wants to manually resolve the transaction outcome as Abort:
 - Send a TXUSER_RESOLVE_MTAG_CHILD_ABORT (section 2.2.8.3.2.2) message using the connection:
 - The **guidTx** field MUST be set to the **Transaction Object.Identifier** of the provided transaction.
 - Set the connection state to Awaiting Abort Response (section 3.3.1.1.5).

3.3.5 Processing Events and Sequencing Rules

3.3.5.1 Transaction Initiation and Completion

3.3.5.1.1 CONNTYPE_TXUSER_BEGINNER as Initiator

For all messages that are received in this connection type, the application MUST process the message as specified in section 3.1. The application MUST also follow the processing rules that are specified in the following sections.

3.3.5.1.1.1 Receiving a TXUSER_BEGINNER_MTAG_BEGUN Message

When the application receives a TXUSER_BEGINNER_MTAG_BEGUN message, the application MUST perform the following actions:

- If the connection state is Awaiting Begin Response:

- Set the connection state to Processing Transaction.
- Create a transaction object that is initialized as follows:
 - Set the transaction **Transaction Object.Identifier** field to the **guidTx** field from the message.
 - Set the transaction **Root** field to true.
- Add the connection to the connection list of the transaction.
- Set the **Connection-Specific Data** field of the connection to the transaction object.
- Return a success result and a reference to the transaction object to the higher-layer business logic.
- Otherwise, the message MUST be processed as an invalid message as specified in section 3.1.6.

3.3.5.1.1.2 Receiving a TXUSER_BEGINNER_MTAG_BEGIN_NO_MEM or TXUSER_BEGINNER_MTAG_BEGIN_LOG_FULL Message

When the application receives either of these messages, the application MUST perform the following actions:

- If the connection state is Awaiting Begin Response:
 - Return a failure result to the higher-layer business logic.
 - Set the connection state to Ended.
- Otherwise, the message MUST be processed as an invalid message as specified in section 3.1.6.

3.3.5.1.1.3 Receiving a TXUSER_BEGINNER_MTAG_REQUEST_COMPLETED Message

When the application receives a TXUSER_BEGINNER_MTAG_REQUEST_COMPLETED message, the application MUST perform the following actions:

- If the connection state is Awaiting Commit Response:
 - Return a Transaction Committed result to the higher-layer business logic.
 - Set the connection state to Ended.
- If the connection state is Awaiting Abort Response:
 - Return a Transaction Aborted result to the higher-layer business logic.
 - Set the connection state to Ended.
- Otherwise, the message MUST be processed as an invalid message as specified in section 3.1.6.

3.3.5.1.1.4 Receiving a TXUSER_BEGINNER_MTAG_COMMIT_TOO_LATE Message

When the application receives a TXUSER_BEGINNER_MTAG_COMMIT_TOO_LATE message, the application MUST perform the following actions:

- If the connection state is Awaiting Commit Response:
 - Return a Transaction Aborted result to the higher-layer business logic.
 - Set the connection state to Ended.

- Otherwise, the message MUST be processed as an invalid message as specified in section 3.1.6.

3.3.5.1.1.5 Receiving a TXUSER_BEGINNER_MTAG_COMMIT_INDOUBT Message

When the application receives a TXUSER_BEGINNER_MTAG_COMMIT_INDOUBT (section 2.2.8.1.1.7) message, the application MUST perform the following actions:

- If the connection state is Awaiting Commit Response:
 - Return a transaction In Doubt (section 3.2.1.3.12) result to the higher-layer business logic.
 - Set the connection state to Ended.
- Otherwise, the message MUST be processed as an invalid message as specified in section 3.1.6.

3.3.5.1.1.6 Connection Disconnected

When a CONNTYPE_TXUSER_BEGINNER (section 2.2.8.1.1) connection is disconnected, the application MUST perform the following actions:

- If the connection state is Awaiting Begin Response:
 - Return a failure result to the higher-layer business logic.
- If the connection state is Awaiting Abort Response:
 - Return a transaction aborted result to the higher-layer business logic.
- If the connection state is Awaiting Commit Response:
 - Return a transaction In Doubt (section 3.2.1.3.12) result to the higher-layer business logic.
- Otherwise, the event MUST be processed as specified in section 3.1.8.3.

3.3.5.1.2 CONNTYPE_TXUSER_BEGIN2 as Initiator

For all messages that are received in this connection type, the application MUST process the message as specified in section 3.1. The application MUST also follow the processing rules that are specified in the following sections.

3.3.5.1.2.1 Receiving a TXUSER_BEGIN2_MTAG_SINK_BEGUN Message

When the application receives a TXUSER_BEGIN2_MTAG_SINK_BEGUN message, the application MUST perform the following actions:

- If the connection state is Awaiting Begin Response, the application MUST:
 - Set the connection state to Processing Transaction.
 - Create a transaction object that is initialized as follows:
 - Set the transaction **Transaction Object.Identifier** field to the **guidTx** field from the message.
 - Set the transaction **Root** field to true.
 - Add the connection to the transaction connection list.
 - Set the transaction field of the connection to the transaction.

- Return a success result and a reference to the transaction object to the higher-layer business logic.
- Otherwise, the message MUST be processed as an invalid message as specified in section 3.1.6.

3.3.5.1.2.2 Receiving a TXUSER_SETTXTIMEOUT_MTAG_REQUEST_COMPLETE Message

When the application receives a TXUSER_SETTXTIMEOUT_MTAG_REQUEST_COMPLETE message, the application MUST perform the following actions:

- If the connection state is Awaiting Set Timeout Response, the application MUST:
 - Set the connection state to Processing Transaction.
 - Return a success result to the higher-layer business logic.
- Otherwise, the message MUST be processed as an invalid message as specified in section 3.1.6.

3.3.5.1.2.3 Receiving a TXUSER_SETTXTIMEOUT_MTAG_TOO_LATE Message

When the application receives a TXUSER_SETTXTIMEOUT_MTAG_TOO_LATE message, the application MUST perform the following actions:

- If the connection state is Awaiting Set Timeout Response, the application MUST:
 - Set the connection state to Processing Transaction.
 - Return a failure result to the higher-layer business logic.
- Otherwise, the message MUST be processed as an invalid message as specified in section 3.1.6.

3.3.5.1.2.4 Receiving a TXUSER_SETTXTIMEOUT_MTAG_TX_NOT_FOUND Message

When the application receives a TXUSER_SETTXTIMEOUT_MTAG_TX_NOT_FOUND (section 2.2.8.3.3.1) message, the application MUST perform the following actions:

- If the connection state is Awaiting Set Timeout Response (section 3.3.1.2.4), the application MUST:
 - Set the connection state to Processing Transaction (section 3.3.1.2.3).
 - Return a failure result to the higher-layer business logic.
- Otherwise, the message MUST be processed as an invalid message, as specified in section 3.1.6.

3.3.5.1.2.5 Receiving a TXUSER_BEGIN2_MTAG_SINK_ERROR Message

When the application receives a TXUSER_BEGIN2_MTAG_SINK_ERROR message, the application MUST perform the following actions:

- If the connection state is Awaiting Begin Response:
 - If the **Error** field in the message is set to TRUN_TXBEGIN_ERROR_NO_MEM or TRUN_TXBEGIN_ERROR_BEGIN_LOG_FULL or TRUN_TXBEGIN_ERROR_DUPLICATE_GUID:
 - Return a failure result to the higher-layer business logic.
 - Set the connection state to Ended.

- Otherwise, the message MUST be processed as an invalid message as specified in section 3.1.6.
- If the connection state is Processing Transaction (section 3.3.1.2.3):
 - If the **Error** field of the message is set to TRUN_TXBEGIN_ERROR_NOTIFY_ABORTED:
 - Return a transaction aborted result to the higher-layer business logic.
 - Set the connection state to Ended.
 - Otherwise, the message MUST be processed as an invalid message as specified in section 3.1.6.
- If the connection state is Awaiting Commit Response:
 - If the **Error** field in the message is set to TRUN_TXBEGIN_ERROR_NOTIFY_COMMITTED or TRUN_TXBEGIN_ERROR_NOTIFY_ABORTED or TRUN_TXBEGIN_ERROR_NOTIFY_INDOUBT:
 - Return the corresponding transaction outcome as a result to the higher-layer business logic.
 - Set the connection state to Ended.
 - Otherwise, the message MUST be processed as an invalid message as specified in section 3.1.6.
- If the connection state is Awaiting Abort Response:
 - If the **Error** field of the message is set to TRUN_TXBEGIN_ERROR_NOTIFY_ABORTED:
 - Return a transaction aborted result to the higher-layer business logic.
 - Set the connection state to Ended.
 - Otherwise, the message MUST be processed as an invalid message as specified in section 3.1.6.
- If the Connection state is Awaiting Set Timeout Response:
 - If the **Error** field of the message is set to TRUN_TXBEGIN_ERROR_NOTIFY_ABORTED:
 - Return a Transaction Aborted result to the higher-layer business logic.
 - Set the connection state to Ended.
 - Otherwise, the message MUST be processed as an invalid message as specified in section 3.1.6.
- Otherwise, the message MUST be processed as an invalid message as specified in section 3.1.6.

3.3.5.1.2.6 Connection Disconnected

When a CONNTYPE_TXUSER_BEGIN2 connection is disconnected, the application MUST perform the following actions:

- If the connection state is Awaiting Begin Response:
 - Return a failure result to the higher-layer business logic.
- If the connection state is Awaiting Set Timeout Response, Processing Transaction, or Awaiting Abort Response:

- Return a transaction aborted result to the higher-layer business logic.
- If the connection state is Awaiting Commit Response:
 - Return a transaction In Doubt (section 3.2.1.3.12) result to the higher-layer business logic.
- Otherwise, the event MUST be processed as specified in section 3.1.8.3.

3.3.5.1.3 CONNTYPE_TXUSER_PROMOTE as Initiator

Unless stated otherwise in this section, the CONNTYPE_TXUSER_PROMOTE (section 2.2.8.1.3) connection type that is acting as an initiator MUST follow the same message processing rules as the CONNTYPE_TXUSER_BEGIN2 (section 2.2.8.1.2) connection type that is acting as an initiator, as specified in CONNTYPE_TXUSER_BEGIN2 as Initiator (section 3.3.5.1.2).

3.3.5.1.3.1 Receiving a TXUSER_BEGIN2_MTAG_SINK_BEGUN Message

When the application receives a TXUSER_BEGIN2_MTAG_SINK_BEGUN message, the application MUST perform the following actions:

- If the connection state is Awaiting Promote Response (section 3.3.1.3.2), the application MUST:
 - Set the connection state to Processing Transaction (section 3.3.1.3.3).
 - Create a transaction object that is initialized as follows:
 - Set the transaction **Transaction Object.Identifier** field to the **guidTx** field from the message. The **guidTx** MUST be the same value as the **guidTx** field in TXUSER_BEGINNER_MTAG_PROMOTE (section 2.2.8.1.3.1) message that was sent to the transaction manager.
 - Set the transaction **Root** field to true.
 - Add the connection to the transaction connection list.
 - Set the transaction field of the connection to the transaction.
 - Return a success result and a reference to the transaction object to the higher-layer business logic.
- Otherwise, the message MUST be processed as an invalid message as specified in section 3.1.6.

3.3.5.1.3.2 Receiving a TXUSER_BEGIN2_MTAG_SINK_ERROR Message

When the application receives a TXUSER_BEGIN2_MTAG_SINK_ERROR message, the application MUST perform the following actions:

- If the connection state is Awaiting Promote Response (section 3.3.1.3.2):
 - If the **Error** field in the message is set to **TRUN_TXBEGIN_ERROR_NO_MEM** or **TRUN_TXBEGIN_ERROR_BEGIN_LOG_FULL** or **TRUN_TXBEGIN_ERROR_DUPLICATE_GUID**:
 - Return a failure result to the higher-layer business logic.
 - Set the connection state to Ended (section 3.3.1.3.7).
 - Otherwise, the message MUST be processed as an invalid message as specified in section 3.1.6.
- Otherwise,

- The application MUST follow the same message processing rules as the CONNTYPE_TXUSER_BEGIN2 connection type acting as an acceptor as specified in Receiving a TXUSER_BEGIN2_MTAG_SINK_ERROR Message (section 3.3.5.1.2.5).

3.3.5.2 Transaction Propagation

3.3.5.2.1 Pull Propagation

3.3.5.2.1.1 CONNTYPE_TXUSER_ASSOCIATE as Initiator

For all messages that are received in this connection type, the application MUST process the messages as specified in section 3.1.

The application MUST also follow the processing rules that are specified in the following sections.

3.3.5.2.1.1.1 Receiving a TXUSER_ASSOCIATE_MTAG_ASSOCIATED Message

When the application receives a TXUSER_ASSOCIATE_MTAG_ASSOCIATED message, the application MUST perform the following actions:

- If the connection state is Awaiting Associate Response, the application MUST:
 - Set the connection state to Active (section 3.3.1.4.3).
 - Return a success result and a reference to the transaction object that is referenced by this connection's Connection-Specific Data field to the higher-layer business logic.
- Otherwise, the message MUST be processed as an invalid message as specified in section 3.1.6.

3.3.5.2.1.1.2 Receiving Other TXUSER_ASSOCIATE_MTAG Messages

When the application receives one of these messages:

- TXUSER_ASSOCIATE_MTAG_TX_NOT_FOUND
- TXUSER_ASSOCIATE_MTAG_TOO_LATE
- TXUSER_ASSOCIATE_MTAG_CREATE_BAD_TMADDR
- TXUSER_ASSOCIATE_MTAG_LOG_FULL_LOCAL
- TXUSER_ASSOCIATE_MTAG_NO_MEM_LOCAL
- TXUSER_ASSOCIATE_MTAG_LOG_FULL_REMOTE
- TXUSER_ASSOCIATE_MTAG_NO_MEM_REMOTE
- TXUSER_ASSOCIATE_MTAG_TOO_MANY_REMOTE
- TXUSER_ASSOCIATE_MTAG_TOO_MANY_LOCAL

the application MUST perform the following actions:

- If the connection state is Awaiting Associate Response:
 - Set the connection state to Ended.
 - Return a failure result to the higher-layer business logic.
- Otherwise, the message MUST be processed as an invalid message as specified in section 3.1.6.

3.3.5.2.1.1.3 Receiving a TXUSER_IMPORT2_MTAG_SINK_ERROR Message

When the application receives a TXUSER_IMPORT2_MTAG_SINK_ERROR message, the application MUST perform the following actions:

- If the connection state is Active:
 - If the **Error** field in the message is set to TRUN_TXBEGIN_ERROR_NOTIFY_COMMITTED, TRUN_TXBEGIN_ERROR_NOTIFY_ABORTED, or TRUN_TXBEGIN_ERROR_NOTIFY_INDOUBT:
 - Notify the higher-layer business logic of the outcome of the transaction.
 - Set the connection state to Ended.
 - Otherwise, the message MUST be processed as an invalid message as specified in section 3.1.6.
- Otherwise, the message MUST be processed as an invalid message as specified in section 3.1.6.

3.3.5.2.1.1.4 Connection Disconnected

When a CONNTYPE_TXUSER_ASSOCIATE (section 2.2.8.2.1.1) connection is disconnected, the application MUST perform the following actions:

- If the connection state is Awaiting Associate Response:
 - Return a failure result to the higher-layer business logic.
- Otherwise, the event MUST be processed as specified in section 3.1.8.3.

3.3.5.2.2 Push Propagation

3.3.5.2.2.1 CONNTYPE_TXUSER_EXTENDEDWHEREABOUTS as Initiator

For all messages that are received in this connection type, the application MUST process the message as specified in section 3.1. The application MUST also follow the processing rules as specified in the following sections.

3.3.5.2.2.1.1 Receiving a TXUSER_EXTENDEDWHEREABOUTS_MTAG_GOT Message

When the application receives a TXUSER_EXTENDEDWHEREABOUTS_MTAG_GOT message, the application MUST perform the following actions:

- If the connection state is Awaiting Get Response:
 - Create a new SWhereabouts structure.
 - Set the **guidSignature** field to the GUID value {2adb4462-bd41-11d0-b12e-00c04fc2f3ef}.
 - Set the **cTmToTmProtocols** field to the **dwProtocolCount** field of the message.
 - Set the **rgtmprotUsableList** field to the **rgtmprotUsableList** field of the message.
 - Return a success result and the new SWhereabouts structure to the higher-layer business logic.
 - Set the connection state to Ended.
- Otherwise, the message MUST be processed as an invalid message as specified in section 3.1.6.

3.3.5.2.2.1.2 Receiving a TXUSER_EXTENDEDCONNECTION_MTAG_NOMEM Message

When the application receives a TXUSER_EXTENDEDCONNECTION_MTAG_NOMEM message, the application MUST perform the following actions:

- If the connection state is Awaiting Get Response:
 - Return a failure result to the higher-layer business logic.
 - Set the connection state to Ended.
- Otherwise, the message MUST be processed as an invalid message as specified in section 3.1.6.

3.3.5.2.2.1.3 CONNTYPE_TXUSER_EXTENDEDCONNECTION Disconnected

When a CONNTYPE_TXUSER_EXTENDEDCONNECTION (section 2.2.8.2.2.1) connection is disconnected, the application MUST perform the following actions:

- If the connection state is Awaiting Get Response:
 - Return a failure result to the higher-layer business logic.
- Otherwise, the event MUST be processed as specified in section 3.1.8.3.

3.3.5.2.2.2 CONNTYPE_TXUSER_EXPORT as Initiator

For all messages that are received in this connection type, the application MUST process the message as specified in section 3.1. The application MUST also follow the processing rules as specified in the following sections.

3.3.5.2.2.2.1 Receiving a TXUSER_EXPORT_MTAG_CREATED Message

When the application receives a TXUSER_EXPORT_MTAG_CREATED message, the application MUST perform the following actions:

- If the connection state is Awaiting Create Response:
 - Set the connection state to Connection Active.
 - Return a success result to the higher-layer business logic.
- Otherwise, the message MUST be processed as an invalid message as specified in section 3.1.6.

3.3.5.2.2.2.2 Receiving a TXUSER_EXPORT_MTAG_CREATE_BAD_TMADDR or TXUSER_EXPORT_MTAG_CREATE_NET_TX_DISABLED Message

When the application receives one of these messages, the application MUST perform the following actions:

- If the connection state is Awaiting Create Response:
 - Return a failure result to the higher-layer business logic.
 - Set the connection state to Ended.
- Otherwise, the message MUST be processed as an invalid message as specified in section 3.1.6.

3.3.5.2.2.2.3 Receiving a TXUSER_EXPORT_MTAG_EXPORTED Message

When the application receives a TXUSER_EXPORT_MTAG_EXPORTED message, the application MUST perform the following actions:

- If the connection state is Awaiting Export Response:
 - Set the connection state to Connection Active.
 - Return a success result to the higher-layer business logic.
 - If the application uses OLETX_TM_ADDR (section 2.2.1.1.1) for creating an Export Connection:
 - Compute the size of **STxInfo** structure in bytes and return the size of the **STxInfo** structure to the higher-layer business logic.
 - Otherwise:
 - Compute the size of GUID in bytes and return the size of the GUID to the higher-layer business logic.
- Otherwise, the message MUST be processed as an invalid message as specified in section 3.1.6.

3.3.5.2.2.2.4 Receiving a TXUSER_EXPORT_MTAG_EXPORT_LOG_FULL, TXUSER_EXPORT_MTAG_EXPORT_NO_MEM, TXUSER_EXPORT_MTAG_EXPORT_TOO_LATE, TXUSER_EXPORT_MTAG_EXPORT_TOO_MANY, or TXUSER_EXPORT_MTAG_EXPORT_NOT_FOUND Message

When the application receives one of these messages, the application MUST perform the following actions:

- If the connection state is Awaiting Export Response, the application MUST:
 - Set the connection state to Connection Active.
 - Return a failure result to the higher-layer business logic.
- Otherwise, the message MUST be processed as an invalid message as specified in section 3.1.6.

3.3.5.2.2.2.5 CONNTYPE_TXUSER_EXPORT Connection Disconnected

When a CONNTYPE_TXUSER_EXPORT (section 2.2.8.2.2.2) connection is disconnected, the application MUST perform the following additional actions:

- If the connection state is Awaiting Create Response or Awaiting Export Response:
 - Return a failure result to the higher-layer business logic.
- Otherwise, the event MUST be processed as specified in section 3.1.8.3.

3.3.5.2.2.3 CONNTYPE_TXUSER_EXPORT2 as Initiator

For all messages that are received in this connection type, the application MUST process the message as specified in section 3.1. The application MUST also follow the processing rules as specified in the following sections.

3.3.5.2.2.3.1 Receiving a TXUSER_EXPORT_MTAG_CREATED Message

When the application receives a TXUSER_EXPORT_MTAG_CREATED message, the application MUST perform the actions specified in section 3.3.5.2.2.2.1.

3.3.5.2.2.3.2 Receiving a TXUSER_EXPORT_MTAG_CREATE_BAD_TMADDR or TXUSER_EXPORT_MTAG_CREATE_NET_TX_DISABLED Message

When the application receives one of these messages, the application MUST perform the actions specified in section 3.3.5.2.2.2.2.

3.3.5.2.2.3.3 Receiving a TXUSER_EXPORT_MTAG_EXPORTED Message

When the application receives one of these messages, the application MUST perform the actions specified in section 3.3.5.2.2.2.3.

3.3.5.2.2.3.4 Receiving a TXUSER_EXPORT_MTAG_EXPORT_LOG_FULL, TXUSER_EXPORT_MTAG_EXPORT_NO_MEM, TXUSER_EXPORT_MTAG_EXPORT_TOO_LATE, TXUSER_EXPORT_MTAG_EXPORT_TOO_MANY, TXUSER_EXPORT_MTAG_EXPORT_NOT_FOUND, or TXUSER_EXPORT_MTAG_EXPORT_COMM_FAILED Message

When the application receives one of these messages, the application MUST perform the actions specified in section 3.3.5.2.2.2.4.

3.3.5.2.2.3.5 CONNTYPE_TXUSER_EXPORT2 Connection Disconnected

When a CONNTYPE_TXUSER_EXPORT2 (section 2.2.8.2.2.3) connection is disconnected, the application MUST perform the following additional actions:

- If the connection state is Awaiting Create Response or Awaiting Export Response:
 - Return a failure result to the higher-layer business logic.
- Otherwise, the event MUST be processed as specified in section 3.1.8.3.

3.3.5.2.2.4 CONNTYPE_TXUSER_IMPORT as Initiator

For all messages that are received in this connection type, the application MUST process the messages as specified in section 3.1. The application MUST also follow the processing rules as specified in the following sections.

3.3.5.2.2.4.1 Receiving a TXUSER_IMPORT_MTAG_IMPORTED Message

When the application receives a TXUSER_IMPORT_MTAG_IMPORTED message, the application MUST perform the following actions:

- If the connection state is Awaiting Import Response:
 - Set the connection state to Transaction Import Successful.
 - Return a success result and a reference to the transaction object to the higher-layer business logic.
- Otherwise, the message MUST be processed as an invalid message as specified in section 3.1.6.

3.3.5.2.2.4.2 Receiving a TXUSER_IMPORT_MTAG_IMPORT_TX_NOT_FOUND Message

When the application receives a TXUSER_IMPORT_MTAG_IMPORT_TX_NOT_FOUND message, the application MUST perform the following actions:

- If the connection state is Awaiting Import Response:

- Set the connection state to Ended.
- Return a failure result to the higher-layer business logic.
- Otherwise, the message MUST be processed as an invalid message as specified in section 3.1.6.

3.3.5.2.2.4.3 Receiving a TXUSER_IMPORT_MTAG_ABORT_TOO_LATE Message.

When the application receives a TXUSER_IMPORT_MTAG_IMPORT_TOO_LATE message, the application MUST perform the following actions:

- If the connection state is Awaiting Abort Response:
 - Set the connection state to Ended.
 - Return a failure result to the higher-layer business logic.
- Otherwise, the message MUST be processed as an invalid message as specified in section 3.1.6.

3.3.5.2.2.4.4 Receiving a TXUSER_IMPORT_MTAG_REQUEST_COMPLETED Message

When the application receives a TXUSER_IMPORT_MTAG_REQUEST_COMPLETED message, the application MUST perform the following actions:

- If the connection state is Awaiting Abort Response:
 - Set the connection state to Ended.
 - Return a success result to the higher-layer business logic.
- Otherwise, the message MUST be processed as an invalid message as specified in section 3.1.6.

3.3.5.2.2.4.5 Connection Disconnected

When a CONNTYPE_TXUSER_IMPORT (section 2.2.8.2.2.4) connection is disconnected, the application MUST perform the following actions:

- If the connection state is Awaiting Import Response or Awaiting Abort Response:
 - Return a failure result to the higher-layer business logic.
- Otherwise, the event MUST be processed as specified in section 3.1.8.3.

3.3.5.2.2.5 CONNTYPE_TXUSER_IMPORT2 as Initiator

For all messages that are received in this connection type, the application MUST process the messages as specified in section 3.1. The application MUST also follow the processing rules as specified in the following sections.

3.3.5.2.2.5.1 Receiving a TXUSER_IMPORT2_MTAG_SINK_IMPORTED Message

When the application receives a TXUSER_IMPORT2_MTAG_SINK_IMPORTED message, the application MUST perform the following actions:

- If the connection state is Awaiting Import Response:
 - Set the connection state to Transaction Import Successful.
 - Return a success result and a reference to the transaction object to the higher-layer business logic.

- Otherwise, the message MUST be processed as an invalid message as specified in section 3.1.6.

3.3.5.2.2.5.2 Receiving a TXUSER_IMPORT2_MTAG_SINK_ERROR Message

When the application receives a TXUSER_IMPORT2_MTAG_SINK_ERROR message, the application MUST perform the following actions:

- If the connection state is Awaiting Import Response:
 - If the **Error** field in the message is set to TRUN_TXIMPORT_ERROR_IMPORT_TX_NOT_FOUND:
 - Return a failure result to the higher-layer business logic.
 - Set the connection state to Ended.
 - Otherwise, the message MUST be processed as an invalid message as specified in section 3.1.6.
- If the connection state is Awaiting Abort Response:
 - If the **Error** field in the message is set to TRUN_TXIMPORT_ERROR_IMPORT_TX_NOT_FOUND:
 - Return a failure result to the higher-layer business logic.
 - Set the connection state to Ended.
 - Otherwise, if the **Error** field in the message is set to TRUN_TXBEGIN_ERROR_NOTIFY_ABORTED, TRUN_TXBEGIN_ERROR_NOTIFY_COMMITTED, or TRUN_TXBEGIN_ERROR_NOTIFY_INDOUBT:
 - Return the respective transaction outcome as a result to the higher-layer business logic.
 - Set the connection state to Ended.
 - Otherwise, the message MUST be processed as an invalid message as specified in section 3.1.6.
- If the connection state is Transaction Import Successful:
 - If the **Error** field in the message is set to TRUN_TXBEGIN_ERROR_NOTIFY_COMMITTED, TRUN_TXBEGIN_ERROR_NOTIFY_ABORTED, or TRUN_TXBEGIN_ERROR_NOTIFY_INDOUBT:
 - Notify the higher-layer business logic of the outcome of the transaction.
 - Set the connection state to Ended.
 - Otherwise, the message MUST be processed as an invalid message as specified in section 3.1.6.
- Otherwise, the message MUST be processed as an invalid message as specified in section 3.1.6.

3.3.5.2.2.5.3 CONNTYPE_TXUSER_IMPORT2 Connection Disconnected

When a CONNTYPE_TXUSER_IMPORT2 (section 2.2.8.2.2.5) connection is disconnected, the application MUST perform the following actions:

- If the connection state is Awaiting Import Response or Awaiting Abort Response:
 - Return a failure result to the higher-layer business logic.

- Otherwise, the event MUST be processed as specified in section 3.1.8.3.

3.3.5.3 Transaction Administration

3.3.5.3.1 CONNTYPE_TXUSER_GETTXDETAILS as Initiator

For all messages that are received in this connection type, the application MUST process the message as specified in section 3.1. The application MUST also follow the processing rules as specified in the following sections.

3.3.5.3.1.1 Receiving a TXUSER_GETTXDETAILS_MTAG_GOTIT Message

When the application receives a TXUSER_GETTXDETAILS_MTAG_GOTIT message, the application MUST perform the following actions:

- If the connection state is Awaiting Response:
 - Return a success result to the higher-layer business logic, including the details that are provided in the following message fields:
 - The **vszSuperiorName** field
 - The **vszSuperiorID** field
 - The **ISubordinateCount** field
 - The **rgSubordinates** field
 - Set the connection state to Ended.
- Otherwise, the message MUST be processed as an invalid message as specified in section 3.1.6.

3.3.5.3.1.2 Receiving a TXUSER_GETTXDETAILS_MTAG_TX_NOT_FOUND Message

When the application receives a TXUSER_GETTXDETAILS_MTAG_TX_NOT_FOUND message, the application MUST perform the following actions:

- If the connection state is Awaiting Response:
 - Return a failure result to the higher-layer business logic.
 - Set the connection state to Ended.
- Otherwise, the message MUST be processed as an invalid message as specified in section 3.1.6.

3.3.5.3.1.3 CONNTYPE_TXUSER_GETTXDETAILS Connection Disconnected

When a CONNTYPE_TXUSER_GETTXDETAILS (section 2.2.8.3.1) connection is disconnected, the application MUST perform the following actions:

- If the connection state is Awaiting Response:
 - Return a failure result to the higher-layer business logic.
- Otherwise, the event MUST be processed as specified in section 3.1.8.3.

3.3.5.3.2 CONNTYPE_TXUSER_RESOLVE as Initiator

For all messages that are received in this connection type, the application MUST process the message as specified in section 3.1.1. The application MUST also follow the processing rules as specified in the following sections.

3.3.5.3.2.1 Receiving a TXUSER_RESOLVE_MTAG_REQUEST_COMPLETE Message

When the application receives a TXUSER_RESOLVE_MTAG_REQUEST_COMPLETE message, the application MUST perform the following actions:

- If the connection state is Awaiting Abort Response, Awaiting Commit Response, or Awaiting Forget Response:
 - Return a success result to the higher-layer business logic.
 - Set the connection state to Ended.
- Otherwise, the message MUST be processed as an invalid message as specified in section 3.1.6

3.3.5.3.2.2 Receiving a TXUSER_RESOLVE_MTAG_ACCESSDENIED or TXUSER_RESOLVE_MTAG_TX_NOT_FOUND Message

When the application receives one of these messages, the application MUST perform the following actions:

- If the connection state is Awaiting Abort Response, Awaiting Commit Response, or Awaiting Forget Response:
 - Return a failure result to the higher-layer business logic.
 - Set the connection state to Ended.
- Otherwise, the message MUST be processed as an invalid message as specified in section 3.1.6

3.3.5.3.2.3 Receiving a TXUSER_RESOLVE_MTAG_CHILD_NOT_PREPARED or TXUSER_RESOLVE_MTAG_NOT_CHILD Message

When the application receives a TXUSER_RESOLVE_MTAG_CHILD_NOT_PREPARED or TXUSER_RESOLVE_MTAG_NOT_CHILD message, the application MUST perform the following actions:

- If the connection state is Awaiting Abort Response or Awaiting Commit Response:
 - Return a failure result to the higher-layer business logic.
 - Set the connection state to Ended.
- Otherwise, the message MUST be processed as an invalid message as specified in section 3.1.6.

3.3.5.3.2.4 Receiving a TXUSER_RESOLVE_MTAG_FORGET_TX_NOT_COMMITTED Message

When the application receives a TXUSER_RESOLVE_MTAG_FORGET_TX_NOT_COMMITTED message, the application MUST perform the following actions:

- If the connection state is Awaiting Forget Response:
 - Return a failure result to the higher-layer business logic.
 - Set the connection state to Ended.
- Otherwise, the message MUST be processed as an invalid message as specified in section 3.1.6

3.3.5.3.2.5 Connection Disconnected

When a CONNTYPE_TXUSER_RESOLVE connection is disconnected, the application MUST perform the following actions:

- If the connection state is Awaiting Abort Response, Awaiting Commit Response, or Awaiting Forget Response:
 - Return a failure result to the higher-layer business logic.
- Otherwise, the event MUST be processed as specified in section 3.1.8.3.

3.3.5.3.3 CONNTYPE_TXUSER_SETTXTIMEOUT as Initiator

For all messages that are received in this connection type, the application MUST process the message as specified in section 3.1. The application MUST also follow the processing rules as specified in the following sections.

3.3.5.3.3.1 Receiving a TXUSER_SETTXTIMEOUT_MTAG_REQUEST_COMPLETE Message

When the application receives a TXUSER_SETTXTIMEOUT_MTAG_REQUEST_COMPLETE message, the application MUST perform the following actions:

- If the connection state is Awaiting Set Timeout Response:
 - Return a success result to the higher-layer business logic.
 - Set the connection state to Ended.
- Otherwise, the message MUST be processed as an invalid message as specified in section 3.1.6.

3.3.5.3.3.2 Receiving a TXUSER_SETTXTIMEOUT_MTAG_TOO_LATE or TXUSER_SETTXTIMEOUT_MTAG_TX_NOT_FOUND Message

When the application receives a TXUSER_SETTXTIMEOUT_MTAG_TOO_LATE or TXUSER_SETTXTIMEOUT_MTAG_TX_NOT_FOUND message, the application MUST perform the following actions:

- If the connection state is Awaiting Set Timeout Response:
 - Return a failure result to the higher-layer business logic.
 - Set the connection state to Ended.
- Otherwise, the message MUST be processed as an invalid message as specified in section 3.1.6.

3.3.5.3.3.3 Connection Disconnected

When a CONNTYPE_TXUSER_SETTXTIMEOUT connection is disconnected, the application MUST perform the following actions:

- If the connection state is Awaiting Set Timeout Response:
 - Return a failure result to the higher-layer business logic.
- Otherwise, the event MUST be processed as specified in section 3.1.8.3.

3.3.5.3.4 CONNTYPE_TXUSER_SETTXTIMEOUT2 as Initiator

For all messages that are received in this connection type, the application MUST process the message as specified in section 3.1. The application MUST also follow the processing rules as specified in the following sections.

3.3.5.3.4.1 Receiving a TXUSER_SETTXTIMEOUT_MTAG_TX_NOT_FOUND Message

When the application receives a TXUSER_SETTXTIMEOUT_MTAG_TX_NOT_FOUND (section 2.2.8.3.3.1) message, the application MUST perform the following actions:

- If the connection state is Awaiting Set Timeout Response:
 - Find an instance of a CONNTYPE_TXUSER_BEGIN2 (section 2.2.8.1.2) or CONNTYPE_TXUSER_PROMOTE (section 2.2.8.1.3) connection in the transaction connection list. This connection is referred to as the beginner connection.
 - If a beginner connection is not found:
 - The application MUST return a failure result to the higher-layer business logic.
 - Otherwise, if the beginner connection state is not Awaiting Set Timeout Response:
 - The application MUST return a failure result to the higher-layer business logic.
 - Otherwise:
 - Set the beginner connection state to Processing Transaction.
 - The application MUST return a failure result to the higher-layer business logic.
 - Set the CONNTYPE_TXUSER_SETTXTIMEOUT2 (section 2.2.8.3.4) connection state to Ended.
- Otherwise, the message MUST be processed as an invalid message as specified in section 3.1.6.

3.3.5.3.4.2 Connection Disconnected

When a CONNTYPE_TXUSER_SETTXTIMEOUT2 connection is disconnected, the application MUST perform the following actions:

- If the connection state is Awaiting Set Timeout Response:
 - Return a failure result to the higher-layer business logic.
- Otherwise, the event MUST be processed as specified in section 3.1.8.3

3.3.5.3.5 CONNTYPE_TXUSER_TRACE as Initiator

For all messages that are received in this connection type, the application MUST process the message as specified in section 3.1. The application MUST also follow the processing rules as specified in the following sections.

3.3.5.3.5.1 Receiving a TXUSER_TRACE_MTAG_REQUEST_COMPLETE Message

When the application receives a TXUSER_TRACE_MTAG_REQUEST_COMPLETE (section 2.2.8.3.5.2) message, the application MUST perform the following actions:

- If the connection state is Awaiting Trace Response:
 - Return a success result to the higher-layer business logic.
 - Set the connection state to Ended.

- Otherwise, the message MUST be processed as an invalid message as specified in section 3.1.6.

3.3.5.3.5.2 Receiving a TXUSER_TRACE_MTAG_REQUEST_FAILED or TXUSER_TRACE_MTAG_TX_NOT_FOUND Message

When the application receives one of these messages, the application MUST perform the following actions:

- If the connection state is Awaiting Trace Response:
 - Return a failure result to the higher-layer business logic.
 - Set the connection state to Ended.
- Otherwise, the message MUST be processed as an invalid message as specified in section 3.1.6.

3.3.5.3.5.3 Connection Disconnected

When a CONNTYPE_TXUSER_TRACE (section 2.2.8.3.5) connection is disconnected, the application MUST perform the following actions:

- If the connection state is Awaiting Trace Response:
 - Return a failure result to the higher-layer business logic.
- Otherwise, the event MUST be processed as specified in section 3.1.8.3.

3.3.5.4 Transaction Manager Administration

3.3.5.4.1 CONNTYPE_TXUSER_GETSECURITYFLAGS as Initiator

For all messages that are received in this connection type, the application MUST process the message as specified in section 3.1. The transaction manager MUST also follow the processing rules as specified in the following sections.

3.3.5.4.1.1 Receiving a TXUSER_GETSECURITYFLAGS_MTAG_FETCHED Message

When the application receives a TXUSER_GETSECURITYFLAGS_MTAG_FETCHED (section 2.2.8.4.1.1) message, the application MUST perform the following actions:

- If the connection state is Awaiting Get Response:
 - Return a success result and the following message information to the higher-layer business logic:
 - The **grfNetworkDtcAccess** field
 - The **grfXaTransactions** field
 - Set the connection state to Ended.
- Otherwise, the message MUST be processed as an invalid message as specified in section 3.1.6.

3.3.5.4.1.2 CONNTYPE_TXUSER_GETSECURITYFLAGS Connection Disconnected

When a CONNTYPE_TXUSER_GETSECURITYFLAGS (section 2.2.8.4.1) connection is disconnected, the application MUST perform the following actions:

- If the connection state is Awaiting Get Response:

- Return a failure result to the higher-layer business logic.
- Otherwise, the event MUST be processed as specified in section 3.1.8.3.

3.3.6 Timer Events

None.

3.3.7 Other Local Events

None.

3.4 Transaction Manager Communicating with Application Details

3.4.1 Abstract Data Model

This section describes a conceptual model of possible data organization that an implementation maintains to participate in this protocol. The described organization is provided to facilitate the explanation of how the protocol behaves. This document does not mandate that implementations adhere to this model as long as their external behavior is consistent with the behavior that is described in this document.

The transaction manager communicating with an application facet MUST maintain all the data elements that are specified in section 3.2.1.

The transaction manager communicating with an application facet MUST also maintain the following data elements:

- **Associates Table:** A table where each object is a list of connection objects of type CONNTYPE_TXUSER_ASSOCIATE (section 2.2.8.2.1.1), keyed by the identifier of the transaction with which the connections are associated. All connection objects in each list reference the same transaction object, and there is only one list per transaction in the **Associates Table**.

Enlistment objects that are created by the transaction manager communicating with an application facet MUST provide the following properties, as specified in section 3.1.1:

- **Name:** An empty string
- **Enlistment Object.Identifier:** An empty string

The transaction manager communicating with an application facet MUST provide the states in the following sections for its supported connection types. The connection types that a transaction manager communicating with an application facet MUST provide for each supported protocol version are as specified in section 2.2.1.1.1.

3.4.1.1 CONNTYPE_TXUSER_BEGINNER Acceptor States

The transaction manager communicating with an application MUST act as an acceptor for the CONNTYPE_TXUSER_BEGINNER connection type. In this role, the transaction manager communicating with an application MUST provide support for the following states:

- Idle
- Beginning Transaction
- Active
- Aborting Transaction

- Committing Transaction
- Ended

The following figure shows the relationships between the CONNTYPE_TXUSER_BEGINNER acceptor states.

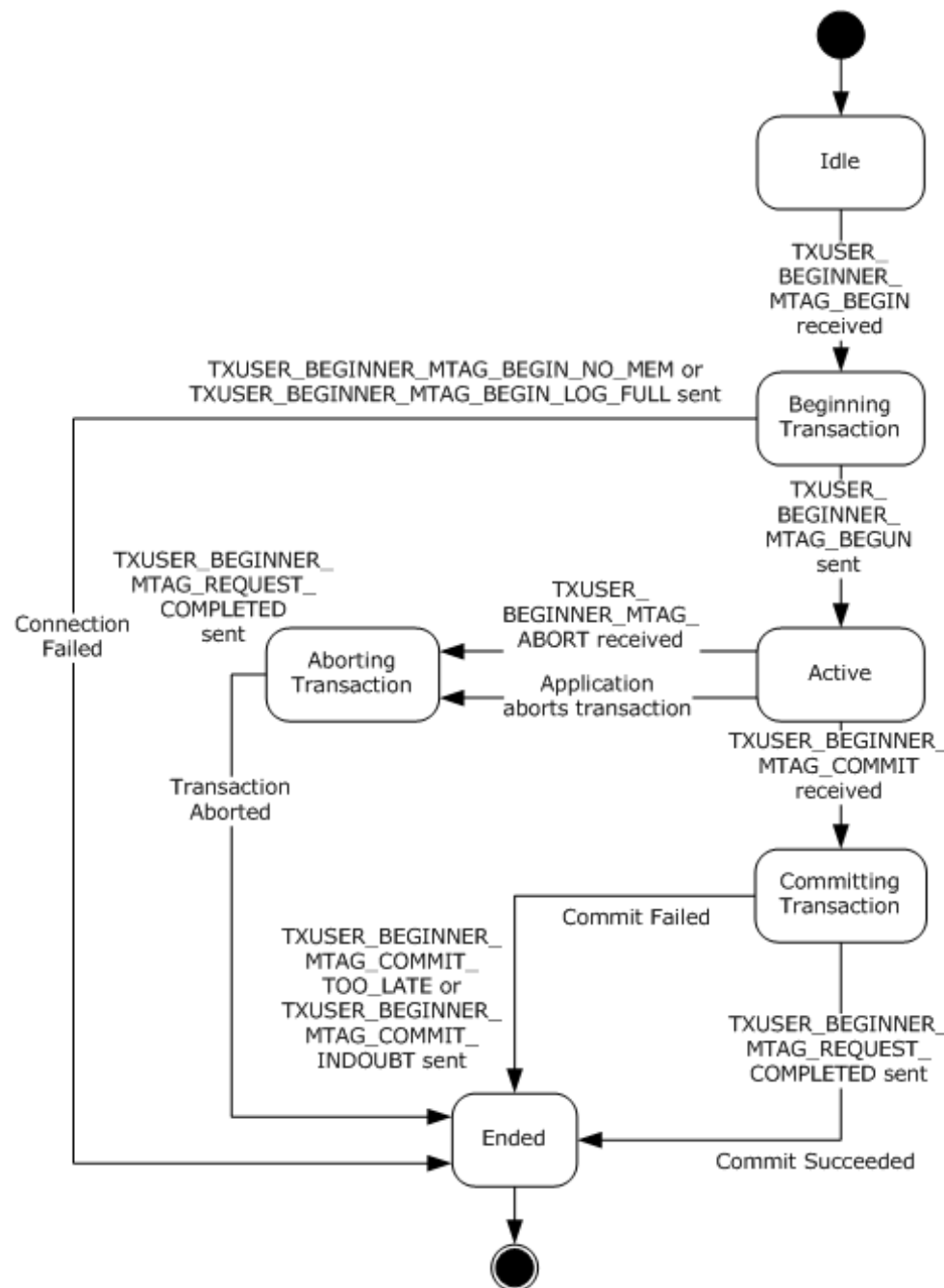

Figure 29: CONNTYPE_TXUSER_BEGINNER Acceptor States

3.4.1.1.1 Idle

The Idle state is the initial state. The following event is processed in this state:

- Receiving a TXUSER_BEGINNER_MTAG_BEGIN Message (section 3.4.5.1.1.1).

3.4.1.1.2 Beginning Transaction

The following events are processed in this state:

- Create Transaction Success (section 3.4.7.8)
- Create Transaction Failure (section 3.4.7.7)

3.4.1.1.3 Active

The following events are processed in this state:

- Receiving a TXUSER_BEGINNER_MTAG_COMMIT Message (section 3.4.5.1.1.2)
- Receiving a TXUSER_BEGINNER_MTAG_ABORT Message (section 3.4.5.1.1.3)
- Unilaterally Aborted (section 3.4.7.23)

3.4.1.1.4 Aborting Transaction

The following events are processed in this state:

- Rollback Complete (section 3.4.7.18)
- Receiving a TXUSER_BEGINNER_MTAG_COMMIT Message (section 3.4.5.1.1.2)
- Phase One Complete (section 3.4.7.13)

3.4.1.1.5 Committing Transaction

The following event is processed in this state:

- Phase One Complete (section 3.4.7.13)

3.4.1.1.6 Ended

This is the final state.

3.4.1.2 CONNTYPE_TXUSER_BEGIN2 Acceptor States

The transaction manager communicating with an application MUST act as an acceptor for the CONNTYPE_TXUSER_BEGIN2 connection type. In this role, the transaction manager communicating with an application MUST provide support for the following states:

- Idle
- Beginning Transaction
- Active
- Modifying Timeout
- Aborting Transaction
- Committing Transaction

- Ended

The following figure shows the relationships between the CONNTYPE_TXUSER_BEGIN2 acceptor states.

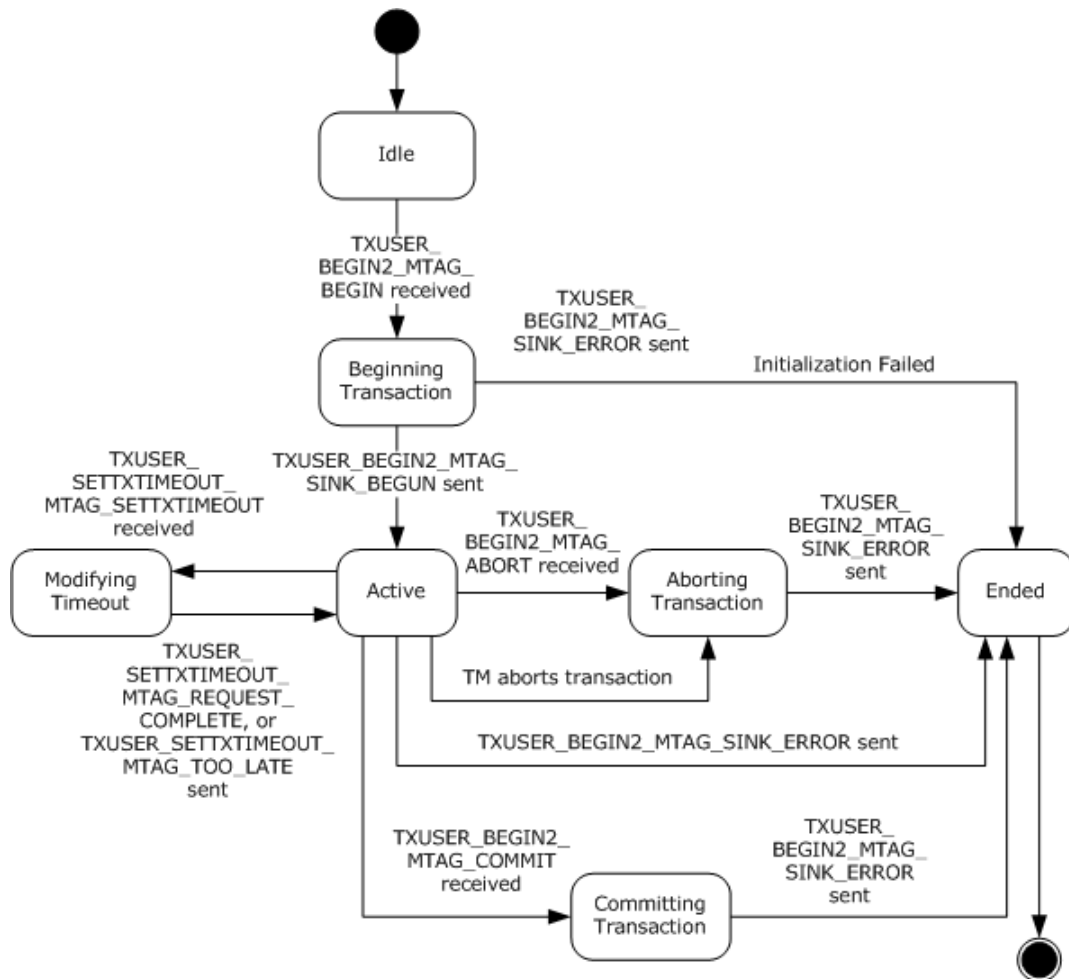

Figure 30: CONNTYPE_TXUSER_BEGIN2 Acceptor States

3.4.1.2.1 Idle

This is the initial state. The following event is processed in this state:

- Receiving a TXUSER_BEGIN2_MTAG_BEGIN Message (section 3.4.5.1.2.1)

3.4.1.2.2 Beginning Transaction

The following events are processed in this state:

- Create Transaction Success (section 3.4.7.8)
- Create Transaction Failure (section 3.4.7.7)

3.4.1.2.3 Active

The following events are processed in this state:

- Receiving a TXUSER_SETTXTIMEOUT_MTAG_SETTXTIMEOUT Message (section 3.4.5.1.2.2)
- Receiving a TXUSER_BEGIN2_MTAG_COMMIT Message (section 3.4.5.1.2.3)
- Receiving a TXUSER_BEGIN2_MTAG_ABORT Message (section 3.4.5.1.2.4)
- Unilaterally Aborted (section 3.4.7.23)

3.4.1.2.4 Modifying Timeout

The following events are processed in this state:

- Set Transaction Timeout Success (section 3.4.7.22)
- Set Transaction Timeout Failure (section 3.4.7.21)

3.4.1.2.5 Aborting Transaction

The following event is processed in this state:

- Rollback Complete (section 3.4.7.18)

3.4.1.2.6 Committing Transaction

The following event is processed in this state:

- Phase One Complete (section 3.4.7.13)

3.4.1.2.7 Ended

This is the final state.

3.4.1.3 CONNTYPE_TXUSER_PROMOTE Acceptor States

The transaction manager communicating with an application MUST act as an acceptor for the CONNTYPE_TXUSER_PROMOTE connection type. In this role, the transaction manager communicating with an application MUST provide support for the following states:

- Idle
- Beginning Transaction
- Active
- Modifying Timeout
- Aborting Transaction
- Committing Transaction
- Ended

The following figure shows the relationship between the CONNTYPE_TXUSER_PROMOTE acceptor states.

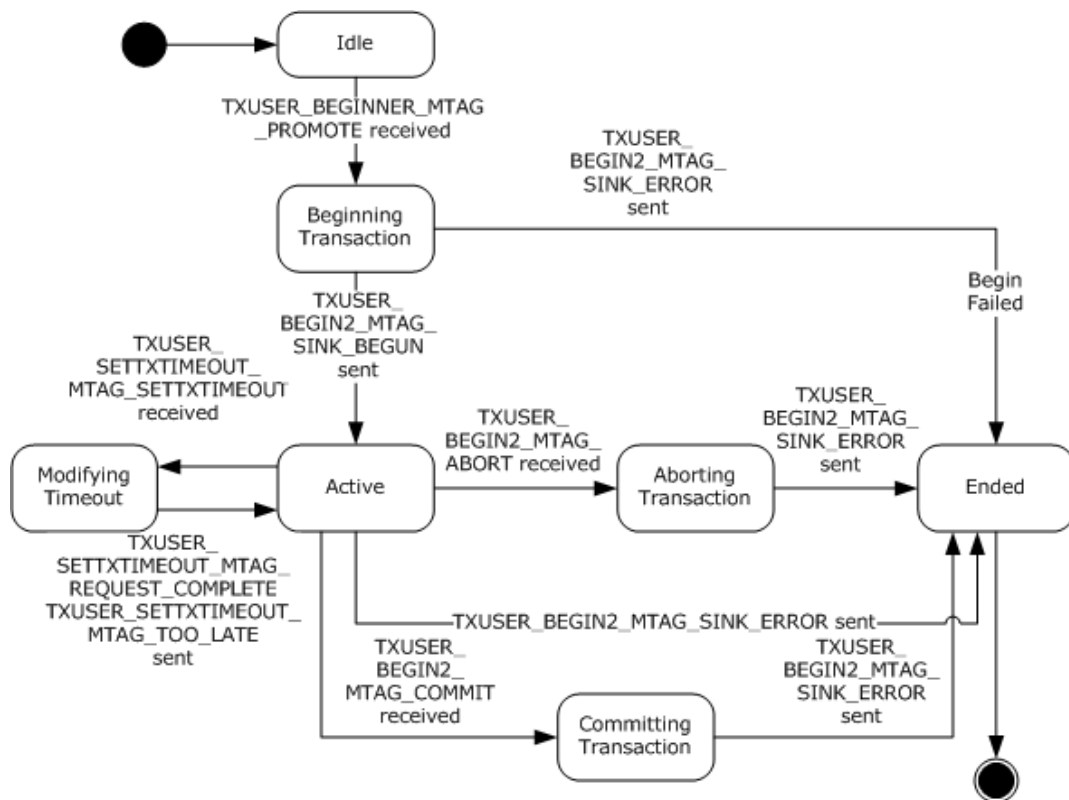

Figure 31: CONNTYPE_TXUSER_PROMOTE Acceptor States

3.4.1.3.1 Idle

This is the initial state. The following event is processed in this state:

- Receiving a TXUSER_BEGINNER_MTAG_PROMOTE Message (section 3.4.5.1.3.1)

3.4.1.3.2 Beginning Transaction

The following events are processed in this state:

- Create Transaction Success (section 3.4.7.8)
- Create Transaction Failure (section 3.4.7.7)

3.4.1.3.3 Active

The following events are processed in this state:

- Receiving a TXUSER_SETTXTIMEOUT_MTAG_SETTXTIMEOUT, TXUSER_BEGIN2_MTAG_COMMIT, or TXUSER_BEGIN2_MTAG_ABORT Message (section 3.4.5.1.3.2)
- Receiving a TXUSER_BEGINNER_MTAG_PROMOTE Message (section 3.4.5.1.3.1)
- Unilaterally Aborted (section 3.4.7.23)

3.4.1.3.4 Modifying Timeout

The following events are processed in this state:

- Set Transaction Timeout Success (section 3.4.7.22)
- Set Transaction Timeout Failure (section 3.4.7.21)

3.4.1.3.5 Aborting Transaction

The following event is processed in this state:

- Rollback Complete (section 3.4.7.18)

3.4.1.3.6 Committing Transaction

The following event is processed in this state:

- Phase One Complete (section 3.4.7.13)

3.4.1.3.7 Ended

This is the final state.

3.4.1.4 CONNTYPE_TXUSER_ASSOCIATE Acceptor States

The transaction manager communicating with an application MUST act as an acceptor for the CONNTYPE_TXUSER_ASSOCIATE connection type. In this role, the transaction manager communicating with an application MUST provide support for the following states:

- Idle
- Processing Associate Request
- Active
- Ended

The following figure shows the relationship between the CONNTYPE_TXUSER_ASSOCIATE acceptor states.

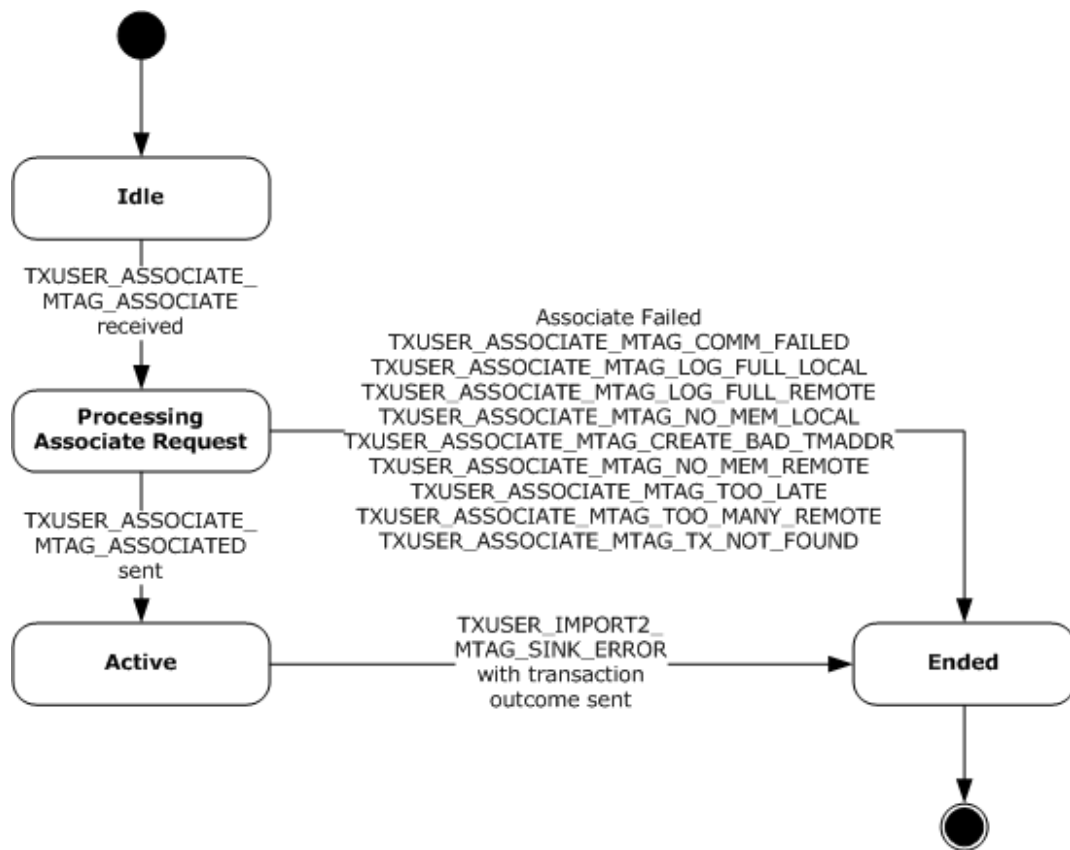

Figure 32: CONNTYPE_TXUSER_ASSOCIATE Acceptor States

3.4.1.4.1 Idle

This is the initial state. The following event is processed in this state:

- Receiving a TXUSER_ASSOCIATE_MTAG_ASSOCIATE Message (section 3.4.5.2.1.1.1)

3.4.1.4.2 Processing Associate Request

The following events are processed in this state:

- Associate Transaction Success (section 3.4.7.2).
- Associate Transaction Failure (section 3.4.7.1). This event applies to these messages:
 - TXUSER_ASSOCIATE_MTAG_COMM_FAILED (section 2.2.8.2.1.1.3)
 - TXUSER_ASSOCIATE_MTAG_LOG_FULL_LOCAL (section 2.2.8.2.1.1.5)
 - TXUSER_ASSOCIATE_MTAG_LOG_FULL_REMOTE (section 2.2.8.2.1.1.6)
 - TXUSER_ASSOCIATE_MTAG_NO_MEM_REMOTE (section 2.2.8.2.1.1.8)
 - TXUSER_ASSOCIATE_MTAG_TOO_LATE (section 2.2.8.2.1.1.9)
 - TXUSER_ASSOCIATE_MTAG_TOO_MANY_REMOTE (section 2.2.8.2.1.1.11)
 - TXUSER_ASSOCIATE_MTAG_TX_NOT_FOUND (section 2.2.8.2.1.1.12)

3.4.1.4.3 Active

The following events are processed in this state:

- Begin Voting (section 3.4.7.6).
- Begin Commit (section 3.4.7.3)
- Begin Rollback (section 3.4.7.5)
- Begin In Doubt (section 3.4.7.4)

3.4.1.4.4 Ended

This is the final state.

3.4.1.5 CONNTYPE_TXUSER_EXTENDEDWHEREABOUTS Acceptor States

The transaction manager communicating with an application MUST act as an acceptor for the CONNTYPE_TXUSER_EXTENDEDWHEREABOUTS connection type. In this role, the transaction manager communicating with an application MUST provide support for the following states:

- Idle
- Processing Inquiry
- Ended

The following figure shows the relationship between the CONNTYPE_TXUSER_EXTENDEDWHEREABOUTS acceptor states.

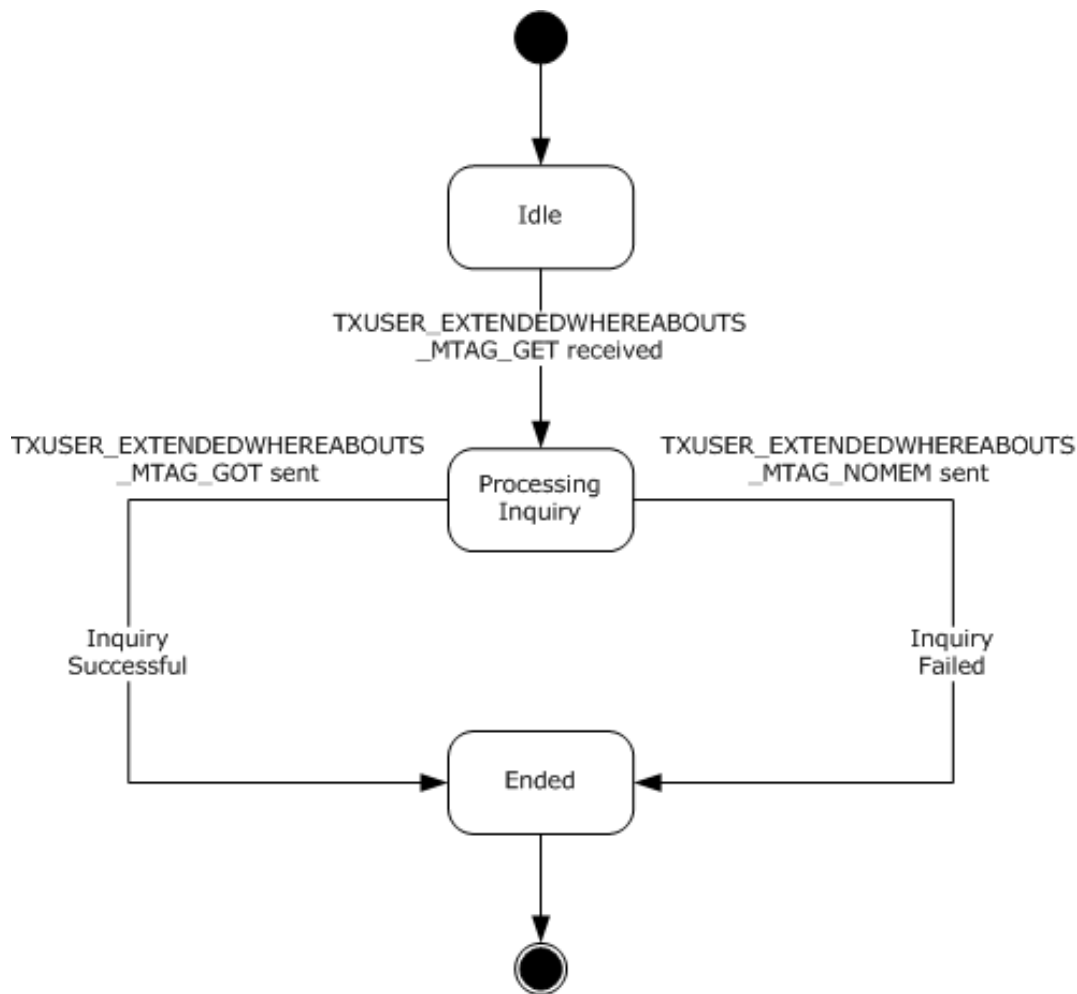

Figure 33: CONNTYPE_TXUSER_EXTENDEDWHEREABOUTS Acceptor States

3.4.1.5.1 Idle

This is the initial state. The following event is processed in this state:

- Receiving a TXUSER_EXTENDEDWHEREABOUTS_MTAG_GET Message (section 3.4.5.2.2.1.1)

3.4.1.5.2 Processing Inquiry

This is a transient state that is assumed during the synchronous processing of a request. No events are processed in this state.

3.4.1.5.3 Ended

This is the final state.

3.4.1.6 CONNTYPE_TXUSER_IMPORT Acceptor States

The transaction manager communicating with an application MUST act as an acceptor for the CONNTYPE_TXUSER_IMPORT connection type. In this role, the transaction manager communicating with an application MUST provide support for the following states:

- Idle
- Processing Import Request
- Active
- Too Late to Abort
- Processing Abort Request
- Ended

The following figure shows the relationship between the CONNTYPE_TXUSER_IMPORT acceptor states.

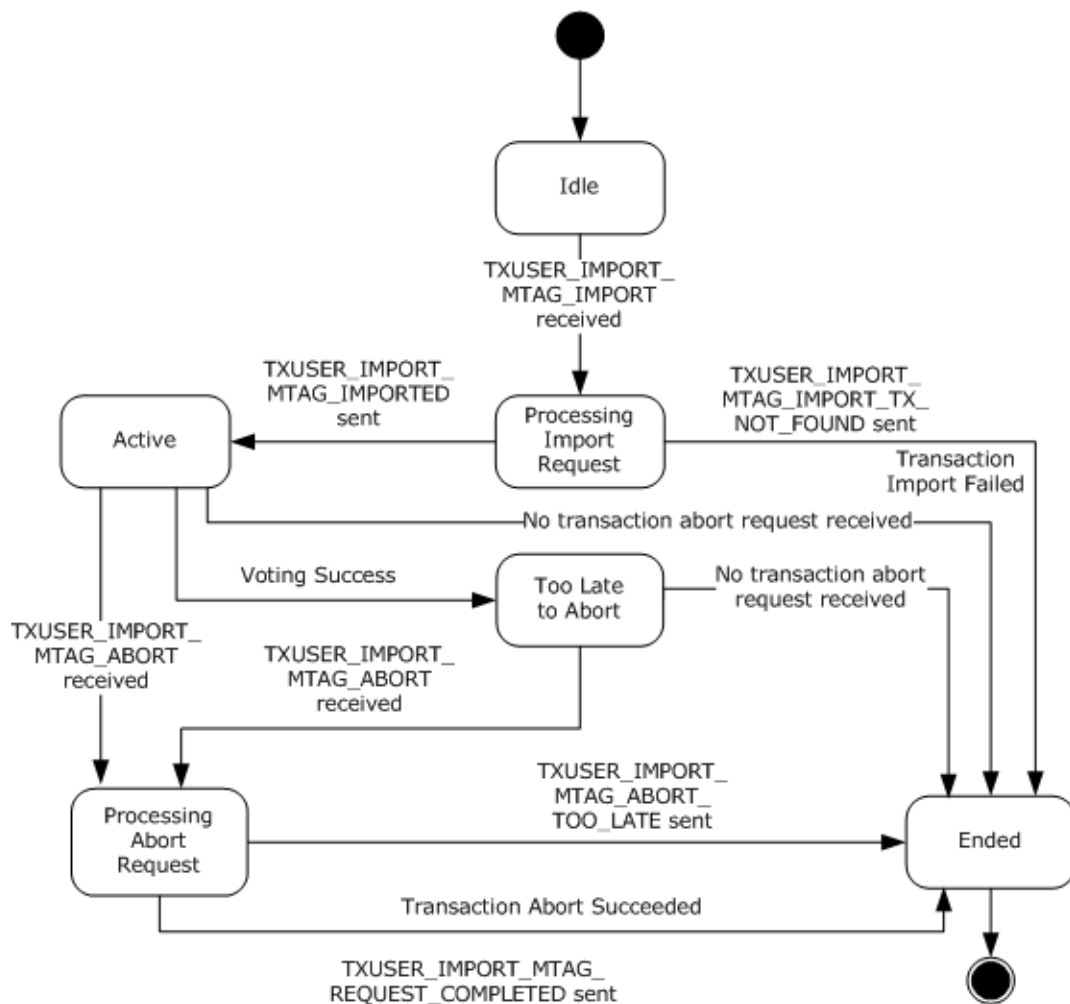

Figure 34: CONNTYPE_TXUSER_IMPORT Acceptor States

3.4.1.6.1 Idle

This is the initial state. The following event is processed in this state:

- Receiving a TXUSER_IMPORT_MTAG_IMPORT Message (section 3.4.5.2.2.4.1)

3.4.1.6.2 Processing Import Request

The following events are processed in this state:

- Create Voter Enlistment Success (section 3.4.7.10)
- Create Voter Enlistment Failure (section 3.4.7.9)

3.4.1.6.3 Active

The following events are processed in this state:

- Receiving a TXUSER_IMPORT_MTAG_ABORT Message (section 3.4.5.2.2.4.2)
- Begin Voting (section 3.4.7.6)
- Begin Commit (section 3.4.7.3)
- Begin Rollback (section 3.4.7.5)
- Begin In Doubt (section 3.4.7.4)

3.4.1.6.4 Too Late to Abort

The following events are processed in this state:

- Receiving a TXUSER_IMPORT_MTAG_ABORT Message (section 3.4.5.2.2.4.2)
- Begin Rollback (section 3.4.7.5)
- Begin Commit (section 3.4.7.3)
- Begin In Doubt (section 3.4.7.4)

3.4.1.6.5 Processing Abort Request

This is a transient state that is assumed during the synchronous processing of a request to abort a transaction. No events are processed in this state.

3.4.1.6.6 Ended

This is the final state.

3.4.1.7 CONNTYPE_TXUSER_IMPORT2 Acceptor States

The transaction manager communicating with an application MUST act as an acceptor for the CONNTYPE_TXUSER_IMPORT2 connection type. In this role, the transaction manager communicating with an application MUST provide support for the following states:

- Idle
- Processing Import Request
- Active
- Too Late to Abort
- Processing Abort Request
- Ended

The following figure shows the relationship between the CONNTYPE_TXUSER_IMPORT2 acceptor states.

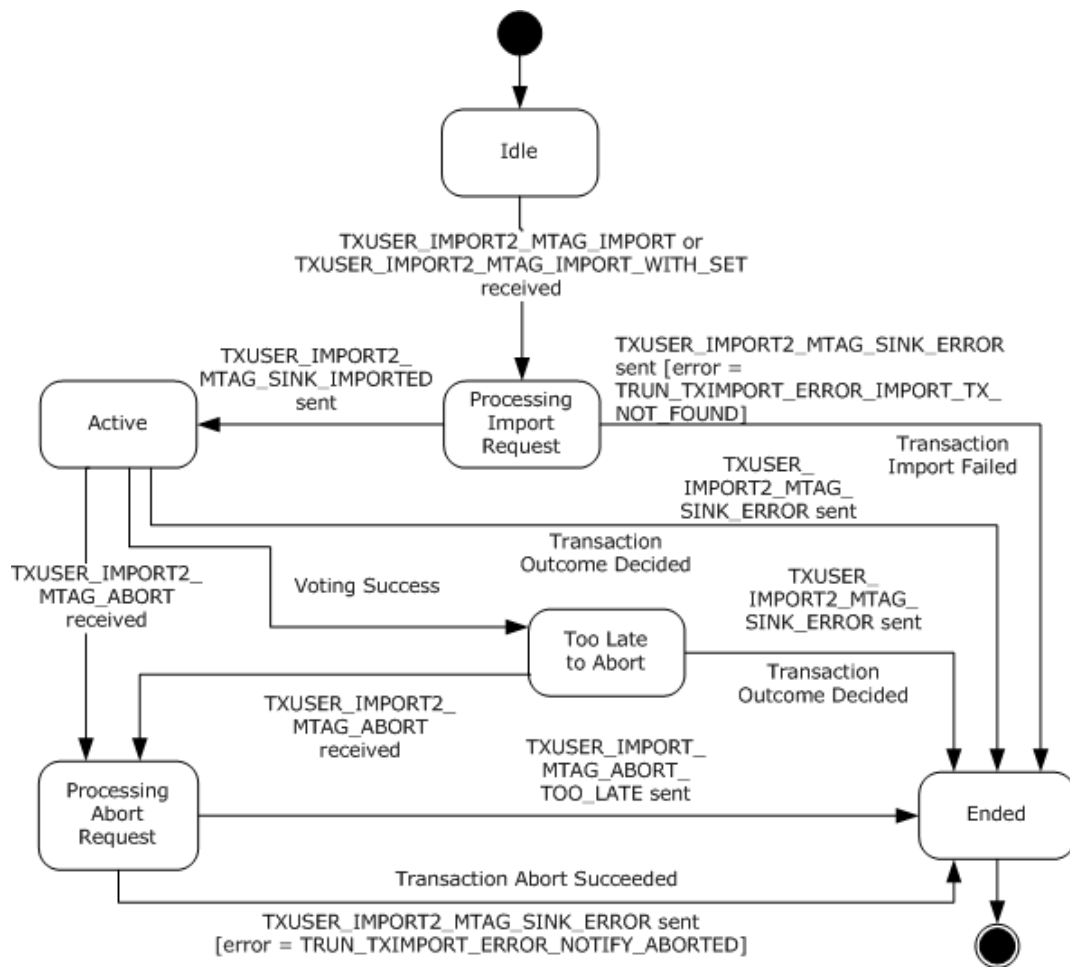

Figure 35: CONNTYPE_TXUSER_IMPORT2 Acceptor States

3.4.1.7.1 Idle

This is the initial state. The following events are processed in this state:

- Receiving a TXUSER_IMPORT2_MTAG_IMPORT Message (section 3.4.5.2.2.5.1)
- Receiving a TXUSER_IMPORT2_MTAG_IMPORT_WITH_SET Message (section 3.4.5.2.2.5.2)

3.4.1.7.2 Processing Import Request

The following events are processed in this state:

- Set Transaction Attributes Success (section 3.4.7.20)
- Set Transaction Attributes Failure (section 3.4.7.19)
- Create Voter Enlistment Success (section 3.4.7.10)

- Create Voter Enlistment Failure (section 3.4.7.9)

3.4.1.7.3 Active

The following events are processed in this state:

- Receiving a TXUSER_IMPORT2_MTAG_ABORT message (section 3.4.5.2.2.5.3)
- Begin Voting (section 3.4.7.6)
- Begin Commit (section 3.4.7.3)
- Begin Rollback (section 3.4.7.5)
- Begin In Doubt (section 3.4.7.4)

3.4.1.7.4 Too Late to Abort

The following events are processed in this state:

- Receiving a TXUSER_IMPORT2_MTAG_ABORT message (section 3.4.5.2.2.5.3)
- Begin Commit (section 3.4.7.3)
- Begin Rollback (section 3.4.7.5)
- Begin In Doubt (section 3.4.7.4)

3.4.1.7.5 Processing Abort Request

This is a transient state that is assumed during the synchronous processing of a request to abort a transaction. No events are processed in this state.

3.4.1.7.6 Ended

This is the final state.

3.4.1.8 CONNTYPE_TXUSER_EXPORT Acceptor States

The transaction manager communicating with an application MUST act as an acceptor for the CONNTYPE_TXUSER_EXPORT connection type. In this role, the transaction manager communicating with an application MUST provide support for the following states:

- Idle
- Processing Connection Request
- Connection Active
- Processing Push Operation Request
- Ended

The following figure shows the relationship between the CONNTYPE_TXUSER_EXPORT acceptor states.

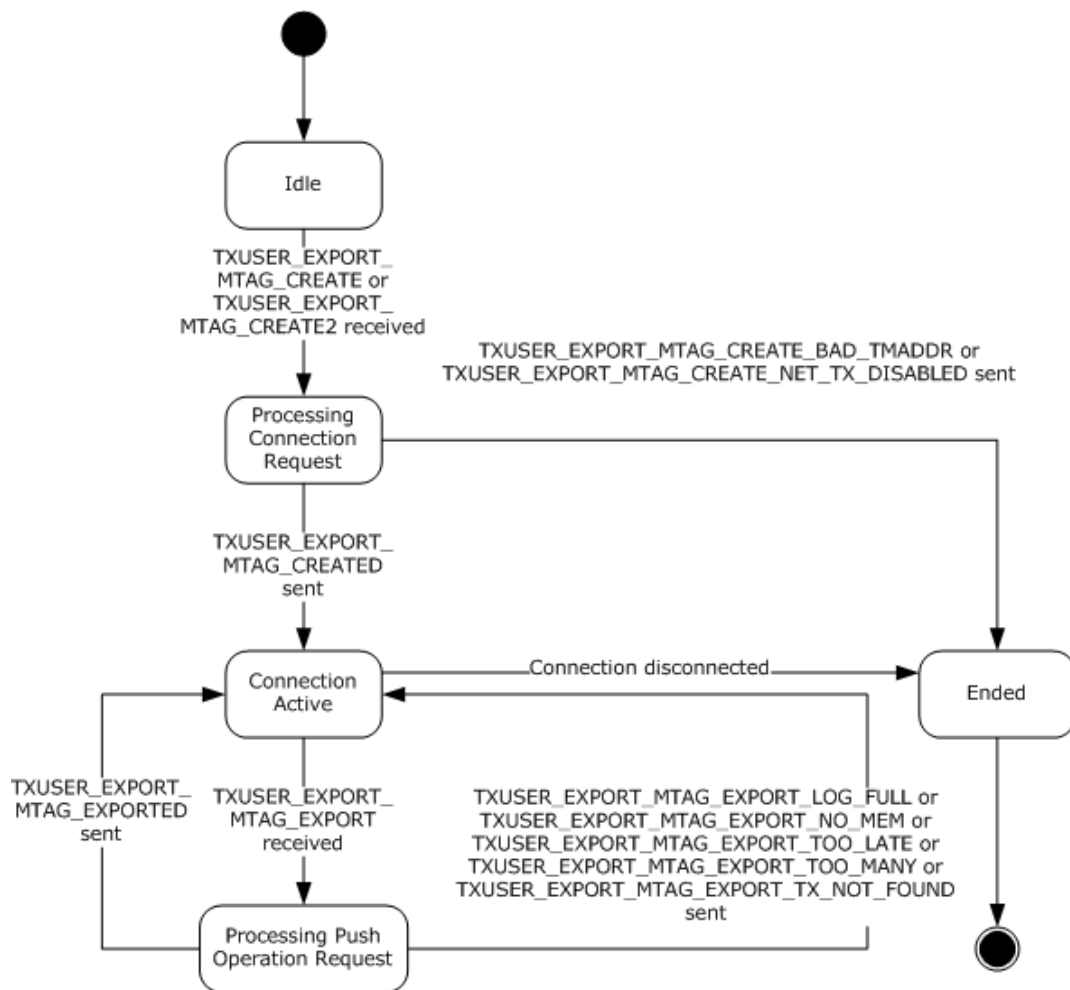

Figure 36: CONNTYPE_TXUSER_EXPORT Acceptor States

3.4.1.8.1 Idle

This is the initial state. The following events are processed in this state:

- Receiving a TXUSER_EXPORT_MTAG_CREATE Message (section 3.4.5.2.2.2.1)
- Receiving a TXUSER_EXPORT_MTAG_CREATE2 Message (section 3.4.5.2.2.2.2)

3.4.1.8.2 Processing Connection Request

This is a transient state that is assumed during the synchronous processing of a create export request. No events are processed in this state.

3.4.1.8.3 Connection Active

The following events are processed in this state:

- Receiving a TXUSER_EXPORT_MTAG_EXPORT Message (section 3.4.5.2.2.2.3)
- Connection Disconnected (section 3.4.5.2.2.2.4)

3.4.1.8.4 Processing Push Operation Request

The following events are processed in this state:

- Export Transaction Success (section 3.4.7.12)
- Export Transaction Failure (section 3.4.7.11)

3.4.1.8.5 Ended

This is the final state.

3.4.1.9 CONNTYPE_TXUSER_EXPORT2 Acceptor States

The transaction manager communicating with an application MUST act as an acceptor for the CONNTYPE_TXUSER_EXPORT2 connection type. In this role, the transaction manager communicating with an application MUST provide support for the following states:

- Idle
- Processing Connection Request
- Connection Active
- Processing Push Operation Request
- Ended

The following figure shows the relationships between the CONNTYPE_TXUSER_EXPORT2 acceptor states.

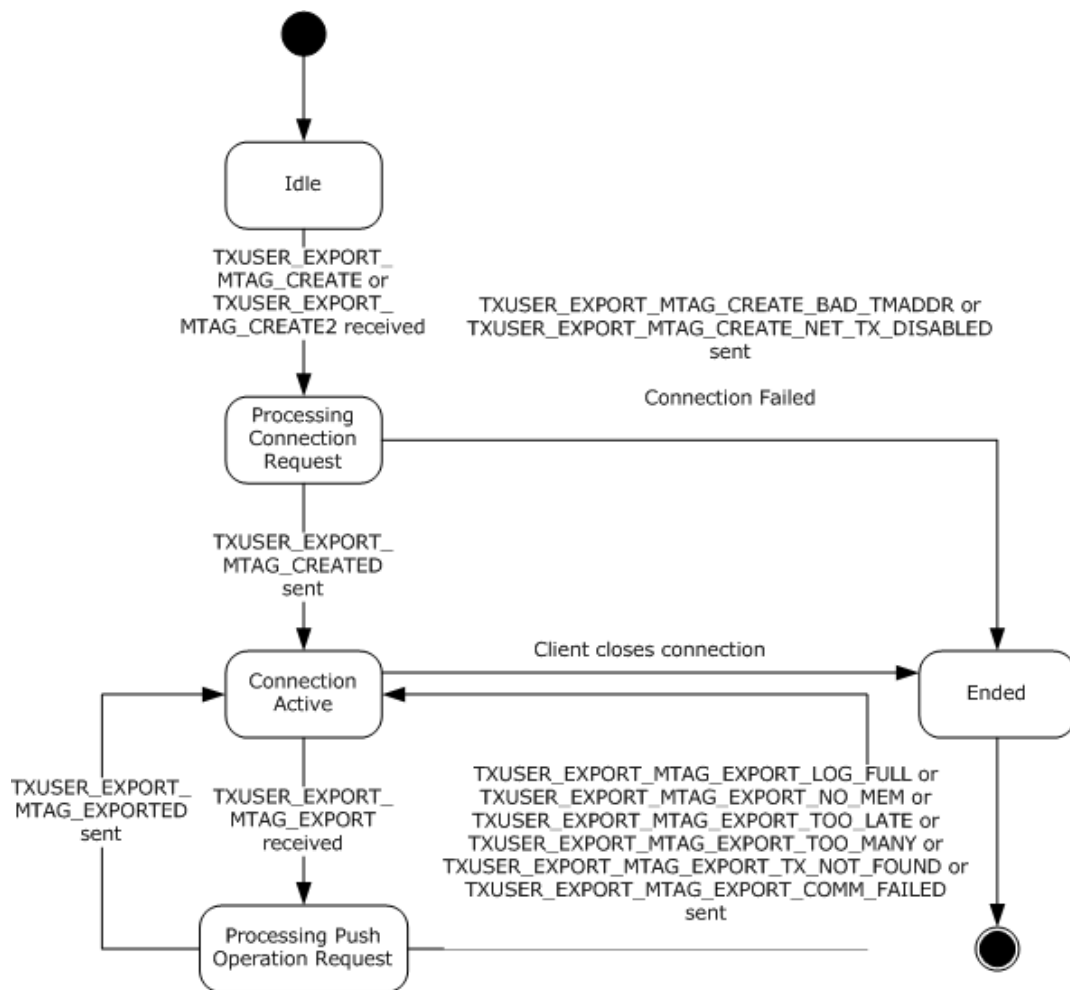

Figure 37: CONNTYPE_TXUSER_EXPORT2 Acceptor States

3.4.1.9.1 Idle

This is the initial state. The following events are processed in this state:

- Receiving a TXUSER_EXPORT_MTAG_CREATE Message (section 3.4.5.2.2.3.1)
- Receiving a TXUSER_EXPORT_MTAG_CREATE2 Message (section 3.4.5.2.2.3.2)

3.4.1.9.2 Processing Connection Request

This is a transient state that is assumed during the synchronous processing of a create export request. No events are processed in this state.

3.4.1.9.3 Connection Active

The following events are processed in this state:

- Receiving a TXUSER_EXPORT_MTAG_EXPORT Message (section 3.4.5.2.2.3.3)
- Connection Disconnected (section 3.4.5.2.2.3.4)

3.4.1.9.4 Processing Push Operation Request

The following events are processed in this state:

- Export Transaction Success (section 3.4.7.12)
- Export Transaction Failure (section 3.4.7.11)

3.4.1.9.5 Ended

This is the final state.

3.4.1.10 CONNTYPE_TXUSER_GETTXDETAILS Acceptor States

The transaction manager communicating with an application MUST act as an acceptor for the CONNTYPE_TXUSER_GETTXDETAILS connection type. In this role, the transaction manager communicating with an application MUST provide support for the following states:

- Idle
- Processing Inquiry
- Ended

The following figure shows the relationship between the CONNTYPE_TXUSER_GETTXDETAILS acceptor states.

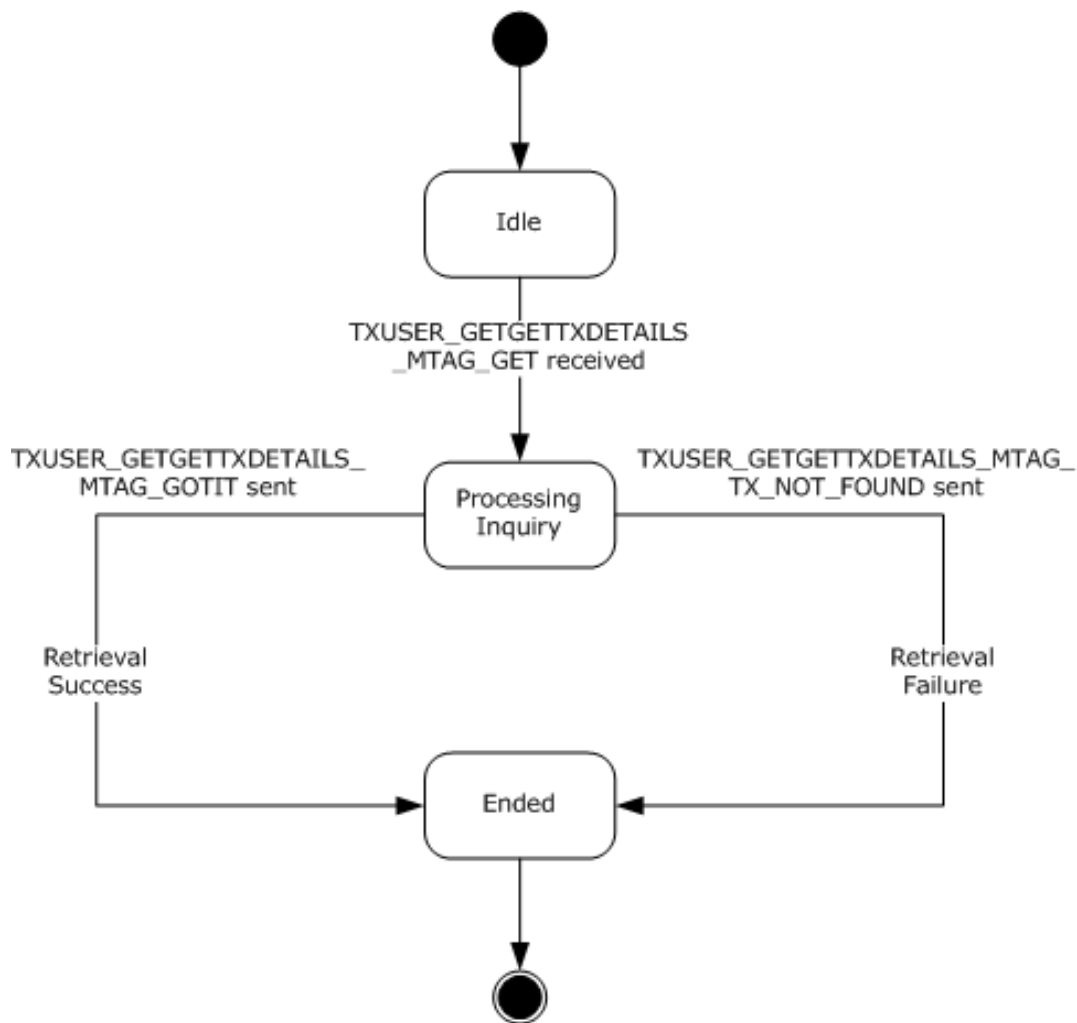

Figure 38: CONNTYPE_TXUSER_GETTXDETAILS Acceptor States

3.4.1.10.1 Idle

This is the initial state. The following event is processed in this state:

- Receiving a TXUSER_GETTXDETAILS_MTAG_GET Message (section 3.4.5.3.1.1)

3.4.1.10.2 Processing Inquiry

This is a transient state that is assumed during the synchronous processing of a request for the transaction details. No events are processed in this state.

3.4.1.10.3 Ended

This is the final state.

3.4.1.11 CONNTYPE_TXUSER_RESOLVE Acceptor States

The transaction manager communicating with an application MUST act as an acceptor for the CONNTYPE_TXUSER_RESOLVE connection type. In this role, the transaction manager communicating with an application MUST provide support for the following states:

- Idle
- Processing Abort Request
- Processing Forget Request
- Processing Commit Request
- Ended

The following figure shows the relationship between the CONNTYPE_TXUSER_RESOLVE acceptor states.

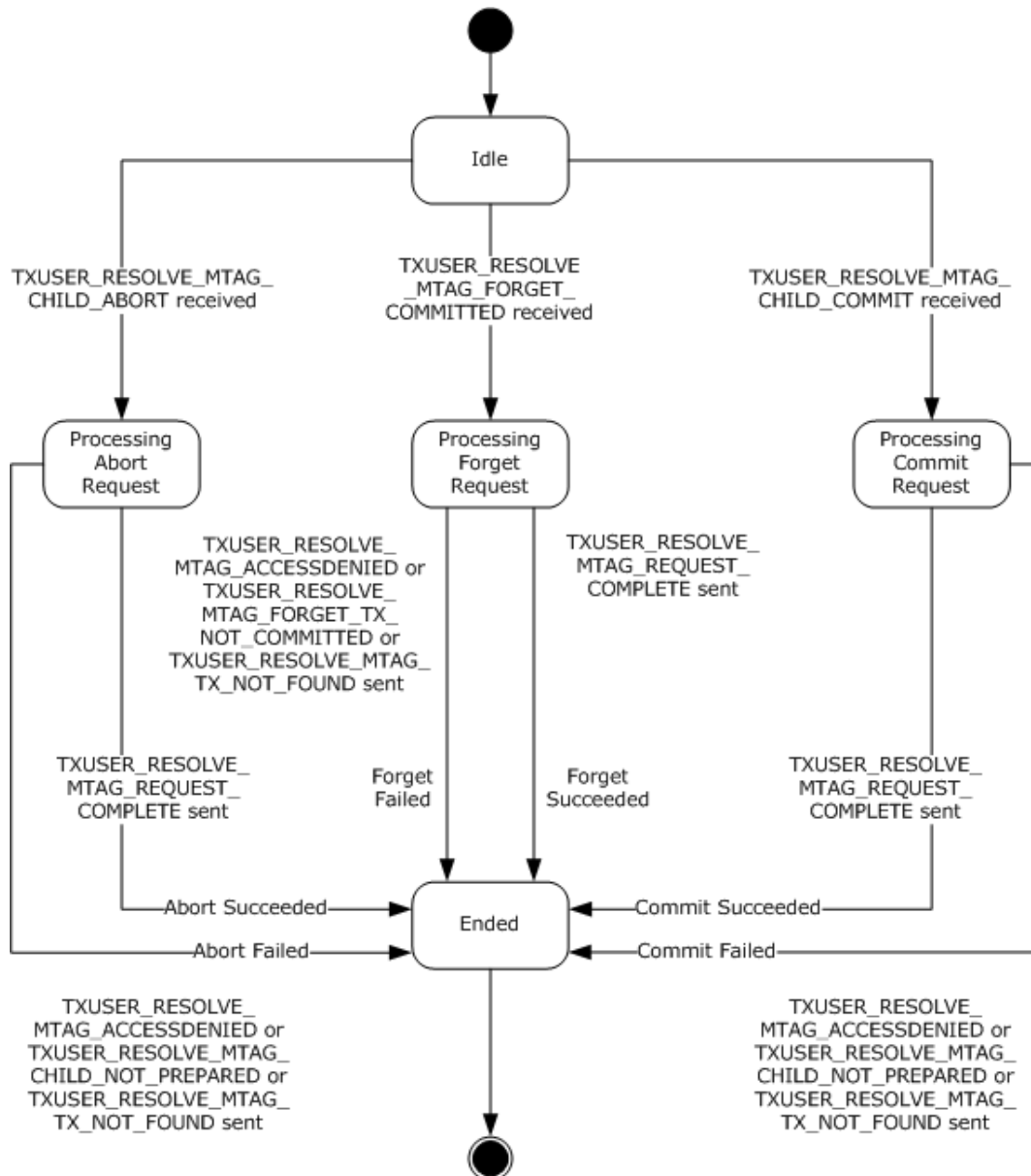

Figure 39: CONNTYPE_TXUSER_RESOLVE Acceptor States

3.4.1.11.1 Idle

This is the initial state. The following events are processed in this state:

- Receiving a TXUSER_RESOLVE_MTAG_CHILD_ABORT Message (section 3.4.5.3.2.1)
- Receiving a TXUSER_RESOLVE_MTAG_CHILD_COMMIT Message (section 3.4.5.3.2.2)
- Receiving a TXUSER_RESOLVE_MTAG_FORGET COMMITTED Message (section 3.4.5.3.2.3)

3.4.1.11.2 Processing Abort Request

The following events are processed in this state:

- Resolve Transaction Complete (section 3.4.7.16)
- Resolve Transaction Access Denied (section 3.4.7.17)

3.4.1.11.3 Processing Forget Request

The following events are processed in this state:

- Resolve Transaction Complete (section 3.4.7.16)
- Resolve Transaction Access Denied (section 3.4.7.17)

3.4.1.11.4 Processing Commit Request

The following events are processed in this state:

- Resolve Transaction Complete (section 3.4.7.16)
- Resolve Transaction Access Denied (section 3.4.7.17)

3.4.1.11.5 Ended

This is the final state.

3.4.1.12 CONNTYPE_TXUSER_SETTXTIMEOUT Acceptor States

The transaction manager communicating with an application MUST act as an acceptor for the CONNTYPE_TXUSER_SETTXTIMEOUT connection type. In this role, the transaction manager communicating with an application MUST provide support for the following states:

- Idle
- Processing Request
- Ended

The following figure shows the relationship between the CONNTYPE_TXUSER_SETTXTIMEOUT acceptor states.

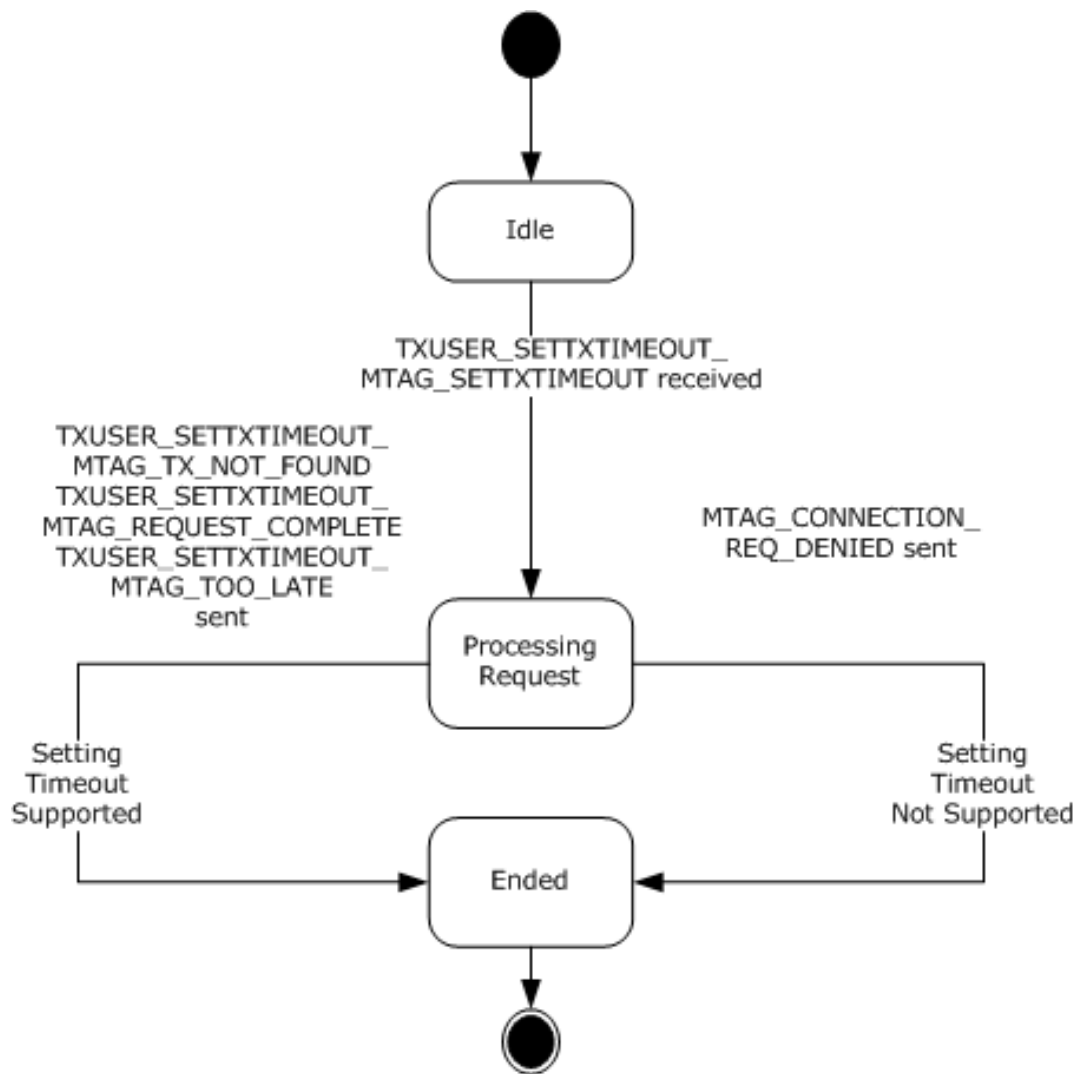

Figure 40: CONNTYPE_TXUSER_SETTXXTIMEOUT Acceptor States

3.4.1.12.1 Idle

This is the initial state. The following event is processed in this state:

- Receiving a TXUSER_SETTXXTIMEOUT_MTAG_SETTXXTIMEOUT Message (section 3.4.5.3.3.1)

3.4.1.12.2 Processing Request

The following events are processed in this state:

- Set Transaction Timeout Success (section 3.4.7.22)
- Set Transaction Timeout Failure (section 3.4.7.21)

3.4.1.12.3 Ended

This is the final state.

3.4.1.13 CONNTYPE_TXUSER_SETTXTIMEOUT2 Acceptor States

The transaction manager communicating with an application **MUST** act as an acceptor for the CONNTYPE_TXUSER_SETTXTIMEOUT2 connection type. In this role, the transaction manager communicating with an application **MUST** provide support for the following states:

- Idle
- Processing Request
- Ended

The following figure shows the relationship between the CONNTYPE_TXUSER_SETTXTIMEOUT2 acceptor states.

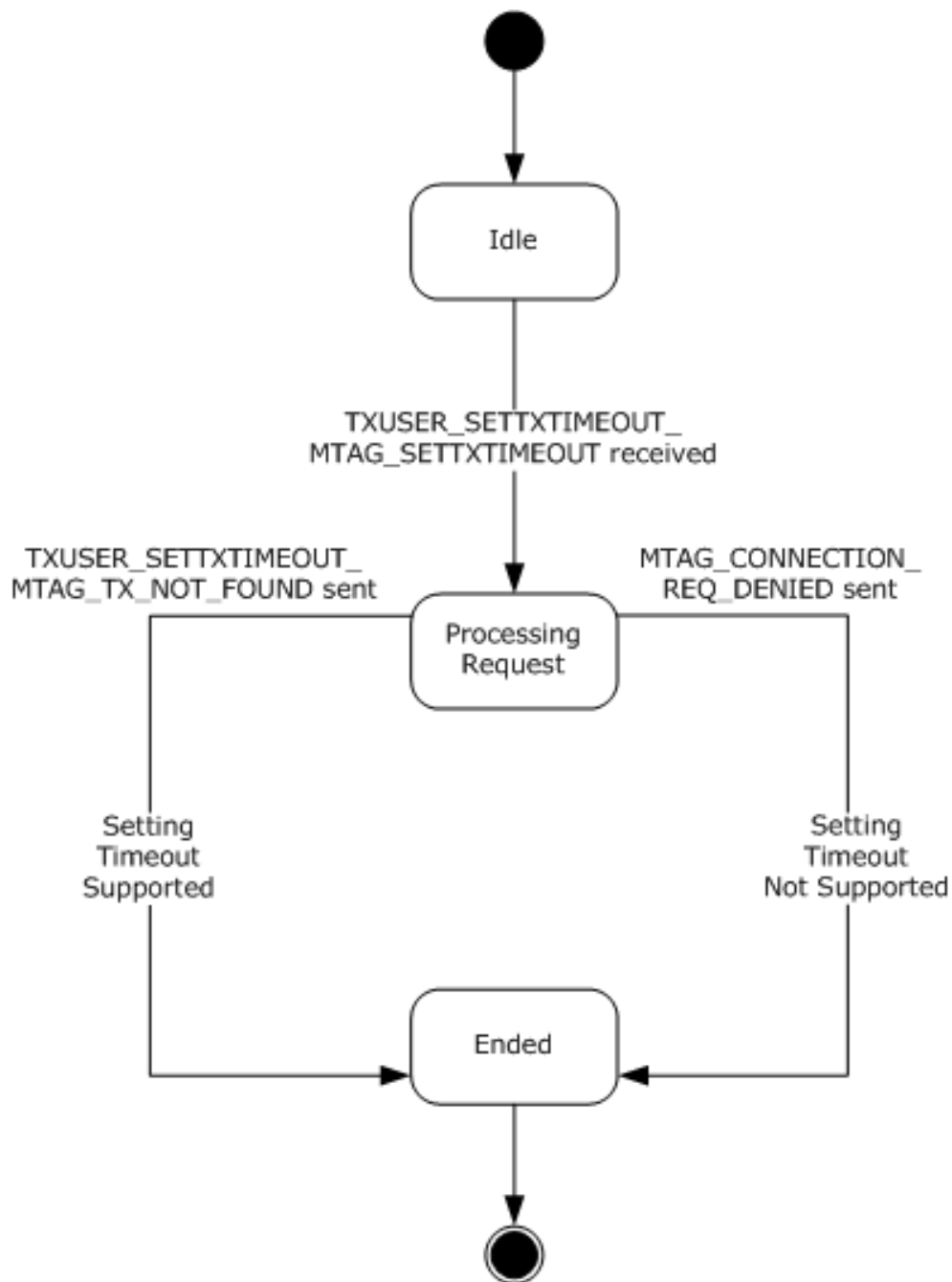

Figure 41: CONNTYPE_TXUSER_SETTXXTIMEOUT2 Acceptor States

3.4.1.13.1 Idle

This is the initial state. The following events are processed in this state:

- Receiving a TXUSER_SETTXXTIMEOUT_MTAG_SETTXXTIMEOUT Message (section 3.4.5.3.4.1).

3.4.1.13.2 Processing Request

This is a transient state that is assumed during the synchronous processing of a request to set a transaction time-out. No events are processed in this state.

3.4.1.13.3 Ended

This is the final state.

3.4.1.14 CONNTYPE_TXUSER_TRACE Acceptor States

The transaction manager communicating with an application MUST act as an acceptor for the CONNTYPE_TXUSER_TRACE connection type. In this role, the transaction manager communicating with an application MUST provide support for the following states:

- Idle
- Processing Trace Request
- Ended

The following figure shows the relationship between the CONNTYPE_TXUSER_TRACE acceptor states.

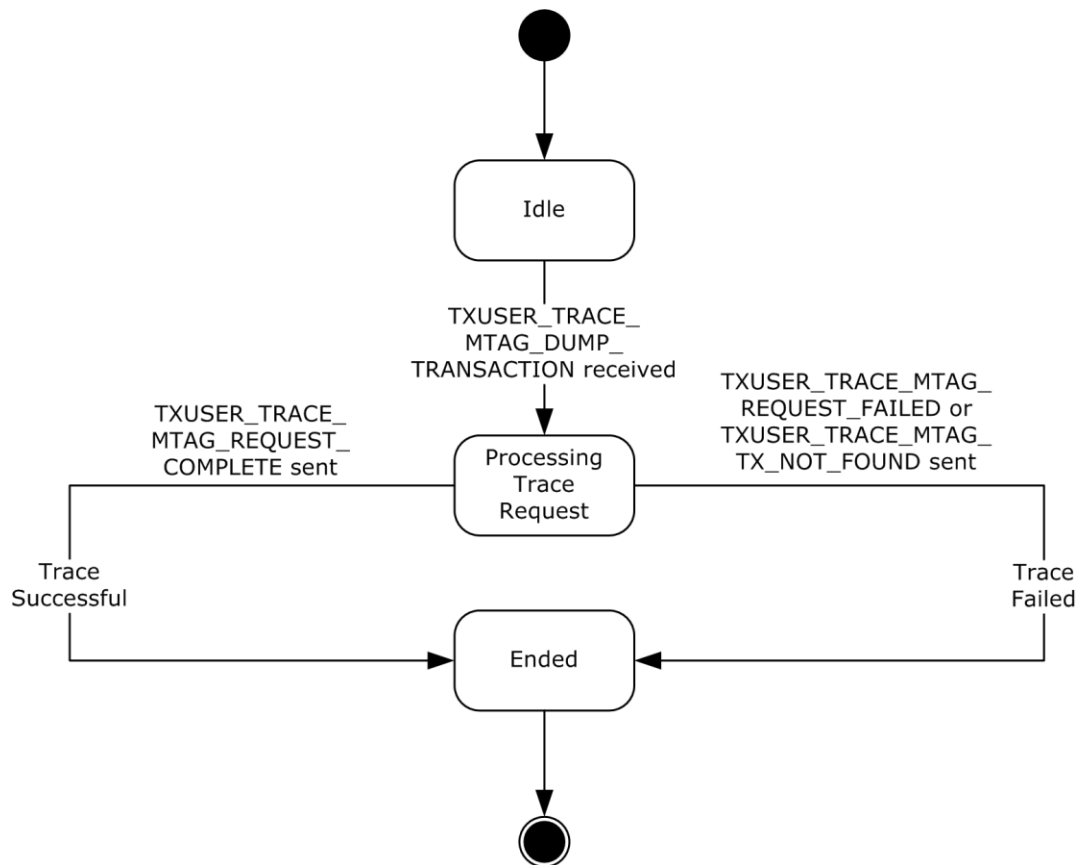

Figure 42: CONNTYPE_TXUSER_TRACE Acceptor States

3.4.1.14.1 Idle

This is the initial state. The following event is processed in this state:

- Receiving a TXUSER_TRACE_MTAG_DUMP_TRANSACTION Message (section 3.4.5.3.5.1)

3.4.1.14.2 Processing Trace Request

This is a transient state that is assumed during the synchronous processing of a request to set a transaction time-out. No events are processed in this state.

3.4.1.14.3 Ended

This is the final state.

3.4.1.15 CONNTYPE_TXUSER_GETSECURITYFLAGS Acceptor States

The transaction manager communicating with an application MUST act as an acceptor for the CONNTYPE_TXUSER_GETSECURITYFLAGS connection type. In this role, the transaction manager communicating with an application MUST provide support for the following states:

- Idle
- Processing Request
- Ended

The following figure shows the relationship between the CONNTYPE_TXUSER_GETSECURITYFLAGS acceptor states.

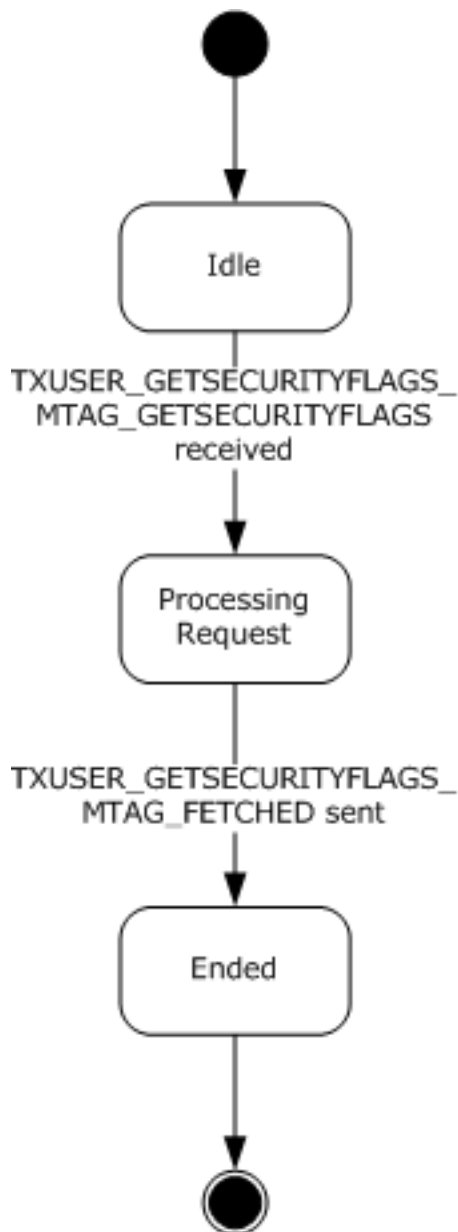

Figure 43: CONNTYPE_TXUSER_GETSECURITYFLAGS Acceptor States

3.4.1.15.1 Idle

This is the initial state. The following event is processed in this state:

- Receiving a TXUSER_GETSECURITYFLAGS_MTAG_GETSECURITYFLAGS Message (section 3.4.5.4.1.1)

3.4.1.15.2 Processing Request

This is a transient state that is assumed during the synchronous processing of a request to get the security flags. No events are processed in this state.

3.4.1.15.3 Ended

This is the final state.

3.4.2 Timers

No timers apply here.

3.4.3 Initialization

When the transaction manager communicating with an application facet is initialized:

- The transaction manager communicating with an application facet **MUST** examine the following security flags on the Core Transaction Manager Facet and perform the following actions:
 - If the Allow Network Access flag is set to false:
 - For all Connection types listed in 3.4.1, the transaction manager communicating with an application facet **MUST** refuse to accept incoming Connections from remote machines as specified in [MS-CMP] section 3.1.5.5 with the rejection **Reason** set to 0x80070005.
 - Otherwise:
 - If the Allow Remote Clients flag is set to false:
 - For the following Connection types, the transaction manager communicating with an application facet **MUST** refuse to accept incoming Connection from remote machines as specified in [MS-CMP] section 3.1.5.5 with the rejection **Reason** set to 0x80070005.
 - CONNTYPE_TXUSER_ASSOCIATE
 - CONNTYPE_TXUSER_BEGINNER
 - CONNTYPE_TXUSER_BEGIN2
 - CONNTYPE_TXUSER_EXPORT
 - CONNTYPE_TXUSER_EXPORT2
 - CONNTYPE_TXUSER_IMPORT
 - CONNTYPE_TXUSER_IMPORT2
 - CONNTYPE_TXUSER_PROMOTE
 - If Allow Remote Administration flag is set to false:
 - For the following connection types, the transaction manager communicating with an application facet **MUST** refuse to accept incoming Connections from remote machines as specified in [MS-CMP] section 3.1.5.5 with the rejection **Reason** set to 0x80070005.
 - CONNTYPE_TXUSER_GETTXDETAILS
 - CONNTYPE_TXUSER_RESOLVE
 - CONNTYPE_TXUSER_TRACE

All data elements maintained by the transaction manager communicating with an application facet are initialized to an empty value unless stated otherwise in this section or in the initialization sections of the facets the transaction manager communicating with an application facet extends, as described in section 3.4.1.

3.4.4 Higher-Layer Triggered Events

No higher-layer triggered events apply here.

3.4.5 Processing Events and Sequencing Rules

3.4.5.1 Transaction Initiation and Completion

3.4.5.1.1 CONNTYPE_TXUSER_BEGINNER as Acceptor

For all messages that are received in this connection type, the transaction manager communicating with an application facet **MUST** process the message as specified in section 3.1. The transaction manager communicating with an application facet **MUST** also follow the processing rules that are specified in the following sections.

3.4.5.1.1.1 Receiving a TXUSER_BEGINNER_MTAG_BEGIN Message

When the transaction manager communicating with an application facet receives a TXUSER_BEGINNER_MTAG_BEGIN (section 2.2.8.1.1.2) message, the transaction manager communicating with an application facet **MUST** perform the following actions:

- If the connection state is Idle:
 - Set the connection state to Beginning Transaction.
 - If the transaction manager does not have sufficient memory available to process the message:
 - Send a TXUSER_BEGINNER_MTAG_BEGIN_NO_MEM (section 2.2.8.1.1.4) message using the connection.
 - Set the connection state to Ended.
 - Otherwise:
 - Create a transaction object using the transaction settings provided in the message:
 - Use the **isoLevel** field as the Isolation Level value of the transaction.
 - Use the **dwTimeout** field as the Timeout value of the transaction.
 - Use the **szDesc** field as the Description value of the transaction.
 - Use the **isoFlags** field as the Isolation Flags value of the transaction.
 - Create a new GUID as specified in [RFC4122] and assign it to the **Transaction Object.Identifier** field of the transaction object.
 - Add the connection to the connection list of the transaction.
 - Set the **Transaction** field of the connection to the transaction object.
 - Create a new Enlistment object with the following values:
 - The transaction manager communicating with an application facet
 - The transaction object
 - The connection
 - Set the Enlistment field of the connection to the new Enlistment object.

- Signal the Create Transaction (section 3.2.7.13) event on the Core Transaction Manager Facet (section 1.3.3.3.1) with the Enlistment object.
- Otherwise, the message MUST be processed as an invalid message, as specified in section 3.1.6.

3.4.5.1.1.2 Receiving a TXUSER_BEGINNER_MTAG_COMMIT Message

When the transaction manager communicating with an application facet receives a TXUSER_BEGINNER_MTAG_COMMIT message, the transaction manager communicating with an application facet MUST perform the following actions:

- If the connection state is Active:
 - Set the connection state to Committing Transaction.
 - Obtain the transaction object referenced by the Enlistment object referenced by this connection.
 - Set the **GRFRM** field of the transaction object to the **grfrm** field of the message.
 - Signal the Begin Phase Zero (section 3.2.7.5) event on the Core Transaction Manager Facet with the transaction object.
- If the connection state is Aborting Transaction:
 - Send a TXUSER_BEGINNER_MTAG_COMMIT_TOO_LATE message using the connection.
 - Set the connection state to Ended.
- Otherwise, the message MUST be processed as an invalid message as specified in section 3.1.6.

3.4.5.1.1.3 Receiving a TXUSER_BEGINNER_MTAG_ABORT Message

When the transaction manager communicating with an application facet receives a TXUSER_BEGINNER_MTAG_ABORT message, the transaction manager communicating with an application facet MUST perform the following actions:

- If the connection state is Active:
 - Set the connection state to Aborting Transaction.
 - Signal the Begin Rollback (section 3.2.7.6) event on the Core Transaction Manager Facet with the transaction object referenced by the Enlistment object referenced by this connection.
- If the connection state is Aborting Transaction:
 - Send a TXUSER_BEGINNER_MTAG_REQUEST_COMPLETED message using the connection.
 - Set the connection state to Ended.
- Otherwise, the message MUST be processed as an invalid message as specified in section 3.1.6.

3.4.5.1.1.4 Connection Disconnected

When a CONNTYPE_TXUSER_BEGINNER (section 2.2.8.1.1) connection is disconnected, the transaction manager communicating with an application facet MUST perform the following actions:

- If the connection state is Active (section 3.4.1.1.3):

- Signal the Begin Rollback (section 3.2.7.6) event on the Core Transaction Manager Facet (section 1.3.3.3.1) with the transaction object referenced by the Enlistment object referenced by this connection.
- Otherwise, the event MUST be processed as specified in section 3.1.8.3.

3.4.5.1.2 CONNTYPE_TXUSER_BEGIN2 as Acceptor

For all messages received in this connection type, the transaction manager communicating with an application facet MUST process the message as specified in section 3.1. The transaction manager communicating with an application facet MUST also follow the processing rules specified in the following sections.

3.4.5.1.2.1 Receiving a TXUSER_BEGIN2_MTAG_BEGIN Message

When the transaction manager communicating with an application facet receives a TXUSER_BEGIN2_MTAG_BEGIN (section 2.2.8.1.2.2) message, the transaction manager communicating with an application facet MUST perform the following actions:

- If the connection state is Idle:
 - Set the connection state to Beginning Transaction.
 - If the transaction manager does not have sufficient memory available to process the message, it MUST:
 - Send a TXUSER_BEGIN2_MTAG_SINK_ERROR (section 2.2.8.1.2.5) message using the connection:
 - The **Error** field MUST be set to TRUN_TXBEGIN_ERROR_NO_MEM.
 - Set the connection state to Ended.
 - Otherwise:
 - Create a transaction object using the transaction settings provided in the message:
 - Use the **isoLevel** field as the Isolation Level value of the transaction.
 - Use the **dwTimeout** field as the Timeout value of the transaction.
 - Use the **szDesc** field as the Description value of the transaction.
 - Use the **isoFlags** field as the Isolation Flags value of the transaction.
 - Create a new GUID as specified in [RFC4122] and assign it to the **Transaction Object.Identifier** field of the transaction object.
 - Add the connection to the connection list of the transaction.
 - Create a new enlistment object with the following values:
 - The transaction manager communicating with an application facet.
 - The transaction object.
 - The connection.
 - Set the **Enlistment** field of the connection to the new enlistment object.

- Signal the Create Transaction (section 3.2.7.13) event on the Core Transaction Manager Facet with the enlistment object.
- Otherwise, the message MUST be processed as an invalid message as specified in section 3.1.6.

3.4.5.1.2.2 Receiving a TXUSER_SETTXTIMEOUT_MTAG_SETTXTIMEOUT Message

When the transaction manager communicating with an application facet receives a TXUSER_SETTXTIMEOUT_MTAG_SETTXTIMEOUT message, the transaction manager communicating with an application facet MUST perform the following actions:

- If the connection state is Active:
 - Set the connection state to Modifying Timeout.
 - Signal the Set Transaction Timeout event on the Core Transaction Manager Facet with the following arguments:
 - The transaction object referenced by the Enlistment object referenced by this connection
 - The **dwTxTimeout** field from the message
- Otherwise, the message MUST be processed as an invalid message as specified in section 3.1.6.

3.4.5.1.2.3 Receiving a TXUSER_BEGIN2_MTAG_COMMIT Message

When the transaction manager communicating with an application facet receives a TXUSER_BEGIN2_MTAG_COMMIT message, the transaction manager communicating with an application facet MUST perform the following actions:

- If the connection state is Active:
 - Set the connection state to Committing Transaction.
 - Obtain the transaction object referenced by the Enlistment object referenced by this connection.
 - Set the **GRFRM** field of the transaction object to the **grfrm** field of the message.
 - Signal the Begin Phase Zero (section 3.2.7.5) event on the Core Transaction Manager Facet with the transaction object.
- Otherwise, the message MUST be processed as an invalid message as specified in section 3.1.6.

3.4.5.1.2.4 Receiving a TXUSER_BEGIN2_MTAG_ABORT Message

When the transaction manager communicating with an application facet receives a TXUSER_BEGIN2_MTAG_ABORT (section 2.2.8.1.2.1) message, the transaction manager communicating with an application facet MUST perform the following actions:

- If the connection state is Active:
 - Set the connection state to Aborting Transaction.
 - Signal the Begin Rollback (section 3.2.7.6) event on the Core Transaction Manager Facet with the transaction object referenced by the Enlistment object referenced by this connection.
- Otherwise, the message MUST be processed as an invalid message as specified in section 3.1.6.

3.4.5.1.2.5 Connection Disconnected

When a CONNTYPE_TXUSER_BEGIN2 (section 2.2.8.1.2) connection is disconnected, the transaction manager communicating with an application facet MUST perform the following actions:

- If the connection state is Active (section 3.4.1.2.3):
 - Signal the Begin Rollback (section 3.2.7.6) event on the Core Transaction Manager Facet (section 1.3.3.3.1) with the transaction object referenced by the Enlistment object referenced by this connection.
- Otherwise, the event MUST be processed as specified in section 3.1.8.3.

3.4.5.1.3 CONNTYPE_TXUSER_PROMOTE as Acceptor

For all messages received in this connection type, the transaction manager communicating with an application facet MUST process the message as specified in section 3.1. The transaction manager communicating with an application facet MUST also follow the processing rules specified in the following sections.

3.4.5.1.3.1 Receiving a TXUSER_BEGINNER_MTAG_PROMOTE Message

When the transaction manager communicating with an application facet receives a TXUSER_BEGINNER_MTAG_PROMOTE message, the transaction manager communicating with an application facet MUST perform the following actions:

- If the connection state is Idle:
 - Set the connection state to Beginning Transaction.
 - If the transaction manager does not have sufficient memory available to process the message:
 - Send a TXUSER_BEGIN2_MTAG_SINK_ERROR message using the connection:
 - The Error field MUST be set to TRUN_TXBEGIN_ERROR_NO_MEM.
 - Set the connection state to Ended.
 - Otherwise:
 - Create a transaction object using the transaction settings provided in the message:
 - Use the **isoLevel** field as the Isolation Level value of the transaction.
 - Use the **dwTimeout** field as the Timeout value of the transaction.
 - Use the **szDesc** field as the Description value of the transaction.
 - Use the **isoFlags** field as the Isolation Flags value of the transaction.
 - Use the **guidTX** field as the **Transaction Object.Identifier** value of the transaction.
 - Add the connection to the connection list of the transaction.
 - Create a new Enlistment object with the following values:
 - The transaction manager communicating with an application facet.
 - The transaction object.
 - The connection.
 - Set the **Enlistment** field of the connection to the new Enlistment object.

- Signal the Create Transaction (section 3.2.7.13) event on the Core Transaction Manager Facet with the enlistment object.
- Otherwise, the message MUST be processed as an invalid message as specified in section 3.1.6.

3.4.5.1.3.2 Receiving a TXUSER_SETTXTIMEOUT_MTAG_SETTXTIMEOUT, TXUSER_BEGIN2_MTAG_COMMIT, or TXUSER_BEGIN2_MTAG_ABORT Message

When the transaction manager communicating with an application facet receives one of these messages, it MUST follow the same message-processing rules as the CONNTYPE_TXUSER_BEGIN2 connection type acting as an acceptor, as specified in section 3.4.5.1.2.

3.4.5.1.3.3 Connection Disconnected

When a CONNTYPE_TXUSER_PROMOTE (section 2.2.8.1.3) connection is disconnected, the transaction manager communicating with an application facet MUST perform the same actions as the CONNTYPE_TXUSER_BEGIN2 (section 2.2.8.1.2) connection type acting as an acceptor. See section 3.4.5.1.2 for more information.

3.4.5.2 Transaction Propagation

3.4.5.2.1 Pull Propagation

3.4.5.2.1.1 CONNTYPE_TXUSER_ASSOCIATE as Acceptor

For all messages received in this connection type, the transaction manager communicating with an application facet MUST process the message as specified in section 3.1. The transaction manager MUST also follow the processing rules that are specified in the following sections.

3.4.5.2.1.1.1 Receiving a TXUSER_ASSOCIATE_MTAG_ASSOCIATE Message

When the transaction manager communicating with an application facet receives a TXUSER_ASSOCIATE_MTAG_ASSOCIATE message, it MUST perform the following actions:

- If the connection state is Idle:
 - Set the connection state to Processing Associate Request (section 3.4.1.4.2).
 - Override the default schema verification actions for incoming messages as specified in section 3.1.6 in the following manner:
 - If the first 16 bytes of the **SourceTmAddr** field is equal to the binary representation of the GUID {DC85CB48-D8A5-11d2-828B-00805F0DF75A}, then:
 - If the **SourceTmAddr** field does not conform to the constraints specified in section 2.2.4.2 for a valid OLETX_TM_ADDR structure, then:
 - Send a TXUSER_ASSOCIATE_MTAG_CREATE_BAD_TMADDR message by using the connection.
 - Perform default invalid message processing, as specified in section 3.1.6.
 - Stop processing the message.
 - Otherwise, if the **SourceTmAddr** field does not conform to the constraints specified in section 2.2.5.3 for a valid NAMEOBJECTBLOB structure, then:

- Send a TXUSER_ASSOCIATE_MTAG_CREATE_BAD_TMADDR message by using the connection.
- Perform default invalid message processing, as specified in section 3.1.6.
- Stop processing the message.
- If the Allow Network Access flag, the Allow Network Transactions flag, or the Allow Inbound Transactions flag of the core transaction manager is set to false:
 - Send a TXUSER_ASSOCIATE_MTAG_CREATE_BAD_TMADDR message using the connection.
 - Set the connection state to Ended.
- Otherwise, if the transaction manager does not have sufficient memory available to process the message:
 - Send a TXUSER_ASSOCIATE_MTAG_NO_MEM_LOCAL message.
 - Set the connection state to Ended.
- Otherwise:
 - Find the transaction object in the transaction table of the transaction manager using the **guidTx** field from the message as the key:
 - If the transaction object is found in the list:
 - Send a TXUSER_ASSOCIATE_MTAG_ASSOCIATED message to the application.
 - Set the connection state to Active.
 - Otherwise, if the transaction object is not found in the list, the transaction manager MUST:
 - Find the list of CONNTYPE_TXUSER_ASSOCIATE connections in the Associates Table field of the transaction manager communicating with an application, using the **guidTx** field from the message as a key.
 - If the list is found:
 - Add this connection to the list.
 - Otherwise:
 - Create an empty list of CONNTYPE_TXUSER_ASSOCIATE connections and add this connection to it.
 - Add the list to the associates table of the transaction manager communicating with an application under the following key:
 - The **guidTx** field from the message.
 - Create a new transaction object with the information provided in the message:
 - Use the **guidTx** field as the **Transaction Object.Identifier** value.
 - Use the **isoLevel** field as the Isolation Level value.
 - Use the **szDesc** field as the Description value.

- If the **SourceTmAddr** field contains OLETX_TM_ADDR (section 2.2.4.2), convert the **SourceTmAddr** field from the message to a new Name object, as specified in section 3.1.1.2.
- Otherwise, convert the **SourceTmAddr** field from the message to a new Name object, as specified in Converting a NAMEOBJECTBLOB Structure to a Name Object (section 3.1.1.4).
- Signal the Associate Transaction (section 3.2.7.1) event on the Core Transaction Manager Facet with the following arguments:
 - The transaction object.
 - The new Name object.
- Otherwise, the message MUST be processed as an invalid message as specified in section 3.1.6.

3.4.5.2.1.1.2 Connection Disconnected

When a CONNTYPE_TXUSER_ASSOCIATE connection is disconnected, the transaction manager communicating with an application facet MUST perform the actions as specified in section 3.1.8.3.

3.4.5.2.2 Push Propagation

3.4.5.2.2.1 CONNTYPE_TXUSER_EXTENDEDWHEREABOUTS as Acceptor

For all messages received in this connection type, the transaction manager communicating with an application facet MUST process the message as specified in section 3.1. The transaction manager MUST also follow the processing rules specified in the following sections.

3.4.5.2.2.1.1 Receiving a TXUSER_EXTENDEDWHEREABOUTS_MTAG_GET Message

When the transaction manager communicating with an application facet receives a TXUSER_EXTENDEDWHEREABOUTS_MTAG_GET message, the transaction manager MUST perform the following actions:

- If the connection state is Idle:
 - Set the connection state to Processing Inquiry.
 - If the transaction manager does not have enough memory to process the TXUSER_EXTENDEDWHEREABOUTS_MTAG_GET message:
 - Send a TXUSER_EXTENDEDWHEREABOUTS_MTAG_NOMEM message using the connection.
 - Otherwise:
 - Send a TXUSER_EXTENDEDWHEREABOUTS_MTAG_GOT message using the connection:
 - If the **Extended Whereabouts Protocol Count** field of the Core Transaction Manager Facet is zero:
 - Set the **dwProtocolCount** field to zero.
 - Set the **rgtmprotUsableList** field to empty.
 - Otherwise:
 - Set the **dwProtocolCount** field to the **Extended Whereabouts Protocol Count** field of the core transaction manager.

- Set the contents of the **rgtmprotUsableList** field to the contents of the **Extended Whereabouts** field of the core transaction manager. The size of the **rgtmprotUsableList** field in bytes MUST be determined by the **Extended Whereabouts Size** field of the core transaction manager.
 - Set the connection state to Ended.
- Otherwise, the message MUST be processed as an invalid message as specified in section 3.1.6.

3.4.5.2.2.1.2 Connection Disconnected

When a CONNTYPE_TXUSER_EXTENDEDWHEREABOUTS (section 2.2.8.2.2.1) connection is disconnected, the transaction manager MUST perform the actions as specified in section 3.1.8.3.

3.4.5.2.2.2 CONNTYPE_TXUSER_EXPORT as Acceptor

For all messages received in this connection type, the transaction manager communicating with an application facet MUST process the message as specified in section 3.1. The transaction manager MUST also follow the processing rules specified in the following sections.

3.4.5.2.2.2.1 Receiving a TXUSER_EXPORT_MTAG_CREATE Message

When the transaction manager communicating with an application facet receives a TXUSER_EXPORT_MTAG_CREATE message, the transaction manager MUST perform the following actions:

- If the connection state is Idle:
 - Set the connection state to Processing Connection Request.
 - If the first 16 bytes of **SourceTmAddr** is equal to the binary representation of the GUID {DC85CB48-D8A5-11d2-828B-00805F0DF75A}, the **SourceTmAddr** field MUST contain an OLETX_TM_ADDR (section 2.2.4.2) structure.
 - Otherwise, the **SourceTmAddr** field MUST contain a NAMEOBJECTBLOB (section 2.2.5.3) structure.
 - Override the default schema verification actions for incoming messages as specified in section 3.1.6 in the following manner:
 - If the **SourceTmAddr** field from the message contains an OLETX_TM_ADDR structure and violates the constraints specified in section 2.2.4.2 or if the **SourceTmAddr** field from the message contains a NAMEOBJECTBLOB structure and violates the constraints specified in section 2.2.5.3, the transaction manager MUST:
 - Send a TXUSER_EXPORT_MTAG_CREATE_BAD_TMADDR message using the connection.
 - Perform default invalid message processing, as specified in section 3.1.6.
 - Cease processing the message.
 - If the Allow Network Access flag, the Allow Network Transactions flag, or the Allow Outbound Transactions flag of the Core Transaction Manager Facet is set to false:
 - Send a TXUSER_EXPORT_MTAG_CREATE_BAD_TMADDR message using the connection.
 - Set the connection state to Ended.
 - Otherwise:

- If the **SourceTmAddr** field contains an OLETX_TM_ADDR structure, convert the **SourceTmAddr** field from the message to a new Name object, as specified in section 3.1.1.2.
- Otherwise, convert the **SourceTmAddr** field from the message to a new Name object, as specified in Converting a NAMEOBJECTBLOB Structure to a Name Object (section 3.1.1.4).
- Store the Name object in the **Connection-Specific Data** field of the connection object.
- Send a TXUSER_EXPORT_MTAG_CREATED message using the connection.
- Set the connection state to Connection Active.
- Otherwise, the message MUST be processed as an invalid message as specified in section 3.1.6.

3.4.5.2.2.2.2 Receiving a TXUSER_EXPORT_MTAG_CREATE2 Message

When the transaction manager receives a TXUSER_EXPORT_MTAG_CREATE2 (section 2.2.8.2.2.2.2) message, the transaction manager MUST perform the following actions:

- If the connection state is Idle:
 - Set the connection state to Processing Connection Request.
 - Override the default schema verification actions for incoming messages as specified in section 3.1.6 in the following manner:
 - If the SourceTmAddr field in the message does not comply with the constraints specified in section 2.2.4.2:
 - Send a TXUSER_EXPORT_MTAG_CREATE_BAD_TMADDR message using the connection.
 - Perform default invalid message processing, as specified in section 3.1.6.
 - Cease processing the message.
 - If the Allow Network Access flag, the Allow Network Transactions flag, or the Allow Outbound Transactions flag of the Core Transaction Manager Facet is set to false:
 - Send a TXUSER_EXPORT_MTAG_CREATE_NET_TX_DISABLED message using the connection.
 - Set the connection state to Ended.
 - Otherwise:
 - Convert the **SourceTmAddr** field from the message to a new Name object, as specified in section 3.1.1.2.
 - Store the Name object in the **Connection-Specific Data** field of the connection object.
 - Send a TXUSER_EXPORT_MTAG_CREATED message using the connection.
 - Set the connection state to Connection Active.
- Otherwise, the message MUST be processed as an invalid message as specified in section 3.1.6.

3.4.5.2.2.2.3 Receiving a TXUSER_EXPORT_MTAG_EXPORT Message

When the transaction manager receives a TXUSER_EXPORT_MTAG_EXPORT message, the transaction manager MUST perform the following actions:

- If the connection state is Connection Active:
 - Set the connection state to Processing Push Operation Request.
 - Find the transaction object in the transaction table of the transaction manager by using the **guidTX** field from the message as the key.
 - If the transaction object is not found:
 - Send a TXUSER_EXPORT_MTAG_EXPORT_TX_NOT_FOUND message using the connection.
 - Set the connection state to Connection Active.
 - Otherwise:
 - Add the connection to the connection list of the transaction.
 - Signal the Export Transaction (section 3.2.7.21) event on the Core Transaction Manager Facet with the following arguments:
 - The Name object stored in the **Connection-Specific Data** field of the connection
 - The transaction object
- Otherwise, the message MUST be processed as an invalid message as specified in section 3.1.6.

3.4.5.2.2.2.4 Connection Disconnected

When a CONNTYPE_TXUSER_EXPORT (section 2.2.8.2.2.2) connection is disconnected, the transaction manager communicating with an application facet MUST perform the actions as specified in section 3.1.8.3.

3.4.5.2.2.3 CONNTYPE_TXUSER_EXPORT2 as Acceptor

For all messages received in this connection type, the transaction manager communicating with an application facet MUST process the messages as specified in section 3.1. The transaction manager MUST also follow the processing rules specified in the following sections.

3.4.5.2.2.3.1 Receiving a TXUSER_EXPORT_MTAG_CREATE Message

When the transaction manager communicating with an application facet receives a TXUSER_EXPORT_MTAG_CREATE message, the transaction manager MUST perform the actions specified in section 3.4.5.2.2.2.1.

3.4.5.2.2.3.2 Receiving a TXUSER_EXPORT_MTAG_CREATE2 Message

When the transaction manager receives a TXUSER_EXPORT_MTAG_CREATE2 message, the transaction manager MUST perform the actions specified in section 3.4.5.2.2.2.2.

3.4.5.2.2.3.3 Receiving a TXUSER_EXPORT_MTAG_EXPORT Message

When the transaction manager receives a TXUSER_EXPORT_MTAG_EXPORT message, the transaction manager MUST perform the actions specified in section 3.4.5.2.2.2.3.

3.4.5.2.2.3.4 Connection Disconnected

When a CONNTYPE_TXUSER_EXPORT2 (section 2.2.8.2.2.3) connection is disconnected, the transaction manager communicating with an application facet MUST perform the actions as specified in section 3.1.8.3.

3.4.5.2.2.4 CONNTYPE_TXUSER_IMPORT as Acceptor

For all messages received in this connection type, the transaction manager communicating with an application facet MUST process the messages as specified in section 3.1. The transaction manager MUST also follow the processing rules specified in the following sections.

3.4.5.2.2.4.1 Receiving a TXUSER_IMPORT_MTAG_IMPORT Message

When the transaction manager receives a TXUSER_IMPORT_MTAG_IMPORT message, the transaction manager MUST perform the following actions:

- If the connection state is Idle:
 - Set the connection state to Processing Import Request.
 - Find the transaction object in the transaction table of the transaction manager by using the **guidTx** field from the message as the key.
 - If the transaction object is not found or if the transaction state is not Active, Phase Zero, or Phase Zero Complete:
 - Send a TXUSER_IMPORT_MTAG_IMPORT_TX_NOT_FOUND message using the connection.
 - Set the connection state to Ended.
 - Otherwise:
 - Add the connection to the connection list of the transaction.
 - Create a new Enlistment object using the following fields:
 - The transaction manager communicating with an application facet
 - The transaction object
 - The connection object
 - Assign the new Enlistment object to the **Enlistment** field of the connection.
 - Signal the Create Voter Enlistment event on the Core Transaction Manager Facet with the new Enlistment object.
- Otherwise, the message MUST be processed as an invalid message as specified in section 3.1.6.

3.4.5.2.2.4.2 Receiving a TXUSER_IMPORT_MTAG_ABORT Message

When the transaction manager receives a TXUSER_IMPORT_MTAG_ABORT message, the transaction manager MUST perform the following actions:

- If the connection state is Too Late to Abort:
 - Set the connection state to Processing Abort Request.
 - Send a TXUSER_IMPORT_MTAG_ABORT_TOO_LATE message using the connection.
 - Set the connection state to Ended.

- Otherwise, if the connection state is Active:
 - Set the connection state to Processing Abort Request.
 - Signal the Enlistment Unilaterally Aborted (section 3.2.7.19) event of the Core Transaction Manager Facet with the **Enlistment** field of the connection.
 - Send a TXUSER_IMPORT_MTAG_REQUEST_COMPLETED message.
 - Set the connection state to Ended.
- Otherwise, the message MUST be processed as an invalid message as specified in section 3.1.6.

3.4.5.2.2.4.3 Connection Disconnected

When a CONNTYPE_TXUSER_ASSOCIATE (section 2.2.8.2.1.1) connection is disconnected, the transaction manager MUST perform the actions as specified in section 3.1.8.3.

3.4.5.2.2.5 CONNTYPE_TXUSER_IMPORT2 as Acceptor

For all messages received in this connection type, the transaction manager communicating with an application facet MUST process the messages as specified in section 3.1. The transaction manager MUST also follow the processing rules specified in the following sections.

3.4.5.2.2.5.1 Receiving a TXUSER_IMPORT2_MTAG_IMPORT Message

When the transaction manager receives a TXUSER_IMPORT2_MTAG_IMPORT message, the transaction manager MUST perform the following actions:

- If the connection state is Idle:
 - Set the connection state to Processing Import Request.
 - Find the transaction object in the transaction table of the transaction manager by using the **guidTx** field from the message as the key.
 - If the transaction object is not found or if the transaction state is not Active, Phase Zero or Phase Zero Complete:
 - Send a TXUSER_IMPORT2_MTAG_SINK_ERROR message using the connection:
 - The **Error** field MUST be set to TRUN_TXIMPORT_ERROR_IMPORT_TX_NOT_FOUND.
 - Set the connection state to Ended.
 - Otherwise:
 - Add the connection to the connection list of the transaction.
 - Create a new Enlistment object using the following fields:
 - The transaction manager communicating with an application facet.
 - The transaction object.
 - The connection object.
 - Assign the new Enlistment object to the **Enlistment** field of the connection.
 - Signal the Create Voter Enlistment event on the Core Transaction Manager Facet with the new Enlistment object.

- Otherwise, the message MUST be processed as an invalid message as specified in section 3.1.6.

3.4.5.2.2.5.2 Receiving a TXUSER_IMPORT2_MTAG_IMPORT_WITH_SET Message

When the transaction manager receives a TXUSER_IMPORT2_MTAG_IMPORT_WITH_SET message, the transaction manager MUST perform the following actions:

- If the connection state is Idle:
 - Set the connection state to Processing Import Request.
 - Find the transaction object in the transaction table of the transaction manager by using the **guidTx** field from the message as the key.
 - If the transaction object is not found or if the transaction state is not Active, Phase Zero, or Phase Zero Complete:
 - Send a TXUSER_IMPORT2_MTAG_SINK_ERROR message using the connection:
 - The **Error** field MUST be set to TRUN_TXIMPORT_ERROR_IMPORT_TX_NOT_FOUND.
 - Set the connection state to Ended.
 - Otherwise:
 - Add the connection to the connection list of the transaction.
 - Signal the Set Transaction Attributes (section 3.2.7.31) event on the Core Transaction Manager Facet with the following arguments:
 - The transaction object
 - The **isoLevel** field from the message
 - The **isoFlags** field from the message
 - The **szDesc** field from the message
- Otherwise, the message MUST be processed as an invalid message as specified in section 3.1.6.

3.4.5.2.2.5.3 Receiving a TXUSER_IMPORT2_MTAG_ABORT Message

When the transaction manager receives a TXUSER_IMPORT2_MTAG_ABORT (section 2.2.8.2.2.5.1) message, the transaction manager MUST perform the following actions:

- If the connection state is Too Late to Abort:
 - Set the connection state to Processing Abort Request.
 - Send a TXUSER_IMPORT2_MTAG_SINK_ERROR (section 2.2.8.2.2.5.4) message using the connection:
 - The **Error** field MUST be set to TRUN_TXIMPORT_ERROR_NOTIFY_ABORTED.
 - Set the connection state to Ended.
- Otherwise, if the connection state is Active:
 - Set the connection state to Processing Abort Request.
 - Signal the Enlistment Unilaterally Aborted (section 3.2.7.19) event of the Core Transaction Manager Facet with the **Enlistment** field of the connection.

- Send a TXUSER_IMPORT2_MTAG_SINK_ERROR message.
 - The **Error** field MUST be set to TRUN_TXIMPORT_ERROR_NOTIFY_ABORTED.
- Set the connection state to Ended.
- Otherwise, the message MUST be processed as an invalid message as specified in section 3.1.6.

3.4.5.2.2.5.4 Connection Disconnected

When a CONNTYPE_TXUSER_ASSOCIATE (section 2.2.8.2.1.1) connection is disconnected, the transaction manager MUST perform the actions as specified in section 3.1.8.3.

3.4.5.3 Transaction Administration

3.4.5.3.1 CONNTYPE_TXUSER_GETTXDETAILS as Acceptor

For all messages received in this connection type, the transaction manager MUST process the message as specified in section 3.1. The transaction manager MUST also follow the processing rules that are specified in the following sections.

3.4.5.3.1.1 Receiving a TXUSER_GETTXDETAILS_MTAG_GET Message

When the transaction manager receives a TXUSER_GETTXDETAILS_MTAG_GET message, the transaction manager MUST perform the following actions:

- If the connection state is Idle:
 - Set the connection state to Processing Inquiry.
 - Find the transaction object in the transaction table of the transaction manager by using the **guidTx** field from the message as the key:
 - If the transaction object is not found in the list, the transaction manager MUST:
 - Send a TXUSER_GETTXDETAILS_MTAG_TX_NOT_FOUND message using the connection.
 - Otherwise:
 - Send a TXUSER_GETTXDETAILS_MTAG_GOTIT message using the connection with the message fields set as follows:
 - The **vszSuperiorName** field MUST be set to a new OLETX_VARLEN_STRING structure that is populated with the transaction object's Superior enlistment object's Name property.
 - The **vszSuperiorID** field MUST be set to a new OLETX_VARLEN_STRING structure that is populated with the transaction object's Superior enlistment object's **Enlistment Object.Identifier** property.
 - The **rgSubordinates** field MUST be set to an array of OLETX_VARLEN_STRING structures. Each subordinate entry is represented by two adjacent structures, whose values are set as follows:
 - For each enlistment object in the Phase One enlistment and Phase Two enlistment lists of the transaction:
 - The first subordinate structure MUST be set to the Name property of the enlistment object.

- The second subordinate structure MUST be set to the **Enlistment Object.Identifier** property of the enlistment object.
 - The **ISubordinateCount** field MUST be set to the number of enlistment objects whose values were added to the rgSubordinates array.
- Set the connection state to Ended.
- Otherwise, the message MUST be processed as an invalid message as specified in section 3.1.6.

3.4.5.3.1.2 Connection Disconnected

When a CONNTYPE_TXUSER_GETTXDETAILS (section 2.2.8.3.1) connection is disconnected, the transaction manager MUST perform the actions as specified in section 3.1.8.3.

3.4.5.3.2 CONNTYPE_TXUSER_RESOLVE as Acceptor

For all messages received in this connection type, the transaction manager communicating with an application facet MUST process the message as specified in section 3.1. The transaction manager MUST also follow the processing rules specified in the following sections.

3.4.5.3.2.1 Receiving a TXUSER_RESOLVE_MTAG_CHILD_ABORT Message

When the transaction manager communicating with an application facet receives a TXUSER_RESOLVE_MTAG_CHILD_ABORT message, the transaction manager communicating with an application facet MUST perform the following actions:

- If the connection state is Idle:
 - Set the connection state to Processing Abort Request.
 - Verify if the initiator identity of the connection is authenticated as an administrator, as specified in section 5.1.<33>
 - If the initiator identity is not authorized to perform the requested action
 - Signal the Resolve Transaction Access Denied (section 3.4.7.17) event on the Transaction Manager facet communicating with an Application facet with the following arguments:
 - The current connection object.
 - Otherwise, find the transaction object in the transaction table of the transaction manager by using the **guidTx** field provided in the message as a key.
- If the transaction object is not found:
 - Send a TXUSER_RESOLVE_MTAG_TX_NOT_FOUND message by using the connection.
 - Set the connection state to Ended.
- Otherwise:
 - Add the connection to the transaction connection list.
 - Signal the Resolve Transaction (section 3.2.7.30) event on the Core Transaction Manager Facet with the following arguments:
 - The transaction object
 - The Aborted outcome

- Otherwise, the message MUST be processed as an invalid message as specified in section 3.1.6.

3.4.5.3.2.2 Receiving a TXUSER_RESOLVE_MTAG_CHILD_COMMIT Message

When the transaction manager communicating with an application facet receives a TXUSER_RESOLVE_MTAG_CHILD_COMMIT message, the transaction manager communicating with an application facet MUST perform the following actions:

- If the connection state is Idle:
 - Set the connection state to Processing Commit request.
 - Verify if the initiator identity of the connection is authenticated as an administrator, as specified in section 5.1.<34>
 - If the initiator identity is not authorized to perform the requested action
 - Signal the Resolve Transaction Access Denied (section 3.4.7.17) event on the Transaction Manager facet communicating with an Application facet with the following arguments:
 - The current connection object.
 - Otherwise find the transaction object in the transaction table of the transaction manager by using the **guidTx** field provided in the message as a key.
 - If the transaction object is not found:
 - Send a TXUSER_RESOLVE_MTAG_TX_NOT_FOUND message by using the connection.
 - Set the connection state to Ended.
 - Otherwise:
 - Add the connection to the transaction connection list.
 - Signal the Resolve Transaction event on the Core Transaction Manager Facet with the following arguments:
 - The transaction object
 - The Committed outcome.
- Otherwise, the message MUST be processed as an invalid message as specified in section 3.1.6.

3.4.5.3.2.3 Receiving a TXUSER_RESOLVE_MTAG_FORGET_COMMITTED Message

When the transaction manager communicating with an application facet receives a TXUSER_RESOLVE_MTAG_FORGET_COMMITTED message, the transaction manager communicating with an application facet MUST perform the following actions:

- If the connection state is Idle:
 - Set the connection state to Processing Forget Request.
 - Verify if the initiator identity of the connection is authenticated as an administrator, as specified in section 5.1.<35>
 - If the initiator identity is not authorized to perform the requested action
 - Signal the Resolve Transaction Access Denied (section 3.4.7.17) event on the Transaction Manager facet communicating with an Application facet with the following arguments:

- The current connection object.
- Otherwise, find the transaction object in the transaction table of the transaction manager by using the **guidTx** field provided in the message as a key.
- If the transaction object is not found:
 - Send a TXUSER_RESOLVE_MTAG_TX_NOT_FOUND message by using the connection.
 - Set the connection state to Ended.
- Otherwise:
 - Add the connection to the transaction connection list.
 - Signal the Resolve Transaction (section 3.2.7.30) event on the Core Transaction Manager Facet with the following arguments:
 - The transaction object
 - The Forgotten outcome
- Otherwise, the message MUST be processed as an invalid message as specified in section 3.1.6.

3.4.5.3.2.4 Connection Disconnected

When a CONNTYPE_TXUSER_RESOLVE (section 2.2.8.3.2) connection is disconnected, the transaction manager MUST perform the actions as specified in section 3.1.8.3.

3.4.5.3.3 CONNTYPE_TXUSER_SETTXTIMEOUT as Acceptor

For all messages received in this connection type, the transaction manager MUST process the message as specified in section 3.1. The transaction manager MUST also follow the processing rules specified in the following sections.

3.4.5.3.3.1 Receiving a TXUSER_SETTXTIMEOUT_MTAG_SETTXTIMEOUT Message

When the transaction manager receives a TXUSER_SETTXTIMEOUT_MTAG_SETTXTIMEOUT (section 2.2.8.1.2.7) message, the transaction manager MUST perform the following actions:

- If the connection state is Idle:
 - Set the connection state to Processing Request.
 - Find the transaction object in the transaction table of the transaction manager by using the **guidTx** field from the message as the key.
 - If the transaction object is not found in the list:
 - Send the application a TXUSER_SETTXTIMEOUT_MTAG_TX_NOT_FOUND (section 2.2.8.3.3.1) message.
 - Set the connection state to Ended.
 - Otherwise:
 - Signal the Set Transaction Timeout (section 3.2.7.32) event on the Core Transaction Manager Facet with the following arguments:
 - The transaction object

- The **dwTxTimeout** field from the message
- Otherwise, the message MUST be processed as an invalid message as specified in section 3.1.6.

3.4.5.3.3.2 Connection Disconnected

When a CONNTYPE_TXUSER_SETTXTIMEOUT (section 2.2.8.3.3) connection is disconnected, the transaction manager MUST perform the actions as specified in section 3.1.8.3.

3.4.5.3.4 CONNTYPE_TXUSER_SETTXTIMEOUT2 as Acceptor

For all messages received in this connection type, the transaction manager MUST process the message as specified in section 3.1. The application MUST also follow the processing rules specified in the following sections.

3.4.5.3.4.1 Receiving a TXUSER_SETTXTIMEOUT_MTAG_SETTXTIMEOUT Message

When the transaction manager receives a TXUSER_SETTXTIMEOUT_MTAG_SETTXTIMEOUT (section 2.2.8.1.2.7) message, the transaction manager MUST perform the following actions:

- If the connection state is Idle:
 - Set the connection state to Processing Request.
 - If the transaction manager of the application supports the CONNTYPE_TXUSER_SETTXTIMEOUT2 (section 2.2.8.3.4) connection type as specified in section 2.2.1.1.1:
 - Send a TXUSER_SETTXTIMEOUT_MTAG_TX_NOT_FOUND (section 2.2.8.3.3.1) message.
 - Otherwise, send an MTAG_CONNECTION_REQ_DENIED (section 2.2.5) message with the **Reason** field set to 0x80070057.
 - Set the connection state to Ended.
- Otherwise, the message MUST be processed as specified in section 3.1.6.

3.4.5.3.4.2 Connection Disconnected

When a CONNTYPE_TXUSER_SETTXTIMEOUT (section 2.2.8.3.3) connection is disconnected, the transaction manager MUST perform the actions as specified in section 3.1.8.3.

3.4.5.3.5 CONNTYPE_TXUSER_TRACE as Acceptor

For all messages received in this connection type, the transaction manager communicating with an application facet MUST process the message as specified in section 3.1. The transaction manager communicating with an application facet MUST also follow the processing rules specified in the following sections.

3.4.5.3.5.1 Receiving a TXUSER_TRACE_MTAG_DUMP_TRANSACTION Message

When the transaction manager communicating with an application facet receives a TXUSER_TRACE_MTAG_DUMP_TRANSACTION message, the transaction manager communicating with an application facet MUST perform the following actions:

- If the connection state is Idle:
 - Set the connection state to Processing Trace Request.

- Find the transaction object in the transaction table of the transaction manager by using the **guidTx** field from the message as the key.
 - If the transaction object is not found in the list, the transaction manager MUST:
 - Send a TXUSER_TRACE_MTAG_TX_NOT_FOUND message using the connection.
 - Otherwise:
 - Attempt to generate trace records for the transaction in the trace file of the transaction manager in an implementation-specific manner.
 - If the operation fails:
 - Send a TXUSER_TRACE_MTAG_REQUEST_FAILED message using the connection.
 - Otherwise:
 - Send a TXUSER_TRACE_MTAG_REQUEST_COMPLETE message using the connection.
 - Set the connection state to Ended.
- Otherwise, the message MUST be processed as an invalid message as specified in section 3.1.6.

3.4.5.3.5.2 Connection Disconnected

When a CONNTYPE_TXUSER_TRACE (section 2.2.8.3.5) connection is disconnected, the transaction manager communicating with an application facet MUST perform the actions as specified in section 3.1.8.3.

3.4.5.4 Transaction Manager Administration

3.4.5.4.1 CONNTYPE_TXUSER_GETSECURITYFLAGS as Acceptor

For all messages received in this connection type, the transaction manager communicating with an application facet MUST process the message as specified in section 3.1. The transaction manager communicating with an application facet MUST also follow the processing rules specified in the following sections.

3.4.5.4.1.1 Receiving a TXUSER_GETSECURITYFLAGS_MTAG_GETSECURITYFLAGS Message

When the transaction manager communicating with an application facet receives a TXUSER_GETSECURITYFLAGS_MTAG_GETSECURITYFLAGS message, the transaction manager communicating with an application facet MUST perform the following actions:

- If the connection state is Idle:
 - Set the connection state to Processing Request.
 - Send a TXUSER_GETSECURITYFLAGS_MTAG_FETCHED message using the connection:
 - If the Allow Network Access flag of the Core Transaction Manager Facet is set to false:
 - Set the **grfNetworkDtcAccess** field to zero.
 - Otherwise, set the **grfNetworkDtcAccess** field as follows:
 - Set all bits to zero by default.

- Set the DTCADVCONFIG_NETWORKDTCACCESS_ENABLE bit to 1.
- If the Allow Remote Administration flag of the Core Transaction Manager Facet is set to true:
 - Set the DTCADVCONFIG_NETWORKDTCACCESS_ADMIN bit to 1.
- If the Allow Network Transactions flag of the Core Transaction Manager Facet is set to true:
 - Set the DTCADVCONFIG_NETWORKDTCACCESS_TX bit to 1.
- If the Allow Remote Clients flag of the Core Transaction Manager Facet is set to true:
 - Set the DTCADVCONFIG_NETWORKDTCACCESS_CLIENTS bit to 1.
- If the Allow TIP flag of the Core Transaction Manager Facet is set to true:
 - Set the DTCADVCONFIG_NETWORKDTCACCESS_TIP bit to 1.
- If the Allow Outbound Transactions flag of the Core Transaction Manager Facet is set to true:
 - Set the DTCADVCONFIG_OUTBOUNDNETWORK_TX bit to 1.
- If the Allow Inbound Transactions flag of the Core Transaction Manager Facet is set to true:
 - Set the DTCADVCONFIG_INBOUNDNETWORK_TX bit to 1.
- If the **Security Level** field of the Core Transaction Manager Facet is set to no security:
 - Set the DTCADVCONFIG_SECURITYLEVEL_NOSECURITY bit to 1.
- Otherwise, if the **Security Level** field of the Core Transaction Manager Facet is set to incoming authentication:
 - Set the DTCADVCONFIG_SECURITYLEVEL_AUTHENTICATEDONLY bit to 1.
- Otherwise, if the **Security Level** field of the Core Transaction Manager Facet is set to mutual authentication:
 - Set the DTCADVCONFIG_SECURITYLEVEL_MUTUALAUTH bit to 1.
- If the Allow XA flag of the Core Transaction Manager Facet is set to true, set the **grfXaTransaction** field to 1; otherwise, set the flag to zero.
- If the Allow LUTransactions flag of the Core Transaction Manager Facet is set to true, set the DTCADVCONFIG_OPTIONS_LUTRANSACTIONS_DISABLE option bit in the grOptions field to 0; otherwise, set the option bit to 1.
- Set the connection state to Ended.
- Otherwise, the message MUST be processed as an invalid message as specified in section 3.1.6.

3.4.5.4.1.2 Connection Disconnected

When a CONNTYPE_TXUSER_TRACE (section 2.2.8.3.5) connection is disconnected, the transaction manager communicating with an application facet MUST perform the actions as specified in section 3.1.8.3.

3.4.6 Timer Events

No timer events apply here.

3.4.7 Other Local Events

A transaction manager communicating with an application facet **MUST** be prepared to process the local events that are defined in the following sections.

The transaction manager communicating with an application facet **MUST** be prepared to process local events pertaining to Phase Zero functionality only on versions where the connection type CONNTYPE_TXUSER_PHASE0 is supported. Section 2.2.1.1.3 defines protocol version support for this connection type. The following local events are affected:

- Register Phase Zero (section 3.4.7.15)
- Phase Zero Complete (section 3.4.7.14)

3.4.7.1 Associate Transaction Failure

The Associate Transaction Failure event **MUST** be signaled with the following arguments:

- A transaction object.
- A value indicating the failure reason. The reason **MUST** be set to one of the following values:
 - Comm Failed
 - Log Full Remote
 - Log Full Local
 - No Mem Remote
 - Too Late
 - Too Many Remote
 - Too Many Local
 - Tx Not Found

If the Associate Transaction Failure event is signaled, the transaction manager **MUST** perform the following actions:

- Find an instance of a CONNTYPE_TXUSER_ASSOCIATE (section 2.2.8.2.1.1) connection list in the associates table of the transaction manager communicating with an application facet by using the **Transaction Object.Identifier** field of the transaction object as the key.
- For each connection in the list:
 - Remove the connection from the list.
 - If the connection state is Processing Associate Request:
 - Send the matching message for the following reason codes:
 - Comm Failed: TXUSER_ASSOCIATE_MTAG_COMM_FAILED (section 2.2.8.2.1.1.3)
 - Log Full Remote: TXUSER_ASSOCIATE_MTAG_LOG_FULL_REMOTE (section 2.2.8.2.1.1.6)

- Log Full Local: TXUSER_ASSOCIATE_MTAG_LOG_FULL_LOCAL (section 2.2.8.2.1.1.5)
 - No Mem Remote:
TXUSER_ASSOCIATE_MTAG_NO_MEM_REMOTE (section 2.2.8.2.1.1.8)
 - Too Late:TXUSER_ASSOCIATE_MTAG_TOO_LATE (section 2.2.8.2.1.1.9)
 - Too Many Remote:
TXUSER_ASSOCIATE_MTAG_TOO_MANY_REMOTE (section 2.2.8.2.1.1.11)
 - Too Many Local:
TXUSER_ASSOCIATE_MTAG_TOO_MANY_LOCAL (section 2.2.8.2.1.1.10)
 - Tx Not Found: TXUSER_ASSOCIATE_MTAG_TX_NOT_FOUND (section 2.2.8.2.1.1.12)
- Set the connection state to Ended.
- Remove the list from the associates table of the transaction manager communicating with an application facet.

3.4.7.2 Associate Transaction Success

The Associate Transaction Success event MUST be signaled with the following arguments:

- A transaction object.

If the Associate Transaction Success event is signaled, the transaction manager MUST perform the following actions:

- Find the list of CONNTYPE_TXUSER_ASSOCIATE (section 2.2.8.2.1.1) connections in the associates table of the transaction manager communicating with an application facet by using the **Transaction Object.Identifier** field of the transaction object as the key.
- For each connection in the list:
 - Remove the connection from the list.
 - If the connection state is Processing Associate Request:
 - Send a TXUSER_ASSOCIATE_MTAG_ASSOCIATED (section 2.2.8.2.1.1.2) message using the connection.
 - Set the connection state to Active.
- Remove the list from the associates table of the transaction manager communicating with an application facet.

3.4.7.3 Begin Commit

The Begin Commit event MUST be signaled with the following arguments:

- An Enlistment object

If the Begin Commit event is signaled, the transaction manager MUST perform the following actions:

- If the enlistment connection is of type CONNTYPE_TXUSER_IMPORT (section 2.2.8.2.2.4):
 - Set the connection state to Ended.

- Otherwise, if the enlistment connection is of type CONNTYPE_TXUSER_IMPORT2 (section 2.2.8.2.2.5) or CONNTYPE_TXUSER_ASSOCIATE (section 2.2.8.2.1.1):
 - Send a TXUSER_IMPORT2_MTAG_SINK_ERROR (section 2.2.8.2.2.5.4) message:
 - The **Error** field MUST be set to TRUN_TXIMPORT_ERROR_NOTIFY_COMMITTED.
 - Set the connection state to Ended.

3.4.7.4 Begin In Doubt

The Begin In Doubt event MUST be signaled with the following arguments:

- An Enlistment object.

If the Begin In Doubt event is signaled, the transaction manager MUST perform the following actions:

- If the enlistment connection is of type CONNTYPE_TXUSER_IMPORT (section 2.2.8.2.2.4):
 - Set the connection state to Ended.
- Otherwise, if the enlistment connection is of type CONNTYPE_TXUSER_IMPORT2 (section 2.2.8.2.2.5) or CONNTYPE_TXUSER_ASSOCIATE (section 2.2.8.2.1.1):
 - Send a TXUSER_IMPORT2_MTAG_SINK_ERROR (section 2.2.8.2.2.5.4) message:
 - The **Error** field MUST be set to TRUN_TXIMPORT_ERROR_NOTIFY_INDOUBT.
 - Set the connection state to Ended.

3.4.7.5 Begin Rollback

The Begin Rollback event MUST be signaled with the following arguments:

- An Enlistment object.

If the Begin Rollback event is signaled, the transaction manager MUST perform the following actions:

- If the enlistment's connection is of type CONNTYPE_TXUSER_IMPORT (section 2.2.8.2.2.4):
 - Set the connection state to Ended.
- Otherwise, if the enlistment's connection is of type CONNTYPE_TXUSER_IMPORT2 (section 2.2.8.2.2.5) or CONNTYPE_TXUSER_ASSOCIATE (section 2.2.8.2.1.1):
 - If the connection state is Active or Too Late to Abort:
 - Send a TXUSER_IMPORT2_MTAG_SINK_ERROR (section 2.2.8.2.2.5.4) message:
 - The **Error** field MUST be set to TRUN_TXIMPORT_ERROR_NOTIFY_ABORTED.
 - Set the connection state to Ended.

3.4.7.6 Begin Voting

The Begin Voting event MUST be signaled with the following arguments:

- An Enlistment object

If the Begin Voting event is signaled, the transaction manager MUST perform the following actions:

- If the enlistment's connection is of type CONNTYPE_TXUSER_IMPORT, CONNTYPE_TXUSER_IMPORT2 or CONNTYPE_TXUSER_ASSOCIATE:
 - Signal the Enlistment Vote Complete event on the Core Transaction Manager Facet with the following arguments:
 - The provided Enlistment object
 - The Prepared vote outcome
 - If the enlistment's connection type is CONNTYPE_TXUSER_IMPORT or CONNTYPE_TXUSER_IMPORT2:
 - Set the connection state to Too Late to Abort.

3.4.7.7 Create Transaction Failure

The Create Transaction Failure event MUST be signaled with the following arguments:

- A transaction object.
- A value indicating the failure reason. The reason MUST be set to one of the following values:
 - Log Full
 - No Mem
 - Duplicate

If the Create Transaction Failure event is signaled, the transaction manager MUST perform the following actions:

- If the transaction's connection list contains a connection of type CONNTYPE_TXUSER_BEGINNER (section 2.2.8.1.1):
 - Send the matching message for the following reason codes:
 - Log Full: TXUSER_BEGINNER_MTAG_BEGIN_LOG_FULL (section 2.2.8.1.1.3)
 - No Mem: TXUSER_BEGINNER_MTAG_BEGIN_NO_MEM (section 2.2.8.1.1.4)
 - Set the connection state to Ended.
- Otherwise, if the transaction's connection list contains a connection of type CONNTYPE_TXUSER_BEGIN2 (section 2.2.8.1.2) or CONNTYPE_TXUSER_PROMOTE (section 2.2.8.1.3):
 - Send a TXUSER_BEGIN2_MTAG_SINK_ERROR (section 2.2.8.1.2.5) message:
 - The Error field MUST be set to the value matching the following reason codes:
 - Log Full: TRUN_TXBEGIN_ERROR_BEGIN_LOG_FULL
 - No Mem: TRUN_TXBEGIN_ERROR_NO_MEM
 - Duplicate: TRUN_TXBEGIN_ERROR_DUPLICATE_GUID
 - Set the connection state to Ended.

3.4.7.8 Create Transaction Success

The Create Transaction Success event MUST be signaled with the following arguments:

- A transaction object

If the Create Transaction Success event is signaled, the transaction manager MUST perform the following actions:

- If the transaction's connection list contains a connection of type CONNTYPE_TXUSER_BEGINNER (section 2.2.8.1.1)
 - Send a TXUSER_BEGINNER_MTAG_BEGUN (section 2.2.8.1.1.5) message.
 - The **guidTx** field MUST be set to the **Transaction Object.Identifier** field of the transaction object.
 - Set the connection state to Active.
- Otherwise, if the transaction's connection list contains a connection of type CONNTYPE_TXUSER_BEGIN2 (section 2.2.8.1.2) or CONNTYPE_TXUSER_PROMOTE (section 2.2.8.1.3):
 - Send a TXUSER_BEGIN2_MTAG_SINK_BEGUN (section 2.2.8.1.2.4) message:
 - The **guidTx** field MUST be set to the **Transaction Object.Identifier** field of the transaction object.
 - Set the connection state to Active.

3.4.7.9 Create Voter Enlistment Failure

The Create Voter Enlistment Failure event MUST be signaled with the following arguments:

- An Enlistment object.
- A value indicating the failure reason. The reason MUST be set to the following value:
 - Too Late

If the Create Voter Enlistment Failure event is signaled, the Transaction Manager MUST perform the following actions:

- If the provided enlistment's connection is of type CONNTYPE_TXUSER_IMPORT2 (section 2.2.8.2.2.5):
 - Send a TXUSER_IMPORT2_MTAG_SINK_ERROR (section 2.2.8.2.2.5.4) message using the provided enlistment's connection:
 - The **Error** field MUST be set to:
 - TRUN_TXIMPORT_ERROR_IMPORT_TX_NOT_FOUND.
 - Set the connection state to Ended.
- Otherwise, if the provided enlistment's connection is of type CONNTYPE_TXUSER_IMPORT (section 2.2.8.2.2.4):
 - Send a TXUSER_IMPORT_MTAG_IMPORT_TX_NOT_FOUND message using the provided enlistment's connection.

- Set the connection state to Ended.

3.4.7.10 Create Voter Enlistment Success

The Create Voter Enlistment Success event MUST be signaled with the following arguments:

- An Enlistment object

If the Create Voter Enlistment Success event is signaled, the Transaction Manager MUST perform the following actions:

- If the provided enlistment's connection is of type CONNTYPE_TXUSER_IMPORT2 (section 2.2.8.2.2.5):
 - Send the TXUSER_IMPORT2_MTAG_SINK_IMPORTED (section 2.2.8.2.2.5.5) message using the provided enlistment's connection.
 - The **isoLevel** field MUST be set to the **Isolation Level** field of the transaction object referenced by the provided Enlistment object.
 - The **isoFlags** field MUST be set to the **Isolation Flags** field of the transaction object referenced by the provided Enlistment object.
- Otherwise, if the provided enlistment's connection is of type CONNTYPE_TXUSER_IMPORT (section 2.2.8.2.2.4):
 - Send the TXUSER_IMPORT_MTAG_IMPORTED (section 2.2.8.2.2.4.5) message using the provided enlistment's connection:
 - The **isoLevel** field MUST be set to the **Isolation Level** field of the transaction object referenced by the provided Enlistment object.
 - The **isoFlags** field MUST be set to the **Isolation Flags** field of the transaction object referenced by the provided Enlistment object.
- Set the connection state to Active.

3.4.7.11 Export Transaction Failure

The Export Transaction Failure event MUST be signaled with the following arguments:

- A transaction object.
- A value indicating the failure reason. The reason MUST be set to one of the following values:
 - Log Full
 - No Mem
 - Too Late
 - Too Many
 - Comm Failed

If the Export Transaction Failure event is signaled, the transaction manager MUST perform the following actions:

- Find an instance of a CONNTYPE_TXUSER_EXPORT2 (section 2.2.8.2.2.3) connection in the provided transaction's connection list.

- Send the matching message for the following reason codes:
 - Log Full: TXUSER_EXPORT_MTAG_EXPORT_LOG_FULL (section 2.2.8.2.2.2.7)
 - No Mem: TXUSER_EXPORT_MTAG_EXPORT_NO_MEM (section 2.2.8.2.2.2.8)
 - Too Late: TXUSER_EXPORT_MTAG_EXPORT_TOO_LATE (section 2.2.8.2.2.2.9)
 - Too Many: TXUSER_EXPORT_MTAG_EXPORT_TOO_MANY (section 2.2.8.2.2.2.10)
 - Not Found: TXUSER_EXPORT_MTAG_EXPORT_TX_NOT_FOUND (section 2.2.8.2.2.2.11)
 - Comm Failed: TXUSER_EXPORT_MTAG_EXPORT_COMM_FAILED (section 2.2.8.2.2.3.1)
- Set the connection state to Ended.
- Otherwise, find an instance of a CONNTYPE_TXUSER_EXPORT (section 2.2.8.2.2.2) connection in the provided transaction's connection list.
 - Send the matching message for the following reason codes:
 - Log Full: TXUSER_EXPORT_MTAG_EXPORT_LOG_FULL (section 2.2.8.2.2.2.7)
 - No Mem: TXUSER_EXPORT_MTAG_EXPORT_NO_MEM (section 2.2.8.2.2.2.8)
 - Too Late: TXUSER_EXPORT_MTAG_EXPORT_TOO_LATE (section 2.2.8.2.2.2.9)
 - Too Many: TXUSER_EXPORT_MTAG_EXPORT_TOO_MANY (section 2.2.8.2.2.2.10)
 - Not Found: TXUSER_EXPORT_MTAG_EXPORT_TX_NOT_FOUND (section 2.2.8.2.2.2.11)
- Otherwise, if no such connection exists, the event MUST be ignored.

3.4.7.12 Export Transaction Success

The Export Transaction Success event MUST be signaled with the following arguments:

- A transaction object

If the Export Transaction Success event is signaled, the transaction manager MUST perform the following actions:

- Find an instance of a CONNTYPE_TXUSER_EXPORT2 (section 2.2.8.2.2.3) connection in the provided transaction's connection list.
 - Send a TXUSER_EXPORT_MTAG_EXPORTED (section 2.2.8.2.2.2.12) message using the connection.
 - Set the connection state to Connection Active (section 3.4.1.9.3).
- Otherwise, find an instance of a CONNTYPE_TXUSER_EXPORT (section 2.2.8.2.2.2) connection in the provided transaction's connection list.
 - Send a TXUSER_EXPORT_MTAG_EXPORTED (section 2.2.8.2.2.2.12) message using the connection.
 - Set the connection state to Connection Active (section 3.4.1.8.3).
- Otherwise, if no such connection exists, the event MUST be ignored.

3.4.7.13 Phase One Complete

The Phase One Complete event MUST be signaled with the following arguments:

- An Enlistment object.
- A value indicating the outcome of Phase One. The value MUST be set to one of the following values:
 - Read Only
 - Committed
 - Aborted
 - In Doubt

If the Phase One Complete event is signaled, the Transaction Manager Communicating with an Application Facet MUST perform the following actions:

- If the provided outcome is Read Only or Committed:
 - If the transaction's connection list contains a connection of type CONNTYPE_TXUSER_BEGINNER (section 2.2.8.1.1):
 - Send a TXUSER_BEGINNER_MTAG_REQUEST_COMPLETED (section 2.2.8.1.1.9) message.
 - Set the connection state to Ended.
 - Otherwise, if the transaction's connection list contains a connection of type CONNTYPE_TXUSER_BEGIN2 (section 2.2.8.1.2) or CONNTYPE_TXUSER_PROMOTE (section 2.2.8.1.3):
 - Send a TXUSER_BEGIN2_MTAG_SINK_ERROR (section 2.2.8.1.2.5) message:
 - The Error field MUST be set to TRUN_TXBEGIN_ERROR_NOTIFY_COMMITTED.
 - Set the connection state to Ended.
- Otherwise, if the provided outcome is Aborted:
 - If the transaction's connection list contains a connection of type CONNTYPE_TXUSER_BEGINNER (section 2.2.8.1.1):
 - If the connection state is Active:
 - Set the connection state to Aborting Transaction.
 - Otherwise, if the connection state is Aborting Transaction or Committing Transaction:
 - Send a TXUSER_BEGINNER_MTAG_REQUEST_COMPLETED (section 2.2.8.1.1.9) message.
 - Set the connection state to Ended.
 - Otherwise, ignore the event.
 - Otherwise, if the transaction's connection list contains a connection of type CONNTYPE_TXUSER_BEGIN2 (section 2.2.8.1.2) or CONNTYPE_TXUSER_PROMOTE (section 2.2.8.1.3):
 - Send a TXUSER_BEGIN2_MTAG_SINK_ERROR (section 2.2.8.1.2.5) message:

- The Error field MUST be set to TRUN_TXBEGIN_ERROR_NOTIFY_ABORTED.
 - Set the connection state to Ended.
- Otherwise, if the provided outcome is In Doubt:
 - If the transaction's connection list contains a CONNTYPE_TXUSER_BEGINNER (section 2.2.8.1.1) connection:
 - Send a TXUSER_BEGINNER_MTAG_COMMIT_INDOUBT (section 2.2.8.1.1.7) message.
 - Set the connection state to Ended.
 - Otherwise, if the transaction's connection list contains a CONNTYPE_TXUSER_BEGIN2 (section 2.2.8.1.2) connection:
 - Send a TXUSER_BEGIN2_MTAG_SINK_ERROR (section 2.2.8.1.2.5) message:
 - The Error field MUST be set to TRUN_TXBEGIN_ERROR_NOTIFY_INDOUBT.
 - Set the connection state to Ended.

3.4.7.14 Phase Zero Complete

The Phase Zero Complete event MUST be signaled with the following arguments:

- An Enlistment object.
- A value indicating the outcome of Phase Zero. The value MUST be set to one of the following values:
 - Success
 - Failure

If the Phase Zero Complete event is signaled, the transaction manager MUST perform the following actions:

- If the provided outcome is Success:
 - Signal the Begin Phase One event on the Core Transaction Manager Facet with the following arguments:
 - The transaction referenced by the provided Enlistment object.
 - The Single Phase Commit flag set to true.

Otherwise:

- Signal the Phase One Complete event on the Transaction Manager Communicating with an Application Facet with the following arguments:
 - The provided Enlistment object
 - The Aborted outcome

3.4.7.15 Register Phase Zero

The Register Phase Zero event MUST be signaled with the following arguments:

- An Enlistment object.

If the Register Phase Zero event is signaled, the transaction manager MUST perform the following actions:

- Signal the Register Phase Zero Success event on the Core Transaction Manager Facet with the following arguments:
 - The provided Enlistment object

3.4.7.16 Resolve Transaction Complete

The Resolve Transaction Complete event MUST be signaled with the following arguments:

- A transaction object.
- A value indicating the result of the resolve transaction operation. The value MUST be set to one of the following values:
 - Committed
 - Aborted
 - Forgotten
 - Not Prepared
 - Not Committed

If the Resolve Transaction Complete event is signaled, the transaction manager MUST perform the following actions:

- Find a CONNTYPE_TXUSER_RESOLVE (section 2.2.8.3.2) connection in the transaction's connection list.
- If the connection is not found, ignore the event.
- Otherwise:
 - If the resolve outcome is Committed, Aborted, or Forgotten:
 - Send a TXUSER_RESOLVE_MTAG_REQUEST_COMPLETE (section 2.2.8.3.2.7) message using the connection.
 - Set the connection state to Ended.
 - Otherwise, if the resolve outcome is Not Prepared:
 - Send a TXUSER_RESOLVE_MTAG_CHILD_NOT_PREPARED (section 2.2.8.3.2.4) message using the connection.
 - Set the connection state to Ended.
 - Otherwise, if the resolve outcome is Not Committed:
 - Send a TXUSER_RESOLVE_MTAG_FORGET_TX_NOT_COMMITTED (section 2.2.8.3.2.6) message using the connection.
 - Set the connection state to Ended.

3.4.7.17 Resolve Transaction Access Denied

The Resolve Transaction Access Denied event MUST be signaled with the following arguments:

- A connection object.

If the Resolve Transaction Access Denied event is signaled, the transaction manager MUST perform the following actions:

- If the connection object is of CONNTYPE_TXUSER_RESOLVE (section 2.2.8.3.2) connection type:
 - Send a TXUSER_RESOLVE_MTAG_ACCESSDENIED (section 2.2.8.3.2.1) message.
 - Set the connection state to Ended.
- Otherwise:
 - Ignore the signal.

3.4.7.18 Rollback Complete

The Rollback Complete event MUST be signaled with the following arguments:

- An Enlistment object

If the Rollback Complete event is signaled, the transaction manager MUST perform the following actions:

- If the connection referenced by the enlistment is of type CONNTYPE_TXUSER_BEGINNER (section 2.2.8.1.1):
 - If the connection state is Aborting Transaction:
 - Send a TXUSER_BEGINNER_MTAG_REQUEST_COMPLETED (section 2.2.8.1.1.9) message.
 - Set the connection state to Ended.
- If the connection referenced by the enlistment is of type CONNTYPE_TXUSER_BEGIN2 (section 2.2.8.1.2) or CONNTYPE_TXUSER_PROMOTE (section 2.2.8.1.3):
 - If the connection state is Modifying Timeout:
 - Send a TXUSER_SETTXTIMEOUT_MTAG_TOO_LATE (section 2.2.8.1.2.8) message.
 - Otherwise, if the connection state is Active, Aborting Transaction, or Committing Transaction:
 - Send a TXUSER_BEGIN2_MTAG_SINK_ERROR (section 2.2.8.1.2.5) message.
 - The Error field MUST be set to TRUN_TXBEGIN_ERROR_NOTIFY_ABORTED.
 - Set the connection state to Ended.

3.4.7.19 Set Transaction Attributes Failure

The Set Transaction Attributes Failure event MUST be signaled with the following arguments:

- A transaction object

If the Set Transaction Attributes Failure event is signaled, the transaction manager MUST perform the following actions:

- Find a CONNTYPE_TXUSER_IMPORT2 connection instance in the provided transaction's connection list.

- If the connection is not found, ignore the event.
- Otherwise:
 - Send a TXUSER_IMPORT2_MTAG_SINK_ERROR message using the connection:
 - The Error field MUST be set to TRUN_TXIMPORT_ERROR_IMPORT_TX_NOT_FOUND.
 - Set the connection state to Ended.

3.4.7.20 Set Transaction Attributes Success

The Set Transaction Attributes Success event MUST be signaled with the following arguments:

- A transaction object

If the Set Transaction Attributes Success event is signaled, the transaction manager MUST perform the following actions:

- Find a CONNTYPE_TXUSER_IMPORT2 (section 2.2.8.2.2.5) connection instance in the provided transaction's connection list.
- If the connection is not found, ignore the signal.
- Otherwise:
 - Create a new Enlistment object using the following fields:
 - The Transaction Manager Communicating with an Application Facet
 - The provided transaction object
 - The connection object
 - Assign the new Enlistment object to the connection's Enlistment field.
 - Signal the Create Voter Enlistment (section 3.2.7.14) event on the Core Transaction Manager Facet (section 1.3.3.3.1) with the new Enlistment object.

3.4.7.21 Set Transaction Timeout Failure

The Set Transaction Timeout Failure event MUST be signaled with the following arguments:

- A transaction object

If the Set Transaction Timeout Failure event is signaled, the transaction manager MUST perform the following actions:

- If the transaction's connection list contains a connection of type CONNTYPE_TXUSER_BEGIN2 (section 2.2.8.1.2) or CONNTYPE_TXUSER_PROMOTE (section 2.2.8.1.3):
 - Send a TXUSER_SETTXTIMEOUT_MTAG_TOO_LATE (section 2.2.8.1.2.8) message using the connection.
 - Set the connection state to Active.
- Otherwise, if the transaction's connection list contains a CONNTYPE_TXUSER_SETTXTIMEOUT (section 2.2.8.3.3) connection:

- Send a TXUSER_SETTXTIMEOUT_MTAG_TOO_LATE (section 2.2.8.1.2.8) message using the connection.
- Set the connection state to Ended.

3.4.7.22 Set Transaction Timeout Success

The Set Transaction Timeout Success event MUST be signaled with the following arguments:

- A transaction object

If the Set Transaction Timeout Success event is signaled, the transaction manager MUST perform the following actions:

- If the transaction's connection list contains a connection of type CONNTYPE_TXUSER_BEGIN2 (section 2.2.8.1.2) or CONNTYPE_TXUSER_PROMOTE (section 2.2.8.1.3):
 - Send a TXUSER_SETTXTIMEOUT_MTAG_REQUEST_COMPLETE (section 2.2.8.1.2.6) message using the connection.
 - Set the connection state to Active.
- Otherwise, if the transaction's connection list contains a CONNTYPE_TXUSER_SETTXTIMEOUT (section 2.2.8.3.3) connection:
 - Send a TXUSER_SETTXTIMEOUT_MTAG_REQUEST_COMPLETE (section 2.2.8.1.2.6) message using the connection.
 - Set the connection state to Ended.

3.4.7.23 Unilaterally Aborted

The Unilaterally Aborted event MUST be signaled with the following arguments:

- An Enlistment object

If the Unilaterally Aborted event is signaled, the transaction manager MUST perform the following actions:

- If the enlistment's connection is of type CONNTYPE_TXUSER_BEGINNER (section 2.2.8.1.1):
 - If the connection state is Active.
 - Set the connection state to Aborting Transaction.
- Otherwise, if the enlistment's connection is of type CONNTYPE_TXUSER_BEGIN2 (section 2.2.8.1.2) or CONNTYPE_TXUSER_PROMOTE (section 2.2.8.1.3):
 - Send a TXUSER_BEGIN2_MTAG_SINK_ERROR (section 2.2.8.1.2.5) message:
 - The Error field MUST be set to TRUN_TXBEGIN_ERROR_NOTIFY_ABORTED.
 - Set the connection state to Ended.

3.5 Resource Manager Details

3.5.1 Abstract Data Model

This section describes a conceptual model of possible data organization that an implementation maintains to participate in this protocol. The described organization is provided to facilitate the explanation of how the protocol behaves. This document does not mandate that implementations adhere to this model as long as their external behavior is consistent with the behavior that is described in this document.

Note that the abstract data model can be implemented in a variety of ways. This protocol does not prescribe or advocate any specific implementation technique.

A resource manager **MUST** maintain all the data elements as specified in section 3.1.1.

A resource manager **MUST** also maintain the following data elements:

- **Resource Manager.Identifier**: A durable GUID that specifies the resource manager identifier.
- **Session identifier**: A volatile GUID that specifies the resource manager session identifier.
- **Resource Manager.Durable Log**: A durable list of transaction objects. The contents of the log **MUST** persist across software restarts and transient failures.
- **Reenlistment list**: A list of connection objects.
- **Transaction manager name**: A Name object that identifies the transaction manager.
- **Reenlistment timeout**: A value that indicates the number of milliseconds the resource manager will wait for an outcome while reenlisting on a transaction.
- **Resource Manager.Connection**: A connection object that **MUST** be of type `CONNTYPE_TXUSER_RESOURCEMANAGERINTERNAL` (section 2.2.10.1.2) or `CONNTYPE_TXUSER_RESOURCEMANAGER` (section 2.2.10.1.1).

When a transaction object is stored in the **Resource Manager.Durable Log** of the resource manager, the resource manager **MUST** record, at minimum, the following fields:

- The **Resource Manager.Identifier** field
- The **Transaction Object.Identifier** field of the transaction object

A resource manager **MUST** provide the states that are defined in the following sections for its supported connection types. Section 2.2.1.1.3 defines the connection types that a resource manager **MUST** provide for each supported protocol version.

For a resource manager initiating a connection, once the connection's state machine enters the Ended state, the connection that is associated with the state machine **MUST** be disconnected, if it is not already disconnected, as specified in [MS-CMP] section 3.1.5.1. In addition, if both the Outgoing Connection Table and the Incoming Connection Table of the Session object containing the connection object referenced by **Resource Manager.Connection** are empty, the following event on the resource manager is signaled:

- Transaction Manager Down (section 3.5.7.4)

3.5.1.1 CONNTYPE_TXUSER_RESOURCEMANAGER Initiator States

The resource manager **MUST** act as an initiator for the `CONNTYPE_TXUSER_RESOURCEMANAGER` (section 2.2.10.1.1) connection type. In this role, the resource manager **MUST** provide support for the following states:

- Idle
- Awaiting Create Response
- Recovering
- Awaiting Completion Confirmation
- Active
- Ended

The following figure shows the relationship between the CONNTYPE_TXUSER_RESOURCEMANAGER (section 2.2.10.1.1) initiator states.

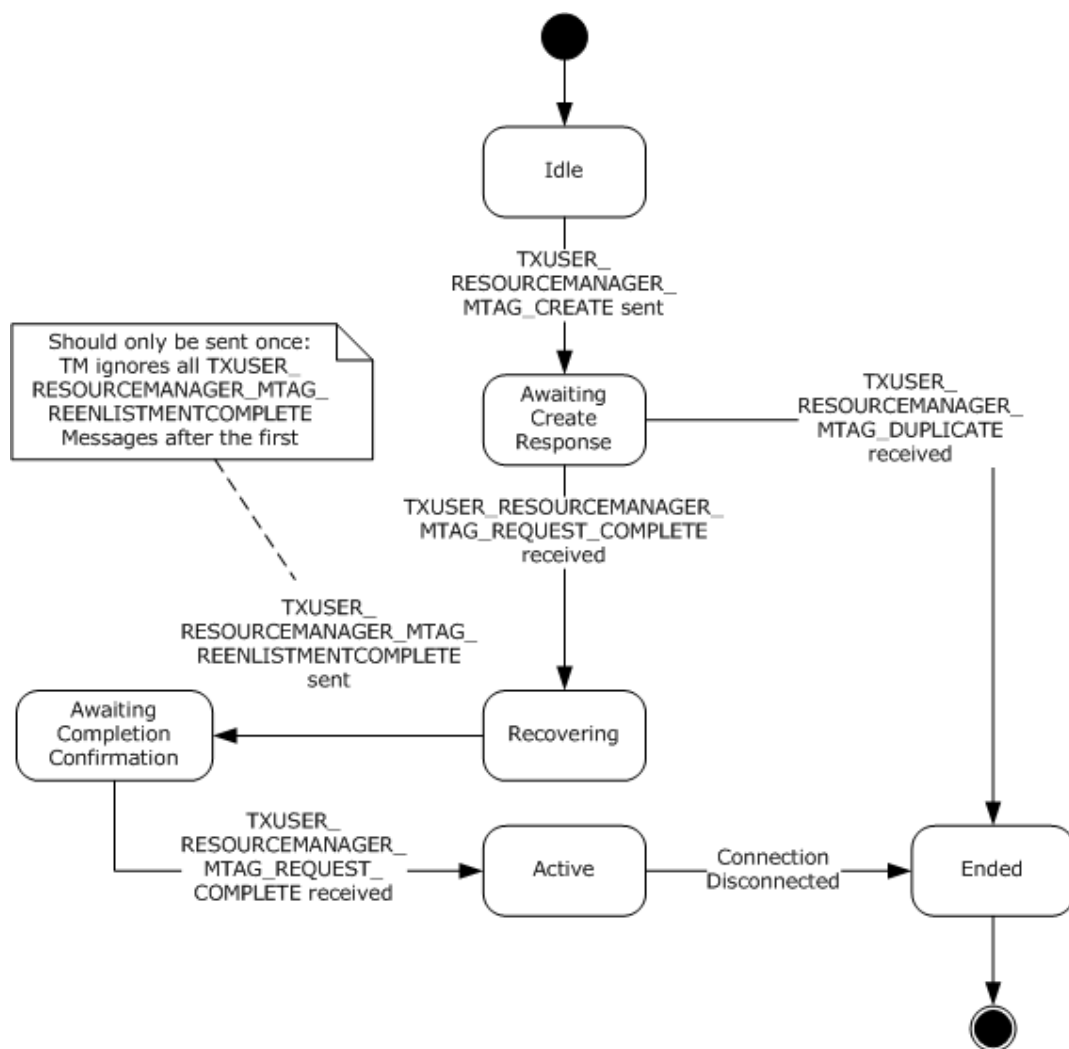

Figure 44: Resource Manager state diagram for CONNTYPE_TXUSER_RESOURCEMANAGER

3.5.1.1.1 Idle

This is the initial state. The following event is processed in this state:

- Registering with Transaction Manager Using CONNTYPE_TXUSER_RESOURCEMANAGER (section 3.5.4.10.1)

3.5.1.1.2 Awaiting Create Response

The following events are processed in this state:

- Receiving a TXUSER_RESOURCEMANAGER_MTAG_REQUEST_COMPLETE Message (section 3.5.5.1.1.2)
- Receiving a TXUSER_RESOURCEMANAGER_MTAG_DUPLICATE Message (section 3.5.5.1.1.1)

3.5.1.1.3 Recovering

The following event is processed in this state:

- Reenlistment Complete (section 3.5.7.3)

3.5.1.1.4 Awaiting Completion Confirmation

The following event is processed in this state:

- Receiving a TXUSER_RESOURCEMANAGER_MTAG_REQUEST_COMPLETE Message (section 3.5.5.1.1.2)

3.5.1.1.5 Active

No specific events are processed in this state.

3.5.1.1.6 Ended

This is the final state.

3.5.1.2 CONNTYPE_TXUSER_RESOURCEMANAGERINTERNAL Initiator States

The resource manager MUST act as an initiator for the CONNTYPE_TXUSER_RESOURCEMANAGERINTERNAL (section 2.2.10.1.2) connection type. In this role, the resource manager MUST provide support for the following states:

- Idle
- Awaiting Create Response
- Recovering
- Awaiting Completion Confirmation
- Active
- Ended

The following figure shows the relationship between the CONNTYPE_TXUSER_RESOURCEMANAGERINTERNAL initiator states.

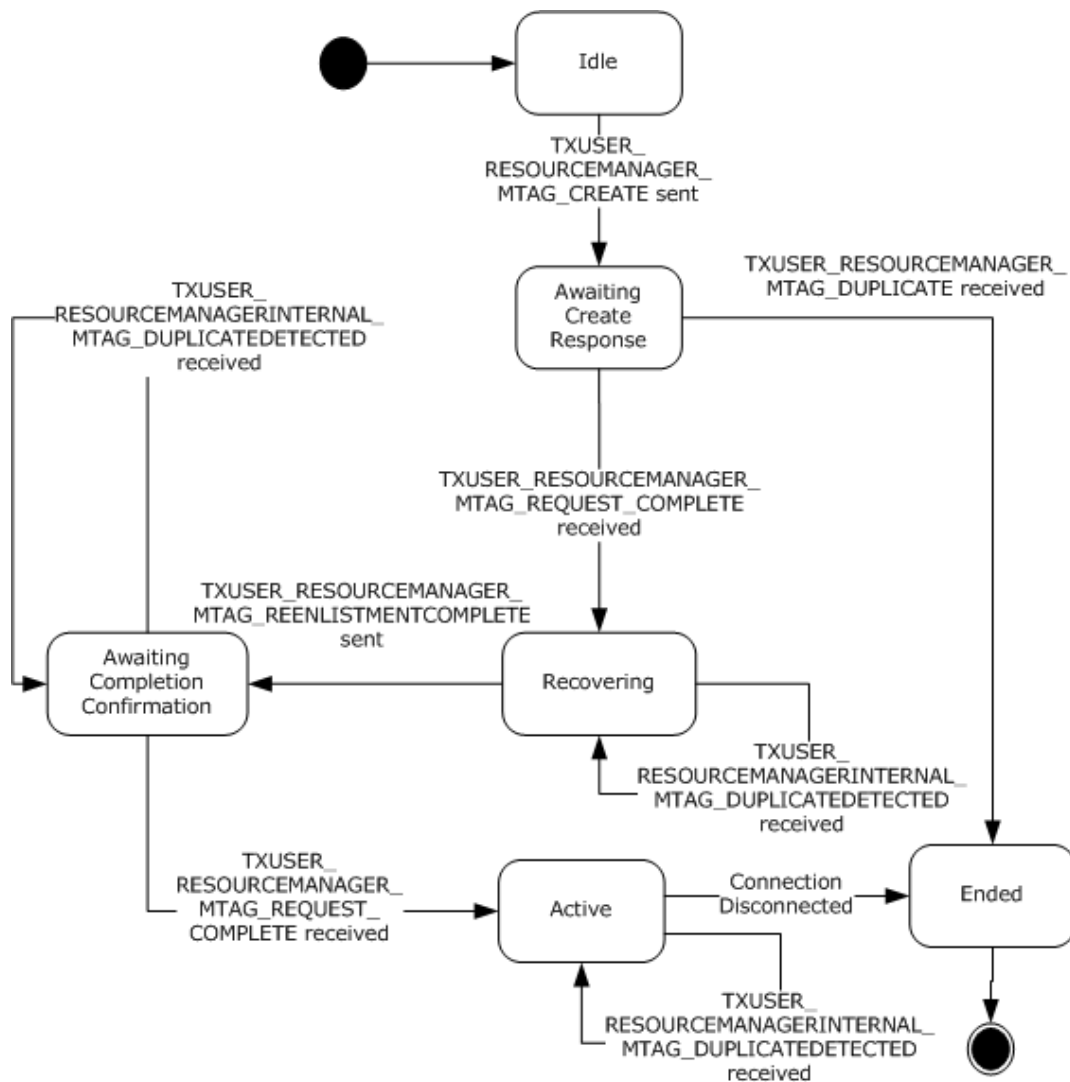

Figure 45: CONNTYPE_TXUSER_RESOURCEMANAGERINTERNAL initiator states

3.5.1.2.1 Idle

This is the initial state. The following event is processed in this state:

- Registering with Transaction Manager Using CONNTYPE_TXUSER_RESOURCEMANAGERINTERNAL (section 3.5.4.10.2)

3.5.1.2.2 Awaiting Create Response

The following events are processed in this state:

- Receiving a TXUSER_RESOURCEMANAGER_MTAG_DUPLICATE or TXUSER_RESOURCEMANAGER_MTAG_REQUEST_COMPLETE Message (section 3.5.5.1.2.1)

3.5.1.2.3 Recovering

The following events are processed in this state:

- Reenlistment Complete (section 3.5.7.3)
- Receiving a TXUSER_RESOURCEMANAGERINTERNAL_MTAG_DUPLICATEDETECTED Message (section 3.5.5.1.2.2)

3.5.1.2.4 Awaiting Completion Confirmation

The following events are processed in this state:

- Receiving a TXUSER_RESOURCEMANAGER_MTAG_DUPLICATE or TXUSER_RESOURCEMANAGER_MTAG_REQUEST_COMPLETE Message (section 3.5.5.1.2.1)

3.5.1.2.5 Active

The following event is processed in this state:

- Receiving a TXUSER_RESOURCEMANAGERINTERNAL_MTAG_DUPLICATEDETECTED Message (section 3.5.5.1.2.2)

3.5.1.2.6 Ended

This is the final state.

3.5.1.3 CONNTYPE_TXUSER_PHASE0 Initiator States

The resource manager MUST act as an initiator for the CONNTYPE_TXUSER_PHASE0 (section 2.2.10.2.1) connection type. In this role, the resource manager MUST provide support for the following states:

- Idle
- Awaiting Create Response
- Active
- Processing Phase Zero Request
- Ended

The following figure shows the relationship between the CONNTYPE_TXUSER_PHASE0 initiator states.

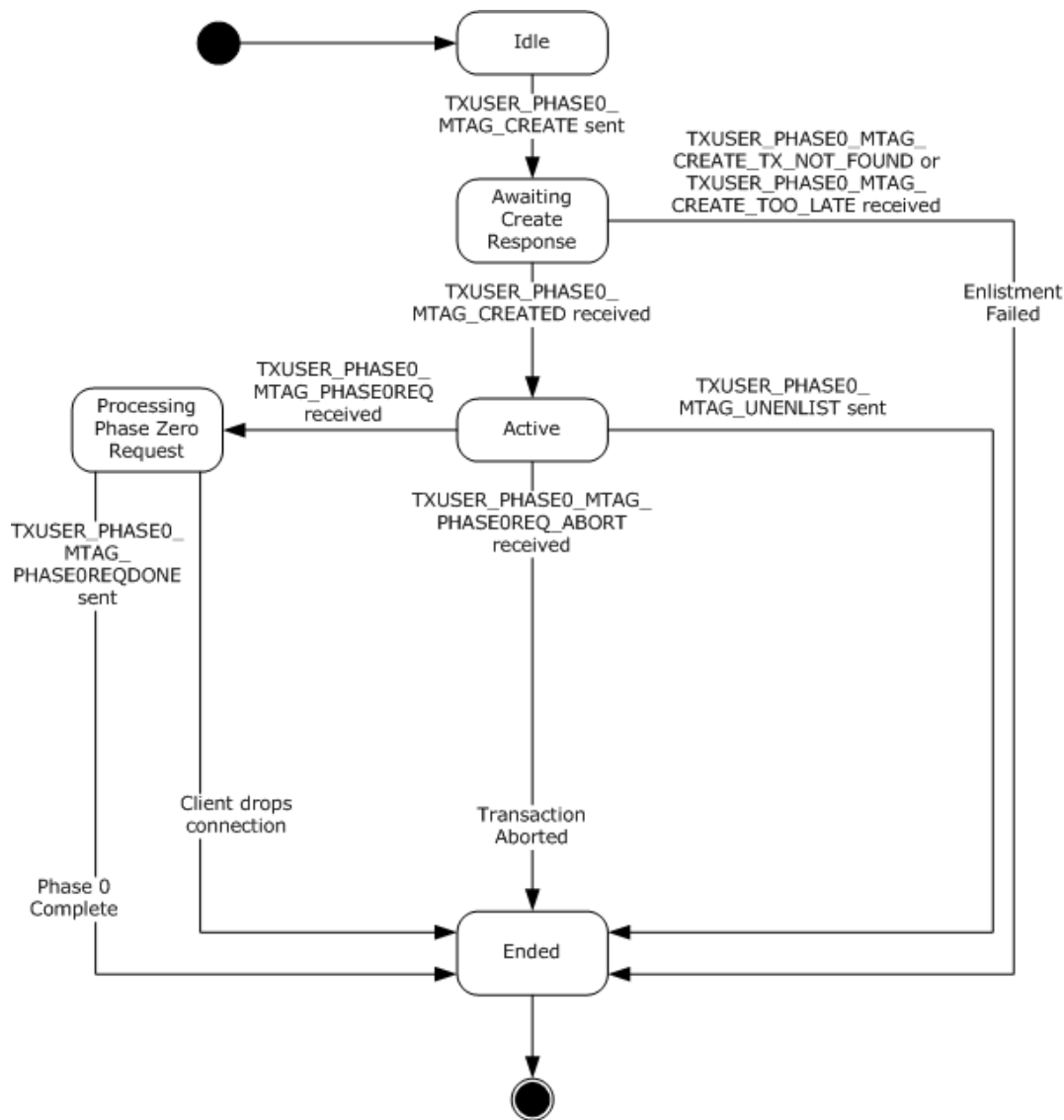

Figure 46: CONNTYPE_TXUSER_PHASE0 Initiator States

3.5.1.3.1 Idle

This is the initial state. The following event is processed in this state:

- Enlisting as a Phase Zero Participant on a Specific Transaction (section 3.5.4.2)

3.5.1.3.2 Awaiting Create Response

The following events are processed in this state:

- Receiving a TXUSER_PHASE0_MTAG_CREATED Message (section 3.5.5.2.1.1)
- Receiving a TXUSER_PHASE0_MTAG_CREATE_TX_NOT_FOUND or TXUSER_PHASE0_MTAG_CREATE_TOO_LATE Message (section 3.5.5.2.1.2)

3.5.1.3.3 Active

The following events are processed in this state:

- Receiving a TXUSER_PHASE0_MTAG_PHASE0REQ (section 3.5.5.2.1.3) message
- Receiving a TXUSER_PHASE0_MTAG_PHASE0REQ_ABORT (section 3.5.5.2.1.4) message
- Canceling Enlistment as a Phase Zero Participant on a Specific Transaction (section 3.5.4.1)

3.5.1.3.4 Processing Phase Zero Request

The following event is processed in this state:

- Phase Zero Request Completed (section 3.5.4.8)

3.5.1.3.5 Ended

This is the final state.

3.5.1.4 CONNTYPE_TXUSER_ENLISTMENT Initiator States

The resource manager MUST act as an initiator for the CONNTYPE_TXUSER_ENLISTMENT (section 2.2.10.2.2) connection type. In this role, the resource manager MUST provide support for the following states:

- Idle
- Awaiting Enlistment Response
- Active
- Single Phase Committing
- Preparing For Transaction Commit
- Finalizing Abort Operations
- Awaiting Transaction Outcome
- Finalizing Commit Operations
- Ended

The following figure shows the relationship between the CONNTYPE_TXUSER_ENLISTMENT initiator states. In the figure, the parenthetical numbers are the actual enumeration values.

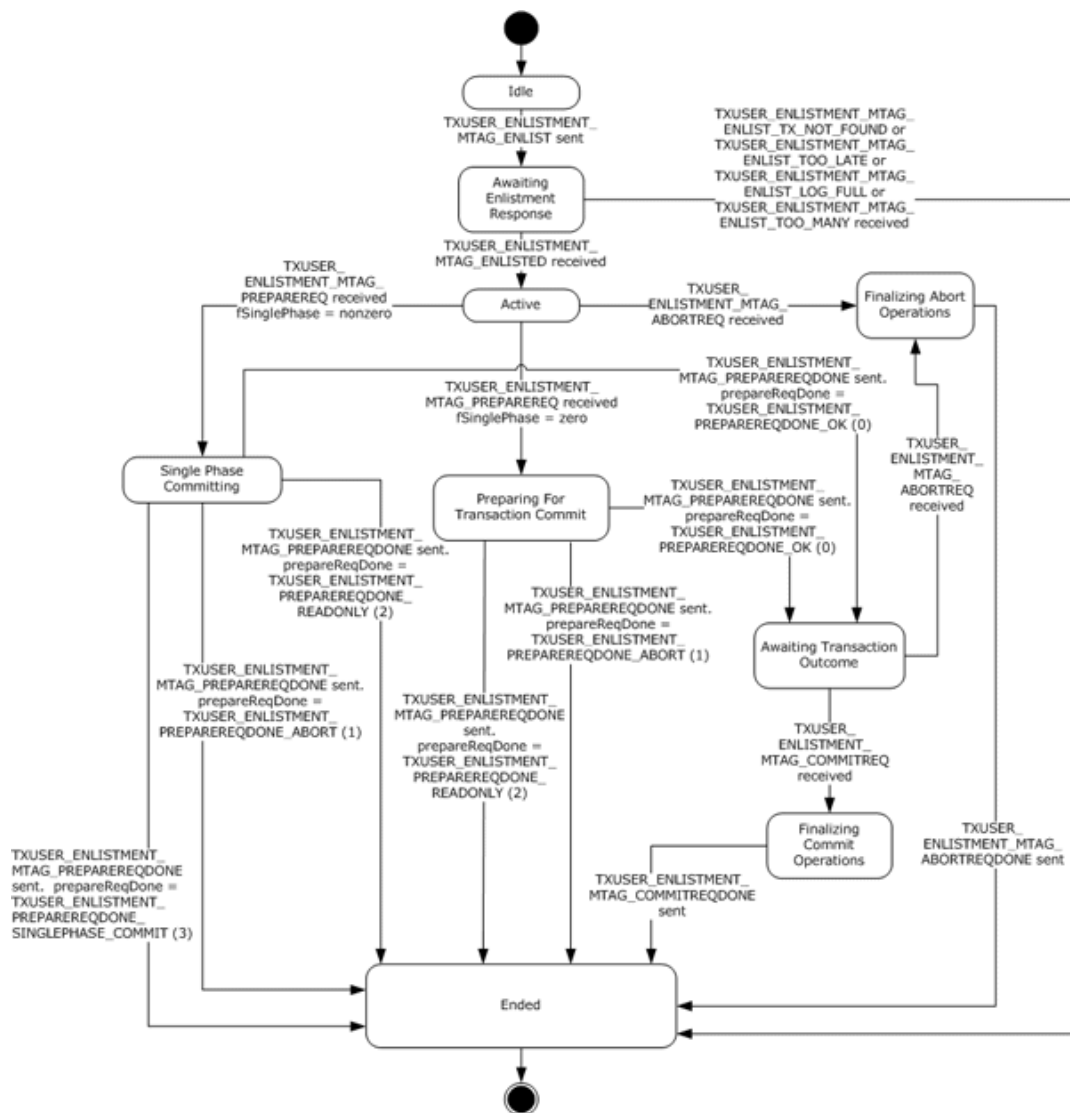

Figure 47: CONNTYPE_TXUSER_ENLISTMENT Initiator States

3.5.1.4.1 Idle

This is the initial state. The following event is processed in this state:

- Enlisting on a Specific Transaction (section 3.5.4.3)

3.5.1.4.2 Awaiting Enlistment Response

The following events are processed in this state:

- Receiving a TXUSER_ENLISTMENT_MTAG_ENLISTED Message (section 3.5.5.2.2.1)
- Receiving a TXUSER_ENLISTMENT_MTAG_ENLIST_TX_NOT_FOUND, TXUSER_ENLISTMENT_MTAG_ENLIST_TOO_LATE, TXUSER_ENLISTMENT_MTAG_ENLIST_LOG_FULL, or TXUSER_ENLISTMENT_MTAG_ENLIST_TOO_MANY Message (section 3.5.5.2.2.2)

3.5.1.4.3 Active

The following events are processed in this state:

- Receiving a TXUSER_ENLISTMENT_MTAG_PREPAREREQ Message (section 3.5.5.2.2.3)
- Receiving a TXUSER_ENLISTMENT_MTAG_ABORTREQ Message (section 3.5.5.2.2.5)
- Connection Disconnected (section 3.5.5.2.2.6)

3.5.1.4.4 Single Phase Committing

The following event is processed in this state:

- Enlistment Single-Phase Commit Request Completed (section 3.5.4.7)

3.5.1.4.5 Preparing for Transaction Commit

The following event is processed in this state:

- Enlistment Prepare Request Completed (section 3.5.4.6)

3.5.1.4.6 Finalizing Abort Operations

The following event is processed in this state:

- Enlistment Abort Request Completed (section 3.5.4.4)

3.5.1.4.7 Awaiting Transaction Outcome

The following events are processed in this state:

- Receiving a TXUSER_ENLISTMENT_MTAG_COMMITREQ Message (section 3.5.5.2.2.4)
- Receiving a TXUSER_ENLISTMENT_MTAG_ABORTREQ Message (section 3.5.5.2.2.5)

3.5.1.4.8 Finalizing Commit Operations

The following event is processed in this state:

- Enlistment Commit Request Completed (section 3.5.4.5)

3.5.1.4.9 Ended

This is the final state.

3.5.1.5 CONNTYPE_TXUSER_REENLIST Initiator States

The resource manager MUST act as an initiator for the CONNTYPE_TXUSER_REENLIST (section 2.2.10.3.1) connection type. In this role, the resource manager MUST provide support for the following states:

- Idle
- Awaiting Reenlist Response
- Ended

The following figure depicts the relationship between the CONNTYPE_TXUSER_REENLIST initiator states.

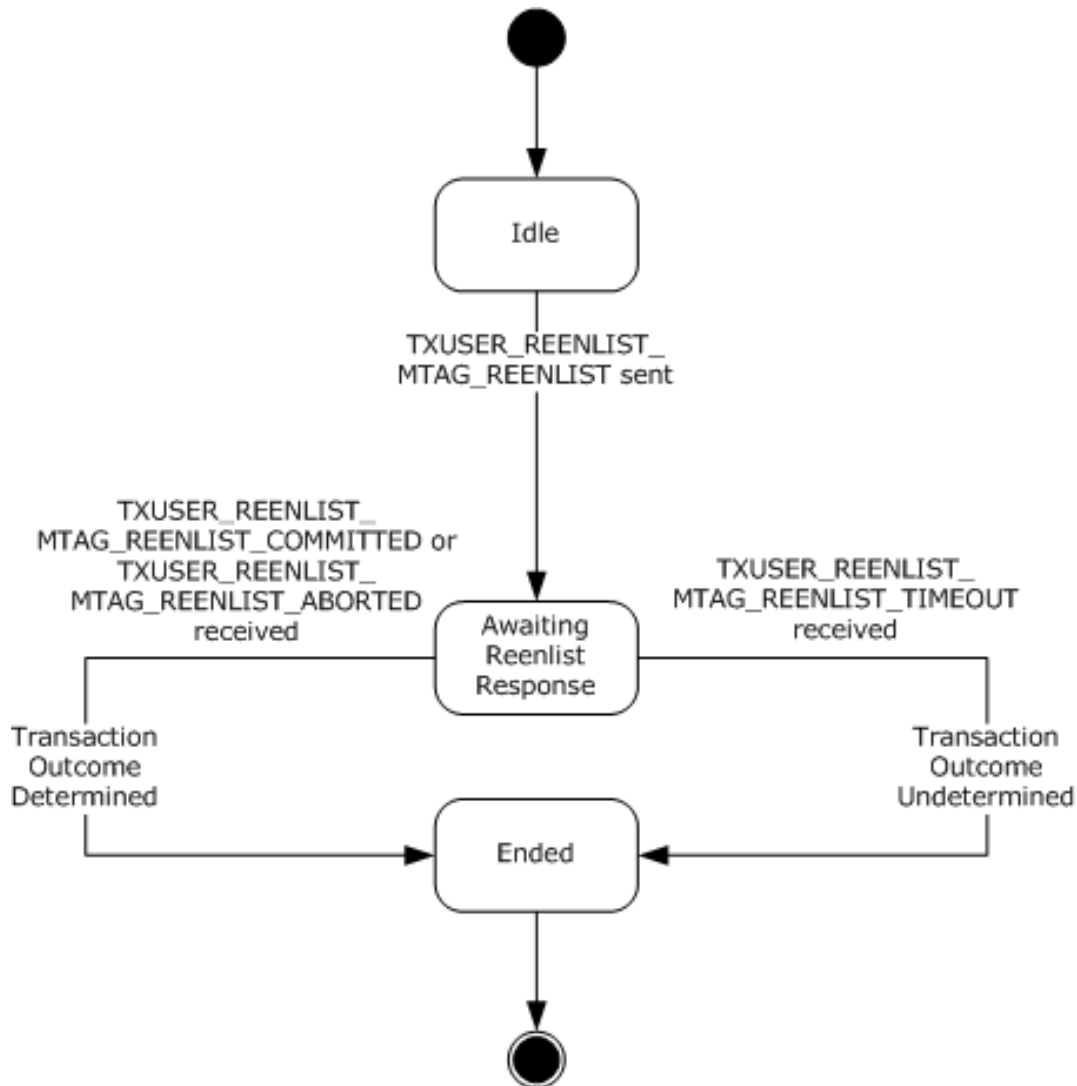

Figure 48: CONNTYPE_TXUSER_REENLIST Initiator States

3.5.1.5.1 Idle

This is the initial state. The following event is processed in this state:

- Recover Transaction (section 3.5.7.1)

3.5.1.5.2 Awaiting Reenlist Response

The following events are processed in this state:

- Receiving a TXUSER_REENLIST_MTAG_REENLIST_COMMITTED Message (section 3.5.5.3.1.1)
- Receiving a TXUSER_REENLIST_MTAG_REENLIST_ABORTED Message (section 3.5.5.3.1.2)
- Receiving a TXUSER_REENLIST_MTAG_REENLIST_TIMEOUT Message (section 3.5.5.3.1.3)

3.5.1.5.3 Ended

This is the final state.

3.5.1.6 CONNTYPE_TXUSER_VOTER Initiator States

The resource manager MUST act as an initiator for the CONNTYPE_TXUSER_VOTER (section 2.2.10.4.1) connection type. In this role, the resource manager MUST provide support for the following states:

- Idle
- Awaiting Creation Response
- Active
- Performing Transaction Operations
- Awaiting Outcome
- Ended

Note that the abstract data model can be implemented in a variety of ways. This protocol does not prescribe or advocate any specific implementation technique.

The following figure shows the relationship between the CONNTYPE_TXUSER_VOTER initiator states.

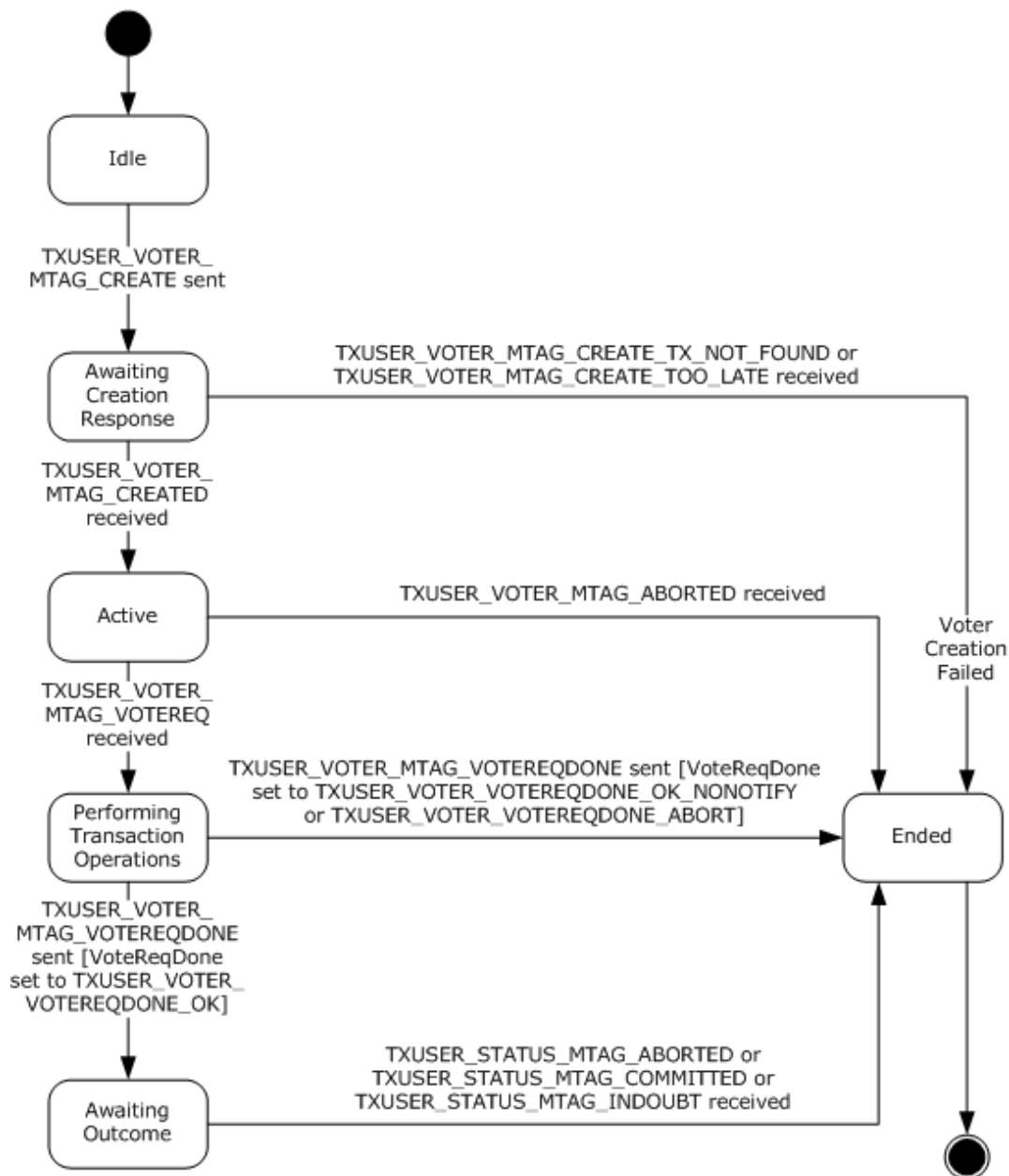

Figure 49: CONNTYPE_TXUSER_VOTER Initiator States

3.5.1.6.1 Idle

This is the initial state. The following event is processed in this state:

- Registering as a Voter on a Specific Transaction (section 3.5.4.9)

3.5.1.6.2 Awaiting Creation Response

The following events are processed in this state:

- Receiving a TXUSER_VOTER_MTAG_CREATED (section 3.5.5.4.1.1) message

- Receiving a TXUSER_VOTER_MTAG_CREATE_TX_NOT_FOUND or TXUSER_VOTER_MTAG_CREATE_TOO_LATE message (section 3.5.5.4.1.2)
- Receiving a Connection Disconnected (section 3.5.5.4.1.7)

3.5.1.6.3 Active

The following events are processed in this state:

- Receiving a TXUSER_VOTER_MTAG_VOTEREQ (section 3.5.5.4.1.3) message
- Receiving a TXUSER_STATUS_MTAG_ABORTED (section 3.5.5.4.1.5) message

3.5.1.6.4 Performing Transaction Operations

The following event is processed in this state:

- Voter Vote Request Completed (section 3.5.4.11)

3.5.1.6.5 Awaiting Outcome

The following events are processed in this state:

- Receiving a TXUSER_STATUS_MTAG_COMMITTED (section 3.5.5.4.1.4) message
- Receiving a TXUSER_STATUS_MTAG_ABORTED (section 3.5.5.4.1.5) message
- Receiving a TXUSER_STATUS_MTAG_INDOUBT (section 3.5.5.4.1.6) message
- Connection Disconnected (section 3.5.5.4.1.7)

3.5.1.6.6 Ended

This is the final state.

3.5.2 Timers

None.

3.5.3 Initialization

When a resource manager is initialized:

- The **Resource Manager.Identifier** field MUST be set to a GUID that is obtained from an implementation-specific source. This value MUST remain consistent across multiple software restarts or transient failures. The resource manager SHOULD create the GUID as specified in [RFC4122].
- The **Transaction Manager Name** field MUST be set to a value that is obtained from an implementation-specific source. This value MUST remain consistent across multiple software restarts or transient failures.
- The **Reenlistment Timeout** field MUST be set to a value that is obtained from an implementation-specific source.
- The resource manager MUST register with its transaction manager, as specified in section 3.5.4.10.

3.5.4 Higher-Layer Triggered Events

The resource manager operation is driven by a set of higher-layer events. These events are triggered by decisions that are made by the higher-layer business logic of the resource manager. The motivations and details of this higher-layer business logic are specific to the implementation of the resource manager and the software environment in which it executes.

The resource manager MUST be prepared to process the following events.

3.5.4.1 Canceling Enlistment as a Phase Zero Participant on a Specific Transaction

This event MUST be signaled by the higher-layer business logic with the following arguments:

- A connection object

If the higher-layer business logic cancels its enlistment as a Phase Zero participant on a specific transaction, the resource manager MUST perform the following steps:

- Send a TXUSER_PHASE0_MTAG_UNENLIST (section 2.2.10.2.1.8) message using the connection.
- Set the connection state to Ended.

3.5.4.2 Enlisting as a Phase Zero Participant on a Specific Transaction

This event MUST be signaled by the higher-layer business logic with the following arguments:

- A transaction object

If the higher-layer business logic enlists as a Phase Zero participant on a specific transaction, the resource manager MUST perform the following steps:

- If the transaction manager of the resource manager supports the CONNTYPE_TXUSER_PHASE0 connection type, as specified in section 2.2.1.1.3:
 - Initiate a new CONNTYPE_TXUSER_PHASE0 (section 2.2.10.2.1) connection to the transaction manager, using the **Transaction Manager Name** field of the resource manager.
 - Send a TXUSER_PHASE0_MTAG_CREATE (section 2.2.10.2.1.1) message using the connection:
 - Set the **guidTx** field to the **Transaction Object.Identifier** field of the transaction object.
 - Set the Transaction field of the connection to the provided transaction object.
 - Set the connection state to Awaiting Create Response.
- Otherwise, the resource manager MUST return a Failure to the higher-layer business logic.

3.5.4.3 Enlisting on a Specific Transaction

This event MUST be signaled by the higher-layer business logic with the following arguments:

- A transaction object.

If the higher-layer business logic decides to enlist on a specific transaction, the resource manager MUST perform the following steps:

- Initiate a new CONNTYPE_TXUSER_ENLISTMENT (section 2.2.10.2.2) connection to the transaction manager, using the **Transaction Manager Name** field of the resource manager.

- Assign the transaction object to the connection-specific data of the connection.
- Add the connection to the connection list of the transaction.
- Send a TXUSER_ENLISTMENT_MTAG_ENLIST (section 2.2.10.2.2.5) message using the connection:
 - Set the **guidTX** field to the **Transaction Object.Identifier** field of the transaction object.
 - Set the **guidRM** field to the **Resource Manager.Identifier** field of the resource manager.
 - Set the **guidSession** field to the **Session Identifier** field of the resource manager.
- Set the connection state to Awaiting Enlistment Response.

3.5.4.4 Enlistment Abort Request Completed

This event MUST be signaled by the higher-layer business logic with the following arguments:

- A connection object.

When the higher-layer business logic completes an enlistment Abort request, as specified in section 3.5.5.2.2.5 and 3.5.5.3.1.2, the resource manager MUST perform the following steps:

- If the connection type of the connection object is CONNTYPE_TXUSER_ENLISTMENT (section 2.2.10.2.2):
 - If the transaction object referenced by the connection object was added to the **Resource Manager.Durable Log**:
 - Remove the transaction object from the **Resource Manager.Durable Log**.
 - Send a TXUSER_ENLISTMENT_MTAG_ABORTREQDONE (section 2.2.10.2.2.2) message using the connection.
 - Set the connection state to Ended.
- Otherwise, if the connection type of the connection object is CONNTYPE_TXUSER_REENLIST (section 2.2.10.3.1):
 - If the transaction object referenced by the connection object was added to the **Resource Manager.Durable Log**:
 - Remove the transaction object from the **Resource Manager.Durable Log**.
 - Remove the connection from the reenlistment list of the resource manager.
 - If the list is now empty:
 - Signal the Reenlistment Complete (section 3.5.7.3) event on the resource manager.
 - Set the connection state to Ended.
- Otherwise, ignore the event.

3.5.4.5 Enlistment Commit Request Completed

This event MUST be signaled by the higher-layer business logic with the following arguments:

- A connection object

When the higher-layer business logic completes an enlistment Commit request as specified in section 3.5.5.2.2.4 and 3.5.5.3.1.1, the resource manager MUST perform the following steps:

- If the connection type of the connection object is CONNTYPE_TXUSER_ENLISTMENT (section 2.2.10.2.2):
 - Remove the transaction object referenced by the connection object from the **Resource Manager.Durable Log**.
 - Send a TXUSER_ENLISTMENT_MTAG_COMMITREQDONE (section 2.2.10.2.2.4) message using the connection.
 - Set the connection state to Ended.
- Otherwise, if the connection type of the connection object is CONNTYPE_TXUSER_REENLIST (section 2.2.10.3.1):
 - Remove the transaction object referenced by the connection object from the **Resource Manager.Durable Log**.
 - Remove the connection from the reenlistment list of the resource manager.
 - If the list is now empty:
 - Signal the Reenlistment Complete (section 3.5.7.3) event on the resource manager.
 - Set the connection state to Ended.
- Otherwise, ignore the event.

3.5.4.6 Enlistment Prepare Request Completed

This event MUST be signaled by the higher-layer business logic with the following arguments:

- A CONNTYPE_TXUSER_ENLISTMENT (section 2.2.10.2.2) connection object.
- An outcome value. This value MUST be one of the following:
 - Prepared
 - Read Only
 - Aborted

When the higher-layer business logic completes a Prepare request, as specified in section 3.5.5.2.2.3, the resource manager MUST perform the following steps:

- If the request outcome is Prepared:
 - Add the transaction object referenced by the connection object to the **Resource Manager.Durable Log**.
 - Send a TXUSER_ENLISTMENT_MTAG_PREPAREREQDONE (section 2.2.10.2.2.12) message using the connection:
 - Set the **prepareReqDone** field to TXUSER_ENLISTMENT_PREPAREREQDONE_OK.
 - Set the **guidReason** field to the value provided by the higher-layer business logic, as specified in section 2.2.10.2.2.12.
 - Set the connection state to Awaiting Transaction Outcome.

- Otherwise, if the request outcome is Read Only:
 - Send a TXUSER_ENLISTMENT_MTAG_PREPAREREQDONE message using the connection:
 - Set the **prepareReqDone** field to TXUSER_ENLISTMENT_PREPAREREQDONE_READONLY.
 - Set the connection state to Ended.
- Otherwise, if the request outcome is Aborted:
 - Send a TXUSER_ENLISTMENT_MTAG_PREPAREREQDONE message using the connection:
 - Set the **prepareReqDone** field to TXUSER_ENLISTMENT_PREPAREREQDONE_ABORT.
 - Set the connection state to Ended.

3.5.4.7 Enlistment Single-Phase Commit Request Completed

This event MUST be signaled by the higher-layer business logic with the following arguments:

- A CONNTYPE_TXUSER_ENLISTMENT (section 2.2.10.2.2) connection object.
- An outcome value. This value MUST be one of the following:
 - Read Only
 - Prepared
 - Committed
 - Aborted

When the higher-layer business logic completes an Enlistment Single-Phase Commit request as specified in Receiving a TXUSER_ENLISTMENT_MTAG_PREPAREREQ Message (section 3.5.5.2.2.3), the resource manager MUST perform the following steps:

- If the request outcome is Read Only:
 - Send a TXUSER_ENLISTMENT_MTAG_PREPAREREQDONE message using the connection:
 - Set the **prepareReqDone** field to TXUSER_ENLISTMENT_PREPAREREQDONE_READONLY.
 - Set the connection state to Ended.
- Otherwise, if the request outcome is Prepared:
 - Add the transaction object referenced by the connection object to the **Resource Manager.Durable Log**.
 - Send a TXUSER_ENLISTMENT_MTAG_PREPAREREQDONE message using the connection:
 - Set the **prepareReqDone** field to TXUSER_ENLISTMENT_PREPAREREQDONE_OK.
 - Set the connection state to Awaiting Transaction Outcome.
- Otherwise, if the request outcome is Committed:
 - Send a TXUSER_ENLISTMENT_MTAG_PREPAREREQDONE message using the connection:
 - Set the **prepareReqDone** field to TXUSER_ENLISTMENT_PREPAREREQDONE_SINGLEPHASE_COMMIT.

- Set the connection state to Ended.
- Otherwise, if the request outcome is Aborted:
 - Send a TXUSER_ENLISTMENT_MTAG_PREPAREREQDONE message using the connection:
 - Set the **prepareReqDone** field to TXUSER_ENLISTMENT_PREPAREREQDONE_ABORT.
 - Set the connection state to Ended.

3.5.4.8 Phase Zero Request Completed

This event MUST be signaled by the higher-layer business logic with the following arguments:

- A connection object.
- An outcome value. This value MUST be one of the following:
 - Read Only
 - Aborted

When the higher-layer business logic completes a Phase Zero request, the resource manager MUST perform the following steps:

- If the Phase Zero outcome is Read Only:
 - Send a TXUSER_PHASE0_MTAG_PHASE0REQDONE message.
 - Set the connection state to Ended.
- Otherwise, if the Phase Zero outcome is Aborted:
 - Set the connection state to Ended.

3.5.4.9 Registering as a Voter on a Specific Transaction

This event MUST be signaled by the higher-layer business logic with the following arguments:

- A transaction object

If the higher-layer business logic decides to register as a voter on a specific transaction manager, the resource manager MUST perform the following steps:

- Initiate a new CONNTYPE_TXUSER_VOTER (section 2.2.10.4.1) connection to the transaction manager using the transaction manager **Name** field of the resource manager.
- Send a TXUSER_VOTER_MTAG_CREATE (section 2.2.10.4.1.4) message using the connection:
 - Set the **guidTX** field to the **Transaction Object.Identifier** field of the transaction object.
- Set the connection state to Awaiting Creation Response.

3.5.4.10 Registering with Transaction Manager

If the higher-layer business logic wants to register with the transaction manager, the resource manager MUST perform the following actions:

- The resource manager SHOULD set the **Session Identifier** field to a new GUID value as specified in [RFC4122]. Optionally, the resource manager MAY instead set the Session Identifier field to NULL GUID.
- If the transaction manager's resource manager supports the CONNTYPE_TXUSER_RESOURCEMANAGERINTERNAL connection type as specified in section 2.2.1.1.3:
 - The resource manager MUST attempt to register with the transaction manager using CONNTYPE_TXUSER_RESOURCEMANAGERINTERNAL.
- Otherwise:
 - The resource manager MUST attempt to register with the transaction manager using CONNTYPE_TXUSER_RESOURCEMANAGER.

3.5.4.10.1 Registering with Transaction Manager Using CONNTYPE_TXUSER_RESOURCEMANAGER

The resource manager MUST perform the following actions:

- Initiate a new CONNTYPE_TXUSER_RESOURCEMANAGER connection using the **Transaction manager name** field of the resource manager.
- Assign the new connection to the **Resource Manager.Connection** field of the resource manager.
- Send a TXUSER_RESOURCEMANAGER_MTAG_CREATE message using the connection:
 - Set the **guidRM** field to the **Resource Manager.Identifier** field of the resource manager.
 - Set the **guidSession** field to the **Session Identifier** field of the resource manager.
- Set the connection state to Awaiting Create Response.

3.5.4.10.2 Registering with Transaction Manager Using CONNTYPE_TXUSER_RESOURCEMANAGERINTERNAL

The resource manager MUST perform the following actions:

- Initiate a new CONNTYPE_TXUSER_RESOURCEMANAGERINTERNAL connection using the transaction manager Name field of the resource manager.
- Assign the new connection to the **Resource Manager.Connection** field of the resource manager.
- Send a TXUSER_RESOURCEMANAGER_MTAG_CREATE message using the connection:
 - Set the **guidRM** field to the **Resource Manager.Identifier** field of the resource manager.
 - Set the **guidSession** field to the **Session Identifier** field of the resource manager.
- Set the connection state to Awaiting Create Response.

3.5.4.11 Voter Vote Request Completed

This event MUST be signaled by the higher-layer business logic with the following arguments:

- A connection object.
- An outcome value. This value MUST be one of the following:

- Prepared
- Read Only
- Aborted

When the higher-layer business logic completes a Voter Vote request, the resource manager **MUST** perform the following steps:

- If the vote outcome is Prepared:
 - Send a TXUSER_VOTER_MTAG_VOTEREQDONE message using the connection:
 - Set the **VoteReqDone** field to TXUSER_VOTER_VOTEREQDONE_OK.
 - Set the connection state to Awaiting Outcome.
- Otherwise, if the vote outcome is Read Only:
 - Send a TXUSER_VOTER_MTAG_VOTEREQDONE message using the connection:
 - Set the **VoteReqDone** field to TXUSER_VOTER_VOTEREQDONE_OK_NONOTIFY.
 - Set the connection state to Ended.
- Otherwise, if the vote outcome is Aborted:
 - Send a TXUSER_VOTER_MTAG_VOTEREQDONE message using the connection:
 - Set the **VoteReqDone** field to TXUSER_VOTER_VOTEREQDONE_ABORT.
 - Set the connection state to Ended.

3.5.5 Processing Events and Sequencing Rules

3.5.5.1 Resource Manager Registration

3.5.5.1.1 CONNTYPE_TXUSER_RESOURCEMANAGER as Initiator

For all messages that are received in this connection type, the resource manager **MUST** process the messages as specified in section 3.1. The resource manager **MUST** additionally follow the processing rules as specified in the following sections.

3.5.5.1.1.1 Receiving a TXUSER_RESOURCEMANAGER_MTAG_DUPLICATE Message

When the resource manager receives a TXUSER_RESOURCEMANAGER_MTAG_DUPLICATE message, the resource manager **MUST** perform the following actions:

- If the connection state is Awaiting Create Response:
 - Set the connection state to Ended.
 - Return a failure result to the higher-layer business logic.

3.5.5.1.1.2 Receiving a TXUSER_RESOURCEMANAGER_MTAG_REQUEST_COMPLETE Message

When the resource manager receives a TXUSER_RESOURCEMANAGER_REQUEST_COMPLETE message, the resource manager **MUST** perform the following actions:

- If the connection state is Awaiting Create Response:
 - Set the connection state to Recovering.
 - Signal the Recover Transactions event on the resource manager.
- Otherwise, if the connection state is Awaiting Completion Confirmation:
 - Set the connection state to Active.
 - Return a success result to the higher-layer business logic.

3.5.5.1.1.3 Connection Disconnected

When a CONNTYPE_TXUSER_RESOURCEMANAGER (section 2.2.10.1.1) connection is disconnected, the resource manager MUST perform the following actions:

- If the connection state is Active, Awaiting Create Response, Recovering, or Awaiting Completion Confirmation:
 - Set the connection state to Ended.
- Otherwise, the event MUST be processed as specified in section 3.1.8.3.

3.5.5.1.2 CONNTYPE_TXUSER_RESOURCEMANAGERINTERNAL as Initiator

For all messages received in this connection type, the resource manager MUST process the messages as specified in section 3.1. The resource manager MUST additionally follow the processing rules as specified in the following sections.

3.5.5.1.2.1 Receiving a TXUSER_RESOURCEMANAGER_MTAG_DUPLICATE or TXUSER_RESOURCEMANAGER_MTAG_REQUEST_COMPLETE Message

When the resource manager receives either the TXUSER_RESOURCEMANAGER_MTAG_DUPLICATE or TXUSER_RESOURCEMANAGER_MTAG_REQUEST_COMPLETE message, it MUST follow the same message-processing rules as the CONNTYPE_TXUSER_RESOURCEMANAGER connection type when it acts as the initiator. See section 3.5.5.1.1 for more information.

3.5.5.1.2.2 Receiving a TXUSER_RESOURCEMANAGERINTERNAL_MTAG_DUPLICATEDETECTED Message

When the resource manager receives a TXUSER_RESOURCEMANAGERINTERNAL_MTAG_DUPLICATEDETECTED message, the resource manager MUST perform the following actions:

- If the connection state is Recovering, Awaiting Completion Confirmation, or Active:
 - Inform the higher-layer business logic that the transaction manager has detected a duplicate resource manager registration.

3.5.5.1.2.3 Connection Disconnected

When a CONNTYPE_TXUSER_RESOURCEMANAGERINTERNAL (section 2.2.10.1.2) connection is disconnected, the event MUST be processed as specified in section 3.1.8.3.

3.5.5.2 Transaction Coordination

3.5.5.2.1 CONNTYPE_TXUSER_PHASE0 as Initiator

For all messages that are received in this connection type, the resource manager MUST process the message as specified in section 3.1. The resource manager MUST additionally follow the processing rules as specified in the following sections.

3.5.5.2.1.1 Receiving a TXUSER_PHASE0_MTAG_CREATED Message

When the resource manager receives a TXUSER_PHASE0_MTAG_CREATED message, the resource manager MUST perform the following actions:

- If the connection state is Awaiting Create Response:
 - Set the connection state to Active.
 - Return a success result to the higher-layer business logic.
 - Add the connection to the connection list of the transaction object referenced by the connection.
- Otherwise, the message MUST be processed as an invalid message as specified in section 3.1.6.

3.5.5.2.1.2 Receiving a TXUSER_PHASE0_MTAG_CREATE_TX_NOT_FOUND or TXUSER_PHASE0_MTAG_CREATE_TOO_LATE Message

When the resource manager receives either the TXUSER_PHASE0_MTAG_CREATE_TOO_LATE or TXUSER_PHASE0_MTAG_CREATE_TX_NOT_FOUND message, the resource manager MUST perform the following actions:

- If the connection state is Awaiting Create Response:
 - Return a failure result to the higher-layer business logic.
 - Set the connection state to Ended.
- Otherwise, the message MUST be processed as an invalid message as specified in section 3.1.6.

3.5.5.2.1.3 Receiving a TXUSER_PHASE0_MTAG_PHASE0REQ Message

When the resource manager receives a TXUSER_PHASE0_MTAG_PHASE0REQ message, the resource manager MUST perform the following actions:

- If the connection state is Active:
 - Set the connection state to Processing Phase Zero Request.
 - Send a Phase Zero request to the higher-layer business logic so that the resource manager can receive the Phase Zero outcome from the higher-layer business logic via the Phase Zero Request Completed (section 3.5.4.8) event.
- Otherwise, the message MUST be processed as an invalid message as specified in section 3.1.6.

3.5.5.2.1.4 Receiving a TXUSER_PHASE0_MTAG_PHASE0REQ_ABORT Message

When the resource manager receives a TXUSER_PHASE0_MTAG_PHASE0REQ_ABORT message, the resource manager MUST perform the following actions:

- If the connection state is Active:

- Send a Transaction Aborted notification to the higher-layer business logic.
- Set the connection state to Ended.
- Otherwise, the message MUST be processed as an invalid message as specified in section 3.1.6.

3.5.5.2.1.5 Connection Disconnected

When a CONNTYPE_TXUSER_PHASE0 (section 2.2.10.2.1) connection is disconnected, the resource manager MUST perform the following actions:

- If the connection state is Awaiting Create Response:
 - Return a failure result to the higher-layer business logic.
- Otherwise, if the connection state is Active or Processing Phase Zero Request:
 - Send a Transaction Aborted notification to the higher-layer business logic.
- Otherwise, the event MUST be processed as specified in section 3.1.8.3.

3.5.5.2.2 CONNTYPE_TXUSER_ENLISTMENT as Initiator

For all messages that are received in this connection type, the resource manager MUST process the message as specified in section 3.1. The resource manager MUST additionally follow the processing rules as specified in the following sections.

3.5.5.2.2.1 Receiving a TXUSER_ENLISTMENT_MTAG_ENLISTED Message

When the resource manager receives a TXUSER_ENLISTMENT_MTAG_ENLISTED message, the resource manager MUST perform the following actions:

- If the connection state is Awaiting Enlistment Response:
 - Set the connection state to Active.
 - Return a success result to the higher-layer business logic.
- Otherwise, the message MUST be processed as an invalid message as specified in section 3.1.6.

3.5.5.2.2.2 Receiving a TXUSER_ENLISTMENT_MTAG_ENLIST_TX_NOT_FOUND, TXUSER_ENLISTMENT_MTAG_ENLIST_TOO_LATE, TXUSER_ENLISTMENT_MTAG_ENLIST_LOG_FULL, or TXUSER_ENLISTMENT_MTAG_ENLIST_TOO_MANY Message

When the resource manager receives a TXUSER_ENLISTMENT_MTAG_ENLIST_TX_NOT_FOUND, TXUSER_ENLISTMENT_MTAG_ENLIST_TOO_LATE, TXUSER_ENLISTMENT_MTAG_ENLIST_LOG_FULL, or TXUSER_ENLISTMENT_MTAG_ENLIST_TOO_MANY message, the resource manager MUST perform the following actions:

- If the connection state is Awaiting Enlistment Response:
 - Return a failure result to the higher-layer business logic.
 - Set the connection state to Ended.
- Otherwise, the message MUST be processed as an invalid message as specified in section 3.1.6.

3.5.5.2.2.3 Receiving a TXUSER_ENLISTMENT_MTAG_PREPAREREQ Message

When the resource manager receives a TXUSER_ENLISTMENT_MTAG_PREPAREREQ message, the resource manager MUST perform the following actions:

- If the connection state is Active:
 - If the fSinglePhase field of the message is nonzero:
 - Set the connection state to Single-Phase Committing.
 - Send a Single-Phase Commit request to the higher-layer business logic.
 - Otherwise:
 - Set the connection state to Preparing For Transaction Commit.
 - Send a Prepare request to the higher-layer business logic.
- Otherwise, the message MUST be processed as an invalid message as specified in section 3.1.6.

3.5.5.2.2.4 Receiving a TXUSER_ENLISTMENT_MTAG_COMMITREQ Message

When the resource manager receives a TXUSER_ENLISTMENT_MTAG_COMMITREQ message, the resource manager MUST perform the following actions:

- If the connection state is Awaiting Transaction Outcome:
 - Set the connection state to Finalizing Commit Operations.
 - Send a Commit Request to the higher-layer business logic.
- Otherwise, the message MUST be processed as an invalid message as specified in section 3.1.6.

3.5.5.2.2.5 Receiving a TXUSER_ENLISTMENT_MTAG_ABORTREQ Message

When the resource manager receives a TXUSER_ENLISTMENT_MTAG_ABORTREQ message, the resource manager MUST perform the following actions:

- If the connection state is Active:
 - Send an Abort request to the higher-layer business logic.
 - Set the connection state to Finalizing Abort Operations.
- Otherwise, if the connection state is Awaiting Transaction Outcome:
 - Remove the transaction object referenced by the connection from the **Resource Manager.Durable Log**.
 - Send an Abort request to the higher-layer business logic.
 - Set the connection state to Finalizing Abort Operations.
- Otherwise, the message MUST be processed as an invalid message as specified in section 3.1.6.

3.5.5.2.2.6 Connection Disconnected

When a CONNTYPE_TXUSER_ENLISTMENT (section 2.2.10.2.2) connection is disconnected, the resource manager MUST perform the following actions:

- If the connection state is either Awaiting Enlistment Response, Active, or Preparing For Transaction Commit:

- Send an Abort request to the higher-layer business logic.
- Otherwise, the event MUST be processed as specified in section 3.1.8.3.

3.5.5.3 Transaction Recovery

3.5.5.3.1 CONNTYPE_TXUSER_REENLIST as Initiator

For all messages that are received in this connection type, the resource manager MUST process the message as specified in section 3.1. The resource manager MUST additionally follow the processing rules as specified in the following sections.

3.5.5.3.1.1 Receiving a TXUSER_REENLIST_MTAG_REENLIST_COMMITTED Message

When the resource manager receives a TXUSER_REENLIST_MTAG_REENLIST_COMMITTED message, the resource manager MUST perform the following actions:

- If the connection state is Awaiting Reenlist Response:
 - Send a Commit request to the higher-layer business logic for the transaction object referenced by the Transaction field of the receiving connection.
 - Set the connection state to Ended.
- Otherwise, the message MUST be processed as an invalid message as specified in section 3.1.6.

3.5.5.3.1.2 Receiving a TXUSER_REENLIST_MTAG_REENLIST_ABORTED Message

When the resource manager receives a TXUSER_REENLIST_MTAG_REENLIST_ABORTED message, the resource manager MUST perform the following actions:

- If the connection state is Awaiting Reenlist Response:
 - Send an Abort request to the higher-layer business logic.
 - Set the connection state to Ended.
- Otherwise, the message MUST be processed as an invalid message as specified in section 3.1.6.

3.5.5.3.1.3 Receiving a TXUSER_REENLIST_MTAG_REENLIST_TIMEOUT Message

When the resource manager receives a TXUSER_REENLIST_MTAG_REENLIST_TIMEOUT message, the resource manager MUST perform the following actions:

- If the connection state is Awaiting Reenlist Response:
 - Signal the Reenlistment Timeout event with the transaction object referenced by this connection.
 - Set the connection state to Ended.
- Otherwise, the message MUST be processed as an invalid message as specified in section 3.1.6.

3.5.5.3.1.4 Connection Disconnected

When a CONNTYPE_TXUSER_REENLIST (section 2.2.10.3.1) connection is disconnected, the resource manager MUST perform the following actions:

- If the connection state is Awaiting Reenlistment Response:

- Return a failure result to the higher-layer business logic.
- Otherwise, the event MUST be processed as specified in section 3.1.8.3.

3.5.5.4 Voting

3.5.5.4.1 CONNTYPE_TXUSER_VOTER as Initiator

For all messages that are received in this connection type, the resource manager MUST process the message as specified in section 3.1. The resource manager MUST additionally follow the processing rules as specified in the following sections.

3.5.5.4.1.1 Receiving a TXUSER_VOTER_MTAG_CREATED Message

When the resource manager receives a TXUSER_VOTER_MTAG_CREATED message, the resource manager MUST perform the following actions:

- If the connection state is Awaiting Creation Response:
 - Return a success result to the higher-layer business logic.
 - Set the connection state to Active.
- Otherwise, the message MUST be processed as an invalid message as specified in section 3.1.6.

3.5.5.4.1.2 Receiving a TXUSER_VOTER_MTAG_CREATE_TX_NOT_FOUND or TXUSER_VOTER_MTAG_CREATE_TOO_LATE Message

When the resource manager receives either a TXUSER_VOTER_MTAG_CREATE_TX_NOT_FOUND or TXUSER_VOTER_MTAG_CREATE_TOO_LATE message, the resource manager MUST perform the following actions:

- If the connection state is Awaiting Creation Response:
 - Return a failure result to the higher-layer business logic.
 - Set the connection state to Ended.
- Otherwise, the message MUST be processed as an invalid message as specified in section 3.1.6.

3.5.5.4.1.3 Receiving a TXUSER_VOTER_MTAG_VOTEREQ Message

When the resource manager receives a TXUSER_VOTER_MTAG_VOTEREQ message, the resource manager MUST perform the following actions:

- If the connection state is Active:
 - Send a Vote request to the higher-layer business logic.
 - Set the connection state to Performing Transaction Operations.
- Otherwise, the message MUST be processed as an invalid message as specified in section 3.1.6.

3.5.5.4.1.4 Receiving a TXUSER_STATUS_MTAG_COMMITTED Message

When the resource manager receives a TXUSER_STATUS_MTAG_COMMITTED message, the resource manager MUST perform the following actions:

- If the connection state is Awaiting Outcome:

- Send a Transaction Committed notification to the higher-layer business logic.
- Set the connection state to Ended.
- Otherwise, the message MUST be processed as an invalid message as specified in section 3.1.6.

3.5.5.4.1.5 Receiving a TXUSER_STATUS_MTAG_ABORTED Message

When the resource manager receives a TXUSER_STATUS_MTAG_ABORTED message, the resource manager MUST perform the following actions:

- If the connection state is Active or Awaiting Outcome:
 - Send a Transaction Aborted notification to the higher-layer business logic.
 - Set the connection state to Ended.
- Otherwise, the message MUST be processed as an invalid message as specified in section 3.1.6.

3.5.5.4.1.6 Receiving a TXUSER_STATUS_MTAG_INDOUBT Message

When the resource manager receives a TXUSER_STATUS_MTAG_INDOUBT message, the resource manager MUST perform the following actions:

- If the connection state is Awaiting Outcome:
 - Send a Transaction In Doubt notification to the higher-layer business logic.
 - Set the connection state to Ended.
- Otherwise, the message MUST be processed as an invalid message as specified in section 3.1.6.

3.5.5.4.1.7 Connection Disconnected

When a CONNTYPE_TXUSER_VOTER (section 2.2.10.4.1) connection is disconnected, the resource manager MUST perform the following actions:

- If the connection state is Awaiting Creation Response:
 - Return a failure result to the higher-layer business logic.
- Otherwise, if the connection state is Awaiting Outcome:
 - Send a Transaction In Doubt notification to the higher-layer business logic.
- Otherwise, the event MUST be processed as specified in section 3.1.8.3.

3.5.6 Timer Events

No timer events.

3.5.7 Other Local Events

The resource manager MUST be prepared to process the local events that appear in this section.

3.5.7.1 Recover Transaction

The Recover Transaction event MUST be signaled with the following arguments:

- A transaction object.

If the Recover Transaction event is signaled, the resource manager MUST perform the following steps:

- Initiate a new CONNTYPE_TXUSER_REENLIST (section 2.2.10.3.1) connection to the transaction manager, using the Transaction Manager Name field of the resource manager.
- Set the **Transaction** field of the connection object to the provided transaction object.
- Add the connection to the reenlistment list of the resource manager.
- Add the connection to the connection list of the transaction object.
- Send a TXUSER_REENLIST_MTAG_REENLIST (section 2.2.10.3.1.1) message using the connection:
 - Set the **guidTx** field to the **Transaction Object.Identifier** field of the transaction.
 - Set the **ulTimeout** field to the Reenlistment Timeout field of the resource manager.
 - Set the **guidRm** field to the **Resource Manager.Identifier** field of the resource manager.
- Set the connection state to Awaiting Reenlist Response.

3.5.7.2 Recover Transactions

If the Recover Transactions event is signaled, the resource manager MUST perform the following steps:

- If the **Resource Manager.Durable Log** of the resource manager is empty:
 - Signal the Reenlistment Complete (section 3.5.7.3) event on the resource manager.
- Otherwise, for each transaction object in the **Resource Manager.Durable Log**:
 - Signal the Recover Transaction (section 3.5.7.1) event on the resource manager with the transaction object.

3.5.7.3 Reenlistment Complete

If the Reenlistment Complete event is signaled, the resource manager MUST perform the following actions:

- Send a TXUSER_RESOURCEMANAGER_MTAG_REENLISTMENTCOMPLETE message using the connection that is referenced by the **Resource Manager.Connection** field of the resource manager.
- Set the connection state to Awaiting Completion Confirmation.

3.5.7.4 Transaction Manager Down

When the Transaction Manager Down event is signaled, the resource manager MUST perform the following steps:

- Inform the higher-layer business logic that the transaction manager has disconnected.
- The higher-layer business requests that the resource manager reregister with the transaction manager. The timing of the request is implementation-specific.

3.5.7.5 Reenlistment Timeout

The Reenlistment Timeout event MUST be signaled with the following arguments:

- A transaction object.

When the Reenlistment Timeout event is signaled, the resource manager MUST perform the following steps:

- Inform the higher-layer business logic that the reenlistment has timed out for the transaction object.
- The higher-layer business MUST request that the resource manager reregister with the transaction manager. The timing of the request is implementation-specific.

3.6 Transaction Manager Communicating with Resource Manager Facet Details

3.6.1 Abstract Data Model

This section describes a conceptual model of possible data organization that an implementation maintains to participate in this protocol. The described organization is provided to facilitate the explanation of how the protocol behaves. This document does not mandate that implementations adhere to this model if their external behavior is consistent with the behavior that is described in this document.

Note that the abstract data model can be implemented in a variety of ways. This protocol does not prescribe or advocate any specific implementation technique.

The transaction manager communicating with a resource manager facet MUST maintain all the data elements as specified in sections 3.1.1 and 3.2.1.

The transaction manager communicating with a resource manager facet MUST additionally maintain the following data elements:

- **Active Resource Manager Table:** A table of entries to resource manager objects, keyed by resource manager identifier.
- **Failed to Notify List:** A list of Enlistment objects representing remote resource managers that have not yet acknowledged the Commit outcome of a transaction.

A resource manager object MUST contain the following data structures:

- **Resource Manager Object.Identifier:** Specifies the resource manager identifier.
- **Session Identifier:** A GUID that specifies the resource manager session identifier.
- **Resource Manager Object.Connection:** The CONNTYPE_TXUSER_RESOURCEMANAGERINTERNAL (section 2.2.10.1.2) or CONNTYPE_TXUSER_RESOURCEMANAGER (section 2.2.10.1.1) connection object that is associated with the resource manager.

Enlistment objects that are created by the transaction manager communicating with a resource manager facet MUST provide the following properties as specified in section 3.1.1:

- **Name:** The resource manager identifier field of the Enlistment object, formatted as a string as specified in [C706] Appendix A.
- **Enlistment Object.Identifier:** An empty string.

The transaction manager communicating with a resource manager MUST provide the states as specified in the following sections for its supported connection types. Section 2.2.1.1.3 defines the connection types that a transaction manager communicating with a resource manager MUST provide for each supported protocol version.

3.6.1.1 CONNTYPE_TXUSER_RESOURCEMANAGER Acceptor States

The transaction manager communicating with a resource manager MUST act as an acceptor for the CONNTYPE_TXUSER_RESOURCEMANAGER (section 2.2.10.1.1) connection type. In this role, the transaction manager communicating with a resource manager MUST provide support for the following states:

- Idle (section 3.6.1.1.1)
- Creating (section 3.6.1.1.2)
- Reenlisting (section 3.6.1.1.3)
- Active (section 3.6.1.1.4)
- Ended (section 3.6.1.1.5)

The following figure shows the relationship between the CONNTYPE_TXUSER_RESOURCEMANAGER (section 2.2.10.1.1) acceptor states.

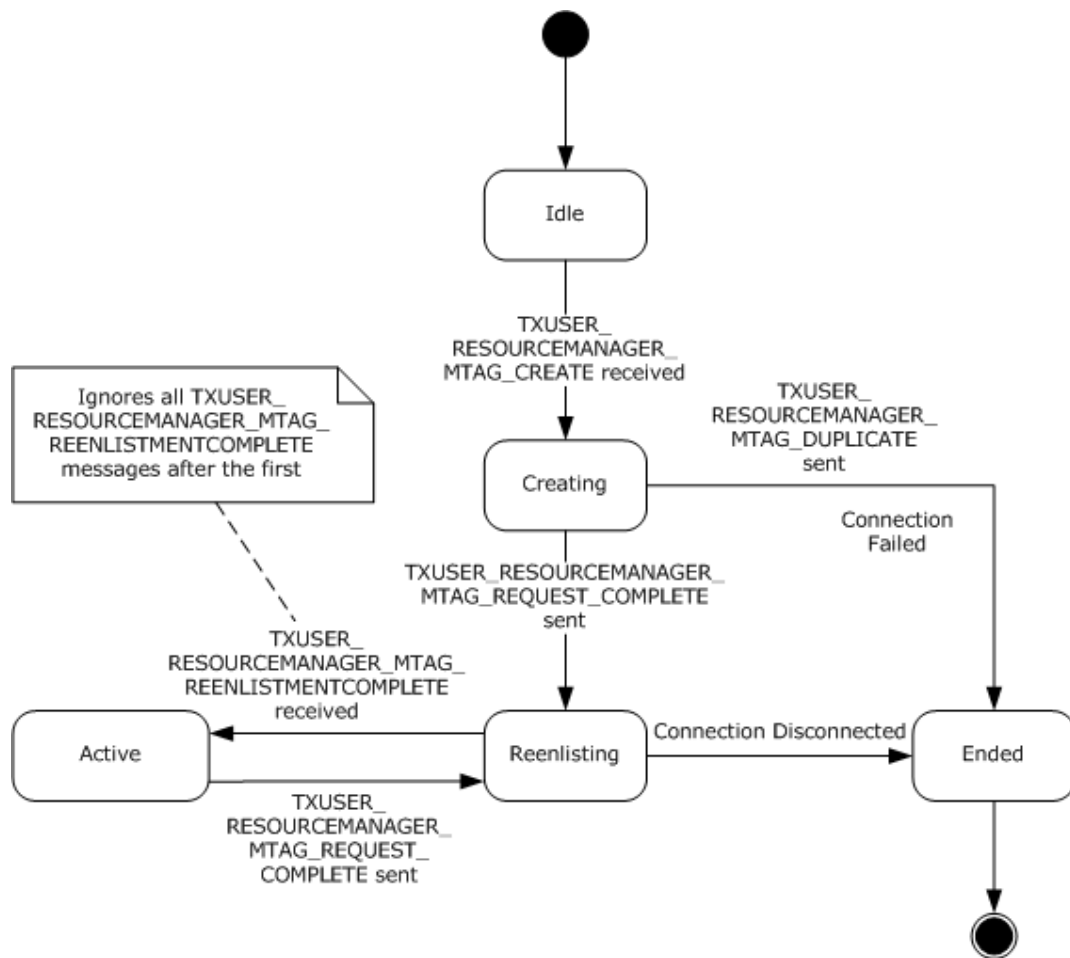

Figure 50: CONNTYPE_TXUSER_RESOURCEMANAGER acceptor states

3.6.1.1.1 Idle

The Idle state is the initial state. The following event is processed in this state:

- Receiving a TXUSER_RESOURCEMANAGER_MTAG_CREATE Message (section 3.6.5.1.1.1)

3.6.1.1.2 Creating

The following event is processed in the Creating state:

- Create Resource Manager (section 3.6.7.9)

3.6.1.1.3 Reenlisting

The following events are processed in the Reenlisting state:

- Receiving a TXUSER_RESOURCEMANAGER_MTAG_REENLISTMENTCOMPLETE Message (section 3.6.5.1.1.2)
- Connection Disconnected (section 3.6.5.1.1.3)

3.6.1.1.4 Active

The following event is processed in the Active state:

- Reenlist Complete (section 3.6.7.15)

3.6.1.1.5 Ended

The final state is the Ended state.

3.6.1.2 CONNTYPE_TXUSER_RESOURCEMANAGERINTERNAL Acceptor States

The transaction manager communicating with a resource manager **MUST** act as an acceptor for the CONNTYPE_TXUSER_RESOURCEMANAGERINTERNAL (section 2.2.10.1.2) connection type. In this role, the transaction manager communicating with a resource manager **MUST** provide support for the following states:

- Idle (section 3.6.1.2.1)
- Creating (section 3.6.1.2.2)
- Reenlisting (section 3.6.1.2.3)
- Active (section 3.6.1.2.4)
- Ended (section 3.6.1.2.5)

The following figure shows the relationship between the CONNTYPE_TXUSER_RESOURCEMANAGERINTERNAL (section 2.2.10.1.2) acceptor states.

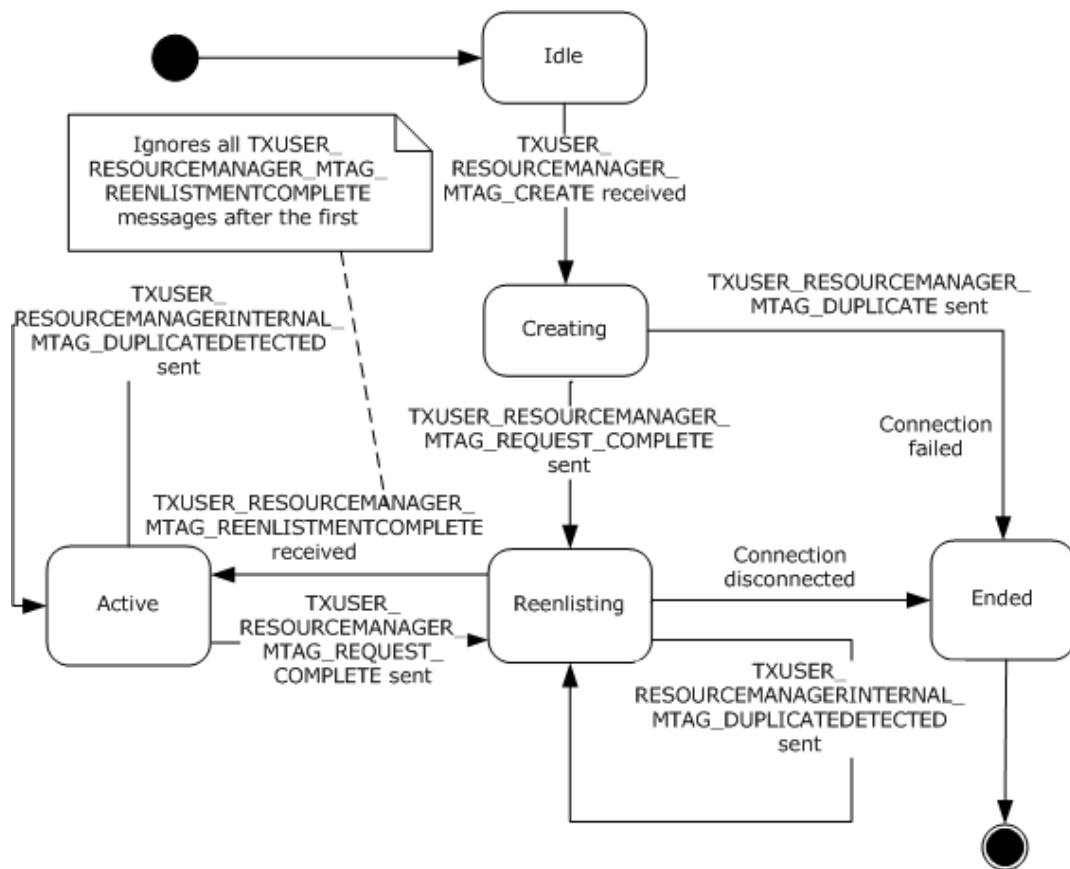

Figure 51: CONNTYPE_TXUSER_RESOURCEMANAGERINTERNAL acceptor states

3.6.1.2.1 Idle

This is the initial state. The following event is processed in this state:

- Receiving a TXUSER_RESOURCEMANAGER_MTAG_CREATE Message (section 3.6.5.1.2.1)

3.6.1.2.2 Creating

The following event is processed in this state:

- Create Resource Manager (section 3.6.7.9)

3.6.1.2.3 Reenlisting

The following events are processed in this state:

- Receiving a TXUSER_RESOURCEMANAGER_MTAG_REENLISTMENTCOMPLETE Message (section 3.6.5.1.2.2)
- Create Resource Manager (section 3.6.7.9)
- Connection Disconnected (section 3.6.5.1.2.3)

3.6.1.2.4 Active

The following events are processed in this state:

- Reenlist Complete (section 3.6.7.15)
- Create Resource Manager (section 3.6.7.9)

3.6.1.2.5 Ended

This is the final state.

3.6.1.3 CONNTYPE_TXUSER_PHASE0 Acceptor States

The transaction manager communicating with a resource manager MUST act as an acceptor for the CONNTYPE_TXUSER_PHASE0 (section 2.2.10.2.1) connection type. In this role, the transaction manager communicating with a resource manager MUST provide support for the following states:

- Idle (section 3.6.1.3.1)
- Awaiting Create Response (section 3.6.1.3.2)
- Active (section 3.6.1.3.3)
- Awaiting Phase Zero Response (section 3.6.1.3.4)
- Ended (section 3.6.1.3.5)

The following figure shows the relationship between the CONNTYPE_TXUSER_PHASE0 (section 2.2.10.2.1) acceptor states.

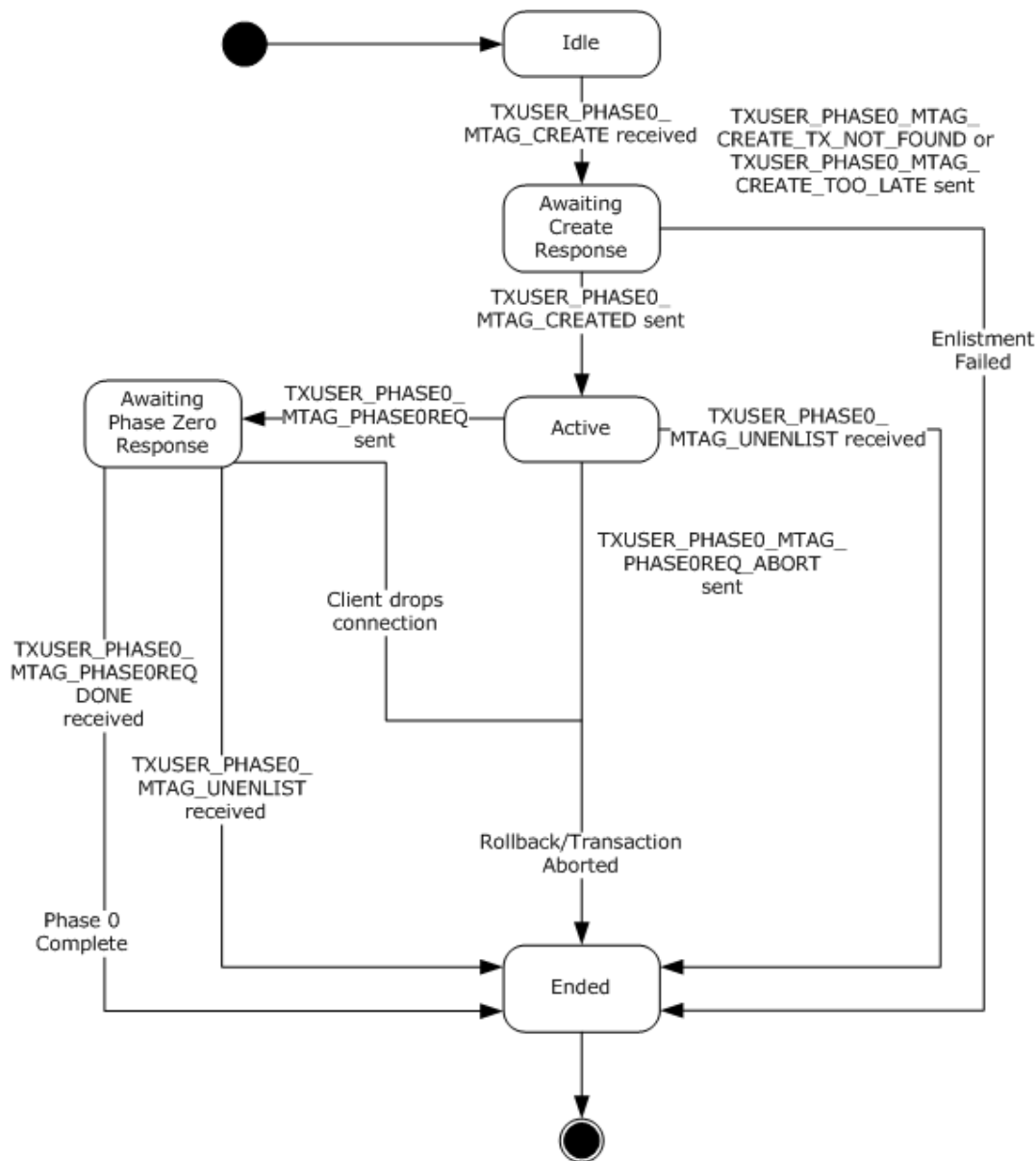

Figure 52: CONNTYPE_TXUSER_PHASE0 acceptor states

3.6.1.3.1 Idle

This is the initial state. The following event us processed in this state:

- Receiving a TXUSER_PHASE0_MTAG_CREATE Message (section 3.6.5.2.1.1)

3.6.1.3.2 Awaiting Create Response

The following events are processed in this state:

- Create Phase Zero Enlistment Success (section 3.6.7.8)
- Create Phase Zero Enlistment Failure (section 3.6.7.7)

3.6.1.3.3 Active

The following events are processed in this state:

- Begin Phase Zero (section 3.6.7.4)
- Phase Zero Aborted (section 3.6.7.14)
- Receiving a TXUSER_PHASE0_MTAG_UNENLIST Message (section 3.6.5.2.1.3)

3.6.1.3.4 Awaiting Phase Zero Response

The following events are processed in this state:

- Receiving a TXUSER_PHASE0_MTAG_PHASE0REQDONE Message (section 3.6.5.2.1.2)
- Receiving a TXUSER_PHASE0_MTAG_UNENLIST Message (section 3.6.5.2.1.3)

3.6.1.3.5 Ended

This is the final state.

3.6.1.4 CONNTYPE_TXUSER_ENLISTMENT Acceptor States

The transaction manager communicating with a resource manager MUST act as an acceptor for the CONNTYPE_TXUSER_ENLISTMENT (section 2.2.10.2.2) connection type. In this role, the transaction manager communicating with a resource manager MUST provide support for the following states:

- Idle (section 3.6.1.4.1)
- Processing Enlistment Request (section 3.6.1.4.2)
- Active (section 3.6.1.4.3)
- Awaiting Single Phase Commit Response (section 3.6.1.4.4)
- Awaiting Prepare Response (section 3.6.1.4.5)
- Awaiting Prepare Response Aborted (section 3.6.1.4.6)
- Prepared (section 3.6.1.4.7)
- Awaiting Commit Response (section 3.6.1.4.8)
- Awaiting Abort Response (section 3.6.1.4.9)
- Ended (section 3.6.1.4.10)

The following figure shows the relationship between the CONNTYPE_TXUSER_ENLISTMENT (section 2.2.10.2.2) acceptor states.

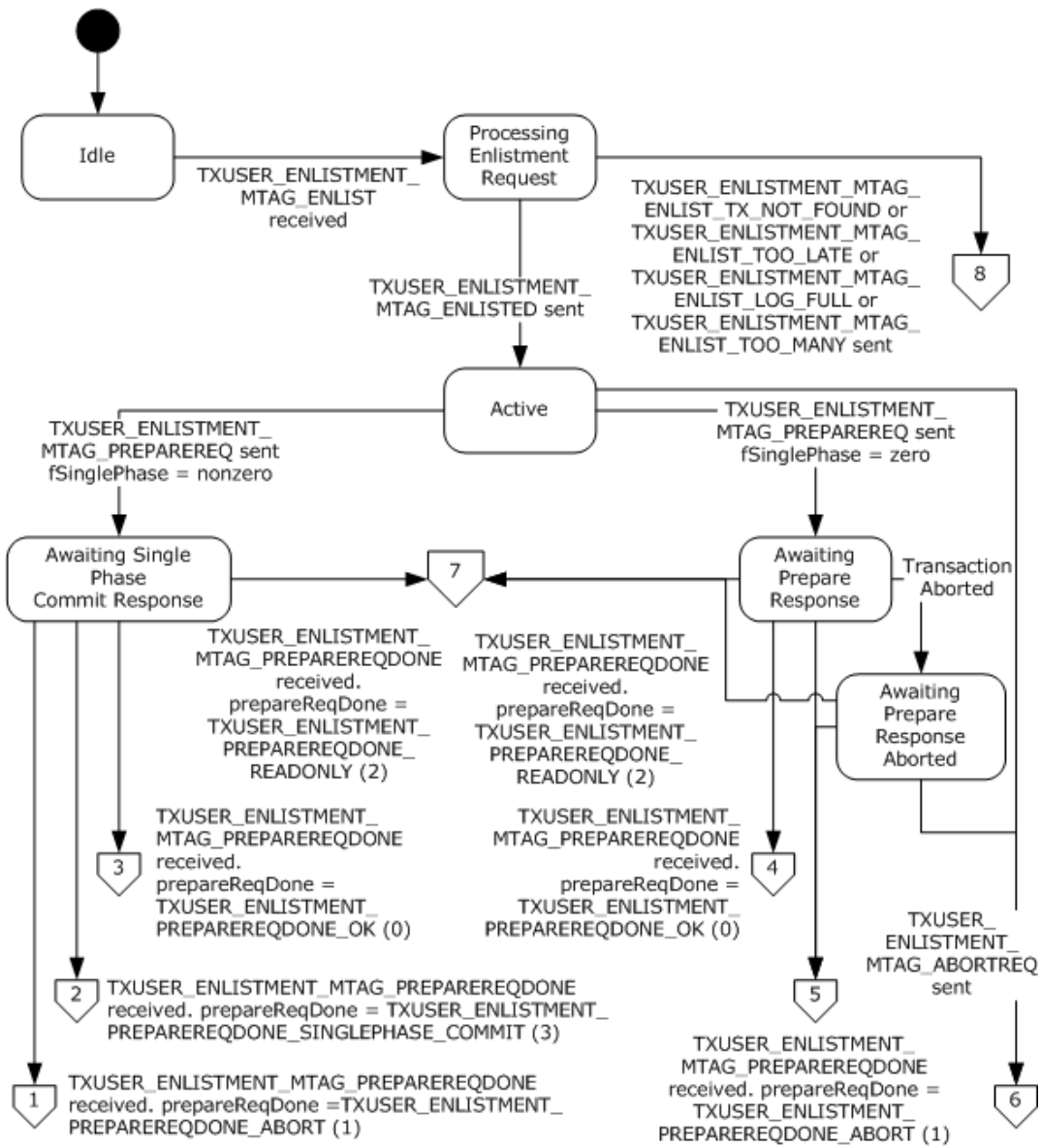

Figure 53: CONNTYPE_TXUSER_ENLISTMENT acceptor states (processing enlistment request)

The following events are processed in this state:

- Begin Phase One (section 3.6.7.3)
- Begin Rollback (section 3.6.7.5)

3.6.1.4.4 Awaiting Single-Phase Commit Response

The following event is processed in this state:

- Receiving a TXUSER_ENLISTMENT_MTAG_PREPAREREQDONE Message (section 3.6.5.2.2.2)

3.6.1.4.5 Awaiting Prepare Response

The following events are processed in this state:

- Receiving a TXUSER_ENLISTMENT_MTAG_PREPAREREQDONE Message (section 3.6.5.2.2.2)
- Begin Rollback (section 3.6.7.5)

3.6.1.4.6 Awaiting Prepare Response Aborted

The following event is processed in this state:

- Receiving a TXUSER_ENLISTMENT_MTAG_PREPAREREQDONE Message (section 3.6.5.2.2.2)

3.6.1.4.7 Prepared

The following events are processed in this state:

- Begin Commit (section 3.6.7.1)
- Begin Rollback (section 3.6.7.5)

3.6.1.4.8 Awaiting Commit Response

The following event is processed in this state:

- Receiving a TXUSER_ENLISTMENT_MTAG_COMMITREQDONE Message (section 3.6.5.2.2.3)

3.6.1.4.9 Awaiting Abort Response

The following event is processed in this state:

- Receiving a TXUSER_ENLISTMENT_MTAG_ABORTREQDONE Message (section 3.6.5.2.2.4)

3.6.1.4.10 Ended

This is the final state.

3.6.1.5 CONNTYPE_TXUSER_REENLIST Acceptor States

The transaction manager communicating with a resource manager MUST act as an acceptor for the CONNTYPE_TXUSER_REENLIST (section 2.2.10.3.1) connection type. In this role, the transaction manager communicating with a resource manager MUST provide support for the following states:

- Idle (section 3.6.1.5.1)
- Processing Reenlist Request (section 3.6.1.5.2)

- Ended (section 3.6.1.5.3)

The following figure shows the relationship between the CONNTYPE_TXUSER_REENLIST (section 2.2.10.3.1) acceptor states.

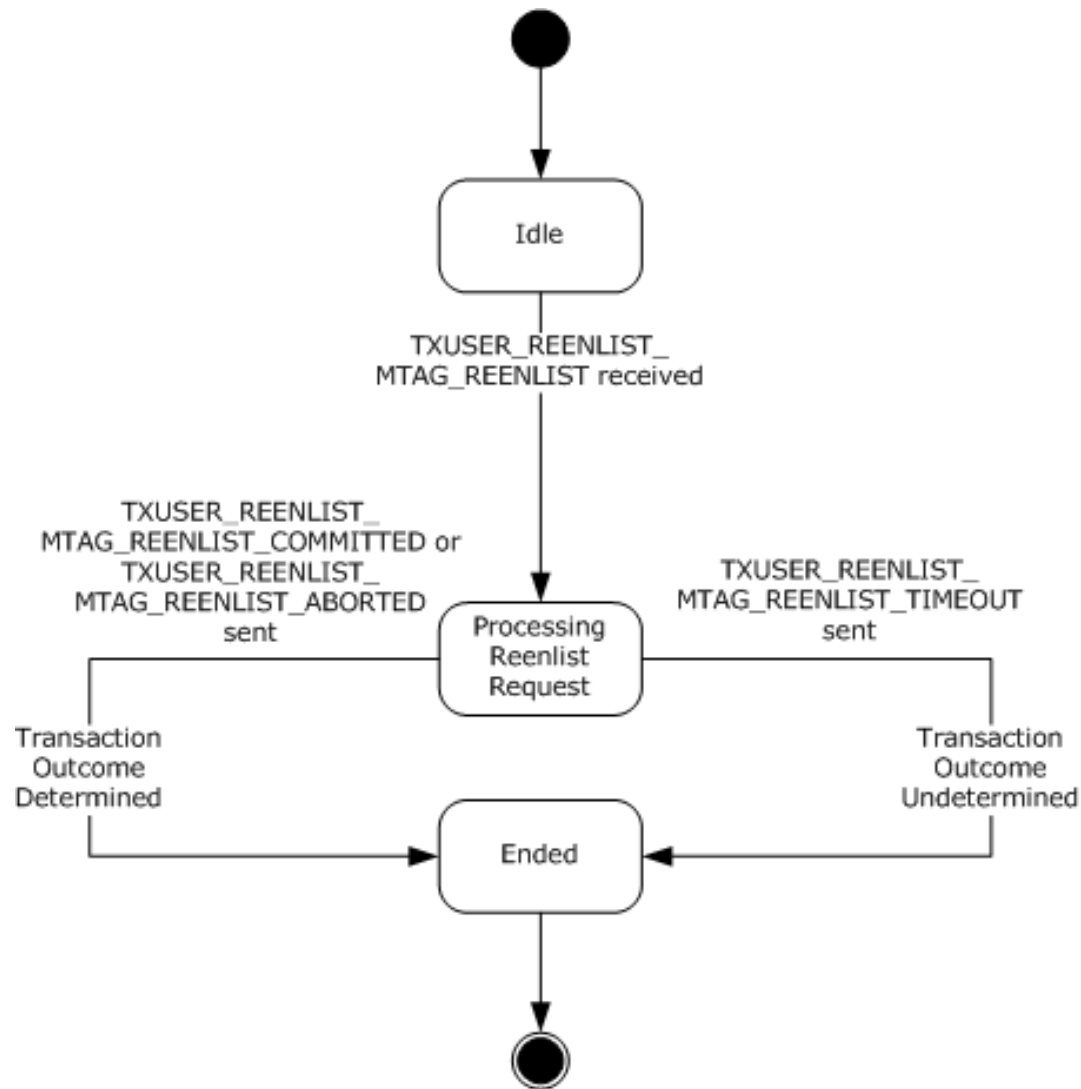

Figure 55: CONNTYPE_TXUSER_REENLIST acceptor states

3.6.1.5.1 Idle

This is the initial state. The following event is processed in this state:

- Receiving a TXUSER_REENLIST_MTAG_REENLIST Message (section 3.6.5.3.1.1)

3.6.1.5.2 Processing Reenlist Request

The following events are processed in this state:

- Begin Commit (section 3.6.7.1)

- Begin Rollback (section 3.6.7.5)
- Reenlist Timeout Timer (section 3.6.6.1)

3.6.1.5.3 Ended

This is the final state.

3.6.1.6 CONNTYPE_TXUSER_VOTER Acceptor States

The transaction manager communicating with a resource manager **MUST** act as an acceptor for the CONNTYPE_TXUSER_VOTER (section 2.2.10.4.1) connection type. In this role, the transaction manager communicating with a resource manager **MUST** provide support for the following states:

- Idle (section 3.6.1.6.1)
- Create Voter (section 3.6.1.6.2)
- Active (section 3.6.1.6.3)
- Awaiting Voter Response (section 3.6.1.6.4)
- Awaiting Outcome (section 3.6.1.6.5)
- Ended (section 3.6.1.6.6)

The following figure shows the relationship between the CONNTYPE_TXUSER_VOTER (section 2.2.10.4.1) acceptor states.

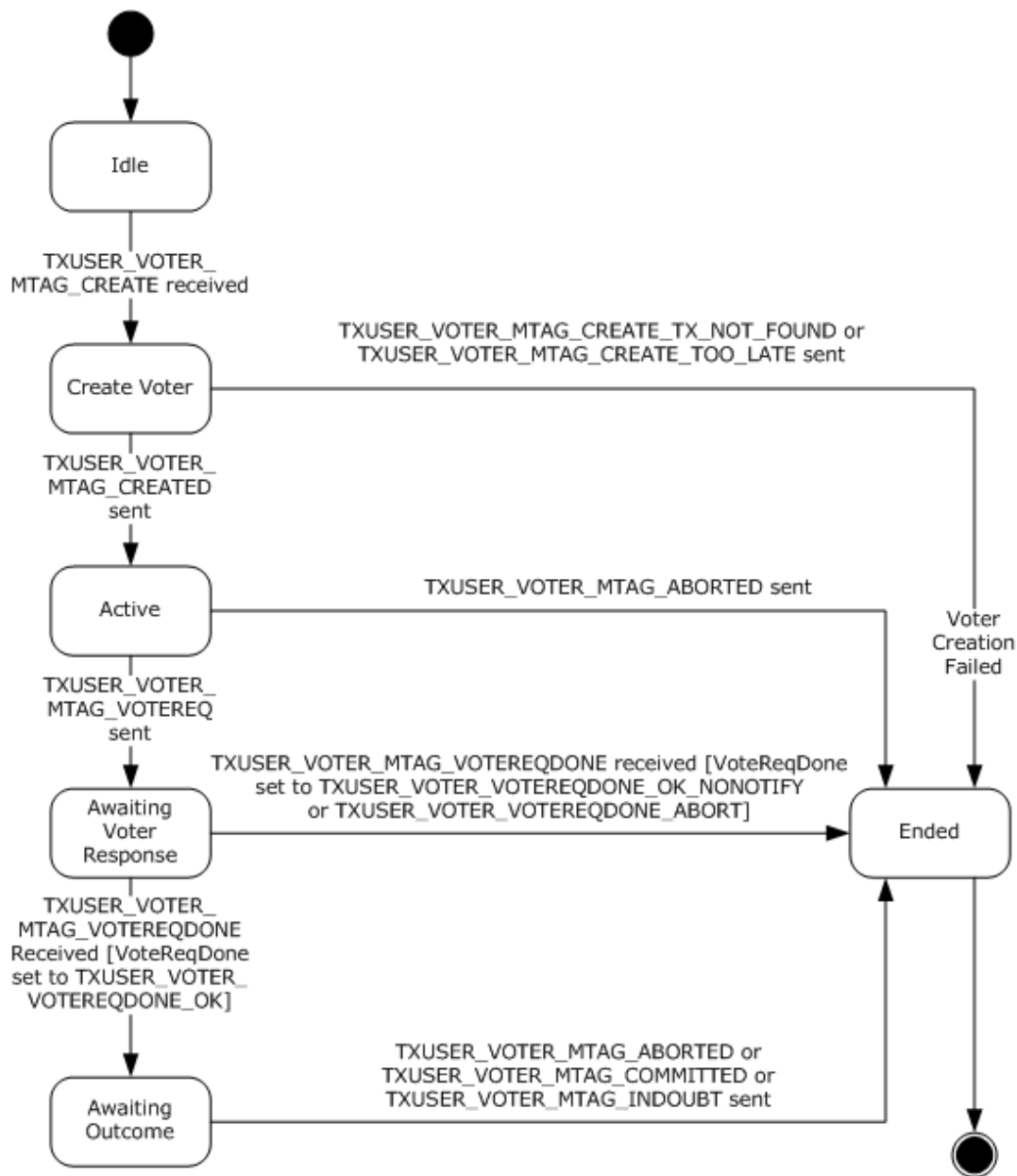

Figure 56: CONNTYPE_TXUSER_VOTER acceptor states

3.6.1.6.1 Idle

This is the initial state. The following event is processed in this state:

- Receiving a TXUSER_VOTER_MTAG_CREATE Message (section 3.6.5.4.1.1)

3.6.1.6.2 Create Voter

The following events are processed in this state:

- Create Voter Enlistment Success (section 3.6.7.13)
- Create Voter Enlistment Failure (section 3.6.7.12)

3.6.1.6.3 Active

The following events are processed in this state:

- Begin Voting (section 3.6.7.6)
- Begin Rollback (section 3.6.7.5)

3.6.1.6.4 Awaiting Voter Response

The following event is processed in this state:

- Receiving a TXUSER_VOTER_MTAG_VOTERREQDONE Message (section 3.6.5.4.1.2)

3.6.1.6.5 Awaiting Outcome

The following events are processed in this state:

- Begin Commit (section 3.6.7.1)
- Begin Rollback (section 3.6.7.5)
- Begin In Doubt (section 3.6.7.2)

3.6.1.6.6 Ended

This is the final state.

3.6.2 Timers

The transaction manager communicating with a resource manager facet **MUST** provide the timer that is shown in the next section.

3.6.2.1 Reenlist Time-Out Timer

The timer **MUST** be set when the transaction manager communicating with a resource manager facet receives a TXUSER_REENLIST_MTAG_REENLIST (section 2.2.10.3.1.1) message on a CONNTYPE_TXUSER_REENLIST (section 2.2.10.3.1) connection. The timer **MUST** be canceled when the CONNTYPE_TXUSER_REENLIST connection is disconnected.

The timer has no default value. The initial value of the timer **MUST** be provided in the TXUSER_REENLIST_MTAG_REENLIST message. The minimum value of the timer **MUST** be zero, which means that the timer never generates a timer event. In this case, the Reenlist Time-Out Timer Event (section 3.6.6.1) is never signaled, and the timeout reply message triggered by this event is never sent.

When the timer is initialized, the transaction manager communicating with a resource manager facet **MUST** provide an Enlistment object to associate with the timer. When the timer expires, the same Enlistment object **MUST** be provided with the timer notification. The transaction manager communicating with a resource manager facet **MUST** provide a distinct Reenlist Timeout timer instance for each CONNTYPE_TXUSER_REENLIST connection.

3.6.3 Initialization

When the transaction manager communicating with a resource manager facet is initialized:

- The transaction manager communicating with a resource manager facet **MUST** examine the following security flags on the Core Transaction Manager Facet (section 1.3.3.3.1) and perform the following actions:
 - If either the Allow Network Access flag or the Allow Remote Clients flag is set to false:
 - For the following connection types, the transaction manager communicating with a resource manager facet **MUST** refuse to accept incoming connections from remote machines as specified in [MS-CMP] section 3.1.5.5 with the rejection **Reason** set to 0x80070005.
 - CONNTYPE_TXUSER_ENLISTMENT (section 2.2.10.2.2)
 - CONNTYPE_TXUSER_RESOURCEMANAGER (section 2.2.10.1.1)
 - CONNTYPE_TXUSER_RESOURCEMANAGERINTERNAL (section 2.2.10.1.2)
 - CONNTYPE_TXUSER_REENLIST (section 2.2.10.3.1)
 - CONNTYPE_TXUSER_VOTER (section 2.2.10.4.1)
 - CONNTYPE_TXUSER_PHASE0 (section 2.2.10.2.1)

All data elements maintained by the transaction manager communicating with a resource manager facet are initialized to an empty value unless stated otherwise in this section or in the initialization sections of the facets the transaction manager communicating with a resource manager facet extends, as described in section 3.6.1.

3.6.4 Higher-Layer Triggered Events

None.

3.6.5 Processing Events and Sequencing Rules

3.6.5.1 Resource Manager Registration

3.6.5.1.1 CONNTYPE_TXUSER_RESOURCEMANAGER as Acceptor

For all messages that are received in this connection type, the transaction manager communicating with a resource manager facet **MUST** process the message as specified in section 3.1. The transaction manager communicating with a resource manager facet **MUST** additionally follow the processing rules as specified in the following sections.

3.6.5.1.1.1 Receiving a TXUSER_RESOURCEMANAGER_MTAG_CREATE Message

When the transaction manager communicating with a resource manager facet receives a TXUSER_RESOURCEMANAGER_MTAG_CREATE (section 2.2.10.1.1.1) message, the transaction manager communicating with a resource manager facet **MUST** perform the following actions:

- If the connection state is Idle:
 - Set the connection state to Creating.
 - Create a resource manager object using the following values:
 - The **guidRM** field from the message as the resource manager identifier.
 - The **guidSession** field from the message as the session identifier of the resource manager.

- The current connection.
- Assign the resource manager object to the Connection-Specific Data field of the connection.
- Signal the Create Resource Manager (section 3.6.7.9) event on the transaction manager communicating with a resource manager facet with the resource manager object.
- Otherwise, the message MUST be processed as an invalid message as specified in section 3.1.6.

3.6.5.1.1.2 Receiving a TXUSER_RESOURCEMANAGER_MTAG_REENLISTMENTCOMPLETE Message

When the transaction manager communicating with a resource manager facet receives a TXUSER_RESOURCEMANAGER_MTAG_REENLISTMENTCOMPLETE (section 2.2.10.1.1.3) message, the transaction manager communicating with a resource manager MUST perform the following actions:

- If the connection state is Reenlisting:
 - Set the connection state to Active.
 - Signal the Reenlist Complete (section 3.6.7.15) event on the transaction manager communicating with a resource manager facet with the resource manager object that is referenced by the Connection-Specific Data field of the connection.
- Otherwise, the message MUST be processed as an invalid message as specified in section 3.1.6.

3.6.5.1.1.3 Connection Disconnected

When a CONNTYPE_TXUSER_RESOURCEMANAGER (section 2.2.10.1.1) connection is disconnected, the transaction manager communicating with a resource manager facet MUST:

- Set the connection state to Ended.
- Signal the Resource Manager Down (section 3.6.7.16) event on the transaction manager communicating with a resource manager facet with the resource manager object referenced by the Connection-Specific Data field of the connection.

3.6.5.1.2 CONNTYPE_TXUSER_RESOURCEMANAGERINTERNAL as Acceptor

For all messages received in this connection type, the transaction manager communicating with a resource manager facet MUST process the message as specified in section 3.1. The transaction manager communicating with a resource manager facet MUST additionally follow the processing rules as specified in the following sections.

3.6.5.1.2.1 Receiving a TXUSER_RESOURCEMANAGER_MTAG_CREATE Message

When the transaction manager communicating with a resource manager facet receives a TXUSER_RESOURCEMANAGER_MTAG_CREATE message, the transaction manager communicating with a resource manager facet MUST perform the following actions:

- If the connection state is Idle:
 - Set the connection state to Creating.
 - Create a resource manager object using the following values:
 - The **guidRM** field from the message as the resource manager identifier.
 - The **guidSession** field from the message as the session identifier of the resource manager.

- This connection.
- Assign the resource manager object to the Connection-Specific Data field of the connection.
- Signal the Create Resource Manager (section 3.6.7.9) event on the transaction manager communicating with a resource manager facet with the resource manager object.
- Otherwise, the message MUST be processed as an invalid message as specified in section 3.1.6.

3.6.5.1.2.2 Receiving a TXUSER_RESOURCEMANAGER_MTAG_REENLISTMENTCOMPLETE Message

When the transaction manager communicating with a resource manager facet receives a TXUSER_RESOURCEMANAGER_MTAG_REENLISTMENTCOMPLETE (section 2.2.10.1.1.3) message, the transaction manager communicating with a resource manager facet MUST perform the following actions:

- If the connection state is Reenlisting:
 - Set the connection state to Active.
 - Signal the Reenlist Complete (section 3.6.7.15) event on the transaction manager communicating with a resource manager facet with the resource manager object that is referenced by the Connection-Specific Data field of the connection.
- Otherwise, the message MUST be processed as an invalid message as specified in section 3.1.6.

3.6.5.1.2.3 Connection Disconnected

When a CONNTYPE_TXUSER_RESOURCEMANAGERINTERNAL (section 2.2.10.1.2) connection is disconnected, the transaction manager communicating with a resource manager facet MUST:

- Set the connection state to Ended.
- Signal the Resource Manager Down (section 3.6.7.16) event on the transaction manager communicating with a resource manager facet with the resource manager object referenced by the Connection-Specific Data field of the connection.

3.6.5.2 Transaction Coordination

3.6.5.2.1 CONNTYPE_TXUSER_PHASE0 as Acceptor

For all messages received in this connection type, the transaction manager communicating with a resource manager facet MUST process the message as specified in section 3.1. The transaction manager communicating with a resource manager facet MUST additionally follow the processing rules as specified in the following sections.

3.6.5.2.1.1 Receiving a TXUSER_PHASE0_MTAG_CREATE Message

When the transaction manager receives a TXUSER_PHASE0_MTAG_CREATE message, the transaction manager communicating with a resource manager facet MUST perform the following actions:

- If the connection state is Idle:
 - Set the connection state to Awaiting Create Response (section 3.6.1.3.2).
 - Find the transaction object in the transaction table of the transaction manager using the **guidTx** field from the message.

- If the transaction is not found:
 - Send a TXUSER_PHASE0_MTAG_CREATE_TX_NOT_FOUND message using the connection.
 - Set the connection state to Ended.
- Otherwise:
 - Create a new Enlistment object with the following values:
 - The transaction manager communicating with a resource manager facet
 - The transaction object
 - The connection
 - Set the **Resource Manager Identifier** field of the Enlistment object to a NULL GUID.
 - Assign the new Enlistment object to the **enlistment** field of the connection.
 - Signal the Create Phase Zero Enlistment event on the Core Transaction Manager Facet with the Enlistment object.
- Otherwise, the message MUST be processed as an invalid message as specified in section 3.1.6.

3.6.5.2.1.2 Receiving a TXUSER_PHASE0_MTAG_PHASE0REQDONE Message

When the transaction manager receives a TXUSER_PHASE0_MTAG_PHASE0REQDONE message, the transaction manager MUST perform the following actions:

- If the connection state is Awaiting Phase Zero Response:
 - Signal the Enlistment Phase Zero Complete event on the Core Transaction Manager Facet with the following arguments:
 - The Enlistment object that is referenced by this connection.
 - The completed outcome value
 - Set the connection state to Ended.
- Otherwise, the message MUST be processed as an invalid message as specified in section 3.1.6.

3.6.5.2.1.3 Receiving a TXUSER_PHASE0_MTAG_UNENLIST Message

When the transaction manager receives a TXUSER_PHASE0_MTAG_UNENLIST (section 2.2.10.2.1.8) message, the transaction manager MUST perform the following actions:

- If the connection state is Active:
 - Signal the Unenlist Phase Zero Enlistment (section 3.2.7.34) event on the Core Transaction Manager Facet (section 1.3.3.3.1) with the Enlistment object that is referenced by this connection.
 - Set the connection state to Ended.
- If the connection state is Awaiting Phase Zero Response:
 - Signal the Enlistment Phase Zero Complete (section 3.2.7.17) event on the Core Transaction Manager Facet with the following arguments:
 - The Enlistment object that is referenced by this connection.

- The completed outcome value.
- Set the connection state to Ended.
- Otherwise, the message MUST be processed as an invalid message as specified in section 3.1.6.

3.6.5.2.1.4 Connection Disconnected

When a CONNTYPE_TXUSER_PHASE0 (section 2.2.10.2.1) connection is disconnected, the transaction manager communicating with a resource manager facet MUST perform the following actions:

- If the connection state is Awaiting Phase Zero Response:
 - Signal the Enlistment Phase Zero Complete (section 3.2.7.17) event on the Core Transaction Manager Facet (section 1.3.3.3.1) with the following arguments:
 - The Enlistment object that is referenced by this connection.
 - The aborted outcome value.
- Otherwise, if the connection state is Active (section 3.6.1.3.3):
 - Signal the Enlistment Unilaterally Aborted (section 3.2.7.19) event on the Core Transaction Manager Facet with the Enlistment object that is referenced by this connection.
- Finally, in all cases, the event MUST be processed as specified in section 3.1.8.3.

3.6.5.2.2 CONNTYPE_TXUSER_ENLISTMENT as Acceptor

For all messages that are received in this connection type, the transaction manager MUST process the message as specified in section 3.1. The transaction manager MUST additionally follow the processing rules as specified in the following sections.

3.6.5.2.2.1 Receiving a TXUSER_ENLISTMENT_MTAG_ENLIST Message

When the transaction manager receives a TXUSER_ENLISTMENT_MTAG_ENLIST message, the transaction manager MUST perform the following actions:

- If the connection state is Idle:
 - Set the connection state to Processing Enlistment Request.
 - Find the transaction object in the transaction table of the transaction manager using the **guidTx** field from the message.
 - If the transaction is not found:
 - Send a TXUSER_ENLIST_MTAG_ENLIST_TX_NOT_FOUND message using the connection.
 - Set the connection state to Ended.
 - Otherwise:
 - Find the resource manager object in the transaction manager's Active Resource Manager table using the **guidRm** field from the message.
 - If the resource manager is not found:
 - Send a TXUSER_ENLIST_MTAG_ENLIST_TOO_LATE message using the connection.
 - Set the connection state to Ended.

- Otherwise:
 - Create a new Enlistment object with the following values:
 - The transaction manager communicating with a resource manager facet
 - The transaction object
 - The connection
 - The **Resource Manager.Identifier** field of the resource manager object
 - Signal the Create Subordinate Enlistment event on the Core Transaction Manager Facet with the new enlistment object.
- Otherwise, the message MUST be processed as an invalid message as specified in section 3.1.6.

3.6.5.2.2.2 Receiving a TXUSER_ENLISTMENT_MTAG_PREPAREREQDONE Message

When the transaction manager receives a TXUSER_ENLISTMENT_MTAG_PREPAREREQDONE (section 2.2.10.2.2.12) message, the transaction manager MUST perform the following actions:

- If the connection state is Awaiting Prepare Response Aborted:
 - If the **prepareReqDone** field of the message is TXUSER_ENLISTMENT_PREPAREREQDONE_OK:
 - Send a TXUSER_ENLISTMENT_MTAG_ABORTREQ (section 2.2.10.2.2.1) message using the connection.
 - Set the connection state to Awaiting Abort Response.
 - Otherwise, set the connection state to Ended.
- If the connection state is Awaiting Single Phase Commit Response:
 - Signal the Enlistment Phase One Complete (section 3.2.7.16) event on the Core Transaction Manager Facet (section 1.3.3.3.1) with the following arguments:
 - The Enlistment object of the connection.
 - The Phase One outcome set to:
 - Committed if the **prepareReqDone** field from the message is TXUSER_ENLISTMENT_PREPAREREQDONE_SINGLEPHASE_COMMIT.
 - Aborted if the **prepareReqDone** field from the message is TXUSER_ENLISTMENT_PREPAREREQDONE_ABORT.
 - Read Only if the **prepareReqDone** field from the message is TXUSER_ENLISTMENT_PREPAREREQDONE_READONLY.
 - Prepared if the **prepareReqDone** field from the message is TXUSER_ENLISTMENT_PREPAREREQDONE_OK.
 - If the **prepareReqDone** field from the message is set to TXUSER_ENLISTMENT_PREPAREREQDONE_OK:
 - Set the connection state to Prepared.
 - Otherwise:

- Set the connection state to Ended.
- If the connection state is Awaiting Prepare Response:
 - Signal the Enlistment Phase One Complete (section 3.2.7.16) event on the Core Transaction Manager Facet with the following arguments:
 - The Enlistment object of the connection.
 - The Phase One outcome set to:
 - Aborted if the **prepareReqDone** field is TXUSER_ENLISTMENT_PREPAREREQDONE_ABORT.
 - Read Only if the **prepareReqDone** field is TXUSER_ENLISTMENT_PREPAREREQDONE_READONLY.
 - Prepared if the **prepareReqDone** field is TXUSER_ENLISTMENT_PREPAREREQDONE_OK.
 - If the **prepareReqDone** field from the message is set to TXUSER_ENLISTMENT_PREPAREREQDONE_OK:
 - Set the connection state to Prepared.
 - Otherwise:
 - Set the connection state to Ended.
- If the connection state is Awaiting Abort Response:
 - Ignore the message.
- Otherwise, the message MUST be processed as an invalid message as specified in section 3.1.6.

3.6.5.2.2.3 Receiving a TXUSER_ENLISTMENT_MTAG_COMMITREQDONE Message

When the transaction manager receives a TXUSER_ENLISTMENT_MTAG_COMMITREQDONE (section 2.2.10.2.2.4) message, the transaction manager MUST perform the following action:

- If the connection state is Awaiting Commit Response:
 - Signal the Enlistment Commit Complete (section 3.2.7.15) event on the Core Transaction Manager Facet (section 1.3.3.3.1) with the Enlistment object of the connection.
 - Set the connection state to Ended.
- Otherwise, the message MUST be processed as an invalid message as specified in section 3.1.6.

3.6.5.2.2.4 Receiving a TXUSER_ENLISTMENT_MTAG_ABORTREQDONE Message

When the transaction manager receives a TXUSER_ENLISTMENT_MTAG_ABORTREQDONE message, the transaction manager MUST perform the following actions:

- If the connection state is Awaiting Abort Response:
 - Signal the Enlistment Rollback Complete event on the Core Transaction Manager Facet with the Enlistment object of the connection.
 - Set the connection state to Ended.

- Otherwise, the message MUST be processed as an invalid message as specified in section 3.1.6.

3.6.5.2.2.5 Connection Disconnected

When a CONNTYPE_TXUSER_ENLISTMENT (section 2.2.10.2.2) connection is disconnected, the transaction manager MUST perform the following actions:

- If the connection state is either Processing Enlistment Request (section 3.6.1.4.2) or Active (section 3.6.1.4.3):
 - Signal the Enlistment Unilaterally Aborted (section 3.2.7.19) event on the Core Transaction Manager Facet (section 1.3.3.3.1) with the Enlistment object of the connection.
- Otherwise, if the connection state is Awaiting Prepare Response (section 3.6.1.4.5):
 - Signal the Enlistment Phase One Complete (section 3.2.7.16) event on the Core Transaction Manager Facet with the following arguments:
 - The Enlistment object of the connection
 - The aborted outcome
- Otherwise, if the connection state is Awaiting Single-Phase Commit Response (section 3.6.1.4.4):
 - Signal the Enlistment Phase One Complete event on the Core Transaction Manager Facet with the following arguments:
 - The Enlistment object of the connection
 - The In Doubt (section 3.2.1.3.12) outcome
- Otherwise, if the connection state is Awaiting Commit Response (section 3.6.1.4.8), the transaction manager MUST perform the following action:
 - Add the Enlistment object of the connection to the **Failed to Notify List** of the transaction manager (section 3.6.1).
- Otherwise, if the connection state is Awaiting Abort Response (section 3.6.1.4.9):
 - Signal the Enlistment Rollback Complete (section 3.2.7.18) event on the Core Transaction Manager Facet with the Enlistment object of the connection.
- Finally, in all cases, the event MUST be processed as specified in section 3.1.8.3.

3.6.5.3 Transaction Recovery

3.6.5.3.1 CONNTYPE_TXUSER_REENLIST as Acceptor

For all messages received in this connection type, the transaction manager communicating with a resource manager facet MUST process the message as specified in section 3.1. The transaction manager communicating with a resource manager facet MUST additionally follow the processing rules as specified in the following sections.

3.6.5.3.1.1 Receiving a TXUSER_REENLIST_MTAG_REENLIST Message

When the transaction manager communicating with a resource manager facet receives a TXUSER_REENLIST_MTAG_REENLIST message, the transaction manager communicating with a resource manager facet MUST perform the following actions:

- If the connection state is Idle:

- Set the connection state to Processing Reenlist Request.
- Look up a resource manager object in the Active Resource Manager table, using the **guidRm** field from the message as the key.
- If the resource manager does not exist:
 - Send a TXUSER_REENLIST_MTAG_REENLIST_ABORTED message using the connection.
 - Set the connection state to Ended.
- Otherwise:
 - Look up a transaction object in the transaction table using the **guidTx** field from the message as the key.
 - If the transaction is not found:
 - Send a TXUSER_REENLIST_MTAG_REENLIST_ABORTED message using the connection.
 - Set the connection state to Ended.
 - Find an Enlistment object in the transaction object's Phase Two Enlistment list whose Resource Manager field matches the resource manager object.
 - If no Enlistment object is found:
 - Send a TXUSER_REENLIST_MTAG_REENLIST_ABORTED message using the connection.
 - Set the connection state to Ended.
 - Otherwise:
 - Initialize the Reenlist Time-out timer providing the following arguments:
 - If the value of the **ulTimeout** field from the message is less than zero:
 - Use a value of zero.
 - Otherwise:
 - Use the **ulTimeout** field from the message.
 - The Enlistment object that is found in the Phase Two enlistment list.
 - Assign the Enlistment object to the **enlistment** field of the connection.
 - Assign the connection object to the **Enlistment Object.Connection** field of the enlistment.
 - Signal the Request Transaction Outcome event on the Core Transaction Manager Facet with the new Enlistment object.
- Otherwise, the message MUST be processed as an invalid message as specified in section 3.1.6.

3.6.5.3.1.2 Connection Disconnected

This event MUST be processed as specified in section 3.1.8.3.

3.6.5.4 Voting

3.6.5.4.1 CONNTYPE_TXUSER_VOTER as Acceptor

For all messages that are received in this connection type, the transaction manager that is communicating with a resource manager facet MUST process the message as specified in section 3.1. The transaction manager communicating with a resource manager facet MUST additionally follow the processing rules as specified in the following sections.

3.6.5.4.1.1 Receiving a TXUSER_VOTER_MTAG_CREATE Message

When the transaction manager communicating with a resource manager facet receives a TXUSER_VOTER_MTAG_CREATE message, it MUST perform the following actions:

- If the connection state is Idle:
 - Set the connection state to Creating Voter.
 - Find the transaction object in the transaction manager's transaction table using the **guidTx** field from the message.
 - If the transaction is not found:
 - Send a TXUSER_VOTER_MTAG_CREATE_TX_NOT_FOUND message using the connection.
 - Set the connection state to Ended.
 - Otherwise:
 - Create a new Enlistment object with the following values:
 - The transaction manager communicating with a resource manager facet
 - The transaction object
 - The connection
 - Set the **Resource Manager Identifier** field of the Enlistment object to aNULL GUID.
 - Assign the new Enlistment object to the **enlistment** field of the connection.
 - Signal the Create Voter Enlistment event on the Core Transaction Manager Facet with the Enlistment object.
- Otherwise, the message MUST be processed as an invalid message as specified in section 3.1.6.

3.6.5.4.1.2 Receiving a TXUSER_VOTER_MTAG_VOTEREQDONE Message

When the transaction manager communicating with a resource manager facet receives a TXUSER_VOTER_MTAG_VOTEREQDONE message, the transaction manager communicating with a resource manager facet MUST perform the following actions:

- If the connection state is Awaiting Voter Response:
 - Set the connection state as follows:
 - If the **VoteReqDone** field from the message is TXUSER_VOTER_VOTEREQDONE_ABORT or TXUSER_VOTER_VOTEREQDONE_OK_NONOTIFY:
 - Set the connection state to Ended.

- Otherwise, If the **VoteReqDone** field from the message is TXUSER_VOTER_VOTEREQDONE_OK:
 - Set the connection state to Awaiting Outcome.
- Otherwise, the message MUST be processed as an invalid message, as specified in section 3.1.6.
- Signal the Enlistment Vote Complete event on the Core Transaction Manager Facet with the following arguments:
 - The Enlistment object that is referenced by this connection.
 - The Vote outcome, which MUST be set to:
 - Prepared if the **VoteReqDone** field from the message is TXUSER_VOTER_VOTEREQDONE_OK.
 - Aborted if the **VoteReqDone** field from the message is TXUSER_VOTER_VOTEREQDONE_ABORT.
 - Read-only if the **VoteReqDone** field from the message is TXUSER_VOTER_VOTEREQDONE_OK_NONOTIFY.
- Otherwise, the message MUST be processed as an invalid message as specified in section 3.1.6.

3.6.5.4.1.3 Connection Disconnected

When a CONNTYPE_TXUSER_VOTER (section 2.2.10.4.1) connection is disconnected, the transaction manager communicating with a resource manager facet MUST perform the following actions:

- If the connection state is either Active (section 3.6.1.6.3) or Awaiting Voter Response:
 - Signal the Enlistment Unilaterally Aborted (section 3.2.7.19) event on the Core Transaction Manager Facet (section 1.3.3.3.1) with the Enlistment object that is referenced by this connection.
- Finally, in all cases, the event MUST be processed as specified in section 3.1.8.3.

3.6.6 Timer Events

3.6.6.1 Reenlist Timeout Timer

When this timer expires, the transaction manager communicating with a resource manager facet MUST perform the following actions:

- Send a TXUSER_REENLIST_MTAG_REENLIST_TIMEOUT (section 2.2.10.3.1.4) message using the connection that is referenced by the provided Enlistment object.
- Set the transaction state to Ended (section 3.2.1.3.14).

3.6.7 Other Local Events

A transaction manager communicating with a resource manager facet MUST be prepared to process the local events that are defined in the following sections.

The transaction manager communicating with a resource manager MUST be prepared to process local events pertaining to Phase Zero functionality only on versions where the connection type

CONNTYPE_TXUSER_PHASE0 is supported. Section 2.2.1.1.3 defines protocol version support for this connection type. The following local events are affected:

- Create Phase Zero Enlistment Success
- Create Phase Zero Enlistment Failure
- Begin Phase Zero
- Phase Zero Aborted

3.6.7.1 Begin Commit

The Begin Commit event MUST be signaled with the following arguments:

- An Enlistment object

If the Begin Commit event is signaled, the transaction manager MUST perform the following actions:

- If the connection of the provided enlistment is of type CONNTYPE_TXUSER_VOTER (section 2.2.10.4.1):
 - Send a TXUSER_STATUS_MTAG_COMMITTED (section 2.2.10.4.1.2) message using the connection.
 - Set the connection state to Ended.
- Otherwise, if the connection of the provided enlistment is of type CONNTYPE_TXUSER_ENLISTMENT (section 2.2.10.2.2):
 - If the connection state is Ended:
 - Add the provided Enlistment object to the **Failed to Notify List** of the transaction manager (section 3.6.1).
 - Otherwise:
 - Send a TXUSER_ENLISTMENT_MTAG_COMMITREQ (section 2.2.10.2.2.3) message using the connection.
 - Set the connection state to Awaiting Commit Response (section 3.6.1.4.8).
- Otherwise, if the connection of the provided enlistment is of type CONNTYPE_TXUSER_REENLIST (section 2.2.10.3.1):
 - If the connection state is Processing Reenlist Request (section 3.6.1.5.2):
 - Send a TXUSER_REENLIST_MTAG_REENLIST_COMMITTED (section 2.2.10.3.1.3) message using the connection.
 - Set the connection state to Ended.
 - Otherwise:
 - Ignore the signal.

3.6.7.2 Begin In Doubt

The Begin In Doubt event MUST be signaled with the following arguments:

- An Enlistment object

If the Begin In Doubt event is signaled, the transaction manager MUST perform the following actions:

- Send a TXUSER_STATUS_MTAG_INDOUBT message using the connection of the provided enlistment.
- Set the connection state to Ended.

3.6.7.3 Begin Phase One

The Begin Phase One event MUST be signaled with the following arguments:

- An Enlistment object
- A Boolean value indicating whether or not the transaction manager communicating with a resource manager facet attempts to make an Enlistment single-phase commit request.

If the Begin Phase One event is signaled, the transaction manager MUST perform the following actions:

- If the connection state of the enlistment is Active:
 - If the provided Single Phase Commit flag (defined in section 3.2.1) is true:
 - Send a TXUSER_ENLISTMENT_MTAG_PREPAREREQ (section 2.2.10.2.2.11) message using the connection of the provided enlistment.
 - The **fSinglePhase** field MUST be set to a nonzero value.
 - Set the **grFRM** field to the **GRFRM** field of the transaction object referenced by the Enlistment object.
 - Set the connection state to Awaiting Single Phase Commit Response.
 - Otherwise:
 - Send a TXUSER_ENLISTMENT_MTAG_PREPAREREQ (section 2.2.10.2.2.11) message using the connection of the provided enlistment.
 - The **fSinglePhase** field MUST be set to 0.
 - Set the **grFRM** field to the **GRFRM** field of the transaction object referenced by the Enlistment object.
 - Set the connection state to Awaiting Prepare Response.
- Otherwise, ignore the event.

3.6.7.4 Begin Phase Zero

The Begin Phase Zero event MUST be signaled with the following arguments:

- An Enlistment object

If the Begin Phase Zero event is signaled, the transaction manager MUST perform the following actions:

- If the connection state is Active:
 - Send a TXUSER_PHASE0_MTAG_PHASE0REQ message using the connection of the provided enlistment.

- Set the connection state to Awaiting Phase Zero Response.
- Otherwise:
 - Ignore the event.

3.6.7.5 Begin Rollback

The Begin Rollback event MUST be signaled with the following arguments:

- An Enlistment object

If the Begin Rollback event is signaled, the transaction manager MUST perform the following actions:

- If the connection of the provided enlistment is of type CONNTYPE_TXUSER_VOTER:
 - Send a TXUSER_STATUS_MTAG_ABORTED message using the connection.
 - Set the connection state to Ended.
- Otherwise, if the connection of the provided enlistment is of type CONNTYPE_TXUSER_ENLISTMENT:
 - If the connection state is Idle:
 - Signal the Enlistment Rollback Complete event on the Core Transaction Manager Facet with the provided Enlistment object.
 - Otherwise:
 - If the connection state is Active or Prepared:
 - Send a TXUSER_ENLISTMENT_MTAG_ABORTREQ message using the connection.
 - Set the connection state to Awaiting Abort Response.
 - Otherwise, if the connection state is Awaiting Prepare Response:
 - Set the connection state to Awaiting Prepare Response Aborted.
- Otherwise, if the connection of the provided enlistment is of type CONNTYPE_TXUSER_REENLIST:
 - If the connection state is Processing Reenlist Request:
 - Send a TXUSER_REENLIST_MTAG_REENLIST_ABORTED message using the connection.
 - Set the connection state to Ended.
 - Otherwise, ignore the signal.

3.6.7.6 Begin Voting

The Begin Voting event MUST be signaled with the following arguments:

- An Enlistment object

If the Begin Voting event is signaled, the transaction manager MUST perform the following actions:

- If the connection state is Active:

- Send a TXUSER_VOTER_MTAG_VOTEREQ message using the connection of the provided enlistment.
- Set the connection state to Awaiting Voter Response.
- Otherwise, ignore the event.

3.6.7.7 Create Phase Zero Enlistment Failure

The Create Phase Zero Enlistment Failure event MUST be signaled with the following arguments:

- An Enlistment object.
- A value indicating the failure reason. The reason MUST be set to one of the following values:
 - Too Late
 - Tx Not Found

If the Create Phase Zero Enlistment Failure event is signaled, the transaction manager MUST perform the following actions:

- If the connection state is Awaiting Create Response (section 3.6.1.3.2):
 - Send the matching message for the following reason codes using the connection of the provided enlistment:
 - Too Late: TXUSER_PHASE0_MTAG_CREATE_TOO_LATE (section 2.2.10.2.1.2).
 - Tx Not Found: TXUSER_PHASE0_MTAG_CREATE_TX_NOT_FOUND (section 2.2.10.2.1.3)
 - Set the connection state to Ended.
- Otherwise, ignore the event.

3.6.7.8 Create Phase Zero Enlistment Success

The Create Phase Zero Enlistment Success event MUST be signaled with the following arguments:

- An Enlistment object

If the Create Phase Zero Enlistment Success event is signaled, the transaction manager MUST perform the following actions:

- If the connection state is Awaiting Create Response (section 3.6.1.3.2):
 - Send a TXUSER_PHASE0_MTAG_CREATED message using the connection of the provided enlistment.
 - Set the connection state to Active.
- Otherwise, ignore the event.

3.6.7.9 Create Resource Manager

The Create Resource Manager event MUST be signaled with the following arguments:

- A resource manager object

If the Create Resource Manager event is signaled, the transaction manager communicating with a resource manager facet MUST perform the following actions:

- Search for a resource manager object in the transaction manager's Active Resource Manager table with the same resource manager identifier as the provided resource manager object.
- If such a resource manager object is found in the table:
 - If the connection object that is referenced by the found resource manager object is of type CONNTYPE_TXUSER_RESOURCEMANAGERINTERNAL (section 2.2.10.1.2):
 - If the connection state of the found resource manager object is either Reenlisting or Active:
 - Send a TXUSER_RESOURCEMANAGERINTERNAL_MTAG_DUPLICATEDETECTED (section 2.2.10.1.2.1) message using the connection object that is referenced by the found resource manager object.
 - Send a TXUSER_RESOURCEMANAGER_MTAG_DUPLICATE (section 2.2.10.1.1.2) message using the connection object that is referenced by the provided resource manager object. Set the state of the connection object that referenced the provided resource manager object to Ended.
 - Set the state of the connection object that referenced the provided resource manager object to Ended.
 - Otherwise,
 - Send a TXUSER_RESOURCEMANAGER_MTAG_DUPLICATE (section 2.2.10.1.1.2) message using the connection object that is referenced by the provided resource manager object.
 - Set the state of the connection object that referenced the provided resource manager object to Ended.
 - Otherwise
 - If the connection state is Creating:
 - Add the provided resource manager object to the Active Resource Manager table, using the resource manager identifier field as the key.
 - Send a TXUSER_RESOURCEMANAGER_MTAG_REQUEST_COMPLETE (section 2.2.10.1.1.4) message using the connection.
 - Set the connection state to Reenlisting.

3.6.7.10 Create Subordinate Enlistment Failure

The Create Subordinate Enlistment Failure event MUST be signaled with the following arguments:

- An Enlistment object.
- A value indicating the failure reason. The reason MUST be set to one of the following values:
 - Log Full
 - Too Late
 - Too Many

If the Create Subordinate Enlistment Failure event is signaled, the transaction manager MUST perform the following actions:

- If the connection state is Processing Enlistment Request:
 - Send the matching message for the following reason codes using the connection of the provided enlistment:
 - Log Full: TXUSER_ENLISTMENT_MTAG_ENLIST_LOG_FULL
 - Too Late: TXUSER_ENLISTMENT_MTAG_ENLIST_TOO_LATE
 - Too Many: TXUSER_ENLISTMENT_MTAG_ENLIST_TOO_MANY
 - Set the connection state to Ended.
- Otherwise, ignore the event.

3.6.7.11 Create Subordinate Enlistment Success

The Create Subordinate Enlistment Success event MUST be signaled with the following arguments:

- An Enlistment object

If the Create Subordinate Enlistment Success event is signaled, the transaction manager MUST perform the following actions:

- If the connection state is Processing Enlistment Request:
 - Send a TXUSER_ENLISTMENT_MTAG_ENLISTED message using the connection of the provided enlistment.
 - Set the connection state to Active.
- Otherwise, ignore the event.

3.6.7.12 Create Voter Enlistment Failure

The Create Voter Enlistment Failure event MUST be signaled with the following arguments:

- An Enlistment object
- A value indicating the failure reason. The reason MUST be set to the following value:
 - Too Late

If the Create Voter Enlistment Failure event is signaled, the transaction manager MUST perform the following actions:

- If the connection state is Creating Voter:
 - Send the TXUSER_VOTER_MTAG_CREATE_TOO_LATE (section 2.2.10.4.1.5) message using the connection of the provided enlistment:
 - Set the connection state to Ended.
- Otherwise, ignore the event.

3.6.7.13 Create Voter Enlistment Success

The Create Voter Enlistment Success event MUST be signaled with the following arguments:

- An Enlistment object

If the Create Voter Enlistment Success event is signaled, the Transaction Manager MUST perform the following actions:

- If the connection state is Creating Voter:
 - Send a TXUSER_VOTER_MTAG_CREATED (section 2.2.10.4.1.7) message using the connection of the provided enlistment.
 - Set the connection state to Active.
- Otherwise, ignore the event.

3.6.7.14 Phase Zero Aborted

The Phase Zero Aborted event MUST be signaled with the following arguments:

- An Enlistment object

If the Phase Zero Aborted event is signaled, the transaction manager MUST perform the following actions:

- If the connection state is Active:
 - Send a TXUSER_PHASE0_MTAG_PHASE0REQ_ABORT message using the connection of the provided enlistment.
 - Set the connection state to ended.
- Otherwise, ignore the event.

3.6.7.15 Reenlist Complete

The Reenlist Complete event MUST be signaled with the following arguments:

- A resource manager object

If the Reenlist Complete event is signaled, the transaction manager communicating with a resource manager facet MUST perform the following actions:

- For each enlistment in the **Failed to Notify List** of the transaction manager (section 3.6.1):
 - If the **Resource Manager Identifier** field of the Enlistment object matches the provided **Resource Manager Object.Identifier** field:
 - Signal the Enlistment Commit Complete event on the Core Transaction Manager Facet providing the Enlistment object.
 - Remove the Enlistment object from the **Failed to Notify List**.
- Send a TXUSER_RESOURCEMANAGER_MTAG_REQUEST_COMPLETE message using the connection of the provided resource manager.
- Set the connection state to Reenlisting.

3.6.7.16 Resource Manager Down

The Resource Manager Down event MUST be signaled with the following arguments:

- A resource manager object

If the Resource Manager Down event is signaled, the transaction manager communicating with a resource manager facet MUST perform the following actions:

- For each enlistment in the **Failed to Notify List** of the transaction manager (section 3.6.1):
 - If the Enlistment object's **Resource Manager Identifier** field matches the provided resource manager object's **Resource Manager Object.Identifier** field:
 - Set the state of the connection object referenced by the Enlistment object to Ended.
- Search for a resource manager object in the manager's **Active Resource Manager Table** with the same resource manager identifier as the provided resource manager object.
- If such a resource manager object is found in the table, remove the resource manager object from the table.

3.7 Superior Transaction Manager Facet Details

3.7.1 Abstract Data Model

This section describes a conceptual model of possible data organization that an implementation maintains to participate in this protocol. The described organization is provided to facilitate the explanation of how the protocol behaves. This document does not mandate that implementations adhere to this model as long as their external behavior is consistent with that described in this document.

Note that the abstract data model can be implemented in a variety of ways. This protocol does not prescribe or advocate any specific implementation technique.

The superior transaction manager facet MUST maintain all the data elements that are specified in sections 3.1.1 and 3.2.1.

The Superior Transaction Manager facet MUST also maintain the following data elements:

Enlistment objects that are created by the superior transaction manager facet MUST provide the following properties as specified in 3.1.1:

- **Name:** The Hostname field in the Enlistment object's connection object
- **Enlistment Object.Identifier:** An empty string

The superior transaction manager MUST provide the states that are defined in the following sections for its supported connection types. Version-Specific Aspects of Connection Types Relevant to a Transaction Manager (section 2.2.1.1.2) defines the connection types that a superior transaction manager MUST provide for each supported protocol version.

3.7.1.1 CONNTYPE_PARTNERTM_PROPAGATE Initiator States

The superior transaction manager MUST act as an initiator for the CONNTYPE_PARTNERTM_PROPAGATE (section 2.2.9.1.1.1) connection type. In this role, the superior transaction manager MUST provide support for the states in this section:

- Idle (section 3.7.1.1.1)

- Awaiting Propagation Response (section 3.7.1.1.2)
- Active (section 3.7.1.1.3)
- Awaiting Abort Response (section 3.7.1.1.4)
- Phase Zero Registration (section 3.7.1.1.5)
- Requesting Phase Zero (section 3.7.1.1.6)
- Phase Zero (section 3.7.1.1.7)
- Phase Zero Registration During Phase Zero (section 3.7.1.1.8)
- Phase Zero with Outstanding Registration (section 3.7.1.1.9)
- Awaiting Prepare Response (section 3.7.1.1.10)
- Prepared (section 3.7.1.1.11)
- Awaiting Commit Response (section 3.7.1.1.12)
- Ended (section 3.7.1.1.13)

The following illustration shows the relationship between the CONNTYPE_PARTNERTM_PROPAGATE initiator states.

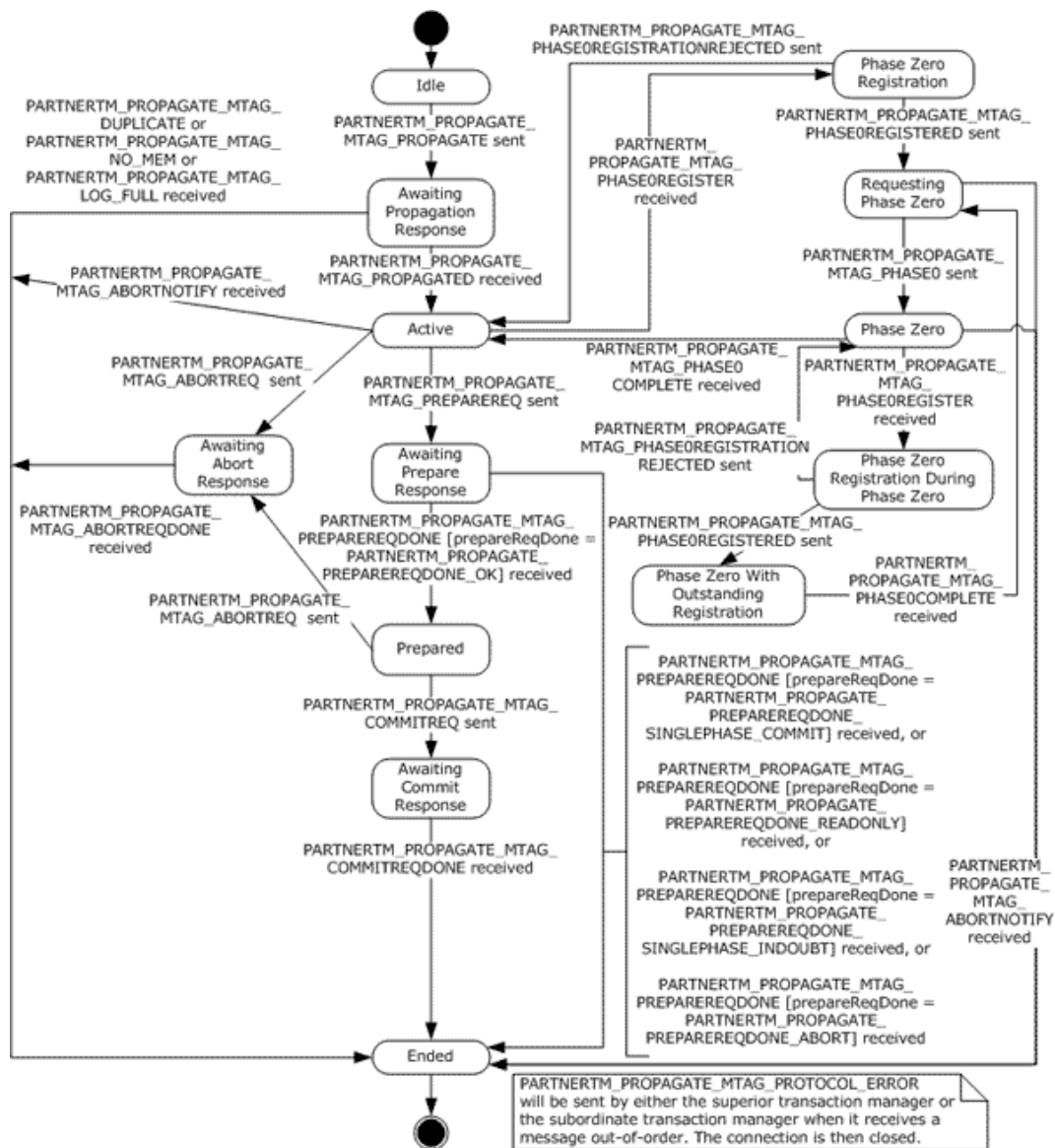

Figure 57: CONNTYPE_PARTNERTM_PROPAGATE initiator states

3.7.1.1.1 Idle

This is the initial state. The following event is processed in this state:

- Propagate Transaction (section 3.7.7.10)

3.7.1.1.2 Awaiting Propagation Response

The following events are processed in this state:

- Receiving a PARTNERTM_PROPAGATE_MTAG_PROPAGATED Message (section 3.7.5.1.1.1.1)
- Receiving a PARTNERTM_PROPAGATE_MTAG_DUPLICATE, PARTNERTM_PROPAGATE_MTAG_NO_MEM, or PARTNERTM_PROPAGATE_MTAG_LOG_FULL Message (section 3.7.5.1.1.1.2)

3.7.1.1.3 Active

The following events are processed in this state:

- Receiving PARTNERTM_PROPAGATE_MTAG_PHASE0REGISTER (section 3.7.5.1.1.1.3)
- Receiving PARTNERTM_PROPAGATE_MTAG_ABORTNOTIFY (section 3.7.5.1.1.1.4)
- Begin Phase One (section 3.7.7.2).
- Begin Rollback (section 3.7.7.4)

3.7.1.1.4 Awaiting Abort Response

The following event is processed in this state:

- Receiving PARTNERTM_PROPAGATE_MTAG_ABORTREQDONE (section 3.7.5.1.1.1.3)

3.7.1.1.5 Phase Zero Registration

The following events are processed in this state:

- Create Phase Zero Enlistment Success (section 3.7.7.6)
- Create Phase Zero Enlistment Failure (section 3.7.7.5)

3.7.1.1.6 Requesting Phase Zero

The following events are processed in this state:

- Receiving PARTNERTM_PROPAGATE_MTAG_ABORTNOTIFY (section 3.7.5.1.1.1.3)
- Begin Phase Zero (section 3.7.7.3)
- Receiving PARTNERTM_PROPAGATE_MTAG_PROTOCOL_ERROR (section 3.7.5.1.1.1.4)

3.7.1.1.7 Phase Zero

The following events are processed in this state:

- Receiving a PARTNERTM_PROPAGATE_MTAG_PHASE0COMPLETE (section 3.7.5.1.1.1.3)
- Receiving a PARTNERTM_PROPAGATE_MTAG_PHASE0REGISTER (section 3.7.5.1.1.1.3)
- Receiving a PARTNERTM_PROPAGATE_MTAG_PROTOCOL_ERROR (section 3.7.5.1.1.1.4)
- Receiving a PARTNERTM_PROPAGATE_MTAG_ABORTNOTIFY (section 3.7.5.1.1.1.3)

3.7.1.1.8 Phase Zero Registration During Phase Zero

The following events are processed in this state:

- Create Phase Zero Enlistment Success (section 3.7.7.6)
- Create Phase Zero Enlistment Failure (section 3.7.7.5)

3.7.1.1.9 Phase Zero with Outstanding Registration

The following events are processed in this state:

- Receiving PARTNERTM_PROPAGATE_MTAG_PHASE0COMPLETE (section 3.7.5.1.1.1.3).

- Receiving PARTNERTM_PROPAGATE_MTAG_PROTOCOL_ERROR (section 3.7.5.1.1.1.4)

3.7.1.1.10 Awaiting Prepare Response

The following events are processed in this state:

- Receiving PARTNERTM_PROPAGATE_MTAG_PREPAREREQDONE (section 3.7.5.1.1.1.3)
- Receiving PARTNERTM_PROPAGATE_MTAG_PROTOCOL_ERROR (section 3.7.5.1.1.1.4)

3.7.1.1.11 Prepared

The following events are processed in this state:

- Begin Commit (section 3.7.7.1)
- Begin Rollback (section 3.7.7.4)

3.7.1.1.12 Awaiting Commit Response

The following events are processed in this state:

- Receiving PARTNERTM_PROPAGATE_MTAG_COMMITREQDONE (section 3.7.5.1.1.1.3)
- Receiving PARTNERTM_PROPAGATE_MTAG_PROTOCOL_ERROR (section 3.7.5.1.1.1.4)

3.7.1.1.13 Ended

This is the final state.

3.7.1.2 CONNTYPE_PARTNERTM_BRANCH Acceptor States

The superior transaction manager MUST act as an acceptor for the CONNTYPE_PARTNERTM_BRANCH (section 2.2.9.1.2.1) connection type. In this role, the superior transaction manager MUST provide support for the states in this section.

The following figure shows the relationship between the CONNTYPE_PARTNERTM_BRANCH acceptor states.

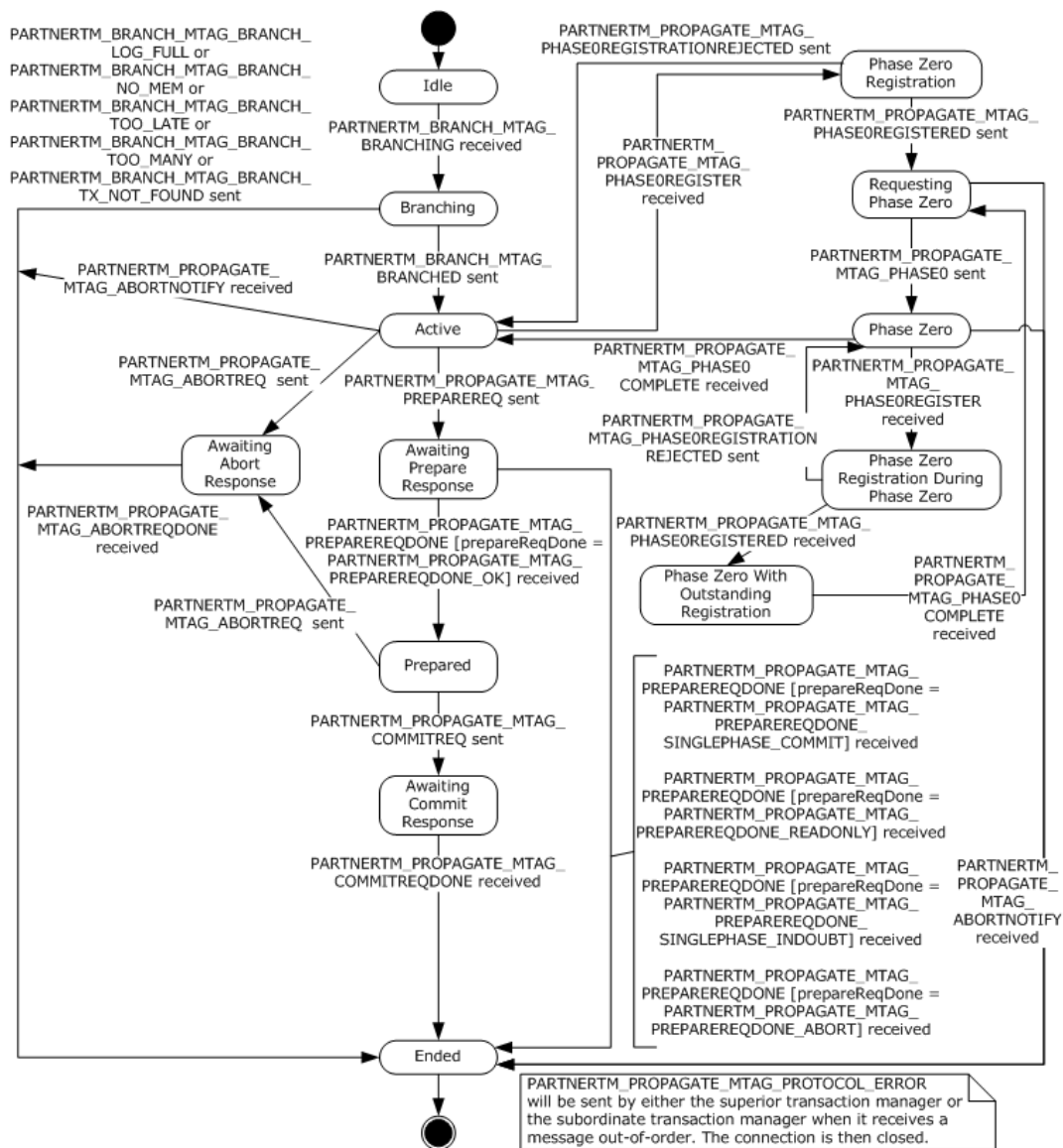

Figure 58: CONNTYPE_PARTNERTM_BRANCH acceptor states

3.7.1.2.1 Idle

This is the initial state. The following event is processed in this state:

- Receiving PARTNERTM_BRANCH_MTAG_BRANCHING (section 3.7.5.1.2.1.1).

3.7.1.2.2 Branching

The following events are processed in this state:

- Create Subordinate Enlistment Success (section 3.7.7.8)
- Create Subordinate Enlistment Failure (section 3.7.7.7)

3.7.1.2.3 Active

The following events are processed in this state:

- Receiving PARTNERTM_PROPAGATE_MTAG_PHASE0REGISTER (section 3.7.5.1.2.1.2)
- Receiving PARTNERTM_PROPAGATE_MTAG_ABORTNOTIFY (section 3.7.5.1.2.1.4)
- Begin Phase One (section 3.7.7.2)
- Begin Rollback (section 3.7.7.4).

3.7.1.2.4 Awaiting Abort Response

The following event is processed in this state:

- Receiving PARTNERTM_PROPAGATE_MTAG_ABORTREQDONE (section 3.7.5.1.2.1.5)

3.7.1.2.5 Phase Zero Registration

The following events are processed in this state:

- Create Phase Zero Enlistment Success (section 3.7.7.6)
- Create Phase Zero Enlistment Failure (section 3.7.7.5)

3.7.1.2.6 Requesting Phase Zero

The following events are processed in this state:

- Receiving PARTNERTM_PROPAGATE_MTAG_ABORTNOTIFY (section 3.7.5.1.2.1.4)
- Begin Phase Zero (section 3.7.7.3)
- Receiving PARTNERTM_PROPAGATE_MTAG_PROTOCOL_ERROR (section 3.7.5.1.2.1.8)

3.7.1.2.7 Phase Zero

The following events are processed in this state:

- Receiving PARTNERTM_PROPAGATE_MTAG_PHASE0COMPLETE (section 3.7.5.1.2.1.3)
- Receiving PARTNERTM_PROPAGATE_MTAG_PHASE0REGISTER (section 3.7.5.1.2.1.2)
- Receiving PARTNERTM_PROPAGATE_MTAG_PROTOCOL_ERROR (section 3.7.5.1.2.1.8)
- Receiving PARTNERTM_PROPAGATE_MTAG_ABORTNOTIFY (section 3.7.5.1.2.1.4)

3.7.1.2.8 Phase Zero Registration During Phase Zero

The following events are processed in this state:

- Create Phase Zero Enlistment Success (section 3.7.7.6)
- Create Phase Zero Enlistment Failure (section 3.7.7.5)

3.7.1.2.9 Phase Zero with Outstanding Registration

The following events are processed in this state:

- Receiving PARTNERTM_PROPAGATE_MTAG_PHASE0COMPLETE (section 3.7.5.1.2.1.3)
- Receiving PARTNERTM_PROPAGATE_MTAG_PROTOCOL_ERROR (section 3.7.5.1.2.1.8)

3.7.1.2.10 Awaiting Prepare Response

The following events are processed in this state:

- Receiving PARTNERTM_PROPAGATE_MTAG_PREPAREREQDONE (section 3.7.5.1.2.1.6)
- Receiving PARTNERTM_PROPAGATE_MTAG_PROTOCOL_ERROR (section 3.7.5.1.2.1.8)

3.7.1.2.11 Prepared

The following events are processed in this state:

- Begin Commit (section 3.7.7.1)
- Begin Rollback (section 3.7.7.4)

3.7.1.2.12 Awaiting Commit Response

The following events are processed in this state:

- Receiving a PARTNERTM_PROPAGATE_MTAG_COMMITREQDONE (section 3.7.5.1.2.1.7)
- Receiving a PARTNERTM_PROPAGATE_MTAG_PROTOCOL_ERROR (section 3.7.5.1.2.1.8)

3.7.1.2.13 Ended

This is the final state.

3.7.1.3 CONNTYPE_PARTNERTM_REDELIVERCOMMIT Initiator States

The superior transaction manager **MUST** act as an initiator for the CONNTYPE_PARTNERTM_REDELIVERCOMMIT connection type. In this role, the superior transaction manager **MUST** provide support for the states in this section.

The following figure shows the relationship between the CONNTYPE_PARTNERTM_REDELIVERCOMMIT initiator states.

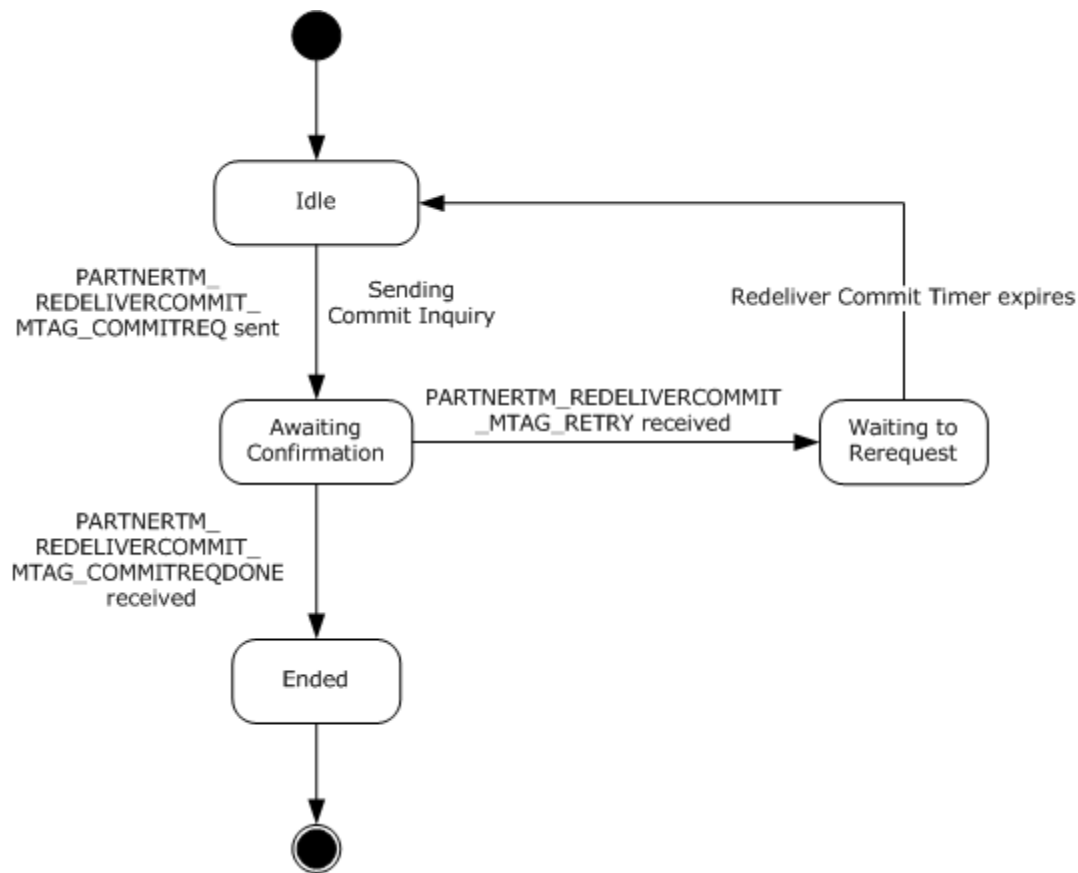

Figure 59: CONNTYPE_PARTNERTM_REDELIVERCOMMIT initiator states

3.7.1.3.1 Idle

This is the initial state. The following event is processed in this state:

- Begin Commit (section 3.7.7.1)

3.7.1.3.2 Awaiting Confirmation

The following events are processed in this state:

- Receiving a PARTNERTM_REDELIVERCOMMIT_MTAG_COMMITREQDONE (section 3.7.5.1.2.1.7)
- Receiving a PARTNERTM_REDELIVERCOMMIT_MTAG_RETRY Message (section 3.7.5.2.2.1.2)

3.7.1.3.3 Waiting to Rerequest

The following event is processed in this state:

- Redeliver Commit Timer (section 3.7.6.1)

3.7.1.3.4 Ended

This is the final state.

3.7.1.4 CONNTYPE_PARTNERTM_CHECKABORT Acceptor States

The superior transaction manager MUST act as an acceptor for the CONNTYPE_PARTNERTM_CHECKABORT (section 2.2.9.2.1.1) connection type. In this role, the superior transaction manager MUST provide support for the states in this section.

The following figure shows the relationship between the CONNTYPE_PARTNERTM_CHECKABORT acceptor states.

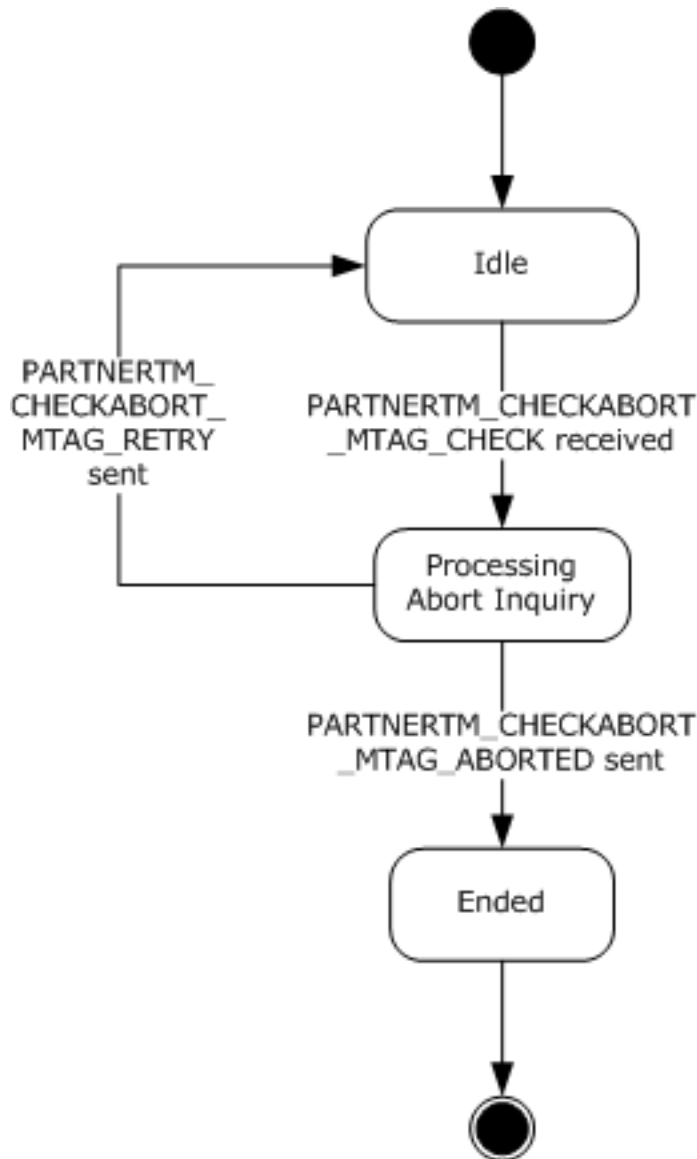

Figure 60: CONNTYPE_PARTNERTM_CHECKABORT acceptor states

3.7.1.4.1 Idle

This is the initial state. The following event is processed in this state:

- Receiving a PARTNERTM_CHECKABORT_MTAG_CHECK Message (section 3.7.5.2.1.1.1)

3.7.1.4.2 Processing Abort Inquiry

This is a transient state that is assumed during the processing of a request for check abort. No specific events are processed in this state.

3.7.1.4.3 Ended

This is the final state.

3.7.2 Timers

The superior transaction manager facet MUST provide the following Redeliver Commit Timer.

3.7.2.1 Redeliver Commit Timer

This timer MUST be set when the Superior Transaction Manager Facet (section 1.3.3.3.4) receives a PARTNERTM_REDELIVERCOMMIT_MTAG_RETRY (section 2.2.9.2.2.1.3) message on a CONNTYPE_PARTNERTM_REDELIVERCOMMIT (section 2.2.9.2.2.1) connection. The timer MUST be canceled when the CONNTYPE_PARTNERTM_REDELIVERCOMMIT (section 2.2.9.2.2.1) connection is disconnected.

The default value of the timer is implementation-specific.<36>

When the timer is initialized, the Superior Transaction Manager Facet (section 1.3.3.3.4) MUST provide an Enlistment object to associate with the timer. When the timer expires, the same Enlistment object MUST be provided alongside the timer notification. The Superior Transaction Manager Facet MUST provide a distinct Redeliver Commit Timer (section 3.7.2.1) instance for each CONNTYPE_PARTNERTM_REDELIVERCOMMIT connection.

3.7.3 Initialization

When the superior transaction manager facet is initialized:

- The superior transaction manager facet MUST examine the following security flags on the core transaction manager and perform the following actions:
 - If one of the Allow Network Access, Allow Network Transactions, or Allow Outbound Transactions flags is set to false:
 - For the following connection type, the superior transaction manager MUST refuse to accept incoming connections from remote machines as specified in [MS-CMP] (section 3.1.5.5) with the rejection Reason set to 0x80070005:
 - CONNTYPE_PARTNERTM_BRANCH (section 2.2.9.1.2.1)
 - If one of the Allow Network Access or Allow Network Transactions flags is set to false, or if both the Allow Inbound Transactions and Allow Outbound Transactions flags are set to false:
 - For the following connection type, the superior transaction manager MUST refuse to accept incoming connections from remote machines as specified in [MS-CMP] (section 3.1.5.5) with the rejection Reason set to 0x80070005:
 - CONNTYPE_PARTNERTM_CHECKABORT (section 2.2.9.2.1.1)

3.7.4 Higher-Layer Triggered Events

No higher-layer triggered events apply.

3.7.5 Processing Events and Sequencing Rules

3.7.5.1 Transaction Propagation and Coordination

3.7.5.1.1 Push Propagation

3.7.5.1.1.1 CONNTYPE_PARTNERTM_PROPAGATE as Initiator

For all messages that are received in this connection type, the superior transaction manager MUST process the message as specified in section 3.1.

Also, for incoming messages, the superior transaction manager MUST override the verification actions of the default state as specified in section 3.1 in the following manner:

- If the current connection state does not define a processing rule for the message:
 - Send a PARTNERTM_PROPAGATE_MTAG_PROTOCOL_ERROR message using the connection.
 - Perform default invalid message processing, as specified in section 3.1.

The superior transaction manager MUST also follow the processing rules that are specified in the following sections.

3.7.5.1.1.1.1 Receiving a PARTNERTM_PROPAGATE_MTAG_PROPAGATED Message

When the superior transaction manager receives a PARTNERTM_PROPAGATE_MTAG_PROPAGATED (section 2.2.9.1.1.1.2) message, the superior transaction manager MUST perform the following actions:

- If the connection state is Awaiting Propagation Response:
 - Set the connection state to Active (section 3.7.1.1.3).
 - Create an Enlistment object with the following values:
 - The Superior Transaction Manager Facet (section 1.3.3.3.4)
 - The transaction object referenced by this connection
 - This connection object
 - Signal the Propagate Transaction Success (section 3.2.7.27) event on the Core Transaction Manager Facet (section 1.3.3.3.1) with the created enlistment object.
- Otherwise, the message MUST be processed as an invalid message as specified in section 3.1.6.

3.7.5.1.1.1.2 Receiving a PARTNERTM_PROPAGATE_MTAG_DUPLICATE, PARTNERTM_PROPAGATE_MTAG_NO_MEM, or PARTNERTM_PROPAGATE_MTAG_LOG_FULL Message

When the Superior Transaction Manager Facet receives a PARTNERTM_PROPAGATE_MTAG_DUPLICATE, PARTNERTM_PROPAGATE_MTAG_NO_MEM, or PARTNERTM_PROPAGATE_MTAG_LOG_FULL message, the superior transaction manager MUST perform the following actions:

- If the connection state is Awaiting Propagation Response:
 - Create an Enlistment object with the following values:

- The Superior Transaction Manager Facet
- The transaction object that is referenced by this connection
- This connection object
- Signal the Propagate Transaction Failure event on the Core Transaction Manager Facet with the following arguments:
 - The created Enlistment object
 - The failure code that matches the incoming message:
 - PARTNERTM_PROPAGATE_MTAG_DUPLICATE: Duplicate
 - PARTNERTM_PROPAGATE_MTAG_NO_MEM: No Mem
 - PARTNERTM_PROPAGATE_MTAG_LOG_FULL: Log Full
 - Set the connection state to Ended.
- Otherwise, the message MUST be processed as an invalid message as specified in section 3.1.6.

3.7.5.1.1.1.3 Receiving a PARTNERTM_PROPAGATE_MTAG_PHASE0REGISTER, PARTNERTM_PROPAGATE_MTAG_PHASE0COMPLETE, PARTNERTM_PROPAGATE_MTAG_PREPAREREQDONE, PARTNERTM_PROPAGATE_MTAG_COMMITREQDONE, PARTNERTM_PROPAGATE_MTAG_ABORTREQDONE, or PARTNERTM_PROPAGATE_MTAG_ABORTNOTIFY Message

When the superior transaction manager facet receives one of these messages, it MUST follow the same message processing rules as the CONNTYPE_PARTNERTM_BRANCH connection type acting as an acceptor. See section 3.7.5.1.2.1 for more information.

3.7.5.1.1.1.4 Receiving a PARTNERTM_PROPAGATE_MTAG_PROTOCOL_ERROR Message

The processing of this event MUST be identical to the processing of the Connection Disconnected event.

3.7.5.1.1.1.5 Connection Disconnected

When a CONNTYPE_PARTNERTM_PROPAGATE (section 2.2.9.1.1.1) connection is disconnected, the Superior Transaction Manager Facet (section 1.3.3.3.4) MUST perform the following actions:

- If the connection state is Awaiting Propagation Response:
 - Create an Enlistment object with the following values:
 - The Superior Transaction Manager Facet
 - The transaction object that is referenced by this connection
 - This connection object
 - Signal the Propagate Transaction Failure (section 3.2.7.26) event on the Core Transaction Manager Facet with the following arguments:
 - The created Enlistment object

- A failure code of Comm Failed.
- Set the connection state to Ended.
- Otherwise:
 - The Superior Transaction Manager Facet (section 1.3.3.3.4) MUST perform the same actions as the CONNTYPE_PARTNERTM_BRANCH (section 2.2.9.1.2.1) connection type acting as an acceptor. For more information, see section 3.7.5.1.2.1.

3.7.5.1.2 Pull Propagation

3.7.5.1.2.1 CONNTYPE_PARTNERTM_BRANCH as Acceptor

For all messages that are received in this connection type, the superior transaction manager MUST process the message as specified in section 3.1.

Also, for incoming messages, the superior transaction manager MUST override the verification actions of the default state, as specified in section 3.1.6, in the following manner:

- If the current connection state does not define a processing rule for the message:
 - Send a PARTNERTM_PROPAGATE_MTAG_PROTOCOL_ERROR message using the connection.
 - Perform default invalid message processing, as specified in section 3.1.6.

The superior transaction manager MUST also follow the processing rules as specified in the following section.

3.7.5.1.2.1.1 Receiving a PARTNERTM_BRANCH_MTAG_BRANCHING Message

When the superior transaction manager receives a PARTNERTM_BRANCH_MTAG_BRANCHING message, the superior transaction manager MUST perform the following actions:

- If the connection state is Idle:
 - Set the connection state to Branching.
 - Find the transaction object in the transaction table of the transaction manager using the **guidTx** field from the message as the key.
 - If a transaction object is found:
 - Create a new Enlistment object with the following values:
 - The Superior Transaction Manager Facet
 - The transaction object
 - The connection object
 - Set the **enlistment** field of the connection to the new Enlistment object.
 - Signal the Create Subordinate Enlistment event on the Core Transaction Manager Facet with the new Enlistment object.
 - Otherwise:
 - Send a PARTNERTM_BRANCH_MTAG_BRANCH_TX_NOT_FOUND message using the connection.

- Set the connection state to Ended.
- Otherwise, the message MUST be processed as an invalid message as specified in section 3.1.6.

3.7.5.1.2.1.2 Receiving a PARTNERTM_PROPAGATE_MTAG_PHASE0REGISTER Message

When the superior transaction manager receives a PARTNERTM_PROPAGATE_MTAG_PHASE0REGISTER (section 2.2.9.1.1.1.14) message, the superior transaction manager MUST perform the following actions:

- If the connection state is Active:
 - Set the connection state to Phase Zero Registration.
 - Signal the Create Phase Zero Enlistment (section 3.2.7.10) event on the Core Transaction Manager Facet (section 1.3.3.3.1) with the Enlistment object that is referenced by this connection.
- Otherwise, if the connection state is Phase Zero:
 - Set the connection state to Phase Zero Registration During Phase Zero.
 - Signal the Create Phase Zero Enlistment event on the Core Transaction Manager Facet with the Enlistment object that is referenced by this connection.
- Otherwise, the message MUST be processed as an invalid message as specified in section 3.1.6.

3.7.5.1.2.1.3 Receiving a PARTNERTM_PROPAGATE_MTAG_PHASE0COMPLETE Message

When the superior transaction manager receives a PARTNERTM_PROPAGATE_MTAG_PHASE0COMPLETE message, the superior transaction manager MUST perform the following actions:

- If the connection state is Phase Zero:
 - Set the connection state to Active.
 - Signal the Enlistment Phase Zero Complete event on the Core Transaction Manager Facet with the following arguments:
 - The Enlistment object that is referenced by this connection.
 - The Completed outcome value.
- Otherwise, if the connection state is Phase Zero with Outstanding Registration:
 - Set the connection state to Requesting Phase Zero.
 - Signal the Enlistment Phase Zero Complete event on the Core Transaction Manager Facet with the following arguments:
 - The Enlistment object that is referenced by this connection
 - The Completed outcome value
- Otherwise, the message MUST be processed as an invalid message as specified in section 3.1.6.

3.7.5.1.2.1.4 Receiving a PARTNERTM_PROPAGATE_MTAG_ABORTNOTIFY Message

When the superior transaction manager receives a PARTNERTM_PROPAGATE_MTAG_ABORTNOTIFY (section 2.2.9.1.1.1.13) message, the superior transaction manager MUST perform the following actions:

- If the connection state is either Active or Requesting Phase Zero:
 - Signal the Enlistment Unilaterally Aborted (section 3.2.7.19) event on the Core Transaction Manager Facet (section 1.3.3.3.1) with the Enlistment object that is referenced by this connection.
 - Set the connection state to Ended.
- Otherwise, if the connection state is Phase Zero (section 3.7.1.2.7):
 - Signal the Enlistment Phase Zero Complete (section 3.2.7.17) event on the Core Transaction Manager Facet with the following arguments:
 - The Enlistment object that is referenced by this connection
 - The Aborted outcome value
 - Set the connection state to Ended.
- Otherwise, the message MUST be processed as an invalid message, as specified in section 3.1.6.

3.7.5.1.2.1.5 Receiving a PARTNERTM_PROPAGATE_MTAG_ABORTREQDONE Message

When the superior transaction manager receives a PARTNERTM_PROPAGATE_MTAG_ABORTREQDONE message, the superior transaction manager MUST perform the following actions:

- If the connection state is Awaiting Abort Response:
 - Signal the Enlistment Rollback Complete event on the Core Transaction Manager Facet with the Enlistment object that is referenced by this connection.
 - Set the connection state to Ended.
- Otherwise, the message MUST be processed as an invalid message as specified in section 3.1.6.

3.7.5.1.2.1.6 Receiving a PARTNERTM_PROPAGATE_MTAG_PREPAREREQDONE Message

When the superior transaction manager receives a PARTNERTM_PROPAGATE_MTAG_PREPAREREQDONE message, the superior transaction manager MUST perform the following actions:

- If the connection state is Awaiting Prepare Response:
 - Signal the Enlistment Phase One Complete (section 3.2.7.16) event on the Core Transaction Manager Facet (section 1.3.3.3.1) with the following arguments:
 - The Enlistment object that is referenced by this connection.
 - The outcome value that is determined by the **prepareReqDone** field from the message. The outcome value is set to:
 - Prepared if the **prepareReqDone** field is PARTNERTM_PROPAGATE_PREPAREREQDONE_OK.
 - Aborted if the prepareReqDone field is PARTNERTM_PROPAGATE_PREPAREREQDONE_ABORT.

- Read Only if the prepareReqDone field is PARTNERTM_PROPAGATE_PREPAREREQDONE_READ_ONLY.
- Committed if the prepareReqDone field is PARTNERTM_PROPAGATE_PREPAREREQDONE_SINGLEPHASE_COMMIT.
- In Doubt if the prepareReqDone field is PARTNERTM_PROPAGATE_PREPAREREQDONE_SINGLEPHASE_INDOUBT.
- If the prepareReqDone value is Prepared:
 - Set the connection state to Prepared.
 - Otherwise, set the connection state to Ended.
- Otherwise, the message MUST be processed as an invalid message as specified in section 3.1.6.

3.7.5.1.2.1.7 Receiving a PARTNERTM_PROPAGATE_MTAG_COMMITREQDONE Message

When the superior transaction manager receives a PARTNERTM_PROPAGATE_MTAG_COMMITREQDONE (section 2.2.9.1.1.1.10) message, the superior transaction manager MUST perform the following actions:

- If the connection state is Awaiting Commit Response:
 - Signal the Enlistment Commit Complete (section 3.2.7.15) event on the core transaction manager with the Enlistment object that is referenced by this connection.
 - Set the connection state to Ended.
- Otherwise, the message MUST be processed as an invalid message as specified in section 3.1.6.

3.7.5.1.2.1.8 Receiving a PARTNERTM_PROPAGATE_MTAG_PROTOCOL_ERROR Message

The processing of this event MUST be identical to the processing of the Connection Disconnected event.

3.7.5.1.2.1.9 Connection Disconnected

When a CONNTYPE_PARTNERTM_BRANCH (section 2.2.9.1.2.1) connection is disconnected, the superior transaction manager facet MUST perform the following actions:

- If the connection state is Awaiting Prepare Response:
 - If the state of the transaction object that is referenced by the connection is Single Phase Commit (section 3.2.1.3.9):
 - Signal the Enlistment Phase Zero Complete (section 3.2.7.17) event on the Core Transaction Manager Facet (section 1.3.3.3.1) with the following arguments:
 - The Enlistment object that is referenced by this connection
 - The In Doubt outcome value
 - Otherwise:
 - Signal the Enlistment Phase Zero Complete event on the Core Transaction Manager Facet with the following arguments:

- The Enlistment object that this connection references
 - The Aborted outcome value
- Otherwise, if the connection state is Awaiting Commit Response:
 - Retrieve the Enlistment object that is referenced by the connection object.
 - Initiate a new CONNTYPE_PARTNERTM_REDELIVERCOMMIT (section 2.2.9.2.2.1) connection using the Name object referenced by the Name field of the session object containing the provided connection.
 - Add the new connection object to the connection list of the transaction object referenced by the Enlistment object.
 - Assign the new connection object to the enlistment **Enlistment Object.Connection** field of the Enlistment Object.
 - Assign the enlistment to the new connection's **Enlistment** field.
 - Send a PARTNERTM_REDELIVERCOMMIT_MTAG_COMMITREQ (section 2.2.9.2.2.1.1) message using the connection:
 - Set the **guidTX** field to the **Transaction Object.Identifier** field of the transaction object that is referenced by this connection Enlistment object.
 - Set the new connection state to Awaiting Confirmation.
- Otherwise, if the connection state is Awaiting Abort Response:
 - Signal the Enlistment Rollback Complete (section 3.2.7.18) event on the Core Transaction Manager Facet with the Enlistment object that is referenced by this connection.
- Otherwise, if the connection state is either Phase Zero, Phase Zero Registration During Phase Zero, or Phase Zero with Outstanding Registration:
 - Signal the Enlistment Phase Zero Complete event on the Core Transaction Manager Facet with the following arguments:
 - The Enlistment object that is referenced by this connection
 - The Aborted outcome value
- Otherwise, if the connection state is either Branching, Active, Phase Zero Registration, or Requesting Phase Zero:
 - Signal the Enlistment Unilaterally Aborted (section 3.2.7.19) event on the Core Transaction Manager Facet with the Enlistment object that is referenced by this connection.
- Finally, in all cases, the event MUST be processed as specified in section 3.1.8.3.

3.7.5.2 Transaction Recovery

3.7.5.2.1 Subordinate-Driven Recovery

3.7.5.2.1.1 CONNTYPE_PARTNERTM_CHECKABORT as Acceptor

For all messages received in this connection type, the Superior Transaction Manager facet MUST process the message in accordance with section 3.1. The Superior Transaction Manager facet MUST additionally follow the processing rules specified in the following sections.

3.7.5.2.1.1.1 Receiving a PARTNERTM_CHECKABORT_MTAG_CHECK Message

When the Superior Transaction Manager Facet receives a PARTNERTM_CHECKABORT_MTAG_CHECK message, the Superior Transaction Manager Facet MUST perform the following actions:

- If the connection state is Idle:
 - Set the connection state to Processing Abort Inquiry.
 - Find the transaction object in the Transaction Manager's transaction Table, using the **guidTx** field from the message as a key.
 - If the transaction object is not found, or if the transaction state is either Aborting or Ended:
 - Send a PARTNERTM_CHECKABORT_MTAG_ABORTED message using the connection.
 - Set the connection state to Ended.
 - Otherwise:
 - Send a PARTNERTM_CHECKABORT_MTAG_RETRY message using the connection.
 - Set the connection state to Idle.
- Otherwise, the message MUST be processed as an invalid message as specified in section 3.1.6.

3.7.5.2.1.1.2 Connection Disconnected

When a CONNTYPE_PARTNERTM_CHECKABORT (section 2.2.9.2.1.1) connection is disconnected, the Superior Transaction Manager Facet (section 1.3.3.3.4) MUST perform the actions as specified in section 3.1.8.3.

3.7.5.2.2 Superior-Driven Recovery

3.7.5.2.2.1 CONNTYPE_PARTNERTM_REDELIVERCOMMIT as Initiator

For all messages received in this connection type, the Superior Transaction Manager Facet MUST process the message as specified in section 3.1. The Superior Transaction Manager Facet MUST additionally follow the processing rules as specified in this section.

3.7.5.2.2.1.1 Receiving a PARTNERTM_REDELIVERCOMMIT_MTAG_COMMITREQDONE Message

When the Superior Transaction Manager Facet (section 1.3.3.3.4) receives a PARTNERTM_REDELIVERCOMMIT_MTAG_COMMITREQDONE (section 2.2.9.2.2.1.2) message, the Superior Transaction Manager Facet MUST perform the following actions:

- If the connection state is Awaiting Confirmation:
 - Signal the Enlistment Commit Complete (section 3.2.7.15) event on the Core Transaction Manager Facet (section 1.3.3.3.1) with the Enlistment object referenced by this connection.
 - Set the connection state to Ended.
- Otherwise, the message MUST be processed as an invalid message as specified in section 3.1.6.

3.7.5.2.2.1.2 Receiving a PARTNERTM_REDELIVERCOMMIT_MTAG_RETRY Message

When the superior transaction manager facet receives a PARTNERTM_REDELIVERCOMMIT_MTAG_RETRY message, the superior transaction manager facet MUST perform the following actions:

- If the connection state is Awaiting Confirmation:
 - Set the connection state to Waiting to Rerequest.
 - Initialize a Redeliver Commit timer with the following arguments:
 - The Enlistment object of the connection
 - An implementation-specific time-out value, as specified in Redeliver Commit Timer
- Otherwise, the message MUST be processed as an invalid message, as specified in section 3.1.6.

3.7.5.2.2.1.3 Connection Disconnected

When a CONNTYPE_PARTNERTM_REDELIVERCOMMIT (section 2.2.9.2.2.1) connection is disconnected, the Superior Transaction Manager Facet (section 1.3.3.3.4) MUST perform the following actions:

- If the connection state is Waiting to Rerequest:
 - Cancel the Redeliver Commit Timer associated with the connection.
- If the connection state is Idle, Waiting to Rerequest, or Awaiting Confirmation:
 - Set the connection state to Ended.
 - Signal the Begin Commit (section 3.7.7.1) event on the Superior Transaction Manager Facet with the Enlistment object referenced by the **Enlistment** field of the connection.
- Otherwise, the event MUST be processed as specified in section 3.1.8.3.

3.7.6 Timer Events

3.7.6.1 Redeliver Commit Timer

When this timer expires, the Superior Transaction Manager Facet (section 1.3.3.3.4) MUST perform the following actions:

- Cancel the Redeliver Commit timer.
- If the connection referenced by the provided enlistment is in the Waiting to Rerequest state:
 - Set the connection state to Idle.
 - Send a PARTNERTM_REDELIVERCOMMIT_MTAG_COMMITREQ (section 2.2.9.2.2.1.1) message using the connection referenced by the provided Enlistment object:
 - Set the **guidTX** field to the **Transaction Object.Identifier** field of the transaction object provided by the Enlistment object.
 - Set the connection state to Awaiting Confirmation.
- Otherwise, ignore the timer event.

3.7.7 Other Local Events

The Superior Transaction Manager MUST be prepared to process the local events defined in the following sections.

The Superior Transaction Manager MUST be prepared to process local events pertaining to Phase Zero functionality only on versions where the connection type CONNTYPE_TXUSER_PHASE0 is supported. Connection Types Relevant to Resource Managers - Versioning defines protocol version support for this connection type. The following local events are affected:

- Create Phase Zero Enlistment Success
- Create Phase Zero Enlistment Failure
- Begin Phase Zero
- Phase Zero Aborted

3.7.7.1 Begin Commit

The Begin Commit event MUST be signaled with the following arguments:

- An Enlistment object

If the Begin Commit event is signaled, the Superior Transaction Manager Facet (section 1.3.3.3.4) MUST perform the following actions:

- If the connection state is Ended:
 - Initiate a new CONNTYPE_PARTNERTM_REDELIVERCOMMIT (section 2.2.9.2.2.1) connection by using the Name object referenced by the Name field of the Session object containing the provided enlistment's connection.
 - Add the new connection to the provided enlistment's transaction's connection list.
 - Set the provided enlistment's **Enlistment Object.Connection** field to the new connection.
 - Set the connection's Enlistment field to the provided Enlistment object.
 - Send a PARTNERTM_REDELIVERCOMMIT_MTAG_COMMITREQ (section 2.2.9.2.2.1.1) message using the new connection.
 - Set the **guidTx** field to the **Transaction Object.Identifier** field of the transaction object referenced by this connection's Enlistment object.
 - Set the new connection state to Awaiting Confirmation.
- Otherwise:
 - Send a PARTNERTM_PROPAGATE_MTAG_COMMITREQ (section 2.2.9.1.1.1.9) message using the connection.
 - Set the connection state to Awaiting Commit Response.

3.7.7.2 Begin Phase One

The Begin Phase One event MUST be signaled with the following arguments:

- An Enlistment object.
- A Boolean Single-Phase Commit value:

- If true, the Superior Transaction Manager Facet (section 1.3.3.3.4) SHOULD attempt to perform a Single-Phase Commit.
- If false, the Superior Transaction Manager Facet MUST NOT attempt to perform a Single-Phase Commit.

If the Begin Phase One event is signaled, the Superior Transaction Manager Facet MUST perform the following actions:

- If the provided Single-Phase Commit value is set to true:
 - Send a PARTNERTM_PROPAGATE_MTAG_PREPAREREQ (section 2.2.9.1.1.1.6) message using the connection.
 - Set the **fSinglePhase** field to a nonzero value.
 - Set the **grfRM** field to the **GRFRM** field of the transaction object referenced by the Enlistment object.
- Otherwise:
 - Send a PARTNERTM_PROPAGATE_MTAG_PREPAREREQ (section 2.2.9.1.1.1.6) message using the connection.
 - Set the **fSinglePhase** field to zero.
 - Set the **grfRM** field to the **GRFRM** field of the transaction object referenced by the Enlistment object.
- Set the connection state to Awaiting Prepare Response.

3.7.7.3 Begin Phase Zero

The Begin Phase Zero event MUST be signaled with the following arguments:

- An Enlistment object

If the Begin Phase Zero event is signaled, the Superior Transaction Manager Facet (section 1.3.3.3.4) MUST perform the following actions:

- Send a PARTNERTM_PROPAGATE_MTAG_PHASE0 (section 2.2.9.1.1.1.17) message using the connection.
- Set the connection state to Phase Zero.

3.7.7.4 Begin Rollback

The Begin Rollback event MUST be signaled with the following arguments:

- An Enlistment object

If the Begin Rollback event is signaled, the Superior Transaction Manager Facet MUST perform the following actions:

- If the provided enlistment's connection state is Ended:
 - Signal the Enlistment Rollback Complete event on the Core Transaction Manager Facet with the following arguments:
 - The provided Enlistment object

- Otherwise:
 - Send a PARTNERTM_PROPAGATE_MTAG_ABORTREQ message using the connection.
 - Set the connection state to Awaiting Abort Response.

3.7.7.5 Create Phase Zero Enlistment Failure

The Create Phase Zero Enlistment Failure event MUST be signaled with the following arguments:

- An Enlistment object.
- A value indicating the failure reason. The reason MUST be set to one of the following values:
 - Too Late
 - Tx Not Found

If the Create Phase Zero Enlistment Failure event is signaled, the Superior Transaction Manager Facet (section 1.3.3.3.4) MUST perform the following actions:

- Send a PARTNERTM_PROPAGATE_MTAG_PHASE0REGISTRATIONREJECTED (section 2.2.9.1.1.1.16) message using the enlistment's connection.
- If the enlistment's connection state is Phase Zero Registration:
 - Set the connection state to Active.
- Otherwise, if the connection state is Phase Zero Registration During Phase Zero:
 - Set the connection state to Phase Zero.
- Otherwise, ignore the event.

3.7.7.6 Create Phase Zero Enlistment Success

The Create Phase Zero Enlistment Success event MUST be signaled with the following arguments:

- An Enlistment object

If the Create Phase Zero Enlistment Success event is signaled, the Superior Transaction Manager Facet (section 1.3.3.3.4) MUST perform the following actions:

- Send a PARTNERTM_PROPAGATE_MTAG_PHASE0REGISTERED (section 2.2.9.1.1.1.15) message using the enlistment's connection.
- If the enlistment's connection state is Phase Zero Registration:
 - Set the connection state to Requesting Phase Zero.
- Otherwise, if the connection state is Phase Zero Registration During Phase Zero:
 - Set the connection state to Phase Zero with Outstanding Registration.
- Otherwise, ignore the event.

3.7.7.7 Create Subordinate Enlistment Failure

The Create Subordinate Enlistment Failure event MUST be signaled with the following arguments:

- An Enlistment object.
- A value indicating the failure reason. The reason **MUST** be set to one of the following values:
 - Log Full
 - Too Late
 - Too Many

If the Create Subordinate Enlistment Failure event is signaled, the Superior Transaction Manager Facet **MUST** perform the following actions:

- Send the matching message for the following reason codes:
 - Log Full: PARTNERTM_BRANCH_MTAG_BRANCH_LOG_FULL
 - Too Late: PARTNERTM_BRANCH_MTAG_BRANCH_TOO_LATE
 - Too Many: PARTNERTM_BRANCH_MTAG_BRANCH_TOO_MANY
- Set the connection state to Ended.

3.7.7.8 Create Subordinate Enlistment Success

The Create Subordinate Enlistment Success event **MUST** be signaled with the following arguments:

- An Enlistment object

If the Create Subordinate Enlistment Success event is signaled, the Superior Transaction Manager Facet **MUST** perform the following actions:

- Send a PARTNERTM_BRANCH_MTAG_BRANCHED message using the enlistment's connection.
- Set the connection state to Active.

3.7.7.9 Phase Zero Aborted

The Phase Zero Aborted event **MUST** be signaled with the following arguments

- An Enlistment object

If the Phase Zero Aborted event is signaled, the Superior Transaction Manager Facet **MUST** perform the following actions:

- Ignore the event.

3.7.7.10 Propagate Transaction

The Propagate Transaction event **MUST** be signaled with the following arguments:

- A **Transaction** object
- A **Name** object representing the remote subordinate transaction manager

If the Propagate Transaction event is signaled, the Superior Transaction Manager Facet (section 1.3.3.3.4) **MUST** perform the following actions:

- Initiate a new CONNTYPE_PARTNERTM_PROPAGATE (section 2.2.9.1.1.1) connection to the provided **Name** object.

- Set the **Transaction** field of the **Connection** object to the provided **Transaction** object.
- Add the **Connection** to the provided **Transaction** connection list.
- Send a PARTNERTM_PROPAGATE_MTAG_PROPAGATE (section 2.2.9.1.1.1.1) message using the **Connection**:
 - Set the **guidTX** field to the **Transaction Object.Identifier** field of the provided **Transaction** object.
 - Set the **isoLevel** field to the **Isolation Level** field of the provided **Transaction** object.
 - Set the **szDesc** field to the **Description** field of the provided **Transaction** object.
- Set the **Connection** state to Awaiting Propagation Response.

3.8 Subordinate Transaction Manager Facet Details

3.8.1 Abstract Data Model

This section describes a conceptual model of possible data organization that an implementation maintains to participate in this protocol. The described organization is provided to facilitate the explanation of how the protocol behaves. This document does not mandate that implementations adhere to this model as long as their external behavior is consistent with that described in this document.

Note that the abstract data model can be implemented in a variety of ways. This protocol does not prescribe or advocate any specific implementation technique.

The Subordinate Transaction Manager Facet (section 3.8) MUST maintain all the data elements as specified in section 3.1.1 and section 3.2.1.

Enlistment objects that are created by the subordinate transaction manager MUST provide the following properties as specified in section 3.1.1:

- **Name:** The Name object referenced by the Name field of the Session object containing the connection object referenced by the **Enlistment Object.Connection** field of the Enlistment object
- **Enlistment Object.Identifier:** An empty string

The subordinate transaction manager MUST provide the states as specified in the following sections for its supported connection types. Section 2.2.1.1.2 defines the connection types that a subordinate transaction manager MUST provide for each supported protocol version.

3.8.1.1 CONNTYPE_PARTNERTM_PROPAGATE Acceptor States

The Subordinate Transaction Manager Facet (section 1.3.3.3.5) MUST act as an acceptor for the CONNTYPE_PARTNERTM_PROPAGATE (section 2.2.9.1.1.1) connection type. In this role, the subordinate transaction manager MUST provide support for the states in this section:

- Idle (section 3.8.1.1.1)
- Propagating (section 3.8.1.1.2)
- Active (section 3.8.1.1.3)
- Aborting (section 3.8.1.1.4)
- Awaiting Registration Response (section 3.8.1.1.5)

- Awaiting Phase Zero (section 3.8.1.1.6)
- Awaiting Phase Zero Outcome (section 3.8.1.1.7)
- Awaiting Registration Response During Phase Zero (section 3.8.1.1.8)
- Awaiting Phase Zero Outcome with Outstanding Registration (section 3.8.1.1.9)
- Preparing (section 3.8.1.1.10)
- Prepared (section 3.8.1.1.11)
- Committing (section 3.8.1.1.12)
- Ended (section 3.8.1.1.13)

The following illustration shows the relationship between the CONNTYPE_PARTNERTM_PROPAGATE acceptor states.

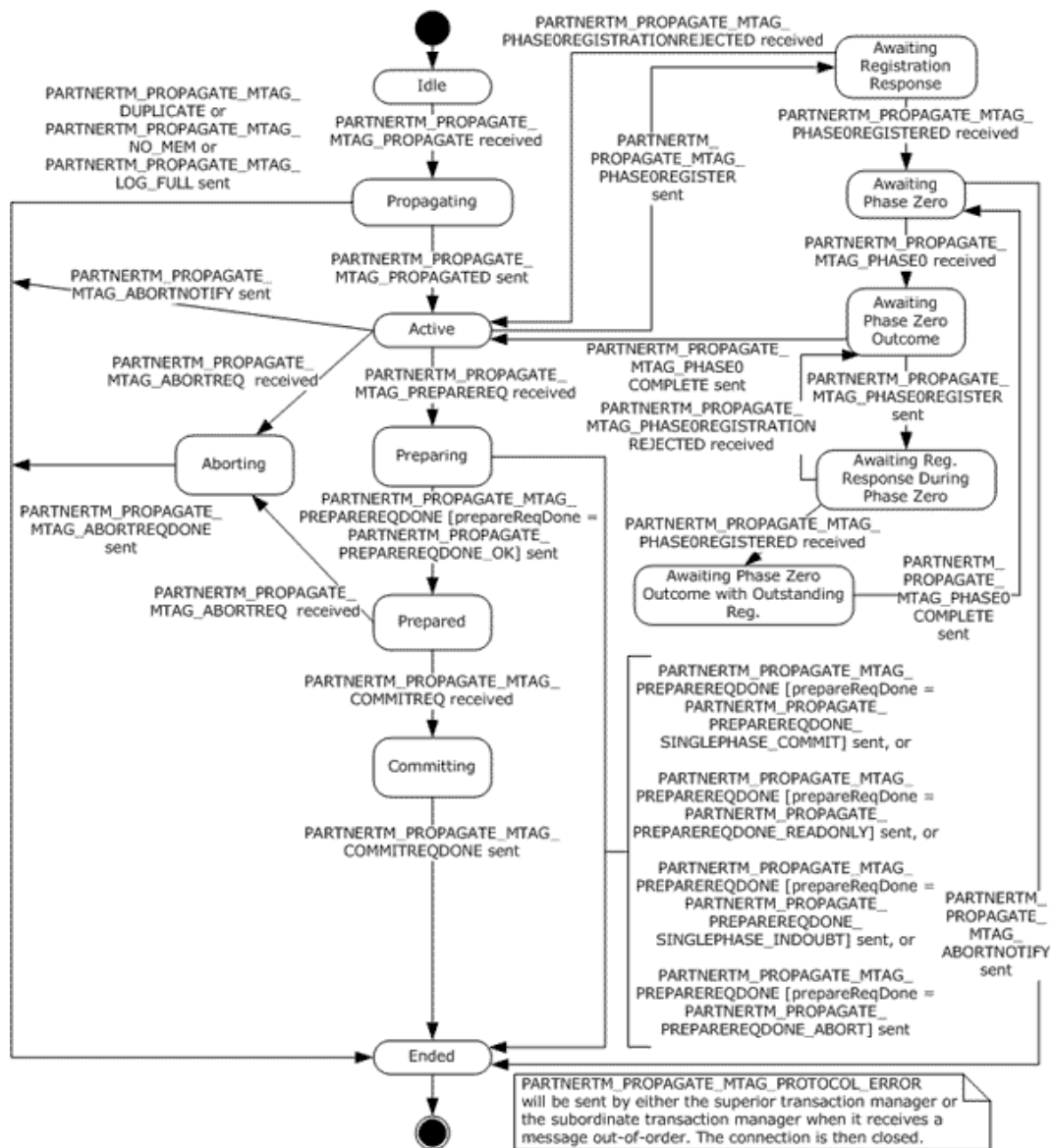

Figure 61: CONNTYPE_PARTERTM_PROPAGATE acceptor states

3.8.1.1.1 Idle

This is the initial state. The following event is processed in this state:

- Receiving a PARTNERTM_PROPAGATE_MTAG_PROPAGATE message (section 3.8.5.1.1.1.1)

3.8.1.1.2 Propagating

The following events are processed in this state:

- Create Superior Enlistment Success (section 3.8.7.4)
- Create Superior Enlistment Failure (section 3.8.7.5)

3.8.1.1.3 Active

The following events are processed in this state:

- Register Phase Zero (section 3.8.7.9)
- Unilaterally Aborted (section 3.8.7.11)
- Receiving a PARTNERTM_PROPAGATE_MTAG_ABORTREQ message (section 3.8.5.1.2.1.5)
- Receiving a PARTNERTM_PROPAGATE_MTAG_PREPAREREQ message (section 3.8.5.1.2.1.7)
- Receiving a PARTNERTM_PROPAGATE_MTAG_PROTOCOL_ERROR message (section 3.8.5.1.1.1.3)

3.8.1.1.4 Aborting

The following event is processed in this state:

- Rollback Complete (section 3.8.7.10)

3.8.1.1.5 Awaiting Registration Response

The following events are processed in this state:

- Receiving a PARTNERTM_PROPAGATE_MTAG_PHASE0REGISTERED message, as described in CONNTYPE_PARTNERTM_PROPAGATE as Acceptor (section 3.8.5.1.1.1) and in Receiving Other PARTNERTM_PROPAGATE_MTAG Messages (section 3.8.5.1.1.1.2).
- Receiving a PARTNERTM_PROPAGATE_MTAG_PROTOCOL_ERROR message (section 3.8.5.1.1.1.3).

3.8.1.1.6 Awaiting Phase Zero

The following events are processed in this state:

- Receiving a PARTNERTM_PROPAGATE_MTAG_PHASE0 message (section 3.8.5.1.2.1.6)
- Unilaterally Aborted (section 3.8.7.11)
- Receiving a PARTNERTM_PROPAGATE_MTAG_PROTOCOL_ERROR message (section 3.8.5.1.2.1.9)

3.8.1.1.7 Awaiting Phase Zero Outcome

The following events are processed in this state:

- Phase Zero Complete (section 3.8.7.6)
- Register Phase Zero (section 3.8.7.9)

3.8.1.1.8 Awaiting Registration Response During Phase Zero

The following events are processed in this state:

- Receiving a PARTNERTM_PROPAGATE_MTAG_PHASE0REGISTERED message (section 3.8.5.1.2.1.3)
- Receiving a PARTNERTM_PROPAGATE_MTAG_PHASE0REGISTRATIONREJECTED message (section 3.8.5.1.1.1.2)
- Receiving a PARTNERTM_PROPAGATE_MTAG_PROTOCOL_ERROR message (section 3.8.5.1.1.1.3)

3.8.1.1.9 Awaiting Phase Zero Outcome with Outstanding Registration

The following event is processed in this state:

- Phase Zero Complete (section 3.8.7.6)

3.8.1.1.10 Preparing

The following event is processed in this state:

- Phase One Complete (section 3.8.7.7)

3.8.1.1.11 Prepared

The following events are processed in this state:

- Receiving a PARTNERTM_PROPAGATE_MTAG_COMMITREQ message (section 3.8.5.1.2.1.8)
- Receiving a PARTNERTM_PROPAGATE_MTAG_ABORTREQ message (section 3.8.5.1.2.1.5)
- Receiving a PARTNERTM_PROPAGATE_MTAG_PROTOCOL_ERROR message (section 3.8.5.1.1.1.3)

3.8.1.1.12 Committing

The following event is processed in this state:

- Commit Complete (section 3.8.7.3)

3.8.1.1.13 Ended

This is the final state.

3.8.1.2 CONNTYPE_PARTNERTM_BRANCH Initiator States

The Subordinate Transaction Manager Facet (section 3.8) MUST act as an initiator for the CONNTYPE_PARTNERTM_BRANCH (section 2.2.9.1.2.1) connection type. In this role, the subordinate transaction manager MUST provide support for the states in this section.

The following illustration shows the relationship between the CONNTYPE_PARTNERTM_BRANCH initiator states.

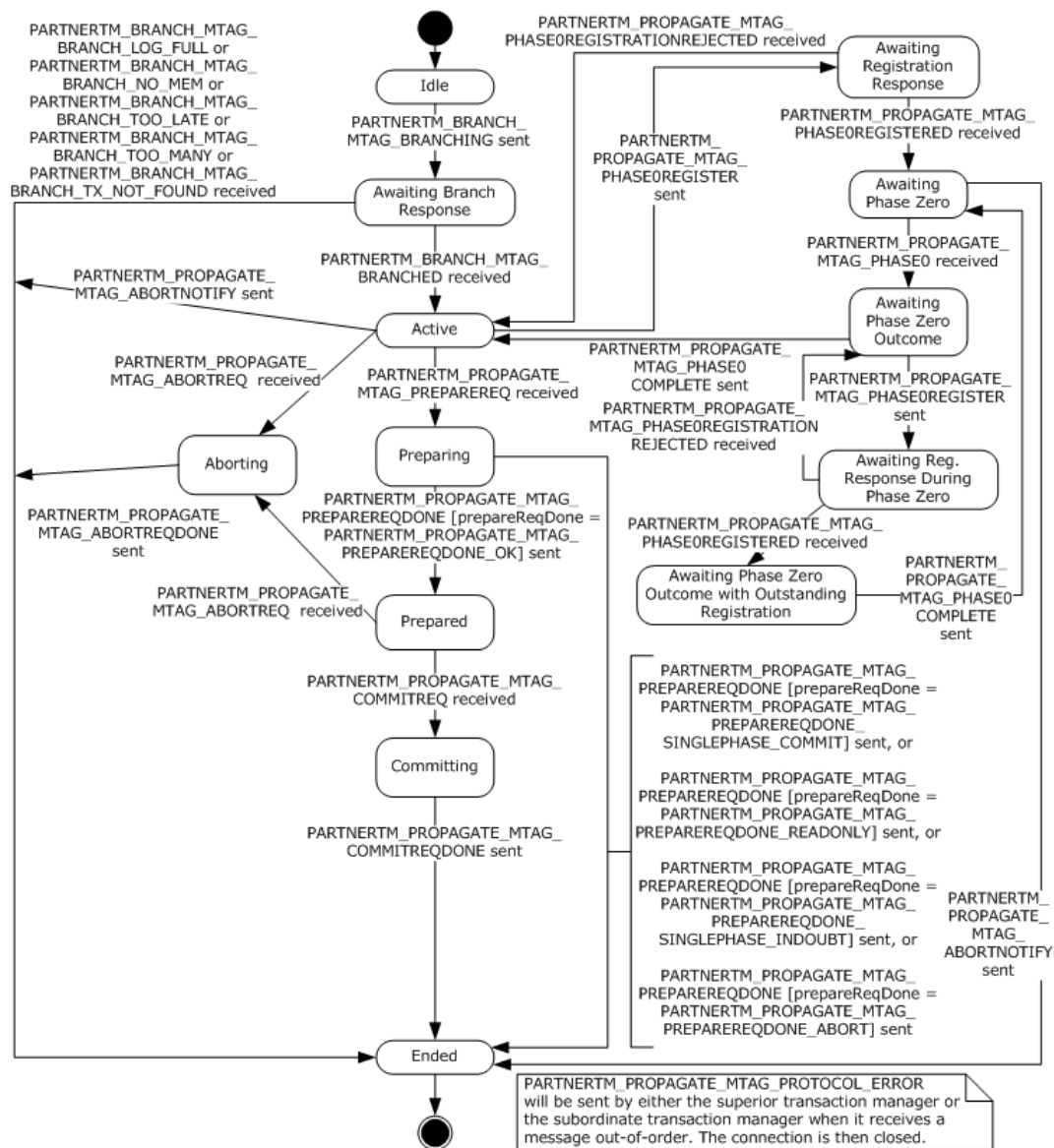

Figure 62: CONNTYPE_PARTNERTM_BRANCH initiator states

3.8.1.2.1 Idle

This is the initial state. The following event is processed in this state:

- Branch Transaction (section 3.8.7.1)

3.8.1.2.2 Awaiting Branch Response

The following events are processed in this state:

- Receiving a PARTNERTM_BRANCH_MTAG_BRANCHED Message (section 3.8.5.1.2.1.1)
- Receiving a PARTNERTM_BRANCH_MTAG_BRANCH_LOG_FULL, PARTNERTM_BRANCH_MTAG_BRANCH_NO_MEM, PARTNERTM_BRANCH_MTAG_BRANCH_TOO_LATE,

PARTNERTM_BRANCH_MTAG_BRANCH_TOO_MANY or
PARTNERTM_BRANCH_MTAG_BRANCH_TX_NOT_FOUND Message (section 3.8.5.1.2.1.2)

3.8.1.2.3 Active

The following events are processed in this state:

- Register Phase Zero (section 3.8.7.9)
- Unilaterally Aborted (section 3.8.7.11)
- Receiving a PARTNERTM_PROPAGATE_MTAG_ABORTREQ Message (section 3.8.5.1.2.1.5)
- Receiving a PARTNERTM_PROPAGATE_MTAG_PREPAREREQ Message (section 3.8.5.1.2.1.7)
- Receiving a PARTNERTM_PROPAGATE_MTAG_PROTOCOL_ERROR Message (section 3.8.5.1.2.1.9)

3.8.1.2.4 Aborting

The following event is processed in this state:

- Rollback Complete (section 3.8.7.10)

3.8.1.2.5 Awaiting Registration Response

The following events are processed in this state:

- Receiving a PARTNERTM_PROPAGATE_MTAG_PHASE0REGISTERED (section 3.8.5.1.2.1.3) message
- Receiving a PARTNERTM_PROPAGATE_MTAG_PHASE0REGISTRATIONREJECTED (section 3.8.5.1.2.1.4) message
- Receiving a PARTNERTM_PROPAGATE_MTAG_PROTOCOL_ERROR (section 3.8.5.1.2.1.9) message

3.8.1.2.6 Awaiting Phase Zero

The following events are processed in this state:

- Receiving a PARTNERTM_PROPAGATE_MTAG_PHASE0 (section 3.8.5.1.2.1.6) message
- Unilaterally Aborted (section 3.8.7.11).
- Receiving a PARTNERTM_PROPAGATE_MTAG_PROTOCOL_ERROR (section 3.8.5.1.2.1.9) message

3.8.1.2.7 Awaiting Phase Zero Outcome

The following event is processed in this state:

- Phase Zero Complete (section 3.8.7.6)

3.8.1.2.8 Awaiting Registration Response During Phase Zero

The following events are processed in this state:

- Receiving a PARTNERTM_PROPAGATE_MTAG_PHASE0REGISTERED (section 3.8.5.1.2.1.3) message

- Receiving a PARTNERTM_PROPAGATE_MTAG_PHASE0REGISTRATIONREJECTED (section 3.8.5.1.2.1.4) message
- Receiving a PARTNERTM_PROPAGATE_MTAG_PROTOCOL_ERROR (section 3.8.5.1.2.1.9) message

3.8.1.2.9 Awaiting Phase Zero Outcome with Outstanding Registration

The following event is processed in this state:

- Phase Zero Complete (section 3.8.7.6)

3.8.1.2.10 Preparing

The following event is processed in this state:

- Phase One Complete (section 3.8.7.7)

3.8.1.2.11 Prepared

The following events are processed in this state:

- Receiving a PARTNERTM_PROPAGATE_MTAG_COMMITREQ (section 3.8.5.1.2.1.8) message
- Receiving a PARTNERTM_PROPAGATE_MTAG_ABORTREQ (section 3.8.5.1.2.1.5) message
- Receiving a PARTNERTM_PROPAGATE_MTAG_PROTOCOL_ERROR (section 3.8.5.1.2.1.9) message

3.8.1.2.12 Committing

The following event is processed in this state:

- Commit Complete (section 3.8.7.3)

3.8.1.2.13 Ended

This is the final state.

3.8.1.3 CONNTYPE_PARTNERTM_REDELIVERCOMMIT Acceptor States

The Subordinate Transaction Manager Facet (section 1.3.3.3.5) MUST act as an acceptor for the CONNTYPE_PARTNERTM_REDELIVERCOMMIT (section 2.2.9.2.2.1) connection type. In this role, the subordinate transaction manager MUST provide support for the states in this section.

The following figure shows the relationship between the CONNTYPE_PARTNERTM_REDELIVERCOMMIT Acceptor states.

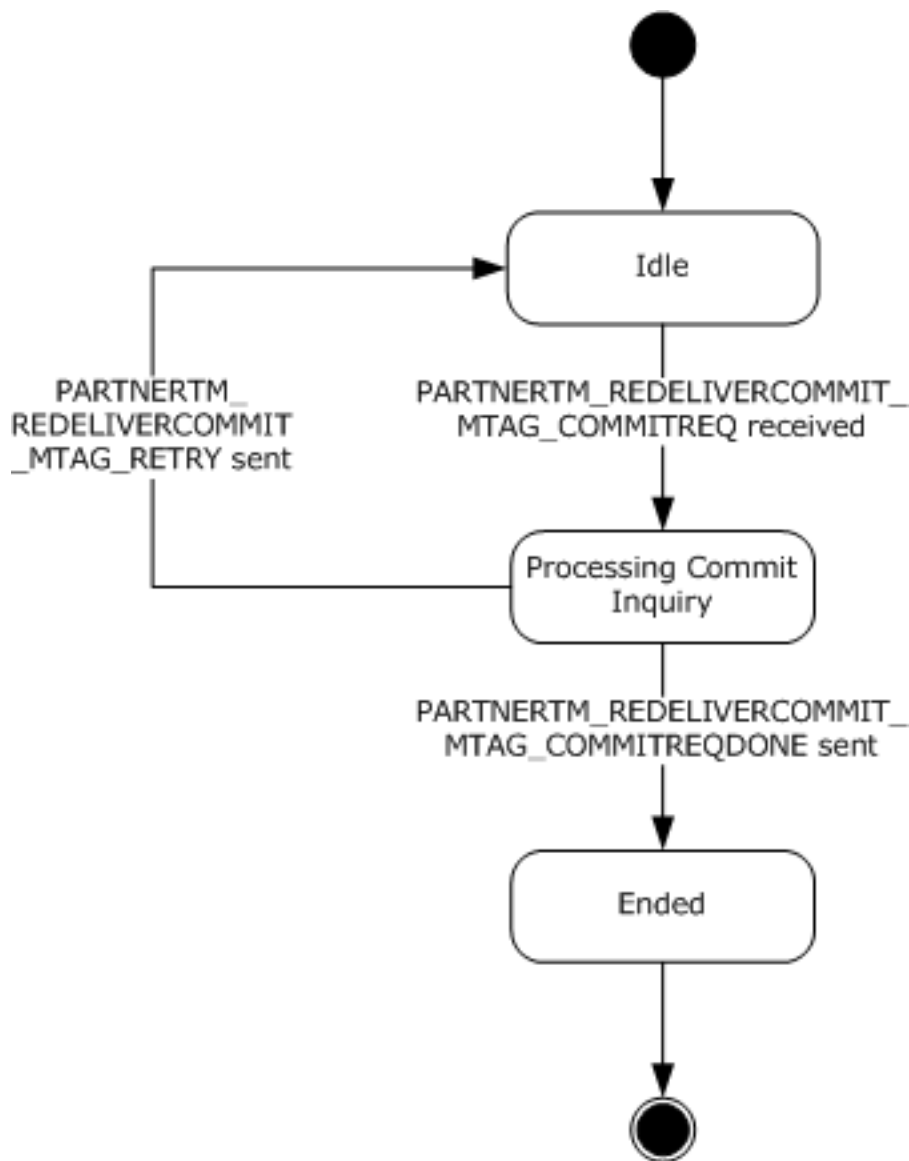

Figure 63: CONNTYPE_PARTNERTM_REDELIVERCOMMIT acceptor states

3.8.1.3.1 Idle

This is the initial state. The following event is processed in this state:

- Receiving a PARTNERTM_REDELIVERCOMMIT_MTAG_COMMITREQ message (section 3.8.5.2.2.1.1)

3.8.1.3.2 Processing Commit Inquiry

The following event is processed in this state:

- Commit Complete (section 3.8.7.3)

3.8.1.3.3 Ended

This is the final state.

3.8.1.4 CONNTYPE_PARTNERTM_CHECKABORT Initiator States

The Subordinate Transaction Manager Facet (section 1.3.3.3.5) MUST act as an initiator for the CONNTYPE_PARTNERTM_CHECKABORT (section 2.2.9.2.1.1) connection type. In this role, the subordinate transaction manager MUST provide support for the states in this section.

The following figure shows the relationship between the CONNTYPE_PARTNERTM_CHECKABORT initiator states.

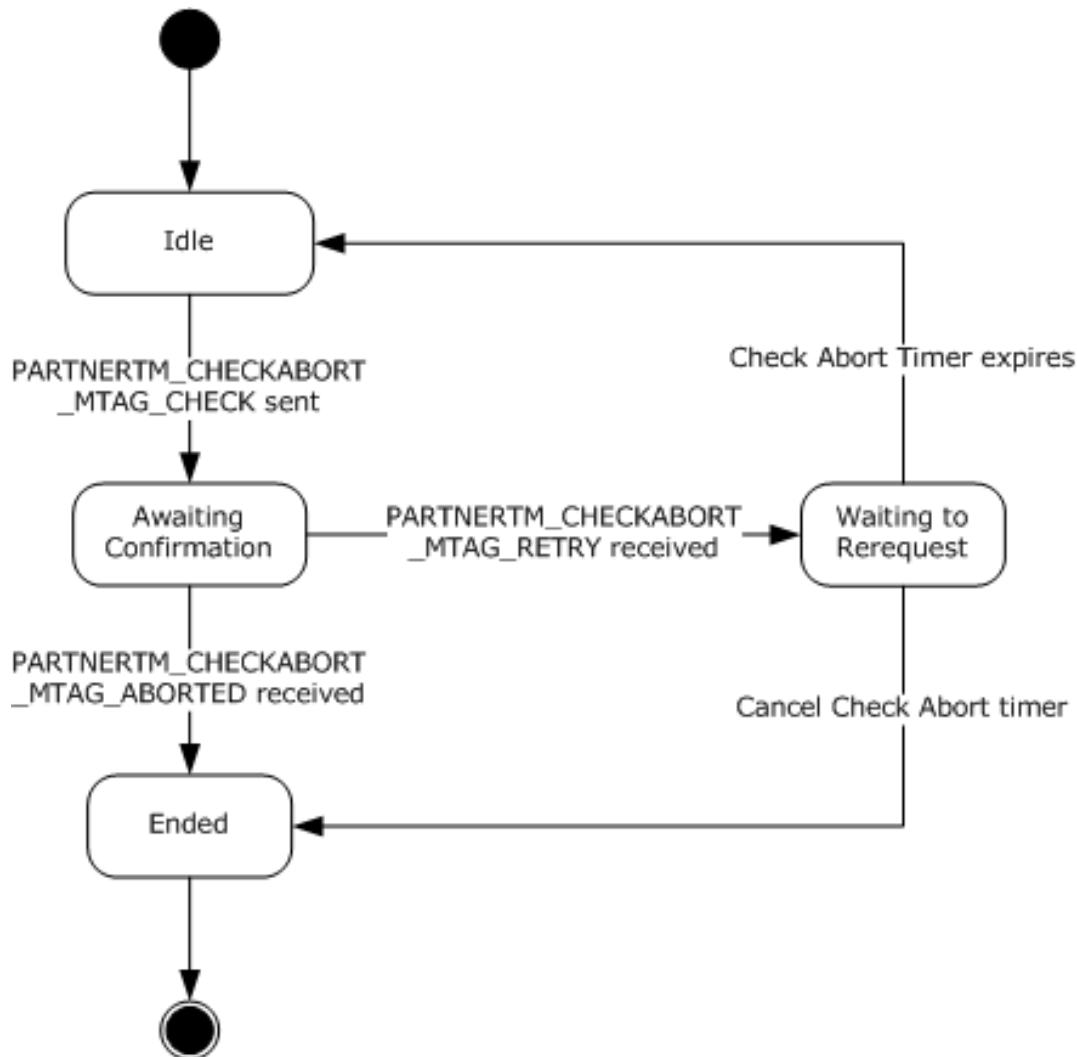

Figure 64: CONNTYPE_PARTNERTM_CHECKABORT initiator states

3.8.1.4.1 Idle

This is the initial state. The following event is processed in this state:

- Recover In Doubt Transaction (section 3.8.7.8)

3.8.1.4.2 Awaiting Confirmation

The following events are processed in this state:

- Receiving a PARTNERTM_CHECKABORT_MTAG_ABORTED Message (section 3.8.5.2.1.1.1)
- Receiving a PARTNERTM_CHECKABORT_MTAG_RETRY Message (section 3.8.5.2.1.1.2)
- Cancel Check Abort (section 3.8.7.2)

3.8.1.4.3 Waiting to ReRequest

The following events are processed in this state:

- Check Abort Timer (section 3.8.2.1)
- Cancel Check Abort (section 3.8.7.2)

3.8.1.4.4 Ended

This is the final state.

3.8.2 Timers

The Subordinate Transaction Manager Facet (section 3.8) MUST provide the Check Abort Timer (section 3.8.2.1).

3.8.2.1 Check Abort Timer

This timer MUST be set when the Subordinate Transaction Manager Facet (section 1.3.3.3.5) receives a PARTNERTM_CHECKABORT_MTAG_RETRY (section 2.2.9.2.1.1.3) message on a CONNTYPE_PARTNERTM_CHECKABORT (section 2.2.9.2.1.1) connection. The timer MUST be canceled when the CONNTYPE_PARTNERTM_CHECKABORT (section 2.2.9.2.1.1) connection is disconnected.

The default value of the timer is implementation-specific.<37>

When the timer is initialized, the Subordinate Transaction Manager Facet (section 1.3.3.3.5) MUST provide an Enlistment object to associate with the timer. When the timer expires, the same Enlistment object MUST be provided alongside the timer notification. The Subordinate Transaction Manager Facet (section 1.3.3.3.5) MUST provide a distinct Check Abort Timer instance for each CONNTYPE_PARTNERTM_CHECKABORT connection.

3.8.3 Initialization

When the Subordinate Transaction Manager Facet (section 1.3.3.3.5) is initialized:

- The Subordinate Transaction Manager Facet MUST examine the following security flags on the Core Transaction Manager Facet and perform the following actions:
 - If one of the Allow Network Access, Allow Network Transactions, or Allow Inbound Transactions flags is set to false:
 - For the following connection type, the Subordinate Transaction Manager Facet MUST refuse to accept incoming connections from remote machines as specified in [MS-CMP] section 3.1.5.5 with the rejection Reason set to 0x80070005.
 - CONNTYPE_PARTNERTM_PROPAGATE (section 2.2.9.1.1.1)
 - If one of the Allow Network Access or Allow Network Transactions flags is set to false, or if both the Allow Inbound Transactions and Allow Outbound Transactions flags are set to false:

- For the following connection type, the Subordinate Transaction Manager Facet **MUST** refuse to accept incoming connections from remote machines as specified in [MS-CMP] section 3.1.5.5 with the rejection reason set to 0x80070005.
 - CONNTYPE_PARTNERTM_REDELIVERCOMMIT (section 2.2.9.2.2.1)

All data elements maintained by the Subordinate Transaction Manager Facet are initialized to an empty value unless stated otherwise in this section or in the initialization sections of the facets the Subordinate Transaction Manager Facet extends, as described in section 3.8.1.

3.8.4 Higher-Layer Triggered Events

There are no higher-layer triggered events.

3.8.5 Processing Events and Sequencing Rules

3.8.5.1 Transaction Propagation and Coordination

3.8.5.1.1 Push Propagation

3.8.5.1.1.1 CONNTYPE_PARTNERTM_PROPAGATE as Acceptor

For all messages received in this connection type, the Subordinate Transaction Manager Facet (section 1.3.3.3.5) **MUST** process the message as specified in section 3.1.

Also, the Subordinate Transaction Manager Facet (section 1.3.3.3.5) **MUST** override the default state verification actions for incoming messages as specified in section 3.1.6 in the following manner:

- If the current connection state does not define a processing rule for the message:
 - Send a PARTNERTM_PROPAGATE_MTAG_PROTOCOL_ERROR message using the connection.
 - Perform default invalid message processing, as specified in section 3.1.6.

The Subordinate Transaction Manager Facet (section 1.3.3.3.5) **MUST** additionally follow the processing rules as specified in this section.

3.8.5.1.1.1.1 Receiving a PARTNERTM_PROPAGATE_MTAG_PROPAGATE Message

When the Subordinate Transaction Manager Facet (section 1.3.3.3.5) receives a PARTNERTM_PROPAGATE_MTAG_PROPAGATE (section 2.2.9.1.1.1.1) message, the Subordinate Transaction Manager Facet **MUST** perform the following actions:

- If the connection state is Idle:
 - Set the connection state to Propagating.
 - If the transaction manager does not have sufficient memory available to process the message, it **MUST**:
 - Send a PARTNERTM_PROPAGATE_MTAG_NO_MEM (section 2.2.9.1.1.1.4) message.
 - Set the connection state to Ended (section 3.8.1.1.13).
 - Otherwise, find the transaction object in the transaction table of the transaction manager using the **guidTx** field from the message as the key:
 - If the transaction object is found in the list:

- Send a PARTNERTM_PROPAGATE_MTAG_DUPLICATE (section 2.2.9.1.1.1.3) message to the superior transaction manager.
- Set the connection state to Ended.
- Otherwise, if the transaction object is not found in the list:
 - Create a new transaction object with the information provided in the message:
 - Use the **guidTx** field from the message as the **Transaction Object.Identifier** value.
 - Use the **isoLevel** field from the message as the Isolation Level value.
 - Use the **szDesc** field from the message as the Description value.
 - Add the connection to the connection list of the transaction.
 - Create a new Enlistment object with the following values:
 - The Subordinate Transaction Manager Facet.
 - The new transaction object.
 - This connection object.
 - Assign the enlistment to the connection's Enlistment field.
 - Signal the Create Superior Enlistment (section 3.2.7.12) event on the Core Transaction Manager Facet (section 1.3.3.3.1) with the Enlistment object.
- Otherwise, the message MUST be processed as specified in section 3.1.6.

3.8.5.1.1.1.2 Receiving Other PARTNERTM_PROPAGATE_MTAG Messages

When the Subordinate Transaction Manager Facet (section 1.3.3.3.5) receives one of these messages:

- PARTNERTM_PROPAGATE_MTAG_PHASE0REGISTRATIONREJECTED (section 2.2.9.1.1.1.16)
- PARTNERTM_PROPAGATE_MTAG_PHASE0REGISTERED (section 2.2.9.1.1.1.15)
- PARTNERTM_PROPAGATE_MTAG_PHASE0 (section 2.2.9.1.1.1.17)
- PARTNERTM_PROPAGATE_MTAG_ABORTREQ (section 2.2.9.1.1.1.11)
- PARTNERTM_PROPAGATE_MTAG_PREPAREREQ (section 2.2.9.1.1.1.6)
- PARTNERTM_PROPAGATE_MTAG_COMMITREQ (section 2.2.9.1.1.1.9)

It MUST follow the same message processing rules as the CONNTYPE_PARTNERTM_BRANCH (section 2.2.9.1.2.1) connection type acting as an initiator. See CONNTYPE_PARTNERTM_BRANCH as Initiator (section 3.8.5.1.2.1) for more information.

3.8.5.1.1.1.3 Receiving a PARTNERTM_PROPAGATE_MTAG_PROTOCOL_ERROR Message

The processing of this event MUST be identical to the processing of the Connection Disconnected event.

3.8.5.1.1.1.4 CONNTYPE_PARTNERTM_PROPAGATE Connection Disconnected

When a CONNTYPE_PARTNERTM_PROPAGATE (section 2.2.9.1.1.1) connection is disconnected, the Subordinate Transaction Manager Facet (section 1.3.3.3.5) MUST perform the same actions as the CONNTYPE_PARTNERTM_BRANCH (section 2.2.9.1.2.1) connection type acting as an initiator. See section 3.8.5.1.2.1 for more information.

3.8.5.1.2 Pull Propagation

3.8.5.1.2.1 CONNTYPE_PARTNERTM_BRANCH as Initiator

For all messages received in this connection type, the Subordinate Transaction Manager Facet MUST process the message as specified in section 3.1.

Also, the Subordinate Transaction Manager Facet MUST override the default state verification actions for incoming messages as specified in section 3.1.6 in the following manner:

- If the current connection state does not define a processing rule for the message:
 - Send a PARTNERTM_PROPAGATE_MTAG_PROTOCOL_ERROR message using the connection.
 - Perform default invalid message processing, as specified in section 3.1.6.

The Subordinate Transaction Manager Facet MUST additionally follow the processing rules as specified in the following sections.

3.8.5.1.2.1.1 Receiving a PARTNERTM_BRANCH_MTAG_BRANCHED Message

When the Subordinate Transaction Manager Facet (section 1.3.3.3.5) receives a PARTNERTM_BRANCH_MTAG_BRANCHED (section 2.2.9.1.2.1.6) message, the Subordinate Transaction Manager Facet MUST perform the following actions:

- If the connection state is Awaiting Branch Response:
 - Set the connection state to Active.
 - Create an Enlistment object with the following values:
 - The Subordinate Transaction Manager Facet
 - The transaction object referenced by the connection's Connection-Specific Data field
 - This connection object
 - Set this connection's **enlistment** field to reference the new Enlistment object.
 - Signal the Branch Transaction Success (section 3.2.7.9) event on the Core Transaction Manager Facet (section 1.3.3.3.1) with the Enlistment object.
- Otherwise, the message MUST be processed as an invalid message as specified in section 3.1.6.

3.8.5.1.2.1.2 Receiving a PARTNERTM_BRANCH_MTAG_BRANCH_LOG_FULL, PARTNERTM_BRANCH_MTAG_BRANCH_NO_MEM, PARTNERTM_BRANCH_MTAG_BRANCH_TOO_LATE, PARTNERTM_BRANCH_MTAG_BRANCH_TOO_MANY, or PARTNERTM_BRANCH_MTAG_BRANCH_TX_NOT_FOUND Message

When the Subordinate Transaction Manager Facet receives one of these messages, the Subordinate Transaction Manager Facet MUST perform the following actions:

- If the connection state is Awaiting Branch Response:

- Create an Enlistment object with a reference to the Subordinate Transaction Manager Facet, a reference to this connection, and a reference to the transaction object referenced by this connection.
- Signal the Branch Transaction Failure event on the Core Transaction Manager Facet with the following arguments:
 - The Enlistment object.
 - The failure code that matches the incoming message:
 - PARTNERTM_BRANCH_MTAG_BRANCH_LOG_FULL: Log Full Remote
 - PARTNERTM_BRANCH_MTAG_BRANCH_NO_MEM: No Mem Remote
 - PARTNERTM_BRANCH_MTAG_BRANCH_TOO_LATE: Too Late
 - PARTNERTM_BRANCH_MTAG_BRANCH_TOO_MANY: Too Many Remote
 - PARTNERTM_BRANCH_MTAG_BRANCH_TX_NOT_FOUND: Tx Not Found
 - Set the connection state to Ended.
- Otherwise, the message MUST be processed as an invalid message as specified in section 3.1.6.

3.8.5.1.2.1.3 Receiving a PARTNERTM_PROPAGATE_MTAG_PHASE0REGISTERED Message

When the Subordinate Transaction Manager Facet (section 1.3.3.3.5) receives a PARTNERTM_PROPAGATE_MTAG_PHASE0REGISTERED (section 2.2.9.1.1.1.15) message, the Subordinate Transaction Manager Facet MUST perform the following actions:

- If the connection state is Awaiting Registration Response:
 - Set the connection state to Awaiting Phase Zero.
 - Signal the Register Phase Zero Success (section 3.2.7.29) event on the Core Transaction Manager Facet (section 1.3.3.3.1) with the Enlistment object referenced by this connection.
- Otherwise, if the connection state is Awaiting Registration Response During Phase Zero:
 - Set the connection state to Awaiting Phase Zero Outcome With Outstanding Registration.
 - Signal the Register Phase Zero Success event on the Core Transaction Manager Facet with the Enlistment object referenced by this connection.
- Otherwise, the message MUST be processed as an invalid message as specified in section 3.1.6.

3.8.5.1.2.1.4 Receiving a PARTNERTM_PROPAGATE_MTAG_PHASE0REGISTRATIONREJECTED Message

When the Subordinate Transaction Manager Facet (section 1.3.3.3.5) receives a PARTNERTM_PROPAGATE_MTAG_PHASE0REGISTRATIONREJECTED (section 2.2.9.1.1.1.16) message, the Subordinate Transaction Manager Facet MUST perform the following actions:

- If the connection state is Awaiting Registration Response:
 - Set the connection state to Active.

- Signal the Register Phase Zero Failure (section 3.2.7.28) event on the Core Transaction Manager Facet (section 1.3.3.3.1) with the following arguments:
 - The Enlistment object referenced by this connection.
 - A failure reason of Too Late.
- Otherwise, if the connection state is Awaiting Registration Response During Phase Zero:
 - Set the connection state to Awaiting Phase Zero Outcome.
 - Signal the Register Phase Zero Failure event on the Core Transaction Manager Facet with the following arguments:
 - The Enlistment object referenced by this connection.
 - A failure reason of Too Late.
- Otherwise, the message MUST be processed as an invalid message as specified in section 3.1.6.

3.8.5.1.2.1.5 Receiving a PARTNERTM_PROPAGATE_MTAG_ABORTREQ Message

When the Subordinate Transaction Manager Facet receives a PARTNERTM_PROPAGATE_MTAG_ABORTREQ message, the Subordinate Transaction Manager Facet MUST perform the following actions:

- If the connection state is either Active or Prepared:
 - Set the connection state to Aborting.
 - Signal the Begin Rollback event on the Core Transaction Manager Facet with the transaction object referenced by the Enlistment object referenced by this connection.
- Otherwise, the message MUST be processed as an invalid message as specified in section 3.1.6.

3.8.5.1.2.1.6 Receiving a PARTNERTM_PROPAGATE_MTAG_PHASE0 Message

When the Subordinate Transaction Manager Facet receives a PARTNERTM_PROPAGATE_MTAG_PHASE0 message, the Subordinate Transaction Manager Facet MUST perform the following actions:

- If the connection state is Awaiting Phase Zero:
 - Set the connection state to Awaiting Phase Zero Outcome.
 - Signal the Begin Phase Zero event on the Core Transaction Manager Facet with the transaction object referenced by the Enlistment object referenced by this connection.
- Otherwise, the message MUST be processed as an invalid message as specified in section 3.1.6.

3.8.5.1.2.1.7 Receiving a PARTNERTM_PROPAGATE_MTAG_PREPAREREQ Message

When the Subordinate Transaction Manager Facet receives a PARTNERTM_PROPAGATE_MTAG_PREPAREREQ message, the Subordinate Transaction Manager Facet MUST perform the following actions:

- If the connection state is Active:
 - Set the connection state to Preparing.
 - Signal the Begin Phase One event on the Core Transaction Manager Facet with the following arguments:

- The transaction object referenced by the Enlistment object referenced by the receiving connection.
- If the **fSinglePhase** field of the message is set to 0x00000000:
 - Set the **Single Phase Commit** flag to false.
- Otherwise:
 - Set the **Single Phase Commit** flag to true.
- Otherwise, the message MUST be processed as an invalid message as specified in section 3.1.6.

3.8.5.1.2.1.8 Receiving a PARTNERTM_PROPAGATE_MTAG_COMMITREQ Message

When the Subordinate Transaction Manager Facet receives a PARTNERTM_PROPAGATE_MTAG_COMMITREQ message, the Subordinate Transaction Manager Facet MUST perform the following actions:

- If the connection state is Prepared:
 - Set the connection state to Committing.
 - Signal the Begin Commit on the Core Transaction Manager Facet event with the transaction object referenced by the Enlistment object referenced by this connection.
- Otherwise, the message MUST be processed as an invalid message as specified in section 3.1.6.

3.8.5.1.2.1.9 Receiving a PARTNERTM_PROPAGATE_MTAG_PROTOCOL_ERROR Message

The processing of this event MUST be identical to the processing of the Connection Disconnected event.

3.8.5.1.2.1.10 Connection Disconnected

When a CONNTYPE_PARTNERTM_BRANCH (section 2.2.9.1.2.1) connection is disconnected, the Subordinate Transaction Manager Facet (section 3.8) MUST perform the following actions:

- If the connection state is Prepared:
 - Signal the Recover In Doubt Transaction (section 3.8.7.8) event on the Subordinate Transaction Manager Facet (section 3.8) with the Enlistment object referenced by this connection.
- Otherwise, if the connection state is Preparing:
 - If the transaction object's Single Phase Commit flag (defined in section 3.2.1) is false, signal the Begin Rollback (section 3.2.7.6) event on Core Transaction Manager Facet (section 1.3.3.3.1) with the transaction object referenced by the Enlistment object referenced by this connection.
 - Otherwise, the event MUST be processed as specified in section 3.1.8.3.
- Otherwise, if the connection state is Awaiting Branch Response:
 - Create an Enlistment object with the following values:
 - The Subordinate Transaction Manager Facet (section 3.8).
 - The transaction object in the Connection-Specific Data field of this connection.

- This connection object.
- Signal the Branch Transaction Failure (section 3.2.7.8) event on the Core Transaction Manager Facet (section 1.3.3.3.1) with the following arguments:
 - The new enlistment object.
 - A failure code of Comm Failed.
- Set the connection state to Ended.
- Otherwise, if the connection state is Active, Awaiting Registration Response, Awaiting Registration Response During Phase Zero, Awaiting Phase Zero, Awaiting Phase Zero Outcome, or Awaiting Phase Zero Outcome With Outstanding Registration:
 - Signal the Begin Rollback (section 3.2.7.6) event on the Core Transaction Manager Facet (section 1.3.3.3.1) with the transaction object referenced by this connection.
- Otherwise, the event MUST be processed as specified in section 3.1.8.3.

3.8.5.2 Transaction Recovery

3.8.5.2.1 Subordinate-Driven Recovery

3.8.5.2.1.1 CONNTYPE_PARTNERTM_CHECKABORT as Initiator

For all messages received in this connection type, the Subordinate Transaction Manager Facet MUST process the message in accordance with section 3.8. The Subordinate Transaction Manager MUST additionally follow the processing rules specified in the following sections.

3.8.5.2.1.1.1 Receiving a PARTNERTM_CHECKABORT_MTAG_ABORTED Message

When the Subordinate Transaction Manager Facet (section 1.3.3.3.5) receives a PARTNERTM_CHECKABORT_MTAG_ABORTED (section 2.2.9.2.1.1.2) message, the Subordinate Transaction Manager MUST perform the following actions:

- If the connection state is Awaiting Confirmation:
 - Signal the Begin Rollback (section 3.2.7.6) event on the Core Transaction Manager Facet (section 1.3.3.3.1) with the:
 - The transaction object referenced by the Enlistment object referenced by this connection.
 - Set the Connection state to Ended.
- Otherwise, the message MUST be processed as an invalid message as specified in section 3.1.6.

3.8.5.2.1.1.2 Receiving a PARTNERTM_CHECKABORT_MTAG_RETRY Message

When the Subordinate Transaction Manager Facet receives a PARTNERTM_CHECKABORT_MTAG_RETRY message, the Subordinate Transaction Manager Facet MUST perform the following actions:

- If the connection state is Awaiting Confirmation:
 - Set the connection state to Waiting to Rerequest.
 - Initialize a Check Abort Timer with the following arguments:
 - The connection's Enlistment object

- An implementation-specific time-out value
- Otherwise, the message MUST be processed as an invalid message as specified in section 3.1.6.

3.8.5.2.1.1.3 CONNTYPE_PARTNERTM_CHECKABORT Connection Disconnected

When a CONNTYPE_PARTNERTM_CHECKABORT (section 2.2.9.2.1.1) connection is disconnected, the Subordinate Transaction Manager Facet (section 3.8) MUST perform the following actions:

- If the connection state is Waiting to Rerequest:
 - Cancel the Check Abort Timer associated with the connection.
- If the connection state is Idle, Waiting to Rerequest, or Awaiting Confirmation:
 - Signal the Recover In Doubt Transaction (section 3.8.7.8) event on the Subordinate Transaction Manager Facet (section 1.3.3.3.5) with the Enlistment object referenced by this connection.
 - Set the connection state to Ended.
- Finally, in all cases, the event MUST be processed as specified in section 3.1.8.3.

3.8.5.2.2 Superior-Driven Recovery

3.8.5.2.2.1 CONNTYPE_PARTNERTM_REDELIVERCOMMIT as Acceptor

For all messages received in this connection type, the Subordinate Transaction Manager Facet MUST process the message in accordance with section 3.8. The Subordinate Transaction Manager Facet MUST additionally follow the processing rules specified in the following sections.

3.8.5.2.2.1.1 Receiving a PARTNERTM_REDELIVERCOMMIT_MTAG_COMMITREQ Message

When the subordinate transaction manager receives a PARTNERTM_REDELIVERCOMMIT_MTAG_COMMITREQ (section 2.2.9.2.2.1.1) message, the Subordinate Transaction Manager Facet (section 1.3.3.3.5) MUST perform the following actions:

- If the connection state is Idle:
 - Set the connection state to Processing Commit Inquiry.
 - Find the transaction object in the transaction manager's transaction table, using the **guidTx** field from the message as a key.
 - If the transaction object is not found:
 - Send a PARTNERTM_REDELIVERCOMMIT_MTAG_COMMITREQDONE (section 2.2.9.2.2.1.2) message using the connection.
 - Set the connection state to Ended.
 - Otherwise, if the transaction state is either Phase One Complete (section 3.2.1.3.8) or In Doubt (section 3.2.1.3.12):
 - Signal the Cancel Check Abort (section 3.8.7.2) event on the Subordinate Transaction Manager Facet with the transaction object.
 - Signal the Begin Commit (section 3.2.7.2) event on the Core Transaction Manager Facet (section 1.3.3.3.1) with the transaction object.

- Otherwise:
 - Send a PARTNERTM_REDELIVERCOMMIT_MTAG_RETRY (section 2.2.9.2.2.1.3) message using the connection.
 - Set the connection state to Idle.
- Otherwise, the message MUST be processed as an invalid message as specified in section 3.1.8.1.

3.8.5.2.2.1.2 Connection Disconnected

When a CONNTYPE_PARTNERTM_REDELIVERCOMMIT (section 2.2.9.2.2.1) connection is disconnected, the Subordinate Transaction Manager Facet (section 1.3.3.3.5) MUST perform the actions as specified in section 3.1.8.3.

3.8.6 Timer Events

3.8.6.1 Check Abort Timer

When this timer expires, the Subordinate Transaction Manager Facet (section 1.3.3.3.5) MUST perform the following actions:

- If the connection referenced by the provided enlistment is in the Waiting to Rerequest state:
 - Set the connection state to Idle.
 - Send a PARTNERTM_CHECKABORT_MTAG_CHECK (section 2.2.9.2.1.1.1) message using the connection referenced by the provided Enlistment object:
 - Set the **guidTX** field to the provided Enlistment object's transaction object's **Transaction Object.Identifier** field.
 - Set the connection state to Awaiting Confirmation.
- Otherwise, ignore the timer event.

3.8.7 Other Local Events

A Subordinate Transaction Manager Facet MUST be prepared to process the local events defined in the following sections.

The subordinate transaction manager MUST be prepared to process local events pertaining to Phase Zero functionality only on versions where the connection type CONNTYPE_TXUSER_PHASE0 is supported. Version-Specific Aspects of Connection Types Relevant to a Resource Manager (section 2.2.1.1.3) defines protocol version support for this connection type. The following local events are affected:

- Register Phase Zero
- Phase Zero Complete

3.8.7.1 Branch Transaction

The Branch Transaction event MUST be signaled with the following arguments:

- A transaction object
- A Name object representing the remote superior transaction manager

If the Branch Transaction event is signaled, the Subordinate Transaction Manager Facet (section 3.8) MUST perform the following actions:

- Initiate a new CONNTYPE_PARTNERTM_BRANCH (section 2.2.9.1.2.1) connection to the provided Name object.
- Assign the provided transaction object to the connection's Connection-Specific Data field.
- Send a PARTNERTM_BRANCH_MTAG_BRANCHING (section 2.2.9.1.2.1.7) message using the connection:
 - Set the **guidTX** field to the provided **Transaction Object.Identifier** field of the transaction object.
- Set the connection state to Awaiting Branch Response (section 3.8.1.2.2).

3.8.7.2 Cancel Check Abort

The Cancel Check Abort event MUST be signaled with the following arguments:

- A transaction object.

If the Cancel Check Abort event is signaled, the Subordinate Transaction Manager Facet (section 3.8) MUST perform the following actions:

- Find a connection object of type CONNTYPE_PARTNERTM_CHECKABORT (section 2.2.9.2.1.1) in the transaction object's Connection list.
- If no such connection is found, ignore the event.
- Otherwise:
 - If a Check Abort timer is active for the transaction, cancel it.
 - Set the connection state to Ended.

3.8.7.3 Commit Complete

The Commit Complete event MUST be signaled with the following arguments:

- An Enlistment object

If the Commit Complete event is signaled, the Subordinate Transaction Manager Facet (section 3.8) MUST perform the following actions:

- If the provided enlistment's connection is of type CONNTYPE_TXUSER_BRANCH (section 2.2.9.1.2.1) or CONNTYPE_PARTNERTM_PROPAGATE (section 2.2.9.1.1.1):
 - Send a PARTNERTM_PROPAGATE_MTAG_COMMITREQDONE (section 2.2.9.1.1.1.10) message using the provided enlistment's connection.
 - Set the connection state to Ended.
- Otherwise, if the provided enlistment's connection is of type CONNTYPE_PARTNERTM_REDELIVERCOMMIT (section 2.2.9.2.2.1):
 - Send a PARTNERTM_REDELIVERCOMMIT_MTAG_COMMITREQDONE (section 2.2.9.2.2.1.2) message using the provided enlistment's connection.
 - Set the connection state to Ended.

3.8.7.4 Create Superior Enlistment Success

The Create Superior Enlistment Success event MUST be signaled with the following arguments:

- An Enlistment object

If the Create Superior Enlistment Success event is signaled, the Subordinate Transaction Manager Facet (section 3.8) MUST perform the following actions:

- Send a PARTNERTM_PROPAGATE_MTAG_PROPAGATED (section 2.2.9.1.1.1.2) message using the provided enlistment's connection:
- Set the connection state to Active.

3.8.7.5 Create Superior Enlistment Failure

The Create Superior Enlistment event MUST be signaled with the following arguments:

- An Enlistment object.
- A value indicating the failure reason. The reason MUST be set to one of the following values:
 - Duplicate
 - Log Full

If the Create Superior Enlistment Failure event is signaled, the Subordinate Transaction Manager Facet (section 3.8) MUST perform the following actions:

- Send the matching message for the following reason codes using the provided enlistment's connection:
 - Duplicate: PARTNERTM_PROPAGATE_MTAG_DUPLICATE (section 2.2.9.1.1.1.3)
 - Log Full: PARTNERTM_PROPAGATE_MTAG_LOG_FULL (section 2.2.9.1.1.1.5)
- Set the connection state to Ended.

3.8.7.6 Phase Zero Complete

The Phase Zero Complete event MUST be signaled with the following arguments:

- An Enlistment object.
- An outcome value. This value MUST be one of the following:
 - Success
 - Failure

If the Phase Zero Complete event is signaled, the Subordinate Transaction Manager Facet (section 3.8) MUST perform the following actions:

- If the provided outcome is Success:
 - Send a PARTNERTM_PROPAGATE_MTAG_PHASE0COMPLETE (section 2.2.9.1.1.1.18) message using the provided enlistment's connection.
 - Set the connection state to Active.
- Otherwise:

- Send a PARTNERTM_PROPAGATE_MTAG_ABORTNOTIFY (section 2.2.9.1.1.1.13) message using the provided enlistment's connection.
- Set the connection state to Ended.

3.8.7.7 Phase One Complete

The Phase One Complete event MUST be signaled with the following arguments:

- An Enlistment object.
- A value indicating the outcome of Phase One. The value MUST be set to one of the following values:
 - Read Only
 - Prepared
 - Committed
 - Aborted
 - In Doubt

If the Phase One Complete event is signaled, the Subordinate Transaction Manager Facet (section 3.8) MUST perform the following actions:

- If the provided outcome is Read Only:
 - Send a PARTNERTM_PROPAGATE_MTAG_PREPAREREQDONE (section 2.2.9.1.1.1.7) message using the provided enlistment's connection:
 - Set the **prepareReqDone** field to PARTNERTM_PROPAGATE_PREPAREREQDONE_READ_ONLY.
 - Set the **guidReason** field to the value provided by the higher-layer business logic, as specified in section 2.2.9.1.1.1.7.
 - Set the connection state to **Ended**.
- Otherwise, if the provided outcome is Prepared:
 - Send a PARTNERTM_PROPAGATE_MTAG_PREPAREREQDONE (section 2.2.9.1.1.1.7) message using the provided enlistment's connection:
 - Set the **prepareReqDone** field to PARTNERTM_PROPAGATE_PREPAREREQDONE_OK.
 - Set the connection state to **Ended**.
- Otherwise, if the provided outcome is Committed:
 - Send a PARTNERTM_PROPAGATE_MTAG_PREPAREREQDONE (section 2.2.9.1.1.1.7) message using the connection:
 - Set the **prepareReqDone** field to PARTNERTM_PROPAGATE_PREPAREREQDONE_SINGLEPHASE_COMMIT.
 - Set the connection state to **Ended**.
- Otherwise, if the provided outcome is Aborted:

- Send a PARTNERTM_PROPAGATE_MTAG_PREPAREREQDONE (section 2.2.9.1.1.1.7) message using the connection:
 - Set the **prepareReqDone** field MUST to PARTNERTM_PROPAGATE_PREPAREREQDONE_ABORT.
 - Set the connection state to **Ended**.
- Otherwise, if the provided outcome is In Doubt (section 3.2.1.3.12):
 - Send a PARTNERTM_PROPAGATE_MTAG_PREPAREREQDONE (section 2.2.9.1.1.1.7) message using the connection:
 - Set the **prepareReqDone** field MUST to PARTNERTM_PROPAGATE_PREPAREREQDONE_SINGLEPHASE_INDOUBT.
 - Set the connection state to **Ended**.

3.8.7.8 Recover In Doubt Transaction

The Recover In Doubt Transaction event MUST be signaled with the following arguments:

- An Enlistment object

If the Recover In Doubt Transaction event is signaled, the Subordinate Transaction Manager Facet (section 3.8) MUST perform the following actions:

- Initiate a new CONNTYPE_PARTNERTM_CHECKABORT (section 2.2.9.2.1.1) connection using the Name object referenced by the **Name** field of the Session object containing the provided Enlistment's connection.
- Send a PARTNERTM_CHECKABORT_MTAG_CHECK (section 2.2.9.2.1.1.1) message using the connection:
 - Set the **guidTX** field to the **Transaction Object.Identifier** field of the transaction object referenced by the provided Enlistment object.
- Set the connection state to Awaiting Confirmation.

3.8.7.9 Register Phase Zero

The Register Phase Zero event MUST be signaled with the following arguments:

- An Enlistment object

If the Register Phase Zero event is signaled, the Subordinate Transaction Manager Facet (section 3.8) MUST perform the following actions:

- If the provided enlistment's connection state is Active:
 - Set the connection state to Awaiting Registration Response (section 3.8.1.1.5).
 - Send a PARTNERTM_PROPAGATE_MTAG_PHASE0REGISTER (section 2.2.9.1.1.1.14) message using the connection.
- Otherwise, if the connection state is Awaiting Phase Zero Outcome:
 - Set the connection state to Awaiting Registration Response During Phase Zero (section 3.8.1.1.8).

- Send a PARTNERTM_PROPAGATE_MTAG_PHASE0REGISTER (section 2.2.9.1.1.1.14) message using the enlistment's connection.
- Otherwise:
 - Signal the Register Phase Zero Failure (section 3.2.7.28) on the Core Transaction Manager Facet (section 1.3.3.3.1) with the following arguments:
 - The provided Enlistment object
 - The Too Late reason code

3.8.7.10 Rollback Complete

The Rollback Complete event MUST be signaled with the following arguments:

- An Enlistment object

If the Rollback Complete event is signaled, the Subordinate Transaction Manager Facet (section 3.8) MUST perform the following actions:

- If the provided enlistment's connection is of type CONNTYPE_PARTNERTM_BRANCH (section 2.2.9.1.2.1) or CONNTYPE_PARTNERTM_PROPAGATE (section 2.2.9.1.1.1)
 - Send a PARTNERTM_PROPAGATE_MTAG_ABORTREQDONE (section 2.2.9.1.1.1.12) message using the provided enlistment's connection.
 - Set the connection state to Ended.
- Otherwise, ignore the signal.

3.8.7.11 Unilaterally Aborted

The Unilaterally Aborted event MUST be signaled with the following arguments:

- An Enlistment object

If the Unilaterally Aborted event is signaled, the Subordinate Transaction Manager Facet (section 3.8) MUST perform the following actions:

- If the provided enlistment's connection state is Aborting:
 - Ignore the signal.
- Otherwise:
 - Send a PARTNERTM_PROPAGATE_MTAG_ABORTNOTIFY (section 2.2.9.1.1.1.13) message using the provided enlistment's connection.
 - Set the connection state to Ended.

4 Protocol Examples

The following sections describe several operations as used in common scenarios to illustrate the function of this protocol. These protocol examples generally assume that an OleTx transports session, as specified in [MS-CMPO] section 3.2.1.2, has already been established between the two participants. However, some examples exhibit how one participant establishes a new OleTx transports session with another participant because of the protocol that is being demonstrated.

Participants communicate with each other by using OleTx multiplexing connections, as specified in [MS-CMP] section 3.1.1.1, that are in turn layered on top of the OleTx transports infrastructure (as specified in [MS-CMPO] section 3.3.1). In these examples, messages are sent from one participant to another by submitting a MESSAGE_PACKET (section 2.2.4.1) to the underlying OleTx multiplexing layer, as specified in [MS-CMP] section 3.1.4.1.

4.1 Simple Transaction Scenario

This scenario shows how an application creates and completes a transaction. The scenario begins with the application establishing a transport session with a transaction manager and negotiating its connection resources.

4.1.1 Beginning a Transaction

This packet sequence is initiated by starting a connection on a transport session between an application and a transaction manager.

CONNTYPE_TXUSER_BEGIN2: The packet sequence starts when an application initiates a connection using CONNTYPE_TXUSER_BEGIN2.

Field	Value	Value description
MsgTag	0x00000005	MTAG_CONNECTION_REQ
fIsMaster	0x00000001	1
dwConnectionId	0x00000001	1
dwUserMsgType	0x00000028	CONNTYPE_TXUSER_BEGIN2
dwcbVarLenData	0x00000000	0
dwReserved1	0xcd64cd64	dwReserved1: 0xcd64cd64

The application then sends a TXUSER_BEGIN2_MTAG_BEGIN user message specifying the isolation level, time-out, transaction description, and isolation flag. For this example, the application requests a transaction with ISOLATIONLEVEL_SERIALIZABLE, a time-out of 60 seconds, a description of "sample transaction", and ISOFLAG_RETAIN_DONTCARE.

Field	Value	Value description
MsgTag	0x000000FF	MTAG_USER_MESSAGE
fIsMaster	0x00000001	1
dwConnectionId	0x00000001	1
dwUserMsgType	0x00006002	TXUSER_BEGIN2_MTAG_BEGIN
dwcbVarLenData	0x00000034	52

Field	Value	Value description
dwReserved1	0xcd64cd64	dwReserved1: 0xcd64cd64
isoLevel	0x00100000	ISOLATIONLEVEL_SERIALIZABLE
dwTimeout	0x0000EA60	60000
szDesc	0x706D6173 0x7420656C 0x736E6172 0x69746361 0x00006E6F 0x00000000 0x00000000 0x00000000 0x00000000 0x00000000 0x00000000	"sample transaction"
isoFlags	0x00000005	ISOFLAG_RETAIN_DONTCARE

When the transaction manager receives the TXUSER_BEGIN2_MTAG_BEGIN message from the application, the transaction manager attempts to create a transaction object with a globally unique identifier (GUID) as its identifier. If the transaction manager successfully creates the transaction, it sends a TXUSER_BEGIN2_MTAG_SINK_BEGUN user message to the application specifying the transaction identifier as the *guidTx* field (for example, 4046037e-9722-46c9-9883-99062341cb35), and the transaction manager adds the transaction to its list of known transaction objects.

Field	Value	Value description
MsgTag	0x00000FFF	MTAG_USER_MESSAGE
fIsMaster	0x00000000	0
dwConnectionId	0x00000001	1
dwUserMsgType	0x00006006	TXUSER_BEGIN2_MTAG_SINK_BEGUN
dwcbVarLenData	0x00000010	16
dwReserved1	0xcd64cd64	dwReserved1: 0xcd64cd64
guidTx	0x4046037E 0x46C99722 0x06999883 0x35CB4123	4046037e-9722-46c9-9883-99062341cb35

4.1.2 Completing a Transaction

After the transaction begins, the application decides whether to commit or abort the transaction. If the application disconnects the connection before committing or aborting the transaction, the transaction manager assumes that the transaction aborts.

4.1.2.1 Committing the Transaction

The application commits the transaction by sending a TXUSER_BEGIN2_MTAG_COMMIT user message specifying a value of zero in the unused **grFRM** field.

Field	Value	Value description
MsgTag	0x000000FF	MTAG_USER_MESSAGE
fIsMaster	0x00000001	1
dwConnectionId	0x00000001	1
dwUserMsgType	0x00006003	TXUSER_BEGIN2_MTAG_COMMIT
dwcbVarLenData	0x00000004	4
dwReserved1	0xcd64cd64	dwReserved1: 0xcd64cd64
grFRM	0x00000000	0

In response, the transaction manager attempts to commit the transaction by using a two-phase commit. If the transaction manager successfully completes Phase One of the transaction, the transaction manager sends a TXUSER_BEGIN2_MTAG_SINK_ERROR user message to the application with TRUN_TXBEGIN_ERROR_NOTIFY_COMMITTED specified in the **Error** field.

Field	Value	Value description
MsgTag	0x000000FF	MTAG_USER_MESSAGE
fIsMaster	0x00000000	0
dwConnectionId	0x00000001	1
dwUserMsgType	0x00006005	TXUSER_BEGIN2_MTAG_SINK_ERROR
dwcbVarLenData	0x00000004	4
dwReserved1	0xcd64cd64	dwReserved1: 0xcd64cd64
Error	0x0000001F	TRUN_TXBEGIN_ERROR_NOTIFY_COMMITTED

After the application gets the TXUSER_BEGIN2_MTAG_SINK_ERROR response from its transaction manager, no more user messages can be sent on this connection and the application initiates the disconnect sequence.

4.2 Transaction Marshaling Scenario (Pull Propagation)

This scenario shows how an application (or resource manager) on Machine1 marshals an existing transaction to an application or resource manager on Machine2 by using pull propagation. Because the receiving application obtains knowledge of an existing transaction, it is implied that another application exists that has access to an existing transaction. The receiving application obtains the necessary information from the existing transaction. Because OleTx does not prescribe application-to-application communication, an out-of-band mechanism (such as an application API) needs to be available to transfer this knowledge from the sending application to the receiving application.

Pull propagation involves three main stages. In the first stage, the sending application (or sender) packages information about an existing transaction and sends the information to the receiving application (or receiver) — this is called marshaling the transaction.

During the second stage (unmarshaling the transaction), the receiver requests an association with the transmitted transaction. If the transaction manager of the receiver does not have a reference for the requested transaction, it enters the third stage and attempts to add itself as a subordinate branch of the transaction by using the transaction manager of the sender.

This scenario requires that the receiving application has established a transport session with a transaction manager and has negotiated its connection resources. The scenario also assumes that there is an out-of-band mechanism (an application API) that the sending and receiving applications use to exchange transactional information. In general, this API is also necessary for the sending application to prescribe work for the receiving application to perform as part of the transaction.

4.2.1 Marshaling the Transaction

To marshal a transaction from the sending application to the receiving application, several pieces of information need to be transmitted to the receiver. The receiver needs to have sufficient knowledge of the existing transaction. That knowledge includes the transaction identifier, the isolation level, the isolation flag, and the description of the transaction.

The receiver also needs to have sufficient locative information of the sender's transaction manager in order for the receiver's transaction manager to establish a communication session with the sender's transaction manager (that is, the OLETX_TM_ADDR). The OLETX_TM_ADDR includes the host name of the sender's transaction manager, its contact identifier, and the RPC communication protocols that the transaction manager of the sender supports.

The transaction information and the sender transaction manager endpoint information are marshaled to a Propagation Token structure, as specified in section 2.2.5.4.

Field	Value	Description
dwVersionMin	0x00000001	1
dwVersionMax	0x00000002	2
guidTx	0x4046037E 0x46C99722 0x06999883 0x35CB4123	4046037e-9722-46c9-9883-99062341cb35
isoLevel	0x00100000	ISOLATIONLEVEL_SERIALIZABLE
isoFlags	0x00000005	ISOFLAG_RETAIN_DONTCARE
cbSourceTmAddr	0x00000058	88
szDesc	0x706D6173 0x7420656C 0x736E6172 0x69746361 0x00006E6F 0x00000000 0x00000000 0x00000000 0x00000000 0x00000000 0x00000000	"sample-transaction"
szGuid	0x30616162 0x35373734	"BAA04775-8F43-4F49-ADEF-5A1B2151190B"

Field	Value	Description
	0x3466382d 0x66342d33 0x612d3934 0x2d666564 0x62316135 0x31353132 0x62303931 0x00000000	
dwcbHostName	0x0000000a	10
dwReserved1	0xcd64cd64	dwReserved1: 0xcd64cd64
grbComProtsSupported	0x00000021	PROT_IP_TCP PROT_LRPC
szHostName	0x6863614d 0x5f656e69 0x00000031	"Machine_1"
cbHostNameW	0x00000014	20
wszHostname	0x0061004D 0x00680063 0x006E0069 0x005F0065 0x00000031	L"Machine_1"

4.2.2 Unmarshaling the Transaction

To begin the unmarshaling process, the receiving application initiates a connection over its transport session with its transaction manager.

CONNTYPE_TXUSER_ASSOCIATE: The packet sequence starts when the receiving application initiates a connection by using CONNTYPE_TXUSER_ASSOCIATE.

Field	Value	Value description
MsgTag	0x00000005	MTAG_CONNECTION_REQ
fIsMaster	0x00000001	1
dwConnectionId	0x00000001	1
dwUserMsgType	0x00000011	CONNTYPE_TXUSER_ASSOCIATE
dwcbVarLenData	0x00000000	0
dwReserved1	0xcd64cd64	dwReserved1: 0xcd64cd64

The receiving application then sends a TXUSER_ASSOCIATE_MTAG_ASSOCIATE user message with the information transmitted to the receiver in the Propagation Token.

Field	Value	Value description
MsgTag	0x000000FF	MTAG_USER_MESSAGE
fIsMaster	0x00000001	1
dwConnectionId	0x00000001	1
dwUserMsgType	0x00002031	TXUSER_ASSOCIATE_MTAG_ASSOCIATE
dwcbVarLenData	0x0000007C	124
dwReserved1	0xcd64cd64	dwReserved1: 0xcd64cd64
guidTx	0x4046037E 0x46C99722 0x06999883 0x35CB4123	4046037e-9722-46c9-9883-99062341cb35
isoLevel	0x00100000	ISOLATIONLEVEL_SERIALIZABLE
isoFlags	0x00000005	ISOFLAG_RETAIN_DONTCARE
cbSourceTmAddr	0x00000038	56
szDesc	0x706D6173 0x7420656C 0x736E6172 0x69746361 0x00006E6F 0x00000000 0x00000000 0x00000000 0x00000000 0x00000000	"sample transaction"
guidSignature	0xDC85CB48 0x11d2D8A5 0x8000828B 0x5AF70D5F	DC85CB48-D8A5-11d2-828B-00805F0DF75A
guidEndpoint	0xBAA04775 0x4F498F43 0x1B5AADEF 0x0B195121	BAA04775-8F43-4F49-ADEF-5A1B2151190B
grbComProtsSupported	0x00000021	PROT_IP_TCP PROT_LRPC
wszHostName	0x0061004d 0x00680063 0x006e0069 0x005f0065 0x00000031	L"Machine_1"

When the receiver's transaction manager receives the TXUSER_ASSOCIATE_MTAG_ASSOCIATE message, that transaction manager attempts to locate the transaction in its list of transaction objects by using the transaction identifier. If the transaction object is not found locally, the transaction

manager attempts to pull the transaction from the sender's transaction manager by using information received from the TXUSER_ASSOCIATE_MTAG_ASSOCIATE message (compare Branching the Transaction).

If the receiver's transaction manager can successfully locate the transaction object or if the requested transaction is successfully pulled to the receiver's transaction manager, it replies to the receiver with a TXUSER_ASSOCIATE_MTAG_ASSOCIATED user message.

Field	Value	Value description
MsgTag	0x00000FFF	MTAG_USER_MESSAGE
fIsMaster	0x00000000	0
dwConnectionId	0x00000001	1
dwUserMsgType	0x00002032	TXUSER_ASSOCIATE_MTAG_ASSOCIATED
dwcbVarLenData	0x00000000	0
dwReserved1	0xcd64cd64	dwReserved1: 0xcd64cd64

After the receiving application gets the TXUSER_ASSOCIATE_MTAG_ASSOCIATED response from its transaction manager (or if it receives an error response), no more user messages can be sent on this connection and the receiver initiates the disconnect sequence.

4.2.3 Branching the Transaction

If the receiver's transaction manager does not have a reference to the requested transaction in its list of transaction objects, it attempts to contact the sender's transaction manager. If successful, it requests a subordinate branch to the transaction through the sender's transaction manager.

To branch the transaction, the receiver's transaction manager needs to have a transport session with the sender's transaction manager. If there is no existing transport session, the receiver's transaction manager uses the OLETX_TM_ADDR information about the sender's transaction manager from the Propagation-Token (section 2.2.5.4) to initiate a session between the two participants. Depending on the value of both participants' contact identifiers, the receiver's transaction manager initiates the transport session as either the primary or secondary partner.

To branch the transaction, the receiver's transaction manager initiates a connection over its transport session with the sender's transaction manager. If the transaction branching is successful, the superior transaction manager (that is, the sender's transaction manager) adds the receiver's transaction manager as a subordinate branch to the transaction.

CONNTYPE_PARTNERTM_BRANCH: The packet sequence starts when the receiver's transaction manager initiates a CONNTYPE_PARTNERTM_BRANCH connection with the sender's transaction manager.

Field	Value	Value description
MsgTag	0x00000005	MTAG_CONNECTION_REQ
fIsMaster	0x00000001	1
dwConnectionId	0x00000001	1
dwUserMsgType	0x00000104	CONNTYPE_PARTNERTM_BRANCH
dwcbVarLenData	0x00000000	0

Field	Value	Value description
dwReserved1	0xcd64cd64	dwReserved1: 0xcd64cd64

The receiver's transaction manager then sends a PARTNERTM_BRANCH_MTAG_BRANCHING user message with the transaction identifier of the requested transaction.

Field	Value	Value description
MsgTag	0x00000FFF	MTAG_USER_MESSAGE
fIsMaster	0x00000001	1
dwConnectionId	0x00000001	1
dwUserMsgType	0x00002051	PARTNERTM_BRANCH_MTAG_BRANCHING
dwcbVarLenData	0x00000010	16
dwReserved1	0xcd64cd64	dwReserved1: 0xcd64cd64
guidTx	0x4046037E 0x46C99722 0x06999883 0x35CB4123	4046037e-9722-46c9-9883-99062341cb35

If the sender's transaction manager is able to create a subordinate branch, it responds to the receiver's transaction manager with a user message with *dwUserMsgType* equal to PARTNERTM_BRANCH_MTAG_BRANCHED.

Field	Value	Value description
MsgTag	0x00000FFF	MTAG_USER_MESSAGE
fIsMaster	0x00000000	0
dwConnectionId	0x00000001	1
dwUserMsgType	0x00002052	PARTNERTM_BRANCH_MTAG_BRANCHED
dwcbVarLenData	0x00000000	0
dwReserved1	0xcd64cd64	dwReserved1: 0xcd64cd64

After receiving the PARTNERTM_BRANCH_MTAG_BRANCHED reply from the sender's transaction manager, the receiver's transaction manager keeps the connection open in order to process two-phase commit notifications from the sender's transaction manager. The sender's transaction manager has now become the superior transaction manager for this transaction; the receiver's transaction manager is now the subordinate transaction manager.

If the sender's transaction manager is unable to create a subordinate branch, it responds to the receiver's transaction manager with a user message with *dwUserMsgType* set to an error value. No more messages are sent on this connection and the receiver's transaction manager initiates the disconnect sequence. The receiver transaction manager then sends an appropriate error response to the receiver on the TXUSER_ASSOCIATE_MTAG_ASSOCIATE connection to inform the receiver of the failure to pull the transaction.

4.3 Transaction Marshaling Scenario (Push Propagation)

This scenario shows how an application or resource manager obtains access to an existing transaction through its transaction manager by using push propagation. Because the receiving application obtains knowledge of an existing transaction, this knowledge implies that there is another application that has access to an existing transaction. The receiving application obtains the necessary information from the existing transaction. Because OleTx does not prescribe application-to-application communication, an out-of-band mechanism (such as an application API) is needed to exchange this knowledge between the sending application and the receiving application.

Push propagation involves four main exchanges. The push sequence begins by the sending application (or sender) obtaining location information from the receiving application (or receiver) about its transaction manager, which is called the whereabouts. Subsequently, the sender uses the receiver's transaction manager whereabouts information to export the transaction. This exchange causes the sender's transaction manager to propagate the transaction to the receiver's transaction manager. The exchanges complete when the receiver imports the transaction from its transaction manager.

The scenario requires that the receiving application has established a transport session with a transaction manager and has negotiated its connection resources. The scenario also assumes that there is some out-of-band mechanism (an application API) that the sending and receiving applications use to exchange transactional information. In general, this API will also be necessary for the sending application to prescribe work for the receiving application to perform as part of the transaction.

4.3.1 Obtaining the Whereabouts of the Receiver's Transaction Manager

To push the transaction from the sender's transaction manager to the receiver's transaction manager, the sender obtains the location of the receiver's transaction manager. Specifically, the sender needs to populate an OLETX_TM_ADDR structure in order to perform an export. Typically, the receiver sends an SWhereabouts structure to the sender by using an out-of-band API. The SWhereabouts structure in this example contains two STmToTmProtocol structures: SDtcCmEndpointInfoV1 and SDtcCmEndpointInfoV2.

Field	Value	Value description
guidSignature	0x2ADB4462 0x11D0BD41 0xC000B12E 0xEFF3C24F	2ADB4462-BD41-11D0-B12E-00C04FC2F3EF
cTmToTmProtocols	0x00000002	2
tmprotDescribed	0x00000002	TmProtocolMsdtcV1
cbTmProtocolData	0x0000001C	28
comprotSupported	0x00000021	PROT_IP_TCP PROT_LRPC
guidEndpointID	0xD2A6A4B9 0x48ABCDB0 0x34E3A68F 0x28611A9B	D2A6A4B9-CDB0-48AB-A68F-E3349B1A6128
szHostname	0x6863614d 0x00026e69	"Machine_2"
tmprotDescribed	0x00000003	TmProtocolMsdtcV2
cbTmProtocolData	0x00000014	20

Field	Value	Value description
wszHostname	0x0061004d 0x00680063 0x006e0069 0x005f0065 0x00000031	L"Machine_2"

4.3.2 Exporting the Transaction

To export the transaction, the sending application needs to have a CONNTYPE_TXUSER_EXPORT connection established with the transaction manager. If a connection is not established, the sender needs to initiate one now.

CONNTYPE_TXUSER_EXPORT: The packet sequence starts when the sender initiates a CONNTYPE_TXUSER_EXPORT connection with its transaction manager.

Field	Value	Value description
MsgTag	0x00000005	MTAG_CONNECTION_REQ
fIsMaster	0x00000001	1
dwConnectionId	0x00000002	2
dwUserMsgType	0x00000004	CONNTYPE_TXUSER_EXPORT
dwcbVarLenData	0x00000000	0
dwReserved1	0xcd64cd64	dwReserved1: 0xcd64cd64

The sending application then sends to its transaction manager a TXUSER_EXPORT_MTAG_CREATE user message on that connection specifying the receiver's transaction manager in an OLETX_TM_ADDR structure.

Field	Value	Value description
MsgTag	0x00000FFF	MTAG_USER_MESSAGE
fIsMaster	0x00000001	1
dwConnectionId	0x00000002	2
dwUserMsgType	0x00001041	TXUSER_EXPORT_MTAG_CREATE
dwcbVarLenData	0x00000038	56
dwReserved1	0xcd64cd64	dwReserved1: 0xcd64cd64
guidSignature	0xDC85CB48 0x11d2D8A5 0x8000828B 0x5AF70D5F	DC85CB48-D8A5-11d2-828B-00805F0DF75A
guidEndpoint	0xD2A6A4B9 0x48ABCDB0	D2A6A4B9-CDB0-48AB-A68F-E3349B1A6128

Field	Value	Value description
	0x34E3A68F 0x28611A9B	
grbComProtsSupported	0x00000021	PROT_IP_TCP PROT_LRPC
wszHostName	0x0061004d 0x00680063 0x006e0069 0x005f0065 0x00000032	L"Machine_2"

When the sender's transaction manager receives the create message, it converts the transaction manager information received in the OLETX_TM_ADDR structure to a Name object and stores the Name object in the **Connection-Specific Data** field of the connection object. If this operation is successful, the transaction manager responds to the sender with a TXUSER_EXPORT_MTAG_CREATED user message.

Field	Value	Value description
MsgTag	0x00000FFF	MTAG_USER_MESSAGE
fIsMaster	0x00000000	0
dwConnectionId	0x00000002	2
dwUserMsgType	0x00001042	TXUSER_EXPORT_MTAG_CREATED
dwcbVarLenData	0x00000000	0
dwReserved1	0xcd64cd64	dwReserved1: 0xcd64cd64

After the export connection is created, the sender requests that the transaction be exported to the receiver's transaction manager by sending a TXUSER_EXPORT_MTAG_EXPORT user message to its transaction manager. This message specifies the identifier of the transaction that the sender wants to have exported in the **guidTx** field of the message.

Field	Value	Value description
MsgTag	0x00000FFF	MTAG_USER_MESSAGE
fIsMaster	0x00000001	1
dwConnectionId	0x00000002	2
dwUserMsgType	0x00001043	TXUSER_EXPORT_MTAG_EXPORT
dwcbVarLenData	0x00000010	16
dwReserved1	0xcd64cd64	dwReserved1: 0xcd64cd64
guidTx	0x4046037E 0x46C99722 0x06999883 0x35CB4123	4046037e-9722-46c9-9883-99062341cb35

When the sender's transaction manager receives the export message, it attempts to propagate the transaction to the receiver's transaction manager. If the propagation is successful, the transaction manager sends to the sender a TXUSER_EXPORT_MTAG_EXPORTED user message.

Field	Value	Value description
MsgTag	0x00000FFF	MTAG_USER_MESSAGE
fIsMaster	0x00000000	0
dwConnectionId	0x00000002	2
dwUserMsgType	0x00001044	TXUSER_EXPORT_MTAG_EXPORTED
dwcbVarLenData	0x00000000	0
dwReserved1	0xcd64cd64	dwReserved1: 0xcd64cd64

When the sender receives the exported message, it sends information to the receiving application by using an out-of-band API that the exported transaction can be imported.

The sender can either close the export connection with its transaction manager by initiating the disconnect sequence, or it can maintain the connection for future exporting of transactions to the receiver's transaction manager.

4.3.3 Propagating the Transaction

When the sending transaction manager receives the export message from the sending application, the transaction manager attempts to propagate the transaction to the receiving transaction manager. If a transport session has not yet been established, the sending transaction manager attempts to establish the session now.

After a transport session is established between the sending transaction manager and the receiving transaction manager and resources are negotiated, the sending transaction manager initiates a CONNTYPE_PARTNERTM_PROPAGATE connection with the receiving transaction manager.

CONNTYPE_PARTNERTM_PROPAGATE: The packet sequence starts when the sending transaction manager initiates a CONNTYPE_PARTNERTM_PROPAGATE connection with the receiving transaction manager.

Field	Value	Value description
MsgTag	0x00000005	MTAG_CONNECTION_REQ
fIsMaster	0x00000001	1
dwConnectionId	0x00000001	1
dwUserMsgType	0x00000101	CONNTYPE_PARTNERTM_PROPAGATE
dwcbVarLenData	0x00000000	0
dwReserved1	0xcd64cd64	dwReserved1: 0xcd64cd64

The sending transaction manager then sends a PARTNERTM_PROPAGATE_MTAG_PROPAGATE user message to the receiving transaction manager and specifies the transaction identifier (guidTx), the isolation level (isoLevel), the transaction description (szDesc), and the isolation flags (isoFlags).

Field	Value	Value description
MsgTag	0x00000FFF	MTAG_USER_MESSAGE
fIsMaster	0x00000001	1
dwConnectionId	0x00000001	1
dwUserMsgType	0x00002001	PARTNERTM_PROPAGATE_MTAG_PROPAGATE
dwcbVarLenData	0x0000003c	60
dwReserved1	0xcd64cd64	dwReserved1: 0xcd64cd64
guidTx	0x4046037E 0x46C99722 0x06999883 0x35CB4123	4046037e-9722-46c9-9883-99062341cb35
isoLevel	0x00100000	ISOLATIONLEVEL_SERIALIZABLE
szDesc	0x706D6173 0x7420656C 0x736E6172 0x69746361 0x00006E6F 0x00000000 0x00000000 0x00000000 0x00000000 0x00000000 0x00000000	"sample transaction"

When the receiving transaction manager receives the message, it adds the transaction to its list of known transactions. If the propagation is successful, the receiving transaction manager sends to the sending transaction manager a PARTNERTM_PROPAGATE_MTAG_PROPAGATED user message.

Field	Value	Value description
MsgTag	0x00000FFF	MTAG_USER_MESSAGE
fIsMaster	0x00000000	0
dwConnectionId	0x00000001	1
dwUserMsgType	0x00002002	PARTNERTM_PROPAGATE_MTAG_PROPAGATED
dwcbVarLenData	0x00000000	0
dwReserved1	0xcd64cd64	dwReserved1: 0xcd64cd64

When the sending transaction manager receives the PARTNERTM_PROPAGATE_MTAG_PROPAGATED message, it adds the receiving transaction manager as a subordinate branch to its list of enlistments for the transaction. If the subordinate transaction manager is successfully added, the sending transaction manager replies to the sender that the export completed successfully.

The sending transaction manager keeps the connection alive for future two-phase commit processing when the transaction is committed or aborted.

4.3.4 Importing the Transaction

When the sender receives notification that the transaction was successfully exported to the receiving transaction manager, the sender sends the transaction identifier (guidTx) to the receiver by using its out-of-band API so that the receiver can import the transaction.

To import the transaction, the receiver needs to initiate a CONNTYPE_TXUSER_IMPORT connection with its transaction manager.

CONNTYPE_TXUSER_IMPORT: The packet sequence starts when the receiver initiates a CONNTYPE_TXUSER_IMPORT connection with its transaction manager.

Field	Value	Value Description
MsgTag	0x00000005	MTAG_CONNECTION_REQ
fIsMaster	0x00000001	1
dwConnectionId	0x00000001	1
dwUserMsgType	0x00000002	CONNTYPE_TXUSER_IMPORT
dwcbVarLenData	0x00000000	0
dwReserved1	0xcd64cd64	dwReserved1: 0xcd64cd64

The receiver then sends a TXUSER_IMPORT_MTAG_IMPORT user message to the its transaction manager and specifies the transaction identifier (guidTx).

Field	Value	Value Description
MsgTag	0x00000FFF	MTAG_USER_MESSAGE
fIsMaster	0x00000001	1
dwConnectionId	0x00000001	1
dwUserMsgType	0x00001021	TXUSER_IMPORT_MTAG_IMPORT
dwcbVarLenData	0x00000010	16
dwReserved1	0xcd64cd64	dwReserved1: 0xcd64cd64
guidTx	0x4046037E 0x46C99722 0x06999883 0x35CB4123	4046037e-9722-46c9-9883-99062341cb35

When the transaction manager receives the TXUSER_IMPORT_MTAG_IMPORT message from the receiver, it attempts to find the transaction identifier (guidTx) in its list of known transactions. If it locates the transaction with that identifier, the transaction manager replies to the receiver with a TXUSER_IMPORT_MTAG_IMPORTED user message that specifies the isolation level (isoLevel) and isolation flags (isoFlags) of the transaction.

Field	Value	Value Description
MsgTag	0x00000FFF	MTAG_USER_MESSAGE
fIsMaster	0x00000000	0

Field	Value	Value Description
dwConnectionId	0x00000001	1
dwUserMsgType	0x00001022	TXUSER_IMPORT_MTAG_IMPORTED
dwcbVarLenData	0x00000008	8
dwReserved1	0xcd64cd64	dwReserved1: 0xcd64cd64
isoLevel	0x00100000	ISOLATIONLEVEL_SERIALIZABLE
isoFlags	0x00000005	ISOFLAG_RETAIN_DONTCARE

When the receiving application gets the TXUSER_IMPORT_MTAG_IMPORTED message, it can enlist on the transaction (if it is a resource manager) or marshal the transaction to another application. The receiving application can also attempt to abort the transaction by using the connection. If the receiver does not intend to abort the transaction, it initiates the disconnect sequence.

4.4 Simple Enlistment Scenario

This scenario shows how a resource manager registers with a transaction manager, enlists on an existing transaction, and then responds to the enlistment notifications from the transaction manager. This scenario does not address resource manager recovery, which is described in the next section.

The scenario begins by the resource manager establishing a transport session with a transaction manager and negotiating its connection resources. It also assumes that there is some out-of-band mechanism (for example, application API) by which an external application is able to send the resource manager work to perform as part of an existing transaction. The resource manager is expected to follow the two-phase commit protocol.

4.4.1 Registering with the Transaction Manager as a Resource Manager

Before a resource manager can participate in transactional work, it needs to register as a resource manager with a transaction manager.

CONNTYPE_TXUSER_RESOURCEMANAGER: The packet sequence starts when the resource manager initiates a CONNTYPE_TXUSER_RESOURCEMANAGER connection.

Field	Value	Value description
MsgTag	0x00000005	MTAG_CONNECTION_REQ
fIsMaster	0x00000001	1
dwConnectionId	0x00000002	2
dwUserMsgType	0x00000005	CONNTYPE_TXUSER_RESOURCEMANAGER
dwcbVarLenData	0x00000000	0
dwReserved1	0xcd64cd64	dwReserved1: 0xcd64cd64

The resource manager then sends a TXUSER_RESOURCEMANAGER_MTAG_CREATE user message that specifies a GUID that uniquely identifies the resource manager (guidRm) and a session GUID that uniquely identifies this session of the resource manager (guidSession). The session GUID can be either a unique GUID that is created each time the resource manager starts up, or a NULL GUID.

Field	Value	Value description
MsgTag	0x00000FFF	MTAG_USER_MESSAGE
fIsMaster	0x00000001	1
dwConnectionId	0x00000002	2
dwUserMsgType	0x00001051	TXUSER_RESOURCEMANAGER_MTAG_CREATE
dwcbVarLenData	0x00000020	32
dwReserved1	0xcd64cd64	dwReserved1: 0xcd64cd64
guidRm	0xE7BAEBDF 0x4E2BDC69 0xA1699FF1 0x772859D3	E7BAEBDF-DC69-4E2B-9FF1-69A1D3592877
guidSession	0x8F5204B3 0x466A5FB9 0xAF2DA0B8 0xAAD9CB3F	8F5204B3-5FB9-466A-A0B8-2DAF3FCBD9AA

If guidRm does not identify a resource manager already registered with the transaction manager, the transaction manager adds the resource manager to its list of registered resource managers and sends to the resource manager a TXUSER_RESOURCEMANAGER_MTAG_REQUEST_COMPLETE user message.

Field	Value	Value description
MsgTag	0x00000FFF	MTAG_USER_MESSAGE
fIsMaster	0x00000000	0
dwConnectionId	0x00000002	2
dwUserMsgType	0x00001053	TXUSER_RESOURCEMANAGER_MTAG_REQUEST_COMPLETE
dwcbVarLenData	0x00000000	0
dwReserved1	0xcd64cd64	dwReserved1: 0xcd64cd64

The resource manager needs to keep this connection open for the duration of its lifetime. If the connection is terminated, any unprepared transactions are aborted.

4.4.2 Enlisting in an Existing Transaction

To enlist in an existing transaction, the resource manager needs to have knowledge of the existing transaction, which likely happened as a result of marshaling the transaction from an application to the resource manager.

CONNTYPE_TXUSER_ENLISTMENT: The packet sequence starts when the resource manager initiates a connection by using CONNTYPE_TXUSER_ENLISTMENT.

Field	Value	Value description
MsgTag	0x00000005	MTAG_CONNECTION_REQ
fIsMaster	0x00000001	1

Field	Value	Value description
dwConnectionId	0x00000002	2
dwUserMsgType	0x00000003	TXUSER_ENLISTMENT_MTAG_ENLIST
dwcbVarLenData	0x00000000	0
dwReserved1	0xcd64cd64	dwReserved1: 0xcd64cd64

The resource manager then sends a TXUSER_ENLISTMENT_MTAG_ENLIST user message specifying the transaction identifier (guidTx), the resource manager identifier (guidRm), and the resource manager session identifier (guidSession).

Field	Value	Value description
MsgTag	0x00000FFF	MTAG_USER_MESSAGE
fIsMaster	0x00000001	1
dwConnectionId	0x00000002	2
dwUserMsgType	0x00001031	TXUSER_ENLISTMENT_MTAG_ENLIST
dwcbVarLenData	0x00000030	48
dwReserved1	0xcd64cd64	dwReserved1: 0xcd64cd64
guidTx	0x4046037E 0x46C99722 0x06999883 0x35CB4123	4046037e-9722-46c9-9883-99062341cb35
guidRm	0xE7BAEBDF 0x4E2BDC69 0xA1699FF1 0x772859D3	E7BAEBDF-DC69-4E2B-9FF1-69A1D3592877
guidSession	0x8F5204B3 0x466A5FB9 0xAF2DA0B8 0xAAD9CB3F	8F5204B3-5FB9-466A-A0B8-2DAF3FCBD9AA

If the transaction manager can enlist the resource manager in the requested transaction, the transaction manager adds the resource manager to its list of subordinate enlistments and replies to the resource manager with a TXUSER_ENLISTMENT_MTAG_ENLISTED user message.

Field	Value	Value description
MsgTag	0x00000FFF	MTAG_USER_MESSAGE
fIsMaster	0x00000000	0
dwConnectionId	0x00000002	2
dwUserMsgType	0x00001032	TXUSER_ENLISTMENT_MTAG_ENLISTED
dwcbVarLenData	0x00000000	0

Field	Value	Value description
dwReserved1	0xcd64cd64	dwReserved1: 0xcd64cd64

The resource manager is now enlisted on the transaction and is now waiting for two-phase commit notifications from the transaction manager. During the time that the resource manager is enlisted on the transaction, the resource manager typically receives from some external application the instructions (that is, work) to perform as part of the transaction.

4.4.3 Responding to Enlistment Notifications

When the transaction is committed, the transaction manager receives notification to prepare the transaction.

4.4.3.1 Responding to a Prepare Request Message

As part of the prepare process, the transaction manager sends TXUSER_ENLISTMENT_MTAG_PREPAREREQ user messages to each of its subordinate resource managers.

Field	Value	Value description
MsgTag	0x00000FFF	MTAG_USER_MESSAGE
fIsMaster	0x00000000	0
dwConnectionId	0x00000002	2
dwUserMsgType	0x00001033	TXUSER_ENLISTMENT_MTAG_PREPAREREQ
dwcbVarLenData	0x00000008	8
dwReserved1	0xcd64cd64	dwReserved1: 0xcd64cd64
grFRM	0x00000000	0
fSinglePhase	0x00000000	0

When the resource manager successfully completes its prepare work, it replies to its transaction manager by using a TXUSER_ENLISTMENT_MTAG_PREPAREREQDONE user message that has the prepareReqDone value set to TXUSER_ENLISTMENT_PREPAREREQDONE_OK.

Field	Value	Value description
MsgTag	0x00000FFF	MTAG_USER_MESSAGE
fIsMaster	0x00000001	1
dwConnectionId	0x00000002	2
dwUserMsgType	0x00001036	TXUSER_ENLISTMENT_MTAG_PREPAREREQDONE
dwcbVarLenData	0x00000014	20
dwReserved1	0xcd64cd64	dwReserved1: 0xcd64cd64
prepareReqDone	0x00000000	TXUSER_ENLISTMENT_PREPAREREQDONE_OK
guidReason	0x00000000	00000000-0000-0000-0000-000000000000

Field	Value	Value description
	0x00000000 0x00000000 0x00000000	

The resource manager now waits for the transaction outcome from its transaction manager.

4.4.3.2 Responding to a Commit Request Message

If the transaction manager receives notification that the transaction is committed, it sends to the resource manager a TXUSER_ENLISTMENT_MTAG_COMMITREQ message.

Field	Value	Value description
MsgTag	0x00000FFF	MTAG_USER_MESSAGE
fIsMaster	0x00000000	0
dwConnectionId	0x00000002	2
dwUserMsgType	0x00001035	TXUSER_ENLISTMENT_MTAG_COMMITREQ
dwcbVarLenData	0x00000000	0
dwReserved1	0xcd64cd64	dwReserved1: 0xcd64cd64

When the resource manager successfully completes its commit work, it replies to its transaction manager with a TXUSER_ENLISTMENT_MTAG_COMMITREQDONE user message.

Field	Value	Value description
MsgTag	0x00000FFF	MTAG_USER_MESSAGE
fIsMaster	0x00000001	1
dwConnectionId	0x00000002	2
dwUserMsgType	0x00001038	TXUSER_ENLISTMENT_MTAG_COMMITREQDONE
dwcbVarLenData	0x00000000	0
dwReserved1	0xcd64cd64	dwReserved1: 0xcd64cd64

The resource manager has now completed all its work that is associated with the transaction and initiates the disconnect sequence on its CONNTYPE_TXUSER_ENLISTMENT connection with its transaction manager.

4.5 Transaction Manager Two-Phase Commit Scenario

This scenario shows how a transaction manager performs the Two-Phase Commit Protocol as both the superior transaction manager facet and the subordinate transaction manager facet.

For this scenario, all connections that are associated with the transaction are extant. The root transaction manager has an existing CONNTYPE_TXUSER_BEGIN2 connection between itself and the initiating application. Optionally, the transaction has one or more existing CONNTYPE_PARTNERTM_BRANCH or CONNTYPE_PARTNERTM_PROPAGATE connections between a superior transaction manager facet and its subordinate transaction manager facets. (A subordinate transaction manager facet can also act as a superior transaction manager facet if it has any

subordinate branches.) Optionally, each transaction manager also has one or more CONNTYPE_TXUSER_ENLISTMENT connections with its registered resource managers.

For this scenario, it is assumed that there are no phase-zero or voter enlistments and that the root transaction manager has more than one subordinate branch and thus will not perform a single-phase commit.

4.5.1 Phase One

The protocol sequence begins when the root transaction manager receives the TXUSER_BEGIN2_MTAG_COMMIT user message from the initiating application over its existing CONNTYPE_TXUSER_BEGIN2 connection (compare Committing the Transaction).

Field	Value	Value description
MsgTag	0x00000FFF	MTAG_USER_MESSAGE
fIsMaster	0x00000001	1
dwConnectionId	0x00000001	1
dwUserMsgType	0x00006003	TXUSER_BEGIN2_MTAG_COMMIT
dwcbVarLenData	0x00000004	4
dwReserved1	0xcd64cd64	dwReserved1: 0xcd64cd64
grFRM	0x00000000	0

The root transaction manager then iterates through the subordinate branches of each transaction and notifies the subordinates that the transaction processing has begun. The root transaction manager then waits for reply notifications from each of the subordinates in order to determine the outcome of the transaction.

4.5.1.1 Phase One - Subordinate Resource Managers

If the subordinate branch is a resource manager (that is, using a CONNTYPE_TXUSER_ENLISTMENT connection), the transaction manager sends a TXUSER_ENLISTMENT_MTAG_PREPAREREQ user message with fSinglePhase set to zero.

Field	Value	Value description
MsgTag	0x00000FFF	MTAG_USER_MESSAGE
fIsMaster	0x00000000	0
dwConnectionId	0x00000002	2
dwUserMsgType	0x00001033	TXUSER_ENLISTMENT_MTAG_PREPAREREQ
dwcbVarLenData	0x00000008	8
dwReserved1	0xcd64cd64	dwReserved1: 0xcd64cd64
grFRM	0x00000000	0
fSinglePhase	0x00000000	0

When the resource manager successfully completes its preparation work, it replies to its transaction manager by using a TXUSER_ENLISTMENT_MTAG_PREPAREREQDONE user message that has the prepareReqDone value set to TXUSER_ENLISTMENT_PREPAREREQDONE_OK.

Field	Value	Value description
MsgTag	0x00000FFF	MTAG_USER_MESSAGE
fIsMaster	0x00000001	1
dwConnectionId	0x00000002	2
dwUserMsgType	0x00001036	TXUSER_ENLISTMENT_MTAG_PREPAREREQDONE
dwcbVarLenData	0x00000014	20
dwReserved1	0xcd64cd64	dwReserved1: 0xcd64cd64
prepareReqDone	0x00000000	TXUSER_ENLISTMENT_PREPAREREQDONE_OK
guidReason	0x00000000 0x00000000 0x00000000 0x00000000	00000000-0000-0000-0000-000000000000

The resource manager now waits for a TXUSER_ENLISTMENT_MTAG_ABORTREQ or TXUSER_ENLISTMENT_MTAG_COMMITREQ message from its transaction manager to determine the outcome for the transaction.

4.5.1.2 Phase One - Subordinate Transaction Manager Facets

If the subordinate branch is a transaction manager (that is, it is using either a CONNTYPE_PARTNERTM_BRANCH or a CONNTYPE_PARTNERTM_PROPAGATE connection), the transaction manager sends a PARTNERTM_PROPAGATE_MTAG_PREPAREREQ user message that has **fSinglePhase** set to zero. If the connection was created by using CONNTYPE_PARTNERTM_BRANCH, **fIsMaster** is zero (0). If the connection was created by using CONNTYPE_PARTNERTM_PROPAGATE, **fIsMaster** is one (1).

Field	Value	Value description
MsgTag	0x00000FFF	MTAG_USER_MESSAGE
fIsMaster	0x00000000	0
dwConnectionId	0x00000001	1
dwUserMsgType	0x00002003	PARTNERTM_PROPAGATE_MTAG_PREPAREREQ
dwcbVarLenData	0x00000008	8
dwReserved1	0xcd64cd64	dwReserved1: 0xcd64cd64
grFRM	0x00000000	0
fSinglePhase	0x00000000	0

When the subordinate transaction manager facet receives the prepare request for a transaction, it then iterates through each of the transaction's subordinate branches and notifies the subordinates that the transaction processing has begun. The transaction manager waits for reply notifications from each of the subordinates in order to determine the outcome of the transaction.

If each subordinate branch of a transaction successfully prepares for the transaction (that is, each subordinate replies with a TXUSER_ENLISTMENT_PREPAREREQDONE_OK or PARTNERTM_PROPAGATE_PREPAREREQDONE_OK message depending on the connection type), the transaction manager replies to its superior transaction manager facet with a PARTNERTM_PROPAGATE_PREPAREREQDONE message that has **prepareReqDone** set to PARTNERTM_PROPAGATE_PREPAREREQDONE_OK. If the connection was created by using CONNTYPE_PARTNERTM_BRANCH, **fIsMaster** is one (1). If the connection was created by using CONNTYPE_PARTNERTM_PROPAGATE, **fIsMaster** is zero (0).

Field	Value	Value description
MsgTag	0x00000FFF	MTAG_USER_MESSAGE
fIsMaster	0x00000001	1
dwConnectionId	0x00000001	1
dwUserMsgType	0x00002006	PARTNERTM_PROPAGATE_MTAG_PREPAREREQDONE
dwcbVarLenData	0x00000014	20
dwReserved1	0xcd64cd64	dwReserved1: 0xcd64cd64
prepareReqDone	0x00000000	PARTNERTM_PROPAGATE_PREPAREREQDONE_OK
guidReason	0x00000000 0x00000000 0x00000000 0x00000000	00000000-0000-0000-0000-000000000000

The transaction manager now waits for a PARTNERTM_PROPAGATE_MTAG_ABORTREQ or PARTNERTM_PROPAGATE_MTAG_COMMITREQ message from its superior transaction manager facet to determine the outcome for the transaction.

4.5.1.3 Phase One - The Root Transaction Manager

If each subordinate branch of the root transaction manager successfully prepares for the transaction (that is, each subordinate replies with a TXUSER_ENLISTMENT_PREPAREREQDONE_OK or PARTNERTM_PROPAGATE_PREPAREREQDONE_OK message, depending on the connection type) the root transaction manager replies to the application that the transaction has committed. It replies by sending a TXUSER_BEGIN2_MTAG_SINK_ERROR message with an error value of TRUN_TXBEGIN_ERROR_NOTIFY_COMMITTED. For more information, see section 4.1.2.

Field	Value	Value description
MsgTag	0x00000FFF	MTAG_USER_MESSAGE
fIsMaster	0x00000000	0
dwConnectionId	0x00000001	1
dwUserMsgType	0x00006005	TXUSER_BEGIN2_MTAG_SINK_ERROR
dwcbVarLenData	0x00000004	4
dwReserved1	0xcd64cd64	dwReserved1: 0xcd64cd64
Error	0x0000001F	TRUN_TXBEGIN_ERROR_NOTIFY_COMMITTED

The root transaction manager then initiates Phase Two processing.

4.5.2 Phase Two

The root transaction manager begins Phase Two by iterating through each subordinate branch of the transaction and notifying the subordinates that Phase Two processing has begun. In this example, the transaction commits.

4.5.2.1 Phase Two - Subordinate Resource Managers

If the subordinate branch is a resource manager (that is, it uses a CONNTYPE_TXUSER_ENLISTMENT connection), the transaction manager sends a TXUSER_ENLISTMENT_MTAG_COMMITREQ user message.

Field	Value	Value description
MsgTag	0x00000FFF	MTAG_USER_MESSAGE
fIsMaster	0x00000000	0
dwConnectionId	0x00000001	1
dwUserMsgType	0x00001035	TXUSER_ENLISTMENT_MTAG_COMMITREQ
dwcbVarLenData	0x00000000	0
dwReserved1	0xcd64cd64	dwReserved1: 0xcd64cd64

When the resource manager successfully completes its commit work, it replies to its transaction manager with a TXUSER_ENLISTMENT_MTAG_COMMITREQDONE user message.

Field	Value	Value description
MsgTag	0x00000FFF	MTAG_USER_MESSAGE
fIsMaster	0x00000001	1
dwConnectionId	0x00000001	1
dwUserMsgType	0x00001038	TXUSER_ENLISTMENT_MTAG_COMMITREQDONE
dwcbVarLenData	0x00000000	0
dwReserved1	0xcd64cd64	dwReserved1: 0xcd64cd64

The resource manager has now completed all its work for the transaction and initiates the disconnect sequence on its CONNTYPE_TXUSER_ENLISTMENT connection with its transaction manager.

4.5.2.2 Phase Two - Subordinate Transaction Manager Facets

If the subordinate branch is a transaction manager (that is, it is using either a CONNTYPE_PARTNERTM_BRANCH or a CONNTYPE_PARTNERTM_PROPAGATE connection), the transaction manager sends a PARTNERTM_PROPAGATE_MTAG_COMMITREQ user message. If the connection was created by using CONNTYPE_PARTNERTM_BRANCH, **fIsMaster** is zero (0). If the connection was created by using CONNTYPE_PARTNERTM_PROPAGATE, **fIsMaster** is one (1).

Field	Value	Value description
MsgTag	0x00000FFF	MTAG_USER_MESSAGE
fIsMaster	0x00000000	0

Field	Value	Value description
dwConnectionId	0x00000001	1
dwUserMsgType	0x00002005	PARTNERTM_PROPAGATE_MTAG_COMMITREQ
dwcbVarLenData	0x00000000	0
dwReserved1	0xcd64cd64	dwReserved1: 0xcd64cd64

When the Subordinate Transaction Manager Facet receives the commit request for a transaction, it then iterates through each subordinate branch of the transaction and notifies the subordinates that the transaction is committed. The transaction manager then waits for reply notifications from each of the subordinates in order to complete Phase Two processing.

When each subordinate branch of the transaction replies that it has committed the transaction (that is, each subordinate replies with a TXUSER_ENLISTMENT_COMMITREQDONE_OK or PARTNERTM_PROPAGATE_COMMITREQDONE_OK message, depending on the connection type), the transaction manager replies to its Superior Transaction Manager Facet with a PARTNERTM_PROPAGATE_COMMITREQDONE message. If the connection was created by using CONNTYPE_PARTNERTM_BRANCH, **fIsMaster** is one (1). If the connection was created by using CONNTYPE_PARTNERTM_PROPAGATE, then **fIsMaster** is zero (0).

Field	Value	Value description
MsgTag	0x00000FFF	MTAG_USER_MESSAGE
fIsMaster	0x00000001	1
dwConnectionId	0x00000001	1
dwUserMsgType	0x00002008	PARTNERTM_PROPAGATE_MTAG_COMMITREQDONE
dwcbVarLenData	0x00000000	0
dwReserved1	0xcd64cd64	dwReserved1: 0xcd64cd64

The subordinate transaction manager facet has now completed all the work that is associated with the transaction. If the subordinate transaction manager facet's connection with its superior transaction manager facet is a CONNTYPE_PARTNERTM_BRANCH connection, the subordinate transaction manager facet initiates the disconnect sequence. If the subordinate transaction manager facet has any CONNTYPE_PARTNERTM_PROPAGATE connections with its subordinate branches, the subordinate transaction manager facet initiates the disconnect sequence on those subordinate branch connections.

4.5.2.3 Phase Two - The Root Transaction Manager

After the root transaction manager receives all reply notifications from each of its subordinates, the transaction life cycle is complete. If the root transaction manager has any CONNTYPE_PARTNERTM_PROPAGATE connections with its subordinate branches, the root transaction manager initiates the disconnect sequence on those subordinate branch connections.

4.6 Resource Manager Recovery Scenario

This scenario describes in more detail how a resource manager registers with a transaction manager, and how the resource manager drives its recovery process. The scenario begins by the resource manager establishing a transport session with a transaction manager and negotiating its connection resources.

4.6.1 Initializing the Recovery Process

After the resource manager registers with the transaction manager (compare Registering with the Transaction Manager as a Resource Manager), it initiates recovery. To perform recovery, the resource manager iterates through its log and locates all in-doubt transactions and requests their outcome by reenlisting in the transaction with the transaction manager.

4.6.2 Reenlisting in In-Doubt Transactions

To reenlist in any transaction that is in-doubt, the resource manager establishes a CONNTYPE_TXUSER_REENLIST connection with its transaction manager.

CONNTYPE_TXUSER_REENLIST: The packet sequence starts when the resource manager initiates a CONNTYPE_TXUSER_REENLIST connection.

Field	Value	Value description
MsgTag	0x00000005	MTAG_CONNECTION_REQ
fIsMaster	0x00000001	1
dwConnectionId	0x00000002	2
dwUserMsgType	0x00000006	CONNTYPE_TXUSER_REENLIST
dwcbVarLenData	0x00000000	0
dwReserved1	0xcd64cd64	dwReserved1: 0xcd64cd64

For each in-doubt transaction, the resource manager sends a TXUSER_REENLIST_MTAG_REENLIST user message specifying the transaction identifier (guidTx), the time-out (in milliseconds) that it will wait for notification, and the resource manager identifier (guidRm). For this sample, the resource manager will wait 1 second (or 1000 milliseconds).

Field	Value	Value description
MsgTag	0x00000FFF	MTAG_USER_MESSAGE
fIsMaster	0x00000001	1
dwConnectionId	0x00000002	2
dwUserMsgType	0x00001061	TXUSER_REENLIST_MTAG_REENLIST
dwcbVarLenData	0x00000024	36
dwReserved1	0xcd64cd64	dwReserved1: 0xcd64cd64
guidTx	0x4046037E 0x46C99722 0x06999883 0x35CB4123	4046037e-9722-46c9-9883-99062341cb35
ulTimeout	0x000003E8	1000
guidRm	0xE7BAEBDF 0x4E2BDC69 0xA1699FF1 0x772859D3	E7BAEBDF-DC69-4E2B-9FF1-69A1D3592877

When transaction manager receives the reenlist request, it attempts to find the transaction in its list of known transactions. If the transaction manager cannot locate the transaction, it assumes that the transaction aborted and replies to the resource manager with a TXUSER_REENLIST_MTAG_REENLIST_ABORTED user message.

Field	Value	Value description
MsgTag	0x00000FFF	MTAG_USER_MESSAGE
fIsMaster	0x00000000	0
dwConnectionId	0x00000002	2
dwUserMsgType	0x00001062	TXUSER_REENLIST_MTAG_REENLIST_ABORTED
dwcbVarLenData	0x00000000	0
dwReserved1	0xcd64cd64	dwReserved1: 0xcd64cd64

If the transaction manager can locate the transaction, the transaction manager attempts to determine outcome. The transaction manager replies to the resource manager with a TXUSER_REENLIST_MTAG_REENLIST_COMMITTED or TXUSER_REENLIST_MTAG_REENLIST_ABORTED user message, as appropriate.

Field	Value	Value description
MsgTag	0x00000FFF	MTAG_USER_MESSAGE
fIsMaster	0x00000000	0
dwConnectionId	0x00000002	2
dwUserMsgType	0x00001063	TXUSER_REENLIST_MTAG_REENLIST_COMMITTED
dwcbVarLenData	0x00000000	0
dwReserved1	0xcd64cd64	dwReserved1: 0xcd64cd64

If the transaction manager is unable to determine outcome in the time-out period, the transaction manager replies to the resource manager with a TXUSER_REENLIST_MTAG_REENLIST_TIMEOUT user message.

Field	Value	Value description
MsgTag	0x00000FFF	MTAG_USER_MESSAGE
fIsMaster	0x00000000	0
dwConnectionId	0x00000002	2
dwUserMsgType	0x00001064	TXUSER_REENLIST_MTAG_REENLIST_TIMEOUT
dwcbVarLenData	0x00000000	0
dwReserved1	0xcd64cd64	dwReserved1: 0xcd64cd64

After the resource manager determines the outcome from the transaction manager, it performs any remaining commit or abort work, as appropriate. If the resource manager receives a time-out notification, it needs to maintain the in-doubt entries in its log unchanged. The resource manager will attempt to determine the outcome of these in-doubt transactions next time it performs recovery.

For any remaining in-doubt transactions, the resource manager needs to perform the previous steps for each in-doubt transaction.

If there are no more in-doubt transactions, the resource manager informs the transaction manager that it has completed its recovery process. The resource manager then initiates the disconnect sequence on this connection.

4.6.3 Completing Recovery

To complete recovery, the resource manager needs to send the transaction manager a TXUSER_RESOURCEMANAGER_MTAG_REENLISTMENTCOMPLETE user message over its CONNTYPE_TXUSER_RESOURCEMANAGER connection.

Field	Value	Value description
MsgTag	0x00000FFF	MTAG_USER_MESSAGE
fIsMaster	0x00000001	1
dwConnectionId	0x00000001	1
dwUserMsgType	0x00001052	TXUSER_RESOURCEMANAGER_MTAG_REENLISTMENTCOMPLETE
dwcbVarLenData	0x00000000	0
dwReserved1	0xcd64cd64	dwReserved1: 0xcd64cd64

When the transaction manager receives the reenlistment complete notification, the transaction manager can clean up any transactions that are associated with the resource manager, such as the transactions in the Failed to Notify state. In response, the transaction manager sends the resource manager a TXUSER_RESOURCEMANAGER_MTAG_REQUEST_COMPLETE user message.

Field	Value	Value description
MsgTag	0x00000FFF	MTAG_USER_MESSAGE
fIsMaster	0x00000000	0
dwConnectionId	0x00000001	1
dwUserMsgType	0x00001053	TXUSER_RESOURCEMANAGER_MTAG_REQUEST_COMPLETE
dwcbVarLenData	0x00000000	0
dwReserved1	0xcd64cd64	dwReserved1: 0xcd64cd64

The resource manager will maintain this connection.

5 Security

5.1 Security Considerations for Implementers

The transaction processing protocol that is defined by this specification is intended for use in an environment where all participants are trusted to collaborate in driving transactions toward a final outcome.

Misuse of the Two-Phase Commit Protocol can enable participants to perform simple denial of service attacks on their transaction managers. Because transaction managers generally communicate with multiple participants simultaneously, this condition represents a denial of service to other participants.

Consequently, implementers need to take the following steps to ensure that transaction processing occurs in a secure environment:

- Each participant is expected to initialize [MS-CMPO] sessions by using mutual authentication, as specified in [MS-CMPO] section 3.2.1.1.
- All transaction manager and resource manager implementations uphold the following principles:
 - Every transaction reaches a common outcome for all participants, in accord with a correctly executed Two-Phase Commit Protocol.
 - No transaction remains In Doubt for a longer period of time than the application's higher-layer business logic accepts. This particular determination is implementation-specific.<38>
 - When authentication credentials are available, the acceptor is expected authorize incoming connections to ensure that the initiator is entitled to perform the actions that it is requesting. Implementations are recommended to adhere to the following authorization policies:
 1. The following connection types need to be accepted only for authenticated principals that have administrator privileges:
 - CONNTYPE_TXUSER_RESOLVE
 - CONNTYPE_TXUSER_TRACE

When incoming authentication is available, the above connection types are required to be established by a user identity that is authenticated as an administrator.

2. The following connection types need to be accepted only for authenticated principals whose principal name takes the form of <DomainName>\<MachineName>\$:
 - CONNTYPE_PARTNERTM_PROPAGATE
 - CONNTYPE_PARTNERTM_REDELIVERCOMMIT
 - CONNTYPE_PARTNERTM_CHECKABORT
 - CONNTYPE_PARTNERTM_BRANCH

When mutual authentication is required, the above connection types are required to be established by a user identity whose principal name takes the form of <DomainName>\<MachineName>\$ where <DomainName> is a NetBIOS domain name and <MachineName> matches the NetBIOS host name of the machine initiating the connection.

3. Transaction manager implementations need to ensure that the remote participant is a transaction manager for connection types that are used only between a superior transaction manager and a subordinate transaction manager.

An implementation can further restrict the set of supported connection types through configuration. These restrictions are reflected in the values of the **grfNetworkDtcAccess**, **grfXaTransactions**, and **grfOptions** fields of the TXUSER_GETSECURITYFLAGS_MTAG_FETCHED message.

5.2 Index of Security Parameters

Security parameter	Section
RPC security level	[MS-CMPO] section 3.2.1.1
Transaction manager security flags	3.2

6 Appendix A: Product Behavior

The information in this specification is applicable to the following Microsoft products or supplemental software. References to product versions include released service packs.

- Windows NT 4.0 operating system Option Pack for Windows NT Server
- Windows 2000 operating system
- Windows XP operating system
- Windows Server 2003 operating system
- Windows Vista operating system
- Windows Server 2008 operating system
- Windows 7 operating system
- Windows Server 2008 R2 operating system
- Windows 8 operating system
- Windows Server 2012 operating system
- Windows 8.1 operating system
- Windows Server 2012 R2 operating system
- Windows 10 operating system
- Windows Server 2016 operating system

Exceptions, if any, are noted below. If a service pack or Quick Fix Engineering (QFE) number appears with the product version, behavior changed in that service pack or QFE. The new behavior also applies to subsequent service packs of the product unless otherwise specified. If a product edition appears with the product version, behavior is different in that product edition.

Unless otherwise specified, any statement of optional behavior in this specification that is prescribed using the terms **"SHOULD"** or **"SHOULD NOT"** implies product behavior in accordance with the SHOULD or SHOULD NOT prescription. Unless otherwise specified, the term **"MAY"** implies that the product does not follow the prescription.

<1> Section 2.1.2.3: While performing push propagation, the Name object (as specified in [MS-CMPO] section 3.2.1.4) of the transaction manager is represented by using the NAMEOBJECTBLOB (section 2.2.5.3) structure on Windows NT 4.0 Option Pack and is represented by using the SWhereabouts (section 2.2.5.11) structure on Windows 2000, Windows XP, Windows Server 2003, Windows Vista, Windows Server 2008 operating system, Windows 7, Windows Server 2008 R2 operating system, Windows 8, Windows Server 2012, Windows 8.1, Windows Server 2012 R2, Windows 10, and Windows Server 2016.

<2> Section 2.2.1.1: MSDTC Connection Manager: OleTx Transaction Protocol version 1 is supported by all Windows versions. Version 2 is supported by Windows 2000, Windows XP, Windows Server 2003, Windows Vista, Windows Server 2008, Windows 7, Windows Server 2008 R2, Windows 8, Windows Server 2012, Windows 8.1, Windows 10, Windows Server 2012 R2, and Windows Server 2016. Version 4 is supported by Windows Server 2003, Windows Vista, Windows Server 2008, Windows 7, Windows Server 2008 R2, Windows 8, Windows Server 2012, Windows 8.1, Windows 10, Windows Server 2012 R2, and Windows Server 2016. Version 5 is supported by Windows Server 2003 operating system with Service Pack 1 (SP1), Windows Vista, Windows Server 2008, Windows 7, Windows Server 2008 R2, Windows 8, Windows Server 2012, Windows 8.1, Windows 10, Windows

Server 2012 R2, and Windows Server 2016. Version 6 is supported by Windows 7, Windows Server 2008 R2, Windows 8, Windows Server 2012, Windows 8.1, Windows Server 2012 R2, Windows 10, and Windows Server 2016.

<3> Section 2.2.1.1.1: The connection type CONNTYPE_TXUSER_EXTENDEDWHEREABOUTS is not supported by Windows XP (excluding Windows XP operating system Service Pack 2 (SP2) and Windows XP operating system Service Pack 3 (SP3)), Windows NT operating system, Windows 2000, and Windows Server 2003.

<4> Section 2.2.1.1.1: The connection type CONNTYPE_TXUSER_EXTENDEDWHEREABOUTS is not supported by Windows XP (excluding Windows XP SP2 and Windows XP SP3), Windows NT, Windows 2000, and Windows Server 2003.

<5> Section 2.2.1.1.1: The connection type CONNTYPE_TXUSER_PROMOTE is not supported by Windows XP, Windows NT, Windows 2000, and Windows Server 2003.

<6> Section 2.2.1.1.1: The connection type CONNTYPE_TXUSER_PROMOTE is not supported by Windows XP, Windows NT, Windows 2000, and Windows Server 2003.

<7> Section 2.2.1.1.1: The connection type CONNTYPE_TXUSER_SETTXTIMEOUT is supported by Windows 2000 operating system Service Pack 4 (SP4) or later.

<8> Section 2.2.1.1.1: The connection type CONNTYPE_TXUSER_SETTXTIMEOUT2 is not supported by Windows XP, Windows NT, and Windows 2000.

<9> Section 2.2.1.1.1: The connection type CONNTYPE_TXUSER_SETTXTIMEOUT2 is not supported by Windows XP, Windows NT, and Windows 2000.

<10> Section 2.2.1.1.1: The message TXUSER_RESOLVE_MTAG_ACCESSDENIED that is associated with connection type CONNTYPE_TXUSER_RESOLVE is not supported by Windows XP (excluding Windows XP SP2 and Windows XP SP3), Windows NT, and Windows 2000.

<11> Section 2.2.1.1.3: Connection type CONNTYPE_TXUSER_RESOURCEMANAGERINTERNAL is not supported by Windows XP, Windows NT, Windows 2000, and Windows Server 2003.

<12> Section 2.2.1.1.3: Connection type CONNTYPE_TXUSER_RESOURCEMANAGERINTERNAL is not supported by Windows XP, Windows NT, Windows 2000, and Windows Server 2003.

<13> Section 2.2.4.1: The value that Windows places in this field is undefined.

<14> Section 2.2.5.2: This structure is not supported on Windows NT and Windows 2000.

<15> Section 2.2.5.3: On Windows NT 4.0 Option Pack and Windows 2000, this field is set to a nondeterministic 4-byte value.

<16> Section 2.2.5.4: The **dwVersionMax** field value is 3 for Windows implementations, except for Windows NT 4.0 Option Pack, where the field value is 1, and for Windows 2000, where the field value is 2.

<17> Section 2.2.5.9: The field **TmProtocolMsdtcV1** is included in the SWhereabouts structure on Windows NT 4.0 Option Pack, Windows 2000, Windows XP, Windows Server 2003, Windows Vista, Windows Server 2008, Windows 7, Windows Server 2008 R2, Windows 8, Windows Server 2012, Windows 8.1, Windows Server 2012 R2, Windows 10, and Windows Server 2016. The **TmProtocolMsdtcV2** field is included in the SWhereabouts structure on Windows 2000, Windows XP, Windows Server 2003, Windows Vista, Windows Server 2008, Windows 7, Windows Server 2008 R2, Windows 8, Windows Server 2012, Windows 8.1, Windows Server 2012 R2, Windows 10, and Windows Server 2016. The **TmProtocolTip** field is included in the SWhereabouts structure, if the transaction manager is so configured, on Windows 2000, Windows XP, Windows Server 2003, Windows Vista, Windows Server 2008, Windows 7, Windows Server 2008 R2, Windows 8, Windows Server 2012, Windows 8.1, Windows Server 2012 R2, Windows 10, and Windows Server 2016. The

TmProtocolExtended field is included in the SWhereabouts structure, if the transaction manager is so configured, on Windows XP SP3, Windows Server 2003 operating system with Service Pack 2 (SP2), Windows Server 2003 operating system with Service Pack 3 (SP3), Windows Vista, Windows Server 2008, Windows 7, Windows Server 2008 R2, Windows 8, Windows Server 2012, Windows 8.1, Windows Server 2012 R2, Windows 10, and Windows Server 2016.

<18> Section 2.2.8.2.1.1.10: Windows does not have a maximum limit on the number of times an application can perform associate request on an already existing transaction by sending the TXUSER_ASSOCIATE_MTAG_ASSOCIATE message. Therefore, the TXUSER_ASSOCIATE_MTAG_TOO_MANY_LOCAL message is never sent by any Windows implementation.

<19> Section 2.2.8.3.2.1: By default, Windows implementations require authentication with an account that is in the administrator group, except that Windows XP (excluding Windows XP SP2 and Windows XP SP3), Windows NT, and Windows 2000 do not require authentication. This behavior is configurable on Windows implementations other than on Windows XP, Windows NT, and Windows 2000, where it is not configurable.

<20> Section 2.2.8.3.2.8: The message TXUSER_RESOLVE_MTAG_NOT_CHILD that is associated with connection type CONNTYPE_TXUSER_RESOLVE is never sent by any Windows implementation.

<21> Section 2.2.10.2.2.8: Windows limits transactions to 32 direct enlistments.

<22> Section 3.1.4.3: Regarding the MSDTC Connection Manager: OleTx Transaction Protocol connection establishment in Windows, an MSDTC Connection Manager: OleTx Transaction Protocol session partner does send connection requests for connection types that it supports (when required by the protocol rules; see section 3). The CONNTYPE_TXUSER_EXPORT2 (section 2.2.8.2.2.3) and CONNTYPE_TXUSER_PROMOTE (section 2.2.8.1.3) could be sent to the other partner, which might not support these connection types. As a result, the requests for the unsupported connection types are rejected with an MTAG_CONNECTION_REQ_DENIED ([MS-CMP] section 2.2.5). When the CONNTYPE_TXUSER_PROMOTE connection type is rejected, Windows implementations return the failure result to the higher business layer. When the CONNTYPE_TXUSER_EXPORT2 connection type is rejected, Windows implementations fall back to the CONNTYPE_TXUSER_EXPORT (section 2.2.8.2.2.2) connection type.

<23> Section 3.1.4.3: Regarding the sending of messages over an established MSDTC Connection Manager: OleTx Transaction Protocol connection in Windows, an MSDTC Connection Manager: OleTx Transaction Protocol session partner never sends messages that it supports (when required by the protocol rules) (see section 3), but that are not supported by the negotiated protocol version (in the context of the connection's connection type) with one exception: TXUSER_RESOLVE_MTAG_ACCESSDENIED (section 2.2.8.3.2.1). For TXUSER_RESOLVE_MTAG_ACCESSDENIED, a partner that supports this message sends it (when required by protocol rules) even if it is not supported by the negotiated protocol version.

<24> Section 3.1.6: On receiving an invalid message on a connection, the participant terminates the associated session on Windows XP operating system Service Pack 1 (SP1), Windows 2000, and the Windows NT 4.0 Option Pack.

<25> Section 3.2.3: No authentication is supported by Windows NT 4.0 Option Pack, Windows 2000, Windows XP, Windows Server 2003, Windows Vista, Windows Server 2008, Windows 7, Windows Server 2008 R2, Windows 8, Windows Server 2012, Windows 8.1, Windows Server 2012 R2, Windows 10, and Windows Server 2016. Incoming authentication and mutual authentication are supported by Windows XP SP2, Windows Server 2003 with SP1, Windows Vista, Windows Server 2008, Windows 7, Windows Server 2008 R2, Windows 8, Windows Server 2012, Windows 8.1, Windows Server 2012 R2, Windows 10 and Windows Server 2016. The security level is configurable to any of the three values on Windows XP SP2, Windows Server 2003 with SP1, Windows Vista, Windows Server 2008, Windows 7, Windows Server 2008 R2, Windows 8, Windows Server 2012, Windows 8.1, Windows Server 2012 R2, Windows 10, and Windows Server 2016.

- <26> Section 3.2.3.1: The **Timeout** field value defaults to zero on Windows implementations.
- <27> Section 3.2.3.2: On Windows NT 4.0 Option Pack, Windows 2000, Windows XP, Windows Server 2003, Windows Vista, Windows Server 2008, Windows 7, Windows Server 2008 R2, Windows 8, Windows Server 2012, Windows 8.1, Windows Server 2012 R2, Windows 10, and Windows Server 2016, the log size is configurable and stored in the registry. The default log size value is 4 MB, and the default maximum size is 512 MB.
- <28> Section 3.2.3.3: The Core Transaction Manager Facet (section 1.3.3.3.1) ensures that transactions with duplicate identifiers are not created; however, for Windows Vista the application of Windows Vista operating system with Service Pack 1 (SP1) is required to restore the correct protocol behavior and ensure that transactions with duplicate identifiers are not created.
- <29> Section 3.2.7.11: The limit of Subordinate Enlistments depends on the type of Enlistment. The default limit on Subordinate Transaction Manager Enlistments is 64 on Windows implementations, except for Windows NT 4.0 Option Pack, where the limit is 16. The limit on Subordinate Resource Manager Enlistments for Windows implementations is 32.
- <30> Section 3.2.7.13: The Core Transaction Manager Facet (section 1.3.3.3.1) ensures that transactions with duplicate identifiers are not created; however, Windows Vista does not ensure that transactions with duplicate identifiers are not created and requires the application of Windows Vista SP1 to restore the correct protocol behavior.
- <31> Section 3.2.7.21: The limit of Subordinate Enlistments depends on the type of Enlistment. The default limit on Subordinate Transaction Manager Enlistments is 64 on Windows implementations, except for Windows NT 4.0 Option Pack, where the limit is 16. The limit on Subordinate Resource Manager Enlistments for Windows implementations is 32.
- <32> Section 3.3.4.1: In Windows Vista, the Core Transaction Manager Facet (section 1.3.3.3.1) does not ensure that transactions with duplicate identifiers are not created. If an identifier that already exists in the transaction table is sent as the **guidTX** field with TXUSER_BEGINNER_MTAG_PROMOTE Message (section 3.4.5.1.3.1), a duplicate entry having the same transaction identifier will be created in the transaction table. As a result, the transaction identifier having duplicate entries in the transaction table is not uniquely mapped to a single transaction object and any subsequent lookup for a transaction object with this identifier can return any one of the duplicate transaction objects. Any subsequent processing rule that involves finding a transaction object by this transaction identifier can have an undefined outcome as a result of this Windows Vista-specific behavior. This undefined behavior was identified post release and has since been addressed in subsequent releases. An implementation avoids duplicate transaction identifiers when beginning a transaction that uses the CONNTYPE_TXUSER_PROMOTE connection type (section 3.3.4.1.3) by always using a new GUID as specified in [RFC4122] for the predetermined transaction identifier.
- <33> Section 3.4.5.3.2.1: By default, authentication is required with an account that is in the administrator group, with the exception that Windows XP (excluding Windows XP SP2 and Windows XP SP3), Windows NT, and Windows 2000 do not require authentication. This behavior is not configurable on Windows XP, Windows NT, or Windows 2000.
- <34> Section 3.4.5.3.2.2: By default, authentication is required with an account that is in the administrator group, with the exception that Windows XP (excluding Windows XP SP2 and Windows XP SP3), Windows NT, and Windows 2000 do not require authentication. This behavior is not configurable on Windows XP, Windows NT, or Windows 2000.
- <35> Section 3.4.5.3.2.3: By default, authentication is required with an account that is in the administrator group, with the exception that Windows XP (excluding Windows XP SP2 and Windows XP SP3), Windows NT, and Windows 2000 do not require authentication. This behavior is not configurable on Windows XP, Windows NT, or Windows 2000.
- <36> Section 3.7.2.1: The value is 1000 milliseconds if the transport is down. Otherwise the default value is 500 milliseconds for Windows implementations. This value is not configurable.

<37> Section 3.8.2.1: The value is 1000 milliseconds for Windows implementations. This value is not configurable.

<38> Section 5.1: Mutual authentication is used by default for Windows implementations, except that no authentication is used on Windows NT 4.0 Option Pack, Windows 2000, and Windows XP SP1.

7 Change Tracking

No table of changes is available. The document is either new or has had no changes since its last release.

8 Index

A

Abstract data model

- application (section 3.1.1 151, section 3.3.1 195, section 3.4.1 254)
- core transaction manager (section 3.1.1 151, section 3.2.1 157)
- resource manager (section 3.1.1 151, section 3.5.1 316, section 3.6.1 344)
- subordinate transaction manager (section 3.1.1 151, section 3.8.1 401)
- superior transaction manager (section 3.1.1 151, section 3.7.1 377)
- transaction manager (section 3.1.1 151, section 3.4.1 254, section 3.6.1 344)

Applicability 52

Application

- abstract data model (section 3.1.1 151, section 3.3.1 195, section 3.4.1 254)
- connection types 80
- facet - role 45
- higher-layer triggered events
 - beginning transaction 223
 - changing transaction time-out 224
 - creating export connection 226
 - generating trace records for transaction 228
 - importing transaction 228
 - importing transaction with additional transaction attributes 229
 - initiating transaction commit 230
 - initiating transaction rollback 231
 - obtaining extended whereabouts 233
 - obtaining security configuration of transaction manager 233
 - overview (section 3.1.5 155, section 3.3.4 222, section 3.4.4 282)
 - pulling transaction 234
 - pushing transaction 235
 - resolving transaction 235

initialization (section 3.1.3 153, section 3.3.3 222, section 3.4.3 281)

local events

- Associate Transaction Failure 303
 - Associate Transaction Success 304
 - Begin Commit 304
 - Begin In Doubt 305
 - Begin Rollback 305
 - Begin Voting 305
 - Connection Disconnected 157
 - Create Transaction Failure 306
 - Create Transaction Success 307
 - Create Voter Enlistment Failure 307
 - Create Voter Enlistment Success 308
 - Export Transaction Failure 308
 - Export Transaction Success 309
 - overview (section 3.1.8 156, section 3.3.7 254, section 3.4.7 303)
 - Phase One Complete 310
 - Phase Zero Complete 311
 - Register Phase Zero 311
 - Resolve Transaction Complete 312
 - Rollback Complete 313
 - Set Transaction Attributes Failure 313
 - Set Transaction Attributes Success 314
 - Set Transaction Timeout Failure 314
 - Set Transaction Timeout Success 315
 - Unilaterally Aborted 315
- #### message processing 301
- transaction administration (section 3.3.5.3 249, section 3.4.5.3 296)
 - transaction initiation and completion (section 3.3.5.1 236, section 3.4.5.1 282)
 - transaction manager administration 253
 - transaction propagation (section 3.3.5.2 242, section 3.4.5.2 287)
- #### overview 151
- #### role 42

- sequencing rules 301
 - transaction administration (section 3.3.5.3 249, section 3.4.5.3 296)
 - transaction initiation and completion (section 3.3.5.1 236, section 3.4.5.1 282)
 - transaction manager administration 253
 - transaction propagation (section 3.3.5.2 242, section 3.4.5.2 287)
- timer events (section 3.1.7 156, section 3.3.6 254, section 3.4.6 303)
- timers (section 3.1.2 153, section 3.3.2 222, section 3.4.2 281)
- versioning 154
- Associate_Msg_Version2 packet 63
- Associate_Msg_Version3 packet 63

C

- Capability negotiation 53
- Capability negotiation mechanisms 54
- Change tracking 460
- Connection types
 - application 80
 - resource manager
 - transaction recovery 144
 - voting 146
 - transaction administration 108
 - transaction manager 118
 - transaction manager propagation 118
 - transaction propagation 90
 - transaction recovery 129
 - version-specific aspects
 - relevant to applications 58
 - relevant to resource managers 60
 - relevant to transaction managers 60
- Connections 56
- CONNTYPE enumeration 71
- CONNTYPE_PARTNERTM_BRANCH
 - acceptor states 381
 - initiator states 405
 - overview 126
- CONNTYPE_PARTNERTM_CHECKABORT
 - acceptor states 386
 - initiator states 410
 - overview 129
- CONNTYPE_PARTNERTM_PROPAGATE
 - acceptor states 401
 - initiator states 377
 - overview 119
- CONNTYPE_PARTNERTM_REDELIVERCOMMIT
 - acceptor states 408
 - initiator states 384
 - overview 131
- CONNTYPE_TXUSER_ASSOCIATE
 - acceptor states 260
 - initiator states 201
 - overview 90
- CONNTYPE_TXUSER_BEGIN2
 - acceptor states 256
 - initiator states 197
 - overview 84
- CONNTYPE_TXUSER_BEGINNER
 - acceptor states 254
 - initiator states 195
 - overview 80
- CONNTYPE_TXUSER_ENLISTMENT
 - acceptor states 351
 - initiator states 322
 - overview 138
- CONNTYPE_TXUSER_EXPORT

acceptor states 267
initiator states 208
overview 97
CONNTYPE_TXUSER_EXPORT2
acceptor states 269
initiator states 210
overview 102
CONNTYPE_TXUSER_EXTENDEDWHEREABOUTS
acceptor states 262
overview 95
CONNTYPE_TXUSER_EXTENDWHEREABOUTS - initiator states 203
CONNTYPE_TXUSER_GETSECURITYFLAGS
acceptor states 279
initiator states 221
overview 117
CONNTYPE_TXUSER_GETTXDETAILS
acceptor states 271
initiator states 212
overview 108
CONNTYPE_TXUSER_IMPORT
acceptor states 263
initiator states 204
overview 103
CONNTYPE_TXUSER_IMPORT2
acceptor states 265
initiator states 206
overview 106
CONNTYPE_TXUSER_PHASE0
acceptor states 349
initiator states 320
overview 135
CONNTYPE_TXUSER_PROMOTE
acceptor states 258
initiator states 199
overview 88
CONNTYPE_TXUSER_REENLIST
acceptor states 354
initiator states 324
overview 144
CONNTYPE_TXUSER_RESOLVE
acceptor states 272
initiator states 214
overview 111
CONNTYPE_TXUSER_RESOURCEMANAGER
acceptor states 345
initiator states 316
overview 132
CONNTYPE_TXUSER_RESOURCEMANAGERINTERNAL
acceptor states 347
initiator states 318
overview 134
CONNTYPE_TXUSER_SETTXTIMEOUT
acceptor states 274
initiator states 216
overview 115
CONNTYPE_TXUSER_SETTXTIMEOUT2
acceptor states 276
initiator states 218
overview 115
CONNTYPE_TXUSER_TRACE
acceptor states 278
initiator states 219
overview 115
CONNTYPE_TXUSER_VOTER
acceptor states 356

- initiator states 326
 - overview 146
- Constants 77
- Core transaction manager
 - abstract data model (section 3.1.1 151, section 3.2.1 157)
 - higher-layer triggered events (section 3.1.5 155, section 3.2.4 171)
 - initialization
 - durable log 171
 - overview (section 3.1.3 153, section 3.2.3 169)
 - transaction
 - object initialization 170
 - recovery 171
 - local events
 - Associate Transaction 172
 - Begin Commit 173
 - Begin In Doubt 174
 - Begin Phase One 174
 - Begin Phase Zero 174
 - Begin Rollback 175
 - Begin Voting 175
 - Branch Transaction Failure 176
 - Branch Transaction Success 176
 - Connection Disconnected 157
 - Create Phase Zero Enlistment 176
 - Create Subordinate Enlistment 177
 - Create Superior Enlistment 178
 - Create Transaction 179
 - Create Voter Enlistment 180
 - Enlistment Commit Complete 180
 - Enlistment Phase One Complete 181
 - Enlistment Phase Zero Complete 182
 - Enlistment Rollback Complete 183
 - Enlistment Unilaterally Aborted 184
 - Enlistment Vote Complete 185
 - Export Transaction 186
 - Forget Transaction 187
 - Notify Aborted 187
 - Notify Recovered Transaction Committed 188
 - overview (section 3.1.8 156, section 3.2.7 172)
 - Phase One Completed 188
 - Propagate Transaction Failure 189
 - Propagate Transaction Success 189
 - Register Phase Zero Failure 190
 - Register Phase Zero Success 190
 - Request Transaction Outcome 193
 - Resolve Transaction 191
 - Set Transaction Attributes 192
 - Set Transaction Timeout 192
 - Unenlist Phase Zero Enlistment 193
 - Voting Complete 194
 - message processing 172
 - overview 151
 - role 45
 - sequencing rules 172
 - timer events (section 3.1.7 156, section 3.2.6 172)
 - timers (section 3.1.2 153, section 3.2.2 168)
 - versioning 154

D

- Data model - abstract
 - application (section 3.1.1 151, section 3.3.1 195, section 3.4.1 254)
 - core transaction manager (section 3.1.1 151, section 3.2.1 157)
 - resource manager (section 3.1.1 151, section 3.5.1 316, section 3.6.1 344)
 - subordinate transaction manager (section 3.1.1 151, section 3.8.1 401)

- superior transaction manager (section 3.1.1 151, section 3.7.1 377)
- transaction manager (section 3.1.1 151, section 3.4.1 254, section 3.6.1 344)
- DTCADVCONFIG_OPTIONS packet 77
- Durability 47

E

- Enlistment example
 - enlisting in existing transaction 441
 - overview 440
 - registering with transaction manager as resource manager 440
 - responding to enlistment notifications 443
- Enumerations 71
- Examples
 - overview 426
 - resource manager recovery scenario
 - completing recovery 452
 - initializing recovery 450
 - overview 449
 - reenlisting in in-doubt transactions 450
 - simple enlistment scenario
 - enlisting in existing transaction 441
 - overview 440
 - registering with transaction manager as resource manager 440
 - responding to enlistment notifications 443
 - simple transaction scenario
 - beginning transaction 426
 - completing transaction 427
 - overview 426
 - transaction manager two-phase commit scenario
 - overview 444
 - Phase One 445
 - Phase Two 448
 - transaction marshaling scenario
 - branching transaction 432
 - exporting transaction 435
 - importing transaction 439
 - marshaling transaction 429
 - obtaining whereabouts of receiver's transaction manager 434
 - overview (section 4.2 428, section 4.3 434)
 - propagating transaction 437
 - unmarshaling transaction 430

F

- Facets - core transaction manager 167
- Fields - vendor-extensible 54

G

- Glossary 28
- GRFRM 77

H

- Higher-layer triggered events
 - application
 - beginning transaction 223
 - changing transaction time-out 224
 - creating export connection 226
 - generating trace records for transaction 228
 - importing transaction 228
 - importing transaction with additional transaction attributes 229
 - initiating transaction commit 230
 - initiating transaction rollback 231

- obtaining extended whereabouts 233
- obtaining security configuration of transaction manager 233
- overview (section 3.1.5 155, section 3.3.4 222, section 3.4.4 282)
- pulling transaction 234
- pushing transaction 235
- resolving transaction 235
- core transaction manager (section 3.1.5 155, section 3.2.4 171)
- resource manager
 - canceling enlistment as Phase Zero participant on specific transaction 329
 - enlisting as Phase Zero participant on specific transaction 329
 - enlisting on specific transaction 329
 - Enlistment Abort request completed 330
 - Enlistment Commit request completed 330
 - Enlistment Prepare request completed 331
 - Enlistment Single-Phase Commit request completed 332
 - overview (section 3.1.5 155, section 3.5.4 329, section 3.6.4 359)
 - Phase Zero request completed 333
 - registering as voter on specific transaction 333
 - registering with transaction manager 333
 - Voter Vote request completed 334
- subordinate transaction manager (section 3.1.5 155, section 3.8.4 412)
- superior transaction manager (section 3.1.5 155, section 3.7.4 387)
- transaction manager (section 3.1.5 155, section 3.4.4 282, section 3.6.4 359)

I

- Implementer - security considerations 453
- Index of security parameters 454
- Informative references 34
- Initialization
 - application (section 3.1.3 153, section 3.3.3 222, section 3.4.3 281)
 - core transaction manager
 - durable log 171
 - overview (section 3.1.3 153, section 3.2.3 169)
 - transaction
 - object initialization 170
 - recovery 171
 - resource manager (section 3.1.3 153, section 3.5.3 328, section 3.6.3 358)
 - subordinate transaction manager (section 3.1.3 153, section 3.8.3 411)
 - superior transaction manager (section 3.1.3 153, section 3.7.3 387)
 - transaction manager (section 3.1.3 153, section 3.4.3 281, section 3.6.3 358)
- Introduction 27

L

- Lifetime - transaction 34
- Local events
 - application
 - Associate Transaction Failure 303
 - Associate Transaction Success 304
 - Begin Commit 304
 - Begin In Doubt 305
 - Begin Rollback 305
 - Begin Voting 305
 - Connection Disconnected 157
 - Create Transaction Failure 306
 - Create Transaction Success 307
 - Create Voter Enlistment Failure 307
 - Create Voter Enlistment Success 308
 - Export Transaction Failure 308
 - Export Transaction Success 309
 - overview (section 3.1.8 156, section 3.3.7 254, section 3.4.7 303)
 - Phase One Complete 310
 - Phase Zero Complete 311
 - Register Phase Zero 311

- Resolve Transaction Complete 312
- Rollback Complete 313
- Set Transaction Attributes Failure 313
- Set Transaction Attributes Success 314
- Set Transaction Timeout Failure 314
- Set Transaction Timeout Success 315
- Unilaterally Aborted 315
- core transaction manager
 - Associate Transaction 172
 - Begin Commit 173
 - Begin In Doubt 174
 - Begin Phase One 174
 - Begin Phase Zero 174
 - Begin Rollback 175
 - Begin Voting 175
 - Branch Transaction Failure 176
 - Branch Transaction Success 176
 - Connection Disconnected 157
 - Create Phase Zero Enlistment 176
 - Create Subordinate Enlistment 177
 - Create Superior Enlistment 178
 - Create Transaction 179
 - Create Voter Enlistment 180
 - Enlistment Commit Complete 180
 - Enlistment Phase One Complete 181
 - Enlistment Phase Zero Complete 182
 - Enlistment Rollback Complete 183
 - Enlistment Unilaterally Aborted 184
 - Enlistment Vote Complete 185
 - Export Transaction 186
 - Forget Transaction 187
 - Notify Aborted 187
 - Notify Recovered Transaction Committed 188
 - overview (section 3.1.8 156, section 3.2.7 172)
 - Phase One Completed 188
 - Propagate Transaction Failure 189
 - Propagate Transaction Success 189
 - Register Phase Zero Failure 190
 - Register Phase Zero Success 190
 - Request Transaction Outcome 193
 - Resolve Transaction 191
 - Set Transaction Attributes 192
 - Set Transaction Timeout 192
 - Unenlist Phase Zero Enlistment 193
 - Voting Complete 194
- resource manager
 - Begin Commit 370
 - Begin In Doubt 370
 - Begin Phase One 371
 - Begin Phase Zero 371
 - Begin Rollback 372
 - Begin Voting 372
 - Connection Disconnected 157
 - Create Phase Zero Enlistment Failure 373
 - Create Phase Zero Enlistment Success 373
 - Create Resource Manager 373
 - Create Subordinate Enlistment Failure 374
 - Create Subordinate Enlistment Success 375
 - Create Voter Enlistment Failure 375
 - Create Voter Enlistment Success 376
 - overview (section 3.1.8 156, section 3.5.7 342, section 3.6.7 369)
 - Phase Zero Aborted 376
 - Recover Transaction 342
 - Recover Transactions 343
 - Reenlist Complete 376

- Reenlistment Complete 343
- Resource Manager Down 377
- Transaction Manager Down 343
- subordinate transaction manager
 - Branch Transaction 420
 - Cancel Check Abort 421
 - Commit Complete 421
 - Connection Disconnected 157
 - Create Superior Enlistment Failure 422
 - Create Superior Enlistment Success 422
 - overview (section 3.1.8 156, section 3.8.7 420)
 - Phase One Complete 423
 - Phase Zero Complete 422
 - Recover In Doubt Transaction 424
 - Register Phase Zero 424
 - Rollback Complete 425
 - Unilaterally Aborted 425
- superior transaction manager
 - Begin Commit 397
 - Begin Phase One 397
 - Begin Phase Zero 398
 - Begin Rollback 398
 - Connection Disconnected 157
 - Create Phase Zero Enlistment Failure 399
 - Create Phase Zero Enlistment Success 399
 - Create Subordinate Enlistment Failure 399
 - Create Subordinate Enlistment Success 400
 - overview (section 3.1.8 156, section 3.7.7 397)
 - Phase Zero Aborted 400
 - Propagate Transaction 400
- transaction manager
 - Associate Transaction Failure 303
 - Associate Transaction Success 304
 - Begin Commit (section 3.4.7.3 304, section 3.6.7.1 370)
 - Begin In Doubt (section 3.4.7.4 305, section 3.6.7.2 370)
 - Begin Phase One 371
 - Begin Phase Zero 371
 - Begin Rollback (section 3.4.7.5 305, section 3.6.7.5 372)
 - Begin Voting (section 3.4.7.6 305, section 3.6.7.6 372)
 - Connection Disconnected 157
 - Create Phase Zero Enlistment Failure 373
 - Create Phase Zero Enlistment Success 373
 - Create Resource Manager 373
 - Create Subordinate Enlistment Failure 374
 - Create Subordinate Enlistment Success 375
 - Create Transaction Failure 306
 - Create Transaction Success 307
 - Create Voter Enlistment Failure (section 3.4.7.9 307, section 3.6.7.12 375)
 - Create Voter Enlistment Success (section 3.4.7.10 308, section 3.6.7.13 376)
 - Export Transaction Failure 308
 - Export Transaction Success 309
 - overview (section 3.1.8 156, section 3.4.7 303, section 3.6.7 369)
 - Phase One Complete 310
 - Phase Zero Aborted 376
 - Phase Zero Complete 311
 - Reenlist Complete 376
 - Register Phase Zero 311
 - Resolve Transaction Complete 312
 - Resource Manager Down 377
 - Rollback Complete 313
 - Set Transaction Attributes Failure 313
 - Set Transaction Attributes Success 314
 - Set Transaction Timeout Failure 314
 - Set Transaction Timeout Success 315
 - Unilaterally Aborted 315

Logging - core transaction manager 161

M

Message processing

- application 301
 - transaction administration (section 3.3.5.3 249, section 3.4.5.3 296)
 - transaction initiation and completion (section 3.3.5.1 236, section 3.4.5.1 282)
 - transaction manager administration 253
 - transaction propagation (section 3.3.5.2 242, section 3.4.5.2 287)
 - common 155
 - core transaction manager 172
 - resource manager
 - registration (section 3.5.5.1 335, section 3.6.5.1 359)
 - transaction coordination (section 3.5.5.2 337, section 3.6.5.2 361)
 - transaction recovery (section 3.5.5.3 340, section 3.6.5.3 366)
 - voting (section 3.5.5.4 341, section 3.6.5.4 368)
 - subordinate transaction manager
 - transaction propagation and coordination 412
 - transaction recovery 418
 - superior transaction manager
 - transaction propagation and coordination 388
 - transaction recovery 394
 - transaction manager
 - administration 301
 - resource manager registration 359
 - transaction administration 296
 - transaction coordination 361
 - transaction initiation and completion 282
 - transaction propagation 287
 - transaction recovery 366
 - voting 368
- MESSAGE_PACKET packet 61
- Messages
- Structures with a Format-Specifying Field as Versioning Mechanism 61
 - Structures with Fields Containing Version Numbers as Versioning Mechanism 60
 - syntax 57
 - transport 56
- MS-CMPO parameterization 56

N

Name object

- computing 57
 - converting NAMEOBJECTBLOB structure to 153
 - converting OLETX_TM_ADDR structure to 152
 - converting to NAMEOBJECTBLOB structure 153
 - converting to OLETX_TM_ADDR structure 152
- NAMEOBJECTBLOB packet 64
- NAMEOBJECTBLOB structure
- converting Name object to 153
 - converting to Name object 153
- Negotiating common protocol version 154
- Normative references 33

O

- OLETX_TM_ADDR structure
- converting Name object to 152
 - converting to Name object 152
- OLETX_ISOLATION_FLAGS enumeration 75
- OLETX_ISOLATION_LEVEL enumeration 77
- OLETX_TM_ADDR packet 62
- OLETX_VARLEN_STRING packet 62
- Overview (synopsis) 34

P

- Parameters - security index 454
- PARTNERTM_BRANCH_MTAG_BRANCH_LOG_FULL packet 126
- PARTNERTM_BRANCH_MTAG_BRANCH_NO_MEM packet 127
- PARTNERTM_BRANCH_MTAG_BRANCH_TOO_LATE packet 127
- PARTNERTM_BRANCH_MTAG_BRANCH_TOO_MANY packet 128
- PARTNERTM_BRANCH_MTAG_BRANCH_TX_NOT_FOUND packet 128
- PARTNERTM_BRANCH_MTAG_BRANCHED packet 128
- PARTNERTM_BRANCH_MTAG_BRANCHING packet 129
- PARTNERTM_CHECKABORT_MTAG_ABORTED packet 130
- PARTNERTM_CHECKABORT_MTAG_CHECK packet 129
- PARTNERTM_CHECKABORT_MTAG_RETRY packet 130
- PARTNERTM_PROPAGATE_MTAG_ABORTNOTIFY packet 124
- PARTNERTM_PROPAGATE_MTAG_ABORTREQ packet 123
- PARTNERTM_PROPAGATE_MTAG_ABORTREQDONE packet 124
- PARTNERTM_PROPAGATE_MTAG_COMMITREQ packet 122
- PARTNERTM_PROPAGATE_MTAG_COMMITREQDONE packet 123
- PARTNERTM_PROPAGATE_MTAG_DUPLICATE packet 120
- PARTNERTM_PROPAGATE_MTAG_LOG_FULL packet 121
- PARTNERTM_PROPAGATE_MTAG_NO_MEM packet 120
- PARTNERTM_PROPAGATE_MTAG_PHASE0 packet 125
- PARTNERTM_PROPAGATE_MTAG_PHASE0COMPLETE packet 126
- PARTNERTM_PROPAGATE_MTAG_PHASE0REGISTER packet 124
- PARTNERTM_PROPAGATE_MTAG_PHASE0REGISTERED packet 125
- PARTNERTM_PROPAGATE_MTAG_PHASE0REGISTRATIONREJECTED packet 125
- PARTNERTM_PROPAGATE_MTAG_PREPAREREQ packet 121
- PARTNERTM_PROPAGATE_MTAG_PREPAREREQDONE packet 121
- PARTNERTM_PROPAGATE_MTAG_PROPAGATE packet 119
- PARTNERTM_PROPAGATE_MTAG_PROPAGATED packet 119
- PARTNERTM_PROPAGATE_MTAG_PROTOCOL_ERROR packet 122
- PARTNERTM_PROPAGATE_MTAG_PREPAREREQDONE_RESPONSE enumeration 74
- PARTNERTM_REDELIVERCOMMIT_MTAG_COMMITREQ packet 131
- PARTNERTM_REDELIVERCOMMIT_MTAG_COMMITREQDONE packet 131
- PARTNERTM_REDELIVERCOMMIT_MTAG_RETRY packet 132
- Phase One 36
- Phase Two 38
- Phase Zero 35
- Preconditions 52
- Prerequisites 52
- Product behavior 455
- Propagation
 - pull (section 2.2.8.2.1 90, section 2.2.9.1.2 126)
 - branching transaction 432
 - marshaling transaction 429
 - overview (section 1.3.5.1 49, section 4.2 428)
 - unmarshaling transaction 430
 - push (section 2.2.8.2.2 95, section 2.2.9.1.1 118)
 - exporting transaction 435
 - importing transaction 439
 - obtaining whereabouts of receiver's transaction manager 434
 - overview (section 1.3.5.2 50, section 4.3 434)
 - propagating transaction 437
 - transaction (section 1.3.5 48, section 2.2.8.2 90)
 - transaction manager 118
- Propagation-Token packet 65
- Protocol extension objects - core transaction manager 167
- Pull propagation (section 2.2.8.2.1 90, section 2.2.9.1.2 126)
 - branching transaction 432
 - marshaling transaction 429
 - overview (section 1.3.5.1 49, section 4.2 428)
 - unmarshaling transaction 430
- Push propagation (section 2.2.8.2.2 95, section 2.2.9.1.1 118)
 - exporting transaction 435

- importing transaction 439
- obtaining whereabouts of receiver's transaction manager 434
- overview (section 1.3.5.2 50, section 4.3 434)
- propagating transaction 437

R

- Recovery example
 - completing recovery 452
 - initializing recovery 450
 - overview 449
 - reenlisting in in-doubt transactions 450
- References 32
 - informative 34
 - normative 33
- Registration - resource manager 132
- Relationship to other protocols 51
- Resource manager
 - abstract data model (section 3.1.1 151, section 3.5.1 316, section 3.6.1 344)
 - connection types 132
 - example
 - completing recovery 452
 - initializing recovery 450
 - overview 449
 - reenlisting in in-doubt transactions 450
 - facet - role 46
 - higher-layer triggered events
 - canceling enlistment as Phase Zero participant on specific transaction 329
 - enlisting as Phase Zero participant on specific transaction 329
 - enlisting on specific transaction 329
 - Enlistment Abort request completed 330
 - Enlistment Commit request completed 330
 - Enlistment Prepare request completed 331
 - Enlistment Single-Phase Commit request completed 332
 - overview (section 3.1.5 155, section 3.5.4 329, section 3.6.4 359)
 - Phase Zero request completed 333
 - registering as voter on specific transaction 333
 - registering with transaction manager 333
 - Voter Vote request completed 334
 - initialization (section 3.1.3 153, section 3.5.3 328, section 3.6.3 358)
 - local events
 - Begin Commit 370
 - Begin In Doubt 370
 - Begin Phase One 371
 - Begin Phase Zero 371
 - Begin Rollback 372
 - Begin Voting 372
 - Connection Disconnected 157
 - Create Phase Zero Enlistment Failure 373
 - Create Phase Zero Enlistment Success 373
 - Create Resource Manager 373
 - Create Subordinate Enlistment Failure 374
 - Create Subordinate Enlistment Success 375
 - Create Voter Enlistment Failure 375
 - Create Voter Enlistment Success 376
 - overview (section 3.1.8 156, section 3.5.7 342, section 3.6.7 369)
 - Phase Zero Aborted 376
 - Recover Transaction 342
 - Recover Transactions 343
 - Reenlist Complete 376
 - Reenlistment Complete 343
 - Resource Manager Down 377
 - Transaction Manager Down 343
 - message processing
 - resource manager registration (section 3.5.5.1 335, section 3.6.5.1 359)

- transaction coordination (section 3.5.5.2 337, section 3.6.5.2 361)
- transaction recovery (section 3.5.5.3 340, section 3.6.5.3 366)
- voting (section 3.5.5.4 341, section 3.6.5.4 368)
- overview 151
- recovery 47
- registration 132
- role 43
- sequencing rules
 - resource manager registration (section 3.5.5.1 335, section 3.6.5.1 359)
 - transaction coordination (section 3.5.5.2 337, section 3.6.5.2 361)
 - transaction recovery (section 3.5.5.3 340, section 3.6.5.3 366)
 - voting (section 3.5.5.4 341, section 3.6.5.4 368)
- timer events (section 3.1.7 156, section 3.5.6 342, section 3.6.6 369)
- timers (section 3.1.2 153, section 3.5.2 328, section 3.6.2 358)
- transaction coordination 135
- versioning 154
- voting 146
- Resource manager recovery scenario
 - completing recovery 452
 - initializing recovery 450
 - overview 449
 - reenlisting in in-doubt transactions 450
- Roles - transaction 41

S

- SDTcCmEndpointInfoV1 packet 66
- SDTcCmEndpointInfoV2 packet 67
- Security
 - computing levels 57
 - implementer considerations 453
 - parameter index 454
- Sequencing rules
 - application 301
 - transaction administration (section 3.3.5.3 249, section 3.4.5.3 296)
 - transaction initiation and completion (section 3.3.5.1 236, section 3.4.5.1 282)
 - transaction manager administration 253
 - transaction propagation (section 3.3.5.2 242, section 3.4.5.2 287)
 - common 155
 - core transaction manager 172
 - resource manager
 - registration (section 3.5.5.1 335, section 3.6.5.1 359)
 - transaction coordination (section 3.5.5.2 337, section 3.6.5.2 361)
 - transaction recovery (section 3.5.5.3 340, section 3.6.5.3 366)
 - voting (section 3.5.5.4 341, section 3.6.5.4 368)
 - subordinate transaction manager
 - transaction propagation and coordination 412
 - transaction recovery 418
 - superior transaction manager
 - transaction propagation and coordination 388
 - transaction recovery 394
 - transaction manager
 - administration 301
 - resource manager registration 359
 - transaction administration 296
 - transaction coordination 361
 - transaction initiation and completion 282
 - transaction propagation 287
 - transaction recovery 366
 - voting 368
- Sessions 56
- SExtendedEndpointInfo packet 68
- Simple enlistment scenario
 - enlisting in existing transaction 441
 - overview 440

- registering with transaction manager as resource manager 440
- responding to enlistment notifications 443
- Simple transaction scenario
 - beginning transaction 426
 - completing transaction 427
 - overview 426
- Single-phase commit 40
- SOleTxInfoForTip packet 67
- Standards assignments 55
- STmToTmProtocol packet 68
- Structures
 - common 61
 - transaction propagation 63
- Structures with a Format-Specifying Field as Versioning Mechanism message 61
- Structures with Fields Containing Version Numbers as Versioning Mechanism message 60
- STxInfo packet 69
- Subordinate transaction manager
 - abstract data model (section 3.1.1 151, section 3.8.1 401)
 - facet - role 46
 - higher-layer triggered events (section 3.1.5 155, section 3.8.4 412)
 - initialization (section 3.1.3 153, section 3.8.3 411)
 - local events
 - Branch Transaction 420
 - Cancel Check Abort 421
 - Commit Complete 421
 - Connection Disconnected 157
 - Create Superior Enlistment Failure 422
 - Create Superior Enlistment Success 422
 - overview (section 3.1.8 156, section 3.8.7 420)
 - Phase One Complete 423
 - Phase Zero Complete 422
 - Recover In Doubt Transaction 424
 - Register Phase Zero 424
 - Rollback Complete 425
 - Unilaterally Aborted 425
 - message processing
 - transaction propagation and coordination 412
 - transaction recovery 418
 - overview 151
 - sequencing rules
 - transaction propagation and coordination 412
 - transaction recovery 418
 - timer events (section 3.1.7 156, section 3.8.6 420)
 - timers (section 3.1.2 153, section 3.8.2 411)
 - versioning 154
- Subordinate-driven transaction recovery 129
- Superior transaction manager
 - abstract data model (section 3.1.1 151, section 3.7.1 377)
 - facet - role 46
 - higher-layer triggered events (section 3.1.5 155, section 3.7.4 387)
 - initialization (section 3.1.3 153, section 3.7.3 387)
 - local events
 - Begin Commit 397
 - Begin Phase One 397
 - Begin Phase Zero 398
 - Begin Rollback 398
 - Connection Disconnected 157
 - Create Phase Zero Enlistment Failure 399
 - Create Phase Zero Enlistment Success 399
 - Create Subordinate Enlistment Failure 399
 - Create Subordinate Enlistment Success 400
 - overview (section 3.1.8 156, section 3.7.7 397)
 - Phase Zero Aborted 400
 - Propagate Transaction 400
 - message processing

- transaction propagation and coordination 388
- transaction recovery 394
- overview 151
- sequencing rules
 - transaction propagation and coordination 388
 - transaction recovery 394
- timer events (section 3.1.7 156, section 3.7.6 396)
- timers (section 3.1.2 153, section 3.7.2 387)
- versioning 154
- Superior-driven transaction recovery 131
- Supporting protocol version 154
- SWhereabouts packet 70
- Syntax - message 57

T

- Timer events
 - application (section 3.1.7 156, section 3.3.6 254, section 3.4.6 303)
 - core transaction manager (section 3.1.7 156, section 3.2.6 172)
 - resource manager (section 3.1.7 156, section 3.5.6 342, section 3.6.6 369)
 - subordinate transaction manager (section 3.1.7 156, section 3.8.6 420)
 - superior transaction manager (section 3.1.7 156, section 3.7.6 396)
 - transaction manager (section 3.1.7 156, section 3.4.6 303, section 3.6.6 369)
- Timers
 - application (section 3.1.2 153, section 3.3.2 222, section 3.4.2 281)
 - core transaction manager (section 3.1.2 153, section 3.2.2 168)
 - resource manager (section 3.1.2 153, section 3.5.2 328, section 3.6.2 358)
 - subordinate transaction manager (section 3.1.2 153, section 3.8.2 411)
 - superior transaction manager (section 3.1.2 153, section 3.7.2 387)
 - transaction manager (section 3.1.2 153, section 3.4.2 281, section 3.6.2 358)
- TM_PROTOCOL enumeration 73
- Tracking changes 460
- Transaction
 - administration - connection types 108
 - completion 80
 - constants 77
 - enumerations 71
 - initiation 80
 - lifetime 34
 - logging - core transaction manager 161
 - manager administration 117
 - marshaling - example
 - branching transaction 432
 - exporting transaction 435
 - importing transaction 439
 - marshaling transaction 429
 - obtaining whereabouts of receiver's transaction manager 434
 - overview (section 4.2 428, section 4.3 434)
 - propagating transaction 437
 - unmarshaling transaction 430
 - propagation
 - connection types 90
 - overview 48
 - structures 63
 - recovery 46
 - roles 41
 - simple - example
 - beginning transaction 426
 - completing transaction 427
 - overview 426
 - states - core transaction manager
 - Aborting 166
 - Active 163
 - Committing 166
 - Ended 167

- Failed To Notify 167
- Idle 163
- In Doubt 166
- Phase One 165
- Phase One Complete 166
- Phase Zero 164
- Phase Zero Complete 164
- Single Phase Commit 166
- Voting 165
- Voting Complete 165
- Transaction manager
 - abstract data model (section 3.1.1 151, section 3.4.1 254, section 3.6.1 344)
 - connection types 118
 - higher-layer triggered events (section 3.1.5 155, section 3.4.4 282, section 3.6.4 359)
 - initialization (section 3.1.3 153, section 3.4.3 281, section 3.6.3 358)
 - local events
 - Associate Transaction Failure 303
 - Associate Transaction Success 304
 - Begin Commit (section 3.4.7.3 304, section 3.6.7.1 370)
 - Begin In Doubt (section 3.4.7.4 305, section 3.6.7.2 370)
 - Begin Phase One 371
 - Begin Phase Zero 371
 - Begin Rollback (section 3.4.7.5 305, section 3.6.7.5 372)
 - Begin Voting (section 3.4.7.6 305, section 3.6.7.6 372)
 - Connection Disconnected 157
 - Create Phase Zero Enlistment Failure 373
 - Create Phase Zero Enlistment Success 373
 - Create Resource Manager 373
 - Create Subordinate Enlistment Failure 374
 - Create Subordinate Enlistment Success 375
 - Create Transaction Failure 306
 - Create Transaction Success 307
 - Create Voter Enlistment Failure (section 3.4.7.9 307, section 3.6.7.12 375)
 - Create Voter Enlistment Success (section 3.4.7.10 308, section 3.6.7.13 376)
 - Export Transaction Failure 308
 - Export Transaction Success 309
 - overview (section 3.1.8 156, section 3.4.7 303, section 3.6.7 369)
 - Phase One Complete 310
 - Phase Zero Aborted 376
 - Phase Zero Complete 311
 - Reenlist Complete 376
 - Register Phase Zero 311
 - Resolve Transaction Complete 312
 - Resource Manager Down 377
 - Rollback Complete 313
 - Set Transaction Attributes Failure 313
 - Set Transaction Attributes Success 314
 - Set Transaction Timeout Failure 314
 - Set Transaction Timeout Success 315
 - Unilaterally Aborted 315
 - message processing
 - resource manager registration 359
 - transaction administration 296
 - transaction coordination 361
 - transaction initiation and completion 282
 - transaction propagation 287
 - transaction recovery 366
 - voting 368
 - overview 151
 - propagation - connection types 118
 - recovery 48
 - role 43
 - sequencing rules
 - resource manager registration 359
 - transaction administration 296

- transaction coordination 361
- transaction initiation and completion 282
- transaction propagation 287
- transaction recovery 366
- voting 368
- timer events (section 3.1.7 156, section 3.4.6 303, section 3.6.6 369)
- timers (section 3.1.2 153, section 3.4.2 281, section 3.6.2 358)
- two-phase commit example
 - overview 444
 - Phase One 445
 - Phase Two 448
- versioning 154
- Transaction manager - core
 - abstract data model (section 3.1.1 151, section 3.2.1 157)
 - higher-layer triggered events (section 3.1.5 155, section 3.2.4 171)
 - initialization
 - durable log 171
 - overview (section 3.1.3 153, section 3.2.3 169)
 - transaction
 - object initialization 170
 - recovery 171
 - local events
 - Associate Transaction 172
 - Begin Commit 173
 - Begin In Doubt 174
 - Begin Phase One 174
 - Begin Phase Zero 174
 - Begin Rollback 175
 - Begin Voting 175
 - Branch Transaction Failure 176
 - Branch Transaction Success 176
 - Connection Disconnected 157
 - Create Phase Zero Enlistment 176
 - Create Subordinate Enlistment 177
 - Create Superior Enlistment 178
 - Create Transaction 179
 - Create Voter Enlistment 180
 - Enlistment Commit Complete 180
 - Enlistment Phase One Complete 181
 - Enlistment Phase Zero Complete 182
 - Enlistment Rollback Complete 183
 - Enlistment Unilaterally Aborted 184
 - Enlistment Vote Complete 185
 - Export Transaction 186
 - Forget Transaction 187
 - Notify Aborted 187
 - Notify Recovered Transaction Committed 188
 - overview (section 3.1.8 156, section 3.2.7 172)
 - Phase One Completed 188
 - Propagate Transaction Failure 189
 - Propagate Transaction Success 189
 - Register Phase Zero Failure 190
 - Register Phase Zero Success 190
 - Request Transaction Outcome 193
 - Resolve Transaction 191
 - Set Transaction Attributes 192
 - Set Transaction Timeout 192
 - Unenlist Phase Zero Enlistment 193
 - Voting Complete 194
- message processing 172
- overview 151
- sequencing rules 172
- timer events (section 3.1.7 156, section 3.2.6 172)
- timers (section 3.1.2 153, section 3.2.2 168)
- versioning 154

- Transaction manager - subordinate
 - abstract data model (section 3.1.1 151, section 3.8.1 401)
 - higher-layer triggered events (section 3.1.5 155, section 3.8.4 412)
 - initialization (section 3.1.3 153, section 3.8.3 411)
 - local events
 - Branch Transaction 420
 - Cancel Check Abort 421
 - Commit Complete 421
 - Connection Disconnected 157
 - Create Superior Enlistment Failure 422
 - Create Superior Enlistment Success 422
 - overview (section 3.1.8 156, section 3.8.7 420)
 - Phase One Complete 423
 - Phase Zero Complete 422
 - Recover In Doubt Transaction 424
 - Register Phase Zero 424
 - Rollback Complete 425
 - Unilaterally Aborted 425
 - message processing
 - transaction propagation and coordination 412
 - transaction recovery 418
 - overview 151
 - sequencing rules
 - transaction propagation and coordination 412
 - transaction recovery 418
 - timer events (section 3.1.7 156, section 3.8.6 420)
 - timers (section 3.1.2 153, section 3.8.2 411)
 - versioning 154
- Transaction manager - superior
 - abstract data model (section 3.1.1 151, section 3.7.1 377)
 - higher-layer triggered events (section 3.1.5 155, section 3.7.4 387)
 - initialization (section 3.1.3 153, section 3.7.3 387)
 - local events
 - Begin Commit 397
 - Begin Phase One 397
 - Begin Phase Zero 398
 - Begin Rollback 398
 - Connection Disconnected 157
 - Create Phase Zero Enlistment Failure 399
 - Create Phase Zero Enlistment Success 399
 - Create Subordinate Enlistment Failure 399
 - Create Subordinate Enlistment Success 400
 - overview (section 3.1.8 156, section 3.7.7 397)
 - Phase Zero Aborted 400
 - Propagate Transaction 400
 - message processing
 - transaction propagation and coordination 388
 - transaction recovery 394
 - overview 151
 - sequencing rules
 - transaction propagation and coordination 388
 - transaction recovery 394
 - timer events (section 3.1.7 156, section 3.7.6 396)
 - timers (section 3.1.2 153, section 3.7.2 387)
 - versioning 154
- Transaction manager administration 117
- Transaction recovery
 - connection types 129
 - resource manager - connection types 144
- Transaction timeout timer 168
- Transaction time-out timer 172
- Transport 56
- Triggered events - higher-layer
 - application
 - beginning transaction 223

- changing transaction time-out 224
- creating export connection 226
- generating trace records for transaction 228
- importing transaction 228
- importing transaction with additional transaction attributes 229
- initiating transaction commit 230
- initiating transaction rollback 231
- obtaining extended whereabouts 233
- obtaining security configuration of transaction manager 233
- overview (section 3.1.5 155, section 3.3.4 222, section 3.4.4 282)
- pulling transaction 234
- pushing transaction 235
- resolving transaction 235
- core transaction manager (section 3.1.5 155, section 3.2.4 171)
- resource manager
 - canceling enlistment as Phase Zero participant on specific transaction 329
 - enlisting as Phase Zero participant on specific transaction 329
 - enlisting on specific transaction 329
 - Enlistment Abort request completed 330
 - Enlistment Commit request completed 330
 - Enlistment Prepare request completed 331
 - Enlistment Single-Phase Commit request completed 332
 - overview (section 3.1.5 155, section 3.5.4 329, section 3.6.4 359)
 - Phase Zero request completed 333
 - registering as voter on specific transaction 333
 - registering with transaction manager 333
 - Voter Vote request completed 334
- subordinate transaction manager (section 3.1.5 155, section 3.8.4 412)
- superior transaction manager (section 3.1.5 155, section 3.7.4 387)
- transaction manager (section 3.1.5 155, section 3.4.4 282, section 3.6.4 359)
- TRUN_TXBEGIN_ERRORS enumeration 74
- TRUN_TXIMPORT_ERRORS enumeration 75
- Two-phase commit example
 - overview 444
 - Phase One 445
 - Phase Two 448
- TXUSER_ASSOCIATE_MTAG_ASSOCIATE packet 90
- TXUSER_ASSOCIATE_MTAG_ASSOCIATED packet 91
- TXUSER_ASSOCIATE_MTAG_COMM_FAILED packet 91
- TXUSER_ASSOCIATE_MTAG_CREATE_BAD_TMADDR packet 92
- TXUSER_ASSOCIATE_MTAG_LOG_FULL_LOCAL packet 92
- TXUSER_ASSOCIATE_MTAG_LOG_FULL_REMOTE packet 92
- TXUSER_ASSOCIATE_MTAG_NO_MEM_LOCAL packet 93
- TXUSER_ASSOCIATE_MTAG_NO_MEM_REMOTE packet 93
- TXUSER_ASSOCIATE_MTAG_TOO_LATE packet 93
- TXUSER_ASSOCIATE_MTAG_TOO_MANY_LOCAL packet 94
- TXUSER_ASSOCIATE_MTAG_TOO_MANY_REMOTE packet 94
- TXUSER_ASSOCIATE_MTAG_TX_NOT_FOUND packet 95
- TXUSER_BEGIN2_MTAG_ABORT packet 84
- TXUSER_BEGIN2_MTAG_BEGIN packet 84
- TXUSER_BEGIN2_MTAG_COMMIT packet 85
- TXUSER_BEGIN2_MTAG_SINK_BEGUN packet 86
- TXUSER_BEGIN2_MTAG_SINK_ERROR packet 86
- TXUSER_BEGINNER_MTAG_ABORT packet 80
- TXUSER_BEGINNER_MTAG_BEGIN packet 80
- TXUSER_BEGINNER_MTAG_BEGIN_LOG_FULL packet 81
- TXUSER_BEGINNER_MTAG_BEGIN_NO_MEM packet 81
- TXUSER_BEGINNER_MTAG_BEGUN packet 82
- TXUSER_BEGINNER_MTAG_COMMIT packet 82
- TXUSER_BEGINNER_MTAG_COMMIT_INDOUBT packet 83
- TXUSER_BEGINNER_MTAG_COMMIT_TOO_LATE packet 83
- TXUSER_BEGINNER_MTAG_PROMOTE packet 89
- TXUSER_BEGINNER_MTAG_REQUEST_COMPLETED packet 84
- TXUSER_ENLISTMENT_MTAG_ABORTREQ packet 138
- TXUSER_ENLISTMENT_MTAG_ABORTREQDONE packet 139

TXUSER_ENLISTMENT_MTAG_COMMITREQ packet 139
TXUSER_ENLISTMENT_MTAG_COMMITREQDONE packet 139
TXUSER_ENLISTMENT_MTAG_ENLIST packet 140
TXUSER_ENLISTMENT_MTAG_ENLIST_LOG_FULL packet 141
TXUSER_ENLISTMENT_MTAG_ENLIST_TOO_LATE packet 141
TXUSER_ENLISTMENT_MTAG_ENLIST_TOO_MANY packet 141
TXUSER_ENLISTMENT_MTAG_ENLIST_TX_NOT_FOUND packet 142
TXUSER_ENLISTMENT_MTAG_ENLISTED packet 142
TXUSER_ENLISTMENT_MTAG_PREPAREREQ packet 143
TXUSER_ENLISTMENT_MTAG_PREPAREREQDONE packet 143
TXUSER_ENLISTMENT_PREPAREREQDONE_RESPONSE enumeration 73
TXUSER_EXPORT_MTAG_CREATE packet 97
TXUSER_EXPORT_MTAG_CREATE_BAD_TMADDR packet 98
TXUSER_EXPORT_MTAG_CREATE_NET_TX_DISABLED packet 98
TXUSER_EXPORT_MTAG_CREATE2 packet 97
TXUSER_EXPORT_MTAG_CREATED packet 99
TXUSER_EXPORT_MTAG_EXPORT packet 99
TXUSER_EXPORT_MTAG_EXPORT_COMM_FAILED packet 102
TXUSER_EXPORT_MTAG_EXPORT_LOG_FULL packet 100
TXUSER_EXPORT_MTAG_EXPORT_NO_MEM packet 100
TXUSER_EXPORT_MTAG_EXPORT_TOO_LATE packet 100
TXUSER_EXPORT_MTAG_EXPORT_TOO_MANY packet 101
TXUSER_EXPORT_MTAG_EXPORT_TX_NOT_FOUND packet 101
TXUSER_EXPORT_MTAG_EXPORTED packet 101
TXUSER_EXTENDEDWHEREABOUTS_MTAG_GET packet 95
TXUSER_EXTENDEDWHEREABOUTS_MTAG_GOT packet 96
TXUSER_EXTENDEDWHEREABOUTS_MTAG_NOMEM packet 96
TXUSER_GETSECURITYFLAGS_MTAG_FETCHED packet 117
TXUSER_GETSECURITYFLAGS_MTAG_GETSECURITYFLAGS packet 118
TXUSER_GETTXDETAILS_MTAG_GET packet 109
TXUSER_GETTXDETAILS_MTAG_GOTIT packet 109
TXUSER_GETTXDETAILS_MTAG_TX_NOT_FOUND packet 110
TXUSER_IMPORT_MTAG_ABORT packet 103
TXUSER_IMPORT_MTAG_ABORT_TOO_LATE packet 103
TXUSER_IMPORT_MTAG_IMPORT packet 104
TXUSER_IMPORT_MTAG_IMPORT_TX_NOT_FOUND packet 104
TXUSER_IMPORT_MTAG_IMPORTED packet 105
TXUSER_IMPORT_MTAG_REQUEST_COMPLETED packet 105
TXUSER_IMPORT2_MTAG_ABORT packet 106
TXUSER_IMPORT2_MTAG_IMPORT packet 106
TXUSER_IMPORT2_MTAG_IMPORT_WITH_SET packet 107
TXUSER_IMPORT2_MTAG_SINK_ERROR packet 107
TXUSER_IMPORT2_MTAG_SINK_IMPORTED packet 108
TXUSER_PHASE0_MTAG_CREATE packet 135
TXUSER_PHASE0_MTAG_CREATE_TOO_LATE packet 136
TXUSER_PHASE0_MTAG_CREATE_TX_NOT_FOUND packet 136
TXUSER_PHASE0_MTAG_CREATED packet 136
TXUSER_PHASE0_MTAG_PHASE0REQ packet 137
TXUSER_PHASE0_MTAG_PHASE0REQ_ABORT packet 137
TXUSER_PHASE0_MTAG_PHASE0REQDONE packet 137
TXUSER_PHASE0_MTAG_UNENLIST packet 138
TXUSER_REENLIST_MTAG_REENLIST packet 144
TXUSER_REENLIST_MTAG_REENLIST_ABORTED packet 145
TXUSER_REENLIST_MTAG_REENLIST_COMMITTED packet 145
TXUSER_REENLIST_MTAG_REENLIST_TIMEOUT packet 145
TXUSER_RESOLVE_MTAG_ACCESSDENIED packet 111
TXUSER_RESOLVE_MTAG_CHILD_ABORT packet 111
TXUSER_RESOLVE_MTAG_CHILD_COMMIT packet 112
TXUSER_RESOLVE_MTAG_CHILD_NOT_PREPARED packet 112
TXUSER_RESOLVE_MTAG_FORGET_COMMITTED packet 113
TXUSER_RESOLVE_MTAG_FORGET_TX_NOT_COMMITTED packet 113
TXUSER_RESOLVE_MTAG_NOT_CHILD packet 114
TXUSER_RESOLVE_MTAG_REQUEST_COMPLETE packet 114
TXUSER_RESOLVE_MTAG_TX_NOT_FOUND packet 114
TXUSER_RESOURCEMANAGER_MTAG_CREATE packet 132

TXUSER_RESOURCEMANAGER_MTAG_DUPLICATE packet 133
TXUSER_RESOURCEMANAGER_MTAG_REENLISTMENTCOMPLETE packet 133
TXUSER_RESOURCEMANAGER_MTAG_REQUEST_COMPLETE packet 134
TXUSER_RESOURCEMANAGERINTERNAL_MTAG_DUPLICATEDETECTED packet 134
TXUSER_SETTXTIMEOUT_MTAG_REQUEST_COMPLETE packet 87
TXUSER_SETTXTIMEOUT_MTAG_SETTXTIMEOUT packet 87
TXUSER_SETTXTIMEOUT_MTAG_TOO_LATE packet 88
TXUSER_SETTXTIMEOUT_MTAG_TX_NOT_FOUND packet 115
TXUSER_STATUS_MTAG_ABORTED packet 146
TXUSER_STATUS_MTAG_COMMITTED packet 146
TXUSER_STATUS_MTAG_INDOUBT packet 147
TXUSER_TRACE_MTAG_DUMP_TRANSACTION packet 116
TXUSER_TRACE_MTAG_REQUEST_COMPLETE packet 116
TXUSER_TRACE_MTAG_REQUEST_FAILED packet 116
TXUSER_TRACE_MTAG_TX_NOT_FOUND packet 117
TXUSER_VOTER_MTAG_CREATE packet 147
TXUSER_VOTER_MTAG_CREATE_TOO_LATE packet 148
TXUSER_VOTER_MTAG_CREATE_TX_NOT_FOUND packet 148
TXUSER_VOTER_MTAG_CREATED packet 148
TXUSER_VOTER_MTAG_VOTEREQ packet 149
TXUSER_VOTER_MTAG_VOTEREQDONE packet 149
TXUSER_VOTER_VOTEREQDONE_RESPONSE enumeration 74

U

Unilateral abort 40
Using negotiated protocol version 155

V

Vendor-extensible fields 54
Version values - computing 57
Versioning (section 1.7 53, section 2.2.1 57)
Versioning - core transaction manager 160
Versioning mechanisms
 overview 53
 structures with fields containing version numbers 60
 structures with format-specifying field 61
 version numbers
 overview 57
 version-specific aspects of connection types relevant to applications 58
 version-specific aspects of connection types relevant to resource managers 60
 version-specific aspects of connection types relevant to transaction managers 60
Versioning negotiation mechanisms 53
Voting - resource manager 146