

[MS-DTCLU-Diff]:

MSDTC Connection Manager: OleTx Transaction Protocol Logical Unit Mainframe Extension

Intellectual Property Rights Notice for Open Specifications Documentation

- **Technical Documentation.** Microsoft publishes Open Specifications documentation (“this documentation”) for protocols, file formats, data portability, computer languages, and standards support. Additionally, overview documents cover inter-protocol relationships and interactions.
- **Copyrights.** This documentation is covered by Microsoft copyrights. Regardless of any other terms that are contained in the terms of use for the Microsoft website that hosts this documentation, you can make copies of it in order to develop implementations of the technologies that are described in this documentation and can distribute portions of it in your implementations that use these technologies or in your documentation as necessary to properly document the implementation. You can also distribute in your implementation, with or without modification, any schemas, IDLs, or code samples that are included in the documentation. This permission also applies to any documents that are referenced in the Open Specifications documentation.
- **No Trade Secrets.** Microsoft does not claim any trade secret rights in this documentation.
- **Patents.** Microsoft has patents that might cover your implementations of the technologies described in the Open Specifications documentation. Neither this notice nor Microsoft's delivery of this documentation grants any licenses under those patents or any other Microsoft patents. However, a given Open Specifications document might be covered by the Microsoft [Open Specifications Promise](#) or the [Microsoft Community Promise](#). If you would prefer a written license, or if the technologies described in this documentation are not covered by the Open Specifications Promise or Community Promise, as applicable, patent licenses are available by contacting iplg@microsoft.com.
- **License Programs.** To see all of the protocols in scope under a specific license program and the associated patents, visit the [Patent Map](#).
- **Trademarks.** The names of companies and products contained in this documentation might be covered by trademarks or similar intellectual property rights. This notice does not grant any licenses under those rights. For a list of Microsoft trademarks, visit www.microsoft.com/trademarks.
- **Fictitious Names.** The example companies, organizations, products, domain names, email addresses, logos, people, places, and events that are depicted in this documentation are fictitious. No association with any real company, organization, product, domain name, email address, logo, person, place, or event is intended or should be inferred.

Reservation of Rights. All other rights are reserved, and this notice does not grant any rights other than as specifically described above, whether by implication, estoppel, or otherwise.

Tools. The Open Specifications documentation does not require the use of Microsoft programming tools or programming environments in order for you to develop an implementation. If you have access to Microsoft programming tools and environments, you are free to take advantage of them. Certain Open Specifications documents are intended for use in conjunction with publicly available standards specifications and network programming art and, as such, assume that the reader either is familiar with the aforementioned material or has immediate access to it.

Support. For questions and support, please contact dochelp@microsoft.com.

Revision Summary

Date	Revision History	Revision Class	Comments
7/20/2007	0.1	Major	MCPP Milestone 5 Initial Availability
9/28/2007	0.1.1	Editorial	Changed language and formatting in the technical content.
10/23/2007	0.2	Minor	Revised some data types.
11/30/2007	0.2.1	Editorial	Changed language and formatting in the technical content.
1/25/2008	0.2.2	Editorial	Changed language and formatting in the technical content.
3/14/2008	0.2.3	Editorial	Changed language and formatting in the technical content.
5/16/2008	0.2.4	Editorial	Changed language and formatting in the technical content.
6/20/2008	0.2.5	Editorial	Changed language and formatting in the technical content.
7/25/2008	0.2.6	Editorial	Changed language and formatting in the technical content.
8/29/2008	0.3	Minor	Clarified the meaning of the technical content.
10/24/2008	0.4	Minor	Clarified the meaning of the technical content.
12/5/2008	1.0	Major	Updated and revised the technical content.
1/16/2009	1.0.1	Editorial	Changed language and formatting in the technical content.
2/27/2009	1.0.2	Editorial	Changed language and formatting in the technical content.
4/10/2009	1.1	Minor	Clarified the meaning of the technical content.
5/22/2009	1.2	Minor	Clarified the meaning of the technical content.
7/2/2009	2.0	Major	Updated and revised the technical content.
8/14/2009	2.1	Minor	Clarified the meaning of the technical content.
9/25/2009	3.0	Major	Updated and revised the technical content.
11/6/2009	3.1	Minor	Clarified the meaning of the technical content.
12/18/2009	4.0	Major	Updated and revised the technical content.
1/29/2010	5.0	Major	Updated and revised the technical content.
3/12/2010	5.1	Minor	Clarified the meaning of the technical content.
4/23/2010	5.2	Minor	Clarified the meaning of the technical content.
6/4/2010	6.0	Major	Updated and revised the technical content.
7/16/2010	7.0	Major	Updated and revised the technical content.
8/27/2010	8.0	Major	Updated and revised the technical content.
10/8/2010	9.0	Major	Updated and revised the technical content.
11/19/2010	10.0	Major	Updated and revised the technical content.
1/7/2011	10.0	None	No changes to the meaning, language, or formatting of the

Date	Revision History	Revision Class	Comments
			technical content.
2/11/2011	10.0	None	No changes to the meaning, language, or formatting of the technical content.
3/25/2011	10.0	None	No changes to the meaning, language, or formatting of the technical content.
5/6/2011	10.0	None	No changes to the meaning, language, or formatting of the technical content.
6/17/2011	10.1	Minor	Clarified the meaning of the technical content.
9/23/2011	10.1	None	No changes to the meaning, language, or formatting of the technical content.
12/16/2011	11.0	Major	Updated and revised the technical content.
3/30/2012	11.0	None	No changes to the meaning, language, or formatting of the technical content.
7/12/2012	11.0	None	No changes to the meaning, language, or formatting of the technical content.
10/25/2012	11.1	Minor	Clarified the meaning of the technical content.
1/31/2013	11.1	None	No changes to the meaning, language, or formatting of the technical content.
8/8/2013	11.2	Minor	Clarified the meaning of the technical content.
11/14/2013	11.2	None	No changes to the meaning, language, or formatting of the technical content.
2/13/2014	11.2	None	No changes to the meaning, language, or formatting of the technical content.
5/15/2014	11.2	None	No changes to the meaning, language, or formatting of the technical content.
6/30/2015	12.0	Major	Significantly changed the technical content.
10/16/2015	12.0	None	No changes to the meaning, language, or formatting of the technical content.
7/14/2016	12.0	None	No changes to the meaning, language, or formatting of the technical content.
6/1/2017	12.0	None	No changes to the meaning, language, or formatting of the technical content.
9/15/2017	13.0	Major	Significantly changed the technical content.
9/12/2018	14.0	Major	Significantly changed the technical content.

Table of Contents

1	(Updated Section) Introduction.....	13
1.1	Glossary	13
1.2	References	16
1.2.1	Normative References	16
1.2.2	Informative References	17
1.3	(Updated Section) Overview	17
1.3.1	Scenarios	17
1.3.1.1	Enlistment and Completion.....	18
1.3.1.2	Transaction Recovery	20
1.3.2	Transaction Roles	21
1.3.2.1	LU 6.2 Implementation Role	22
1.3.2.2	Transaction Manager Role	22
1.3.2.2.1	Transaction Manager Communicating with an LU 6.2 Implementation Facet	22
1.4	Relationship to Other Protocols	22
1.5	Prerequisites/Preconditions	23
1.6	Applicability Statement	23
1.7	Versioning and Capability Negotiation	23
1.8	Vendor-Extensible Fields	23
1.9	Standards Assignments.....	24
2	Messages.....	25
2.1	Transport.....	25
2.2	Message Syntax.....	25
2.2.1	Common Structures	25
2.2.1.1	MESSAGE_PACKET	25
2.2.1.2	DTCLU_VARLEN_BYTEARRAY	26
2.2.2	Transaction Enumerations.....	26
2.2.2.1	DTCLUCOMPARESTATE	26
2.2.2.2	DTCLUCOMPARESTATESCONFIRMATION	27
2.2.2.3	DTCLUCOMPARESTATESERROR.....	27
2.2.2.4	DTCLUXLN	27
2.2.2.5	DTCLUXLNCONFIRMATION	27
2.2.2.6	DTCLUXLNERROR.....	28
2.2.2.7	DTCLUCOMPARESTATESRESPONSE	28
2.2.2.8	DTCLUXLNRESPONSE	29
2.2.2.9	CONNTYPE	29
2.2.3	Connection Types Relevant to LU 6.2	30
2.2.3.1	CONNTYPE_TXUSER_DTCLUCONFIGURE	30
2.2.3.1.1	TXUSER_DTCLURMCONFIGURE_MTAG_ADD	30
2.2.3.1.2	TXUSER_DTCLURMCONFIGURE_MTAG_DELETE	30
2.2.3.1.3	TXUSER_DTCLURMCONFIGURE_MTAG_REQUEST_COMPLETED.....	31
2.2.3.1.4	TXUSER_DTCLURMCONFIGURE_MTAG_ADD_DUPLICATE.....	31
2.2.3.1.5	TXUSER_DTCLURMCONFIGURE_MTAG_DELETE_NOT_FOUND	32
2.2.3.1.6	TXUSER_DTCLURMCONFIGURE_MTAG_DELETE_UNRECOVERED_TRANS	32
2.2.3.1.7	TXUSER_DTCLURMCONFIGURE_MTAG_DELETE_INUSE	32
2.2.3.1.8	TXUSER_DTCLURMCONFIGURE_MTAG_ADD_LOG_FULL	33
2.2.3.2	CONNTYPE_TXUSER_DTCLURECOVERY	33
2.2.3.2.1	TXUSER_DTCLURMRECOVERY_MTAG_ATTACH	33
2.2.3.2.2	TXUSER_DTCLURMRECOVERY_MTAG_REQUEST_COMPLETED	34
2.2.3.2.3	TXUSER_DTCLURMRECOVERY_MTAG_ATTACH_DUPLICATE	34
2.2.3.2.4	TXUSER_DTCLURMRECOVERY_MTAG_ATTACH_NOT_FOUND.....	35
2.2.3.3	CONNTYPE_TXUSER_DTCLURMENLISTMENT	35
2.2.3.3.1	TXUSER_DTCLURMENLISTMENT_MTAG_CREATE	35
2.2.3.3.2	TXUSER_DTCLURMENLISTMENT_MTAG_REQUEST_COMPLETED	36

2.2.3.3.3	TXUSER_DTCLURMENLISTMENT_MTAG_TO_DTC_CONVERSATIONLOST	36
2.2.3.3.4	TXUSER_DTCLURMENLISTMENT_MTAG_TO_DTC_BACKEDOUT	37
2.2.3.3.5	TXUSER_DTCLURMENLISTMENT_MTAG_TO_DTC_BACKOUT	37
2.2.3.3.6	TXUSER_DTCLURMENLISTMENT_MTAG_TO_DTC_COMMITTED	37
2.2.3.3.7	TXUSER_DTCLURMENLISTMENT_MTAG_TO_DTC_FORGET	38
2.2.3.3.8	TXUSER_DTCLURMENLISTMENT_MTAG_TO_DTC_REQUESTCOMMIT	38
2.2.3.3.9	TXUSER_DTCLURMENLISTMENT_MTAG_TO_LU_BACKEDOUT	39
2.2.3.3.10	TXUSER_DTCLURMENLISTMENT_MTAG_TO_LU_BACKOUT	39
2.2.3.3.11	TXUSER_DTCLURMENLISTMENT_MTAG_TO_LU_COMMITTED	39
2.2.3.3.12	TXUSER_DTCLURMENLISTMENT_MTAG_TO_LU_PREPARE	40
2.2.3.3.13	TXUSER_DTCLURMENLISTMENT_MTAG_CREATE_TX_NOT_FOUND	40
2.2.3.3.14	TXUSER_DTCLURMENLISTMENT_MTAG_CREATE_TOO_LATE	40
2.2.3.3.15	TXUSER_DTCLURMENLISTMENT_MTAG_CREATE_LOG_FULL	41
2.2.3.3.16	TXUSER_DTCLURMENLISTMENT_MTAG_CREATE_TOO_MANY	41
2.2.3.3.17	TXUSER_DTCLURMENLISTMENT_MTAG_CREATE_LU_NOT_FOUND	42
2.2.3.3.18	TXUSER_DTCLURMENLISTMENT_MTAG_UNPLUG	42
2.2.3.3.19	TXUSER_DTCLURMENLISTMENT_MTAG_CREATE_DUPLICATE_LU_TRANSID	42
2.2.3.3.20	TXUSER_DTCLURMENLISTMENT_MTAG_CREATE_LU_NO_RECOVERY_PROCESSES	43
2.2.3.3.21	TXUSER_DTCLURMENLISTMENT_MTAG_CREATE_LU_DOWN	43
2.2.3.3.22	TXUSER_DTCLURMENLISTMENT_MTAG_CREATE_LU_RECOVERING	44
2.2.3.3.23	TXUSER_DTCLURMENLISTMENT_MTAG_CREATE_LU_RECOVERY_MISMATCH	44
2.2.3.4	CONNTYPE_TXUSER_DTCLURECOVERYINITIATEDBYDTC	44
2.2.3.4.1	TXUSER_DTCLURECOVERYINITIATEDBYDTC_MTAG_GETWORK	45
2.2.3.4.2	TXUSER_DTCLURECOVERYINITIATEDBYDTC_MTAG_GETWORK_NOT_FOUND	45
2.2.3.4.3	TXUSER_DTCLURECOVERYINITIATEDBYDTC_MTAG_WORK_CHECKLUSTATUS	46
2.2.3.4.4	TXUSER_DTCLURECOVERYINITIATEDBYDTC_MTAG_WORK_TRANS	46
2.2.3.4.5	TXUSER_DTCLURECOVERYINITIATEDBYDTC_MTAG_LUSTATUS	47
2.2.3.4.6	TXUSER_DTCLURECOVERYINITIATEDBYDTC_MTAG_REQUESTCOMPLETE	47
2.2.3.4.7	TXUSER_DTCLURECOVERYINITIATEDBYDTC_MTAG_CONFIRMATION_FROM_OUR_XLN	48
2.2.3.4.8	TXUSER_DTCLURECOVERYINITIATEDBYDTC_MTAG_THEIR_XLN_RESPONSE	48
2.2.3.4.9	TXUSER_DTCLURECOVERYINITIATEDBYDTC_MTAG_CONFIRMATION_FOR_THEIR_XLN	49
2.2.3.4.10	TXUSER_DTCLURECOVERYINITIATEDBYDTC_MTAG_ERROR_FROM_OUR_XLN	50
2.2.3.4.11	TXUSER_DTCLURECOVERYINITIATEDBYDTC_MTAG_CHECK_FOR_COMPARE_STATES	50
2.2.3.4.12	TXUSER_DTCLURECOVERYINITIATEDBYDTC_MTAG_COMPARESTATES_INFO	50
2.2.3.4.13	TXUSER_DTCLURECOVERYINITIATEDBYDTC_MTAG_NO_COMPARESTATES	51
2.2.3.4.14	TXUSER_DTCLURECOVERYINITIATEDBYDTC_MTAG_THEIR_COMPARESTATES	51

2.2.3.4.15	TXUSER_DTCLURECOVERYINITIATEDBYDTC_MTAG_CONFIRMATION_FOR_T HEIR_COMPARESTATES	52
2.2.3.4.16	TXUSER_DTCLURECOVERYINITIATEDBYDTC_MTAG_ERROR_FROM_OUR_CO MPARESTATES	52
2.2.3.4.17	TXUSER_DTCLURECOVERYINITIATEDBYDTC_MTAG_CONVERSATION_LOST	53
2.2.3.4.18	TXUSER_DTCLURECOVERYINITIATEDBYDTC_MTAG_NEW_RECOVERY_SEQ NUM	53
2.2.3.5	CONNTYPE_TXUSER_DTCLURECOVERYINITIATEDBYLU	54
2.2.3.5.1	TXUSER_DTCLURECOVERYINITIATEDBYLU_MTAG_THEIR_XLN.....	54
2.2.3.5.2	TXUSER_DTCLURECOVERYINITIATEDBYLU_MTAG_RESPONSE_FOR_THEIR_ XLN	55
2.2.3.5.3	TXUSER_DTCLURECOVERYINITIATEDBYLU_MTAG_CONFIRMATION_OF_OUR _XLN	56
2.2.3.5.4	TXUSER_DTCLURECOVERYINITIATEDBYLU_MTAG_THEIR_COMPARESTATES	57
2.2.3.5.5	TXUSER_DTCLURECOVERYINITIATEDBYLU_MTAG_RESPONSE_FOR_THEIR_ COMPARESTATES	57
2.2.3.5.6	TXUSER_DTCLURECOVERYINITIATEDBYLU_MTAG_CONFIRMATION_OF_OUR _COMPARESTATES	58
2.2.3.5.7	TXUSER_DTCLURECOVERYINITIATEDBYLU_MTAG_ERROR_OF_OUR_COMPA RESTATES	58
2.2.3.5.8	TXUSER_DTCLURECOVERYINITIATEDBYLU_MTAG_CONVERSATION_LOST	59
2.2.3.5.9	TXUSER_DTCLURECOVERYINITIATEDBYLU_MTAG_REQUESTCOMPLETE .	59
2.2.3.5.10	TXUSER_DTCLURECOVERYINITIATEDBYLU_MTAG_THEIR_XLN_NOT_FOUND	60
3	Protocol Details.....	61
3.1	Common Details	61
3.1.1	Abstract Data Model.....	61
3.1.2	Timers	61
3.1.3	Initialization.....	61
3.1.4	Protocol Version Negotiation	61
3.1.5	Higher-Layer Triggered Events	62
3.1.6	Message Processing Events and Sequencing Rules	62
3.1.7	Timer Events.....	62
3.1.8	Other Local Events.....	62
3.2	LU 6.2 Implementation Details.....	62
3.2.1	Abstract Data Model.....	62
3.2.1.1	CONNTYPE_TXUSER_DTCLUCONFIGURE Initiator States	63
3.2.1.1.1	Idle	64
3.2.1.1.2	Awaiting Add Response	64
3.2.1.1.3	Awaiting Delete Response.....	64
3.2.1.1.4	Ended	65
3.2.1.2	CONNTYPE_TXUSER_DTCLURECOVERY Initiator States	65
3.2.1.2.1	Idle	66
3.2.1.2.2	Awaiting Register Response	66
3.2.1.2.3	Registered	66
3.2.1.2.4	Ended	67
3.2.1.3	CONNTYPE_TXUSER_DTCLURMENLISTMENT Initiator States.....	67

3.2.1.3.1	Idle	68
3.2.1.3.2	Awaiting Enlistment Response.....	69
3.2.1.3.3	Active	69
3.2.1.3.4	Preparing for Transaction Commit.....	69
3.2.1.3.5	Awaiting Backout Response	69
3.2.1.3.6	Awaiting Transaction Outcome	69
3.2.1.3.7	Finalizing Abort Operations	70
3.2.1.3.8	Finalizing Commit Operations.....	70
3.2.1.3.9	Ended	70
3.2.1.4	CONNTYPE_TXUSER_DTCLURECOVERYINITIATEDBYDTC Initiator States.....	70
3.2.1.4.1	Idle	72
3.2.1.4.2	Awaiting Response to Work Query	72
3.2.1.4.3	Processing Cold XLN Request	73
3.2.1.4.4	Processing Warm XLN Request.....	73
3.2.1.4.5	Awaiting Response to XLN Confirmation	73
3.2.1.4.6	Awaiting Response to XLN	73
3.2.1.4.7	Awaiting Response to Compare States Query During Warm XLN	73
3.2.1.4.8	XLN Exchange Complete.....	74
3.2.1.4.9	Awaiting Response to Compare States Query	74
3.2.1.4.10	Processing Compare States Request	74
3.2.1.4.11	Awaiting Response to Compare States	74
3.2.1.4.12	Processing LU Status Check	74
3.2.1.4.13	Awaiting Request Complete	74
3.2.1.4.14	Ended	75
3.2.1.5	CONNTYPE_TXUSER_DTCLURECOVERYINITIATEDBYLU Initiator States	75
3.2.1.5.1	Idle	76
3.2.1.5.2	Awaiting Response to XLN Request.....	76
3.2.1.5.3	Processing XLN Confirmation	77
3.2.1.5.4	Awaiting Response to XLN Confirmation	77
3.2.1.5.5	Awaiting Response to XLN Confirmation with Error	77
3.2.1.5.6	XLN Exchange Complete.....	77
3.2.1.5.7	Awaiting Response to Compare States	77
3.2.1.5.8	Processing Compare States Response	77
3.2.1.5.9	Awaiting Request Complete	78
3.2.1.5.10	Ended	78
3.2.2	Timers	78
3.2.3	Initialization.....	78
3.2.4	Higher-Layer Triggered Events	78
3.2.4.1	Adding an LU Name Pair	78
3.2.4.2	Deleting an LU Name Pair	79
3.2.4.3	Registering Recovery Process For LU Pair	79
3.2.4.4	All Sessions Lost	79
3.2.4.5	Creating LU 6.2 Subordinate Enlistment.....	80
3.2.4.6	Aborting LU 6.2 Subordinate Enlistment.....	80
3.2.4.7	LU 6.2 Subordinate Enlistment Prepare Request Completed.....	81
3.2.4.8	LU 6.2 Subordinate Enlistment Conversation Lost.....	81
3.2.4.9	Unplugging LU 6.2 Subordinate Enlistment.....	82
3.2.4.10	LU 6.2 Subordinate Enlistment Abort Request Completed	82
3.2.4.11	LU 6.2 Subordinate Enlistment Commit Request Completed	82
3.2.4.12	LU 6.2 Subordinate Enlistment Single-Phase Commit Request Completed	83
3.2.4.13	Local LU Initiated Recovery Sending Query For Work.....	83
3.2.4.14	Local LU Initiated Recovery Sending New Recovery Sequence Number	83
3.2.4.15	Local LU Initiated Recovery Sending XLN Error	84
3.2.4.16	Local LU Initiated Recovery Sending XLN Response	84
3.2.4.17	Local LU Initiated Recovery Sending XLN Confirmation	85
3.2.4.18	Local LU Initiated Recovery Sending Compare States Query	86
3.2.4.19	Local LU Initiated Recovery Sending Compare States	87
3.2.4.20	Local LU Initiated Recovery Sending Compare States Error.....	87

3.2.4.21	Local LU Initiated Recovery Sending LU Status	88
3.2.4.22	Local LU Initiated Recovery Conversation Lost	88
3.2.4.23	Remote LU Initiated Recovery Sending XLN	89
3.2.4.24	Remote LU Initiated Recovery Sending XLN Confirmation	90
3.2.4.25	Remote LU Initiated Recovery Sending Compare States	91
3.2.4.26	Remote LU Initiated Recovery Sending Compare States Confirmation	92
3.2.4.27	Remote LU Initiated Recovery Sending Compare States Error	92
3.2.4.28	Remote LU Initiated Recovery Conversation Lost.....	93
3.2.5	Message Processing Events and Sequencing Rules	93
3.2.5.1	CONNTYPE_TXUSER_DTCLUCONFIGURE as Initiator	93
3.2.5.1.1	Receiving a TXUSER_DTCLURMCONFIGURE_MTAG_ADD_DUPLICATE Message.....	93
3.2.5.1.2	Receiving a TXUSER_DTCLURMCONFIGURE_MTAG_DELETE_NOT_FOUND Message.....	93
3.2.5.1.3	Receiving a TXUSER_DTCLURMCONFIGURE_MTAG_DELETE_UNRECOVERED_TRANS Message.....	93
3.2.5.1.4	Receiving a TXUSER_DTCLURMCONFIGURE_MTAG_DELETE_INUSE Message	94
3.2.5.1.5	Receiving a TXUSER_DTCLURMCONFIGURE_MTAG_REQUEST_COMPLETED Message.....	94
3.2.5.1.6	Receiving a TXUSER_DTCLURMCONFIGURE_MTAG_ADD_LOG_FULL Message.....	94
3.2.5.1.7	Connection Disconnected.....	94
3.2.5.2	CONNTYPE_TXUSER_DTCLURECOVERY as Initiator.....	95
3.2.5.2.1	Receiving a TXUSER_DTCLURMRECOVERY_MTAG_ATTACH_NOT_FOUND Message.....	95
3.2.5.2.2	Receiving a TXUSER_DTCLURMRECOVERY_MTAG_ATTACH_DUPLICATE Message.....	95
3.2.5.2.3	Receiving a TXUSER_DTCLURMRECOVERY_MTAG_REQUEST_COMPLETED Message.....	95
3.2.5.2.4	Connection Disconnected.....	96
3.2.5.3	CONNTYPE_TXUSER_DTCLURMENLISTMENT as Initiator	96
3.2.5.3.1	Receiving a TXUSER_DTCLURMENLISTMENT_MTAG_REQUEST_COMPLETED Message.....	96
3.2.5.3.2	Receiving Other TXUSER_DTCLURMENLISTMENT_MTAG Messages.....	96
3.2.5.3.3	Receiving a TXUSER_DTCLURMENLISTMENT_MTAG_TO_LU_PREPARE Message.....	97
3.2.5.3.4	Receiving a TXUSER_DTCLURMENLISTMENT_MTAG_TO_LU_BACKEDOUT Message.....	97
3.2.5.3.5	Receiving a TXUSER_DTCLURMENLISTMENT_MTAG_TO_LU_BACKOUT Message.....	97
3.2.5.3.6	Receiving a TXUSER_DTCLURMENLISTMENT_MTAG_TO_LU_COMMITTED Message.....	98
3.2.5.3.7	Connection Disconnected.....	98
3.2.5.4	CONNTYPE_TXUSER_DTCLURECOVERYINITIATEDBYDTC as Initiator	98
3.2.5.4.1	Receiving a TXUSER_DTCLURECOVERYINITIATEDBYDTC_MTAG_GETWORK_NOT_FOUN D Message.....	98
3.2.5.4.2	Receiving a TXUSER_DTCLURECOVERYINITIATEDBYDTC_MTAG_WORK_CHECKLUSTATU S Message.....	98
3.2.5.4.3	Receiving a TXUSER_DTCLURECOVERYINITIATEDBYDTC_MTAG_WORK_TRANS Message	99
3.2.5.4.4	Receiving a TXUSER_DTCLURECOVERYINITIATEDBYDTC_MTAG_CONFIRMATION_FOR_T HEIR_XLN Message	99

3.2.5.4.5	Receiving a TXUSER_DTCLURECOVERYINITIATEDBYDTC_MTAG_NO_COMPARESTATES Message.....	100
3.2.5.4.6	Receiving a TXUSER_DTCLURECOVERYINITIATEDBYDTC_MTAG_COMPARESTATES_INFO Message.....	100
3.2.5.4.7	Receiving a TXUSER_DTCLURECOVERYINITIATEDBYDTC_MTAG_CONFIRMATION_FOR_T HEIR_COMPARESTATES Message	101
3.2.5.4.8	Receiving a TXUSER_DTCLURECOVERYINITIATEDBYDTC_MTAG_REQUESTCOMPLETE Message.....	101
3.2.5.4.9	Connection Disconnected.....	102
3.2.5.5	CONNTYPE_TXUSER_DTCLURECOVERYINITIATEDBYLU as Initiator.....	102
3.2.5.5.1	Receiving a TXUSER_DTCLURECOVERYINITIATEDBYLU_MTAG_THEIR_XLN_NOT_FOUND Message.....	102
3.2.5.5.2	Receiving a TXUSER_DTCLURECOVERYINITIATEDBYLU_MTAG_RESPONSE_FOR_THEIR_XLN Message	102
3.2.5.5.3	Receiving a TXUSER_DTCLURECOVERYINITIATEDBYLU_MTAG_RESPONSE_FOR_THEIR_COMPARESTATES Message	103
3.2.5.5.4	Receiving a TXUSER_DTCLURECOVERYINITIATEDBYLU_MTAG_REQUESTCOMPLETE Message.....	104
3.2.5.5.5	Connection Disconnected.....	104
3.2.6	Timer Events.....	104
3.2.7	Other Local Events.....	104
3.3	Transaction Manager Communicating with an LU 6.2 Implementation Facet Details	104
3.3.1	Abstract Data Model.....	104
3.3.1.1	Logging	107
3.3.1.2	CONNTYPE_TXUSER_DTCLUCONFIGURE Acceptor States	108
3.3.1.2.1	Idle	108
3.3.1.2.2	Processing Add Request	108
3.3.1.2.3	Processing Delete Request.....	108
3.3.1.2.4	Ended	108
3.3.1.2.5	State Diagram	108
3.3.1.3	CONNTYPE_TXUSER_DTCLURECOVERY Acceptor States	109
3.3.1.3.1	Idle	109
3.3.1.3.2	Processing Register Request	109
3.3.1.3.3	Registered	109
3.3.1.3.4	Ended	110
3.3.1.3.5	State Diagram	110
3.3.1.4	CONNTYPE_TXUSER_DTCLURMENLISTMENT Acceptor States.....	110
3.3.1.4.1	Idle	111
3.3.1.4.2	Processing Enlistment Request	111
3.3.1.4.3	Active	111
3.3.1.4.4	Awaiting Prepare Response.....	111
3.3.1.4.5	Processing Backout Request.....	111
3.3.1.4.6	Prepared	112
3.3.1.4.7	Awaiting Commit Response.....	112
3.3.1.4.8	Awaiting Abort Response	112
3.3.1.4.9	Ended	112
3.3.1.4.10	State Diagram	112
3.3.1.5	CONNTYPE_TXUSER_DTCLURECOVERYINITIATEDBYDTC Acceptor States....	113
3.3.1.5.1	Idle	114
3.3.1.5.2	Processing Work Query	114

3.3.1.5.3	Awaiting Response To Cold XLN.....	114
3.3.1.5.4	Processing Response To Cold XLN.....	115
3.3.1.5.5	Awaiting Response To Warm XLN	115
3.3.1.5.6	Processing Response to Warm XLN	115
3.3.1.5.7	Processing Compare State Query During Warm XLN.....	115
3.3.1.5.8	Awaiting LU Status Response	115
3.3.1.5.9	Processing LU Status Response	115
3.3.1.5.10	Awaiting Compare States Query	116
3.3.1.5.11	Processing Compare States Query	116
3.3.1.5.12	Awaiting Compare States Response	116
3.3.1.5.13	Processing Compare States Response	116
3.3.1.5.14	Processing Compare States Error.....	116
3.3.1.5.15	Is Obsolete Awaiting Response To Cold XLN.....	116
3.3.1.5.16	Is Obsolete Awaiting Response To Warm XLN.....	116
3.3.1.5.17	Is Obsolete Awaiting LU Status Response	117
3.3.1.5.18	Is Obsolete Processing Response	117
3.3.1.5.19	Is Obsolete Processing Compare State Query During Warm XLN.....	117
3.3.1.5.20	Ended	117
3.3.1.5.21	State Diagram	117
3.3.1.6	CONNTYPE_TXUSER_DTCLURECOVERYINITIATEDBYLU Acceptor States	121
3.3.1.6.1	Idle	122
3.3.1.6.2	Processing XLN Request	122
3.3.1.6.3	Awaiting XLN Confirmation	122
3.3.1.6.4	Processing XLN Confirmation	122
3.3.1.6.5	Awaiting Compare States Request	122
3.3.1.6.6	Processing Compare States Request	122
3.3.1.6.7	Awaiting Compare States Confirmation	122
3.3.1.6.8	Processing Compare States Confirmation.....	123
3.3.1.6.9	Is Obsolete Awaiting XLN Confirmation.....	123
3.3.1.6.10	Ended	123
3.3.1.6.11	State Diagram	123
3.3.2	Timers	124
3.3.2.1	LU Status Timer.....	124
3.3.3	Initialization.....	125
3.3.4	Higher-Layer Triggered Events	125
3.3.4.1	Recover	125
3.3.5	Message Processing Events and Sequencing Rules	126
3.3.5.1	CONNTYPE_TXUSER_DTCLUCONFIGURE as Acceptor	126
3.3.5.1.1	Receiving a TXUSER_DTCLURMCONFIGURE_MTAG_ADD Message.....	126
3.3.5.1.2	Receiving a TXUSER_DTCLURMCONFIGURE_MTAG_DELETE Message	127
3.3.5.2	CONNTYPE_TXUSER_DTCLURECOVERY as Acceptor.....	128
3.3.5.2.1	Receiving a TXUSER_DTCLURMRECOVERY_MTAG_ATTACH Message	128
3.3.5.2.2	Connection Disconnected.....	129
3.3.5.3	CONNTYPE_TXUSER_DTCLURMENLISTMENT as Acceptor	129
3.3.5.3.1	Receiving a TXUSER_DTCLURMENLISTMENT_MTAG_CREATE Message...130	
3.3.5.3.2	Receiving a TXUSER_DTCLURMENLISTMENT_MTAG_TO_DTC_REQUESTCOMMIT Message.....	132
3.3.5.3.3	Receiving a TXUSER_DTCLURMENLISTMENT_MTAG_TO_DTC_BACKOUT Message.....	132
3.3.5.3.4	Receiving a TXUSER_DTCLURMENLISTMENT_MTAG_TO_DTC_FORGET Message.....	133
3.3.5.3.5	Receiving a TXUSER_DTCLURMENLISTMENT_MTAG_TO_DTC_BACKEDOUT Message.....	133
3.3.5.3.6	Receiving a TXUSER_DTCLURMENLISTMENT_MTAG_TO_DTC_CONVERSATIONLOST Message.....	134
3.3.5.3.7	Connection Disconnected.....	135

3.3.5.4	CONNTYPE_TXUSER_DTCLURECOVERYINITIATEDBYDTC as Acceptor	135
3.3.5.4.1	Receiving a TXUSER_DTCLURECOVERYINITIATEDBYDTC_MTAG_GETWORK Message.....	136
3.3.5.4.2	Receiving a TXUSER_DTCLURECOVERYINITIATEDBYDTC_MTAG_NEW_RECOVERY_SEQ_ NUM Message	136
3.3.5.4.3	Receiving a TXUSER_DTCLURECOVERYINITIATEDBYDTC_MTAG_CONFIRMATION_FROM _OUR_XLN Message	138
3.3.5.4.4	Receiving a TXUSER_DTCLURECOVERYINITIATEDBYDTC_MTAG_ERROR_FROM_OUR_XL N Message.....	139
3.3.5.4.5	Receiving a TXUSER_DTCLURECOVERYINITIATEDBYDTC_MTAG_THEIR_XLN_RESPONSE Message.....	141
3.3.5.4.6	Receiving a TXUSER_DTCLURECOVERYINITIATEDBYDTC_MTAG_CHECK_FOR_COMPARE STATES Message	144
3.3.5.4.7	Receiving a TXUSER_DTCLURECOVERYINITIATEDBYDTC_MTAG_THEIR_COMPARESTATE S Message.....	147
3.3.5.4.8	Receiving a TXUSER_DTCLURECOVERYINITIATEDBYDTC_MTAG_ERROR_FROM_OUR_CO MPARESTATES Message	149
3.3.5.4.9	Receiving a TXUSER_DTCLURECOVERYINITIATEDBYDTC_MTAG_LUSTATUS Message.....	149
3.3.5.4.10	Connection Disconnected.....	150
3.3.5.5	CONNTYPE_TXUSER_DTCLURECOVERYINITIATEDBYLU as Acceptor.....	151
3.3.5.5.1	Receiving a TXUSER_DTCLURECOVERYINITIATEDBYLU_MTAG_THEIR_XLN Message.....	151
3.3.5.5.2	Receiving a TXUSER_DTCLURECOVERYINITIATEDBYLU_MTAG_CONFIRMATION_OF_OUR _XLN Message	155
3.3.5.5.3	Receiving a TXUSER_DTCLURECOVERYINITIATEDBYLU_MTAG_THEIR_COMPARESTATES Message.....	156
3.3.5.5.4	Receiving a TXUSER_DTCLURECOVERYINITIATEDBYLU_MTAG_CONFIRMATION_OF_OUR _COMPARESTATES Message	159
3.3.5.5.5	Receiving a TXUSER_DTCLURECOVERYINITIATEDBYLU_MTAG_ERROR_OF_OUR_COMPA RESTATES Message	160
3.3.5.5.6	Connection Disconnected.....	160
3.3.6	Timer Events.....	161
3.3.6.1	LU Status Timer Tick	161
3.3.7	Other Local Events.....	161
3.3.7.1	Create Subordinate Enlistment Success	161
3.3.7.2	Create Subordinate Enlistment Failure	162
3.3.7.3	Begin Phase One.....	162
3.3.7.4	Begin Rollback.....	163
3.3.7.5	Begin Commit.....	163
3.3.7.6	Local LU Initiated Recovery Obsolete XLN Exchange	164
3.3.7.7	Send Cold XLN.....	165
3.3.7.8	Send Warm XLN	165
3.3.7.9	Send Check LU Status	166
3.3.7.10	Remote LU Initiated Recovery Obsolete XLN Exchange	166
3.3.7.11	Recovery Work Ready.....	166
3.3.7.12	Received New Recovery Sequence Number	169

3.3.7.13	Obsolete All XLN Exchanges	169
3.3.7.14	Received New Remote Log Name	170
3.3.7.15	Begin Remote LU Initiated Synchronization	170
3.3.7.16	Begin Local LU Initiated Synchronization	170
3.3.7.17	Synchronization Successful	171
3.3.7.18	Synchronization Inconsistent	171
3.3.7.19	Received LU Status	172
3.3.7.20	Local LU Initiated Recovery Worker Ended	172
3.3.7.21	Synchronization Connection Down	173
3.3.7.22	Remote LU Initiated Recovery Ended	173
3.3.7.23	Recovery Down	174
3.3.7.24	LUW Conversation Lost	174
4	Protocol Examples	175
4.1	LU Name Pair Configuration Scenario	175
4.1.1	Configuring an LU Name Pair	175
4.1.2	Deleting an LU Name Pair	176
4.2	Registering as the Recovery Process for an LU Name Pair Scenario	178
4.2.1	Registering the Recovery Process	178
4.2.2	Unregistering the Recovery Process	180
4.3	Performing Cold Recovery for an LU Name Pair Scenario	180
4.3.1	Performing Cold Recovery	180
4.4	Enlisting in an OleTx Transaction as an LU 6.2 Implementation Scenario	183
4.4.1	Enlisting an LUW on an OleTx Transaction	184
4.4.2	Participating in Two Phase Commit	186
4.5	Performing Warm Recovery for an LU Name Pair Scenario	188
4.5.1	Performing Warm Recovery	188
5	Security	194
5.1	Security Considerations for Implementers	194
6	(Updated Section) Appendix A: Product Behavior	195
7	Change Tracking	197
8	Index	198

1 (Updated Section) Introduction

The MSDTC Connection Manager: OleTx Transaction Protocol Logical Unit Mainframe Extension (DTCLU) provides transaction processing support to implementations of Logical Unit type 6.2 (LU 6.2). This extension is used between an implementation of LU 6.2 and a transaction manager. The DTCLU extension enables integration of a LU 6.2-based transaction participant into an OleTx transaction, and vice-versa. DTCLU extends the ~~transaction protocol described in~~ OleTx Transaction Protocol [MS-DTCO] with helper messages and abstract state, such as additional mechanisms for identifying a transaction, or support for recovery that does not use the presumed-abort two-phase-commit variant.

Sections 1.5, 1.8, 1.9, 2, and 3 of this specification are normative. All other sections and examples in this specification are informative.

1.1 Glossary

This document uses the following terms:

active phase: The time during the lifetime of an atomic transaction before the commit request when the participants in the transaction (applications and resource managers) perform all their intended work operations inside the transaction.

application: A participant that is responsible for beginning, propagating, and completing an atomic transaction. An application communicates with a transaction manager in order to begin and complete transactions. An application communicates with a transaction manager in order to marshal transactions to and from other applications. An application also communicates in application-specific ways with a resource manager in order to submit requests for work on resources.

atomic transaction: A shared activity that provides mechanisms for achieving the atomicity, consistency, isolation, and durability (ACID) properties when state changes occur inside participating resource managers.

cold recovery: Initial recovery work performed by a transaction manager for a LU 6.2 implementation with respect to a specific LU Name Pair.

cold XLN: The Exchange Log Name messages that are exchanged during cold recovery.

Compare States: In LU 6.2, Compare States messages are sent from one logical unit (LU) to another to convey information about the state of a logical unit of work. For a more complete definition, see [SNAFormat].

connection: In OleTx, an ordered set of logically related messages. The relationship between the messages is defined by the higher-layer protocol, but they are guaranteed to be delivered exactly one time and in order relative to other messages in the connection.

connection type: A specific set of interactions between participants in an OleTx protocol that accomplishes a specific set of state changes. A connection type consists of a bidirectional sequence of messages that are conveyed by using the MSDTC Connection Manager: OleTx Transports Protocol and the MSDTC Connection Manager: OleTx Multiplexing Protocol transport protocol, as described in [MS-CMPO] and [MS-CMP]. A specified transaction typically involves many different connection types during its lifetime.

conversation: In LU 6.2, conversations connect transaction programs, and are used by the transaction programs to transfer messages. For a more complete definition, see [LU62Peer].

DTCLU: MSDTC Connection Manager: OleTx Transaction Protocol Logical Unit Mainframe Extension, as specified in [MS-DTCLU].

enlistment: The relationship between a participant and a transaction manager in an atomic transaction. The term typically refers to the relationship between a resource manager and its transaction manager, or between a subordinate transaction manager facet and its superior transaction manager facet.

Exchange Log Name (XLN): In LU 6.2, Exchange Log Name messages are sent from one LU to another to convey information about the state of a log, such as log names and log status. For a more complete definition, see [SNAFormat].

globally unique identifier (GUID): A term used interchangeably with universally unique identifier (UUID) in Microsoft protocol technical documents (TDs). Interchanging the usage of these terms does not imply or require a specific algorithm or mechanism to generate the value. Specifically, the use of this term does not imply or require that the algorithms described in [RFC4122] or [C706] must be used for generating the GUID. See also universally unique identifier (UUID).

heuristic abort outcome: An outcome of an atomic transaction that indicates that a transaction manager has autonomously made an Abort Outcome decision. For a more complete definition, see [LU62SPS].

heuristic commit outcome: An outcome of an atomic transaction that indicates that a transaction manager has autonomously made a Commit Outcome decision. For a more complete definition, see [LU62SPS].

heuristic mixed outcome: An outcome of an atomic transaction that indicates that a participant has autonomously decided the outcome, and the decision is not consistent with the outcome decision made by other participants. For a more complete definition, see [LU62SPS].

In Doubt outcome: One of the outcomes of an atomic transaction. The In Doubt outcome indicates that a commit request was issued by the root application but that the transaction manager cannot ascertain the actual commit or abort decision.

local log name: A log name that identifies a log held by a local LU.

local LU: An LU 6.2 implementation ([MS-DTCLU] section 3.2) that uses the MSDTC Connection Manager: OleTx Transaction Protocol Logical Unit Mainframe Extension protocol [MS-DTCLU] to communicate with a transaction manager.

log: A durable store used to maintain transaction state.

log status: In LU 6.2, the status of a log can be either Cold or Warm. A log whose status is Cold contains no transaction state. A log whose status is Warm can contain transaction state.

Log Status Cold: A log status value of Cold.

Log Status Warm: A log status of Warm.

logical unit (LU): An addressable network element in the Systems Network Architecture that serves as an access point to the network for programs and users, allowing them to access resources and communicate with other programs and users. For more information on logical units, see [SNA].

logical unit of work (LUW): In LU 6.2, the transaction programs divide the distributed transaction into logical units of work, delimited by Sync Points, to which all participants attempt to synchronize their state. For a more complete definition, see [LU62Peer].

LU Name Pair: An identifier that uniquely specifies the pairing of a local LU and a remote LU.

LU Type 6.2 (LU 6.2): A type of logical unit designed to provide support for two or more distributed application programs cooperating to carry out some work. All communication provided by LU 6.2 is program-to-program. For more information, see [LU62Peer].

LUW identifier: An identifier for a logical unit of work.

message tag (MTAG): A message that is sent between participants in the context of connections.

outcome: One of the three possible results (Commit, Abort, In Doubt) reachable at the end of a life cycle for an atomic transaction.

participant: Any of the parties that are involved in an atomic transaction and that have a stake in the operations that are performed under the transaction or in the outcome of the transaction ([WSAT10], [WSAT11]).

Phase One: The initial phase of a two-phase commit sequence. During this phase, the participants in the transaction are requested to prepare to be committed. This phase is also known as the "Prepare" phase. At the end of Phase One, the outcome of the transaction is known.

Phase Two: The second phase of a two-phase commit sequence. This phase occurs after the decision to commit or abort is determined. During this phase, the participants in the transaction are ordered to either commit or rollback.

recovery: The process of reestablishing connectivity and synchronizing views on the outcome of transactions between two participants after a transient failure. Recovery occurs either between a resource manager and a transaction manager, or between a Superior Transaction Manager Facet and a Subordinate Transaction Manager Facet.

recovery sequence number: A sequence number used to demarcate sequences of recovery protocol messages to make it possible to detect obsolete recovery protocol messages.

remote log name: A log name that identifies a log held by a remote LU.

remote LU: An LU 6.2 Implementation ([MS-DTCLU] section 3.2) that communicates with the local LU, but without making use of the protocol specified in [MS-DTCLU].

resource manager (RM): The participant that is responsible for coordinating the state of a resource with the outcome of atomic transactions. For a specified transaction, a resource manager enlists with exactly one transaction manager to vote on that transaction outcome and to obtain the final outcome. A resource manager is either durable or volatile, depending on its resource.

session: In OleTx, a transport-level connection between a Transaction Manager and another Distributed Transaction participant over which multiplexed logical connections and messages flow. A session remains active so long as there are logical connections using it.

subordinate transaction manager: A role taken by a transaction manager that is responsible for voting on the outcome of an atomic transaction. A subordinate transaction manager coordinates the voting and notification of its subordinate participants on behalf of its superior transaction manager. When communicating with those subordinate participants, the subordinate transaction manager acts in the role of superior transaction manager. The root transaction manager is never a subordinate transaction manager. A subordinate transaction manager has exactly one superior transaction manager.

superior transaction manager: A role taken by a transaction manager that is responsible for gathering outcome votes and providing the final transaction outcome. A root transaction manager can act as a superior transaction manager to a number of subordinate transaction managers. A transaction manager can act as both a subordinate transaction manager and a superior transaction manager on the same transaction.

Sync Point Processing: In LU 6.2, a distributed error recovery function that allows transaction programs to coordinate error recovery and maintain consistency between distributed resources. For a more complete definition, see [SNA].

Sync Point Services (SPS): In LU 6.2, the component of the LU that provides support for sync points. For a description of the Sync Point Services architecture, see [LU62SPS].

transaction: In OleTx, an atomic transaction.

transaction identifier: The GUID that uniquely identifies an atomic transaction.

transaction manager: The party that is responsible for managing and distributing the outcome of atomic transactions. A transaction manager is either a root transaction manager or a subordinate transaction manager for a specified transaction.

transaction program: In Systems Network Architecture, it is a program that is the direct user of an LU 6.2, or it is executed within an LU 6.2. For a more complete definition, see [LU62Verb] and [LU62Peer].

transient failure: Any event that could result in a loss of transport connectivity between participants, such as a software crash, a software restart, or a temporary problem with network connections.

two-phase commit: An agreement protocol that is used to resolve the outcome of an atomic transaction in response to a commit request from the root application. Phase One and Phase Two are the distinct phases of the Two-Phase Commit Protocol.

warm recovery: Subsequent recovery work performed by a transaction manager for a LU 6.2 implementation with respect to a specific LU Name Pair. (See cold recovery).

Warm XLN: The Exchange Log Name messages that are exchanged during warm recovery.

work: The set of state changes that are applied to resources inside an atomic transaction.

MAY, SHOULD, MUST, SHOULD NOT, MUST NOT: These terms (in all caps) are used as defined in [RFC2119]. All statements of optional behavior use either MAY, SHOULD, or SHOULD NOT.

1.2 References

Links to a document in the Microsoft Open Specifications library point to the correct section in the most recently published version of the referenced document. However, because individual documents in the library are not updated at the same time, the section numbers in the documents may not match. You can confirm the correct section numbering by checking the Errata.

1.2.1 Normative References

We conduct frequent surveys of the normative references to assure their continued availability. If you have any issue with finding a normative reference, please contact dochelp@microsoft.com. We will assist you in finding the relevant information.

[LU62Peer] IBM Corporation, "SNA LU 6.2 Peer Protocols SC31-6808-02", October 1996,
<http://www.elink.ibmmlink.ibm.com/publications/servlet/pbi.wss?CTY=US&FNC=SRX&PBL=SC31-6808-02>

[LU62SPS] IBM Corporation, "SNA Sync Point Services Architecture References SC31-8134-00", August 1994,
<http://www.elink.ibmmlink.ibm.com/public/applications/publications/cgibin/pbi.cgi?CTY=US&FNC=SRX&PBL=SC31-8134-00>

[LU62Verb] IBM Corporation, "SNA Transaction Programmer's Reference Manual for LU Type 6.2 GC30-3084-05", November 1993,
<http://www.elink.ibmmlink.ibm.com/public/applications/publications/cgibin/pbi.cgi?CTY=US&FNC=SRX&PBL=GC30-3084-05>

[MS-CMPO] Microsoft Corporation, "MSDTC Connection Manager: OleTx Transports Protocol".

[MS-CMP] Microsoft Corporation, "MSDTC Connection Manager: OleTx Multiplexing Protocol".

[MS-DTCO] Microsoft Corporation, "MSDTC Connection Manager: OleTx Transaction Protocol".

[RFC2119] Bradner, S., "Key words for use in RFCs to Indicate Requirement Levels", BCP 14, RFC 2119, March 1997, <http://www.rfc-editor.org/rfc/rfc2119.txt>

1.2.2 Informative References

None.

1.3 (Updated Section) Overview

The MSDTC Connection Manager: OleTx Transaction Protocol Logical Unit Mainframe Extension provides transactional support to implementations of Logical Unit type 6.2 (LU 6.2). The protocol (DTCLU) is used between an implementation of Logical Unit type 6.2 (LU 6.2) and a transaction manager to provide transaction support. It enables integration of a LU 6.2-based transaction participant into an OleTx transaction, and vice-versa. DTCLU extends the transaction protocol described in OleTx Transaction Protocol [MS-DTCO+] with helper messages and abstract state, such as additional mechanisms for identifying a transaction, or support for recovery that does not use the presumed-abort two-phase-commit variant.

An LU 6.2 implementation can use the protocol extension to delegate many of its responsibilities for the transactional features of each logical unit of work (LUW) to a transaction manager. This reduces the amount of work necessary to implement LU 6.2. A transaction manager that implements this protocol extension provides two main areas of support. First, it supports the enlistment of an LUW in, and its completion as part of, an atomic transaction. Second, it supports recovery after a transient failure that affects connectivity between a local LU and a remote LU, or between the local LU and a transaction manager.

The scenarios and roles are described in the following sections as follows:

- The scenarios that this protocol is intended to support such as enlistment, completion, and transaction recovery.
- The distinct roles, additional to those described in [MS-DTCO], transaction roles that are played by participants in these scenarios. in addition to those described in [MS-DTCO].

1.3.1 Scenarios

The following diagram shows some of the components involved in typical usage scenarios for the MSDTC Connection Manager: OleTx Transaction Protocol Logical Unit Mainframe Extension.

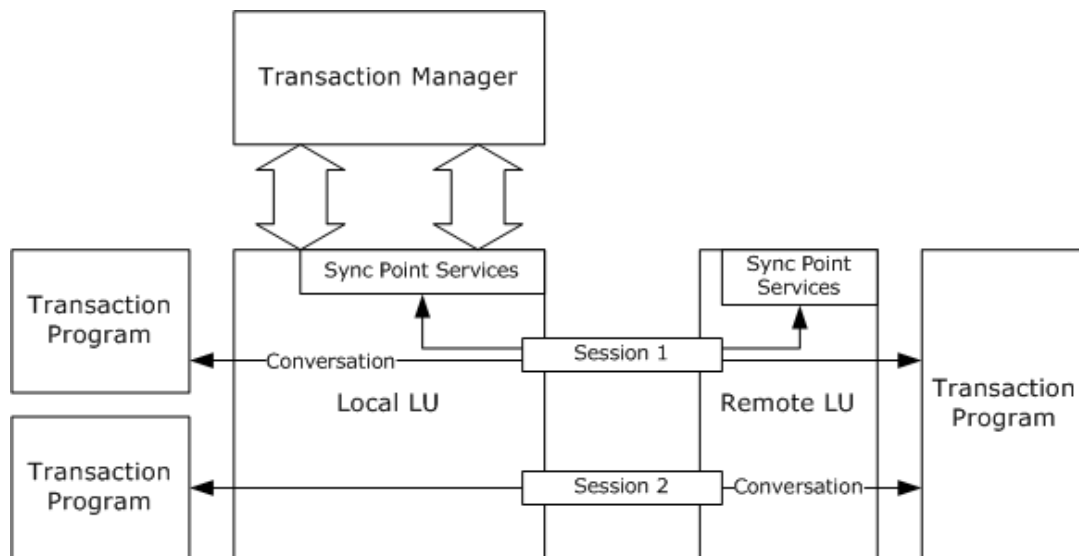

Figure 1: Components typically used for this protocol

The following sections illustrate the interactions that take place between these components in a common scenario drawn from each of the two main areas of support provided to LU 6.2 Implementations by this protocol.

1.3.1.1 Enlistment and Completion

The following sequence diagram is a schematic of the interactions that take place between a transaction program, a local LU, a transaction manager, and a remote LU when a logical unit of work is enlisted on a transaction and the transaction is completed.

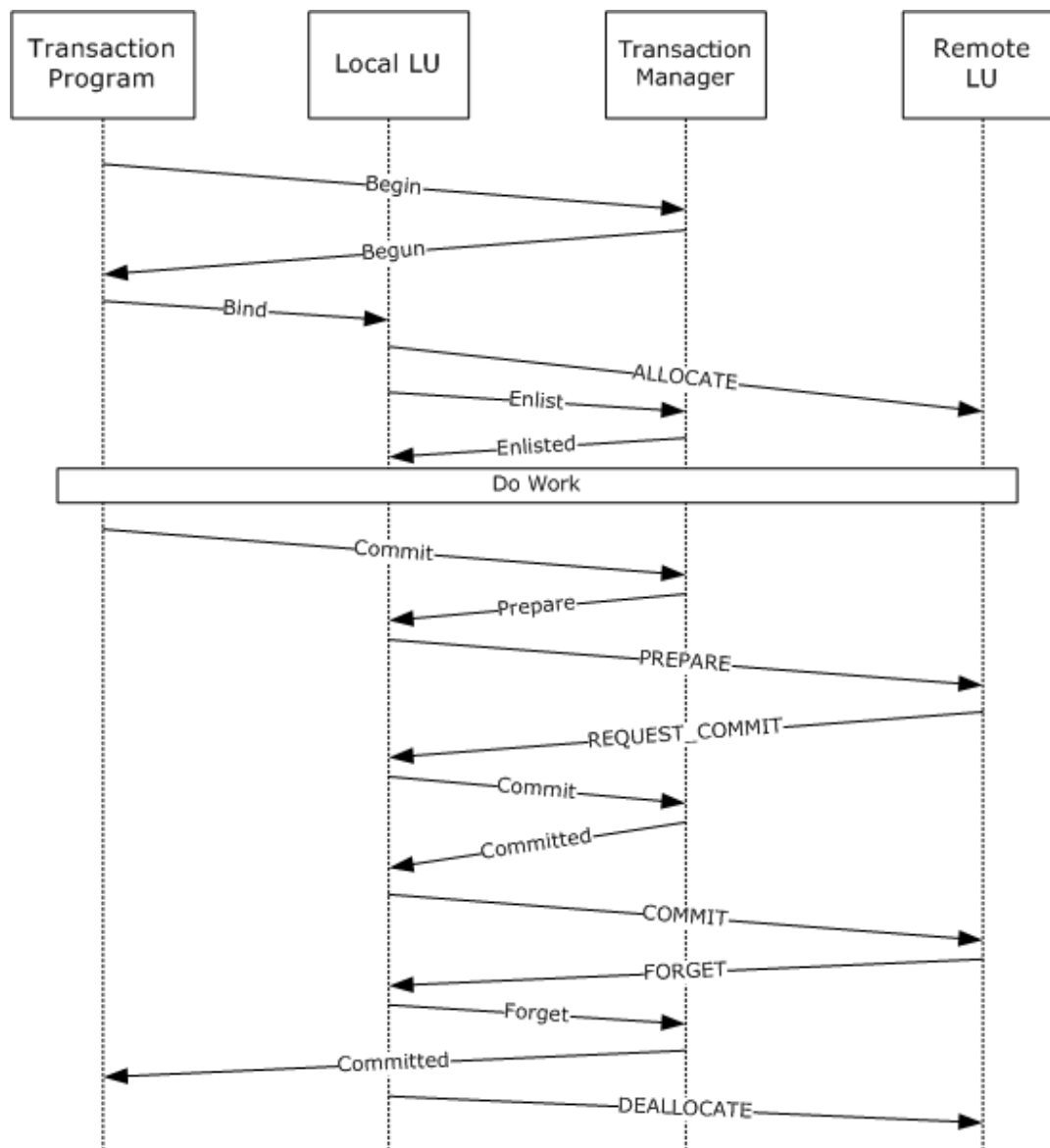

Figure 2: MS-DTCLU enlistment

All the exchanges depicted are notional, and are not intended to provide an accurate representation of any concrete protocol. The protocols involved are specified as follows:

- The protocol between the local LU and the transaction manager is specified in sections 1.3.2.2.1 and 3.3.
- The protocol between the transaction program and the transaction manager is specified in [MS-DTCO]. The transaction program plays the role of application, as specified in that document.
- The protocol between the local LU and the remote LU is specified in [LU62Peer].
- The protocol between the transaction program and the local LU is specified in [LU62Verb].

The general pattern is that of the Two-Phase Commit protocol described in [MS-DTCO]. A major difference is that the transaction manager does not communicate directly with all the participants in

the transaction. Specifically, work performed by a transaction program that uses the remote LU is coordinated only indirectly, via the protocol between the local LU and the remote LU.

Note that the protocol specified in this document is applicable only where the local LU initiates the logical unit of work.

Note also that although the role played by the local LU is broadly similar to a resource manager, it does not correspond exactly with any of the roles specified by [MS-DTCO]. Consequently, this document specifies an additional role, LU 6.2 Implementation, in section 1.3.2.1.

1.3.1.2 Transaction Recovery

The atomicity property of a transaction guarantees that all participants in the transaction receive the same outcome. To honor this guarantee, transaction managers have to be capable of recovering from transient failures.

After a transient failure, the transaction manager re-establishes connectivity with the local LU, if the connection with the local LU is lost, and participates in the re-establishment of consistent state at the local and remote LUs.

The following sequence diagram is a schematic of the interactions that take place between Sync Point Services (SPS) in a remote LU, a local LU, SPS in a local LU, and a transaction program during recovery initiated by a remote LU.

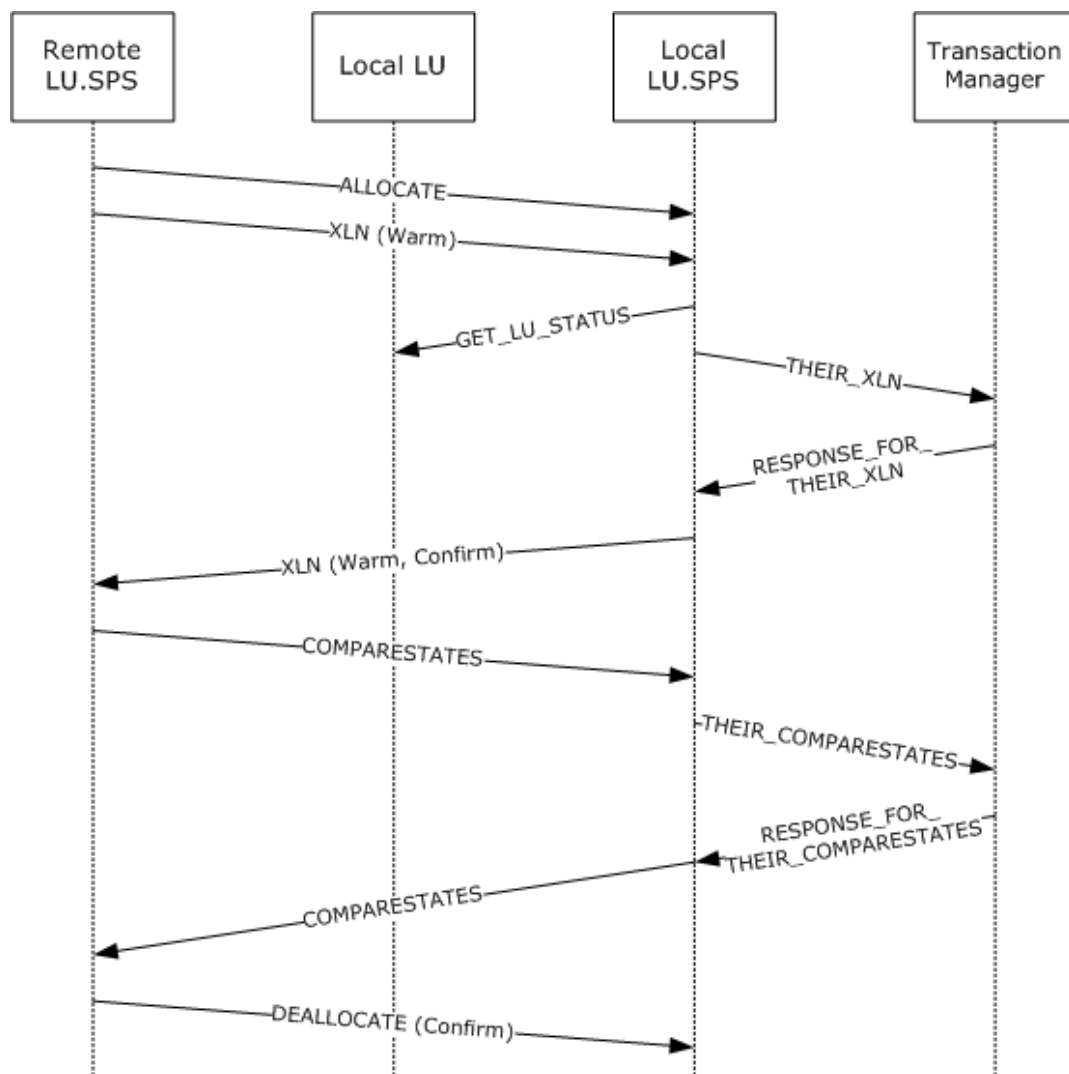

Figure 3: MS-DTCLU recovery

All the exchanges depicted are notional, and are not intended to provide an accurate representation of any concrete protocol. The protocols involved are specified as follows:

- The protocol between Local LU.SPS and the transaction manager is specified in sections 1.3.2.2.1 and 3.3.
- The protocol between the Local LU.SPS and the Remote LU.SPS is specified in [LU62SPS].

The intent of these interactions is similar to that of the recovery protocol between a subordinate transaction manager and a superior transaction manager as specified in [MS-DTCO]. However, the role played by Local LU.SPS does not correspond exactly with any of the roles as specified in [MS-DTCO]. Consequently, this document specifies an additional role, LU 6.2 Implementation, in section 1.3.2.1.

1.3.2 Transaction Roles

This protocol specifies an additional role, the LU 6.2 Implementation, and extends the transaction manager role as specified in [MS-DTCO]. These roles are described in the following sections.

1.3.2.1 LU 6.2 Implementation Role

The LU 6.2 Implementation role is performed by an implementation of LU 6.2, and is typically responsible for performing the following tasks:

- Managing LU Name Pair.
- Enlisting a logical unit of work on an existing transaction as a Phase One and Phase Two participant.
- Participating in a Two-Phase Commit coordinated by a transaction manager, and mapping to and from the related LU 6.2 protocol.
- Participating in recovery initiated by a transaction manager.
- Notifying a transaction manager of recovery initiated by a remote LU, and participating in that process.

1.3.2.2 Transaction Manager Role

This document specifies the following facet, in addition to those specified in [MS-DTCO].

1.3.2.2.1 Transaction Manager Communicating with an LU 6.2 Implementation Facet

The Transaction Manager Communicating with an LU 6.2 Implementation Facet provides the following services to an LU 6.2 Implementation:

- Enlistment of a logical unit of work on a transaction as a Phase One participant.
- Phase One and Phase Two notifications inside the Two-Phase Commit Protocol.
- LU Name Pair management.
- Registration of a recovery process for an LU 6.2 Implementation.
- Recovery and outcome notification for logical units of work enlisted on a transaction.

1.4 Relationship to Other Protocols

This protocol extends the protocol specified in [MS-DTCO]. The following diagram illustrates the protocol layering for this protocol.

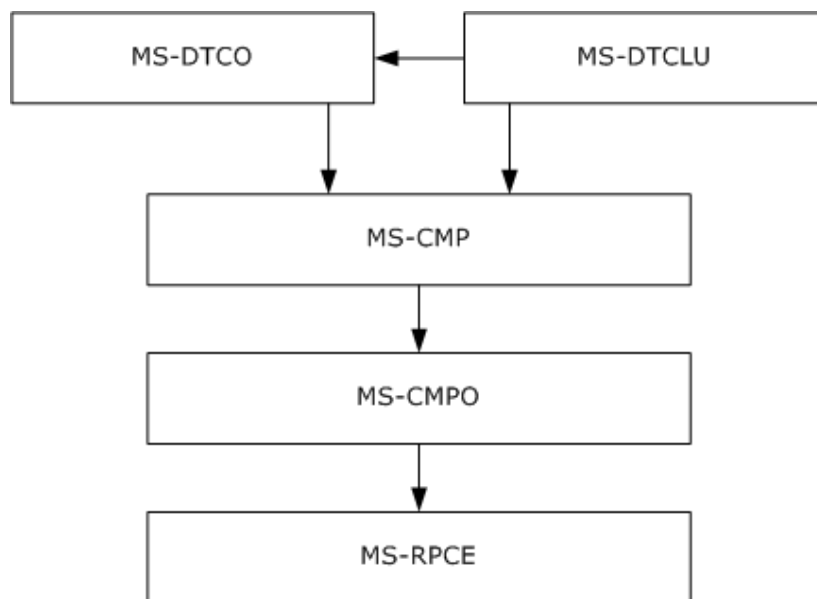

Figure 4: Protocol layering for MS-DTCLU

1.5 Prerequisites/Preconditions

This protocol requires that all participating roles possess implementations of the transports protocol specified in [MS-CMPO] and the multiplexing protocol specified in [MS-CMP]. This protocol also requires that an implementation of the transaction protocol specified in [MS-DTCO] is accessible using the protocols specified in [MS-CMPO] and [MS-CMP].

1.6 Applicability Statement

This protocol applies to scenarios where an LU 6.2 implementation (section 3.2) provides support for Sync Point Processing, and an implementation of the protocol described in [MS-DTCO] is available. It supports the coordination of LU 6.2 logical units of work with atomic transactions, and recovery from transient failure.

This protocol requires network topologies where the transports protocol described [MS-CMPO] and the multiplexing protocol described in [MS-CMP] constitute a viable network transport for establishing many short-lived connection exchanges that accomplish specific tasks.

1.7 Versioning and Capability Negotiation

This section specifies the versioning and capability aspects of this protocol.

The protocol specified in this document is not version-specific, and its capabilities are not negotiable.

This protocol supports Logical Unit type 6.2 (LU 6.2) and requires that the external entities comply with LU 6.2 as specified in [LU62Peer], [LU62Verb], and [LU62SPS].

1.8 Vendor-Extensible Fields

None.

1.9 Standards Assignments

None.

2 Messages

2.1 Transport

An implementation of this protocol uses the transport infrastructure provided by the underlying implementation of the transaction protocol specified in [MS-DTCO]. Because this protocol uses the transport infrastructure provided by the transaction protocol, the set of requirements specified in [MS-DTCO] section 2.1 MUST also apply to this protocol.

2.2 Message Syntax

2.2.1 Common Structures

2.2.1.1 MESSAGE_PACKET

The MESSAGE_PACKET structure defines the initial message fields that are contained by all message tags (MTAGs) in this protocol, as specified in [MS-CMP] section 2.2.2.

0	1	2	3	4	5	6	7	8	9	10	11	12	13	14	15	16	17	18	19	20	21	22	23	24	25	26	27	28	29	30	31
MsgTag																															
fIsMaster																															
dwConnectionId																															
dwUserMsgType																															
dwcbVarLenData																															
dwReserved1																															

MsgTag (4 bytes): A 4-byte integer value that describes the OLE transaction message type. For all uses in this document, this value MUST be MTAG_USER_MESSAGE, as specified in [MS-CMP] section 2.2.8.

fIsMaster (4 bytes): The value that indicates the direction of the message in the conversation.

This value MUST be one of the following values.

Value	Meaning
0x00000000	The message is sent by the party that accepted the connection.
0x00000001	The message is sent by the party that initiated the connection.

dwConnectionId (4 bytes): An integer value that MUST contain the unique identifier for the associated connection.

dwUserMsgType (4 bytes): This field contains the message type identifier. Each MTAG that is defined in this section MUST specify a distinct value for this field for a specified connection type.

dwcbVarLenData (4 bytes): An unsigned integer value that MUST contain the size, in bytes, of the message buffer that contains the MESSAGE_PACKET structure, minus the size, in bytes, of the MESSAGE_PACKET structure itself.

dwReserved1 (4 bytes): Reserved. This value MUST be set to an implementation-specific value <1> and MUST be ignored on receipt.

2.2.1.2 DTCLU_VARLEN_BYTEARRAY

The DTCLU_VARLEN_BYTEARRAY structure is used to represent a variable-length byte array.

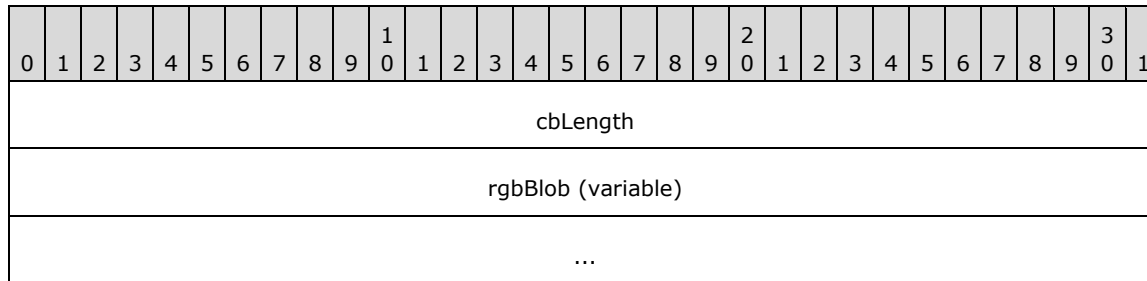

cbLength (4 bytes): A 32-bit unsigned integer that MUST contain the number of bytes in the **rgbBlob** field.

rgbBlob (variable): This field contains the byte array. The number of bytes in this field MUST be equal to the value of **cbLength**. If **cbLength** is 0, this field MUST NOT be present.

2.2.2 Transaction Enumerations

2.2.2.1 DTCLUCOMPARESTATE

The **DTCLUCOMPARESTATE** enumeration defines the status values for a logical unit of work.

```
typedef enum
{
    DTCLUCOMPARESTATE_COMMITTED = 1,
    DTCLUCOMPARESTATE_HEURISTICCOMMITTED = 2,
    DTCLUCOMPARESTATE_HEURISTICMIXED = 3,
    DTCLUCOMPARESTATE_HEURISTICRESET = 4,
    DTCLUCOMPARESTATE_INDOUBT = 5,
    DTCLUCOMPARESTATE_RESET = 6
} DTCLUCOMPARESTATE;
```

DTCLUCOMPARESTATE_COMMITTED: The outcome of a transaction is a commit outcome.

DTCLUCOMPARESTATE_HEURISTICCOMMITTED: The outcome of a transaction is a heuristic commit outcome.

DTCLUCOMPARESTATE_HEURISTICMIXED: The outcome of a transaction is a heuristic mixed outcome.

DTCLUCOMPARESTATE_HEURISTICRESET: The outcome of a transaction is a heuristic abort outcome.

DTCLUCOMPARESTATE_INDOUBT: The outcome of a transaction is an in doubt outcome.

DTCLUCOMPARESTATE_RESET: The outcome of a transaction is an abort outcome.

2.2.2.2 DTCLUCOMPARESTATESCONFIRMATION

The **DTCLUCOMPARESTATESCONFIRMATION** enumeration defines the completion status values for a comparison of the LUW state between a local LU and a remote LU during recovery.

```
typedef enum
{
    DTCLUCOMPARESTATESCONFIRMATION_CONFIRM = 1,
    DTCLUCOMPARESTATESCONFIRMATION_PROTOCOL = 2
} DTCLUCOMPARESTATESCONFIRMATION;
```

DTCLUCOMPARESTATESCONFIRMATION_CONFIRM: The LUW state supplied by a remote LU matches the local LU LUW state held by a transaction manager and recovery is complete.

DTCLUCOMPARESTATESCONFIRMATION_PROTOCOL: The LUW state supplied by a remote LU does not match the local LU LUW state held by a transaction manager.

2.2.2.3 DTCLUCOMPARESTATESERROR

The **DTCLUCOMPARESTATESERROR** enumeration defines the error status values for a comparison of the state of an LUW between a local LU and a remote LU during recovery.

```
typedef enum
{
    DTCLUCOMPARESTATESERROR_PROTOCOL = 1
} DTCLUCOMPARESTATESERROR;
```

DTCLUCOMPARESTATESERROR_PROTOCOL: A protocol error occurred.

2.2.2.4 DTCLUXLN

The **DTCLUXLN** enumeration defines the log status values used in an exchange of state information between a remote LU and a local LU.

```
typedef enum
{
    DTCLUXLN_COLD = 1,
    DTCLUXLN_WARM = 2
} DTCLUXLN;
```

DTCLUXLN_COLD: The log status of an LU is Log Status Cold.

DTCLUXLN_WARM: The log status of an LU is Log Status Warm.

2.2.2.5 DTCLUXLNCONFIRMATION

The **DTCLUXLNCONFIRMATION** enumeration defines the completion status values for an exchange of Exchange Log Name (XLN) messages with a remote LU.

```
typedef enum
{
    DTCLUXLNCONFIRMATION_CONFIRM = 1,
    DTCLUXLNCONFIRMATION_LOGNAMEMISMATCH = 2,
    DTCLUXLNCONFIRMATION_COLDWARMISMATCH = 3,
    DTCLUXLNCONFIRMATION_OBSOLETE = 4
} DTCLUXLNCONFIRMATION;
```

DTCLUXLNCONFIRMATION_CONFIRM: No inconsistencies were detected between the remote LU state and the local LU state held by a transaction manager.

DTCLUXLNCONFIRMATION_LOGNAMEMISMATCH: The remote log name supplied by the remote LU does not match the remote log name at the local LU held by a transaction manager.

DTCLUXLNCONFIRMATION_COLDWARMISMATCH: The log status of the remote LU (as supplied by the remote LU) is Log Status Cold, and the log status of the local LU held by a transaction manager is Log Status Warm.

DTCLUXLNCONFIRMATION_OBSOLETE: The exchange of XLNs has been invalidated, for example, because the recovery sequence number has been incremented since the exchange began.

2.2.2.6 DTCLUXLNERROR

The **DTCLUXLNERROR** enumeration defines the error status values for an exchange of XLN messages with a remote LU.

```
typedef enum
{
    DTCLUXLNERROR_PROTOCOL = 1,
    DTCLUXLNERROR_LOGNAMEMISMATCH = 2,
    DTCLUXLNERROR_COLDWARMISMATCH = 3
} DTCLUXLNERROR;
```

DTCLUXLNERROR_PROTOCOL: A protocol error occurred.

DTCLUXLNERROR_LOGNAMEMISMATCH: The local log name supplied by a remote LU does not match the local log name at the local LU held by a transaction manager, or the remote log name supplied by a remote LU does not match the remote log name at the local LU held by a transaction manager.

DTCLUXLNERROR_COLDWARMISMATCH: The log status of the remote LU supplied by a remote LU is Log Status Cold, and the log status of the local LU held by a transaction manager is Log Status Warm; or the log status of the remote LU supplied by a remote LU is Log Status Warm, and the log status of the local LU held by a transaction manager is Log Status Cold.

2.2.2.7 DTCLUCOMPARESTATESRESPONSE

The **DTCLUCOMPARESTATESRESPONSE** enumeration defines the completion status of an exchange of LUW state information between a local LU and a remote LU during recovery.

```
typedef enum
{
    DTCLUCOMPARESTATESRESPONSE_OK = 1,
    DTCLUCOMPARESTATESRESPONSE_PROTOCOL = 2
} DTCLUCOMPARESTATESRESPONSE;
```

DTCLUCOMPARESTATESRESPONSE_OK: The LUW state supplied by a remote LU matches the LUW state held for a local LU by a transaction manager.

DTCLUCOMPARESTATESRESPONSE_PROTOCOL: The LUW state supplied by a remote LU does not match the LUW state held for a local LU by a transaction manager.

2.2.2.8 DTCLUXLNRESPONSE

The **DTCLUXLNRESPONSE** enumeration defines the completion status of an exchange of XLN messages with a remote LU.

```
typedef enum
{
    DTCLUXLNRESPONSE_OK_SENDOURXLNBACK = 1,
    DTCLUXLNRESPONSE_OK_SENDCONFIRMATION = 2,
    DTCLUXLNRESPONSE_LOGNAMEMISMATCH = 3,
    DTCLUXLNRESPONSE_COLDWARMISMATCH = 4
} DTCLUXLNRESPONSE;
```

DTCLUXLNRESPONSE_OK_SENDOURXLNBACK: No inconsistencies were detected between the remote LU state and the local LU state held by the transaction manager, and the remote LU has not supplied the local log name.

DTCLUXLNRESPONSE_OK_SENDCONFIRMATION: No inconsistencies were detected between the remote LU state and the local LU state held by the transaction manager.

DTCLUXLNRESPONSE_LOGNAMEMISMATCH: The remote log name supplied by the remote LU does not match the remote log name at the local LU held by the transaction manager; or the local log name supplied by the remote LU does not match the local log name held by the transaction manager.

DTCLUXLNRESPONSE_COLDWARMISMATCH: The remote LU's log status supplied by the remote LU is Log Status Cold, and the local LU's log status held by the transaction manager is Log Status Warm.

2.2.2.9 CONNTYPE

The **CONNTYPE** enumeration defines the connection types that are used by this protocol.

```
typedef enum
{
    CONNTYPE_TXUSER_DTCLURMENLISTMENT = 0x00000016,
    CONNTYPE_TXUSER_DTCLUCONFIGURE = 0x00000018,
    CONNTYPE_TXUSER_DTCLURECOVERY = 0x00000019,
    CONNTYPE_TXUSER_DTCLURECOVERYINITIATEDBYDTC = 0x00000020,
    CONNTYPE_TXUSER_DTCLURECOVERYINITIATEDBYLU = 0x00000021
} CONNTYPE;
```

CONNTYPE_TXUSER_DTCLURMENLISTMENT: This connection type is used by an LU 6.2 implementation to establish a subordinate enlistment with a transaction manager.

CONNTYPE_TXUSER_DTCLUCONFIGURE: This connection type is used to manage a set of LU Name Pairs held by a transaction manager.

CONNTYPE_TXUSER_DTCLURECOVERY: This connection type is used by an LU 6.2 implementation to register as a recovery process with a transaction manager.

CONNTYPE_TXUSER_DTCLURECOVERYINITIATEDBYDTC: This connection type is used to request LU 6.2 work from a transaction manager.

CONNTYPE_TXUSER_DTCLURECOVERYINITIATEDBYLU: This connection type is used for LU 6.2 recovery initiated by an LU 6.2 implementation.

2.2.3 Connection Types Relevant to LU 6.2

2.2.3.1 CONNTYPE_TXUSER_DTCLUCONFIGURE

The **CONNTYPE_TXUSER_DTCLUCONFIGURE** connection type is used to manage a set of LU Name Pairs held by a transaction manager.

The use of **CONNTYPE_TXUSER_DTCLUCONFIGURE** as an initiator is specified in section 3.2.5.1, and as an acceptor is specified in section 3.3.5.1.

2.2.3.1.1 TXUSER_DTCLURMCONFIGURE_MTAG_ADD

The TXUSER_DTCLURMCONFIGURE_MTAG_ADD message is sent by an LU 6.2 implementation (section 3.2) to request the addition of an LU Name Pair to the set of LU Name Pairs held by a transaction manager.

0	1	2	3	4	5	6	7	8	9	10	11	12	13	14	15	16	17	18	19	20	21	22	23	24	25	26	27	28	29	30	31
MsgHeader (24 bytes)																															
...																															
...																															
LuNamePair (variable)																															
...																															

MsgHeader (24 bytes): This field MUST contain a MESSAGE_PACKET structure.

- The value of the **dwUserMsgType** field MUST be 0x00004201.
- The value of the **dwcbVarLenData** field MUST be at least 4.

LuNamePair (variable): This field MUST contain a DTCLU_VARLEN_BYTEARRAY structure that identifies an LU Name Pair. If **cbLength** is not a multiple of 4, the end of the field MUST be aligned on a 4-byte boundary by padding with arbitrary values that MUST be ignored on receipt.

2.2.3.1.2 TXUSER_DTCLURMCONFIGURE_MTAG_DELETE

The TXUSER_DTCLURMCONFIGURE_MTAG_DELETE message is sent by an LU 6.2 implementation (section 3.2) to request the deletion of an LU Name Pair from the set of LU Name Pairs held by a transaction manager.

0	1	2	3	4	5	6	7	8	9	10	11	12	13	14	15	16	17	18	19	20	21	22	23	24	25	26	27	28	29	30	31
MsgHeader (24 bytes)																															
...																															
...																															

LuNamePair (variable)
...

MsgHeader (24 bytes): This field MUST contain a MESSAGE_PACKET structure.

- The value of the **dwUserMsgType** field MUST be 0x00004202.
- The value of the **dwcbVarLenData** field MUST be at least 4.

LuNamePair (variable): This field MUST contain a DTCLU_VARLEN_BYTEARRAY structure that identifies an LU Name Pair. If **cbLength** is not a multiple of 4, the end of the field MUST be aligned on a 4-byte boundary by padding with arbitrary values that MUST be ignored on receipt.

2.2.3.1.3 TXUSER_DTCLURMCONFIGURE_MTAG_REQUEST_COMPLETED

The TXUSER_DTCLURMCONFIGURE_MTAG_REQUEST_COMPLETED message is sent by a transaction manager to indicate that an LU Name Pair has been successfully added to or removed from a set of LU Name Pairs held by a transaction manager.

0	1	2	3	4	5	6	7	8	9	10	11	12	13	14	15	16	17	18	19	20	21	22	23	24	25	26	27	28	29	30	31
MsgHeader (24 bytes)																															
...																															
...																															

MsgHeader (24 bytes): This field MUST contain a MESSAGE_PACKET structure.

- The value of the **dwUserMsgType** field MUST be 0x00004203.
- The value of the **dwcbVarLenData** field MUST be 0.

2.2.3.1.4 TXUSER_DTCLURMCONFIGURE_MTAG_ADD_DUPLICATE

The TXUSER_DTCLURMCONFIGURE_MTAG_ADD_DUPLICATE message is sent by a transaction manager to indicate that an LU Name Pair is already a member of the set of LU Name Pairs held by a transaction manager, and therefore cannot be added.

0	1	2	3	4	5	6	7	8	9	10	11	12	13	14	15	16	17	18	19	20	21	22	23	24	25	26	27	28	29	30	31
MsgHeader (24 bytes)																															
...																															
...																															

MsgHeader (24 bytes): This field MUST contain a MESSAGE_PACKET structure.

- The value of the **dwUserMsgType** field MUST be 0x00004204.
- The value of the **dwcbVarLenData** field MUST be 0.

2.2.3.1.5 TXUSER_DTCLURMCONFIGURE_MTAG_DELETE_NOT_FOUND

The TXUSER_DTCLURMCONFIGURE_MTAG_DELETE_NOT_FOUND message is sent by a transaction manager to indicate that an LU Name Pair is not a member of the set of LU Name Pairs held by a transaction manager, and therefore cannot be deleted.

0	1	2	3	4	5	6	7	8	9	0	1	2	3	4	5	6	7	8	9	0	1	2	3	4	5	6	7	8	9	0	1
MsgHeader (24 bytes)																															
...																															
...																															

MsgHeader (24 bytes): This field MUST contain a MESSAGE_PACKET structure.

- The value of the **dwUserMsgType** field MUST be 0x00004205.
- The value of the **dwcbVarLenData** field MUST be 0.

2.2.3.1.6 TXUSER_DTCLURMCONFIGURE_MTAG_DELETE_UNRECOVERED_TRANS

The TXUSER_DTCLURMCONFIGURE_MTAG_DELETE_UNRECOVERED_TRANS message is sent by a transaction manager to indicate that an LU Name Pair cannot be removed from the set of LU Name Pairs because a recovery process is active for a logical unit of work associated with the LU Name Pair.

0	1	2	3	4	5	6	7	8	9	0	1	2	3	4	5	6	7	8	9	0	1	2	3	4	5	6	7	8	9	0	1
MsgHeader (24 bytes)																															
...																															
...																															

MsgHeader (24 bytes): This field MUST contain a MESSAGE_PACKET structure.

- The value of the **dwUserMsgType** field MUST be 0x00004206.
- The value of the **dwcbVarLenData** field MUST be 0.

2.2.3.1.7 TXUSER_DTCLURMCONFIGURE_MTAG_DELETE_INUSE

The TXUSER_DTCLURMCONFIGURE_MTAG_DELETE_INUSE message is sent by a transaction manager to indicate that an LU Name Pair cannot be removed from the set of LU Name Pairs because a logical unit of work associated with the LU Name Pair is active.

0	1	2	3	4	5	6	7	8	9	0	1	2	3	4	5	6	7	8	9	0	1	2	3	4	5	6	7	8	9	0	1
MsgHeader (24 bytes)																															
...																															

...

MsgHeader (24 bytes): This field MUST contain a MESSAGE_PACKET structure.

- The value of the **dwUserMsgType** field MUST be 0x00004207.
- The value of the **dwcbVarLenData** field MUST be 0.

2.2.3.1.8 TXUSER_DTCLURMCONFIGURE_MTAG_ADD_LOG_FULL

The TXUSER_DTCLURMCONFIGURE_MTAG_ADD_LOG_FULL message SHOULD<2> be sent by a transaction manager to indicate that the LU Name Pair cannot be added to the set of LU Name Pairs because insufficient space exists in the local LU recovery log that is held by a transaction manager to durably log the LU Name Pair.

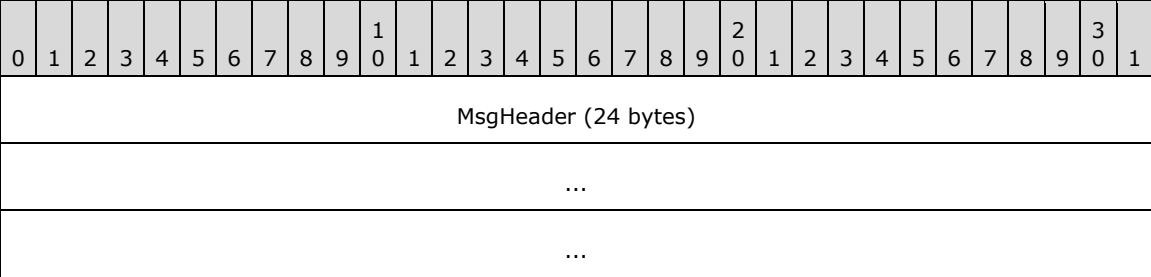

MsgHeader (24 bytes): This field MUST contain a MESSAGE_PACKET structure.

- The value of the **dwUserMsgType** field MUST be 0x00004208.
- The value of the **dwcbVarLenData** field MUST be 0.

2.2.3.2 CONNTYPE_TXUSER_DTCLURECOVERY

The **CONNTYPE_TXUSER_DTCLURECOVERY** connection type is used by an LU 6.2 Implementation to register as a recovery process with a transaction manager.

The use of **CONNTYPE_TXUSER_DTCLURECOVERY** as an initiator is specified in section 3.2.5.2, and as an acceptor in section 3.3.5.2.

2.2.3.2.1 TXUSER_DTCLURMRECOVERY_MTAG_ATTACH

The TXUSER_DTCLURMRECOVERY_MTAG_ATTACH message is sent by an LU 6.2 implementation (section 3.2) to register as a recovery process for logical units of work that involve the logical units identified by the LU Name Pair specified by the request.

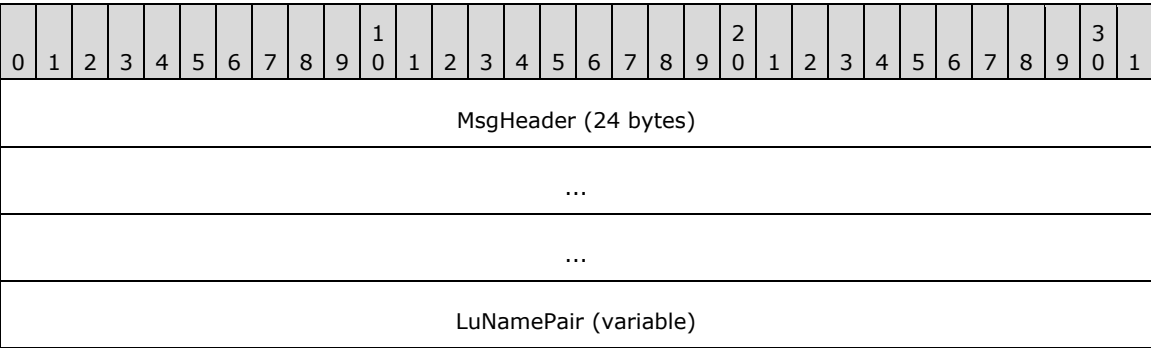

...

MsgHeader (24 bytes): This field MUST contain a MESSAGE_PACKET structure.

- The value of the **dwUserMsgType** field MUST be 0x00004301.
- The value of the **dwcbVarLenData** field MUST be at least 4.

LuNamePair (variable): This field MUST contain a DTCLU_VARLEN_BYTEARRAY structure that identifies an LU Name Pair. If the value of **cbLength** is not a multiple of 4, the end of the field MUST be aligned on a 4-byte boundary by padding with arbitrary values that MUST be ignored on receipt.

2.2.3.2.2 TXUSER_DTCLURMRECOVERY_MTAG_REQUEST_COMPLETED

The TXUSER_DTCLURMRECOVERY_MTAG_REQUEST_COMPLETED message is sent by a transaction manager to indicate that a request by an LU 6.2 implementation (section 3.2) to register as a recovery process for logical units of work that involves the logical units identified by the LU Name Pair specified by the request has completed successfully.

0	1	2	3	4	5	6	7	8	9	10	11	12	13	14	15	16	17	18	19	20	21	22	23	24	25	26	27	28	29	30	31
MsgHeader (24 bytes)																															
...																															
...																															

MsgHeader (24 bytes): This field MUST contain a MESSAGE_PACKET structure.

- The value of the **dwUserMsgType** field MUST be 0x00004303.
- The value of the **dwcbVarLenData** field MUST be 0.

2.2.3.2.3 TXUSER_DTCLURMRECOVERY_MTAG_ATTACH_DUPLICATE

The TXUSER_DTCLURMRECOVERY_MTAG_ATTACH_DUPLICATE message is sent by a transaction manager to indicate that the requested recovery process is already registered for logical units of work that involve the logical units identified by the LU Name Pair; therefore, the registration request cannot be completed.

0	1	2	3	4	5	6	7	8	9	10	11	12	13	14	15	16	17	18	19	20	21	22	23	24	25	26	27	28	29	30	31
MsgHeader (24 bytes)																															
...																															
...																															

MsgHeader (24 bytes): This field MUST contain a MESSAGE_PACKET structure.

- The value of the **dwUserMsgType** field MUST be 0x00004304.

- The value of the **dwcbVarLenData** field MUST be 0.

2.2.3.2.4 TXUSER_DTCLURMRECOVERY_MTAG_ATTACH_NOT_FOUND

The TXUSER_DTCLURMRECOVERY_MTAG_ATTACH_NOT_FOUND message is sent by a transaction manager to indicate that the LU Name Pair specified by the request is not a member of the set of LU Name Pairs held by a transaction manager; therefore the registration request cannot be completed.

0	1	2	3	4	5	6	7	8	9	10	11	12	13	14	15	16	17	18	19	20	21	22	23	24	25	26	27	28	29	30	31
MsgHeader (24 bytes)																															
...																															
...																															

MsgHeader (24 bytes): This field MUST contain a MESSAGE_PACKET structure.

- The value of the **dwUserMsgType** field MUST be 0x00004305.
- The value of the **dwcbVarLenData** field MUST be 0.

2.2.3.3 CONNTYPE_TXUSER_DTCLURMENLISTMENT

The **CONNTYPE_TXUSER_DTCLURMENLISTMENT** connection type is used by an LU 6.2 implementation (section 3.2) to establish a subordinate enlistment with a transaction manager.

The use of **CONNTYPE_TXUSER_DTCLURMENLISTMENT** as an initiator is specified in section 3.2.5.3, and as an acceptor in section 3.3.5.3.

2.2.3.3.1 TXUSER_DTCLURMENLISTMENT_MTAG_CREATE

The TXUSER_DTCLURMENLISTMENT_MTAG_CREATE message is sent by an LU 6.2 implementation (section 3.2) to request the creation of an LU 6.2 subordinate enlistment on a transaction managed by a transaction manager.

0	1	2	3	4	5	6	7	8	9	10	11	12	13	14	15	16	17	18	19	20	21	22	23	24	25	26	27	28	29	30	31
MsgHeader (24 bytes)																															
...																															
...																															
guidTx (16 bytes)																															
...																															
...																															
LuNamePair (variable)																															

...
LuTransId (variable)
...

MsgHeader (24 bytes): This field MUST contain a MESSAGE_PACKET structure.

- The value of the **dwUserMsgType** field MUST be 0x00004101.
- The value of the **dwcbVarLenData** field MUST be at least 24.

guidTx (16 bytes): This field MUST contain a GUID that specifies the transaction identifier for a transaction held by a transaction manager.

LuNamePair (variable): This field MUST contain a DTCLU_VARLEN_BYTEARRAY structure that identifies an LU Name Pair. If the value of **cbLength** is not a multiple of 4, the end of the field MUST be aligned on a 4-byte boundary by padding with arbitrary values that MUST be ignored on receipt.

LuTransId (variable): This field MUST contain a DTCLU_VARLEN_BYTEARRAY structure that specifies the LUW ID. If the value of **cbLength** is not a multiple of 4, the end of the field MUST be aligned on a 4-byte boundary by padding with arbitrary values that MUST be ignored on receipt.

2.2.3.3.2 TXUSER_DTCLURMENLISTMENT_MTAG_REQUEST_COMPLETED

The TXUSER_DTCLURMENLISTMENT_MTAG_REQUEST_COMPLETED message is sent by a transaction manager to indicate that a request to create an LU 6.2 subordinate enlistment on a transaction managed by a transaction manager was completed successfully.

0	1	2	3	4	5	6	7	8	9	10	11	12	13	14	15	16	17	18	19	20	21	22	23	24	25	26	27	28	29	30	31
MsgHeader (24 bytes)																															
...																															
...																															

MsgHeader (24 bytes): This field MUST contain a MESSAGE_PACKET structure.

- The value of the **dwUserMsgType** field MUST be 0x00004102.
- The value of the **dwcbVarLenData** field MUST be 0.

2.2.3.3.3 TXUSER_DTCLURMENLISTMENT_MTAG_TO_DTC_CONVERSATIONLOST

The TXUSER_DTCLURMENLISTMENT_MTAG_TO_DTC_CONVERSATIONLOST message is sent by an LU 6.2 implementation (section 3.2) to indicate that the conversation with a remote LU was lost.

0	1	2	3	4	5	6	7	8	9	10	11	12	13	14	15	16	17	18	19	20	21	22	23	24	25	26	27	28	29	30	31
MsgHeader (24 bytes)																															

...
...

MsgHeader (24 bytes): This field MUST contain a MESSAGE_PACKET structure.

- The value of the **dwUserMsgType** field MUST be 0x00004103.
- The value of the **dwcbVarLenData** field MUST be 0.

2.2.3.3.4 TXUSER_DTCLURMENLISTMENT_MTAG_TO_DTC_BACKEDOUT

The TXUSER_DTCLURMENLISTMENT_MTAG_TO_DTC_BACKEDOUT message is sent by an LU 6.2 implementation (section 3.2) to acknowledge that the LU 6.2 implementation has successfully processed a request to abort a logical unit of work and a transaction manager is no longer obligated to retain the outcome of this logical unit of work.

0	1	2	3	4	5	6	7	8	9	10	11	12	13	14	15	16	17	18	19	20	21	22	23	24	25	26	27	28	29	30	31
MsgHeader (24 bytes)																															
...																															
...																															

MsgHeader (24 bytes): This field MUST contain a MESSAGE_PACKET structure.

- The value of the **dwUserMsgType** field MUST be 0x00004104.
- The value of the **dwcbVarLenData** field MUST be 0.

2.2.3.3.5 TXUSER_DTCLURMENLISTMENT_MTAG_TO_DTC_BACKOUT

The TXUSER_DTCLURMENLISTMENT_MTAG_TO_DTC_BACKOUT message is sent by an LU 6.2 implementation to request a transaction manager to abort a logical unit of work.

0	1	2	3	4	5	6	7	8	9	10	11	12	13	14	15	16	17	18	19	20	21	22	23	24	25	26	27	28	29	30	31
MsgHeader (24 bytes)																															
...																															
...																															

MsgHeader (24 bytes): This field MUST contain a MESSAGE_PACKET structure.

- The value of the **dwUserMsgType** field MUST be 0x00004105.
- The value of the **dwcbVarLenData** field MUST be 0.

2.2.3.3.6 TXUSER_DTCLURMENLISTMENT_MTAG_TO_DTC_COMMITTED

The TXUSER_DTCLURMENLISTMENT_MTAG_TO_DTC_COMMITTED message is sent by an LU 6.2 implementation to a transaction manager to indicate that it has successfully committed a logical unit of work.

0	1	2	3	4	5	6	7	8	9	0	1	2	3	4	5	6	7	8	9	0	1	2	3	4	5	6	7	8	9	0	1
MsgHeader (24 bytes)																															
...																															
...																															

MsgHeader (24 bytes): This field MUST contain a MESSAGE_PACKET structure.

- The value of the **dwUserMsgType** field MUST be 0x00004106.
- The value of the **dwcbVarLenData** field MUST be 0.

2.2.3.3.7 TXUSER_DTCLURMENLISTMENT_MTAG_TO_DTC_FORGET

The TXUSER_DTCLURMENLISTMENT_MTAG_TO_DTC_FORGET message is sent by an LU 6.2 implementation (section 3.2) to a transaction manager to indicate that it has successfully committed a logical unit of work.

0	1	2	3	4	5	6	7	8	9	0	1	2	3	4	5	6	7	8	9	0	1	2	3	4	5	6	7	8	9	0	1
MsgHeader (24 bytes)																															
...																															
...																															

MsgHeader (24 bytes): This field MUST contain a MESSAGE_PACKET structure.

- The value of the **dwUserMsgType** field MUST be 0x00004107.
- The value of the **dwcbVarLenData** field MUST be 0.

2.2.3.3.8 TXUSER_DTCLURMENLISTMENT_MTAG_TO_DTC_REQUESTCOMMIT

The TXUSER_DTCLURMENLISTMENT_MTAG_TO_DTC_REQUESTCOMMIT message is sent by an LU 6.2 implementation (section 3.2) to indicate that it has successfully processed a request to carry out the necessary operations to commit a logical unit of work.

0	1	2	3	4	5	6	7	8	9	0	1	2	3	4	5	6	7	8	9	0	1	2	3	4	5	6	7	8	9	0	1
MsgHeader (24 bytes)																															
...																															
...																															

MsgHeader (24 bytes): This field MUST contain a MESSAGE_PACKET structure.

- The value of the **dwUserMsgType** field MUST be 0x00004108.
- The value of the **dwcbVarLenData** field MUST be 0.

2.2.3.3.9 TXUSER_DTCLURMENLISTMENT_MTAG_TO_LU_BACKEDOUT

The TXUSER_DTCLURMENLISTMENT_MTAG_TO_LU_BACKEDOUT message is sent by a transaction manager to acknowledge that it has successfully processed a request to abort a logical unit of work.

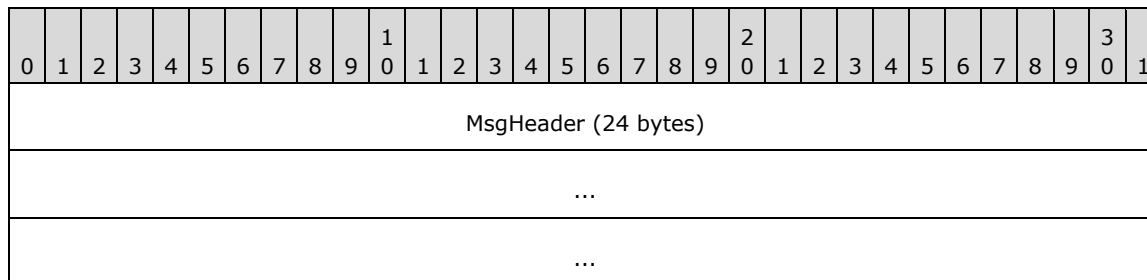

MsgHeader (24 bytes): This field MUST contain a MESSAGE_PACKET structure.

- The value of the **dwUserMsgType** field MUST be 0x00004109.
- The value of the **dwcbVarLenData** field MUST be 0.

2.2.3.3.10 TXUSER_DTCLURMENLISTMENT_MTAG_TO_LU_BACKOUT

The TXUSER_DTCLURMENLISTMENT_MTAG_TO_LU_BACKOUT message is sent by a transaction manager to inform the LU 6.2 implementation (section 3.2) that a logical unit of work has aborted.

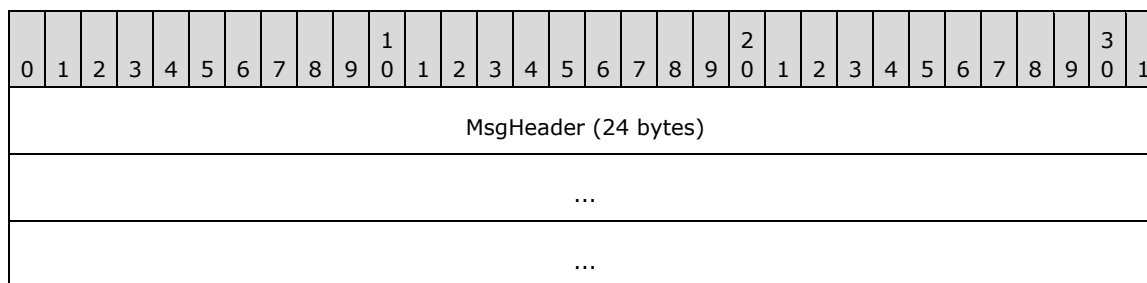

MsgHeader (24 bytes): This field MUST contain a MESSAGE_PACKET structure.

- The value of the **dwUserMsgType** field MUST be 0x00004110.
- The value of the **dwcbVarLenData** field MUST be 0.

2.2.3.3.11 TXUSER_DTCLURMENLISTMENT_MTAG_TO_LU_COMMITTED

The TXUSER_DTCLURMENLISTMENT_MTAG_TO_LU_COMMITTED message is sent by a transaction manager to indicate that a logical unit of work was successfully committed.

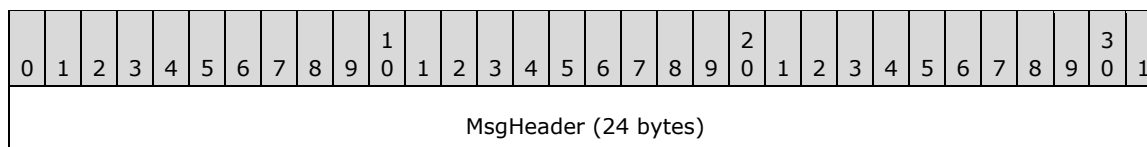

...
...

MsgHeader (24 bytes): This field MUST contain a MESSAGE_PACKET structure.

- The value of the **dwUserMsgType** field MUST be 0x00004111.
- The value of the **dwcbVarLenData** field MUST be 0.

2.2.3.3.12 TXUSER_DTCLURMENLISTMENT_MTAG_TO_LU_PREPARE

The TXUSER_DTCLURMENLISTMENT_MTAG_TO_LU_PREPARE message is sent by a transaction manager to request that the LU 6.2 implementation (section 3.2) perform the actions that are needed to prepare a logical unit of work to be committed.

0	1	2	3	4	5	6	7	8	9	0	1	2	3	4	5	6	7	8	9	0	1	2	3	4	5	6	7	8	9	0	1
MsgHeader (24 bytes)																															
...																															
...																															

MsgHeader (24 bytes): This field MUST contain a MESSAGE_PACKET structure.

- The value of the **dwUserMsgType** field MUST be 0x00004113.
- The value of the **dwcbVarLenData** field MUST be 0.

2.2.3.3.13 TXUSER_DTCLURMENLISTMENT_MTAG_CREATE_TX_NOT_FOUND

The TXUSER_DTCLURMENLISTMENT_MTAG_CREATE_TX_NOT_FOUND message is sent by a transaction manager to indicate that a request to create an LU 6.2 subordinate enlistment failed because the transaction identified by the request is not a member of the set of transactions held by a transaction manager.

0	1	2	3	4	5	6	7	8	9	0	1	2	3	4	5	6	7	8	9	0	1	2	3	4	5	6	7	8	9	0	1
MsgHeader (24 bytes)																															
...																															
...																															

MsgHeader (24 bytes): This field MUST contain a MESSAGE_PACKET structure.

- The value of the **dwUserMsgType** field MUST be 0x00004116.
- The value of the **dwcbVarLenData** field MUST be 0.

2.2.3.3.14 TXUSER_DTCLURMENLISTMENT_MTAG_CREATE_TOO_LATE

The TXUSER_DTCLURMENLISTMENT_MTAG_CREATE_TOO_LATE message is sent by a transaction manager to indicate that a request to create an LU 6.2 subordinate enlistment failed because it is too late in the lifetime of the transaction identified by the request.

0	1	2	3	4	5	6	7	8	9	0	1	2	3	4	5	6	7	8	9	0	1	2	3	4	5	6	7	8	9	0	1
MsgHeader (24 bytes)																															
...																															
...																															

MsgHeader (24 bytes): This field MUST contain a MESSAGE_PACKET structure.

- The value of the **dwUserMsgType** field MUST be 0x00004117.
- The value of the **dwcbVarLenData** field MUST be 0.

2.2.3.3.15 TXUSER_DTCLURMENLISTMENT_MTAG_CREATE_LOG_FULL

The TXUSER_DTCLURMENLISTMENT_MTAG_CREATE_LOG_FULL message is sent by a transaction manager to indicate that a request to create an LU 6.2 subordinate enlistment failed because insufficient space exists in the local LU recovery log held by a transaction manager to durably log the enlistment.

0	1	2	3	4	5	6	7	8	9	0	1	2	3	4	5	6	7	8	9	0	1	2	3	4	5	6	7	8	9	0	1
MsgHeader (24 bytes)																															
...																															
...																															

MsgHeader (24 bytes): This field MUST contain a MESSAGE_PACKET structure.

- The value of the **dwUserMsgType** field MUST be 0x00004118.
- The value of the **dwcbVarLenData** field MUST be 0.

2.2.3.3.16 TXUSER_DTCLURMENLISTMENT_MTAG_CREATE_TOO_MANY

The TXUSER_DTCLURMENLISTMENT_MTAG_CREATE_TOO_MANY message is sent by a transaction manager to indicate that a request to create an LU 6.2 subordinate enlistment failed because the implementation-specific<3> maximum number of enlistments for the transaction managed by a transaction manager has been reached.

0	1	2	3	4	5	6	7	8	9	0	1	2	3	4	5	6	7	8	9	0	1	2	3	4	5	6	7	8	9	0	1
MsgHeader (24 bytes)																															
...																															

...

MsgHeader (24 bytes): This field MUST contain a MESSAGE_PACKET structure.

- The value of the **dwUserMsgType** field MUST be 0x00004119.
- The value of the **dwcbVarLenData** field MUST be 0.

2.2.3.3.17 TXUSER_DTCLURMENLISTMENT_MTAG_CREATE_LU_NOT_FOUND

The TXUSER_DTCLURMENLISTMENT_MTAG_CREATE_LU_NOT_FOUND message is sent by a transaction manager to indicate that a request to create an LU 6.2 subordinate enlistment failed because the LU Name Pair specified by the request is not a member of the set of LU Name Pairs held by the transaction manager.

0	1	2	3	4	5	6	7	8	9	0	1	2	3	4	5	6	7	8	9	0	1	2	3	4	5	6	7	8	9	0	1	2	3	4	5	6	7	8	9	0	1
MsgHeader (24 bytes)																																									
...																																									
...																																									

MsgHeader (24 bytes): This field MUST contain a MESSAGE_PACKET structure.

- The value of the **dwUserMsgType** field MUST be 0x00004120.
- The value of the **dwcbVarLenData** field MUST be 0.

2.2.3.3.18 TXUSER_DTCLURMENLISTMENT_MTAG_UNPLUG

The TXUSER_DTCLURMENLISTMENT_MTAG_UNPLUG message is sent by an LU 6.2 implementation (section 3.2) to a transaction manager to unplug itself from a subordinate enlistment.

0	1	2	3	4	5	6	7	8	9	0	1	2	3	4	5	6	7	8	9	0	1	2	3	4	5	6	7	8	9	0	1	2	3	4	5	6	7	8	9	0	1
MsgHeader (24 bytes)																																									
...																																									
...																																									

MsgHeader (24 bytes): This field MUST contain a MESSAGE_PACKET structure.

- The value of the **dwUserMsgType** field MUST be 0x00004122.
- The value of the **dwcbVarLenData** field MUST be 0.

2.2.3.3.19 TXUSER_DTCLURMENLISTMENT_MTAG_CREATE_DUPLICATE_LU_TRANS ID

The TXUSER_DTCLURMENLISTMENT_MTAG_CREATE_DUPLICATE_LU_TRANSID message is sent by a transaction manager to indicate that a request to create an LU 6.2 subordinate enlistment failed

because a logical unit of work identified by the LUW ID specified by the request is already associated with the LU Name Pair specified by the request.

0	1	2	3	4	5	6	7	8	9	10	11	12	13	14	15	16	17	18	19	20	21	22	23	24	25	26	27	28	29	30	31
MsgHeader (24 bytes)																															
...																															
...																															

MsgHeader (24 bytes): This field MUST contain a MESSAGE_PACKET structure.

- The value of the **dwUserMsgType** field MUST be 0x00004123.
- The value of the **dwcbVarLenData** field MUST be 0.

2.2.3.3.20 TXUSER_DTCLURMENLISTMENT_MTAG_CREATE_LU_NO_RECOVERY_PROCESS

The TXUSER_DTCLURMENLISTMENT_MTAG_CREATE_LU_NO_RECOVERY_PROCESS message is sent by a transaction manager to indicate that a request to create an LU 6.2 subordinate enlistment failed because there is no recovery process registered for the LU Name Pair specified by the request.

0	1	2	3	4	5	6	7	8	9	10	11	12	13	14	15	16	17	18	19	20	21	22	23	24	25	26	27	28	29	30	31
MsgHeader (24 bytes)																															
...																															
...																															

MsgHeader (24 bytes): This field MUST contain a MESSAGE_PACKET structure.

- The value of the **dwUserMsgType** field MUST be 0x00004124.
- The value of the **dwcbVarLenData** field MUST be 0.

2.2.3.3.21 TXUSER_DTCLURMENLISTMENT_MTAG_CREATE_LU_DOWN

The TXUSER_DTCLURMENLISTMENT_MTAG_CREATE_LU_DOWN message is sent by a transaction manager to indicate that a request to create an LU 6.2 subordinate enlistment failed because the required recovery process was not previously performed for the local LUs and remote LUs identified by the LU Name Pair specified by the request.

0	1	2	3	4	5	6	7	8	9	10	11	12	13	14	15	16	17	18	19	20	21	22	23	24	25	26	27	28	29	30	31
MsgHeader (24 bytes)																															
...																															
...																															

MsgHeader (24 bytes): This field MUST contain a MESSAGE_PACKET structure.

- The value of the **dwUserMsgType** field MUST be 0x00004125.
- The value of the **dwcbVarLenData** field MUST be 0.

2.2.3.3.22 TXUSER_DTCLURMENLISTMENT_MTAG_CREATE_LU_RECOVERING

The TXUSER_DTCLURMENLISTMENT_MTAG_CREATE_LU_RECOVERING message is sent by a transaction manager to indicate that a request to create an LU 6.2 subordinate enlistment failed because a recovery process is in progress for the local LUs and remote LUs identified by the LU Name Pair specified by the request.

0	1	2	3	4	5	6	7	8	9	10	11	12	13	14	15	16	17	18	19	20	21	22	23	24	25	26	27	28	29	30	31
MsgHeader (24 bytes)																															
...																															
...																															

MsgHeader (24 bytes): This field MUST contain a MESSAGE_PACKET structure.

- The value of the **dwUserMsgType** field MUST be 0x00004126.
- The value of the **dwcbVarLenData** field MUST be 0.

2.2.3.3.23 TXUSER_DTCLURMENLISTMENT_MTAG_CREATE_LU_RECOVERY_MISMATCH

The TXUSER_DTCLURMENLISTMENT_MTAG_CREATE_LU_RECOVERY_MISMATCH message is sent by a transaction manager to indicate that a request to create an LU 6.2 subordinate enlistment failed, because the recovery process for the local LUs and the remote LUs identified by the LU Name Pair specified by the request detected inconsistencies between the states of the logical units.

0	1	2	3	4	5	6	7	8	9	10	11	12	13	14	15	16	17	18	19	20	21	22	23	24	25	26	27	28	29	30	31
MsgHeader (24 bytes)																															
...																															
...																															

MsgHeader (24 bytes): This field MUST contain a MESSAGE_PACKET structure.

- The value of the **dwUserMsgType** field MUST be 0x00004127.
- The value of the **dwcbVarLenData** field MUST be 0.

2.2.3.4 CONNTYPE_TXUSER_DTCLURECOVERYINITIATEDBYDTC

The **CONNTYPE_TXUSER_DTCLURECOVERYINITIATEDBYDTC** connection type is used to request LU 6.2 recovery work from the transaction manager.

The use of **CONNTYPE_TXUSER_DTCLURECOVERYINITIATEDBYDTC** as an initiator is specified in section 3.2.5.4, and as an acceptor in section 3.3.5.4.

2.2.3.4.1 TXUSER_DTCLURECOVERYINITIATEDBYDTC_MTAG_GETWORK

The TXUSER_DTCLURECOVERYINITIATEDBYDTC_MTAG_GETWORK message is sent by an LU 6.2 implementation to query for LU 6.2 recovery work for a pair of logical units identified by an LU Name Pair.

0	1	2	3	4	5	6	7	8	9	10	11	12	13	14	15	16	17	18	19	20	21	22	23	24	25	26	27	28	29	30	31
MsgHeader (24 bytes)																															
...																															
...																															
LuNamePair (variable)																															
...																															

MsgHeader (24 bytes): This field MUST contain a MESSAGE_PACKET structure.

- The value of the **dwUserMsgType** field MUST be 0x00004401.
- The value of the **dwcbVarLenData** field MUST be at least 4.

LuNamePair (variable): This field MUST contain a DTCLU_VARLEN_BYTEARRAY structure that identifies an LU Name Pair. If the value of **cbLength** is not a multiple of 4, the end of the field MUST be aligned on a 4-byte boundary by padding with arbitrary values that MUST be ignored on receipt.

2.2.3.4.2 TXUSER_DTCLURECOVERYINITIATEDBYDTC_MTAG_GETWORK_NOT_FOUND

The TXUSER_DTCLURECOVERYINITIATEDBYDTC_MTAG_GETWORK_NOT_FOUND message is sent by a transaction manager to indicate that a query for LU 6.2 recovery work failed because the LU Name Pair specified by the query is not a member of the set of LU Name Pairs held by the transaction manager.

0	1	2	3	4	5	6	7	8	9	10	11	12	13	14	15	16	17	18	19	20	21	22	23	24	25	26	27	28	29	30	31
MsgHeader (24 bytes)																															
...																															
...																															

MsgHeader (24 bytes): This field MUST contain a MESSAGE_PACKET structure.

- The value of the **dwUserMsgType** field MUST be 0x00004402.
- The value of the **dwcbVarLenData** field MUST be 0.

2.2.3.4.3 TXUSER_DTCLURECOVERYINITIATEDBYDTC_MTAG_WORK_CHECKLUSTATUS

The TXUSER_DTCLURECOVERYINITIATEDBYDTC_MTAG_WORK_CHECKLUSTATUS message is sent by a transaction manager to request a status check of the sessions between a pair of logical units identified by the LU Name Pair specified by a previous TXUSER_DTCLURECOVERYINITIATEDBYDTC_MTAG_GETWORK message.

0	1	2	3	4	5	6	7	8	9	10	11	12	13	14	15	16	17	18	19	20	21	22	23	24	25	26	27	28	29	30	31
MsgHeader (24 bytes)																															
...																															
...																															

MsgHeader (24 bytes): This field MUST contain a MESSAGE_PACKET structure.

- The value of the **dwUserMsgType** field MUST be 0x00004403.
- The value of the **dwcbVarLenData** field MUST be 0.

2.2.3.4.4 TXUSER_DTCLURECOVERYINITIATEDBYDTC_MTAG_WORK_TRANS

The TXUSER_DTCLURECOVERYINITIATEDBYDTC_MTAG_WORK_TRANS message is sent by a transaction manager to initiate recovery for a pair of logical units identified by the LU Name Pair specified by a previous TXUSER_DTCLURECOVERYINITIATEDBYDTC_MTAG_GETWORK message.

0	1	2	3	4	5	6	7	8	9	10	11	12	13	14	15	16	17	18	19	20	21	22	23	24	25	26	27	28	29	30	31
MsgHeader (24 bytes)																															
...																															
...																															
RecoverySeqNum																															
XIn																															
dwProtocol																															
OurLogName (variable)																															
...																															
RemoteLogName (variable)																															
...																															

MsgHeader (24 bytes): This field MUST contain a MESSAGE_PACKET structure.

- The value of the **dwUserMsgType** field MUST be 0x00004404.

- The value of the **dwcbVarLenData** field MUST be at least 20.

RecoverySeqNum (4 bytes): A 32-bit signed integer that MUST contain the value for the recovery sequence number of a local LU held by a transaction manager.

XIn (4 bytes): This field MUST contain the log status of a local LU held by a transaction manager. The value MUST be one defined by the DTCLUXLN enumeration.

dwProtocol (4 bytes): A 32-bit unsigned integer that MUST contain 0.

OurLogName (variable): This field MUST contain a DTCLU_VARLEN_BYTEARRAY structure which contains the local log name held by a transaction manager. If **cbLength** is not a multiple of 4, the end of the field MUST be aligned on a 4-byte boundary by padding with arbitrary values that MUST be ignored on receipt.

RemoteLogName (variable): This field MUST contain a DTCLU_VARLEN_BYTEARRAY structure which either has the **cbLength** field set to 0, or contains the remote log name supplied by a remote LU. If **cbLength** is not a multiple of 4, the end of the field MUST be aligned on a 4-byte boundary by padding with arbitrary values that MUST be ignored on receipt.

2.2.3.4.5 TXUSER_DTCLURECOVERYINITIATEDBYDTC_MTAG_LUSTATUS

The TXUSER_DTCLURECOVERYINITIATEDBYDTC_MTAG_LUSTATUS message is sent by an LU 6.2 implementation (section 3.2) to provide the recovery sequence number held by an LU 6.2 implementation for a pair of logical units identified by an LU Name Pair specified by a previous TXUSER_DTCLURECOVERYINITIATEDBYDTC_MTAG_GETWORK message.

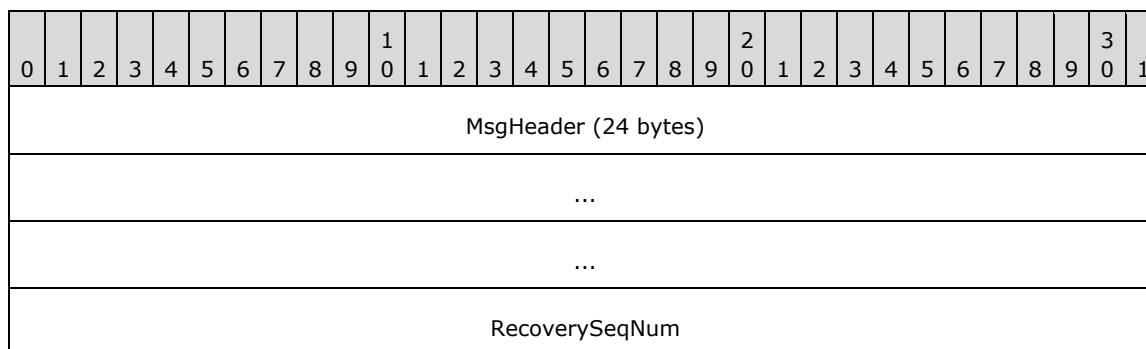

MsgHeader (24 bytes): This field MUST contain a MESSAGE_PACKET structure.

- The value of the **dwUserMsgType** field MUST be 0x00004407.
- The value of the **dwcbVarLenData** field MUST be 4.

RecoverySeqNum (4 bytes): A 32-bit signed integer that MUST contain the value for the recovery sequence number held by an LU 6.2 implementation for a pair of LUs identified by an LU Name Pair specified by a previous TXUSER_DTCLURECOVERYINITIATEDBYDTC_MTAG_GETWORK message.

2.2.3.4.6 TXUSER_DTCLURECOVERYINITIATEDBYDTC_MTAG_REQUESTCOMPLETE

The TXUSER_DTCLURECOVERYINITIATEDBYDTC_MTAG_REQUESTCOMPLETE message is sent by a transaction manager to indicate that a request initiated by an LU 6.2 implementation (section 3.2) has completed successfully.

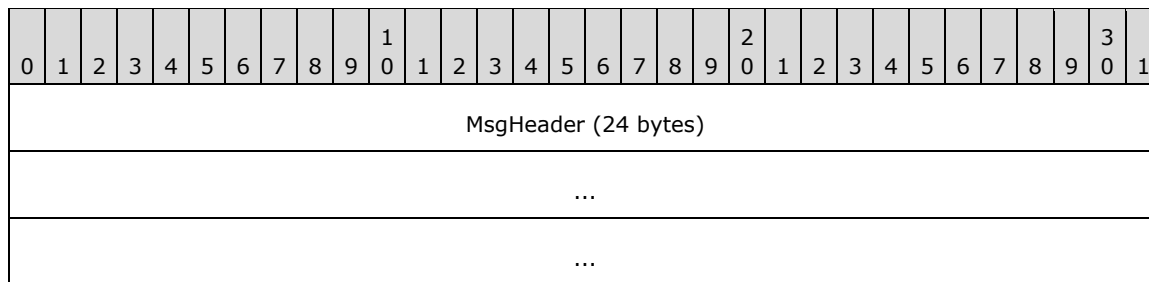

MsgHeader (24 bytes): This field MUST contain a MESSAGE_PACKET structure.

- The value of the **dwUserMsgType** field MUST be 0x00004408.
- The value of the **dwcbVarLenData** field MUST be 0.

2.2.3.4.7 TXUSER_DTCLURECOVERYINITIATEDBYDTC_MTAG_CONFIRMATION_FROM_OUR_XLN

The TXUSER_DTCLURECOVERYINITIATEDBYDTC_MTAG_CONFIRMATION_FROM_OUR_XLN message is sent by an LU 6.2 implementation (section 3.2) to report the completion status of an exchange of XLN messages with a remote LU.

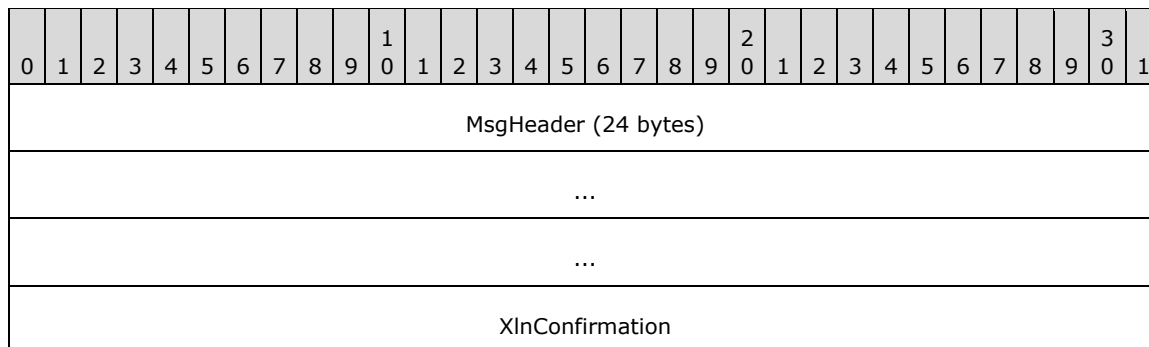

MsgHeader (24 bytes): This field MUST contain a MESSAGE_PACKET structure.

- The value of the **dwUserMsgType** field MUST be 0x00004409.
- The value of the **dwcbVarLenData** field MUST be 4.

XlnConfirmation (4 bytes): This field MUST contain the completion status of an exchange of XLN messages with a remote LU. The value MUST be one defined by the DTCLUXLNCONFIRMATION enumeration.

2.2.3.4.8 TXUSER_DTCLURECOVERYINITIATEDBYDTC_MTAG_THEIR_XLN_RESPONSE

The TXUSER_DTCLURECOVERYINITIATEDBYDTC_MTAG_THEIR_XLN_RESPONSE message is sent by an LU 6.2 implementation (section 3.2) to report the contents of an XLN response sent by a remote LU.

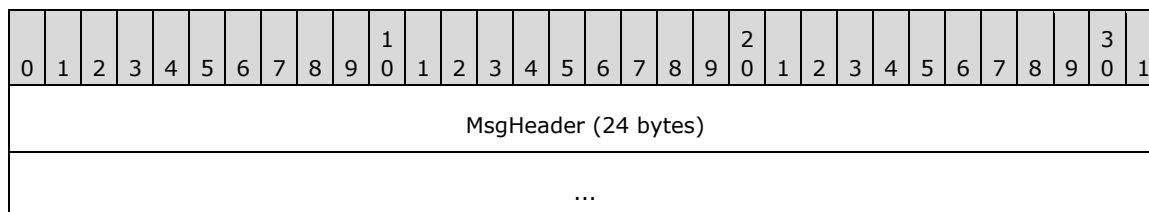

...
Xln
dwProtocol
RemoteLogName (variable)
...

MsgHeader (24 bytes): This field MUST contain a MESSAGE_PACKET structure.

- The value of the **dwUserMsgType** field MUST be 0x00004410.
- The value of the **dwcbVarLenData** field MUST be at least 12.

Xln (4 bytes): This field MUST contain the log status supplied by a remote LU. The value MUST be one defined by the DTCLXLN enumeration.

dwProtocol (4 bytes): A 32-bit unsigned integer that MUST contain 0.

RemoteLogName (variable): This field MUST contain a DTCLU_VARLEN_BYTEARRAY structure that contains the remote log name supplied by a remote LU. If the value of **cbLength** is not a multiple of 4, the end of the field MUST be aligned on a 4-byte boundary by padding with arbitrary values that MUST be ignored on receipt.

2.2.3.4.9 TXUSER_DTCLURECOVERYINITIATEDBYDTC_MTAG_CONFIRMATION_FOR_THEIR_XLN

The TXUSER_DTCLURECOVERYINITIATEDBYDTC_MTAG_CONFIRMATION_FOR_THEIR_XLN message is sent by the transaction manager to report the completion status of an exchange of XLN messages with a remote LU.

0	1	2	3	4	5	6	7	8	9	10	11	12	13	14	15	16	17	18	19	20	21	22	23	24	25	26	27	28	29	30	31
MsgHeader (24 bytes)																															
...																															
...																															
XlnConfirmation																															

MsgHeader (24 bytes): This field MUST contain a MESSAGE_PACKET structure.

- The value of the **dwUserMsgType** field MUST be 0x00004411.
- The value of the **dwcbVarLenData** field MUST be 4.

XlnConfirmation (4 bytes): This field MUST contain the completion status of an exchange of XLN messages with a remote LU. The value MUST be one defined by the DTCLXLNCONFIRMATION enumeration.

2.2.3.4.10 TXUSER_DTCLURECOVERYINITIATEDBYDTC_MTAG_ERROR_FROM_OUR_XLN

The TXUSER_DTCLURECOVERYINITIATEDBYDTC_MTAG_ERROR_FROM_OUR_XLN message is sent by an LU 6.2 implementation (section 3.2) to report that an exchange of XLN messages with a remote LU did not complete normally.

0	1	2	3	4	5	6	7	8	9	10	11	12	13	14	15	16	17	18	19	20	21	22	23	24	25	26	27	28	29	30	31
MsgHeader (24 bytes)																															
...																															
...																															
XlnError																															

MsgHeader (24 bytes): This field MUST contain a MESSAGE_PACKET structure.

- The value of the **dwUserMsgType** field MUST be 0x00004412.
- The value of the **dwcbVarLenData** field MUST be 4.

XlnError (4 bytes): This field MUST contain the error status resulting from an exchange of XLN messages with a remote LU. The value MUST be one defined by the DTCLUXLNERROR enumeration.

2.2.3.4.11 TXUSER_DTCLURECOVERYINITIATEDBYDTC_MTAG_CHECK_FOR_COMPA RESTATES

The TXUSER_DTCLURECOVERYINITIATEDBYDTC_MTAG_CHECK_FOR_COMPARESTATES message is sent by an LU 6.2 implementation (section 3.2) to query for a logical unit of work that requires recovery work to be performed.

0	1	2	3	4	5	6	7	8	9	10	11	12	13	14	15	16	17	18	19	20	21	22	23	24	25	26	27	28	29	30	31
MsgHeader (24 bytes)																															
...																															
...																															

MsgHeader (24 bytes): This field MUST contain a MESSAGE_PACKET structure.

- The value of the **dwUserMsgType** field MUST be 0x00004413.
- The value of the **dwcbVarLenData** field MUST be 0.

2.2.3.4.12 TXUSER_DTCLURECOVERYINITIATEDBYDTC_MTAG_COMPARESTATES_I NFO

The TXUSER_DTCLURECOVERYINITIATEDBYDTC_MTAG_COMPARESTATES_INFO message is sent by a transaction manager to provide information about a logical unit of work (LUW) that requires recovery work to be performed.

0	1	2	3	4	5	6	7	8	9	10	11	12	13	14	15	16	17	18	19	20	21	22	23	24	25	26	27	28	29	30	31
MsgHeader (24 bytes)																															
...																															
...																															
CompareStates																															
LuTransId (variable)																															
...																															

MsgHeader (24 bytes): This field MUST contain a MESSAGE_PACKET structure.

- The value of the **dwUserMsgType** field MUST be 0x00004414.
- The value of the **dwcbVarLenData** field MUST be at least 8.

CompareStates (4 bytes): This field MUST contain the status of an LUW held by a transaction manager. The value MUST be one defined by the DTCLUCOMPARESTATE enumeration.

LuTransId (variable): This field MUST contain a DTCLU_VARLEN_BYTEARRAY structure that contains the LUW ID. If the value of **cbLength** is not a multiple of 4, the end of the field MUST be aligned on a 4-byte boundary by padding with arbitrary values that MUST be ignored on receipt.

2.2.3.4.13 TXUSER_DTCLURECOVERYINITIATEDBYDTC_MTAG_NO_COMPARESTATE S

The TXUSER_DTCLURECOVERYINITIATEDBYDTC_MTAG_NO_COMPARESTATES message is sent by a transaction manager to indicate that there is no logical unit that requires recovery work to be performed.

0	1	2	3	4	5	6	7	8	9	10	11	12	13	14	15	16	17	18	19	20	21	22	23	24	25	26	27	28	29	30	31
MsgHeader (24 bytes)																															
...																															
...																															

MsgHeader (24 bytes): This field MUST contain a MESSAGE_PACKET structure.

- The value of the **dwUserMsgType** field MUST be 0x00004415.
- The value of the **dwcbVarLenData** field MUST be 0.

2.2.3.4.14 TXUSER_DTCLURECOVERYINITIATEDBYDTC_MTAG_THEIR_COMPARESTATES

The TXUSER_DTCLURECOVERYINITIATEDBYDTC_MTAG_THEIR_COMPARESTATES message is sent by an LU 6.2 implementation (section 3.2) to report logical unit of work state information received from a remote LU.

0	1	2	3	4	5	6	7	8	9	0	1	2	3	4	5	6	7	8	9	0	1	2	3	4	5	6	7	8	9	0	1
MsgHeader (24 bytes)																															
...																															
...																															
CompareStates																															

MsgHeader (24 bytes): This field MUST contain a MESSAGE_PACKET structure.

- The value of the **dwUserMsgType** field MUST be 0x00004416.
- The value of the **dwcbVarLenData** field MUST be 4.

CompareStates (4 bytes): This field MUST contain the status of a logical unit of work. The value MUST be one defined by the DTCLUCOMPARESTATE enumeration.

2.2.3.4.15 TXUSER_DTCLURECOVERYINITIATEDBYDTC_MTAG_CONFIRMATION_FOR_THEIR_COMPARESTATES

The TXUSER_DTCLURECOVERYINITIATEDBYDTC_MTAG_CONFIRMATION_FOR_THEIR_COMPARESTATES message is sent by a transaction manager to report the completion status of an exchange of logical unit of work (LUW) state information with a remote LU.

0	1	2	3	4	5	6	7	8	9	0	1	2	3	4	5	6	7	8	9	0	1	2	3	4	5	6	7	8	9	0	1
MsgHeader (24 bytes)																															
...																															
...																															
CompareStatesConfirmation																															

MsgHeader (24 bytes): This field MUST contain a MESSAGE_PACKET structure.

- The value of the **dwUserMsgType** field MUST be 0x00004417.
- The value of the **dwcbVarLenData** field MUST be 4.

CompareStatesConfirmation (4 bytes): This field MUST contain the completion status for an exchange of LUW state information between a local LU and a remote LU during recovery. The value MUST be one defined by the DTCLUCOMPARESTATESCONFIRMATION enumeration.

2.2.3.4.16 TXUSER_DTCLURECOVERYINITIATEDBYDTC_MTAG_ERROR_FROM_OUR_COMPARESTATES

The TXUSER_DTCLURECOVERYINITIATEDBYDTC_MTAG_ERROR_FROM_OUR_COMPARESTATES message is sent by an LU 6.2 implementation (section 3.2) to indicate that an error has occurred when exchanging LUW state information with a remote LU.

0	1	2	3	4	5	6	7	8	9	10	11	12	13	14	15	16	17	18	19	20	21	22	23	24	25	26	27	28	29	30	31
MsgHeader (24 bytes)																															
...																															
...																															
CompareStatesError																															

MsgHeader (24 bytes): This field MUST contain a MESSAGE_PACKET structure.

- The value of the **dwUserMsgType** field MUST be 0x00004418.
- The value of the **dwcbVarLenData** field MUST be 4.

CompareStatesError (4 bytes): This field MUST contain the error status for an exchange of LUW state information between a local LU and a remote LU during recovery. The value MUST be one defined by the DTCLUCOMPARESTATESERROR enumeration.

2.2.3.4.17 TXUSER_DTCLURECOVERYINITIATEDBYDTC_MTAG_CONVERSATION_LOST

The TXUSER_DTCLURECOVERYINITIATEDBYDTC_MTAG_CONVERSATION_LOST message is sent by an LU 6.2 implementation (section 3.2) to report that the conversation with a remote LU was lost.

0	1	2	3	4	5	6	7	8	9	10	11	12	13	14	15	16	17	18	19	20	21	22	23	24	25	26	27	28	29	30	31
MsgHeader (24 bytes)																															
...																															
...																															

MsgHeader (24 bytes): This field MUST contain a MESSAGE_PACKET structure.

- The value of the **dwUserMsgType** field MUST be 0x00004419.
- The value of the **dwcbVarLenData** field MUST be 0.

2.2.3.4.18 TXUSER_DTCLURECOVERYINITIATEDBYDTC_MTAG_NEW_RECOVERY_SEQ_NUM

The TXUSER_DTCLURECOVERYINITIATEDBYDTC_MTAG_NEW_RECOVERY_SEQ_NUM message is sent by an LU 6.2 implementation (section 3.2) to indicate that the recovery sequence number specified by a transaction manager is out of date.

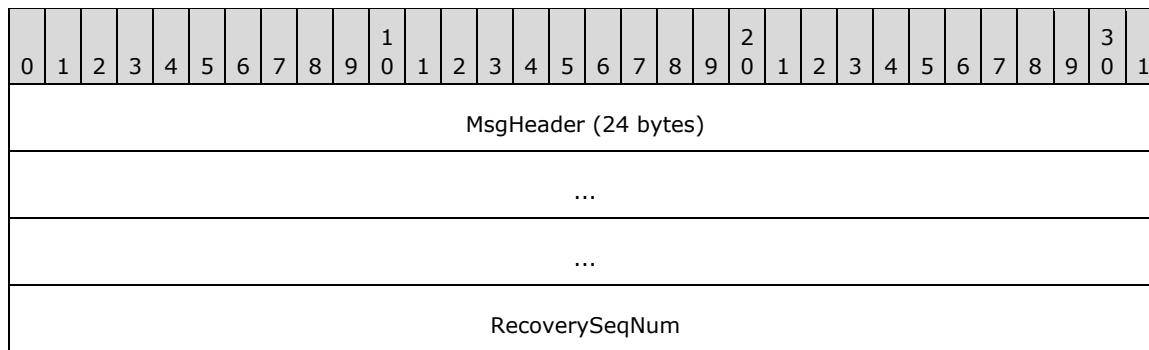

MsgHeader (24 bytes): This field MUST contain a MESSAGE_PACKET structure.

- The value of the **dwUserMsgType** field MUST be 0x00004420.
- The value of the **dwcbVarLenData** field MUST be 4.

RecoverySeqNum (4 bytes): A 32-bit signed integer that MUST contain the value for the recovery sequence number held by an LU 6.2 implementation for a pair of logical units identified by the LU Name Pair specified in a previous TXUSER_DTCLURECOVERYINITIATEDBYDTC_MTAG_GETWORK message.

2.2.3.5 CONNTYPE_TXUSER_DTCLURECOVERYINITIATEDBYLU

The **CONNTYPE_TXUSER_DTCLURECOVERYINITIATEDBYLU** connection type is used for LU 6.2 recovery work initiated by an LU 6.2 implementation (section 3.2).

The use of **CONNTYPE_TXUSER_DTCLURECOVERYINITIATEDBYLU** as an initiator is specified in section 3.2.5.5, and as an acceptor in section 3.3.5.5.

2.2.3.5.1 TXUSER_DTCLURECOVERYINITIATEDBYLU_MTAG_THEIR_XLN

The TXUSER_DTCLURECOVERYINITIATEDBYLU_MTAG_THEIR_XLN message is sent by an LU 6.2 implementation (section 3.2) to initiate recovery work for a pair of LUs identified by the LU Name Pair specified by the request when an XLN message is received from a remote LU.

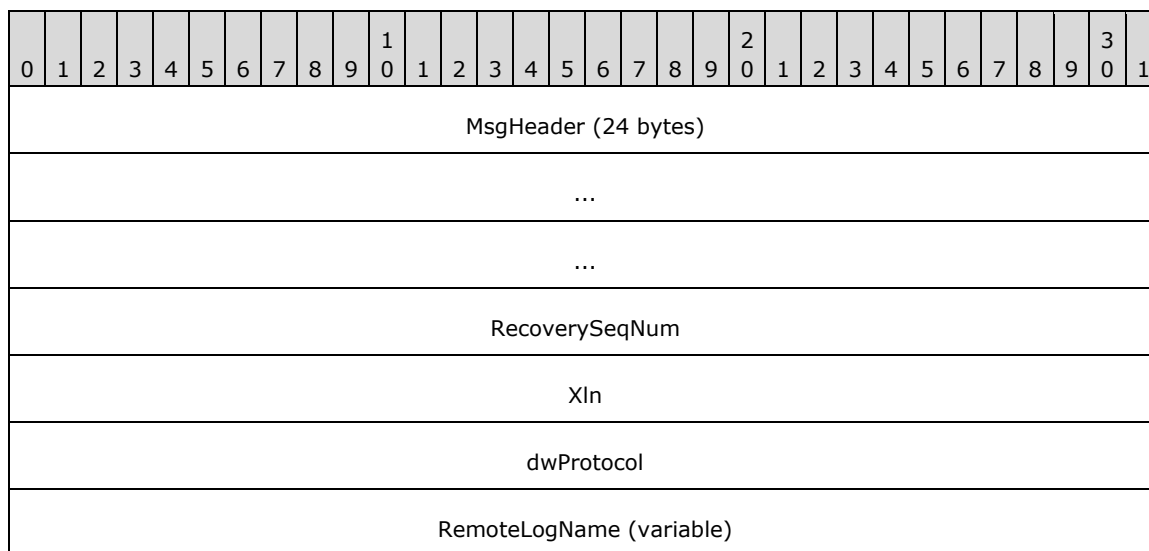

...
OurLogName (variable)
...
LuNamePair (variable)
...

MsgHeader (24 bytes): This field MUST contain a MESSAGE_PACKET structure.

- The value of the **dwUserMsgType** field MUST be 0x00004501.
- The value of the **dwcbVarLenData** field MUST be at least 24.

RecoverySeqNum (4 bytes): A 32-bit signed integer that MUST contain the value for the recovery sequence number held by the LU 6.2 implementation for the pair of LUs identified by the **LuNamePair** field.

XIn (4 bytes): This field MUST contain the log status supplied by a remote LU. The value MUST be one defined by the DTCLUXLN enumeration.

dwProtocol (4 bytes): A 32-bit unsigned integer that MUST contain 0.

RemoteLogName (variable): This field MUST contain a DTCLU_VARLEN_BYTEARRAY structure that contains the remote log name supplied by a remote LU. If the value of **cbLength** is not a multiple of 4, the end of the field MUST be aligned on a 4-byte boundary by padding with arbitrary values that MUST be ignored on receipt.

OurLogName (variable): This field MUST contain a DTCLU_VARLEN_BYTEARRAY structure that either has **cbLength** field set to 0, or contains the local log name supplied by a remote LU. If the value of **cbLength** is not a multiple of 4, the end of the field MUST be aligned on a 4-byte boundary by padding with arbitrary values that MUST be ignored on receipt.

LuNamePair (variable): This field MUST contain a DTCLU_VARLEN_BYTEARRAY structure that identifies an LU Name Pair. If the value of **cbLength** is not a multiple of 4, the end of the field MUST be aligned on a 4-byte boundary by padding with arbitrary values that MUST be ignored on receipt.

2.2.3.5.2 TXUSER_DTCLURECOVERYINITIATEDBYLU_MTAG_RESPONSE_FOR_THEIR_XLN

The TXUSER_DTCLURECOVERYINITIATEDBYLU_MTAG_RESPONSE_FOR_THEIR_XLN message is sent by a transaction manager to request that an XLN response is sent to a remote LU.

0	1	2	3	4	5	6	7	8	9	10	11	12	13	14	15	16	17	18	19	20	21	22	23	24	25	26	27	28	29	30	31
MsgHeader (24 bytes)																								...							
...																															

XlnResponse
Xln
dwProtocol
OurLogName (variable)
...

MsgHeader (24 bytes): This field MUST contain a MESSAGE_PACKET structure.

- The value of the **dwUserMsgType** field MUST be 0x00004502.
- The value of the **dwcbVarLenData** field MUST be at least 16.

XlnResponse (4 bytes): This field MUST contain the type of XLN response to be sent to the remote LU. The value MUST be one defined by the DTCLUXLNRESPONSE enumeration.

Xln (4 bytes): This field MUST contain the log status of a local LU held by a transaction manager. The value MUST be one defined by the DTCLUXLN enumeration.

dwProtocol (4 bytes): A 32-bit unsigned integer that MUST contain 0.

OurLogName (variable): This field MUST contain a DTCLU_VARLEN_BYTEARRAY structure that contains the local log name held by a transaction manager. If the value of **cbLength** is not a multiple of 4, the end of the field MUST be aligned on a 4-byte boundary by padding with arbitrary values that MUST be ignored on receipt.

2.2.3.5.3 TXUSER_DTCLURECOVERYINITIATEDBYLU_MTAG_CONFIRMATION_OF_OUR_XLN

The TXUSER_DTCLURECOVERYINITIATEDBYLU_MTAG_CONFIRMATION_OF_OUR_XLN message is sent by an LU 6.2 implementation (section 3.2) to report the completion status for an exchange of XLN messages with a remote LU.

0	1	2	3	4	5	6	7	8	9	10	11	12	13	14	15	16	17	18	19	20	21	22	23	24	25	26	27	28	29	30	31
MsgHeader (24 bytes)																															
...																															
...																															
XlnConfirmation																															

MsgHeader (24 bytes): This field MUST contain a MESSAGE_PACKET structure.

- The value of the **dwUserMsgType** field MUST be 0x00004503.
- The value of the **dwcbVarLenData** field MUST be 4.

XlnConfirmation (4 bytes): This field MUST contain the completion status for an exchange of XLN messages with a remote LU. The value MUST be one defined by the DTCLUXLNCONFIRMATION enumeration.

2.2.3.5.4 TXUSER_DTCLURECOVERYINITIATEDBYLU_MTAG_THEIR_COMPARESTATES

The TXUSER_DTCLURECOVERYINITIATEDBYLU_MTAG_THEIR_COMPARESTATES message is sent by an LU 6.2 implementation (section 3.2) to report the state information received from a remote LU for an LUW that requires recovery work to be performed.

0	1	2	3	4	5	6	7	8	9	10	11	12	13	14	15	16	17	18	19	20	21	22	23	24	25	26	27	28	29	30	31
MsgHeader (24 bytes)																															
...																															
...																															
CompareStates																															
LuTransId (variable)																															
...																															

MsgHeader (24 bytes): This field MUST contain a MESSAGE_PACKET structure.

- The value of the **dwUserMsgType** field MUST be 0x00004504.
- The value of the **dwcbVarLenData** field MUST be at least 8.

CompareStates (4 bytes): This field MUST contain the status of an LUW. The value MUST be one defined by the DTCLUCOMPARESTATE enumeration.

LuTransId (variable): This field MUST contain a DTCLU_VARLEN_BYTEARRAY structure that contains the LUW ID. If the value of **cbLength** is not a multiple of 4, the end of the field MUST be aligned on a 4-byte boundary by padding with arbitrary values that MUST be ignored on receipt.

2.2.3.5.5 TXUSER_DTCLURECOVERYINITIATEDBYLU_MTAG_RESPONSE_FOR_THEIR_COMPARESTATES

The TXUSER_DTCLURECOVERYINITIATEDBYLU_MTAG_RESPONSE_FOR_THEIR_COMPARESTATES message is sent by a transaction manager to report the completion status of an exchange of LUW state information with a remote LU.

0	1	2	3	4	5	6	7	8	9	10	11	12	13	14	15	16	17	18	19	20	21	22	23	24	25	26	27	28	29	30	31
MsgHeader (24 bytes)																															
...																															
...																															
CompareStatesResponse																															

CompareStates

MsgHeader (24 bytes): This field MUST contain a MESSAGE_PACKET structure.

- The value of the **dwUserMsgType** field MUST be 0x00004505.
- The value of the **dwcbVarLenData** field MUST be 8.

CompareStatesResponse (4 bytes): This field MUST contain the completion status for an exchange of LUW state information with a remote LU. The value MUST be one defined by the DTCLUCOMPARESTATESRESPONSE enumeration.

CompareStates (4 bytes): This field MUST contain the status of an LUW held by a transaction manager. The value MUST be one defined by the DTCLUCOMPARESTATE enumeration.

2.2.3.5.6 TXUSER_DTCLURECOVERYINITIATEDBYLU_MTAG_CONFIRMATION_OF_OUR_COMPARESTATES

The TXUSER_DTCLURECOVERYINITIATEDBYLU_MTAG_CONFIRMATION_OF_OUR_COMPARESTATES message is sent by an LU 6.2 implementation (section 3.2) to report the completion status of an exchange of LUW state information with a remote LU.

0	1	2	3	4	5	6	7	8	9	10	11	12	13	14	15	16	17	18	19	20	21	22	23	24	25	26	27	28	29	30	31
MsgHeader (24 bytes)																															
...																															
...																															
CompareStatesConfirmation																															

MsgHeader (24 bytes): This field MUST contain a MESSAGE_PACKET structure.

- The value of the **dwUserMsgType** field MUST be 0x00004506.
- The value of the **dwcbVarLenData** field MUST be 4.

CompareStatesConfirmation (4 bytes): This field MUST contain the completion status for an exchange of LUW state information between a local LU and a remote LU during recovery. The value MUST be one defined by the DTCLUCOMPARESTATESCONFIRMATION enumeration.

2.2.3.5.7 TXUSER_DTCLURECOVERYINITIATEDBYLU_MTAG_ERROR_OF_OUR_COMPARESTATES

The TXUSER_DTCLURECOVERYINITIATEDBYLU_MTAG_ERROR_OF_OUR_COMPARESTATES message is sent by an LU 6.2 implementation (section 3.2) to indicate that an exchange of LUW state information with a remote LU did not complete normally.

0	1	2	3	4	5	6	7	8	9	10	11	12	13	14	15	16	17	18	19	20	21	22	23	24	25	26	27	28	29	30	31
MsgHeader (24 bytes)																															

...
...
CompareStatesError

MsgHeader (24 bytes): This field MUST contain a MESSAGE_PACKET structure.

- The value of the **dwUserMsgType** field MUST be 0x00004507.
- The value of the **dwcbVarLenData** field MUST be 4.

CompareStatesError (4 bytes): This field MUST contain the error status for an exchange of LUW state information between a local LU and a remote LU during recovery. The value MUST be one defined by the DTCLUCOMPARESTATESERROR enumeration.

2.2.3.5.8 TXUSER_DTCLURECOVERYINITIATEDBYLU_MTAG_CONVERSATION_LOST

The TXUSER_DTCLURECOVERYINITIATEDBYLU_MTAG_CONVERSATION_LOST message is sent by an LU 6.2 implementation (section 3.2) to report that the conversation with a remote LU was lost.

0	1	2	3	4	5	6	7	8	9	10	11	12	13	14	15	16	17	18	19	20	21	22	23	24	25	26	27	28	29	30	31
MsgHeader (24 bytes)																															
...																															
...																															

MsgHeader (24 bytes): This field MUST contain a MESSAGE_PACKET structure.

- The value of the **dwUserMsgType** field MUST be 0x00004508.
- The value of the **dwcbVarLenData** field MUST be 0.

2.2.3.5.9 TXUSER_DTCLURECOVERYINITIATEDBYLU_MTAG_REQUESTCOMPLETE

The TXUSER_DTCLURECOVERYINITIATEDBYLU_MTAG_REQUESTCOMPLETE message is sent by a transaction manager to indicate that a request initiated by an LU 6.2 implementation (section 3.2) has been completed.

0	1	2	3	4	5	6	7	8	9	10	11	12	13	14	15	16	17	18	19	20	21	22	23	24	25	26	27	28	29	30	31
MsgHeader (24 bytes)																															
...																															
...																															

MsgHeader (24 bytes): This field MUST contain a MESSAGE_PACKET structure.

- The value of the **dwUserMsgType** field MUST be 0x00004509.

- The value of the **dwcbVarLenData** field MUST be 0.

2.2.3.5.10 TXUSER_DTCLURECOVERYINITIATEDBYLU_MTAG_THEIR_XLN_NOT_FOUND

The TXUSER_DTCLURECOVERYINITIATEDBYLU_MTAG_THEIR_XLN_NOT_FOUND message is sent by a transaction manager to indicate that a request for initiating recovery work failed because the LU Name Pair specified by the request is not a member of the set of LU Name Pairs held by a transaction manager.

0	1	2	3	4	5	6	7	8	9	10	11	12	13	14	15	16	17	18	19	20	21	22	23	24	25	26	27	28	29	30	31
MsgHeader (24 bytes)																															
...																															
...																															

MsgHeader (24 bytes): This field MUST contain a MESSAGE_PACKET structure.

- The value of the **dwUserMsgType** field MUST be 0x00004510.
- The value of the **dwcbVarLenData** field MUST be 0.

3 Protocol Details

3.1 Common Details

This section defines common details for the transaction participants, as specified in sections 3.2 and 3.3. Each participant **MUST** conform to the details as specified in this section.

3.1.1 Abstract Data Model

This section describes a conceptual model of possible data organization that an implementation maintains to participate in this protocol. The described organization is provided to facilitate the explanation of how the protocol behaves. This document does not mandate that implementations adhere to this model as long as their external behavior is consistent with the behavior that is described in this document.

Note that the abstract data model can be implemented in a variety of ways. This protocol does not prescribe or advocate any specific implementation technique.

Participants **MUST** use connections of the multiplexing protocol as a transport protocol for sending messages. Section 2.1 defines the mechanisms by which this protocol initializes and makes use of the multiplexing protocol.

A participant **MUST** extend the definition of a connection object (as specified in [MS-CMP] section 3.1.1.1) to include the following data element:

- **State:** A state enumeration that represents the current state of the connection.

A state enumeration **MUST** contain a set of values that represent specific states in a logical state machine. For a connection type, these values represent the different states to which the connection's logical state machine is set during the lifetime of the connection.

When a participant initiates or accepts a connection, the **State** field of the connection **MUST** be set initially to the Idle state. When the connection is disconnected, the connection state **MUST** be set to the Ended state.

When an instance of a state machine enters the Ended state, the connection that is associated with the state machine **MUST** be disconnected (if it is not already disconnected), as specified in [MS-CMP] section 3.1.5.1.

A participant **MUST** support both initiating and accepting multiple concurrent connection of any connection type inside the same, or different, MSDTC Connection Manager: OleTx Transports Protocol (as specified in [MS-CMPO]) sessions. Consequently, a participant **MUST** support the existence of multiple instances of a single connection of the same type. A participant **MUST** also support initiating multiple concurrent sessions to several different endpoints.

3.1.2 Timers

None.

3.1.3 Initialization

As specified in [MS-DTCO] section 3.1.3.

3.1.4 Protocol Version Negotiation

As specified in [MS-DTCO] section 3.1.4.

3.1.5 Higher-Layer Triggered Events

None.

3.1.6 Message Processing Events and Sequencing Rules

As specified in [MS-DTCO] section 3.1.6.

3.1.7 Timer Events

None.

3.1.8 Other Local Events

As specified in [MS-DTCO] section 3.1.8.

3.2 LU 6.2 Implementation Details

3.2.1 Abstract Data Model

This section describes a conceptual model of possible data organization that an implementation maintains to participate in this protocol. The described organization is provided to facilitate the explanation of how the protocol behaves. This document does not mandate that implementations adhere to this model as long as their external behavior is consistent with the behavior that is described in this document.

An LU 6.2 Implementation MUST maintain all the data elements that are specified in section 3.1.1.

An LU 6.2 Implementation MUST also maintain the following data elements:

- **Transaction Manager Name:** A Name object that identifies the transaction manager that is associated with the LU 6.2 Implementation.
- **Recovery Sequence Number Table:** A table of recovery sequence numbers, keyed by LU Name Pair.
 - **Recovery Sequence Number:** A sequence number that is used to demarcate sequences of Recovery protocol messages and therefore, to make it possible to detect obsolete Recovery protocol messages. The recovery sequence number is initialized to 0.
- The connection object of type CONNTYPE_TXUSER_DTCLURECOVERY (section 2.2.3.2) MUST be extended to include the following data field:
 - **LU Name Pair:** Specifies a reference to the **LU Pair** object that is associated with the connection.
- The connection object of type CONNTYPE_TXUSER_DTCLURECOVERYINITIATEDBYDTC MUST be extended to include the following data fields:
 - **Early Compare States Check Done:** This flag is used to indicate whether the Compare States check query was processed during Warm XLN.
 - **Transaction Found To Recover:** This flag is used to indicate whether there are transactions that require recovery work to be performed.
- The connection object of type CONNTYPE_TXUSER_DTCLURECOVERYINITIATEDBYLU MUST be extended to include the following data fields:

- **LU Pair:** Specifies a reference to the **LU Pair** object that is associated with the connection.
- **LUW To Recover:** Specifies a reference to the **LUW** object that is associated with the connection.

An LU 6.2 Implementation **MUST** provide the states that are defined in the following sections for its supported connection types.

An LU 6.2 Implementation **MAY**<4> also maintain the following data element:

- **LU Transactions Enabled:** This flag specifies whether a transaction manager has enabled this protocol. This flag is used to disable or enable all functionality of this protocol.

The **LU Transactions Enabled** flag is initialized based on the value of the **Allow LUTransactions** flag in the transaction manager, as specified in section 3.2.3.

3.2.1.1 CONNTYPE_TXUSER_DTCLUCONFIGURE Initiator States

The LU 6.2 implementation (section 3.2) **MUST** act as an initiator for the CONNTYPE_TXUSER_DTCLUCONFIGURE connection type. In this role, an LU 6.2 implementation **MUST** provide support for the following states:

- Idle
- Awaiting Add Response
- Awaiting Delete Response
- Ended

The following figure shows the relationship between the CONNTYPE_TXUSER_DTCLUCONFIGURE initiator states.

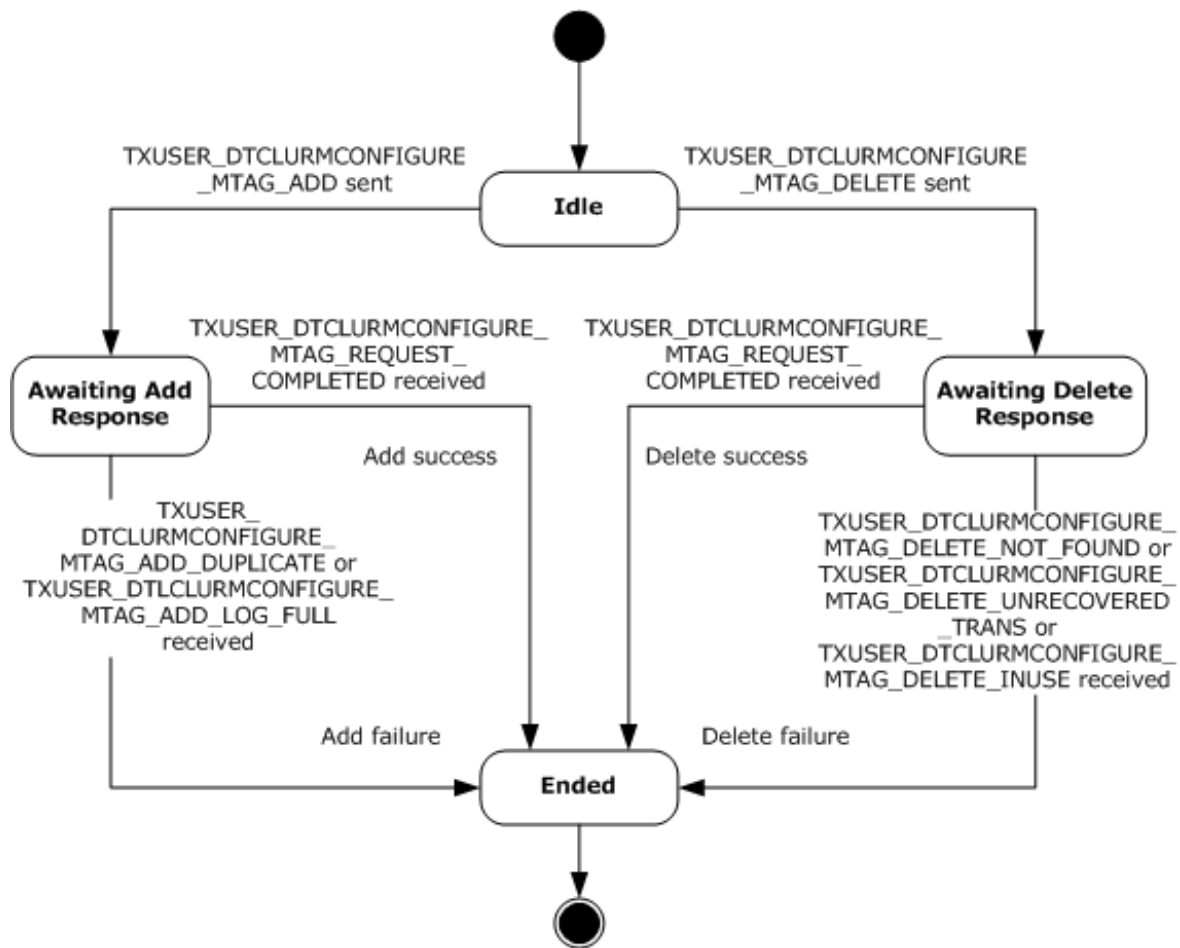

Figure 5: CONNTYPE_TXUSER_DTCLURMCONFIGURE initiator states

3.2.1.1.1 Idle

Idle is the initial state. The following events are processed in this state:

- Adding an LU Name Pair
- Deleting an LU Name Pair

3.2.1.1.2 Awaiting Add Response

The following events are processed in the Awaiting Add Response state:

- Receiving a TXUSER_DTCLURMCONFIGURE_MTAG_ADD_DUPLICATE message
- Receiving a TXUSER_DTCLURMCONFIGURE_MTAG_REQUEST_COMPLETED message
- Receiving a TXUSER_DTCLURMCONFIGURE_MTAG_ADD_LOG_FULL Message
- Connection Disconnected (section 3.2.5.1.7)

3.2.1.1.3 Awaiting Delete Response

The following events are processed in the Awaiting Delete Response state:

- Receiving a TXUSER_DTCLURMCONFIGURE_MTAG_DELETE_NOT_FOUND message
- Receiving a TXUSER_DTCLURMCONFIGURE_MTAG_DELETE_UNRECOVERED_TRANS message
- Receiving a TXUSER_DTCLURMCONFIGURE_MTAG_DELETE_INUSE message
- Receiving a TXUSER_DTCLURMCONFIGURE_MTAG_REQUEST_COMPLETED message
- Connection Disconnected (section 3.2.5.1.7)

3.2.1.1.4 Ended

Ended is the final state.

3.2.1.2 CONNTYPE_TXUSER_DTCLURECOVERY Initiator States

The LU 6.2 implementation (section 3.2) MUST act as an initiator for the CONNTYPE_TXUSER_DTCLURECOVERY connection type. In this role, an LU 6.2 implementation MUST provide support for the following states:

- Idle
- Awaiting Register Response
- Registered
- Ended

The following figure shows the relationship between the CONNTYPE_TXUSER_DTCLURECOVERY initiator states.

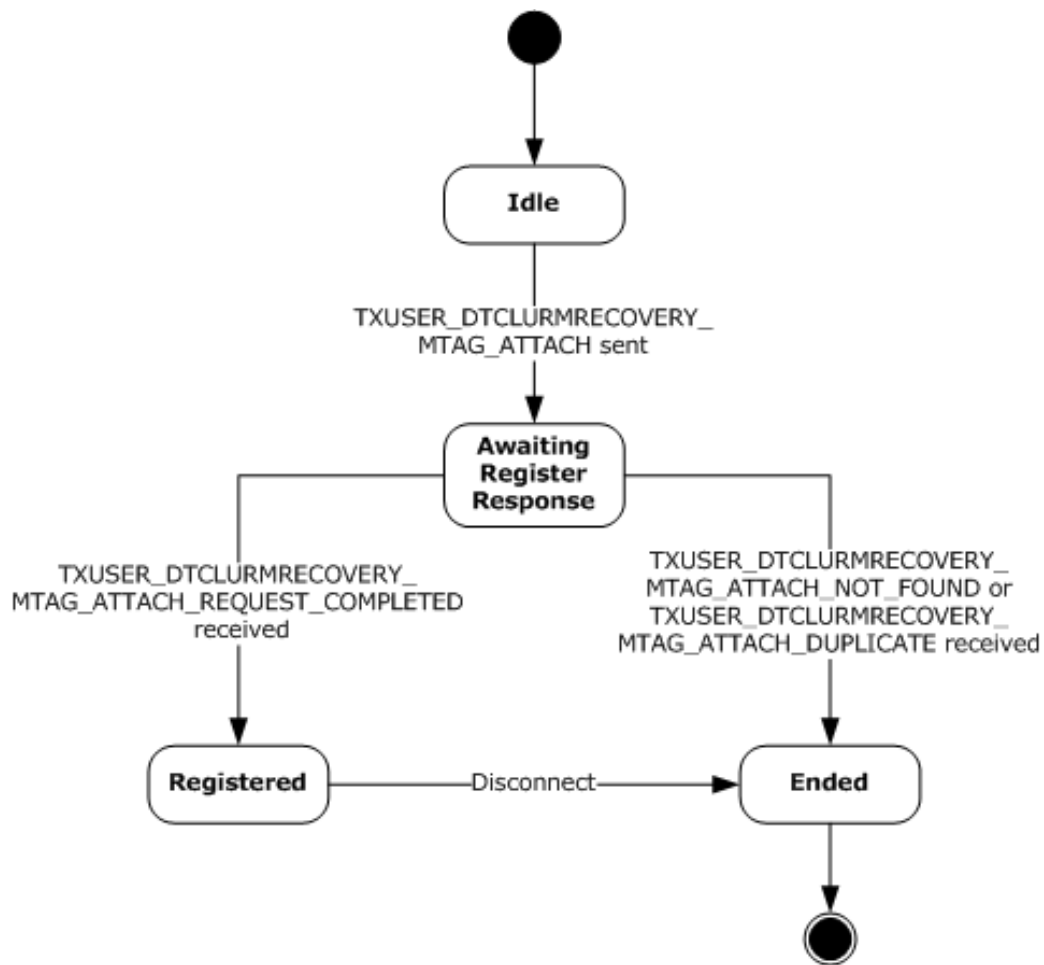

Figure 6: CONNTYPE_TXUSER_DTCLURECOVERY initiator states

3.2.1.2.1 Idle

Idle is the initial state. The following event is processed in this state:

- Registering recovery process for LU pair

3.2.1.2.2 Awaiting Register Response

The following events are processed in the Awaiting Register Response state:

- Receiving a TXUSER_DTCLURMRECOVERY_MTAG_ATTACH_NOT_FOUND message
- Receiving a TXUSER_DTCLURMRECOVERY_MTAG_ATTACH_DUPLICATE message
- Receiving a TXUSER_DTCLURMRECOVERY_MTAG_REQUEST_COMPLETED message
- Connection Disconnected (section 3.2.5.2.4)

3.2.1.2.3 Registered

The Disconnect event indicates that if the connection is disconnected, then the registration as a recovery process by an LU 6.2 implementation is ended. So the LU 6.2 implementation (section 3.2) MUST maintain the CONNTYPE_TXUSER_DTCLURECOVERY connection in the Registered state for the

intended lifetime of any CONNTYPE_TXUSER_DTCLURECOVERYINITIATEDBYDTC and CONNTYPE_TXUSER_DTCLURECOVERYINITIATEDBYLU connections that are associated with the same **LU Pair** object.

3.2.1.2.4 Ended

Ended is the final state.

3.2.1.3 CONNTYPE_TXUSER_DTCLURMENLISTMENT Initiator States

The LU 6.2 implementation (section 3.2) MUST act as an initiator for the CONNTYPE_TXUSER_DTCLURMENLISTMENT connection type. In this role, an LU 6.2 implementation MUST provide support for the following states:

- Idle
- Awaiting Enlistment Response
- Active
- Preparing for Transaction Commit
- Awaiting Backout Response
- Awaiting Transaction Outcome
- Finalizing Abort Operations
- Finalizing Commit Operations
- Ended

The following figure shows the relationship between the CONNTYPE_TXUSER_DTCLURMENLISTMENT initiator states.

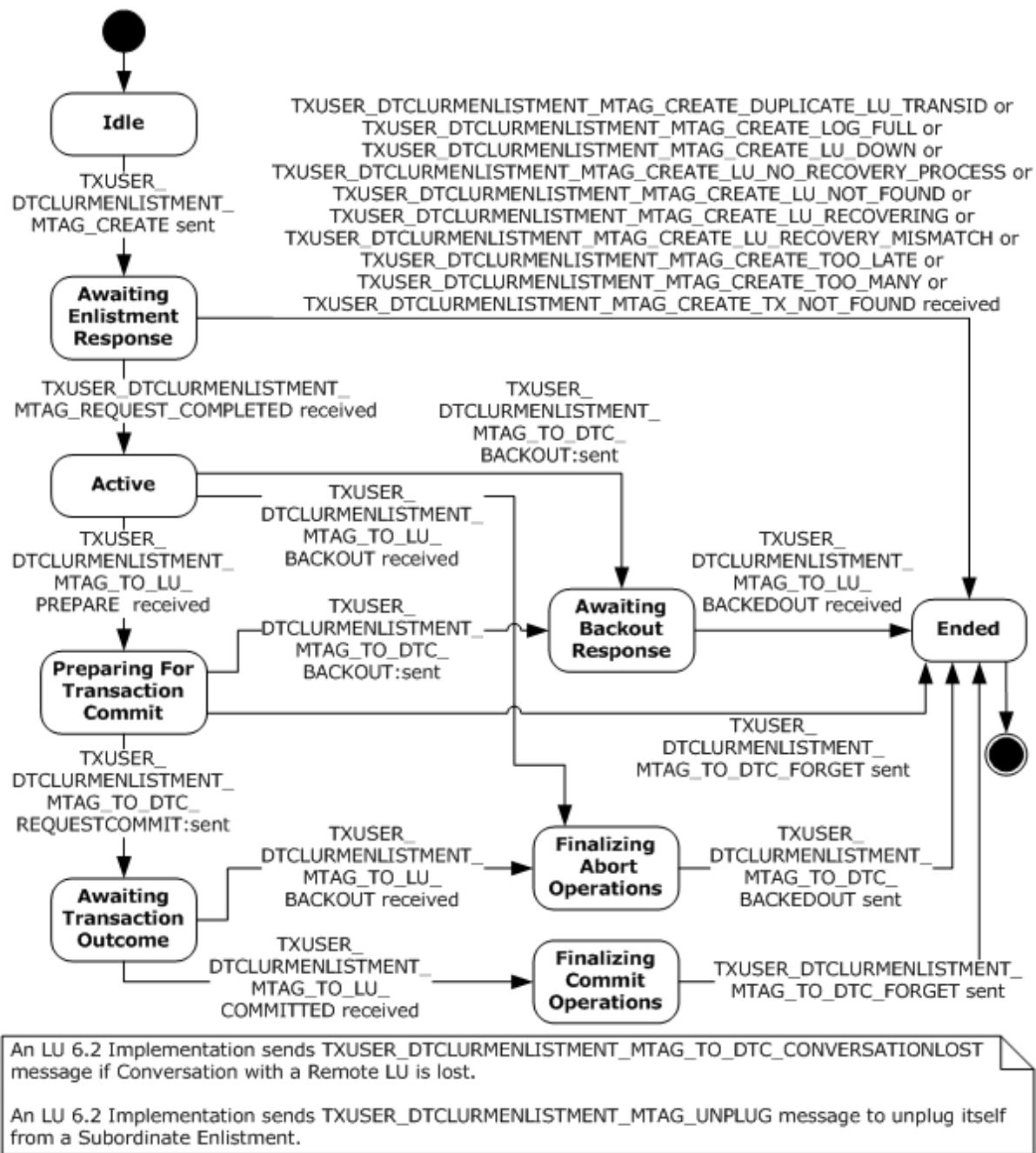

Figure 7: CONNTYPE_TXUSER_DTCLURMENLISTMENT initiator states

3.2.1.3.1 Idle

Idle is the initial state. The following events are processed in this state:

- Creating LU 6.2 Subordinate Enlistment
- LU 6.2 Subordinate Enlistment Conversation Lost
- Unplugging LU 6.2 Subordinate Enlistment

3.2.1.3.2 Awaiting Enlistment Response

The following events are processed in the Awaiting Enlistment Response state:

- Receiving a TXUSER_DTCLURMENLISTMENT_MTAG_REQUEST_COMPLETED message
- Receiving Other TXUSER_DTCLURMENLISTMENT_MTAG messages
- LU 6.2 Subordinate Enlistment Conversation Lost
- Unplugging LU 6.2 Subordinate Enlistment
- Connection Disconnected (section 3.2.5.3.7)

3.2.1.3.3 Active

The following events are processed in the Active state:

- Receiving a TXUSER_DTCLURMENLISTMENT_MTAG_TO_LU_PREPARE message
- Receiving a TXUSER_DTCLURMENLISTMENT_MTAG_TO_LU_BACKOUT message
- Aborting LU 6.2 Subordinate Enlistment
- LU 6.2 Subordinate Enlistment-Conversation Lost
- Unplugging LU 6.2 Subordinate Enlistment
- Connection Disconnected (section 3.2.5.3.7)

3.2.1.3.4 Preparing for Transaction Commit

The following events are processed in the Preparing for Transaction Commit state:

- LU 6.2 Subordinate Enlistment Prepare Request Completed
- LU 6.2 Subordinate Enlistment-Conversation Lost
- Unplugging LU 6.2 Subordinate Enlistment

3.2.1.3.5 Awaiting Backout Response

The following events are processed in the Awaiting Backout Response state:

- Receiving a TXUSER_DTCLURMENLISTMENT_MTAG_TO_LU_BACKEDOUT message
- LU 6.2 Subordinate Enlistment-Conversation Lost
- Unplugging LU 6.2 Subordinate Enlistment
- Connection Disconnected (section 3.2.5.3.7)

3.2.1.3.6 Awaiting Transaction Outcome

The following events are processed in the Awaiting Transaction Outcome state:

- Receiving a TXUSER_DTCLURMENLISTMENT_MTAG_TO_LU_BACKOUT message
- Receiving a TXUSER_DTCLURMENLISTMENT_MTAG_TO_LU_COMMITTED message
- LU 6.2 Subordinate Enlistment-Conversation Lost

- Unplugging LU 6.2 Subordinate Enlistment
- Connection Disconnected (section 3.2.5.3.7)

3.2.1.3.7 Finalizing Abort Operations

The following events are processed in the Finalizing Abort Operations state:

- LU 6.2 Subordinate Enlistment Abort Request Completed
- LU 6.2 Subordinate Enlistment-Conversation Lost
- Unplugging LU 6.2 Subordinate Enlistment

3.2.1.3.8 Finalizing Commit Operations

The following events are processed in the Finalizing Commit Operations state:

- LU 6.2 Subordinate Enlistment Commit Request Completed
- LU 6.2 Subordinate Enlistment-Conversation Lost
- Unplugging LU 6.2 Subordinate Enlistment

3.2.1.3.9 Ended

Ended is the final state.

3.2.1.4 CONNTYPE_TXUSER_DTCLURECOVERYINITIATEDBYDTC Initiator States

The LU 6.2 implementation (section 3.2) MUST act as an initiator for the CONNTYPE_TXUSER_DTCLURECOVERYINITIATEDBYDTC connection type. In this role, the LU 6.2 implementation MUST provide support for the following states:

- Idle
- Awaiting Response to Work Query
- Processing Cold XLN Request
- Processing Warm XLN Request
- Awaiting Response to XLN Confirmation
- Awaiting Response to XLN
- Awaiting Response to Compare States Query During Warm XLN
- XLN Exchange Complete
- Awaiting Response to Compare States Query
- Processing Compare States Request
- Awaiting Response to Compare States
- Processing LU Status Check
- Awaiting Request Complete
- Ended

The following figure shows the relationship between the CONNTYPE_TXUSER_DTCLURECOVERYINITIATEDBYDTC initiator states.

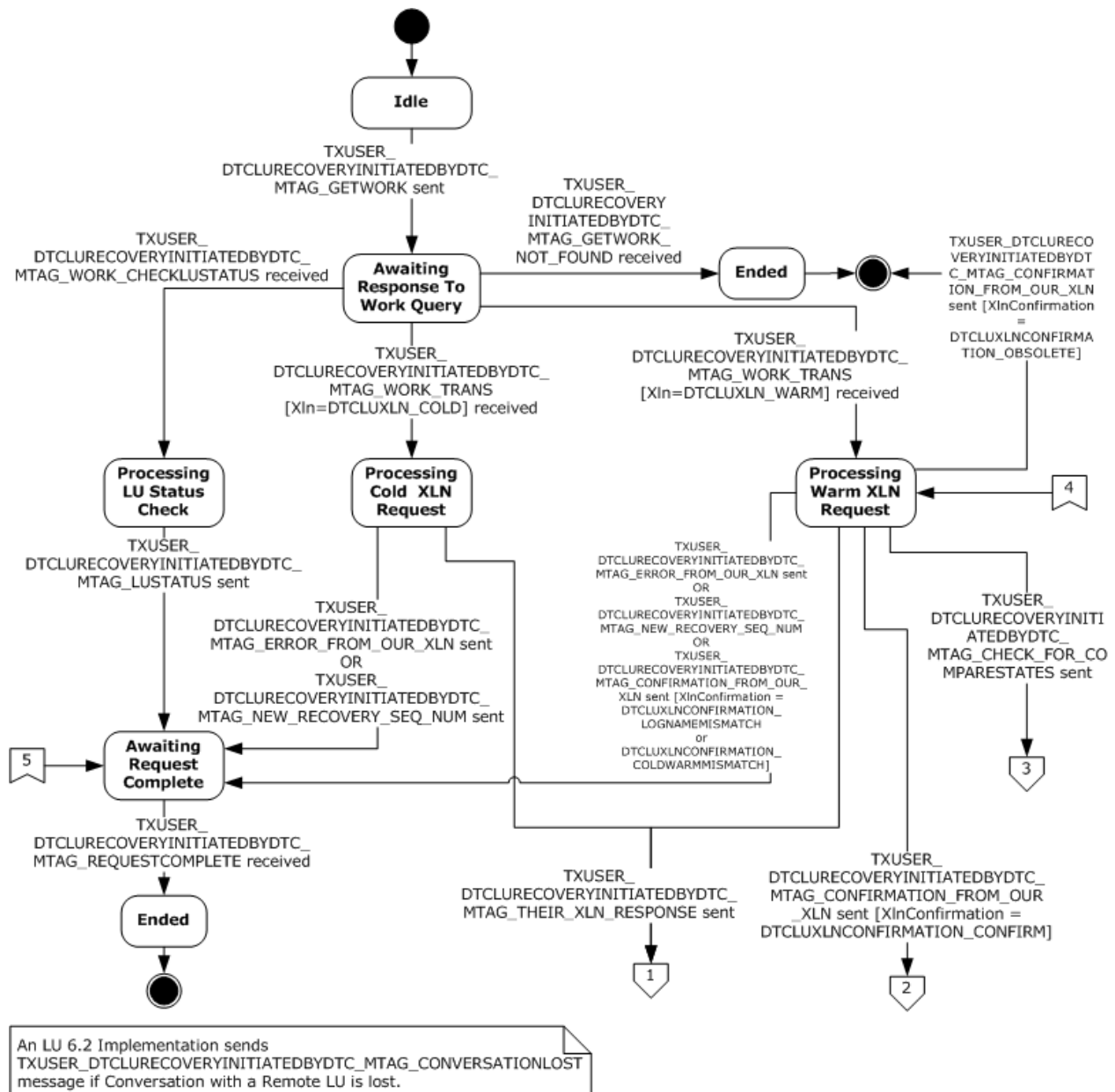

Figure 8: CONNTYPE_TXUSER_DTCLURECOVERYINITIATEDBYDTC initiator states, part 1

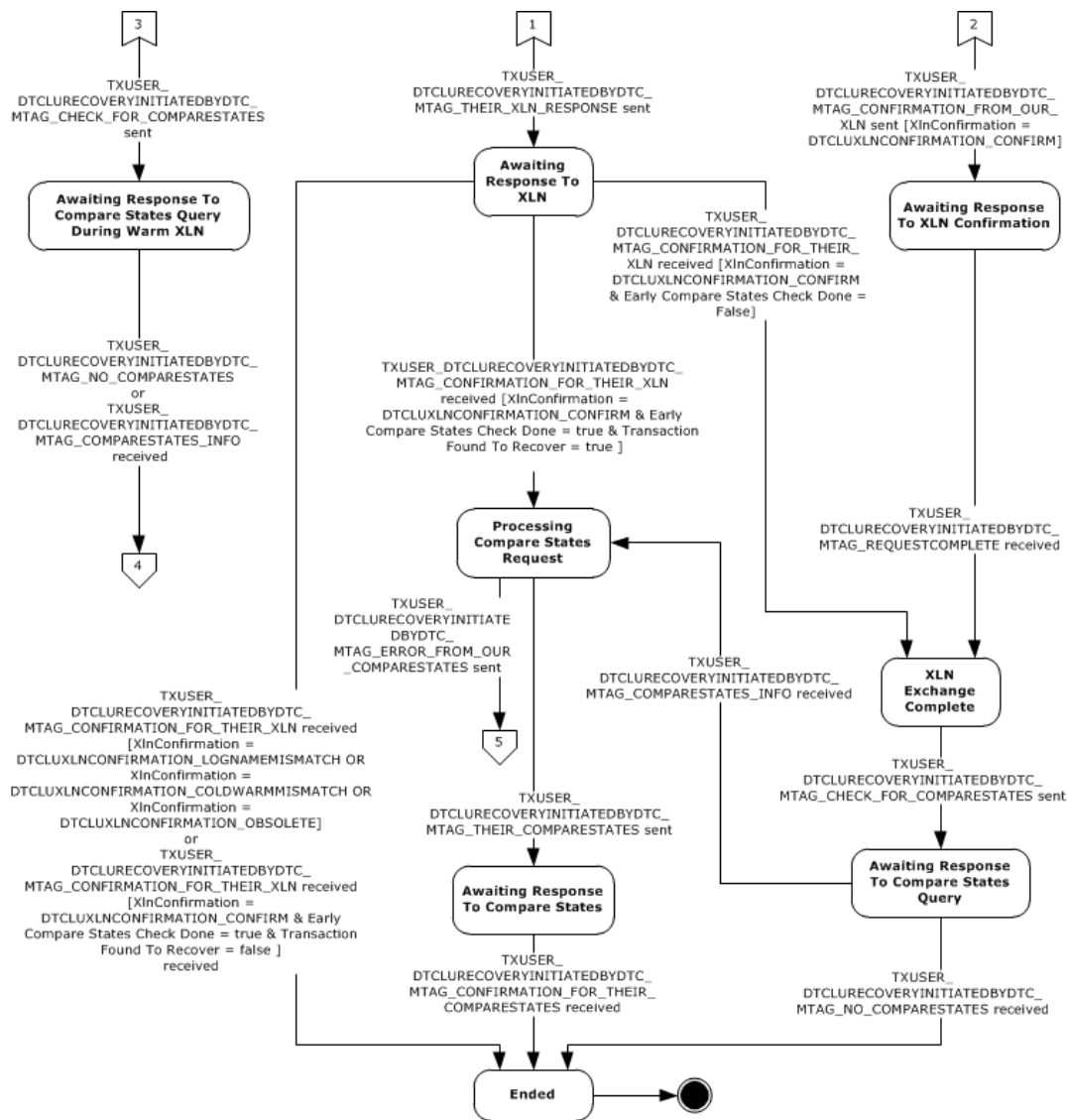

Figure 9: CONNTYPE_TXUSER_DTCLURECOVERYINITIATEDBYDTC initiator states, part 2

3.2.1.4.1 Idle

Idle is the initial state. The following events are processed in this state:

- Local LU Initiated Recovery Sending Query for Work
- Local LU Initiated Recovery Conversation Lost

3.2.1.4.2 Awaiting Response to Work Query

The following events are processed in the Awaiting Response to Work Query state:

- Receiving a TXUSER_DTCLURECOVERYINITIATEDBYDTC_MTAG_GETWORK_NOT_FOUND message
- Receiving a TXUSER_DTCLURECOVERYINITIATEDBYDTC_MTAG_WORK_CHECKLUSTATUS message
- Receiving a TXUSER_DTCLURECOVERYINITIATEDBYDTC_MTAG_WORK_TRANS message

- Local LU Initiated Recovery Conversation Lost
- Connection Disconnected

3.2.1.4.3 Processing Cold XLN Request

The following events are processed in the Processing Cold XLN Request state:

- Local LU Initiated Recovery Sending New Recovery Sequence Number
- Local LU Initiated Recovery Sending XLN Error
- Local LU Initiated Recovery Sending XLN Response
- Local LU Initiated Recovery Conversation Lost

3.2.1.4.4 Processing Warm XLN Request

The following events are processed in the Processing Warm XLN Request state:

- Local LU Initiated Recovery Sending New Recovery Sequence Number
- Local LU Initiated Recovery Sending XLN Error
- Local LU Initiated Recovery Sending XLN Confirmation
- Local LU Initiated Recovery Sending XLN Response
- Local LU Initiated Recovery Sending Compare-States Query
- Local LU Initiated Recovery Conversation Lost

3.2.1.4.5 Awaiting Response to XLN Confirmation

The following events are processed in the Awaiting Response to XLN Confirmation state:

- Receiving a TXUSER_DTCLURECOVERYINITIATEDBYDTC_MTAG_REQUESTCOMPLETE message
- Local LU Initiated Recovery Conversation Lost
- Connection Disconnected

3.2.1.4.6 Awaiting Response to XLN

The following events are processed in the Awaiting Response to XLN state:

- Receiving a TXUSER_DTCLURECOVERYINITIATEDBYDTC_MTAG_CONFIRMATION_FOR_THEIR_XLN message
- Local LU Initiated Recovery Conversation Lost
- Connection Disconnected

3.2.1.4.7 Awaiting Response to Compare States Query During Warm XLN

The following events are processed in the Awaiting Response to Compare States Query During Warm XLN state:

- Receiving a TXUSER_DTCLURECOVERYINITIATEDBYDTC_MTAG_NO_COMPARESTATES message
- Receiving a TXUSER_DTCLURECOVERYINITIATEDBYDTC_MTAG_COMPARESTATES_INFO message

- Local LU Initiated Recovery Conversation Lost
- Connection Disconnected

3.2.1.4.8 XLN Exchange Complete

The following events are processed in the XLN Exchange Complete state:

- Local LU Initiated Recovery Sending Compare States Query
- Local LU Initiated Recovery Conversation Lost

3.2.1.4.9 Awaiting Response to Compare States Query

The following events are processed in the Awaiting Response to Compare States Query state:

- Receiving a TXUSER_DTCLURECOVERYINITIATEDBYDTC_MTAG_NO_COMPARESTATES message
- Receiving a TXUSER_DTCLURECOVERYINITIATEDBYDTC_MTAG_COMPARESTATES_INFO message
- Local LU Initiated Recovery Conversation Lost
- Connection Disconnected

3.2.1.4.10 Processing Compare States Request

The following events are processed in the Processing Compare States Request state:

- Local LU Initiated Recovery Sending Compare States
- Local LU Initiated Recovery Sending Compare States Error
- Local LU Initiated Recovery Conversation Lost

3.2.1.4.11 Awaiting Response to Compare States

The following events are processed in Awaiting Response to Compare States state:

- Receiving a TXUSER_DTCLURECOVERYINITIATEDBYDTC_MTAG_CONFIRMATION_FOR_THEIR_COMPARESTATE S message
- Local LU Initiated Recovery Conversation Lost
- Connection Disconnected

3.2.1.4.12 Processing LU Status Check

The following events are processed in the Processing LU Status Check state:

- Local LU Initiated Recovery Sending LU Status
- Local LU Initiated Recovery Conversation Lost

3.2.1.4.13 Awaiting Request Complete

The following events are processed in the Awaiting Request Complete state:

- Receiving a TXUSER_DTCLURECOVERYINITIATEDBYDTC_MTAG_REQUESTCOMPLETE message
- Local LU Initiated Recovery Conversation Lost

- Connection Disconnected

3.2.1.4.14 Ended

Ended is the final state.

3.2.1.5 CONNTYPE_TXUSER_DTCLURECOVERYINITIATEDBYLU Initiator States

The LU 6.2 implementation (section 3.2) MUST act as an initiator for the CONNTYPE_TXUSER_DTCLURECOVERYINITIATEDBYLU connection type. In this role, the LU 6.2 implementation MUST provide support for the following states:

- Idle
- Awaiting Response to XLN Request
- Processing XLN Confirmation
- Awaiting Response to XLN Confirmation
- Awaiting Response to XLN Confirmation With Error
- XLN Exchange Complete
- Awaiting Response To Compare States
- Processing Compare States Response
- Awaiting Request Complete
- Ended

The following figure shows the relationship between the CONNTYPE_TXUSER_DTCLURECOVERYINITIATEDBYLU initiator states.

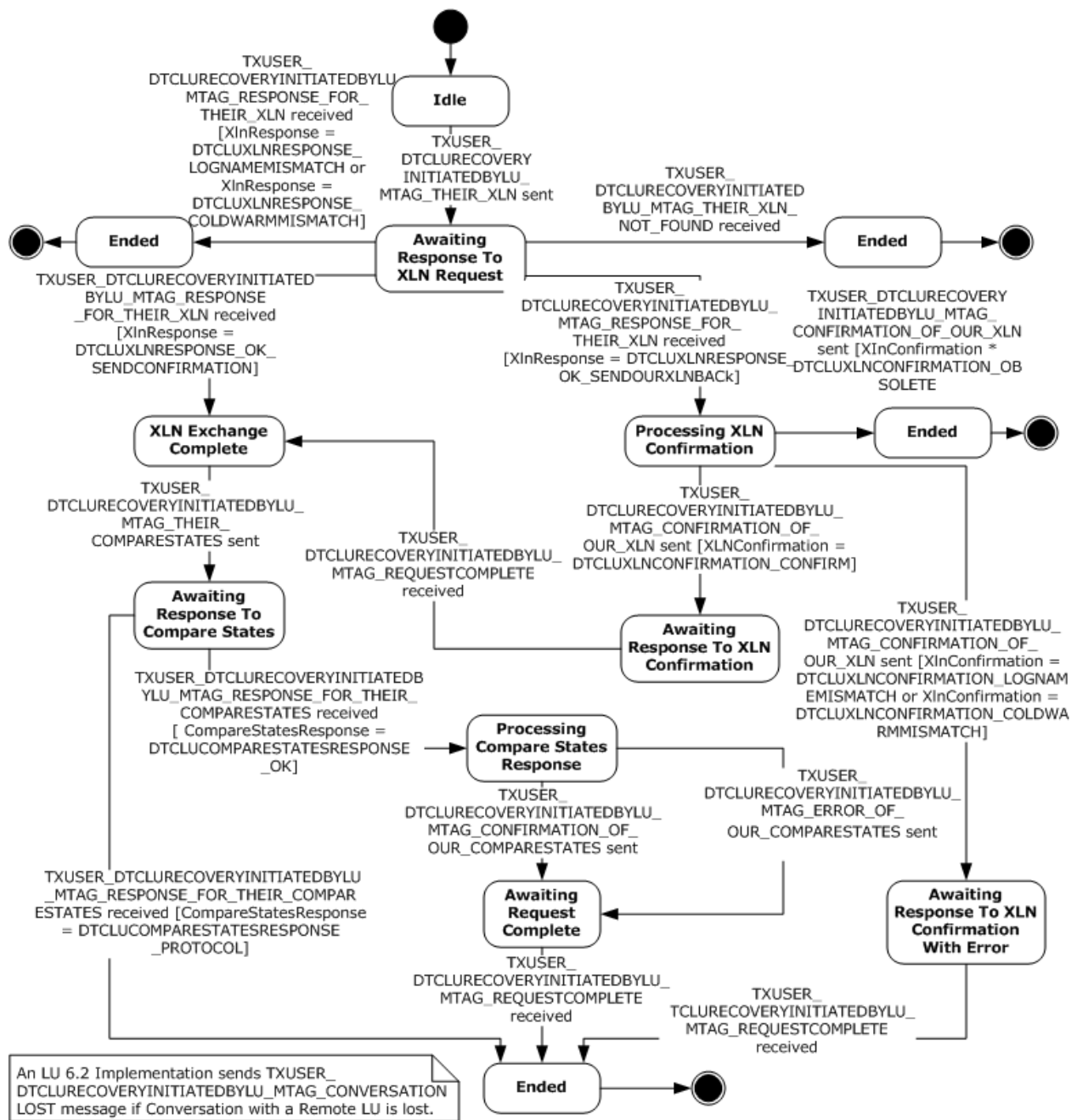

Figure 10: CONNTYPE_TXUSER_DTCLURECOVERYINITIATEDBYLU initiator states

3.2.1.5.1 Idle

Idle is the initial state. The following events are processed in this state:

- Remote LU Initiated Recovery Sending XLN
- Remote LU Initiated Recovery Conversation Lost

3.2.1.5.2 Awaiting Response to XLN Request

The following events are processed in the Awaiting Response to XLN Request state:

- Receiving a TXUSER_DTCLURECOVERYINITIATEDBYLU_MTAG_THEIR_XLN_NOT_FOUND message
- Receiving a TXUSER_DTCLURECOVERYINITIATEDBYLU_MTAG_RESPONSE_FOR_THEIR_XLN message
- Remote LU Initiated Recovery Conversation Lost
- Connection Disconnected (section 3.2.5.5.5)

3.2.1.5.3 Processing XLN Confirmation

The following events are processed in the Processing XLN Confirmation state:

- Remote LU Initiated Recovery Sending XLN Confirmation
- Remote LU Initiated Recovery Conversation Lost

3.2.1.5.4 Awaiting Response to XLN Confirmation

The following events are processed in the Awaiting Response to XLN Confirmation state:

- Receiving a TXUSER_DTCLURECOVERYINITIATEDBYLU_MTAG_REQUESTCOMPLETE message
- Remote LU Initiated Recovery Conversation Lost
- Connection Disconnected (section 3.2.5.5.5)

3.2.1.5.5 Awaiting Response to XLN Confirmation with Error

The following events are processed in the Awaiting Response to XLN Confirmation with Error state:

- Receiving a TXUSER_DTCLURECOVERYINITIATEDBYLU_MTAG_REQUESTCOMPLETE message
- Remote LU Initiated Recovery Conversation Lost
- Connection Disconnected (section 3.2.5.5.5)

3.2.1.5.6 XLN Exchange Complete

The following events are processed in the XLN Exchange Complete state:

- Remote LU Initiated Recovery Sending Compare States
- Remote LU Initiated Recovery Conversation Lost

3.2.1.5.7 Awaiting Response to Compare States

The following events are processed in the Awaiting Response to Compare States state:

- Receiving a TXUSER_DTCLURECOVERYINITIATEDBYLU_MTAG_RESPONSE_FOR_THEIR_COMPARESTATES message
- Remote LU Initiated Recovery Conversation Lost
- Connection Disconnected (section 3.2.5.5.5)

3.2.1.5.8 Processing Compare States Response

The following events are processed in the Processing Compare States Response state:

- Remote LU Initiated Recovery Sending Compare States Confirmation
- Remote LU Initiated Recovery Sending Compare States Error
- Remote LU Initiated Recovery Conversation Lost

3.2.1.5.9 Awaiting Request Complete

The following events are processed in the Awaiting Request Complete state:

- Receiving a TXUSER_DTCLURECOVERYINITIATEDBYLU_MTAG_REQUESTCOMPLETE message
- Remote LU Initiated Recovery Conversation Lost
- Connection Disconnected (section 3.2.5.5.5)

3.2.1.5.10 Ended

Ended is the final state.

3.2.2 Timers

None.

3.2.3 Initialization

When an LU 6.2 Implementation is initialized, the **Transaction Manager Name** field MUST be set to a value that is obtained from an implementation-specific source.

The **LU Transactions Enabled** flag is initialized by sending a TXUSER_GETSECURITYFLAGS_MTAG_GETSECURITYFLAGS message using the CONNTYPE_TXUSER_GETSECURITYFLAGS connection to the transaction manager as specified in section 3.3.4.11 in [MS-DTCO]. On receiving the **TXUSER_GETSECURITYFLAGS_MTAG_GETSECURITYFLAGS** message, the transaction manager responds with a TXUSER_GETSECURITYFLAGS_MTAG_FETCHED message, which indicates whether the transaction manager supports LU transactions by setting the **DTCADVCONFIG_OPTIONS_LUTRANSACTIONS_DISABLE** bit in the **grfOptions** field, as specified in section 3.4.5.4.1.1 in [MS-DTCO].

3.2.4 Higher-Layer Triggered Events

The LU 6.2 Implementation MUST be prepared to process a set of higher-layer events. These events are triggered by decisions that are made by the higher-layer business logic of the LU 6.2 Implementation. The motivations and details of the higher-layer business logic are specific to an LU 6.2 Implementation and the software environment in which it executes.

When an LU 6.2 Implementation processes one of these events, it MUST communicate a Success or Failure result to the higher-layer business logic. The LU 6.2 Implementation MUST be prepared to process the events in the following sections.

3.2.4.1 Adding an LU Name Pair

This event MUST be signaled by the higher-layer business logic with the LU Name Pair argument.

If the Adding an LU Name Pair event is signaled, the LU 6.2 Implementation MUST perform the following actions:

- Initiate a new CONNTYPE_TXUSER_DTCLUCONFIGURE connection using the **Transaction Manager Name** field of the LU 6.2 Implementation.
- Send a TXUSER_DTCLURMCONFIGURE_MTAG_ADD message using the connection:
 - The **cbLength** field of the DTCLU_VARLEN_BYTEARRAY structure (contained in the **LuNamePair** field) MUST be set to the number of bytes in the provided LU Name Pair.
 - The first **cbLength** bytes of the **rgbBlob** field of the DTCLU_VARLEN_BYTEARRAY structure (contained in the **LuNamePair** field) MUST be set to the provided LU Name Pair.
- Set the connection state to Awaiting Add Response.

3.2.4.2 Deleting an LU Name Pair

This event MUST be signaled by the higher-layer business logic with the LU Name Pair argument.

If the Deleting an LU Name Pair event is signaled, the LU 6.2 Implementation MUST perform the following actions:

- Initiate a new CONNTYPE_TXUSER_DTCLUCONFIGURE connection using the **Transaction Manager Name** field of the implementation.
- Send a TXUSER_DTCLURMCONFIGURE_MTAG_DELETE message using the connection:
 - The **cbLength** field of the DTCLU_VARLEN_BYTEARRAY structure (contained in the **LuNamePair** field) MUST be set to the number of bytes in the provided LU Name Pair.
 - The first **cbLength** bytes of the **rgbBlob** field of the DTCLU_VARLEN_BYTEARRAY structure (contained in the **LuNamePair** field) MUST be set to the provided LU Name Pair.
- Set the connection state to Awaiting Delete Response.

3.2.4.3 Registering Recovery Process For LU Pair

This event MUST be signaled by the higher-layer business logic with the LU Name Pair argument.

If the Registering Recovery Process For LU Pair event is signaled, the LU 6.2 Implementation MUST perform the following actions:

- Initiate a new CONNTYPE_TXUSER_DTCLURECOVERY connection using the **Transaction Manager Name** field of the LU 6.2 Implementation. Set the LU Name Pair of the CONNTYPE_TXUSER_DTCLURECOVERY connection to the LU Name Pair argument provided by the higher-layer business logic.
- Send a TXUSER_DTCLURMRECOVERY_MTAG_ATTACH message using the connection:
 - The **cbLength** field of the DTCLU_VARLEN_BYTEARRAY structure (contained in the **LuNamePair** field) MUST be set to the number of bytes in the provided LU Name Pair.
 - The first **cbLength** bytes of the **rgbBlob** field of the DTCLU_VARLEN_BYTEARRAY structure (contained in the **LuNamePair** field) MUST be set to the provided LU Name Pair.
- Set the connection state to Awaiting Register Response.

3.2.4.4 All Sessions Lost

This event MUST be signaled by the higher-layer business logic with the LU Name Pair argument.

If the All Sessions Lost event is signaled, the LU 6.2 Implementation MUST perform the following actions:

- Attempt to find the recovery sequence number keyed by the LU Name Pair in the Recovery Sequence Number Table.
- If the recovery sequence number is not found:
 - Return a failure result to the higher-layer business logic.
- Otherwise:
 - Increment the found recovery sequence number.

3.2.4.5 Creating LU 6.2 Subordinate Enlistment

This event MUST be signaled by the higher-layer business logic with the following arguments:

- **Transaction Object.Identifier** as defined in [MS-DTCO] section 3.1.1
- LU Name Pair
- LUW Identifier

If the Creating LU 6.2 Subordinate Enlistment event is signaled, the LU 6.2 Implementation MUST perform the following actions:

- Initiate a new CONNTYPE_TXUSER_DTCLURMENLISTMENT connection using the **Transaction Manager Name** field of the LU 6.2 Implementation.
- Send a TXUSER_DTCLURMENLISTMENT_MTAG_CREATE message using the connection:
 - The **guidTx** field MUST be set to the provided **Transaction Object.Identifier**.
 - The **cbLength** field of the DTCLU_VARLEN_BYTEARRAY structure (contained in the **LuNamePair** field) MUST be set to the number of bytes in the provided LU Name Pair.
 - The first **cbLength** bytes of the **rgbBlob** field of the DTCLU_VARLEN_BYTEARRAY structure (contained in the **LuNamePair** field) MUST be set to the provided LU Name Pair.
 - The **cbLength** field of the DTCLU_VARLEN_BYTEARRAY structure (contained in the **LuTransId** field) MUST be set to the number of bytes in the provided LUW identifier.
 - The first **cbLength** bytes of the **rgbBlob** field of the DTCLU_VARLEN_BYTEARRAY structure (contained in the **LuTransId** field) MUST be set to the provided LUW identifier.
- Set the connection state to Awaiting Enlistment Response.

3.2.4.6 Aborting LU 6.2 Subordinate Enlistment

This event MUST be signaled by the higher-layer business logic with the following arguments:

- A connection object of type CONNTYPE_TXUSER_DTCLURMENLISTMENT

If the Aborting LU 6.2 Subordinate Enlistment event is signaled, the LU 6.2 Implementation MUST perform the following actions:

- If the provided connection state is not set to Active:
 - Return a failure result to the higher-layer business logic.

- Otherwise:
 - Send a TXUSER_DTCLURMENLISTMENT_MTAG_TO_DTC_BACKOUT message using the provided connection.
 - Set the connection state to Awaiting Backout Response.

3.2.4.7 LU 6.2 Subordinate Enlistment Prepare Request Completed

This event MUST be signaled by the higher-layer business logic with the following arguments:

- A connection object of type CONNTYPE_TXUSER_DTCLURMENLISTMENT
- A request outcome value. This value MUST be one of the following:
 - Prepared
 - Aborted
 - Forget

If the LU 6.2 Subordinate Enlistment Prepare Request Completed event is signaled, the LU 6.2 Implementation MUST perform the following actions:

- If the provided connection state is not set to Preparing For Transaction Commit:
 - Return a failure result to the higher-layer business logic.
- Otherwise:
 - If the request outcome is Prepared:
 - Send a TXUSER_DTCLURMENLISTMENT_MTAG_TO_DTC_REQUESTCOMMIT message using the provided connection.
 - Set the connection state to Awaiting Transaction Outcome.
 - Otherwise, if the request outcome is Aborted:
 - Send a TXUSER_DTCLURMENLISTMENT_MTAG_TO_DTC_BACKOUT message using the provided connection.
 - Set the connection state to Awaiting Backout Response.
 - Otherwise, if the request outcome is Forget:
 - Send a TXUSER_DTCLURMENLISTMENT_MTAG_TO_DTC_FORGET message using the provided connection.
 - Set the connection state to Ended.

3.2.4.8 LU 6.2 Subordinate Enlistment Conversation Lost

This event MUST be signaled by the higher-layer business logic with the following argument:

- A connection object of type CONNTYPE_TXUSER_DTCLURMENLISTMENT

If the LU 6.2 Subordinate Enlistment Conversation Lost event is signaled, the LU 6.2 Implementation MUST perform the following actions:

- Send a TXUSER_DTCLURMENLISTMENT_MTAG_TO_DTC_CONVERSATIONLOST message using the provided connection.
- Set the connection state to Ended.

3.2.4.9 Unplugging LU 6.2 Subordinate Enlistment

This event MUST be signaled by the higher-layer business logic with the following argument:

- A connection object of type CONNTYPE_TXUSER_DTCLURMENLISTMENT

If the Unplugging LU 6.2 Subordinate Enlistment event is signaled, the LU 6.2 implementation (section 3.2) MUST perform the following actions:

- Send a TXUSER_DTCLURMENLISTMENT_MTAG_UNPLUG message using the provide connection.
- Set the connection state to Ended.

3.2.4.10 LU 6.2 Subordinate Enlistment Abort Request Completed

This event MUST be signaled by the higher-layer business logic with the following argument:

- A connection object of type CONNTYPE_TXUSER_DTCLURMENLISTMENT.

If the LU 6.2 Subordinate Enlistment Abort Request Completed event is signaled, the LU 6.2 implementation (section 3.2) MUST perform the following actions:

- If the provided connection state is not set to Finalizing Abort Operations:
 - Return a failure result to the higher-layer business logic.
- Otherwise:
 - Send a TXUSER_DTCLURMENLISTMENT_MTAG_TO_DTC_BACKEDOUT message using the provided connection.
 - Set the connection state to Ended.

3.2.4.11 LU 6.2 Subordinate Enlistment Commit Request Completed

This event MUST be signaled by the higher-layer business logic with the following argument:

- A connection object of type CONNTYPE_TXUSER_DTCLURMENLISTMENT

If the LU 6.2 Subordinate Enlistment Commit Request Completed event is signaled, the LU 6.2 implementation (section 3.2) MUST perform the following actions:

- If the provided connection state is not set to Finalizing Commit Operations:
 - Return a failure result to the higher-layer business logic.
- Otherwise:
 - Send a TXUSER_DTCLURMENLISTMENT_MTAG_TO_DTC_FORGET message using the provided connection.
 - Set the connection state to Ended.

3.2.4.12 LU 6.2 Subordinate Enlistment Single-Phase Commit Request Completed

This event MUST be signaled by the higher-layer business logic with the following argument:

- A connection object of type CONNTYPE_TXUSER_DTCLURMENLISTMENT

If the LU 6.2 Subordinate Enlistment Commit Request Completed event is signaled, the LU 6.2 implementation (section 3.2) MUST perform the following action:

- Send a TXUSER_DTCLURMENLISTMENT_MTAG_TO_DTC_COMMITTED message using the provided connection.

3.2.4.13 Local LU Initiated Recovery Sending Query For Work

This event MUST be signaled by the higher-layer business logic with the LU Name Pair argument.

If the Local LU Initiated Recovery Sending Query For Work event is signaled, the LU 6.2 implementation (section 3.2) MUST perform the following actions:

- Initiate a new CONNTYPE_TXUSER_DTCLURECOVERYINITIATEDBYDTC connection using the **Transaction Manager Name** field of the LU 6.2 implementation. Set the **Early Compare States Check Done** and **Transaction Found To Recover** flags of the CONNTYPE_TXUSER_DTCLURECOVERYINITIATEDBYDTC connection object to FALSE.
- Send a TXUSER_DTCLURECOVERYINITIATEDBYDTC_MTAG_GETWORK message using the provided connection:
 - The **cbLength** field of the DTCLU_VARLEN_BYTEARRAY structure (contained in the **LuNamePair** field) MUST be set to the number of bytes in the provided LU Name Pair.
 - The first **cbLength** bytes of the **rgbBlob** field of the DTCLU_VARLEN_BYTEARRAY structure (contained in the **LuNamePair** field) MUST be set to the provided LU Name Pair.
- Set the connection state to Awaiting Response To Work Query.

3.2.4.14 Local LU Initiated Recovery Sending New Recovery Sequence Number

This event MUST be signaled by the higher-layer business logic with the following arguments:

- A connection object of type CONNTYPE_TXUSER_DTCLURECOVERYINITIATEDBYDTC
- New Recovery Sequence Number

If the Local LU Initiated Recovery Sending New Recovery Sequence Number event is signaled, the LU 6.2 implementation (section 3.2) MUST perform the following actions:

- If the provided connection state is not set to either Processing Cold XLN Request or Processing Warm XLN Request:
 - Return a failure result to the higher-layer business logic.
- Otherwise:
 - Attempt to find the recovery sequence number keyed by the LU Name Pair in the Recovery Sequence Number Table.
 - If the recovery sequence number is not found:
 - Return a failure to the higher-layer business logic.

- Otherwise:
 - Update the recovery sequence number keyed by the LU Name Pair in the Recovery Sequence Number Table with the provided new recovery sequence number.
 - Send a TXUSER_DTCLURECOVERYINITIATEDBYDTC_MTAG_NEW_RECOVERY_SEQ_NUM message using the provided connection:
 - The **RecoverySeqNum** field MUST be set to the provided new recovery sequence number.
 - Set the connection state to Awaiting Request Complete.

3.2.4.15 Local LU Initiated Recovery Sending XLN Error

This event MUST be signaled by the higher-layer business logic with the following arguments:

- A connection object of type CONNTYPE_TXUSER_DTCLURECOVERYINITIATEDBYDTC
- An Error Reason value, which MUST be set to one of the following values:
 - Log Name Mismatch
 - Cold Warm Mismatch
 - Protocol Error

If the Local LU Initiated Recovery Sending XLN Error event is signaled, the LU 6.2 implementation (section 3.2) MUST perform the following actions:

- If the provided connection state is not set to either Processing Cold XLN Request or Processing Warm XLN Request:
 - Return a failure result to the higher-layer business logic.
- Otherwise:
 - Send a TXUSER_DTCLURECOVERYINITIATEDBYDTC_MTAG_ERROR_FROM_OUR_XLN message using the provided connection:
 - The **XlnError** field MUST be set to one of the following elements of the DTCLUXLNERROR enumeration:
 - DTCLUXLNERROR_LOGNAMEMISMATCH if the provided Error Reason value is Log Name Mismatch
 - DTCLUXLNERROR_COLDWARMISMATCH if the provided Error Reason value is Cold Warm Mismatch
 - DTCLUXLNERROR_PROTOCOL if the provided Error Reason value is Protocol Error
 - Set the connection state to Awaiting Request Complete.

3.2.4.16 Local LU Initiated Recovery Sending XLN Response

This event MUST be signaled by the higher-layer business logic with the following arguments:

- A connection object of type CONNTYPE_TXUSER_DTCLURECOVERYINITIATEDBYDTC
- Remote Log Status value, which MUST be set to one of the following values:

- Warm
- Cold
- Remote Log Name

If the Local LU Initiated Recovery Sending XLN Response event is signaled, the LU 6.2 implementation MUST perform the following actions:

- If the provided connection state is not set to either Processing Cold XLN Request or Processing Warm XLN Request:
 - Return a failure result to the higher-layer business logic.
- Otherwise:
 - Send a TXUSER_DTCLURECOVERYINITIATEDBYDTC_MTAG_THEIR_XLN_RESPONSE message using the provided connection:
 - The **Xln** field MUST be set to one of the following elements of the DTCLUXLN enumeration:
 - DTCLUXLN_WARM if the provided Remote Log Status value is Warm
 - DTCLUXLN_COLD if the provided Remote Log Status value is Cold
 - The **dwProtocol** field MUST be set to 0.
 - The **cbLength** field of the DTCLU_VARLEN_BYTEARRAY structure (contained in the **RemoteLogName** field) MUST be set to the number of bytes in the provided remote log name.
 - The first **cbLength** bytes of the **rgbBlob** field of the DTCLU_VARLEN_BYTEARRAY structure (contained in the **RemoteLogName** field) MUST be set to the provided remote log name.
 - Set the connection state to Awaiting Response To XLN.

3.2.4.17 Local LU Initiated Recovery Sending XLN Confirmation

This event MUST be signaled by the higher-layer business logic with the following arguments:

- A connection object of type CONNTYPE_TXUSER_DTCLURECOVERYINITIATEDBYDTC
- An XLN Response value, which MUST be set to one of the following values:
 - Confirm
 - Log Name Mismatch
 - Cold Warm Mismatch
 - Obsolete

If the Local LU Initiated Recovery Sending XLN Confirmation event is signaled, the LU 6.2 implementation (section 3.2) MUST perform the following actions:

- If the provided connection state is not set to Processing Warm XLN Request:
 - Return a failure result to the higher-layer business logic.
- Otherwise:

- Send a TXUSER_DTCLURECOVERYINITIATEDBYDTC_MTAG_CONFIRMATION_FROM_OUR_XLN message using the provided connection:
 - The **XlnConfirmation** field MUST be set to one of the following elements of the DTCLUXLNCONFIRMATION enumeration:
 - DTCLUXLNCONFIRMATION_CONFIRM if the provided XLN Response value is Confirm
 - DTCLUXLNCONFIRMATION_LOGNAMEMISMATCH if the provided XLN Response value is Log Name Mismatch
 - DTCLUXLNCONFIRMATION_COLDWARMISMATCH if the provided XLN Response value is Cold Warm Mismatch
 - DTCLUXLNCONFIRMATION_OBSOLETE if the provided XLN Response value is Obsolete
 - If the provided XLN Response value is Confirm:
 - Set the connection state to Awaiting Response To XLN Confirmation.
 - Otherwise, if the provided XLN Response value is either Log Name Mismatch or Cold Warm Mismatch:
 - Set the connection state to Awaiting Request Complete.
 - Otherwise:
 - Set the connection state to Ended.

3.2.4.18 Local LU Initiated Recovery Sending Compare States Query

This event MUST be signaled by the higher-layer business logic with the following argument:

- A connection object of type CONNTYPE_TXUSER_DTCLURECOVERYINITIATEDBYDTC

If the Local LU Initiated Recovery Sending Compare States Query event is signaled, the LU 6.2 implementation (section 3.2) MUST perform the following actions:

- If the provided connection state is not set to either Processing Warm XLN Request or XLN Exchange Complete:
 - Return a failure result to the higher-layer business logic.
- Otherwise:
 - If the connection state is Processing Warm XLN Request:
 - Send a TXUSER_DTCLURECOVERYINITIATEDBYDTC_MTAG_CHECK_FOR_COMPARESTATES message using the provided connection.
 - Set the Early Compare States Check Done field of the connection object to TRUE.
 - Set the connection state to Awaiting Response To Compare States Query During Warm XLN.
 - Otherwise, if the connection state is XLN Exchange Complete:
 - Send a TXUSER_DTCLURECOVERYINITIATEDBYDTC_MTAG_CHECK_FOR_COMPARESTATES message using the provided connection.
 - Set the connection state to Awaiting Response To Compare States Query.

3.2.4.19 Local LU Initiated Recovery Sending Compare States

This event MUST be signaled by the higher-layer business logic with the following arguments:

- A connection object of type CONNTYPE_TXUSER_DTCLURECOVERYINITIATEDBYDTC
- A **LUW Status** value, which MUST be set to one of the following values:
 - Committed
 - Heuristic Committed
 - Heuristic Mixed
 - Heuristic Reset
 - In Doubt
 - Reset

If the Local LU Initiated Recovery Sending Compare States event is signaled, the LU 6.2 implementation (section 3.2) MUST perform the following actions:

- If the provided connection state is not set to Processing Compare States Request:
 - Return a failure result to the higher-layer business logic.
- Otherwise:
 - Send a TXUSER_DTCLURECOVERYINITIATEDBYDTC_MTAG_THEIR_COMPARESTATES message using the provided connection:
 - The **CompareStates** field MUST be set to one of the following elements of the DTCLUCOMPARESTATE enumeration:
 - DTCLUCOMPARESTATE_COMMITTED if the provided LUW Status value is Committed
 - DTCLUCOMPARESTATE_HEURISTICCOMMITTED if the provided LUW Status value is Heuristic Committed
 - DTCLUCOMPARESTATE_HEURISTICMIXED if the provided LUW Status value is Heuristic Mixed
 - DTCLUCOMPARESTATE_HEURISTICRESET if the provided LUW Status value is Heuristic Reset
 - DTCLUCOMPARESTATE_INDOUBT if the provided LUW Status value is In Doubt
 - DTCLUCOMPARESTATE_RESET if the provided LUW Status value is Reset
 - Set the connection state to Awaiting Response To Compare States.

3.2.4.20 Local LU Initiated Recovery Sending Compare States Error

This event MUST be signaled by the higher-layer business logic with the following argument:

- A connection object of type CONNTYPE_TXUSER_DTCLURECOVERYINITIATEDBYDTC

If the Local LU Initiated Recovery Sending Compare States Error event is signaled, the LU 6.2 implementation (section 3.2) MUST perform the following actions:

- If the provided connection state is not set to Processing Compare States Request:

- Return a failure result to the higher-layer business logic.
- Otherwise:
 - Send a TXUSER_DTCLURECOVERYINITIATEDBYDTC_MTAG_ERROR_FROM_OUR_COMPARESTATES message using the provided connection:
 - The **CompareStatesError** field MUST be set to DTCLUCOMPARESTATESERROR_PROTOCOL.
 - Set the connection state to Awaiting Request Complete.

3.2.4.21 Local LU Initiated Recovery Sending LU Status

This event MUST be signaled by the higher-layer business logic with the following arguments:

- A connection object of type CONNTYPE_TXUSER_DTCLURECOVERYINITIATEDBYDTC
- LU Name Pair

If the Local LU Initiated Recovery Sending LU Status event is signaled, the LU 6.2 implementation (section 3.2) MUST perform the following actions:

- If the provided connection state is not set to Processing LU Status Check:
 - Return a failure result to the higher-layer business logic.
- Otherwise:
 - Attempt to find the recovery sequence number keyed by the LU Name Pair in the Recovery Sequence Number Table.
 - If the recovery sequence number is not found:
 - Return a failure result to the higher-layer business logic.
 - Otherwise:
 - Send a TXUSER_DTCLURECOVERYINITIATEDBYDTC_MTAG_LUSTATUS message using the provided connection:
 - The **RecoverySeqNum** field MUST be set to the found recovery sequence number.
 - Set the connection state to Awaiting Request Complete.

3.2.4.22 Local LU Initiated Recovery Conversation Lost

This event MUST be signaled by the higher-layer business logic with the following argument:

- A connection object of type CONNTYPE_TXUSER_DTCLURECOVERYINITIATEDBYDTC

If the Local LU Initiated Recovery Conversation Lost event is signaled, the LU 6.2 implementation (section 3.2) MUST perform the following actions:

- Send a TXUSER_DTCLURECOVERYINITIATEDBYDTC_MTAG_CONVERSATION_LOST message using the provided connection.
- Set the connection state to Ended.

3.2.4.23 Remote LU Initiated Recovery Sending XLN

This event MUST be signaled by the higher-layer business logic with the following arguments:

- A **Remote Log Status** value. This value MUST be one of the following:
 - Warm
 - Cold
- Remote Log Name
- Local Log Name supplied by a remote LU
- LU Name Pair

If the Remote LU Initiated Recovery Sending XLN event is signaled, the LU 6.2 Implementation MUST perform the following actions:

- Attempt to find the recovery sequence number keyed by the LU Name Pair in the Recovery Sequence Number Table.
- If the recovery sequence number is not found:
 - Return a failure result to the higher-layer business logic.
- Otherwise:
 - Initiate a new CONNTYPE_TXUSER_DTCLURECOVERYINITIATEDBYLU connection using the **Transaction Manager Name** field of the LU 6.2 Implementation. Set the **LU Pair** field of the CONNTYPE_TXUSER_DTCLURECOVERYINITIATEDBYLU connection object to the provided LU Name Pair. Set the **LUW To Recover** field of the CONNTYPE_TXUSER_DTCLURECOVERYINITIATEDBYLU connection object to null.
 - Send a TXUSER_DTCLURECOVERYINITIATEDBYLU_MTAG_THEIR_XLN message using the connection:
 - The **RecoverySeqNum** field MUST be set to the found recovery sequence number.
 - The **Xln** field MUST be set to one of the following elements of the DTCLUXLN enumeration:
 - DTCLUXLN_WARM if the provided **Remote Log Status** value is Warm.
 - DTCLUXLN_COLD if the provided **Remote Log Status** value is Cold.
 - The **dwProtocol** field MUST be set to 0.
 - The **cbLength** field of the DTCLU_VARLEN_BYTEARRAY structure (contained in the **RemoteLogName** field) MUST be set to the number of bytes in the provided remote log name.
 - The first **cbLength** bytes of the **rgbBlob** field of the DTCLU_VARLEN_BYTEARRAY structure (contained in the **RemoteLogName** field) MUST be set to the provided remote log name.
 - The **cbLength** field of the DTCLU_VARLEN_BYTEARRAY structure (contained in the **OurLogName** field) MUST be set to the number of bytes in the provided local log name supplied by the remote LU.
 - The first **cbLength** bytes of the **rgbBlob** field of the DTCLU_VARLEN_BYTEARRAY structure (contained in the **OurLogName** field) MUST be set to the provided local log name supplied by the remote LU.

- The **cbLength** field of the DTCLU_VARLEN_BYTEARRAY structure (contained in the **LuNamePair** field) MUST be set to the number of bytes in the provided LU Name Pair.
- The first **cbLength** bytes of the **rgbBlob** field of the DTCLU_VARLEN_BYTEARRAY structure (contained in the **LuNamePair** field) MUST be set to the provided LU Name Pair.
- Set the connection state to Awaiting Response To XLN Request.

3.2.4.24 Remote LU Initiated Recovery Sending XLN Confirmation

This event MUST be signaled by the higher-layer business logic with the following arguments:

- A connection object of type CONNTYPE_TXUSER_DTCLURECOVERYINITIATEDBYLU
- An **XLN Response** value. This value MUST be one of the following:
 - Confirm
 - Log Name Mismatch
 - Cold Warm Mismatch
 - Obsolete

If the Remote LU Initiated Recovery Sending XLN Confirmation event is signaled, the LU 6.2 implementation (section 3.2) MUST perform the following actions:

- If the provided connection state is not set to Processing XLN Confirmation:
 - Return a failure result to the higher-layer business logic.
- Otherwise:
 - Send a TXUSER_DTCLURECOVERYINITIATEDBYLU_MTAG_CONFIRMATION_OF_OUR_XLN message using the provided connection:
 - The **XlnConfirmation** field MUST be set to one of the following elements of the DTCLUXLNCONFIRMATION enumeration:
 - DTCLUXLNCONFIRMATION_CONFIRM if the provided XLN Response value is Confirm.
 - DTCLUXLNCONFIRMATION_LOGNAMEMISMATCH if the provided XLN Response value is Log Name Mismatch.
 - DTCLUXLNCONFIRMATION_COLDWARMISMATCH if the provided XLN Response value is Cold Warm Mismatch.
 - DTCLUXLNCONFIRMATION_OBSOLETE if the provided XLN Response value is Obsolete.
 - If the provided XLN Response value is set to Confirm:
 - Set the connection state to Awaiting Response To XLN Confirmation.
 - Otherwise, if the provided XLN Response value is set to Log Name Mismatch or Cold Warm Mismatch:
 - Set the connection state to Awaiting Response To XLN Confirmation With Error.
 - Otherwise, if the provided XLN Response value is set to Obsolete:
 - Set the connection state to Ended.

3.2.4.25 Remote LU Initiated Recovery Sending Compare States

This event MUST be signaled by the higher-layer business logic with the following arguments:

- A connection object of type CONNTYPE_TXUSER_DTCLURECOVERYINITIATEDBYLU
- A **Remote LUW Status** value. This value MUST be one of the following:
 - Committed
 - Heuristic Committed
 - Heuristic Mixed
 - Heuristic Reset
 - In Doubt
 - Reset
- LUW Identifier

If the Remote LU Initiated Recovery Sending Compare States event is signaled, the LU 6.2 implementation (section 3.2) MUST perform the following actions:

- If the provided connection state is not set to XLN Exchange Complete:
 - Return a failure result to the higher-layer business logic.
- Otherwise:
 - Send a TXUSER_DTCLURECOVERYINITIATEDBYLU_MTAG_THEIR_COMPARESTATES message using the provided connection:
 - The **CompareStates** field MUST be set to one of the following DTCLUCOMPARESTATE values:
 - DTCLUCOMPARESTATE_COMMITTED if the provided **Remote LUW Status** value is Committed
 - DTCLUCOMPARESTATE_HEURISTICCOMMITTED if the provided **Remote LUW Status** value is Heuristic Committed
 - DTCLUCOMPARESTATE_HEURISTICMIXED if the provided **Remote LUW Status** value is Heuristic Mixed
 - DTCLUCOMPARESTATE_HEURISTICRESET if the provided **Remote LUW Status** value is Heuristic Reset
 - DTCLUCOMPARESTATE_INDOUBT if the provided **Remote LUW Status** value is In Doubt
 - DTCLUCOMPARESTATE_RESET if the provided **Remote LUW Status** value is Reset
 - The **cbLength** field of the DTCLU_VARLEN_BYTEARRAY structure (contained in the **LuTransId** field) MUST be set to the number of bytes in the provided LUW identifier.
 - The first **cbLength** bytes of the **rgbBlob** field of the DTCLU_VARLEN_BYTEARRAY structure (contained in the **LuTransId** field) MUST be set to the provided LUW identifier.
 - Set the connection state to Awaiting Response To Compare States.

3.2.4.26 Remote LU Initiated Recovery Sending Compare States Confirmation

This event MUST be signaled by the higher-layer business logic with the following arguments:

- A connection object of type CONNTYPE_TXUSER_DTCLURECOVERYINITIATEDBYLU
- A **Compare States Confirmation** value. This value MUST be one of the following:
 - Confirm
 - Protocol Error

If the Remote LU Initiated Recovery Sending Compare States Confirmation event is signaled, the LU 6.2 implementation (section 3.2) MUST perform the following actions:

- If the provided connection state is not set to Processing Compare States Response:
 - Return a failure result to the higher-layer business logic.
- Otherwise:
 - Send a TXUSER_DTCLURECOVERYINITIATEDBYLU_MTAG_CONFIRMATION_OF_OUR_COMPARESTATES message using the provided connection:
 - The **CompareStatesConfirmation** field MUST be set to one of the following elements of the DTCLUCOMPARESTATESCONFIRMATION enumeration:
 - DTCLUCOMPARESTATESCONFIRMATION_CONFIRM if the provided Compare States Confirmation value is Confirm
 - DTCLUCOMPARESTATESCONFIRMATION_PROTOCOL if the provided Compare States Confirmation value is Protocol Error
 - The connection state SHOULD be set to Awaiting Request Complete.

3.2.4.27 Remote LU Initiated Recovery Sending Compare States Error

This event MUST be signaled by the higher-layer business logic with the following argument:

- A connection object of type CONNTYPE_TXUSER_DTCLURECOVERYINITIATEDBYLU

If the Remote LU Initiated Recovery Sending Compare States Error event is signaled, the LU 6.2 implementation (section 3.2) MUST perform the following actions:

- If the provided connection state is not set to Processing Compare States Response:
 - Return a failure result to the higher-layer business logic.
- Otherwise:
 - Send a TXUSER_DTCLURECOVERYINITIATEDBYLU_MTAG_ERROR_OF_OUR_COMPARESTATES message using the provided connection:
 - The **CompareStatesError** field MUST be set to DTCLUCOMPARESTATESERROR_PROTOCOL.
 - Set the connection state to Awaiting Request Complete.

3.2.4.28 Remote LU Initiated Recovery Conversation Lost

This event MUST be signaled by the higher-layer business logic with the following argument:

- A connection object of type CONNTYPE_TXUSER_DTCLURECOVERYINITIATEDBYLU

If the Remote LU Initiated Recovery Conversation Lost event is signaled, the LU 6.2 implementation (section 3.2) MUST perform the following actions:

- Send a TXUSER_DTCLURECOVERYINITIATEDBYLU_MTAG_CONVERSATION_LOST message using the provided connection.
- Set the connection state to Ended.

3.2.5 Message Processing Events and Sequencing Rules

3.2.5.1 CONNTYPE_TXUSER_DTCLUCONFIGURE as Initiator

For all messages that are received in this connection type, the LU 6.2 implementation (section 3.2) MUST process the message as specified in section 3.1. The LU 6.2 implementation MUST additionally follow the processing rules specified in the following sections.

3.2.5.1.1 Receiving a TXUSER_DTCLURMCONFIGURE_MTAG_ADD_DUPLICATE Message

When the LU 6.2 implementation (section 3.2) receives a TXUSER_DTCLURMCONFIGURE_MTAG_ADD_DUPLICATE message, it MUST perform the following actions:

- If the connection state is Awaiting Add Response:
 - Return a failure result to the higher-layer business logic.
 - Set the connection state to Ended.
- Otherwise, the message MUST be processed as an invalid message, as specified in [MS-DTCO], section 3.1.6.

3.2.5.1.2 Receiving a TXUSER_DTCLURMCONFIGURE_MTAG_DELETE_NOT_FOUND Message

When the LU 6.2 implementation (section 3.2) receives a TXUSER_DTCLURMCONFIGURE_MTAG_DELETE_NOT_FOUND message, it MUST perform the following actions:

- If the connection state is Awaiting Delete Response:
 - Return a failure result to the higher-layer business logic.
 - Set the connection state to Ended.
- Otherwise, the message MUST be processed as an invalid message, as specified in [MS-DTCO], section 3.1.6.

3.2.5.1.3 Receiving a TXUSER_DTCLURMCONFIGURE_MTAG_DELETE_UNRECOVERED_TRANS Message

When the LU 6.2 implementation (section 3.2) receives a TXUSER_DTCLURMCONFIGURE_MTAG_DELETE_UNRECOVERED_TRANS message, it MUST perform the following actions:

- If the connection state is Awaiting Delete Response:
 - Return a failure result to the higher-layer business logic.
 - Set the connection state to Ended.
- Otherwise, the message MUST be processed as an invalid message, as specified in [MS-DTCO], section 3.1.6.

3.2.5.1.4 Receiving a TXUSER_DTCLURMCONFIGURE_MTAG_DELETE_INUSE Message

When the LU 6.2 implementation (section 3.2) receives a TXUSER_DTCLURMCONFIGURE_MTAG_DELETE_INUSE message, it MUST perform the following actions:

- If the connection state is Awaiting Delete Response:
 - Return a failure result to the higher-layer business logic.
 - Set the connection state to Ended.
- Otherwise, the message MUST be processed as an invalid message, as specified in [MS-DTCO], section 3.1.6.

3.2.5.1.5 Receiving a TXUSER_DTCLURMCONFIGURE_MTAG_REQUEST_COMPLETED Message

When the LU 6.2 implementation (section 3.2) receives a TXUSER_DTCLURMCONFIGURE_MTAG_REQUEST_COMPLETED message, it MUST perform the following actions:

- If the connection state is either Awaiting Add Response or Awaiting Delete Response:
 - Return a success result to the higher-layer business logic.
 - Set the connection state to Ended.
- Otherwise, the message MUST be processed as an invalid message, as specified in [MS-DTCO], section 3.1.6.

3.2.5.1.6 Receiving a TXUSER_DTCLURMCONFIGURE_MTAG_ADD_LOG_FULL Message

When the LU 6.2 implementation (section 3.2) receives a TXUSER_DTCLURMCONFIGURE_MTAG_ADD_LOG_FULL message, it MUST perform the following actions:

- If the connection state is Awaiting Add Response:
 - Return a failure result to the higher-layer business logic.
 - Set the connection state to Ended.
- Otherwise, the message MUST be processed as an invalid message, as specified in [MS-DTCO], section 3.1.6.

3.2.5.1.7 Connection Disconnected

When a CONNTYPE_TXUSER_DTCLUCONFIGURE is disconnected, the LU 6.2 implementation (section 3.2) MUST perform the following actions:

- If the connection state is either Awaiting Add Response or Awaiting Delete Response:
 - Return a failure result to the higher-layer business logic.
- Otherwise, the event MUST be processed as specified in section 3.1.8.

3.2.5.2 CONNTYPE_TXUSER_DTCLURECOVERY as Initiator

For all messages that are received in this connection type, the LU 6.2 implementation (section 3.2) MUST process the message, as specified in section 3.1. The LU 6.2 Implementation MUST additionally follow the processing rules as specified in the following sections.

3.2.5.2.1 Receiving a TXUSER_DTCLURMRECOVERY_MTAG_ATTACH_NOT_FOUND Message

When the LU 6.2 implementation (section 3.2) receives a TXUSER_DTCLURMRECOVERY_MTAG_ATTACH_NOT_FOUND message, it MUST perform the following actions:

- If the connection state is Awaiting Register Response:
 - Return a failure result to the higher-layer business logic.
 - Set the connection state to Ended.
- Otherwise, the message MUST be processed as an invalid message, as specified in [MS-DTCO], section 3.1.6.

3.2.5.2.2 Receiving a TXUSER_DTCLURMRECOVERY_MTAG_ATTACH_DUPLICATE Message

When the LU 6.2 implementation (section 3.2) receives a TXUSER_DTCLURMRECOVERY_MTAG_ATTACH_DUPLICATE message, it MUST perform the following actions:

- If the connection state is Awaiting Register Response:
 - Return a failure result to the higher-layer business logic.
 - Set the connection state to Ended.
- Otherwise, the message MUST be processed as an invalid message, as specified in [MS-DTCO], section 3.1.6.

3.2.5.2.3 Receiving a TXUSER_DTCLURMRECOVERY_MTAG_REQUEST_COMPLETED Message

When the LU 6.2 implementation (section 3.2) receives a TXUSER_DTCLURMRECOVERY_MTAG_REQUEST_COMPLETED message, it MUST perform the following actions:

- If the connection state is Awaiting Register Response:
 - Add an entry for the LU Name Pair associated with the connection object in the Recovery Sequence Number Table with the recovery sequence number initialized to 1.

- Return a success result to the higher-layer business logic.
- Set the connection state to Registered.
- Otherwise, the message MUST be processed as an invalid message, as specified in [MS-DTCO], section 3.1.6.

3.2.5.2.4 Connection Disconnected

When a CONNTYPE_TXUSER_DTCLURECOVERY is disconnected, the LU 6.2 implementation (section 3.2) MUST perform the following actions:

- If the connection state is Awaiting Register Response:
 - Delete the entry for the recovery sequence number in the Recovery Sequence Number Table keyed by the LU Name Pair associated with the connection object.
 - Return a failure result to the higher-layer business logic.
- Otherwise, the event MUST be processed as specified in section 3.1.8.

3.2.5.3 CONNTYPE_TXUSER_DTCLURMENLISTMENT as Initiator

For all messages that are received in this connection type, the LU 6.2 implementation (section 3.2) MUST process the message, as specified in section 3.1. The LU 6.2 implementation MUST additionally follow the processing rules as specified in the following sections.

3.2.5.3.1 Receiving a TXUSER_DTCLURMENLISTMENT_MTAG_REQUEST_COMPLETED Message

When the LU 6.2 implementation (section 3.2) receives a TXUSER_DTCLURMENLISTMENT_MTAG_REQUEST_COMPLETED message, it MUST perform the following actions:

- If the connection state is Awaiting Enlistment Response:
 - Return a success result and the connection object to the higher-layer business logic.
 - Set the connection state to Active.
- Otherwise, the message MUST be processed as an invalid message, as specified in [MS-DTCO], section 3.1.6.

3.2.5.3.2 Receiving Other TXUSER_DTCLURMENLISTMENT_MTAG Messages

When the LU 6.2 implementation (section 3.2) receives one of the following messages:

- TXUSER_DTCLURMENLISTMENT_MTAG_CREATE_DUPLICATE_LU_TRANSID
- TXUSER_DTCLURMENLISTMENT_MTAG_CREATE_LOG_FULL
- TXUSER_DTCLURMENLISTMENT_MTAG_CREATE_LU_DOWN
- TXUSER_DTCLURMENLISTMENT_MTAG_CREATE_LU_NO_RECOVERY_PROCESS
- TXUSER_DTCLURMENLISTMENT_MTAG_CREATE_LU_NOT_FOUND
- TXUSER_DTCLURMENLISTMENT_MTAG_CREATE_LU_RECOVERING
- TXUSER_DTCLURMENLISTMENT_MTAG_CREATE_LU_RECOVERY_MISMATCH

- TXUSER_DTCLURMENLISTMENT_MTAG_CREATE_TOO_LATE
- TXUSER_DTCLURMENLISTMENT_MTAG_CREATE_TOO_MANY
- TXUSER_DTCLURMENLISTMENT_MTAG_CREATE_TX_NOT_FOUND

the LU 6.2 Implementation MUST perform the following actions:

- If the connection state is Awaiting Enlistment Response:
 - Return a failure result to the higher-layer business logic.
 - Set the connection state to Ended.
- Otherwise, the message MUST be processed as an invalid message, as specified in [MS-DTCO], section 3.1.6.

3.2.5.3.3 Receiving a TXUSER_DTCLURMENLISTMENT_MTAG_TO_LU_PREPARE Message

When the LU 6.2 implementation (section 3.2) receives a TXUSER_DTCLURMENLISTMENT_MTAG_TO_LU_PREPARE message, it MUST perform the following actions:

- If the connection state is Active:
 - Send a Prepare request to the higher-layer business logic.
 - Set the connection state to Preparing For Transaction Commit.
- Otherwise, the message MUST be processed as an invalid message, as specified in [MS-DTCO], section 3.1.6.

3.2.5.3.4 Receiving a TXUSER_DTCLURMENLISTMENT_MTAG_TO_LU_BACKEDOUT Message

When the LU 6.2 implementation (section 3.2) receives a TXUSER_DTCLURMENLISTMENT_MTAG_TO_LU_BACKEDOUT message, it MUST perform the following actions:

- If the connection state is Awaiting Backout Response:
 - Return a success result to the higher-layer business logic.
 - Set the connection state to Ended.
- Otherwise, the message MUST be processed as an invalid message, as specified in [MS-DTCO], section 3.1.6.

3.2.5.3.5 Receiving a TXUSER_DTCLURMENLISTMENT_MTAG_TO_LU_BACKOUT Message

When the LU 6.2 implementation (section 3.2) receives a TXUSER_DTCLURMENLISTMENT_MTAG_TO_LU_BACKOUT message, it MUST perform the following actions:

- If the connection state is Awaiting Transaction Outcome or Active:
 - Send a Backout request to the higher-layer business logic.
 - Set the connection state to Finalizing Abort Operations.

- Otherwise, the message MUST be processed as an invalid message, as specified in [MS-DTCO], section 3.1.6.

3.2.5.3.6 Receiving a TXUSER_DTCLURMENLISTMENT_MTAG_TO_LU_COMMITTED Message

When the LU 6.2 implementation (section 3.2) receives a TXUSER_DTCLURMENLISTMENT_MTAG_TO_LU_COMMITTED message, it MUST perform the following actions:

- If the connection state is Awaiting Transaction Outcome:
 - Send a Commit request to the higher-layer business logic.
 - Set the connection state to Finalizing Commit Operations.
- Otherwise, the message MUST be processed as an invalid message, as specified in [MS-DTCO], section 3.1.6.

3.2.5.3.7 Connection Disconnected

When a CONNTYPE_TXUSER_DTCLURMENLISTMENT is disconnected, the LU 6.2 implementation (section 3.2) MUST perform the following actions.

- If the connection state is either Awaiting Enlistment Response, Active, Awaiting Backout Response, or Awaiting Transaction Outcome:
 - Return a failure result to the higher-layer business logic.
- Otherwise, the event MUST be processed as specified in section 3.1.8.

3.2.5.4 CONNTYPE_TXUSER_DTCLURECOVERYINITIATEDBYDTC as Initiator

For all messages that are received in this connection type, the LU 6.2 implementation (section 3.2) MUST process the message, as specified in section 3.1. The LU 6.2 implementation MUST additionally follow the processing rules as specified in the following sections.

3.2.5.4.1 Receiving a TXUSER_DTCLURECOVERYINITIATEDBYDTC_MTAG_GETWORK_NOT_FOUND Message

When the LU 6.2 implementation (section 3.2) receives a TXUSER_DTCLURECOVERYINITIATEDBYDTC_MTAG_GETWORK_NOT_FOUND message, it MUST perform the following actions:

- If the connection state is Awaiting Response To Work Query:
 - Return a failure result to the higher-layer business logic.
 - Set the connection state to Ended.
- Otherwise, the message MUST be processed as an invalid message, as specified in [MS-DTCO], section 3.1.6.

3.2.5.4.2 Receiving a TXUSER_DTCLURECOVERYINITIATEDBYDTC_MTAG_WORK_CHECKLUSTATUS Message

When the LU 6.2 implementation (section 3.2) receives a TXUSER_DTCLURECOVERYINITIATEDBYDTC_MTAG_WORK_CHECKLUSTATUS message, it MUST perform the following actions:

- If the connection state is Awaiting Response To Work Query:
 - Return a success result and the connection object to the higher-layer business logic.
 - Set the connection state to Processing LU Status Check.
- Otherwise, the message MUST be processed as an invalid message, as specified in [MS-DTCO], section 3.1.6.

3.2.5.4.3 Receiving a TXUSER_DTCLURECOVERYINITIATEDBYDTC_MTAG_WORK_TRANS Message

When the LU 6.2 implementation (section 3.2) receives a TXUSER_DTCLURECOVERYINITIATEDBYDTC_MTAG_WORK_TRANS message, it MUST perform the following actions:

- If the connection state is Awaiting Response To Work Query:
 - Update the recovery sequence number in the Recovery Sequence Number Table keyed by the LU Name Pair associated with the connection object with the **RecoverySeqNum** field from the message.
 - Return a success result, the connection object, and the following message information to the higher-layer business logic:
 - The **RecoverySeqNum** field
 - The **XIn** field
 - The **OurLogName** field
 - The **RemoteLogName** field
 - If the **XIn** field of the message is set to DTCLUXLN_COLD:
 - Set the connection state to Processing Cold XLN Request.
 - Otherwise, if the **XIn** field of the message is set to DTCLUXLN_WARM:
 - Set the connection state to Processing Warm XLN Request.
- Otherwise, the message MUST be processed as an invalid message, as specified in [MS-DTCO], section 3.1.6.

3.2.5.4.4 Receiving a TXUSER_DTCLURECOVERYINITIATEDBYDTC_MTAG_CONFIRMATION_FOR_THEIR_XLN Message

When the LU 6.2 implementation (section 3.2) receives a TXUSER_DTCLURECOVERYINITIATEDBYDTC_MTAG_CONFIRMATION_FOR_THEIR_XLN message, it MUST perform the following actions:

- If the connection state is Awaiting Response To XLN:
 - If the **XInConfirmation** field of the message is set to DTCLUXLNCONFIRMATION_CONFIRM:
 - If the **Early Compare States Check Done** field of the connection object is set to TRUE:

- If the **Transaction Found To Recover** field of the connection object is set to TRUE:
 - Return a success result to the higher-layer business logic.
 - Set the connection state to Processing Compare States Request.
- Otherwise:
 - Return a success result to the higher-layer business logic.
 - Set the connection state to Ended.
- Otherwise:
 - Return a success result to the higher-layer business logic.
 - Set the connection state to XLN Exchange Complete.
- Otherwise:
 - Return a failure result and the following message information to the higher-layer business logic:
 - The **XInConfirmation** field.
 - Set the connection state to Ended.
- Otherwise, the message MUST be processed as an invalid message, as specified in [MS-DTCO], section 3.1.6.

3.2.5.4.5 Receiving a TXUSER_DTCLURECOVERYINITIATEDBYDTC_MTAG_NO_COMPARESTATES Message

When the LU 6.2 implementation (section 3.2) receives a TXUSER_DTCLURECOVERYINITIATEDBYDTC_MTAG_NO_COMPARESTATES message, it MUST perform the following actions:

- If the connection state is Awaiting Response To Compare States Query During Warm XLN:
 - Set the **Transaction Found To Recover** field of the connection object to FALSE.
 - Return a success result to the higher-layer business logic.
 - Set the connection state to Processing Warm XLN Request.
- Otherwise, if the connection state is Awaiting Response to Compare States Query:
 - Return a success result to the higher-layer business logic.
 - Set the connection state to Ended.
- Otherwise, the message MUST be processed as an invalid message, as specified in [MS-DTCO], section 3.1.6.

3.2.5.4.6 Receiving a TXUSER_DTCLURECOVERYINITIATEDBYDTC_MTAG_COMPARESTATES_INFO Message

When the LU 6.2 implementation (section 3.2) receives a TXUSER_DTCLURECOVERYINITIATEDBYDTC_MTAG_COMPARESTATES_INFO message, it MUST perform the following actions:

- If the connection state is Awaiting Response To Compare States Query During Warm XLN:
 - Set the **Transaction Found To Recover** field of the connection object to TRUE.
 - Return a success result and the following message information to the higher-layer business logic:
 - The **CompareStates** field
 - The **LuTransId** field
 - Set the connection state to Processing Warm XLN Request.
- Otherwise, if the connection state is Awaiting Response To Compare States Query:
 - Return a success result and the following message information to the higher-layer business logic:
 - The **CompareStates** field
 - The **LuTransId** field
 - Set the connection state to Processing Compare States Request.
- Otherwise, the message MUST be processed as an invalid message, as specified in [MS-DTCO], section 3.1.6.

3.2.5.4.7 Receiving a TXUSER_DTCLURECOVERYINITIATEDBYDTC_MTAG_CONFIRMATION_FOR_T HEIR_COMPARESTATES Message

When the LU 6.2 implementation (section 3.2) receives a TXUSER_DTCLURECOVERYINITIATEDBYDTC_MTAG_CONFIRMATION_FOR_THEIR_COMPARESTATES message, it MUST perform the following actions:

- If the connection state is Awaiting Response To Compare States:
 - Return a success result and the following message information to the higher-layer business logic:
 - The **CompareStatesConfirmation** field
 - Set the connection state to Ended.
- Otherwise, the message MUST be processed as an invalid message, as specified in [MS-DTCO], section 3.1.6.

3.2.5.4.8 Receiving a TXUSER_DTCLURECOVERYINITIATEDBYDTC_MTAG_REQUESTCOMPLETE Message

When the LU 6.2 implementation (section 3.2) receives a TXUSER_DTCLURECOVERYINITIATEDBYDTC_MTAG_REQUESTCOMPLETE message, it MUST perform the following actions:

- If the connection state is Awaiting Request Complete:

- Return a success result to the higher-layer business logic.
- Set the connection state to Ended.
- Otherwise, if the connection state is Awaiting Response To XLN Confirmation:
 - Return a success result to the higher-layer business logic.
 - Set the connection state to XLN Exchange Complete.
- Otherwise, the message MUST be processed as an invalid message, as specified in [MS-DTCO], section 3.1.6.

3.2.5.4.9 Connection Disconnected

When a CONNTYPE_TXUSER_DTCLURECOVERYINITIATEDBYDTC is disconnected, the LU 6.2 implementation (section 3.2) MUST perform the following actions:

- If the connection state is either Awaiting Response To Work Query, Awaiting Response To XLN Confirmation, Awaiting Response To XLN, Awaiting Response To Compare States Query During Warm XLN, Awaiting Response To Compare States Query, Awaiting Response To Compare States, or Awaiting Request Complete:
 - Return a failure result to the higher-layer business logic.
- Otherwise, the event MUST be processed as specified in section 3.1.8.

3.2.5.5 CONNTYPE_TXUSER_DTCLURECOVERYINITIATEDBYLU as Initiator

For all messages that are received in this connection type, the LU 6.2 implementation (section 3.2) MUST process the message, as specified in section 3.1. The LU 6.2 Implementation MUST additionally follow the processing rules as specified in the following sections.

3.2.5.5.1 Receiving a TXUSER_DTCLURECOVERYINITIATEDBYLU_MTAG_THEIR_XLN_NOT_FOUND Message

When an LU 6.2 implementation (section 3.2) receives a TXUSER_DTCLURECOVERYINITIATEDBYLU_MTAG_THEIR_XLN_NOT_FOUND message, it MUST perform the following actions:

- If the connection state is Awaiting Response To XLN Request:
 - Return a failure result to the higher-layer business logic.
 - Set the connection state to Ended.
- Otherwise, the message MUST be processed as an invalid message, as specified in [MS-DTCO], section 3.1.6.

3.2.5.5.2 Receiving a TXUSER_DTCLURECOVERYINITIATEDBYLU_MTAG_RESPONSE_FOR_THEIR_XLN Message

When an LU 6.2 implementation (section 3.2) receives a TXUSER_DTCLURECOVERYINITIATEDBYLU_MTAG_RESPONSE_FOR_THEIR_XLN message, it MUST perform the following actions:

- If the connection state is Awaiting Response To XLN Request:

- If the **XInResponse** field of the message is set to either DTCLUXLNRESPONSE_LOGNAMEMISMATCH or DTCLUXLNRESPONSE_COLDWARMISMATCH:
 - Return a failure result to the higher-layer business logic.
 - Set the connection state to Ended.
- Otherwise:
 - Return a success result, the connection object, and the following message information to the higher-layer business logic:
 - The **XInResponse** field
 - The **XIn** field
 - The **OurLogName** field
 - If the **XInResponse** field of the message is set to DTCLUXLNRESPONSE_OK_SENDCONFIRMATION:
 - Set the connection state to XLN Exchange Complete.
 - Otherwise, if the **XInResponse** field of the message is set to DTCLUXLNRESPONSE_OK_SENDOURXLNBACK:
 - Set the connection state to Processing XLN Confirmation.
- Otherwise, the message MUST be processed as an invalid message, as specified in [MS-DTCO], section 3.1.6.

3.2.5.5.3 Receiving a TXUSER_DTCLURECOVERYINITIATEDBYLU_MTAG_RESPONSE_FOR_THEIR_COMPARESTATES Message

When an LU 6.2 implementation (section 3.2) receives a TXUSER_DTCLURECOVERYINITIATEDBYLU_MTAG_RESPONSE_FOR_THEIR_COMPARESTATES message, it MUST perform the following actions:

- If the connection state is Awaiting Response To Compare States:
 - If the **CompareStatesResponse** field of the message is set to DTCLUCOMPARESTATESRESPONSE_PROTOCOL:
 - Return a failure result to the higher-layer business logic.
 - Set the connection state to Ended.
 - Otherwise, if the **CompareStatesResponse** field of the message is set to DTCLUCOMPARESTATESRESPONSE_OK:
 - Return a success result and the following message information to the higher-layer business logic:
 - The **CompareStates** field
 - Set the connection state to Processing Compare States Response.
- Otherwise, the message MUST be processed as an invalid message, as specified in [MS-DTCO], section 3.1.6.

3.2.5.5.4 Receiving a TXUSER_DTCLURECOVERYINITIATEDBYLU_MTAG_REQUESTCOMPLETE Message

When the LU 6.2 implementation (section 3.2) receives a TXUSER_DTCLURECOVERYINITIATEDBYLU_MTAG_REQUESTCOMPLETE message, the LU 6.2 implementation MUST perform the following actions:

- If the connection state is Awaiting Response To XLN Confirmation:
 - Return a success result to the higher-layer business logic.
 - Set the connection state to XLN Exchange Complete.
- Otherwise, if the connection state is Awaiting Request Complete:
 - Return a success result to the higher-layer business logic.
 - Set the connection state to Ended.
- Otherwise, if the connection state is Awaiting Response To XLN Confirmation With Error:
 - Return a failure result to the higher-layer business logic
 - Set the connection state to Ended.
- Otherwise, the message MUST be processed as an invalid message, as specified in [MS-DTCO], section 3.1.6.

3.2.5.5.5 Connection Disconnected

When a CONNTYPE_TXUSER_DTCLURECOVERYINITIATEDBYLU is disconnected, the LU 6.2 implementation (section 3.2) MUST perform the following actions:

- If the connection state is either Awaiting Response To XLN Request, Awaiting Response To XLN Confirmation, Awaiting Response To XLN Confirmation With Error, Awaiting Response To Compare States, or Awaiting Request Complete:
 - Return a failure result to the higher-layer business logic.
- Otherwise, the event MUST be processed as specified in section 3.1.8.

3.2.6 Timer Events

None.

3.2.7 Other Local Events

None.

3.3 Transaction Manager Communicating with an LU 6.2 Implementation Facet Details

3.3.1 Abstract Data Model

This section describes a conceptual model of possible data organization that an implementation maintains to participate in this protocol. The described organization is provided to facilitate the explanation of how the protocol behaves. This document does not mandate that the implementations

adhere to this model as long as their external behavior is consistent with the behavior that is described in this document.

Note that the abstract data model can be implemented in a variety of ways. This protocol does not prescribe or advocate any specific implementation technique.

The **Transaction Manager Communicating with an LU 6.2 Implementation** Facet MUST maintain the following data elements:

- **LU Pair Table:** A durable table of **LU Pair** objects, keyed by an LU Name Pair. An **LU Pair** object represents an association between a local LU and a remote LU.
- **LU Pair Object:** An **LU Pair Object** MUST contain the following data elements:
 - **LU Name Pair:** A durable byte array that MUST uniquely identify the **LU Pair** object.
 - **Local Log Name:** A durable byte array that MUST contain the log name of the local LU.
 - **Remote Log Name:** A durable byte array that MUST contain the log name provided by the remote LU.
 - **Is Warm:** A durable flag that indicates whether the log status of the local LU is Log Status Warm or Log Status Cold.
 - **LUW List:** A durable list of LUW objects that are associated with the **LU Pair** object. An **LUW** object represents a logical unit of work.
 - **Resource Manager Identifier:** A durable GUID that specifies the Resource Manager Identifier used when interacting with the Core Transaction Manager Facet as specified in section 3.3.5.3.1.
 - **Recovery Sequence Number:** Specifies the recovery sequence number that is provided by the LU 6.2 Implementation to demarcate sequences of recovery protocol messages flowing between the local LU and remote LU associated by this LU Pair.
 - **Local LU Initiated Recovery List:** A list of connection objects of type CONNTYPE_TXUSER_DTCLURECOVERYINITIATEDBYDTC. Each object represents a recovery process initiated by the transaction manager on behalf of the local LU.
 - **Remote LU Initiated Recovery List:** A list of connection objects of type CONNTYPE_TXUSER_DTCLURECOVERYINITIATEDBYLU. Each object represents a recovery process initiated by the remote LU.
 - **LU Pair Recovery State:** An enumeration that indicates the extent to which the **LU Pair** object has been recovered. This MUST contain one of the values defined by **LU Pair Recovery State** enumeration, later in this section.
 - **Is LUW Triggered Recovery Pending:** A flag that indicates whether a request to recover an LUW associated with the **LU Pair** object is waiting to be processed.
- **LUW Object:** An **LUW** Object MUST contain the following data elements:
 - **Transaction Identifier:** A durable GUID that specifies the transaction identifier of the transaction that is associated with the logical unit of work.
 - **LUW Identifier:** A durable byte array specifying the LUW identifier.
 - **Local LU LUW State:** A durable enumeration that specifies the state of the LUW as perceived by its associated local LU. This MUST contain one of the values defined by **LUW State** enumeration, later in this section.

- **LUW Recovery State:** An enumeration that specifies the state of recovery work for the LUW. This MUST contain one of the values defined by **LUW Recovery State** enumeration, later in this section.
- **Enlistment:** Specifies a durable reference to the **Enlistment** object (as specified in [MS-DTCO] section 3.1.1) which represents the enlistment of the LUW on an atomic transaction.
- **Recovery Sequence Number For LUW:** Specifies a snapshot of the recovery sequence number field of the **LU Pair** object that represents the pair of LUs involved in the LUW taken when the message TXUSER_DTCLURMENLISTMENT_MTAG_CREATE is processed.
- **Is Conversation Lost:** A flag that indicates whether the LU 6.2 Implementation has reported the conversation with the remote LU being used for this LUW as lost.
- The connection object of type CONNTYPE_TXUSER_DTCLURECOVERY MUST be extended to include the following data field:
 - **LU Pair:** Specifies a reference to the **LU Pair** object that is associated with the connection.
- The connection object of type CONNTYPE_TXUSER_DTCLURMENLISTMENT MUST be extended to include the following data fields:
 - **LU Pair:** Specifies a reference to the **LU Pair** object that is associated with the connection.
 - **LUW:** Specifies a reference to the **LUW** object that is associated with the connection.
- The connection object of type CONNTYPE_TXUSER_DTCLURECOVERYINITIATEDBYDTC MUST be extended to include the following data fields:
 - **LU Pair:** Specifies a reference to the **LU Pair** object that is associated with the connection.
 - **LUW To Recover:** Specifies a reference to the LUW object that is associated with the connection.
 - **Recovery Sequence Number For Connection:** Specifies a snapshot of the **Recovery Sequence Number** field of the associated **LU Pair** object taken when a response is sent to the TXUSER_DTCLURECOVERYINITIATEDBYDTC_MTAG_GETWORK message.
 - **Compare State Query Received:** This flag is used to indicate whether a Compare States Query was processed while awaiting an XLN Response.
- The connection object of type CONNTYPE_TXUSER_DTCLURECOVERYINITIATEDBYLU MUST be extended to include the following data fields:
 - **LU Pair:** Specifies a reference to the **LU Pair** object that is associated with the connection.
 - **LUW To Recover:** Specifies a reference to the **LUW** object that is associated with the connection.
- **LU Pair Recovery State:** An enumeration that indicates the extent to which the **LU Pair** object has been recovered. This element MUST be set to one of the following values:
 - **Recovery Process Not Attached:** This value is used to indicate that a recovery process has not been registered for the LU Name Pair.
 - **Not Synchronized:** This value is used to indicate that a recovery process has been registered for the LU Name Pair but that the local LU and remote LU are not currently synchronized.
 - **Synchronizing No Remote Name:** This value is used to indicate that an XLN exchange is in progress between the local LU and the remote LU, and the remote LU has not yet supplied a remote log name.

- Synchronizing Have Remote Name: This value is used to indicate that an XLN exchange is in progress between the local LU and the remote LU, and the remote LU has supplied a remote log name.
- Inconsistent: This value is used to indicate that an exchange of XLN messages has shown that the local LU and the remote LU are currently in inconsistent states.
- Synchronized: This value is used to indicate that an exchange of XLN messages has shown that the local LU and the remote LU are in consistent states.
- Synchronized Awaiting LU Status: This value is used to indicate that an exchange of XLN messages has shown that the local LU and the remote LU are in consistent states, and a response from the LU 6.2 Implementation reporting the status of the local LU is awaited.
- **LUW Recovery State:** An enumeration that specifies the state, with respect to recovery, of the LUW as perceived by the local LU. This element **MUST** be set to one of the following values:
 - Recovery Not Needed: This value is used to indicate that recovery is not needed for the LUW.
 - Need Recovery: This value is used to indicate that recovery needs to be performed for the LUW.
 - Recovering: This value is used to indicate that recovery is in progress for the LUW.
- **LUW State:** An enumeration that specifies the state of the logical unit of work as perceived by the local LU. This element **MUST** be set to one of the following values:
 - Active: The logical unit of work is in Active Phase.
 - Committed: The logical unit of work is in Phase Two with the outcome as Committed.
 - Reset: The logical unit of work is in Phase Two with the outcome as Aborted.
 - In Doubt: The logical unit of work is in Phase Two with the outcome as In Doubt.
 - Forget: The logical unit of work has been completed.
- **Log:** A durable list of **LU Pair** objects. The contents of this log **MUST** persist across software restarts or transient failures.

3.3.1.1 Logging

When an **LU Pair** object is stored in the log, the Transaction Manager Communicating with an LU 6.2 Implementation Facet **MUST** record only the object fields marked as durable.

When an **LU Pair** object is retrieved from the log, the Transaction Manager Communicating with an LU 6.2 Implementation Facet **MUST** set the data elements as follows:

- **Recovery Sequence Number:** To the value 1.
- **LU Pair Recovery State:** To the value Recovery Process Not Attached.
- **Is LUW Triggered Recovery Pending:** To the value FALSE.

When an **LUW** object is stored in the log, the Transaction Manager Communicating with an LU 6.2 Implementation Facet **MUST** record only the object fields marked as durable.

When an **LUW** object is retrieved from the log, the Transaction Manager Communicating with an LU 6.2 Implementation Facet **MUST** set the data elements as follows:

- **Recovery Sequence Number For LUW:** To the value 0.

- **Is Conversation Lost:** To the value FALSE.

When an enlistment object is stored in the log, the Transaction Manager Communicating with an LU 6.2 Implementation Facet MUST record all of the object fields.

When a connection object is stored in the log, the Transaction Manager Communicating with an LU 6.2 Implementation Facet MUST record all of the object fields.

When a connection object is retrieved from the log, the Transaction Manager Communicating with an LU 6.2 Implementation Facet MUST set its state to Ended.

3.3.1.2 CONNTYPE_TXUSER_DTCLUCONFIGURE Acceptor States

The Transaction Manager Communicating with an LU 6.2 Implementation Facet MUST act as an acceptor for the CONNTYPE_TXUSER_DTCLUCONFIGURE connection type. In this role, the Transaction Manager Communicating with an LU 6.2 Implementation Facet MUST provide support for the following states:

- Idle
- Processing Add Request
- Processing Delete Request
- Ended

3.3.1.2.1 Idle

This is the initial state. The following events are processed in this state:

- Receiving a TXUSER_DTCLURMCONFIGURE_MTAG_ADD message
- Receiving a TXUSER_DTCLURMCONFIGURE_MTAG_DELETE message

3.3.1.2.2 Processing Add Request

This is a transient state that is assumed during the synchronous processing of adding an LU Pair request. No events are processed in this state.

3.3.1.2.3 Processing Delete Request

This is a transient state that is assumed during the synchronous processing of deleting an LU Pair request. No events are processed in this state.

3.3.1.2.4 Ended

This is the final state.

3.3.1.2.5 State Diagram

The following figure shows the relationship between the CONNTYPE_TXUSER_DTCLUCONFIGURE acceptor states.

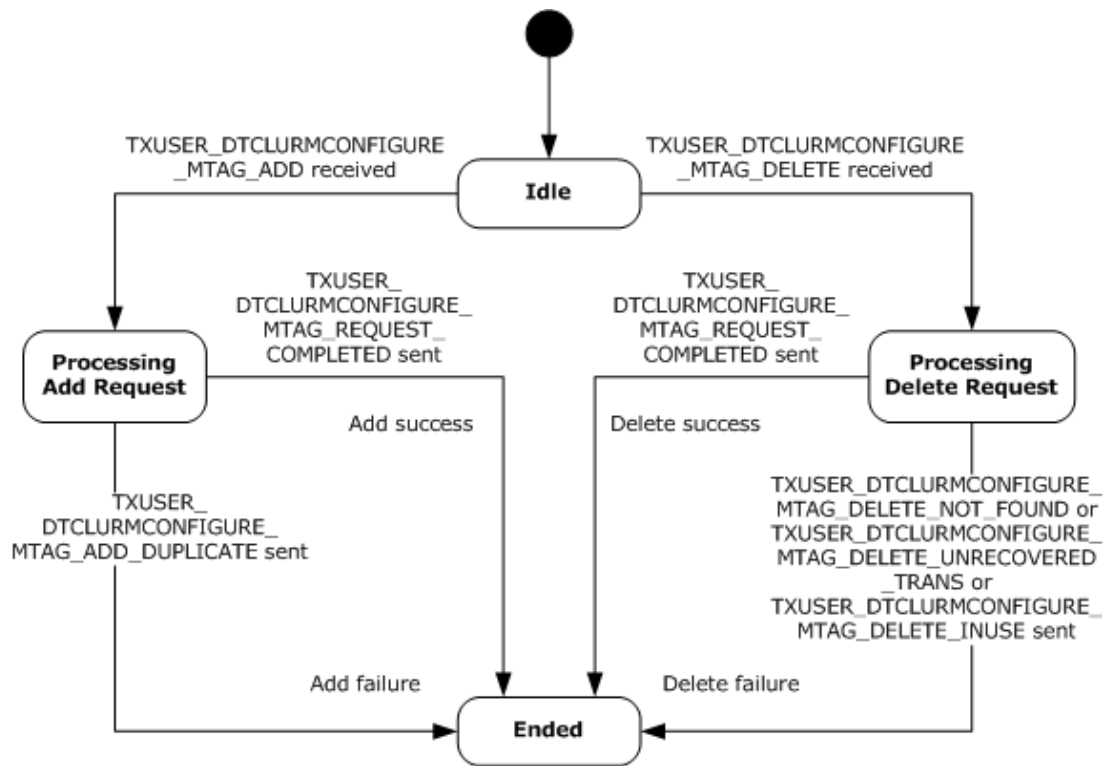

Figure 11: CONNTYPE_TXUSER_DTCLURMCONFIGURE acceptor states

3.3.1.3 CONNTYPE_TXUSER_DTCLURECOVERY Acceptor States

The Transaction Manager Communicating with an LU 6.2 Implementation Facet MUST act as an acceptor for the CONNTYPE_TXUSER_DTCLURECOVERY connection type. In this role, the Transaction Manager Communicating with an LU 6.2 Implementation Facet MUST provide support for the following states:

- Idle
- Processing Register Request
- Registered
- Ended

3.3.1.3.1 Idle

This is the initial state. The following event is processed in this state:

- Receiving a TXUSER_DTCLURMRECOVERY_MTAG_ATTACH message

3.3.1.3.2 Processing Register Request

This is a transient state that is assumed during the synchronous processing of a register request. No events are processed in this state.

3.3.1.3.3 Registered

The following event is processed in this state:

- Connection Disconnected (section 3.3.5.2.2)

3.3.1.3.4 Ended

This is the final state.

3.3.1.3.5 State Diagram

The following figure shows the relationship between the CONNTYPE_TXUSER_DTCLURECOVERY acceptor states.

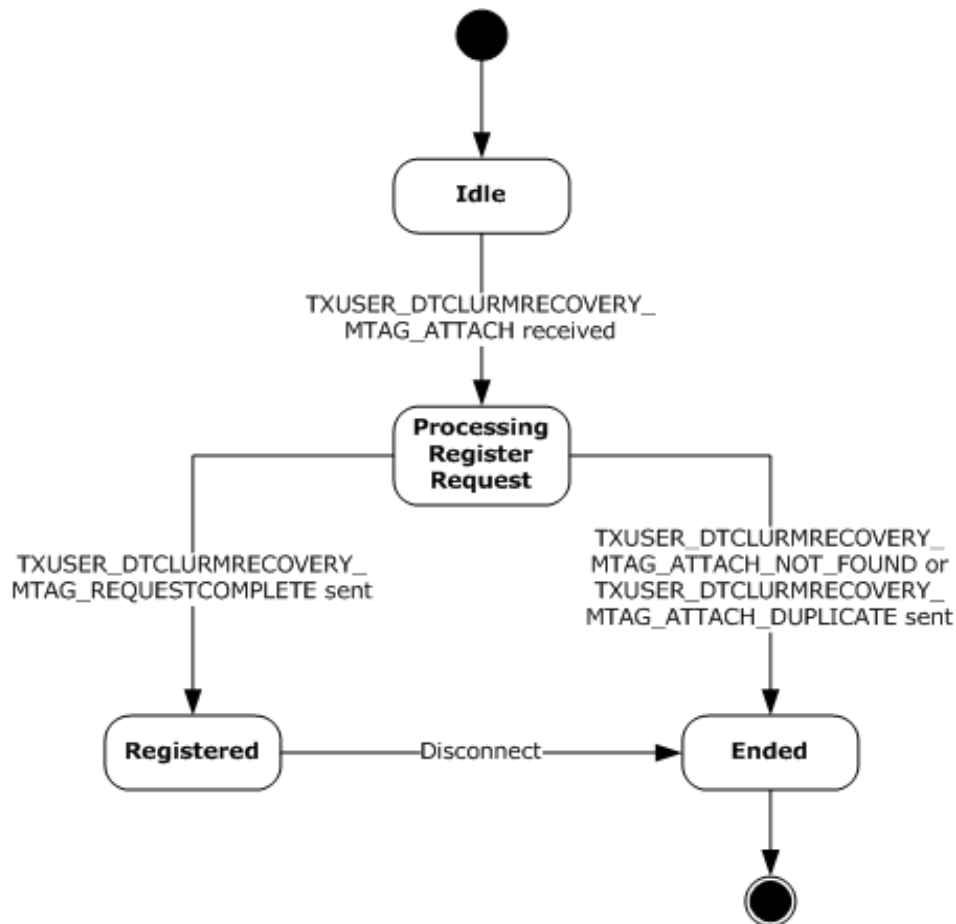

Figure 12: CONNTYPE_TXUSER_DTCLURECOVERY acceptor states

3.3.1.4 CONNTYPE_TXUSER_DTCLURMENLISTMENT Acceptor States

The Transaction Manager Communicating with an LU 6.2 Implementation Facet MUST act as an acceptor for the CONNTYPE_TXUSER_DTCLURMENLISTMENT connection type. In this role, the Transaction Manager Communicating with an LU 6.2 Implementation Facet MUST provide support for the following states:

- Idle
- Processing Enlistment Request
- Active

- Awaiting Prepare Response
- Processing Backout Request
- Prepared
- Awaiting Commit Response
- Awaiting Abort Response
- Ended

3.3.1.4.1 Idle

This is the initial state. The following events are processed in this state:

- Receiving a TXUSER_DTCLURMENLISTMENT_MTAG_CREATE message
- Receiving a TXUSER_DTCLURMENLISTMENT_MTAG_TO_DTC_CONVERSATIONLOST message

3.3.1.4.2 Processing Enlistment Request

The following events are processed in this state:

- Create Subordinate Enlistment Success
- Create Subordinate Enlistment Failure
- Receiving a TXUSER_DTCLURMENLISTMENT_MTAG_TO_DTC_CONVERSATIONLOST message

3.3.1.4.3 Active

The following events are processed in this state:

- Begin Phase One
- Begin Rollback
- Receiving a TXUSER_DTCLURMENLISTMENT_MTAG_TO_DTC_BACKOUT message
- Receiving a TXUSER_DTCLURMENLISTMENT_MTAG_TO_DTC_CONVERSATIONLOST message

3.3.1.4.4 Awaiting Prepare Response

The following events are processed in this state:

- Receiving a TXUSER_DTCLURMENLISTMENT_MTAG_TO_DTC_REQUESTCOMMIT message
- Receiving a TXUSER_DTCLURMENLISTMENT_MTAG_TO_DTC_BACKOUT message
- Receiving a TXUSER_DTCLURMENLISTMENT_MTAG_TO_DTC_FORGET message
- Receiving a TXUSER_DTCLURMENLISTMENT_MTAG_TO_DTC_CONVERSATIONLOST message

3.3.1.4.5 Processing Backout Request

The following events are processed in this state:

- Begin Rollback
- Receiving a TXUSER_DTCLURMENLISTMENT_MTAG_TO_DTC_CONVERSATIONLOST message

3.3.1.4.6 Prepared

The following events are processed in this state:

- Begin Commit
- Begin Rollback
- Receiving a TXUSER_DTCLURMENLISTMENT_MTAG_TO_DTC_CONVERSATIONLOST message

3.3.1.4.7 Awaiting Commit Response

The following events are processed in this state:

- Receiving a TXUSER_DTCLURMENLISTMENT_MTAG_TO_DTC_FORGET message
- Receiving a TXUSER_DTCLURMENLISTMENT_MTAG_TO_DTC_CONVERSATIONLOST message

3.3.1.4.8 Awaiting Abort Response

The following events are processed in this state:

- Receiving a TXUSER_DTCLURMENLISTMENT_MTAG_TO_DTC_BACKEDOUT message
- Receiving a TXUSER_DTCLURMENLISTMENT_MTAG_TO_DTC_CONVERSATIONLOST message

3.3.1.4.9 Ended

This is the final state.

3.3.1.4.10 State Diagram

The following figure shows the relationship between the CONNTYPE_TXUSER_DTCLURMENLISTMENT acceptor states.

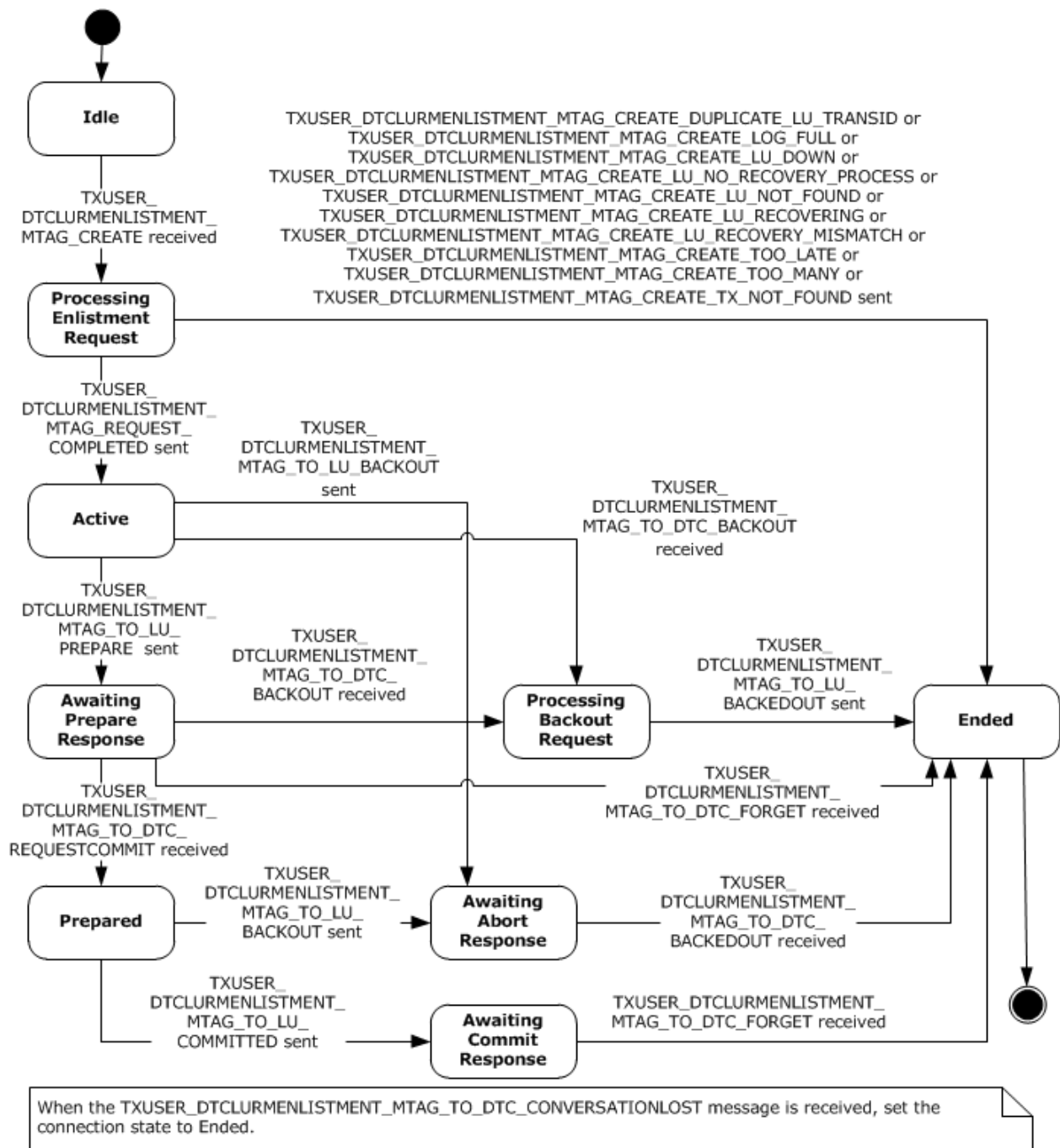

Figure 13: CONNTYPE_TXUSER_DTCLURMENLISTMENT acceptor states

3.3.1.5 CONNTYPE_TXUSER_DTCLURECOVERYINITIATEDBYDTC Acceptor States

The Transaction Manager Communicating with an LU 6.2 Implementation Facet MUST act as an acceptor for the CONNTYPE_TXUSER_DTCLURECOVERYINITIATEDBYDTC connection type. In this role, the Transaction Manager Communicating with an LU 6.2 Implementation Facet MUST provide support for the following states:

- Idle

- Processing Work Query
- Awaiting Response To Cold XLN
- Processing Response To Cold XLN
- Awaiting Response To Warm XLN
- Processing Response To Warm XLN
- Processing Compare State Query During Warm XLN
- Awaiting LU Status Response
- Processing LU Status Response
- Awaiting Compare States Query
- Processing Compare States Query
- Awaiting Compare States Response
- Processing Compare States Response
- Is Obsolete Awaiting Response To Cold XLN
- Is Obsolete Awaiting Response To Warm XLN
- Is Obsolete Awaiting LU Status Response
- Is Obsolete Processing Response
- Is Obsolete Processing Compare State Query During Warm XLN
- Ended

3.3.1.5.1 Idle

This is the initial state. The following events are processed in this state:

- Receiving a TXUSER_DTCLURECOVERYINITIATEDBYDTC_MTAG_GETWORK message
- Connection Disconnected (section 3.3.5.4.10)

3.3.1.5.2 Processing Work Query

The following events are processed in this state:

- Send Cold XLN
- Send Warm XLN
- Send Check LU Status
- Recovery Work Ready
- Connection Disconnected (section 3.3.5.4.10)

3.3.1.5.3 Awaiting Response To Cold XLN

The following events are processed in this state:

- Local LU Initiated Recovery Obsolete XLN Exchange
- Receiving a TXUSER_DTCLURECOVERYINITIATEDBYDTC_MTAG_NEW_RECOVERY_SEQ_NUM message
- Receiving a TXUSER_DTCLURECOVERYINITIATEDBYDTC_MTAG_ERROR_FROM_OUR_XLN message
- Receiving a TXUSER_DTCLURECOVERYINITIATEDBYDTC_MTAG_THEIR_XLN_RESPONSE message
- Connection Disconnected (section 3.3.5.4.10)

3.3.1.5.4 Processing Response To Cold XLN

This is a transient state that is assumed during the synchronous processing of a response to a Cold XLN request. No events are processed in this state.

3.3.1.5.5 Awaiting Response To Warm XLN

The following events are processed in this state:

- Local LU Initiated Recovery Obsolete XLN Exchange
- Receiving a TXUSER_DTCLURECOVERYINITIATEDBYDTC_MTAG_NEW_RECOVERY_SEQ_NUM message
- Receiving a TXUSER_DTCLURECOVERYINITIATEDBYDTC_MTAG_CONFIRMATION_FROM_OUR_XLN message
- Receiving a TXUSER_DTCLURECOVERYINITIATEDBYDTC_MTAG_ERROR_FROM_OUR_XLN message
- Receiving a TXUSER_DTCLURECOVERYINITIATEDBYDTC_MTAG_THEIR_XLN_RESPONSE message
- Receiving a TXUSER_DTCLURECOVERYINITIATEDBYDTC_MTAG_CHECK_FOR_COMPARESTATES message
- Connection Disconnected (section 3.3.5.4.10)

3.3.1.5.6 Processing Response to Warm XLN

This is a transient state that is assumed during the synchronous processing of a response to a Warm XLN request. No events are processed in this state.

3.3.1.5.7 Processing Compare State Query During Warm XLN

This is a transient state that is assumed during the synchronous processing of a Compare States query during a Warm XLN request. No events are processed in this state.

3.3.1.5.8 Awaiting LU Status Response

The following events are processed in this state:

- Local LU Initiated Recovery Obsolete XLN Exchange
- Receiving a TXUSER_DTCLURECOVERYINITIATEDBYDTC_MTAG_LUSTATUS message
- Connection Disconnected (section 3.3.5.4.10)

3.3.1.5.9 Processing LU Status Response

This is a transient state that is assumed during the synchronous processing of a response to an LU status request. No events are processed in this state.

3.3.1.5.10 Awaiting Compare States Query

The following events are processed in this state:

- Receiving a TXUSER_DTCLURECOVERYINITIATEDBYDTC_MTAG_CHECK_FOR_COMPARESTATES message
- Connection Disconnected (section 3.3.5.4.10)

3.3.1.5.11 Processing Compare States Query

This is a transient state that is assumed during the synchronous processing of a query for a Compare States request. No events are processed in this state.

3.3.1.5.12 Awaiting Compare States Response

The following events are processed in this state:

- Receiving a TXUSER_DTCLURECOVERYINITIATEDBYDTC_MTAG_THEIR_COMPARESTATES message
- Receiving a TXUSER_DTCLURECOVERYINITIATEDBYDTC_MTAG_ERROR_FROM_OUR_COMPARESTATES message

3.3.1.5.13 Processing Compare States Response

This is a transient state that is assumed during the synchronous processing of a response for a Compare States request. No events are processed in this state.

3.3.1.5.14 Processing Compare States Error

This is a transient state that is assumed during the synchronous processing of a response for a Compare States error request. No events are processed in this state.

3.3.1.5.15 Is Obsolete Awaiting Response To Cold XLN

The following events are processed in this state:

- Receiving a TXUSER_DTCLURECOVERYINITIATEDBYDTC_MTAG_NEW_RECOVERY_SEQ_NUM message
- Receiving a TXUSER_DTCLURECOVERYINITIATEDBYDTC_MTAG_ERROR_FROM_OUR_XLN message
- Receiving a TXUSER_DTCLURECOVERYINITIATEDBYDTC_MTAG_THEIR_XLN_RESPONSE message
- Connection Disconnected (section 3.3.5.4.10)

3.3.1.5.16 Is Obsolete Awaiting Response To Warm XLN

The following events are processed in this state:

- Receiving a TXUSER_DTCLURECOVERYINITIATEDBYDTC_MTAG_NEW_RECOVERY_SEQ_NUM message
- Receiving a TXUSER_DTCLURECOVERYINITIATEDBYDTC_MTAG_CONFIRMATION_FROM_OUR_XLN message

- Receiving a TXUSER_DTCLURECOVERYINITIATEDBYDTC_MTAG_ERROR_FROM_OUR_XLN message
- Receiving a TXUSER_DTCLURECOVERYINITIATEDBYDTC_MTAG_THEIR_XLN_RESPONSE message
- Receiving a TXUSER_DTCLURECOVERYINITIATEDBYDTC_MTAG_CHECK_FOR_COMPARESTATES message
- Connection Disconnected (section 3.3.5.4.10)

3.3.1.5.17 Is Obsolete Awaiting LU Status Response

The following events are processed in this state:

- Receiving a TXUSER_DTCLURECOVERYINITIATEDBYDTC_MTAG_LUSTATUS message
- Connection Disconnected (section 3.3.5.4.10)

3.3.1.5.18 Is Obsolete Processing Response

This is a transient state that is assumed during the synchronous processing of a request. No events are processed in this state.

3.3.1.5.19 Is Obsolete Processing Compare State Query During Warm XLN

This is a transient state that is assumed during the synchronous processing of a request. No events are processed in this state.

3.3.1.5.20 Ended

This is the final state.

3.3.1.5.21 State Diagram

The following figure shows the relationship between the CONNTYPE_TXUSER_DTCLURECOVERYINITIATEDBYDTC acceptor states.

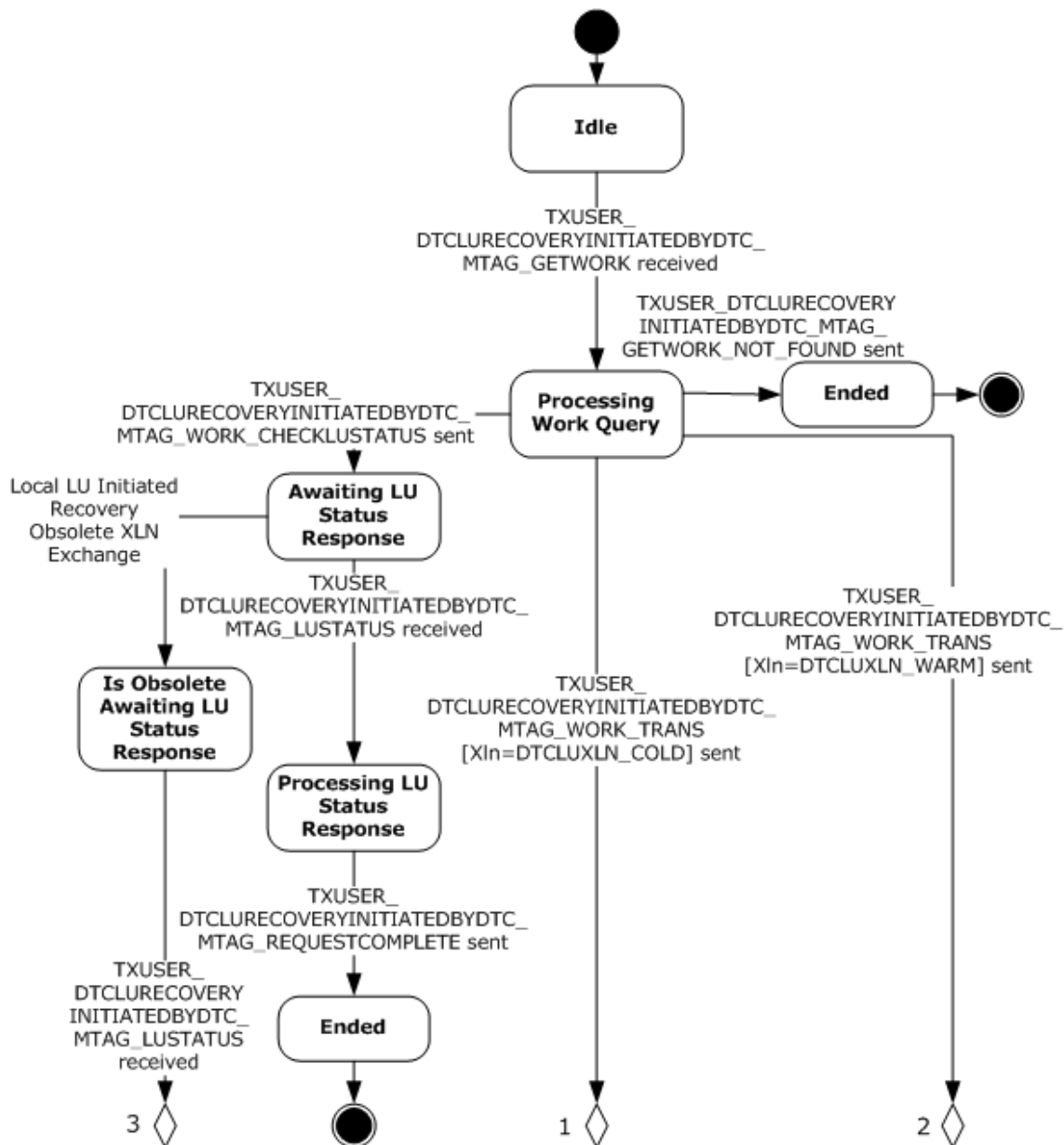

Figure 14: CONNTYPE_TXUSER_DTCLURECOVERYINITIATEDBYDTC, Part 1

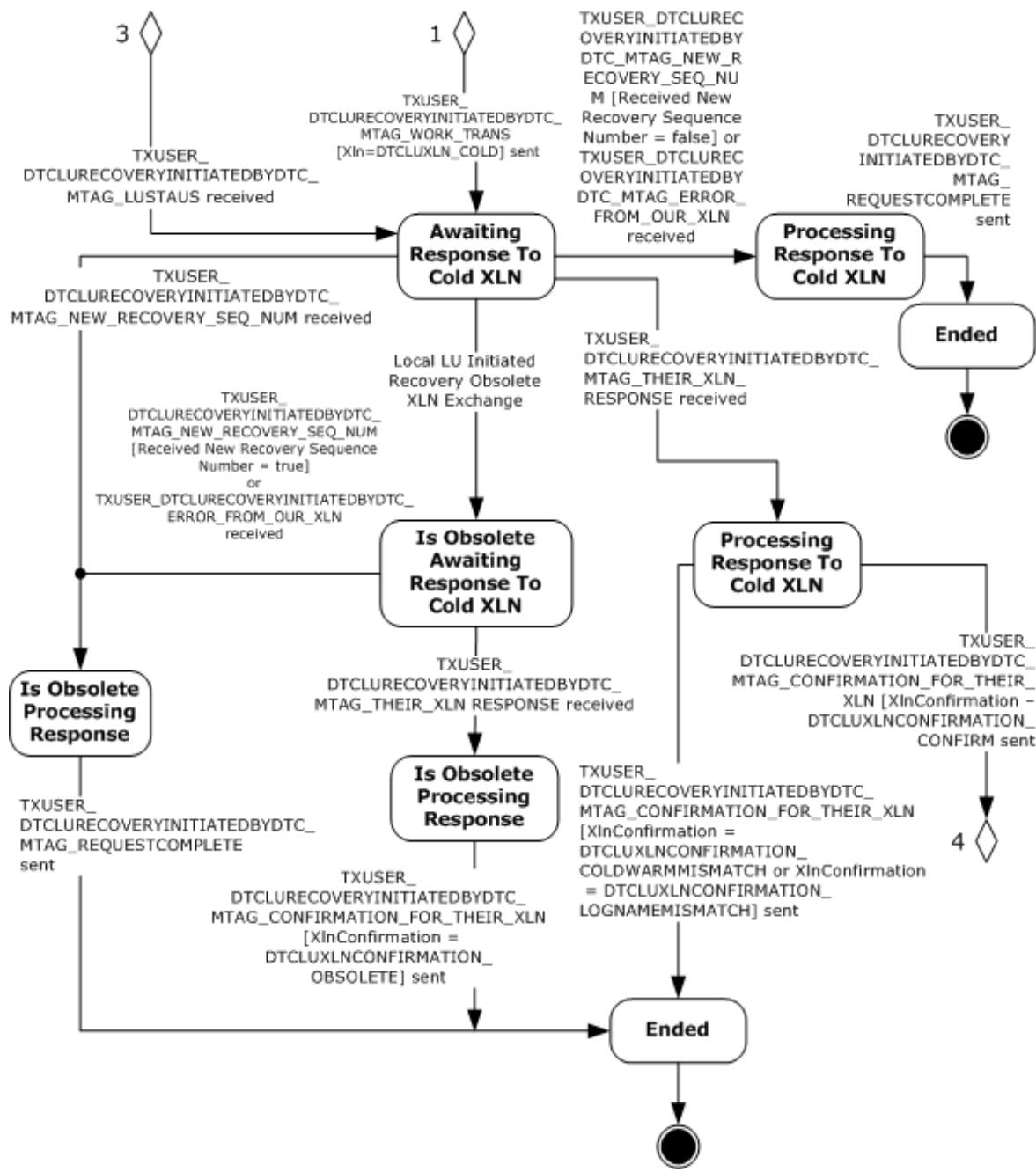

Figure 15: CONNTYPE_TXUSER_DTCLURECOVERYINITIATEDBYDTC, Part 2

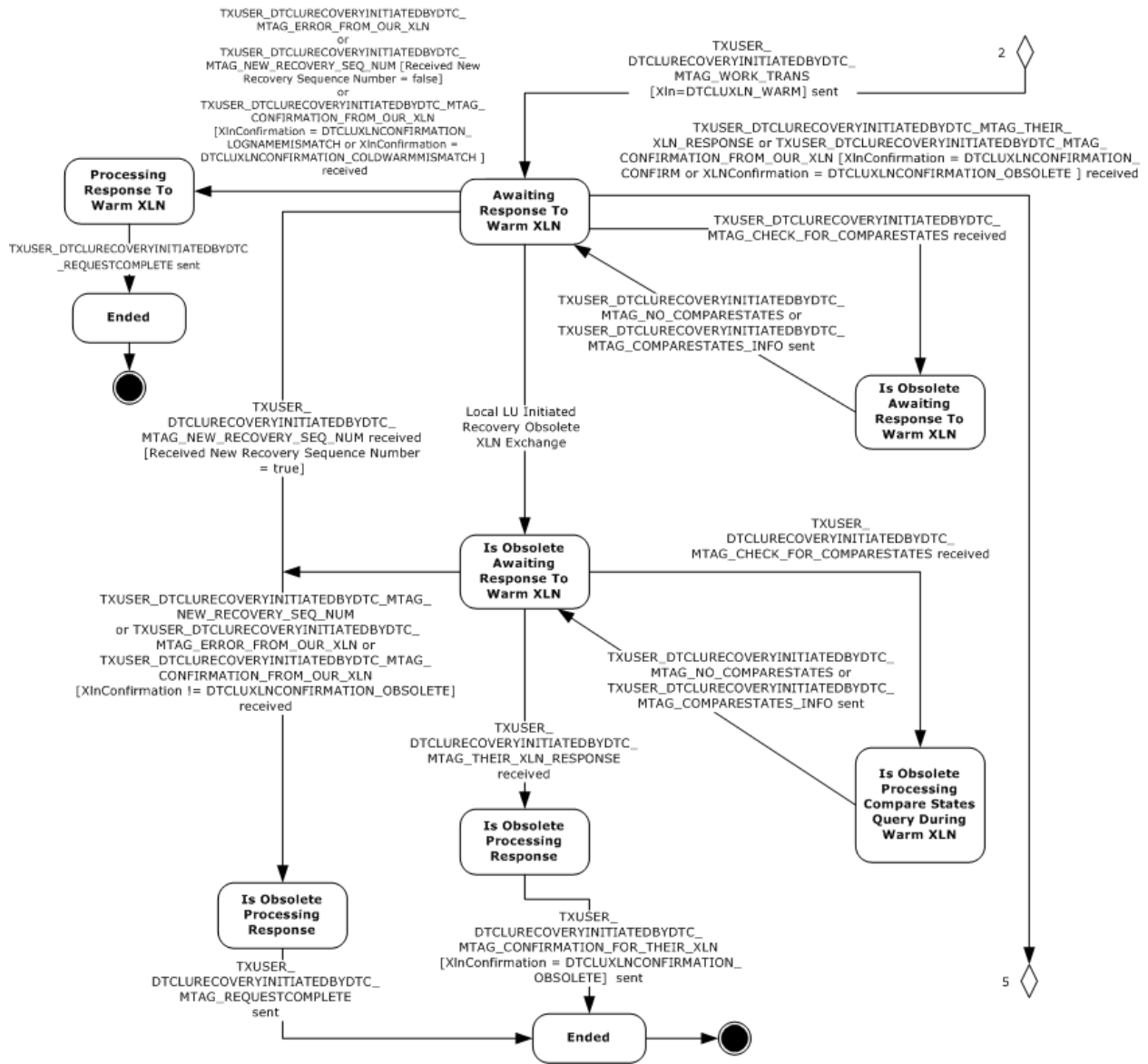

Figure 16: CONNTYPE_TXUSER_DTCLURECOVERYINITIATEDBYDTC, Part 3

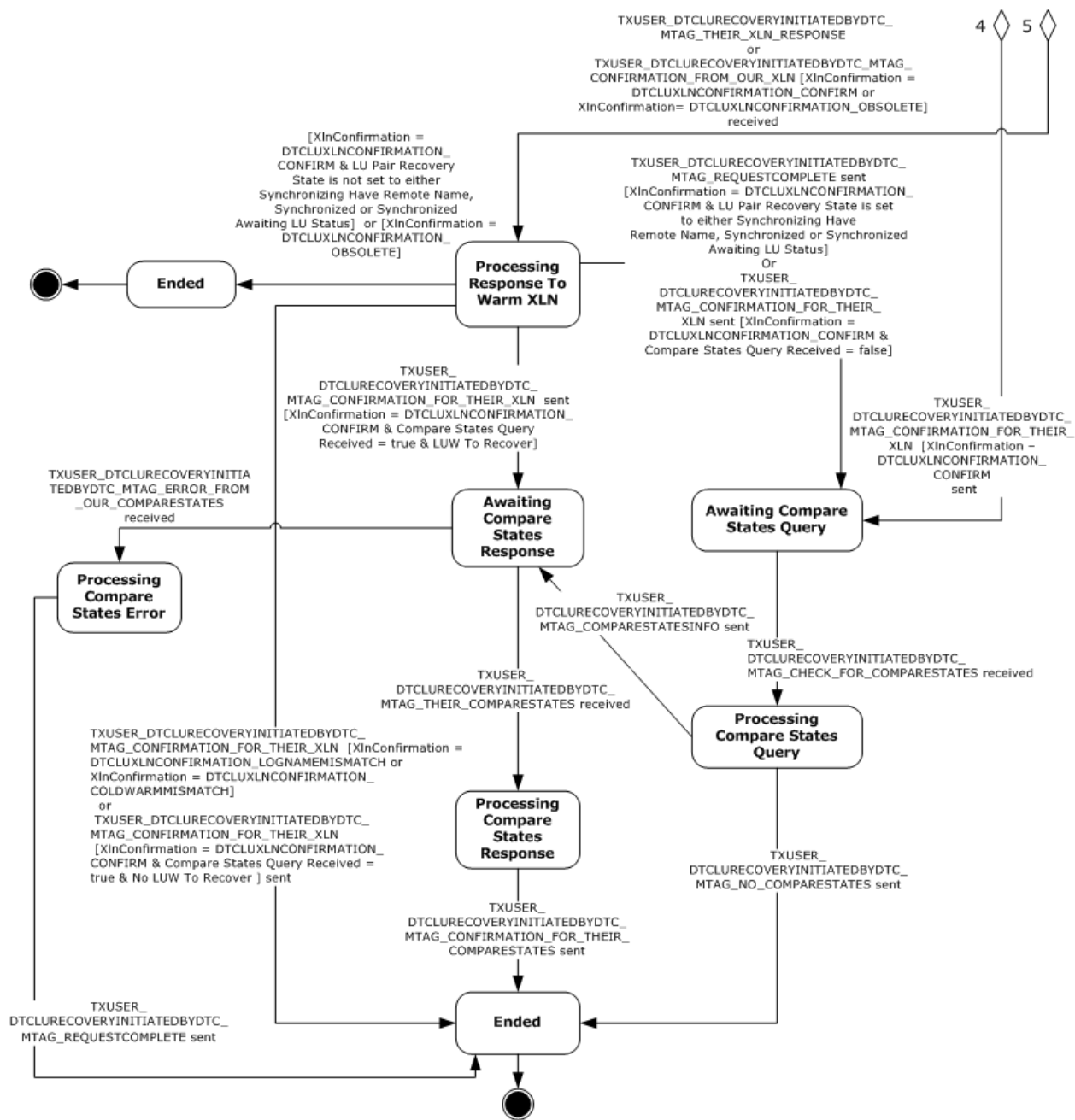

Figure 17: CONNTYPE_TXUSER_DTCLURECOVERYINITIATEDBYDTC, Part 4

3.3.1.6 CONNTYPE_TXUSER_DTCLURECOVERYINITIATEDBYLU Acceptor States

The Transaction Manager Communicating with an LU 6.2 Implementation Facet MUST act as an acceptor for the CONNTYPE_TXUSER_DTCLURECOVERYINITIATEDBYLU connection type. In this role, the Transaction Manager Communicating with an LU 6.2 Implementation Facet MUST provide support for the following states:

- Idle
- Processing XLN Request

- Awaiting XLN Confirmation
- Processing XLN Confirmation
- Awaiting Compare States Request
- Processing Compare States Request
- Awaiting Compare States Confirmation
- Processing Compare States Confirmation
- Is Obsolete Awaiting XLN Confirmation
- Ended

3.3.1.6.1 Idle

This is the initial state. The following event is processed in this state:

- Receiving a TXUSER_DTCLURECOVERYINITIATEDBYLU_MTAG_THEIR_XLN message (section 3.3.5.5.1)

3.3.1.6.2 Processing XLN Request

This is a transient state that is assumed during the synchronous processing of a XLN request. No events are processed in this state.

3.3.1.6.3 Awaiting XLN Confirmation

The following events are processed in this state:

- Receiving a TXUSER_DTCLURECOVERYINITIATEDBYLU_MTAG_CONFIRMATION_OF_OUR_XLN message (section 3.3.5.5.2)
- Remote LU Initiated Recovery Obsolete XLN Exchange
- Connection Disconnected (section 3.3.5.5.6)

3.3.1.6.4 Processing XLN Confirmation

This is a transient state that is assumed during the synchronous processing of an XLN confirmation request. No events are processed in this state.

3.3.1.6.5 Awaiting Compare States Request

The following event is processed in this state:

- Receiving a TXUSER_DTCLURECOVERYINITIATEDBYLU_MTAG_THEIR_COMPARESTATES message (section 3.3.5.5.3)
- Connection Disconnected (section 3.3.5.5.6)

3.3.1.6.6 Processing Compare States Request

This is a transient state that is assumed during the synchronous processing of a Compare States request. No events are processed in this state.

3.3.1.6.7 Awaiting Compare States Confirmation

The following events are processed in this state:

- Receiving a TXUSER_DTCLURECOVERYINITIATEDBYLU_MTAG_CONFIRMATION_OF_OUR_COMPARESTATES message (section 3.3.5.5.4)
- Receiving a TXUSER_DTCLURECOVERYINITIATEDBYLU_MTAG_ERROR_OF_OUR_COMPARESTATES message (section 3.3.5.5.5)
- Connection Disconnected (section 3.3.5.5.6)

3.3.1.6.8 Processing Compare States Confirmation

This is a transient state that is assumed during the synchronous processing of a Compare States confirmation request. No events are processed in this state.

3.3.1.6.9 Is Obsolete Awaiting XLN Confirmation

The following events are processed in this state:

- Receiving a TXUSER_DTCLURECOVERYINITIATEDBYLU_MTAG_CONFIRMATION_OF_OUR_XLN message (section 3.3.5.5.2)
- Connection Disconnected (section 3.3.5.5.6)

3.3.1.6.10 Ended

This is the final state.

3.3.1.6.11 State Diagram

The following figure shows the relationship between the CONNTYPE_TXUSER_DTCLURECOVERYINITIATEDBYLU acceptor states.

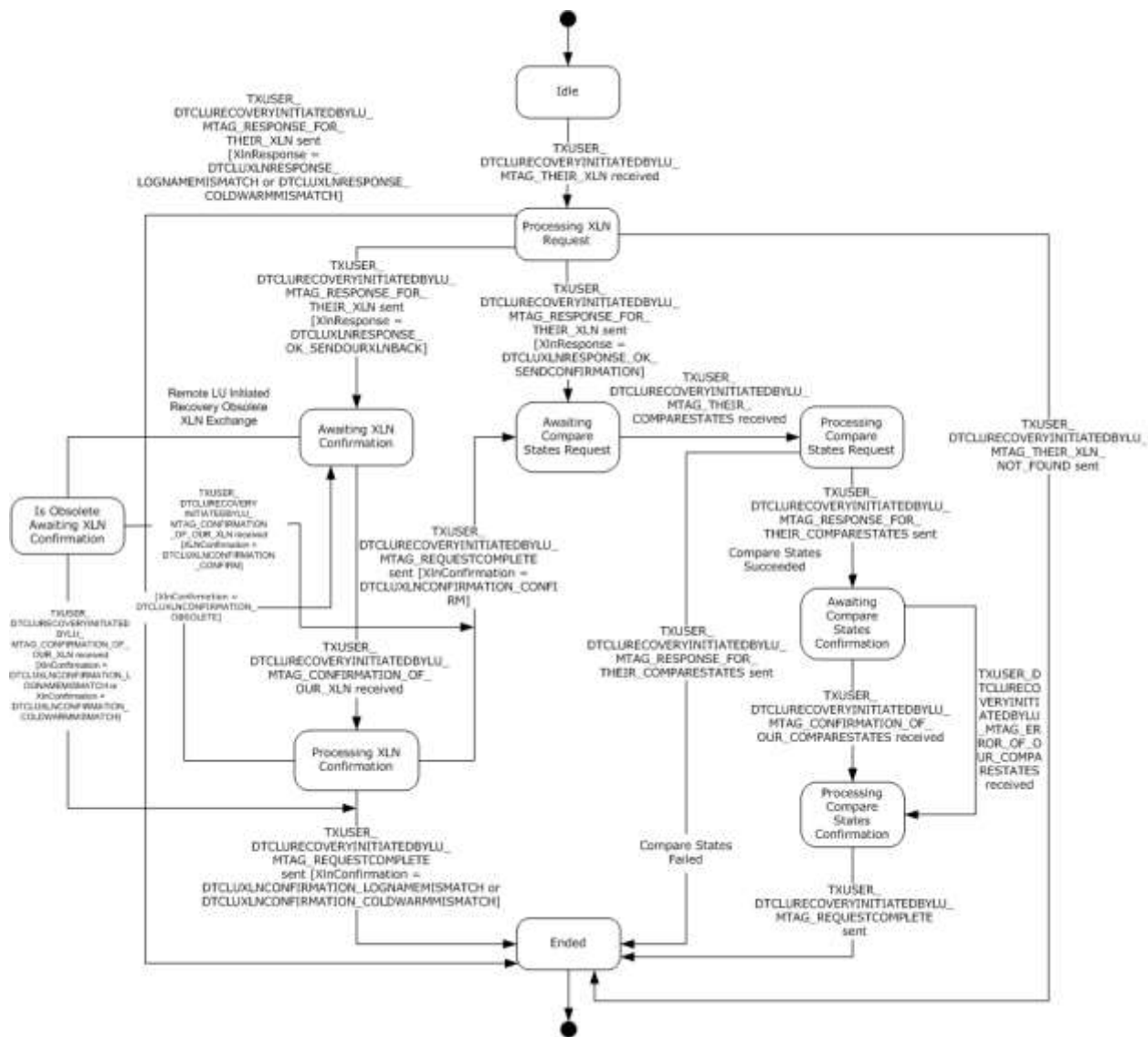

Figure 18: CONNTYPE_TXUSER_DTCLURECOVERYINITIATEDBYLU acceptor states

3.3.2 Timers

The Transaction Manager Communicating with an LU 6.2 Implementation Facet MUST provide the timer that is specified in the next section.

3.3.2.1 LU Status Timer

The **LU Status timer** is a nonrecurring timer. The timer MUST be started whenever an **LU Pair** object is synchronized and no recovery is in progress, as specified by the processing of the Synchronization Successful and Received LU Status events.

The value of the timer is set to an implementation-specific value.<5>

When the timer is initialized, the Transaction Manager Communicating with an LU 6.2 Implementation Facet MUST provide an **LU Pair** object to associate with the timer. When the timer expires, the LU Status Timer Tick event MUST be signaled with the same **LU Pair** object as the only argument. The

Transaction Manager Communicating with an LU 6.2 Implementation Facet MUST provide a distinct LU Status timer instance for each **LU Pair** object.

3.3.3 Initialization

The Transaction Manager Communicating with an LU 6.2 Implementation Facet MUST examine the following security flags on the Core Transaction Manager Facet (as specified in [MS-DTCO] section 3.2) and perform the following actions:

- If either the **Allow Network Access** flag or the **Allow Remote Clients** flag is set to FALSE, it MUST refuse to accept incoming connections from remote machines as specified in [MS-CMP] section 3.1.5.5, with the rejection reason set to 0x80070005 for the following connection types:
 - CONNTYPE_TXUSER_DTCLUCONFIGURE
 - CONNTYPE_TXUSER_DTCLURECOVERY
 - CONNTYPE_TXUSER_DTCLURMENLISTMENT
 - CONNTYPE_TXUSER_DTCLURECOVERYINITIATEDBYDTC
 - CONNTYPE_TXUSER_DTCLURECOVERYINITIATEDBYLU
- If both the **Allow Network Access** flag and **Allow Remote Clients** flag are set to TRUE and **Allow LU Transactions** flag as defined in [MS-DTCO] section 3.2.1 is set to FALSE, it MUST refuse to accept the following connection types, as specified in [MS-CMP] section 3.1.5.5, with the rejection reason set to 0x80070005:
 - CONNTYPE_TXUSER_DTCLUCONFIGURE
 - CONNTYPE_TXUSER_DTCLURECOVERY
 - CONNTYPE_TXUSER_DTCLURMENLISTMENT
 - CONNTYPE_TXUSER_DTCLURECOVERYINITIATEDBYDTC
 - CONNTYPE_TXUSER_DTCLURECOVERYINITIATEDBYLU

3.3.4 Higher-Layer Triggered Events

The operation of the Core Transaction Manager Facet MUST be prepared to process the higher-layer events in this section.

3.3.4.1 Recover

This event is triggered by the higher-layer software hosting infrastructure when it reinitializes the system after a software failure or restart.

When the Transaction Manager Communicating with an LU 6.2 Implementation Facet is asked to Recover after a software failure or restart, it MUST perform the following actions:

- For each **LU Pair** object in the log of the Transaction Manager Communicating with an LU 6.2 Implementation Facet:
 - Copy the **LU Pair** object to the LU Pair Table of the Transaction Manager Communicating with an LU 6.2 Implementation Facet.
- For each **LU Pair** object in the LU Pair Table of the Transaction Manager Communicating with an LU 6.2 Implementation Facet:

- For each LUW object in the LUW List of the currently referenced **LU Pair** object:
 - Attempt to find a transaction in the transaction table of the transaction manager (as specified in [MS-DTCO] section 3.1.1) that meets the following condition:
 - The value of the **Transaction Object.Identifier** field of the **Transaction** object is set to the value of the **Transaction Identifier** field of the currently referenced **LUW** object.
 - If a transaction that meets the preceding condition is found:
 - If the local LU LUW State of the currently referenced **LUW** object is set to Forget:
 - Continue processing for the next **LUW** object in the **LUW** List.
 - Otherwise:
 - Signal the Request Transaction Outcome event (as specified in [MS-DTCO] section 3.2.7.33) on the Core Transaction Manager Facet with the following argument:
 - The Enlistment object of the currently referenced **LUW** object.
 - Otherwise:
 - Set the local LU LUW State of the currently referenced **LUW** object to Reset.
 - Set the LUW Recovery State of the currently referenced **LUW** object to Need Recovery.
 - Signal the Recovery Work Ready event with the following arguments:
 - The currently referenced **LU Pair** object.
 - The Recovery Work Ready Reason set to LUW Recovery.
- All incoming connections MUST be rejected until the Core Transaction Manager Facet signals the Begin Commit event or Begin Rollback event for each transaction. Connection rejection is as specified in [MS-CMP] section 3.1.5.5, with the rejection reason value set to 0x80070005.

3.3.5 Message Processing Events and Sequencing Rules

3.3.5.1 CONNTYPE_TXUSER_DTCLUCONFIGURE as Acceptor

For all messages received in this Connection Type, the Transaction Manager Communicating with an LU 6.2 Implementation Facet MUST process the message, as specified in section 3.1. The Transaction Manager Communicating with an LU 6.2 Implementation Facet MUST also follow the processing rules specified in the following sections.

3.3.5.1.1 Receiving a TXUSER_DTCLURMCONFIGURE_MTAG_ADD Message

When the Transaction Manager Communicating with an LU 6.2 Implementation Facet receives a TXUSER_DTCLURMCONFIGURE_MTAG_ADD (section 2.2.3.1.1) message, it MUST perform the following actions:

- If the connection state is Idle:
 - Set the connection state to Processing Add Request.

- Attempt to find the **LU Pair** object keyed by the first **cbLength** bytes of the **rgbBlob** field of the DTCLU_VARLEN_BYTEARRAY structure (contained in the **LuNamePair** field) of the message in the LU Pair Table.
- If the **LU Pair** object is found:
 - Send the TXUSER_DTCLURMCONFIGURE_MTAG_ADD_DUPLICATE (section 2.2.3.1.4) message using the connection.
- Otherwise:
 - Create an **LU Pair** object that is initialized as follows:
 - Set the **LU Name Pair** field to the first **cbLength** bytes of the **rgbBlob** field of the DTCLU_VARLEN_BYTEARRAY structure (contained in the **LuNamePair** field) of the message.
 - Set the **Local Log Name** field to an implementation-specific value.
 - Set the **Resource Manager Identifier** field to a new GUID value.
 - Set the **Recovery Sequence Number** field to 1.
 - Set the **Is Warm** flag to FALSE.
 - Set the **LU Pair Recovery State** field to Recovery Process Not Attached.
 - Set the **Is LUW Triggered Recovery Pending** flag to FALSE.
 - Attempt to add the new **LU Pair** object to the log and the LU Pair Table keyed by the first **cbLength** bytes of the **rgbBlob** field of the DTCLU_VARLEN_BYTEARRAY structure (contained in the **LuNamePair** field) of the message.
 - If LU Pair is added successfully:
 - Send the TXUSER_DTCLURMCONFIGURE_MTAG_REQUEST_COMPLETED (section 2.2.3.1.3) message using the connection.
 - Otherwise:
 - Send the TXUSER_DTCLURMCONFIGURE_MTAG_ADD_LOG_FULL message using the connection.
 - Set the connection state to Ended.
- Otherwise, if the connection state is Ended:
 - Ignore the message.
- Otherwise, the message MUST be processed as an invalid message, as specified in [MS-DTCO], section 3.1.6.

3.3.5.1.2 Receiving a TXUSER_DTCLURMCONFIGURE_MTAG_DELETE Message

The Transaction Manager Communicating with an LU 6.2 Implementation Facet MUST perform the following actions when it receives a TXUSER_DTCLURMCONFIGURE_MTAG_DELETE message:

- If the connection state is Idle:
 - Set the connection state to Processing Delete Request.

- Attempt to find the **LU Pair** object keyed by the first **cbLength** bytes of the **rgbBlob** field of the DTCLU_VARLEN_BYTEARRAY structure (contained in the **LuNamePair** field) of the message in the LU Pair Table.
- If the **LU Pair** object is not found:
 - Send the TXUSER_DTCLURMCONFIGURE_MTAG_DELETE_NOT_FOUND message using the connection.
- Otherwise:
 - If the **LU Pair Recovery State** field of the **LU Pair** object is not set to Recovery Process Not Attached:
 - Send the TXUSER_DTCLURMCONFIGURE_MTAG_DELETE_INUSE message using the connection.
 - Otherwise:
 - If the LUW List of the found **LU Pair** object is not empty:
 - Send the TXUSER_DTCLURMCONFIGURE_MTAG_DELETE_UNRECOVERED_TRANS message using the connection.
 - Otherwise:
 - Remove the found **LU Pair** object from the LU Pair Table and the log.
 - Send the TXUSER_DTCLURMCONFIGURE_MTAG_REQUEST_COMPLETED message using the connection.
- Set the connection state to Ended.
- Otherwise, if the connection state is Ended:
 - Ignore the message.
- Otherwise, the message MUST be processed as an invalid message, as specified in [MS-DTCO], section 3.1.6.

3.3.5.2 CONNTYPE_TXUSER_DTCLURECOVERY as Acceptor

For all messages received in this connection type, the Transaction Manager Communicating with an LU 6.2 Implementation Facet MUST process the message, as specified in section 3.1. The Transaction Manager Communicating with an LU 6.2 Implementation Facet MUST also follow the processing rules specified in the following sections.

3.3.5.2.1 Receiving a TXUSER_DTCLURMRECOVERY_MTAG_ATTACH Message

A Transaction Manager Communicating with an LU 6.2 Implementation Facet MUST perform the following actions to attempt to register the connection's MSDTC Connection Manager: OleTx Transports Protocol (as specified in [MS-CMPO]) session for all recovery processing associated with the LU Name Pair when it receives a TXUSER_DTCLURMRECOVERY_MTAG_ATTACH (section 2.2.3.2.1) message:

- If the connection state is Idle:
 - Set the connection state to Processing Register Request.

- Attempt to find the **LU Pair** object keyed by the first **cbLength** bytes of the **rgbBlob** field of the DTCLU_VARLEN_BYTEARRAY structure (contained in the **LuNamePair** field) of the message in the LU Pair Table.
- If the **LU Pair** object is not found:
 - Send the TXUSER_DTCLURMRECOVERY_MTAG_ATTACH_NOT_FOUND (section 2.2.3.2.4) message using the connection.
 - Set the connection state to Ended (section 3.3.1.3.4).
- Otherwise:
 - If the **LU Pair Recovery State** field of the found **LU Pair** object is set to Recovery Process Not Attached:
 - Set the **LU Pair Recovery State** field of the found **LU Pair** object to Not Synchronized.
 - Send the TXUSER_DTCLURMRECOVERY_MTAG_REQUEST_COMPLETED (section 2.2.3.2.2) message using the connection.
 - Set the connection state to Registered.
 - Otherwise:
 - Send the TXUSER_DTCLURMRECOVERY_MTAG_ATTACH_DUPLICATE (section 2.2.3.2.3) message using the connection.
 - Set the connection state to Ended.
- Otherwise, if the connection state is Ended:
 - Ignore the message.
- Otherwise, the message MUST be processed as an invalid message, as specified in [MS-DTCO], section 3.1.6.

3.3.5.2.2 Connection Disconnected

When a CONNTYPE_TXUSER_DTCLURECOVERY connection is disconnected, a Transaction Manager Communicating with an LU 6.2 Implementation Facet MUST perform the following actions:

- If the connection state is Registered:
 - Set the **LU Pair Recovery State** field of the **LU Pair** object referenced by this connection to Recovery Process Not Attached.
 - Set the connection state to Ended (section 3.3.1.3.4).
- Otherwise, the event MUST be processed as specified in [MS-DTCO] section 3.1.8.3

3.3.5.3 CONNTYPE_TXUSER_DTCLURMENLISTMENT as Acceptor

For all messages received in this connection type, the Transaction Manager Communicating with an LU 6.2 Implementation Facet MUST process the message as specified in section 3.1. The Transaction Manager Communicating with an LU 6.2 Implementation Facet MUST also follow the processing rules specified in the following sections.

3.3.5.3.1 Receiving a TXUSER_DTCLURMENLISTMENT_MTAG_CREATE Message

When the Transaction Manager Communicating with an LU 6.2 Implementation Facet receives a TXUSER_DTCLURMENLISTMENT_MTAG_CREATE (section 2.2.3.3.1) message, it MUST perform the following actions:

- If the connection state is Idle:
 - Set the connection state to Processing Enlistment Request.
 - Attempt to find the **LU Pair** object keyed by the value of the first **cbLength** bytes of the **rgbBlob** field of the DTCLU_VARLEN_BYTEARRAY structure (contained in the **LuNamePair** field) of the message in the LU Pair Table.
 - If the **LU Pair** object is not found:
 - Send a TXUSER_DTCLURMENLISTMENT_MTAG_CREATE_LU_NOT_FOUND (section 2.2.3.3.17) message using the connection.
 - Set the connection state to Ended (section 3.3.1.4.9).
 - Otherwise:
 - Set the **LU Pair** field of the connection object to the found **LU Pair** object.
 - If the **LU Pair Recovery State** field of the found **LU Pair** object is set to Recovery Process Not Attached:
 - Send a TXUSER_DTCLURMENLISTMENT_MTAG_CREATE_LU_NO_RECOVERY_PROCESS (section 2.2.3.3.20) message using the connection.
 - Set the connection state to Ended.
 - Otherwise, if the **LU Pair Recovery State** field of the found **LU Pair** object is set to Not Synchronized:
 - Send a TXUSER_DTCLURMENLISTMENT_MTAG_CREATE_LU_DOWN (section 2.2.3.3.21) message using the connection.
 - Set the connection state to Ended.
 - Otherwise, if the **LU Pair Recovery State** field of the found **LU Pair** object is set to either Synchronizing No Remote Name or Synchronizing Have Remote Name:
 - Send a TXUSER_DTCLURMENLISTMENT_MTAG_CREATE_LU_RECOVERING (section 2.2.3.3.22) message using the connection.
 - Set the connection state to Ended.
 - Otherwise, if the **LU Pair Recovery State** field of the found **LU Pair** object is set to Inconsistent:
 - Send a TXUSER_DTCLURMENLISTMENT_MTAG_CREATE_LU_RECOVERY_MISMATCH (section 2.2.3.3.23) message using the connection.
 - Set the connection state to Ended.

- Otherwise:
 - Attempt to find the **Transaction** object keyed by the value of the **guidTx** field of the message in the Transaction table of the Core Transaction Manager Facet.
 - If the **Transaction** object is not found:
 - Send a TXUSER_DTCLURMENLISTMENT_MTAG_CREATE_TX_NOT_FOUND (section 2.2.3.3.13) message using the connection.
 - Set the connection state to Ended.
 - Otherwise:
 - Attempt to find an LUW object with its **LUW Identifier** field set to the value of the first **cbLength** bytes of the **rgbBlob** field of the DTCLU_VARLEN_BYTEARRAY structure (contained in the **LuTransId** field) of the message in the LUW List of the found **LU Pair** object.
 - If an **LUW** object is found:
 - Send a TXUSER_DTCLURMENLISTMENT_MTAG_CREATE_DUPLICATE_LU_TRANSID (section 2.2.3.3.19) message using the connection.
 - Set the connection state to Ended.
 - Otherwise:
 - Create a new Enlistment object that is initialized as follows:
 - Set the **Transaction Manager Facet** field to the Transaction Manager Communicating with an LU 6.2 Implementation Facet.
 - Set the **Transaction** field to the found **Transaction** object.
 - Set the **Resource Manager Identifier** field to the resource manager identifier field of the found **LU Pair** object.
 - Set the **Connection** field to the connection object.
 - Create a new **LUW** object that is initialized as follows:
 - Set the **Transaction Identifier** field to the **guidTx** field of the message.
 - Set the **LUW Identifier** field to the first **cbLength** bytes of the **rgbBlob** field of the DTCLU_VARLEN_BYTEARRAY structure (contained in the **LuTransId** field) of the message.
 - Set the **Enlistment** field to the new **Enlistment** object.
 - Set the **Recovery Sequence Number For LUW** field to the **Recovery Sequence Number** field of the found **LU Pair** object.
 - Set the **Local LU LUW State** field to Active.
 - Set the **LUW Recovery State** field to Recovery Not Needed.
 - Set the **Is Conversation Lost** Flag to FALSE.
 - Set the **LUW** field on the connection to refer to the new **LUW** object.

- Add the new **LUW** object to the **LUW** List of the found **LU Pair Object**.
- Signal the Create Subordinate Enlistment event (as specified in [MS-DTCO] section 3.2.7.11) on the Core Transaction Manager Facet with the following argument:
 - The new **Enlistment** object.
- Otherwise, if the connection state is Ended:
 - Ignore the message.
- Otherwise, the message **MUST** be processed as an invalid message, as specified in [MS-DTCO], section 3.1.6.

3.3.5.3.2 Receiving a TXUSER_DTCLURMENLISTMENT_MTAG_TO_DTC_REQUESTCOMMIT Message

When the Transaction Manager Communicating with an LU 6.2 Implementation Facet receives a TXUSER_DTCLURMENLISTMENT_MTAG_TO_DTC_REQUESTCOMMIT (section 2.2.3.3.8) message, it **MUST** perform the following actions:

- If the connection state is Awaiting Prepare Response:
 - Signal the Enlistment Phase One Complete event (as specified in [MS-DTCO] section 3.2.7.16) on the Core Transaction Manager Facet with the following arguments:
 - The Enlistment object of the LUW object referenced by this connection
 - The Phase One outcome set to Prepared
 - Set the connection state to Prepared.
- Otherwise, if the connection state is Ended:
 - Ignore the message.
- Otherwise, the message **MUST** be processed as an invalid message, as specified in [MS-DTCO], section 3.1.6.

3.3.5.3.3 Receiving a TXUSER_DTCLURMENLISTMENT_MTAG_TO_DTC_BACKOUT Message

When the Transaction Manager Communicating with an LU 6.2 Implementation Facet receives a TXUSER_DTCLURMENLISTMENT_MTAG_TO_DTC_BACKOUT (section 2.2.3.3.5) message, it **MUST** perform the following actions:

- If the connection state is Active:
 - Set the Local LU LUW State field of the LUW object referenced by this connection to Reset.
 - Signal the Enlistment Unilaterally Aborted event (as specified in [MS-DTCO] section 3.2.7.19) on the Core Transaction Manager Facet with the following arguments:
 - The Enlistment object of the LUW object referenced by this connection
 - Set the connection state to Processing Backout Request.
- Otherwise, if the connection state is Awaiting Prepare Response:
 - Set the Local LU LUW State of the LUW object referenced by this connection to Forget.

- Signal the Enlistment Phase One Complete event (as specified in [MS-DTCO] section 3.2.7.16) on the Core Transaction Manager Facet with the following arguments:
 - The Enlistment object of the LUW object referenced by this connection
 - The Phase One outcome set to Aborted.
- Set the connection state to Processing Backout Request.
- Otherwise, if the connection state is Ended:
 - Ignore the message.
- Otherwise, the message MUST be processed as an invalid message, as specified in [MS-DTCO], section 3.1.6.

3.3.5.3.4 Receiving a TXUSER_DTCLURMENLISTMENT_MTAG_TO_DTC_FORGET Message

When the Transaction Manager Communicating with an LU 6.2 Implementation Facet receives a TXUSER_DTCLURMENLISTMENT_MTAG_TO_DTC_FORGET message, it MUST perform the following actions:

- If the connection state is Awaiting Prepare Response:
 - Set the **Local LU LUW State** field of the LUW object referenced by this connection to Forget.
 - Signal the Enlistment Phase One Complete event (as specified in [MS-DTCO] section 3.2.7.16) on the Core Transaction Manager Facet with the following arguments:
 - The Enlistment object of the LUW object referenced by this connection
 - The Phase One outcome set to Read Only
 - Set the connection state to Ended.
- Otherwise, if the connection state is Awaiting Commit Response:
 - Set the Local LU LUW State of the LUW object referenced by this connection to Forget.
 - Signal the Enlistment Commit Complete event (as specified in [MS-DTCO] section 3.2.7.15) on the Core Transaction Manager Facet with the following argument:
 - The Enlistment object of the LUW object referenced by this connection
 - Set the connection state to Ended.
- Otherwise, if the connection state is Ended:
 - Ignore the message.
- Otherwise, the message MUST be processed as an invalid message, as specified in [MS-DTCO], section 3.1.6.

3.3.5.3.5 Receiving a TXUSER_DTCLURMENLISTMENT_MTAG_TO_DTC_BACKEDOUT Message

When the Transaction Manager Communicating with an LU 6.2 Implementation Facet receives a TXUSER_DTCLURMENLISTMENT_MTAG_TO_DTC_BACKEDOUT message, it MUST perform the following actions:

- If the connection state is Awaiting Abort Response:
 - Set the Local LU LUW State of the LUW object referenced by this connection to Forget.
 - Signal the Enlistment Rollback Complete event (as specified in [MS-DTCO] section 3.2.7.18) on the Core Transaction Manager Facet with the following argument:
 - The Enlistment object of the LUW object referenced by this connection
 - Set the connection state to Ended.
- Otherwise, if the connection state is Ended:
 - Ignore the message.
- Otherwise, the message MUST be processed as an invalid message, as specified in [MS-DTCO], section 3.1.6.

3.3.5.3.6 Receiving a TXUSER_DTCLURMENLISTMENT_MTAG_TO_DTC_CONVERSATIONLOST Message

When the Transaction Manager Communicating with an LU 6.2 Implementation Facet receives a TXUSER_DTCLURMENLISTMENT_MTAG_TO_DTC_CONVERSATIONLOST message, it MUST perform the following actions:

- If the connection state is either Idle or Processing Enlistment Request:
 - Set the connection state to Ended.
- Otherwise, if the connection state is either Active or Processing Backout Request:
 - If the Local LU LUW State of the LUW object referenced by this connection is Active:
 - Set the Local LU LUW State of the LUW object referenced by this connection to Reset.
 - Signal the LUW Conversation Lost event using the following arguments:
 - The LU Pair object referenced by this connection
 - The LUW object referenced by this
 - Set the connection state to Ended.
- Otherwise, if the connection state is either Awaiting Prepare Response, Prepared, Awaiting Commit Response, or Awaiting Abort Response:
 - If the Local LU LUW State of the LUW object referenced by this connection is Active:
 - Set the Local LU LUW State of the LUW object referenced by this connection to Reset.
 - Set the LUW Recovery State of the LUW object referenced by this connection to Need Recovery.
 - Signal the LUW Conversation Lost event using the following arguments:
 - The LU Pair object referenced by this connection
 - The LUW object referenced by this connection
 - Set the connection state to Ended.

- Otherwise, if the connection state is Ended:
 - Ignore the message.
- Otherwise, the message **MUST** be processed as an invalid message, as specified in [MS-DTCO], section 3.1.6.

3.3.5.3.7 Connection Disconnected

When a CONNTYPE_TXUSER_DTCLURMENLISTMENT connection is disconnected, the Transaction Manager Communicating with an LU 6.2 Implementation Facet **MUST** perform the following actions:

- If the connection state is either Idle or Processing Enlistment Request:
 - Set the connection state to Ended.
- Otherwise, if the connection state is either Active or Processing Backout Request:
 - If the Local LU LUW State of the LUW object referenced by this connection is Active:
 - Set the Local LU LUW State of the LUW object referenced by this connection to Reset.
 - Signal the LUW Conversation Lost event using the following arguments:
 - The LU Pair object referenced by this connection
 - The LUW object referenced by this connection
 - Set the connection state to Ended.
- Otherwise, if the connection state is either Awaiting Prepare Response, Prepared, Awaiting Commit Response, or Awaiting Abort Response:
 - If the Local LU LUW State of the LUW object referenced by this connection is Active:
 - Set the Local LU LUW State of the LUW object referenced by this connection to Reset.
 - Set the LUW Recovery State of the LUW object referenced by this connection to Need Recovery.
 - Signal the LUW Conversation Lost event using the following arguments:
 - The LU Pair object referenced by this connection
 - The LUW object referenced by this connection
 - Set the connection state to Ended.
- Otherwise, if the connection state is Ended:
 - Ignore the event.
- Otherwise, the event **MUST** be processed as specified in [MS-DTCO] section 3.1.8.3.

3.3.5.4 CONNTYPE_TXUSER_DTCLURECOVERYINITIATEDBYDTC as Acceptor

For all messages received in this connection type, the transaction manager **MUST** process the message, as specified in 3.1. The transaction manager **MUST** additionally follow the processing rules specified in the following sections.

3.3.5.4.1 Receiving a TXUSER_DTCLURECOVERYINITIATEDBYDTC_MTAG_GETWORK Message

When the Transaction Manager Communicating with an LU 6.2 Implementation Facet receives a TXUSER_DTCLURECOVERYINITIATEDBYDTC_MTAG_GETWORK message, it MUST perform the following actions:

- If the connection state is Idle:
 - Set the connection state to Processing Work Query.
 - Attempt to find the LU Pair object keyed by the value of the first **cbLength** bytes of the **rgbBlob** field of the DTCLU_VARLEN_BYTEARRAY structure (contained in the **LuNamePair** field) of the message in the LU Pair Table.
 - If the LU Pair object is not found:
 - Send a TXUSER_DTCLURECOVERYINITIATEDBYDTC_MTAG_GETWORK_NOT_FOUND message using the connection.
 - Set the connection state to Ended (section 3.3.1.5.20).
 - Otherwise, if the LU Pair object is found:
 - Set the **LU Pair** field of the connection object to the LU Pair object found in the LU Pair Table.
 - Set the **Recovery Sequence Number For Connection** field of the connection object to the **Recovery Sequence Number** field of the LU Pair object referenced by the connection.
 - Add the connection object to the Local LU Initiated Recovery List.
 - Signal the Recovery Work Ready event with the following arguments:
 - The LU Pair object referenced by this connection
 - A Recovery Work Ready Reason of Miscellaneous
- Otherwise, if the connection state is Ended (section 3.3.1.5.20):
 - Ignore the message.
- Otherwise, the message MUST be processed as an invalid message, as specified in [MS-DTCL], section 3.1.6.

3.3.5.4.2 Receiving a TXUSER_DTCLURECOVERYINITIATEDBYDTC_MTAG_NEW_RECOVERY_SEQ_NUM Message

When the Transaction Manager Communicating with an LU 6.2 Implementation Facet receives a TXUSER_DTCLURECOVERYINITIATEDBYDTC_MTAG_NEW_RECOVERY_SEQ_NUM message, it MUST perform the following actions:

- If the connection state is Awaiting Response To Cold XLN:
 - Signal the Received New Recovery Sequence Number event with the following arguments.
 - The LU Pair object referenced by this connection
 - The value of the **RecoverySeqNum** field of the message

- If the return value from the Received New Recovery Sequence Number event is TRUE:
 - Set the connection state to Is Obsolete Processing Response.
- Otherwise:
 - Set the connection state to Processing Response To Cold XLN.
- Send a TXUSER_DTCLURECOVERYINITIATEDBYDTC_MTAG_REQUESTCOMPLETE message using the connection.
- Signal the Local LU Initiated Recovery Worker Ended event with the following arguments:
 - The LU Pair object referenced by this connection
 - The connection object
- Set the connection state to Ended (section 3.3.1.5.20).
- Otherwise, if the connection state is Awaiting Response To Warm XLN:
 - Signal the Received New Recovery Sequence Number event with the following arguments:
 - The LU Pair object referenced by this connection
 - The value of the **RecoverySeqNum** field of the message
 - If the return value from the Received New Recovery Sequence Number event is TRUE:
 - Set the connection state to Is Obsolete Processing Response.
 - Otherwise:
 - Set the connection state to Processing Response To Warm XLN.
 - Send a TXUSER_DTCLURECOVERYINITIATEDBYDTC_MTAG_REQUESTCOMPLETE message using the connection.
 - Signal the Local LU Initiated Recovery Worker Ended event with the following arguments:
 - The LU Pair object referenced by this connection
 - The connection object
 - Set the connection state to Ended (section 3.3.1.5.20).
- Otherwise, if the connection state is either Is Obsolete Awaiting Response To Cold XLN or Is Obsolete Awaiting Response To Warm XLN:
 - Set the connection state to Is Obsolete Processing Response.
 - Send a TXUSER_DTCLURECOVERYINITIATEDBYDTC_MTAG_REQUESTCOMPLETE message using the connection.
 - Signal the Local LU Initiated Recovery Worker Ended event with the following arguments:
 - The LU Pair object referenced by this connection
 - The connection object
 - Set the connection state to Ended (section 3.3.1.5.20).
- Otherwise, if the connection state is Ended (section 3.3.1.5.20):

- Ignore the message.
- Otherwise, the message MUST be processed as an invalid message, as specified in [MS-DTCO], section 3.1.6.

3.3.5.4.3 Receiving a TXUSER_DTCLURECOVERYINITIATEDBYDTC_MTAG_CONFIRMATION_FROM_OUR_XLN Message

When the Transaction Manager Communicating with an LU 6.2 Implementation Facet receives a TXUSER_DTCLURECOVERYINITIATEDBYDTC_MTAG_CONFIRMATION_FROM_OUR_XLN message, it MUST perform the following actions:

- If the connection state is Awaiting Response To Warm XLN:
 - Set the connection state to Processing Response To Warm XLN.
- If the **XlnConfirmation** field of the message is set to DTCLUXLNCONFIRMATION_CONFIRM:
 - If the LU Pair Recovery State of the LU Pair object referenced by this connection is set to either Synchronizing Have Remote Name, Synchronized, or Synchronized Awaiting LU Status:
 - Signal the Synchronization Successful event with the following argument:
 - The LU Pair object referenced by this connection
 - Send a TXUSER_DTCLURECOVERYINITIATEDBYDTC_MTAG_REQUESTCOMPLETE message using the connection.
 - Set the connection state to Awaiting Compare States Query.
 - Otherwise:
 - The transaction manager that communicates with an LU 6.2 implementation (section 3.2) MUST drop the connection.
 - Signal the Local LU Initiated Recovery Worker Ended event with the following arguments:
 - The LU Pair object referenced by this connection
 - The connection object
 - Set the connection state to Ended (section 3.3.1.5.20).
- Otherwise, if the **XlnConfirmation** field of the message is set to either DTCLUXLNCONFIRMATION_LOGNAMEMISMATCH or DTCLUXLNCONFIRMATION_COLDWARMISMATCH:
 - Signal the Synchronization Inconsistent event with the following argument:
 - The LU Pair object referenced by this connection
 - Send a TXUSER_DTCLURECOVERYINITIATEDBYDTC_MTAG_REQUESTCOMPLETE message using the connection.
 - Signal the Local LU Initiated Recovery Worker Ended event with the following arguments:
 - The LU Pair object referenced by this connection

- The connection object
 - Set the connection state to Ended (section 3.3.1.5.20).
- Otherwise:
 - The transaction manager that communicates with an LU 6.2 Implementation MUST drop the connection.
 - Signal the Local LU Initiated Recovery Worker Ended event with the following arguments:
 - The LU Pair object referenced by this connection
 - The connection object
 - Set the connection state to Ended (section 3.3.1.5.20).
- Otherwise, if the connection state is Is Obsolete Awaiting Response to Warm XLN:
 - Set the connection state to Is Obsolete Processing Response.
 - If the **XInConfirmation** field of the message is not set to DTCLUXLNCONFIRMATION_LOGNAMEMISMATCH, DTCLUXLNCONFIRMATION_COLDWARMISMATCH, or DTCLUXLNCONFIRMATION_CONFIRM:
 - The transaction manager that communicates with an LU 6.2 Implementation MUST drop the connection.
 - Signal the Local LU Initiated Recovery Worker Ended event with the following arguments:
 - The LU Pair object referenced by this connection
 - The connection object
 - Set the connection state to Ended (section 3.3.1.5.20).
 - Otherwise:
 - Send a TXUSER_DTCLURECOVERYINITIATEDBYDTC_MTAG_REQUESTCOMPLETE message using the connection.
 - Signal the Local LU Initiated Recovery Worker Ended event with the following arguments:
 - The LU Pair object referenced by this connection
 - The connection object
 - Set the connection state to Ended (section 3.3.1.5.20).
- Otherwise, if the connection state is Ended (section 3.3.1.5.20):
 - Ignore the message.
- Otherwise, the message MUST be processed as an invalid message, as specified in [MS-DTCO], section 3.1.6.

3.3.5.4.4 Receiving a TXUSER_DTCLURECOVERYINITIATEDBYDTC_MTAG_ERROR_FROM_OUR_XLN Message

When the Transaction Manager Communicating with an LU 6.2 Implementation Facet receives a TXUSER_DTCLURECOVERYINITIATEDBYDTC_MTAG_ERROR_FROM_OUR_XLN message, it MUST perform the following actions:

- If the connection state is Awaiting Response To Cold XLN:
 - Set the connection state to Processing Response To Cold XLN.
 - Signal the Synchronization Inconsistent event with the following arguments:
 - The LU Pair object referenced by this connection
 - Send a TXUSER_DTCLURECOVERYINITIATEDBYDTC_MTAG_REQUESTCOMPLETE message using the connection.
 - Signal the Local LU Initiated Recovery Worker Ended event with the following arguments:
 - The LU Pair object referenced by this connection
 - The connection object
 - Set the connection state to Ended (section 3.3.1.5.20).
- Otherwise, if the connection state is Awaiting Response To Warm XLN:
 - Set the connection state to Processing Response To Warm XLN.
 - Signal the Synchronization Inconsistent event with the following arguments:
 - The LU Pair object referenced by this connection
 - Send a TXUSER_DTCLURECOVERYINITIATEDBYDTC_MTAG_REQUESTCOMPLETE message using the connection.
 - Signal the Local LU Initiated Recovery Worker Ended event with the following arguments:
 - The LU Pair object referenced by this connection
 - The connection object
 - Set the connection state to Ended (section 3.3.1.5.20).
- Otherwise, if the connection state is either Is Obsolete Awaiting Response To Cold XLN or Is Obsolete Awaiting Response To Warm XLN:
 - Set the connection state to Is Obsolete Processing Response.
 - Send a TXUSER_DTCLURECOVERYINITIATEDBYDTC_MTAG_REQUESTCOMPLETE message using the connection.
 - Signal the Local LU Initiated Recovery Worker Ended event with the following arguments:
 - The LU Pair object referenced by this connection
 - The connection object
 - Set the connection state to Ended (section 3.3.1.5.20).
- Otherwise, if the connection state is Ended (section 3.3.1.5.20):
 - Ignore the message.

- Otherwise, the message MUST be processed as an invalid message, as specified in [MS-DTCO], section 3.1.6.

3.3.5.4.5 Receiving a **TXUSER_DTCLURECOVERYINITIATEDBYDTC_MTAG_THEIR_XLN_RESPONSE Message**

When the Transaction Manager Communicating with an LU 6.2 Implementation Facet receives a TXUSER_DTCLURECOVERYINITIATEDBYDTC_MTAG_THEIR_XLN_RESPONSE message, it MUST perform the following actions:

- If the connection state is Awaiting Response To Cold XLN:
 - Set the connection state to Processing Response To Cold XLN.
 - Signal the Received New Remote Log Name event with the following arguments:
 - The LU Pair object referenced by this connection
 - The value of the first **cbLength** bytes of the **rgbBlob** field of the DTCLU_VARLEN_BYTEARRAY structure (contained in the **RemoteLogName** field) of the message
 - If the following conditions are both TRUE:
 - The **LU Pair Recovery State** field of the LU Pair object referenced by this connection is not set to Synchronizing No Remote Name.
 - The **Remote Log Name** field of the LU Pair object referenced by this connection is not set to the value of the first **cbLength** bytes of the **rgbBlob** field of the DTCLU_VARLEN_BYTEARRAY structure (contained in the **RemoteLogName** field) of the message.

Then perform the following actions:

- Signal the Synchronization Inconsistent event with the following arguments:
 - The LU Pair object referenced by this connection
- Send a TXUSER_DTCLURECOVERYINITIATEDBYDTC_MTAG_CONFIRMATION_FOR_THEIR_XLN message using the connection.
 - The **XlnConfirmation** field MUST be set to DTCLUXLNCOMFIRMATION_LOGNAMEMISMATCH.
- Set the connection state to Ended (section 3.3.1.5.20).
- Otherwise, if the following conditions are both TRUE:
 - The **Is Warm** field of the LU Pair object referenced by this connection is TRUE.
 - The LUW List of the LU Pair object is not empty.

Then perform the following actions:

- Signal the Synchronization Inconsistent event with the following arguments:
 - The LU Pair object referenced by this connection

- Send a TXUSER_DTCLURECOVERYINITIATEDBYDTC_MTAG_CONFIRMATION_FOR_THEIR_XLN message using the connection.
 - The **XlnConfirmation** field MUST be set to DTCLUXLNCOMFIRMATION_COLDWARMISMATCH.
- Signal the Local LU Initiated Recovery Worker Ended event with the following arguments:
 - The LU Pair object referenced by this connection
 - The connection object
- Set the connection state to Ended.
- Otherwise:
 - Signal the Received New Remote Log Name event with the following arguments:
 - The LU Pair object referenced by this connection
 - The value of the first **cbLength** bytes of the **rgbBlob** field of the DTCLU_VARLEN_BYTEARRAY structure (contained in the **RemoteLogName** field) of the message
 - Signal the Synchronization Successful event with the following arguments:
 - The LU Pair object referenced by this connection
 - Send a TXUSER_DTCLURECOVERYINITIATEDBYDTC_MTAG_CONFIRMATION_FOR_THEIR_XLN message using the connection.
 - The **XlnConfirmation** field MUST be set to DTCLUXLNCOMFIRMATION_CONFIRM.
 - Set the connection state to Awaiting Compare States Query.
- Otherwise, if the connection state is Awaiting Response To Warm XLN:
 - Set the connection state to Processing Response To Warm XLN.
 - If the following conditions are both TRUE:
 - The **LU Pair Recovery State** field of the LU Pair object referenced by this connection is not set to Synchronizing No Remote Name.
 - The **Remote Log Name** field of the LU Pair object referenced by this connection is not set to the first **cbLength** bytes of the **rgbBlob** field of the DTCLU_VARLEN_BYTEARRAY structure (contained in the **RemoteLogName** field) of the message.

Then perform the following actions:

- Signal the Synchronization Inconsistent event with the following arguments:
 - The LU Pair object referenced by this connection
- Send a TXUSER_DTCLURECOVERYINITIATEDBYDTC_MTAG_CONFIRMATION_FOR_THEIR_XLN message using the connection.
 - The **XlnConfirmation** field MUST be set to DTCLUXLNCOMFIRMATION_LOGNAMEMISMATCH.

- Signal the Local LU Initiated Recovery Worker Ended event with the following arguments:
 - The LU Pair object referenced by this connection
 - The connection object
- Set the connection state to Ended.
- Otherwise, if the following conditions are all TRUE:
 - The **Is Warm** field of the LU Pair object referenced by this connection is TRUE.
 - The LUW List of the LU Pair object referenced by this connection is not empty.
 - The value of the **XIn** field of the message is set to DTCLUXLN_COLD.

Then perform the following actions:

- Signal the Synchronization Inconsistent event with the following arguments:
 - The LU Pair object referenced by this connection
- Send a TXUSER_DTCLURECOVERYINITIATEDBYDTC_MTAG_CONFIRMATION_FOR_THEIR_XLN message using the connection.
 - The **XInConfirmation** field MUST be set to DTCLUXLNCOMFIRMATION_COLDWARMISMATCH.
- Signal the Local LU Initiated Recovery Worker Ended event with the following arguments:
 - The LU Pair object referenced by this connection
 - The connection object
- Set the connection state to Ended.
- Otherwise:
 - Signal the Received New Remote Log Name event with the following arguments:
 - The LU Pair object referenced by this connection
 - The value of the first **cbLength** bytes of the **rgbBlob** field of the DTCLU_VARLEN_BYTEARRAY structure (contained in the **RemoteLogName** field) of the message
 - Signal the Synchronization Successful event with the following arguments:
 - The LU Pair object referenced by this connection
 - Send a TXUSER_DTCLURECOVERYINITIATEDBYDTC_MTAG_CONFIRMATION_FOR_THEIR_XLN message using the connection.
 - The **XInConfirmation** field MUST be set to DTCLUXLNCOMFIRMATION_CONFIRM.
 - If the **Compare State Query Received** field of the connection object is TRUE:
 - If the **LUW To Recover** field of the connection object is set:
 - Set the connection state to Awaiting Compare States Response.

- Otherwise:
 - Signal the Local LU Initiated Recovery Worker Ended event with the following arguments:
 - The LU Pair object referenced by this connection
 - The connection object
 - Set the connection state to Ended.
- Otherwise:
 - Set the state to Awaiting Compare States Query.
- Otherwise, if the connection state is either Is Obsolete Awaiting Response To Cold XLN or Is Obsolete Awaiting Response To Warm XLN:
 - Set the connection state to Is Obsolete Processing Response.
 - Send a TXUSER_DTCLURECOVERYINITIATEDBYDTC_MTAG_CONFIRMATION_FOR_THEIR_XLN message using the connection.
 - The **XInConfirmation** field MUST be set to DTCLUXLNCONFIRMATION_OBSOLETE.
 - Signal the Local LU Initiated Recovery Worker Ended event with the following arguments:
 - The LU Pair object referenced by this connection
 - The connection object
 - Set the connection state to Ended.
- Otherwise, if the connection state is Ended (section 3.3.1.5.20):
 - Ignore the message.
- Otherwise, the message MUST be processed as an invalid message, as specified in [MS-DTCO], section 3.1.6.

3.3.5.4.6 Receiving a TXUSER_DTCLURECOVERYINITIATEDBYDTC_MTAG_CHECK_FOR_COMPARESTATES Message

When the Transaction Manager Communicating with an LU 6.2 Implementation Facet receives a TXUSER_DTCLURECOVERYINITIATEDBYDTC_MTAG_CHECK_FOR_COMPARESTATES message, it MUST perform the following actions:

- If the connection state is Awaiting Compare States Query:
 - Set the connection state to Processing Compare States Query.
 - Attempt to find the first LUW object in the LUW List of the LU Pair object referenced by this connection for which the following condition is TRUE:
 - The **LUW Recovery State** field of the LUW object is set to Need Recovery.
 - If no LUW object is found:
 - Send a TXUSER_DTCLURECOVERYINITIATEDBYDTC_MTAG_NO_COMPARESTATES message using the connection.

- Signal the Local LU Initiated Recovery Worker Ended event with the following arguments:
 - The LU Pair object referenced by this connection
 - The connection object
- Set the connection state to Ended (section 3.3.1.5.20).
- Otherwise:
 - Set the **LUW Recovery State** field of the LUW object to Recovering.
 - Set the **LUW To Recover** field of the current connection object to the previously found LUW object.
 - Send a TXUSER_DTCLURECOVERYINITIATEDBYDTC_MTAG_COMPARESTATES_INFO message using the connection.
 - If the **Local LU LUW State** field of the LUW object found in the list is set to In Doubt:
 - The **CompareStates** field MUST be set to DTCLUCOMPARESTATE_INDOUBT.
 - Otherwise, if the **Local LU LUW State** field of the LUW object found in the list is set to either Active or Reset:
 - The **CompareStates** field MUST be set to DTCLUCOMPARESTATE_RESET.
 - Otherwise, if the **Local LU LUW State** field of the LUW object found in the list is set to Committed:
 - The **CompareStates** field MUST be set to DTCLUCOMPARESTATE_COMMITTED.
 - Otherwise, if the **Local LU LUW State** field of the LUW object found in the list is set to Forget:
 - The transaction manager that communicates with an LU 6.2 implementation (section 3.2) MUST drop the connection.
 - The **cbLength** of the DTCLU_VARLEN_BYTEARRAY structure (contained in the **LuTransId** field) MUST be set to the number of bytes in the **LUW Identifier** field of the LUW object found in the list.
 - The first **cbLength** bytes of the **rgbBlob** field of the DTCLU_VARLEN_BYTEARRAY structure (contained in the **LuTransId** field) MUST be set to the value of the LUW object found in the list.
 - Set the connection state to Awaiting Compare States Response.
- Otherwise, if the connection state is Awaiting Response To Warm XLN:
 - Set the connection state to Processing Compare States Query During Warm XLN.
 - Set the **Compare State Query Received** field of the connection object to TRUE.
 - Attempt to find the first LUW object in the LUW List of the LU Pair object referenced by this connection for which the following condition is TRUE:
 - The **LUW Recovery State** field of the LUW object is set to Need Recovery.
 - If no LUW object is found:

- Send a TXUSER_DTCLURECOVERYINITIATEDBYDTC_MTAG_NO_COMPARESTATES message using the connection.
- Set the connection state to Awaiting Response To Warm XLN.
- Otherwise:
 - Set the **LUW Recovery State** field of the LUW object to Recovering.
 - Set the **LUW To Recover** field of the current connection object to the previously found LUW object.
 - Send a TXUSER_DTCLURECOVERYINITIATEDBYDTC_MTAG_COMPARESTATES_INFO message using the connection.
 - If the **Local LU LUW State** field of the LUW object found in the list is set to In Doubt:
 - The **CompareStates** field MUST be set to DTCLUCOMPARESTATE_INDOUBT.
 - Otherwise, if the **Local LU LUW State** field of the LUW object found in the list is set to either Active or Reset:
 - The **CompareStates** field MUST be set to DTCLUCOMPARESTATE_RESET.
 - Otherwise, if the **Local LU LUW State** field of the LUW object found in the list is set to Committed:
 - The **CompareStates** field MUST be set to DTCLUCOMPARESTATE_COMMITTED.
 - Otherwise, if the **Local LU LUW State** field of the LUW object found in the list is set to Forget:
 - The transaction manager that communicates with an LU 6.2 Implementation MUST drop the connection.
 - The **cbLength** of the DTCLU_VARLEN_BYTEARRAY structure (contained in the **LuTransId** field) MUST be set to the number of bytes in the **LUW Identifier** field of the LUW object found in the list.
 - The first **cbLength** bytes of the **rgbBlob** field of the DTCLU_VARLEN_BYTEARRAY structure (contained in the **LuTransId** field) MUST be set to the value of the **LUW Identifier** field of the LUW object.
 - Set the connection state to Awaiting Response to Warm XLN.
- Otherwise, if the connection state is Is Obsolete Awaiting Response To Warm XLN:
 - Set the connection state to Is Obsolete Processing Compare States Query During Warm XLN.
 - Set the **Compare State Query Received** field of the connection object to TRUE.
 - Attempt to find the first LUW object in the LUW List of the LU Pair object referenced by this connection for which the following condition is TRUE:
 - The **LUW Recovery State** field of the LUW object is set to Need Recovery.
 - If no LUW object is found:
 - Send a TXUSER_DTCLURECOVERYINITIATEDBYDTC_MTAG_NO_COMPARESTATES] message using the connection.
 - Set the connection state to Is Obsolete Awaiting Response To Warm XLN.

- Otherwise:
 - Set the **LUW Recovery State** field of the LUW object to Recovering.
 - Set the **LUW To Recover** field of the current connection object to the previously found LUW object.
 - Send a TXUSER_DTCLURECOVERYINITIATEDBYDTC_MTAG_COMPARESTATES_INFO message using the connection.
 - If the **Local LU LUW State** field of the LUW object found in the list is set to In Doubt:
 - The **CompareStates** field MUST be set to DTCLUCOMPARESTATE_INDOUBT.
 - Otherwise, if the **Local LU LUW State** field of the LUW object found in the list is set to either Active or Reset:
 - The **CompareStates** field MUST be set to DTCLUCOMPARESTATE_RESET.
 - Otherwise, if the **Local LU LUW State** field of the LUW object found in the list is set to Committed:
 - The **CompareStates** field MUST be set to DTCLUCOMPARESTATE_COMMITTED.
 - Otherwise, if the **Local LU LUW State** field of the LUW object found in the list is set to Forget:
 - The transaction manager that communicates with an LU 6.2 Implementation MUST drop the connection.
 - The **cbLength** field of the DTCLU_VARLEN_BYTEARRAY structure (contained in the **LuTransId** field) MUST be set to the number of bytes in the **LUW Identifier** field of the LUW object.
 - The first **cbLength** bytes of the **rgbBlob** field of the DTCLU_VARLEN_BYTEARRAY structure (contained in the **LuTransId** field) MUST be set to the value of the **LUW Identifier** field of the LUW object.
 - Set the connection state to Is Obsolete Processing Compare State Query During Warm XLN.
- Otherwise, if the connection state is Ended (section 3.3.1.5.20):
 - Ignore the message.
- Otherwise, the message MUST be processed as an invalid message, as specified in [MS-DTCO], section 3.1.6.

3.3.5.4.7 Receiving a TXUSER_DTCLURECOVERYINITIATEDBYDTC_MTAG_THEIR_COMPARESTATE S Message

When the Transaction Manager Communicating with an LU 6.2 Implementation Facet receives a TXUSER_DTCLURECOVERYINITIATEDBYDTC_MTAG_THEIR_COMPARESTATES message, it MUST perform the following actions:

- If the connection state is Awaiting Compare States Response:
 - Set the connection state to Processing Compare States Response.
 - If the **Compare States Query Received** flag is not set to TRUE:

- Disconnect the connection on which the message was received.
- Set the connection state to Ended.
- Tear down the session with which the connection was established.
- Otherwise, the transaction manager that communicates with an LU 6.2 Implementation MUST perform the following actions:
 - If the **Local LU LUW State** field of the LUW object referenced by the **LUW To Recover** field of the connection is set to either Reset or Active:
 - If the **CompareStates** field of the message is set to either DTCLUCOMPARESTATE_COMMITTED or DTCLUCOMPARESTATE_INDOUBT:
 - Send a TXUSER_DTCLURECOVERYINITIATEDBYDTC_MTAG_CONFIRMATION_FOR_THEIR_COMPARESTATES message using the connection.
 - The **CompareStatesConfirmation** field MUST be set to DTCLUCOMPARESTATESCONFIRMATION_PROTOCOL.
 - Otherwise:
 - Set the Local LU LUW State of the LUW object referenced by the **LUW To Recover** field of the connection to Forget.
 - Set the **LUW Recovery State** field of the LUW object referenced by the **LUW To Recover** field of the connection to Recovery Not Needed.
 - Signal the Enlistment Rollback Complete event (as specified in [MS-DTCO] section 3.2.7.18) on the Core Transaction Manager Facet with the following argument:
 - The Enlistment object of the LUW object referenced by the **LUW To Recover** field of the connection.
 - Send a TXUSER_DTCLURECOVERYINITIATEDBYDTC_MTAG_CONFIRMATION_FOR_THEIR_COMPARESTATES message using the connection.
 - The **CompareStatesConfirmation** field MUST be set to DTCLUCOMPARESTATESCONFIRMATION_CONFIRM.
 - Otherwise, if the **Local LU LUW State** field of the LUW object referenced by the **LUW To Recover** field of the connection is set to Committed:
 - If the **CompareStates** field of the message is set to DTCLUCOMPARESTATE_INDOUBT:
 - Send a TXUSER_DTCLURECOVERYINITIATEDBYDTC_MTAG_CONFIRMATION_FOR_THEIR_COMPARESTATES message using the connection.
 - The **CompareStatesConfirmation** field MUST be set to DTCLUCOMPARESTATESCONFIRMATION_PROTOCOL.
 - Otherwise:
 - Set the Local LU LUW State of the LUW object referenced by the **LUW To Recover** field of the connection to Forget.

- Set the **LUW Recovery State** field of the LUW object referenced by the **LUW To Recover** field of the connection to Recovery Not Needed.
- Signal the Enlistment Commit Complete event on the Core Transaction Manager Facet with the following argument:
 - The Enlistment object of the LUW object referenced by the **LUW To Recover** field of the connection.
- Send a TXUSER_DTCLURECOVERYINITIATEDBYDTC_MTAG_CONFIRMATION_FOR_THEIR_COMPARESTATES message using the connection.
 - The **CompareStatesConfirmation** field MUST be set to DTCLUCOMPARESTATESCONFIRMATION_CONFIRM.
- Otherwise, the transaction manager that communicates with an LU 6.2 Implementation MUST drop the connection as specified in the Connection Disconnected (section 3.3.5.4.10) event.
- Otherwise, if the connection state is Ended (section 3.3.1.5.20):
 - Ignore the message.
- Otherwise, the message MUST be processed as an invalid message, as specified in [MS-DTCO], section 3.1.6.

3.3.5.4.8 Receiving a TXUSER_DTCLURECOVERYINITIATEDBYDTC_MTAG_ERROR_FROM_OUR_COMPARESTATES Message

When the Transaction Manager Communicating with an LU 6.2 Implementation Facet receives a TXUSER_DTCLURECOVERYINITIATEDBYDTC_MTAG_ERROR_FROM_OUR_COMPARESTATES message, it MAY perform the following actions:

- If the connection state is Awaiting Compare States Response:
 - Set the connection state to Processing Compare States Error.
 - Send a TXUSER_DTCLURECOVERYINITIATEDBYDTC_MTAG_REQUESTCOMPLETE message using the connection.
 - Signal the Local LU Initiated Recovery Worker Ended event with the following arguments:
 - The LU Pair object referenced by this connection
 - The connection object
 - Set the connection state to Ended (section 3.3.1.5.20).
- Otherwise, if the connection state is Ended (section 3.3.1.5.20):
 - Ignore the message.
- Otherwise, the message MUST be processed as an invalid message, as specified in [MS-DTCO], section 3.1.6.

3.3.5.4.9 Receiving a TXUSER_DTCLURECOVERYINITIATEDBYDTC_MTAG_LUSTATUS Message

When the Transaction Manager Communicating with an LU 6.2 Implementation Facet receives a TXUSER_DTCLURECOVERYINITIATEDBYDTC_MTAG_LUSTATUS message, it MUST perform the following actions:

- If the connection state is Awaiting LU Status Response:
 - Set the connection state to Processing LU Status Response.
 - Signal the Received New Recovery Sequence Number event with the following arguments:
 - The LU Pair object referenced by this connection
 - The value of the **RecoverySeqNum** field of the message
 - If the return value from the Received New Recovery Sequence Number event is FALSE:
 - Signal the Received LU Status event with the following arguments:
 - The LU Pair object referenced by this connection
 - Send a TXUSER_DTCLURECOVERYINITIATEDBYDTC_MTAG_REQUESTCOMPLETE message using the connection.
 - Signal the Local LU Initiated Recovery Worker Ended event with the following arguments:
 - The LU Pair object referenced by this connection
 - The connection object
 - Set the connection state to Ended (section 3.3.1.5.20).
- Otherwise, if the connection state is Is Obsolete Awaiting LU Status Response:
 - Set the connection state to Is Obsolete Processing Response.
 - Send a TXUSER_DTCLURECOVERYINITIATEDBYDTC_MTAG_REQUESTCOMPLETE message using the connection.
 - Signal the Local LU Initiated Recovery Worker Ended event with the following arguments:
 - The LU Pair object referenced by this connection
 - The connection object
 - Set the connection state to Ended (section 3.3.1.5.20).
- Otherwise, if the connection state is Ended (section 3.3.1.5.20):
 - Ignore the message.
- Otherwise, the message MUST be processed as an invalid message, as specified in [MS-DTCO], section 3.1.6.

3.3.5.4.10 Connection Disconnected

When a CONNTYPE_TXUSER_DTCLURECOVERYINITIATEDBYDTC connection is disconnected, the Transaction Manager Communicating with an LU 6.2 Implementation Facet MUST perform the following actions:

- If the connection state is either Processing Work Query, Awaiting Response To Cold XLN, Awaiting Response To Warm XLN, or Awaiting LU Status Response:

- Signal the Local LU Initiated Recovery Worker Ended event with the following arguments:
 - The LU Pair object referenced by this connection
 - The connection object
- Set the connection state to Ended (section 3.3.1.5.20).
- Signal the Synchronization Connection Down event with the following arguments:
 - The LU Pair object referenced by this connection
- Otherwise, if the connection state is either Idle, Awaiting Compare States Query, Awaiting Compare States Response, Is Obsolete Awaiting Response To Cold XLN, Is Obsolete Awaiting Response To Warm XLN, or Is Obsolete Awaiting LU Status Response:
 - Signal the Local LU Initiated Recovery Worker Ended event with the following arguments:
 - The LU Pair object referenced by this connection
 - The connection object
 - Set the connection state to Ended (section 3.3.1.5.20).
- Otherwise, if the connection state is Ended (section 3.3.1.5.20):
 - Ignore the event.
- Otherwise, the event MUST be processed as specified in [MS-DTCO] section 3.1.8.3.

3.3.5.5 CONNTYPE_TXUSER_DTCLURECOVERYINITIATEDBYLU as Acceptor

For all messages received in this Connection Type, the Transaction Manager Communicating with an LU 6.2 Implementation Facet MUST process the message, as specified in section 3.1. The Transaction Manager Communicating with an LU 6.2 Implementation Facet MUST also follow the processing rules specified in the following sections.

3.3.5.5.1 Receiving a TXUSER_DTCLURECOVERYINITIATEDBYLU_MTAG_THEIR_XLN Message

When the Transaction Manager Communicating with an LU 6.2 Implementation Facet receives a TXUSER_DTCLURECOVERYINITIATEDBYLU_MTAG_THEIR_XLN message, it MUST perform the following actions:

- If the connection state is Idle:
 - Set the connection state to Processing XLN Request.
 - Attempt to find the LU Pair object keyed by the first **cbLength** bytes of the **rgbBlob** field of the DTCLU_VARLEN_BYTEARRAY structure (contained in the **LuNamePair** field) of the message in the LU Pair Table.
 - If the LU Pair object is not found:
 - Send a TXUSER_DTCLURECOVERYINITIATEDBYLU_MTAG_THEIR_XLN_NOT_FOUND message using the connection.
 - Signal the Remote LU Initiated Recovery Ended event with the following arguments:
 - The LU Pair object referenced by this connection

- The connection object
- Set the connection state to Ended (section 3.3.1.6.10).
- Otherwise, if the LU Pair object is found:
 - Set the **LU Pair** field of the connection object to the found LU Pair object.
 - Signal the Received New Recovery Sequence Number event with the following arguments:
 - The LU Pair object referenced by this connection
 - The value of the **RecoverySeqNum** field of the message
 - Add the connection object to the Remote LU Initiated Recovery List.
 - Signal the Begin Remote LU Initiated Synchronization event with the following argument:
 - The LU Pair object referenced by this connection
 - Signal the Received New Remote Log Name event with the following arguments:
 - The LU Pair object referenced by this connection
 - The first **cbLength** bytes of the **rgbBlob** field of the DTCLU_VARLEN_BYTEARRAY structure (contained in the **RemoteLogName** field) of the message
 - If both the following conditions are TRUE:
 - The **LU Pair Recovery State** field of the found LU Pair object is not set to Synchronizing No Remote Name.
 - The **Remote Log Name** field of the found LU Pair object is not set to the first **cbLength** bytes of the **rgbBlob** field of the DTCLU_VARLEN_BYTEARRAY structure (contained in the **RemoteLogName** field) of the message.

Or if both the following conditions are TRUE:

- The **cbLength** field of the DTCLU_VARLEN_BYTEARRAY structure (contained in the **LocalLogName** field) of the message is not set.
- The **Local Log Name** field of the found LU Pair object is not set to the value of **cbLength** field of the DTCLU_VARLEN_BYTEARRAY structure (contained in the **LocalLogName** field) of the message.

Then perform the following actions:

- Send a TXUSER_DTCLURECOVERYINITATEDBYLU_MTAG_RESPONSE_FOR_THEIR_XLN message using the connection.
 - The **XlnResponse** field MUST be set to DTCLUXLNRESPONSE_LOGNAMEMISMATCH.
 - If the **Is Warm** flag of the found LU Pair object is set to FALSE, the **Xln** field MUST be set to DTCLUXLN_COLD.
 - Otherwise if the **Is Warm** flag is set to TRUE, the **Xln** field MUST be set to DTCLUXLN_WARM.
 - The **dwProtocol** field MUST be set to 0.

- The first **cbLength** bytes of the **rgbBlob** field of the DTCLU_VARLEN_BYTEARRAY structure (contained in the **OurLogName** field) MUST be set to the **Local Log Name** field of the found LU Pair object. The **cbLength** field of the DTCLU_VARLEN_BYTEARRAY structure (contained in the **OurLogName** field) MUST be set to the number of bytes in the **Local Log Name** field of the found LU Pair object.
- Signal the Remote LU Initiated Recovery (section 3.3.1.6.10) event with the following arguments:
 - The LU Pair object referenced by this connection
 - The connection object
- Set the connection state to Ended (section 3.3.1.6.10).
- Signal the Synchronization Inconsistent event with the following argument:
 - LU Pair object referenced by this connection
- Otherwise:
 - If the following conditions are all TRUE:
 - The **Is Warm** flag of the found LU Pair object is set to TRUE.
 - The LUW List of the found LU Pair object is not empty.
 - The **XIn** field of the message is set to DTCLUXLN_COLD.

Then perform the following actions:

- Signal the Synchronization Inconsistent event with the following argument:
 - LU Pair object referenced by this connection
- Send a TXUSER_DTCLURECOVERYINITATEDBYLU_MTAG_RESPONSE_FOR_THEIR_XLN message using the connection.
 - The **XInResponse** field MUST be set to DTCLUXLNRESPONSE_COLDWARMISMATCH.
 - If the **Is Warm** flag of the found LU Pair object is set to FALSE, the **XIn** field MUST be set to DTCLUXLN_COLD.
 - Otherwise, if the **Is Warm** flag is set to TRUE, the **XIn** field MUST be set to DTCLUXLN_WARM.
 - The **dwProtocol** field MUST be set to 0.
 - The first **cbLength** bytes of the **rgbBlob** field of the DTCLU_VARLEN_BYTEARRAY structure (contained in the **OurLogName** field) MUST be set to the **Local Log Name** field of the found LU Pair object. The **cbLength** field of the DTCLU_VARLEN_BYTEARRAY structure (contained in the **OurLogName** field) MUST be set to the number of bytes in the **Local Log Name** field of the found LU Pair object.
- Signal the Remote LU Initiated Recovery (section 3.3.7.22) event with the following arguments:
 - The LU Pair object referenced by this connection

- The connection object
- Set the connection state to Ended (section 3.3.1.6.10).
- Otherwise, the transaction manager that communicates with an LU 6.2 implementation (section 3.2) SHOULD perform the following actions:
 - If the following conditions are all TRUE:
 - The **XIn** field of the message is set to DTCLUXLN_WARM.
 - The **Is Warm** flag of the found LU Pair object is set to TRUE.
 - The **cbLength** field of the DTCLU_VARLEN_BYTEARRAY structure (contained in the **LocalLogName** field) of the message is not set to 0.

Then perform the following actions.

- Signal the Received New Remote Log Name event with the following arguments:
 - LU Pair object referenced by this connection
 - The first **cbLength** bytes of the **rgbBlob** field of the DTCLU_VARLEN_BYTEARRAY structure (contained in the **RemoteLogName** field) of the message
- Signal the Synchronization Successful event with the following argument:
 - The LU Pair object referenced by this connection
- Send a TXUSER_DTCLURECOVERYINITATEDBYLU_MTAG_RESPONSE_FOR_THEIR_XLN message using the connection.
 - The **XInResponse** field MUST be set to DTCLUXLNRESPONSE_OK_SENDCONFIRMATION.
 - If the **Is Warm** flag of the found LU Pair object is set to FALSE, the **XIn** field MUST be set to DTCLUXLN_COLD.
 - Otherwise, if the **Is Warm** flag is set to TRUE, the **XIn** field MUST be set to DTCLUXLN_WARM.
 - The **dwProtocol** field MUST be set to 0.
 - The first **cbLength** bytes of the **rgbBlob** field of the DTCLU_VARLEN_BYTEARRAY structure (contained in the **OurLogName** field) MUST be set to the **Local Log Name** field of the found LU Pair object. The **cbLength** field of the DTCLU_VARLEN_BYTEARRAY structure (contained in the **OurLogName** field) MUST be set to the number of bytes in the **Local Log Name** field of the found LU Pair object.
 - Set the connection state to Awaiting Compare States Request.
- Otherwise:
 - Send a TXUSER_DTCLURECOVERYINITATEDBYLU_MTAG_RESPONSE_FOR_THEIR_XLN message using the connection.
 - The **XInResponse** field MUST be set to DTCLUXLNRESPONSE_OK_SENDOURXLNBACK.

- If the **Is Warm** flag of the found LU Pair object is set to FALSE, the **Xln** field MUST be set to DTCLUXLN_COLD; otherwise, if the **Is Warm** flag is set to TRUE, the **Xln** field MUST be set to DTCLUXLN_WARM.
- The **dwProtocol** field is set to 0.
- The first **cbLength** bytes of the **rgbBlob** field of the DTCLU_VARLEN_BYTEARRAY structure (contained in the **OurLogName** field) MUST be set to the **Local Log Name** field of the found LU Pair object. The **cbLength** field of the DTCLU_VARLEN_BYTEARRAY structure (contained in the **OurLogName** field) MUST be set to the number of bytes in the **Local Log Name** field of the found LU Pair object.
- Set the connection state to Awaiting XLN Confirmation.
- Otherwise, if the connection state is 3.3.1.6.103.3.1.6.10:
 - Ignore the message.
- Otherwise, the message MUST be processed as an invalid message, as specified in [MS-DTCO], section 3.1.6.

3.3.5.5.2 Receiving a TXUSER_DTCLURECOVERYINITIATEDBYLU_MTAG_CONFIRMATION_OF_OUR_XLN Message

When the Transaction Manager Communicating with an LU 6.2 Implementation Facet receives a TXUSER_DTCLURECOVERYINITIATEDBYLU_MTAG_CONFIRMATION_OF_OUR_XLN message, it MUST perform the following actions:

- If the connection state is Awaiting XLN Confirmation:
 - Set the connection state to Processing XLN Confirmation.
 - If the **XlnConfirmation** field from the message is set to DTCLUXLNCONFIRMATION_CONFIRM:
 - Signal the Synchronization Successful event with the following argument:
 - LU Pair object referenced by this connection
 - Send a TXUSER_DTCLURECOVERYINITIATEDBYLU_MTAG_REQUESTCOMPLETE message using the connection.
 - Set the connection state to Awaiting Compare States Request.
 - Otherwise, if the **XlnConfirmation** field from the message is set to either DTCLUXLNCONFIRMATION_COLDWARMISMATCH or DTCLUXLNCONFIRMATION_LOGNAMEMISMATCH:
 - Signal the Synchronization Inconsistent event with the following argument:
 - LU Pair object referenced by this connection
 - Send a TXUSER_DTCLURECOVERYINITIATEDBYLU_MTAG_REQUESTCOMPLETE message using the connection.
 - Signal the Remote LU Initiated Recovery Ended event with the following arguments:
 - The LU Pair object referenced by this connection

- The connection object
 - Set the connection state to Ended (section 3.3.1.6.10).
- Otherwise:
 - The transaction manager that communicates with an LU 6.2 implementation (section 3.2) MUST drop the connection.
 - Set the connection state to Awaiting XLN Confirmation.
- Otherwise, if the connection state is Is Obsolete Awaiting XLN Confirmation:
 - If the **XlnConfirmation** field from the message is set to DTCLUXLNCONFIRMATION_CONFIRM:
 - Send a TXUSER_DTCLURECOVERYINITIATEDBYLU_MTAG_REQUESTCOMPLETE message using the connection.
 - Set the connection state to Awaiting Compare States Request.
 - Otherwise, if the **XlnConfirmation** field from the message is set to either DTCLUXLNCONFIRMATION_COLDWARMISMATCH or DTCLUXLNCONFIRMATION_LOGNAMEMISMATCH:
 - Send a TXUSER_DTCLURECOVERYINITIATEDBYLU_MTAG_REQUESTCOMPLETE message using the connection.
 - Signal the Remote LU Initiated Recovery Ended event with the following arguments:
 - The LU Pair object referenced by this connection
 - The connection object
 - Set the connection state to Ended (section 3.3.1.6.10).
 - Otherwise:
 - The transaction manager that communicates with an LU 6.2 Implementation MUST drop the connection.
 - Set the connection state to Is Obsolete Awaiting XLN Confirmation.
- Otherwise, if the connection state is Ended (section 3.3.1.6.10):
 - Ignore the message.
- Otherwise, the message MUST be processed as an invalid message, as specified in [MS-DTCO], section 3.1.6.

3.3.5.5.3 Receiving a TXUSER_DTCLURECOVERYINITIATEDBYLU_MTAG_THEIR_COMPARESTATES Message

When the Transaction Manager Communicating with an LU 6.2 Implementation Facet receives a TXUSER_DTCLURECOVERYINITIATEDBYLU_MTAG_THEIR_COMPARESTATES message, it MUST perform the following actions:

- If the connection state is Awaiting Compare States Request:
 - Set the connection state to Processing Compare States Request.

- Attempt to find the first LUW object in the LUW List of the LU Pair object referenced by this connection for which the following condition is TRUE:
 - The value of the **LUW Identifier** field of the LUW object is set to the first **cbLength** bytes of the **rgbBlob** field of the DTCLU_VARLEN_BYTEARRAY structure (contained in the **LuTransId** field) of the message.
- If no LUW object that meets the above condition is found:
 - Send a TXUSER_DTCLURECOVERYINITIATEDBYLU_MTAG_RESPONSE_FOR_THEIR_COMPARESTATES message using the connection.
 - The **CompareStatesResponse** field MUST be set to DTCLUCOMPARESTATESRESPONSE_OK.
 - The **CompareStates** field MUST be set to DTCLUCOMPARESTATE_RESET.
 - Signal the Remote LU Initiated Recovery Ended event with the following arguments:
 - The LU Pair object referenced by this connection
 - The connection object
 - Set the connection state to Ended (section 3.3.1.6.10).
- Otherwise:
 - If the **Local LU LUW State** field of the LUW object referenced by the **LUW To Recover** field of the connection is set to Active:
 - If the **CompareStates** field of the message is set to DTCLUCOMPARESTATE_COMMITTED:
 - Send a TXUSER_DTCLURECOVERYINITIATEDBYLU_MTAG_RESPONSE_FOR_THEIR_COMPARERESTATES message using the connection.
 - The **CompareStatesResponse** field MUST be set to DTCLUCOMPARESTATESRESPONSE_PROTOCOL.
 - The **CompareStates** field MUST be set to DTCLUCOMPARESTATE_RESET.
 - Signal the Remote LU Initiated Recovery Ended event with the following arguments:
 - The LU Pair object referenced by this connection
 - The connection object
 - Set the connection state to Ended (section 3.3.1.6.10).
 - Otherwise:
 - The transaction manager that communicates with an LU 6.2 Implementation MUST drop the connection.
 - Otherwise, if the **Local LU LUW State** field of the LUW object referenced by the **LUW To Recover** field of the connection is set to Reset:
 - If the **CompareStates** field of the message is set to DTCLUCOMPARESTATE_RESET:

- The transaction manager that communicates with an LU 6.2 Implementation MAY perform the following actions:
 - Set the Local LU LUW State of the LUW object referenced by this connection to Forget.
 - Set the LUW Recovery State of the LUW object referenced by this connection to Recovery Not Needed.
- Signal the Enlistment Rollback Complete event (as specified in [MS-DTCO] section 3.2.7.18) on the Core Transaction Manager Facet with the following argument:
 - The Enlistment object of the LUW object referenced by this connection
- Send a TXUSER_DTCLURECOVERYINITIATEDBYLU_MTAG_RESPONSE_FOR_THEIR_COMPA RESTATES message using the connection.
 - The **CompareStatesResponse** field MUST be set to DTCLUCOMPARESTATESRESPONSE_OK.
 - The **CompareStates** field MUST be set to DTCLUCOMPARESTATE_RESET.
- Set the connection state to Awaiting Compare States Confirmation.
- Otherwise:
 - Send a TXUSER_DTCLURECOVERYINITIATEDBYLU_MTAG_RESPONSE_FOR_THEIR_COMPA RESTATES message using the connection.
 - The **CompareStatesResponse** field MUST be set to DTCLUCOMPARESTATESRESPONSE_PROTOCOL.
 - The **CompareStates** field MUST be set to DTCLUCOMPARESTATE_RESET.
 - Signal the Remote LU Initiated Recovery Ended event with the following arguments:
 - The LU Pair object referenced by this connection
 - The connection object
 - Set the connection state to Ended (section 3.3.1.6.10).
- Otherwise, if the **Local LU LUW State** field of the LUW object referenced by the **LUW To Recover** field of the connection is set to Committed:
 - If the **CompareStates** field of the message is set to DTCLUCOMPARESTATE_COMMITTED:
 - The transaction manager that communicates with an LU 6.2 Implementation MAY perform the following actions:
 - Set the Local LU LUW State of the LUW object referenced by this connection to Forget.
 - Set the LUW Recovery State of the LUW object referenced by this connection to Recovery Not Needed.
 - Signal the Enlistment Commit Complete event (as specified in [MS-DTCO] section 3.2.7.15) on the Core Transaction Manager Facet with the following argument:

- The Enlistment object of the LUW object referenced by this connection
- Send a TXUSER_DTCLURECOVERYINITIATEDBYLU_MTAG_RESPONSE_FOR_THEIR_COMPARESTATES message using the connection.
 - The **CompareStatesResponse** field MUST be set to DTCLUCOMPARESTATESRESPONSE_OK.
 - The **CompareStates** field MUST be set to DTCLUCOMPARESTATE_COMMITTED.
- Set the connection state to Awaiting Compare States Confirmation.
- Otherwise:
 - Send a TXUSER_DTCLURECOVERYINITIATEDBYLU_MTAG_RESPONSE_FOR_THEIR_COMPARESTATES message using the connection.
 - The **CompareStatesResponse** field MUST be set to DTCLUCOMPARESTATESRESPONSE_PROTOCOL.
 - The **CompareStates** field MUST be set to DTCLUCOMPARESTATE_RESET.
 - Signal the Remote LU Initiated Recovery Ended event with the following arguments:
 - The LU Pair object referenced by this connection
 - The connection object
 - Set the connection state to Ended (section 3.3.1.6.10).
- Otherwise, the transaction manager that communicates with an LU 6.2 Implementation MUST drop the connection.
- Otherwise, if the connection state is Ended (section 3.3.1.6.10):
 - Ignore the message.
- Otherwise, the message MUST be processed as an invalid message, as specified in [MS-DTCO], section 3.1.6.

3.3.5.5.4 Receiving a

TXUSER_DTCLURECOVERYINITIATEDBYLU_MTAG_CONFIRMATION_OF_OUR_COMPARESTATES Message

When the Transaction Manager Communicating with an LU 6.2 Implementation Facet receives a TXUSER_DTCLURECOVERYINITIATEDBYLU_MTAG_CONFIRMATION_OF_OUR_COMPARESTATES message, it MUST perform the following actions:

- If the connection state is Awaiting Compare States Confirmation:
 - Set the connection state to Processing Compare States Confirmation.
 - Send a TXUSER_DTCLURECOVERYINITIATEDBYLU_MTAG_REQUESTCOMPLETE message using the connection.
 - Signal the Remote LU Initiated Recovery Ended event with the following arguments:

- The LU Pair object referenced by this connection
- The connection object
- Set the connection state to Ended (section 3.3.1.6.10).
- Otherwise, if the connection state is Ended (section 3.3.1.6.10):
 - Ignore the message.
- Otherwise, the message MUST be processed as an invalid message, as specified in [MS-DTCO], section 3.1.6.

3.3.5.5.5 Receiving a TXUSER_DTCLURECOVERYINITIATEDBYLU_MTAG_ERROR_OF_OUR_COMPA RESTATES Message

When the Transaction Manager Communicating with an LU 6.2 Implementation Facet receives a TXUSER_DTCLURECOVERYINITIATEDBYLU_MTAG_ERROR_OF_OUR_COMPARESTATES message, it MAY<7> perform the following actions:

- If the connection state is Awaiting Compare States Confirmation:
 - Set the connection state to Processing Compare States Confirmation.
 - Send a TXUSER_DTCLURECOVERYINITIATEDBYLU_MTAG_REQUESTCOMPLETE message using the connection.
 - Signal the Remote LU Initiated Recovery Ended event with the following arguments:
 - The **LU Pair** object referenced by this connection
 - The connection object
 - Set the connection state to Ended (section 3.3.1.6.10).
- Otherwise, if the connection state is Ended (section 3.3.1.6.10):
 - Ignore the message.
- Otherwise, the message MUST be processed as an invalid message, as specified in [MS-DTCO], section 3.1.6.

3.3.5.5.6 Connection Disconnected

When a CONNTYPE_TXUSER_DTCLURECOVERYINITIATEDBYLU connection is disconnected, the Transaction Manager Communicating with an LU 6.2 Implementation Facet MUST perform the following actions:

- If the connection state is Awaiting XLN Confirmation:
 - Signal the Remote LU Initiated Recovery Ended event with the following arguments:
 - The **LU Pair** object referenced by this connection
 - The connection object
 - Set the connection state to Ended (section 3.3.1.6.10).
 - Signal the Synchronization Connection Down event with the following argument:

- The **LU Pair** object referenced by this connection
- Otherwise, if the connection state is either Idle, Awaiting Compare States Request, Awaiting Compare States Confirmation, or Is Obsolete Awaiting XLN Confirmation:
 - Signal the Remote LU Initiated Recovery Ended event with the following arguments:
 - The **LU Pair** object referenced by this connection
 - The connection object
 - Set the connection state to Ended (section 3.3.1.6.10).
- Otherwise, if the connection state is Ended (section 3.3.1.6.10):
 - Ignore the message.
- Otherwise, the event **MUST** be processed as specified in [MS-DTCO] section 3.1.8.3.

3.3.6 Timer Events

3.3.6.1 LU Status Timer Tick

The LU Status Timer Tick event **MUST** be signaled with the following argument:

- An LU Pair object

If the LU Status Timer Tick event is signaled, the Transaction Manager Communicating with an LU 6.2 Implementation Facet **MUST** perform the following action:

- Signal the Recovery Work Ready event with the following arguments:
 - The provided LU Pair object
 - The Recovery Work Ready Reason set to LU Status Timer

3.3.7 Other Local Events

A Transaction Manager Communicating with an LU 6.2 Implementation Facet **MUST** be prepared to process the local events defined in the following sections.

3.3.7.1 Create Subordinate Enlistment Success

The Create Subordinate Enlistment Success event **MUST** be signaled with the following argument:

- An Enlistment object

If the Create Subordinate Enlistment Success event is signaled, the Transaction Manager Communicating with an LU 6.2 Implementation Facet **MUST** perform the following actions:

- If the connection state is Processing Enlistment Request:
 - Send the TXUSER_DTCLURMENLISTMENT_MTAG_REQUEST_COMPLETED message using the connection of the provided enlistment.
 - Set the connection state to Active.
- Otherwise, ignore the event.

3.3.7.2 Create Subordinate Enlistment Failure

The Create Subordinate Enlistment Failure event MUST be signaled with the following arguments:

- An Enlistment object.
- A value that indicates the failure reason that MUST be one of the following values:
 - Log Full
 - Too Late
 - Too Many

If the Create Subordinate Enlistment Failure event is signaled, the Transaction Manager Communicating with an LU 6.2 Implementation Facet MUST perform the following actions:

- If the connection state is Processing Enlistment Request:
 - If the failure reason is Log Full:
 - Send a TXUSER_DTCLURMENLISTMENT_MTAG_CREATE_LOG_FULL message using the connection of the provided Enlistment object.
 - Otherwise, if the failure reason is Too Late:
 - Send a TXUSER_DTCLURMENLISTMENT_MTAG_CREATE_TOO_LATE message using the connection of the provided Enlistment object.
 - Otherwise, if the failure reason is Too Many:
 - Send a TXUSER_DTCLURMENLISTMENT_MTAG_CREATE_TOO_MANY message using the connection of the provided Enlistment object.
 - Set the connection state to Ended (section 3.3.1.4.9).
- Otherwise, ignore the event.

3.3.7.3 Begin Phase One

The Begin Phase One event MUST be signaled with the following arguments:

- An Enlistment object
- A Boolean value that indicates whether the Transaction Manager Communicating with an LU 6.2 Implementation Facet SHOULD or MUST NOT attempt to perform a Single Phase Commit (This argument is not used by this protocol and is ignored.)

If the Begin Phase One event is signaled, the Transaction Manager Communicating with an LU 6.2 Implementation Facet MUST perform the following actions:

- If the connection state is Active:
 - Send a TXUSER_DTCLURMENLISTMENT_MTAG_TO_LU_PREPARE message using the connection referenced by the provided Enlistment object.
 - Set the connection state to Awaiting Prepare Response.
- Otherwise, ignore the event.

3.3.7.4 Begin Rollback

The Begin Rollback event MUST be signaled with the following argument:

- An Enlistment object

If the Begin Rollback event is signaled, the Transaction Manager Communicating with an LU 6.2 Implementation Facet MUST perform the following actions:

- If the **Connection** field of the provided Enlistment object is not set:
 - For each LU Pair object in the LU Pair Table:
 - Attempt to find the first LUW object in the LUW List of the LU Pair object that meets the following condition:
 - The **Transaction Identifier** field of the LUW object is set to the value of the **Transaction Identifier** field of the provided Enlistment object.
 - If an LUW object is found:
 - Set the Local LU LUW State of the found LUW object to Reset.
 - Set the LUW Recovery State of the found LUW object to Need Recovery.
 - Signal the Recovery Work Ready event with the following arguments:
 - The LU Pair object
 - The Recovery Work Ready Reason set to LUW Recovery
- Otherwise:
 - If the connection state is either Active or Prepared:
 - Send a TXUSER_DTCLURMENLISTMENT_MTAG_TO_LU_BACKOUT message using the connection referenced by the provided Enlistment object.
 - Set the connection state to Awaiting Abort Response.
 - Otherwise, if the connection state is Processing Backout Request:
 - Send a TXUSER_DTCLURMENLISTMENT_MTAG_TO_LU_BACKEDOUT message using the connection referenced by the provided Enlistment object.
 - Set the Local LU LUW State field of the LUW object of the provided Enlistment object to Forget.
 - Signal the Enlistment Rollback Complete event on the Core Transaction Manager Facet with the following argument:
 - The provided Active Phase Enlistment object.
 - Set the connection state to Ended (section 3.3.1.4.9).
 - Otherwise, ignore the event.

3.3.7.5 Begin Commit

The Begin Commit event MUST be signaled with the following argument:

- An Enlistment object

If the Begin Commit event is signaled, the Transaction Manager Communicating with an LU 6.2 Implementation Facet MUST perform the following actions:

- If the **Connection** field of the provided Enlistment object is not set:
 - For each LU Pair object in the LU Pair Table:
 - Attempt to find the first LUW object in the LUW List of the LU Pair object that meets the following condition:
 - The **Transaction Identifier** field of the LUW object is set to the value of the **Transaction Identifier** field of the provided Enlistment object.
 - If an LUW object is found:
 - Set the Local LU LUW State of the found LUW object to Committed.
 - Set the LUW Recovery State of the found LUW object to Need Recovery.
 - Signal the Recovery Work Ready event with the following arguments:
 - The LU Pair object
 - The Recovery Work Ready Reason set to LUW Recovery
 - Otherwise:
 - Continue processing.
- Otherwise:
 - If the connection state is Prepared:
 - Send a TXUSER_DTCLURMENLISTMENT_MTAG_TO_LU_COMMITTED message using the connection of the provided Enlistment object.
 - Set the connection state to Awaiting Commit Response.
 - Otherwise, ignore the event.

3.3.7.6 Local LU Initiated Recovery Obsolete XLN Exchange

The Local LU Initiated Recovery Obsolete XLN Exchange event MUST be signaled with the following argument:

- A connection object of type CONNTYPE_TXUSER_DTCLURECOVERYINITIATEDBYDTC

If the following arguments: event is signaled, the Transaction Manager Communicating with an LU 6.2 Implementation Facet MUST perform the following actions:

- If the connection state is Awaiting Response To Cold XLN:
 - Set the connection state to Is Obsolete Awaiting Response To Cold XLN.
- Otherwise, if the connection state is Awaiting Response To Warm XLN:
 - Set the connection state to Is Obsolete Awaiting Response To Warm XLN.
- Otherwise, if the connection state is Awaiting LU Status Response:
 - Set the connection state to Is Obsolete Awaiting LU Status Response.

3.3.7.7 Send Cold XLN

The Send Cold XLN event MUST be signaled with the following argument:

- A connection object of type CONNTYPE_TXUSER_DTCLURECOVERYINITIATEDBYDTC

If the Send Cold XLN event is signaled, the Transaction Manager Communicating with an LU 6.2 Implementation Facet MUST perform the following actions:

- Set the connection state to Awaiting Response To Cold XLN.
- Send a TXUSER_DTCLURECOVERYINITIATEDBYDTC_MTAG_WORK_TRANS message using the connection.
 - The **RecoverySeqNum** field of the message MUST be set to the **Recovery Sequence Number For Connection** field of the connection.
 - The **Xln** field of the message MUST be set to DTCLUXLN_COLD.
 - The **cbLength** field of the DTCLU_VARLEN_BYTEARRAY structure (contained in the **OurLogName** field) MUST be set to the number of bytes in the **Local Log Name** field of the LU Pair object referenced by the connection. The first **cbLength** bytes of the **rgbBlob** field of the DTCLU_VARLEN_BYTEARRAY structure (contained in the **OurLogName** field) of the message MUST be set to the **Local Log Name** field of the LU Pair object referenced by the connection.
 - The **cbLength** field of the DTCLU_VARLEN_BYTEARRAY structure (contained in the **RemoteLogName** field) of the message MUST be set to 0.

3.3.7.8 Send Warm XLN

The Send Warm XLN event MUST be signaled with the following argument:

- A connection object of type CONNTYPE_TXUSER_DTCLURECOVERYINITIATEDBYDTC

If the Send Warm XLN event is signaled, the Transaction Manager Communicating with an LU 6.2 Implementation Facet MUST perform the following actions:

- Set the connection state to Awaiting Response To Warm XLN.
- Send a TXUSER_DTCLURECOVERYINITIATEDBYDTC_MTAG_WORK_TRANS message using the connection.
 - The **RecoverySeqNum** field of the message MUST be set to the **Recovery Sequence Number For Connection** field of the connection.
 - The **Xln** field of the message MUST be set to DTCLUXLN_WARM.
 - The **cbLength** field of the DTCLU_VARLEN_BYTEARRAY structure (contained in the **OurLogName** field) MUST be set to the number of bytes in the **Local Log Name** field of the LU Pair object referenced by the connection.
 - The first **cbLength** bytes of the **rgbBlob** field of the DTCLU_VARLEN_BYTEARRAY structure (contained in the **OurLogName** field) of the message MUST be set to the **Local Log Name** field of the LU Pair object referenced by the connection.
 - The **cbLength** field of the DTCLU_VARLEN_BYTEARRAY structure (contained in the **RemoteLogName** field) MUST be set to the number of bytes in the **Remote Log Name** field of the LU Pair object referenced by the connection.

- The first **cbLength** bytes of the **rgbBlob** field of the DTCLU_VARLEN_BYTEARRAY structure (contained in the **RemoteLogName** field) of the message MUST be set to the **Remote Log Name** field of the LU Pair object referenced by the connection.

3.3.7.9 Send Check LU Status

The Send Check LU Status event MUST be signaled with the following argument:

- A connection object of type CONNTYPE_TXUSER_DTCLURECOVERYINITIATEDBYDTC

If the Send Check LU Status event is signaled, the Transaction Manager Communicating with an LU 6.2 Implementation Facet MUST perform the following actions:

- Set the connection state to Awaiting LU Status Response.
- Send a TXUSER_DTCLURECOVERYINITIATEDBYDTC_MTAG_WORK_CHECKLUSTATUS message using the connection.

3.3.7.10 Remote LU Initiated Recovery Obsolete XLN Exchange

The Remote LU Initiated Recovery Obsolete XLN Exchange event MUST be signaled with the following argument:

- A connection object of type CONNTYPE_TXUSER_DTCLURECOVERYINITIATEDBYLU

If the Remote LU Initiated Recovery Obsolete XLN Exchange event is signaled, the Transaction Manager Communicating with an LU 6.2 Implementation Facet MUST perform the following actions:

- If the connection state is Awaiting XLN Confirmation:
 - Set the connection state to Is Obsolete Awaiting XLN Confirmation.

3.3.7.11 Recovery Work Ready

The Recovery Work Ready event MUST be signaled with the following arguments:

- An LU Pair object
- A Recovery Work Ready Reason that MUST be set to one of the following values:
 - Miscellaneous
 - LU Status Timer
 - LUW Recovery

If the Recovery Work Ready event is signaled, the Transaction Manager Communicating with an LU 6.2 Implementation Facet MUST perform the following actions:

- Attempt to find the first connection object in the Local LU Initiated Recovery List that meets the following condition:
 - The state of the connection object is set to Processing Work Query.
- If the connection object is found:
 - If the provided Recovery Work Ready Reason is either set to LUW Recovery, or if all the following conditions are satisfied:

- The **Is LUW Triggered Recovery Pending** flag of the provided LU Pair object is set to TRUE.
- The provided Recovery Work Ready Reason is set to Miscellaneous.
- The **LU Pair Recovery State** field of the provided LU Pair object is set to Synchronized.

Then perform the following actions:

- Set the **Is LUW Triggered Recovery Pending** flag of the provided LU Pair object to TRUE.
- If the **LU Pair Recovery State** field of the provided LU Pair object is set to Synchronized:
 - Attempt to find the first LUW object in the **LUW List** field of the provided LU Pair object that meets the following conditions:
 - The **Is Conversation Lost** flag of the LUW object is set to TRUE.
 - The value of the **Recovery Sequence Number For LUW** field of the LUW object is set to the value of the **Recovery Sequence Number** field of the provided LU Pair object.
 - If an LUW object is found that meets the previous conditions:
 - Set the **Is LUW Triggered Recovery Pending** flag of the provided LU Pair object to FALSE.
 - Set the **Is Conversation Lost** flag of the found LUW object to FALSE.
 - Set the **LU Pair Recovery State** field of the LU Pair object to Synchronized Awaiting LU Status.
 - Set the **Recovery Sequence Number For Connection** field of the previously found connection object to the **Recovery Sequence Number** field of the provided LU Pair object.
 - Signal the Send Check LU Status event on the previously found connection object.
 - Otherwise:
 - Attempt to find the first LUW object in the **LUW List** field of the provided LU Pair object that meets the following condition:
 - The **LUW Recovery State** field of the LUW object is set to Need Recovery.
 - If no LUW object is found that meets the previous conditions:
 - Set the **Is LUW Triggered Recovery Pending** flag to FALSE.
 - If an LUW object is found:
 - The transaction manager that communicates with an LU 6.2 implementation (section 3.2) MUST perform the following actions:
 - Set the **Is LUW Triggered Recovery Pending** flag to FALSE.
 - Set the value of the **Recovery Sequence Number For Connection** field of the previously found connection object to the value of the **Recovery Sequence Number** field of the provided LU Pair object.

- Signal the Send Warm XLN event on the previously found connection object.
- Otherwise, if the provided Recovery Work Ready Reason is set to Miscellaneous:
 - If the following condition is TRUE:
 - The **LU Pair Recovery State** field of the provided LU Pair object is set to Not Synchronized.

Then perform the following actions:

- Signal the Begin Local LU Initiated Synchronization event with the following argument:
 - The provided LU Pair object
 - Set the **Recovery Sequence Number For Connection** field of the previously found connection object to the recovery sequence number of the provided LU Pair object.
 - If the **Is Warm** flag of the provided LU Pair object is set to TRUE:
 - Signal the Send Warm XLN event on the previously found connection object.
 - Otherwise:
 - Signal the Send Cold XLN event on the previously found connection object.
- Otherwise, if the **LU Pair Recovery State** field of the provided LU Pair object is set to Synchronized:
 - Find the first LUW object in the **LUW List** field of the provided LU Pair object that meets the following condition:
 - The **LUW Recovery State** field of the LUW object is set to Need Recovery.
 - If an LUW object is found that meets the previous condition:
 - Set the **Recovery Sequence For Connection** field of the connection object to the recovery sequence number of the provided LU Pair object.
 - Signal the Send Warm XLN event on the previously found connection object.
- Otherwise, if the following conditions are all TRUE:
 - The provided Recovery Work Ready Reason is set to LU Status Timer.
 - The **LU Pair Recovery State** field of the provided LU Pair object is set to Synchronized.

Then perform the following actions:

- Set the **LU Pair Recovery State** field of the LU Pair object to Synchronized Awaiting LU Status.
- Set the **Recovery Sequence Number For Connection** field of the previously found connection object to the **Recovery Sequence Number** field of the provided LU Pair object.
- Signal the Send Check LU Status event on the previously found connection object.
- Otherwise, ignore the event.

- Otherwise:
 - Ignore the event.

3.3.7.12 Received New Recovery Sequence Number

The Received New Recovery Sequence Number event MUST be signaled with the following arguments:

- An LU Pair object
- A New Recovery Sequence Number

The **Received New Recovery Sequence Number** event returns a flag that indicates if the New Recovery Sequence Number received is greater than the recovery sequence number of the provided LU Pair object.

If the Received New Recovery Sequence Number event is signaled, the Transaction Manager Communicating with an LU 6.2 Implementation Facet MUST perform the following actions:

- If the value of the provided the New Recovery Sequence Number is less than or equal to the value of the **Recovery Sequence Number** field of the provided LU Pair object:
 - Set the return value to FALSE.
- Otherwise:
 - Set the **Recovery Sequence Number** field of the provided LU Pair object to the provided New Recovery Sequence Number.
 - If the **LU Pair Recovery State** field of the provided LU Pair object is not set to Not Synchronized:
 - Set the **LU Pair Recovery State** field of the provided LU Pair object to Not Synchronized.
 - Signal the Obsolete All XLN Exchanges event with the following argument:
 - The provided LU Pair object
 - Signal the Recovery Work Ready event with the following arguments:
 - The provided LU Pair object
 - The Recovery Work Ready Reason set to Miscellaneous
 - Set the return value to TRUE.

3.3.7.13 Obsolete All XLN Exchanges

The Obsolete All XLN Exchanges event MUST be signaled with the following argument:

- An LU Pair object

If the Obsolete All XLN Exchanges event is signaled, the Transaction Manager Communicating with an LU 6.2 Implementation Facet MUST perform the following actions:

- For each connection object in the Local LU Initiated Recovery List of the provided LU Pair object:
 - Signal the Local LU Initiated Recovery Obsolete XLN Exchange event on the connection object.
- For each connection object in the Remote LU Initiated Recovery List of the provided LU Pair object:

- Signal the Remote LU Initiated Recovery Obsolete XLN Exchange event on the connection object.

3.3.7.14 Received New Remote Log Name

The Received New Remote Log Name event MUST be signaled with the following arguments:

- An LU Pair object
- A Remote Log Name

If the Received New Remote Log Name event is signaled, the Transaction Manager Communicating with an LU 6.2 Implementation Facet MUST perform the following actions:

- If the **LU Pair Recovery State** field of the provided LU Pair object is set to Synchronizing No Remote Name:
 - Set the **Remote Log Name** field of the provided LU Pair object to the provided remote log name.
 - Set the **LU Pair Recovery State** field of the provided LU Pair object to Synchronizing Have Remote Name.

3.3.7.15 Begin Remote LU Initiated Synchronization

The Begin Remote LU Initiated Synchronization event MUST be signaled with the following argument:

- An LU Pair object

If the Begin Remote LU Initiated Synchronization event is signaled, the Transaction Manager Communicating with an LU 6.2 Implementation Facet MUST perform the following actions:

- If the **LU Pair Recovery State** field of the provided LU Pair object is set to either Not Synchronized or Inconsistent:
 - If the **Is Warm** flag of the provided LU Pair object is set to TRUE:
 - Set the **LU Pair Recovery State** field of the provided LU Pair object to Synchronizing Have Remote Name.
 - Otherwise:
 - Set the **LU Pair Recovery State** field of the provided LU Pair object to Synchronizing No Remote Name.

3.3.7.16 Begin Local LU Initiated Synchronization

The Begin Local LU Initiated Synchronization event MUST be signaled with the following argument:

- An LU Pair object

If the Begin Local LU Initiated Synchronization event is signaled, the Transaction Manager Communicating with an LU 6.2 Implementation Facet MUST perform the following actions:

- If the **LU Pair Recovery State** field of the provided LU Pair object is set to either Not Synchronized or Inconsistent:
 - If the **Is Warm** flag of the provided LU Pair object is set to TRUE:

- Set the **LU Pair Recovery State** field of the provided LU Pair object to Synchronizing Have Remote Name.
- Otherwise:
 - Set the **LU Pair Recovery State** field of the provided LU Pair object to Synchronizing No Remote Name.

3.3.7.17 Synchronization Successful

The Synchronization Successful event MUST be signaled with the following argument:

- An LU Pair object

If the Synchronization Successful event is signaled, the Transaction Manager Communicating with an LU 6.2 Implementation Facet MUST perform the following actions:

- If the **LU Pair Recovery State** field of the provided LU Pair object is set to either Synchronizing No Remote Name or Synchronizing Have Remote Name:
 - Set the **LU Pair Recovery State** field of the provided LU Pair object to Synchronized.
- If the **Is Warm** flag of the provided LU Pair object is set to FALSE:
 - Start an LU Status Timer associated with the provided LU Pair object.
 - Set the **Is Warm** flag of the provided LU Pair object to TRUE.
- Otherwise:
 - Start an LU Status Timer associated with the provided LU Pair object.
 - If the **Is LUW Triggered Recovery Pending** flag of the provided LU Pair object is set to TRUE:
 - Signal the Recovery Work Ready event with the following arguments:
 - The provided LU Pair object
 - The Recovery Work Ready Reason set to LUW Recovery

3.3.7.18 Synchronization Inconsistent

The Synchronization Inconsistent event MUST be signaled with the following argument:

- An LU Pair object

If the Synchronization Inconsistent event is signaled, the Transaction Manager Communicating with an LU 6.2 Implementation Facet MUST perform the following actions:

- If the **LU Pair Recovery State** field of the provided LU Pair object is set to either Synchronized or Synchronized Awaiting LU Status:
 - Set the **LU Pair Recovery State** field of the provided LU Pair object to Not Synchronized.
- Otherwise, if the **LU Pair Recovery State** field of the provided LU Pair object is set to either Synchronizing No Remote Name or Synchronizing Having Remote Name:
 - Set the **LU Pair Recovery State** field of the provided LU Pair object to Inconsistent.
- Signal the Obsolete All XLN Exchanges event with the following argument:

- The provided LU Pair object

3.3.7.19 Received LU Status

The Received LU Status event MUST be signaled with the following argument:

- An LU Pair object

If the Received LU Status event is signaled, the Transaction Manager Communicating with an LU 6.2 Implementation Facet MUST perform the following actions:

- If the **LU Pair Recovery State** field of the provided LU Pair object is set to Synchronized Awaiting LU Status:
 - Set the **LU Pair Recovery State** field of the provided LU Pair object to Synchronized.
- Attempt to find the first LUW object in the LUW List in the provided LU Pair object that meets the following condition:
 - The Recovery state of the LUW object is Need Recovery.
- If an LUW object that meets the previous condition is found or the **Is LUW Triggered Recovery Pending** flag of the provided LU Pair object is TRUE:
 - Signal the Recovery Work Ready event with the following arguments:
 - The provided LU Pair object
 - The Recovery Work Ready Reason set to LUW Recovery
- Otherwise:
 - Start the LU Status Timer that is associated with the provided LU Pair object.

3.3.7.20 Local LU Initiated Recovery Worker Ended

The Local LU Initiated Recovery Worker Ended event MUST be signaled with the following arguments:

- An LU Pair object
- A connection object

If the Local LU Initiated Recovery Worker Ended event is signaled, the Transaction Manager Communicating with an LU 6.2 Implementation Facet MUST perform the following actions:

- If the LU Pair object is not set:
 - Ignore the event.
- Otherwise:
 - Attempt to find the provided connection object in the Local LU Initiated Recovery List of the provided LU Pair object.
 - If found:
 - Remove the provided connection object from the Local LU Initiated Recovery List of the provided LU Pair object.
 - Otherwise:

- Ignore the event.

3.3.7.21 Synchronization Connection Down

The Synchronization Connection Down event MUST be signaled with the following argument:

- An LU Pair object

If the Synchronization Connection Down event is signaled, the Transaction Manager Communicating with an LU 6.2 Implementation Facet MUST perform the following actions:

- If the LU Pair object is set:
 - If the **LU Pair Recovery State** field of the provided LU Pair object is set to either Synchronizing No Remote Name, Synchronizing Have Remote Name, Synchronized, or Synchronized Awaiting LU Status:
 - Set the **LU Pair Recovery State** field of the provided LU Pair object to Not Synchronized.
 - If the **Is Warm** flag of the provided LU Pair object is set to FALSE:
 - Unset the **Remote Log Name** field of the provided LU Pair object.
 - Signal the Obsolete All XLN Exchanges event with the following argument:
 - The provided LU Pair object
 - Signal the Recovery Work Ready event with the following arguments:
 - The provided LU Pair object
 - The Recovery Work Ready Reason set to Miscellaneous.
 - Otherwise:
 - Ignore the event.

3.3.7.22 Remote LU Initiated Recovery Ended

The Remote LU Initiated Recovery Ended event MUST be signaled with the following arguments:

- An LU Pair object
- A connection object

If the Remote LU Initiated Recovery Ended event is signaled, the Transaction Manager Communicating with an LU 6.2 Implementation Facet MUST perform the following actions:

- If the LU Pair object is not set:
 - Ignore the event.
- Otherwise:
 - Attempt to find the provided connection object in the **Remote LU Initiated Recovery List** field of the provided LU Pair object.
 - If found:
 - Remove the provided connection object in the **Remote LU Initiated Recovery List** field of the provided LU Pair object.

- Otherwise:
 - Ignore the event.

3.3.7.23 Recovery Down

The Recovery Down event MUST be signaled with the following argument:

- An LU Pair object

If the Recovery Down event is signaled, the Transaction Manager Communicating with an LU 6.2 Implementation Facet MUST perform the following actions:

- Set the **LU Pair Recovery State** field of the LU Pair object to Recovery Process Not Attached.
- If the **Is Warm** flag of the provided LU Pair object is FALSE:
 - Unset the **Remote Log Name** field of the provided LU Pair object.
- Signal the Obsolete All XLN Exchanges event with the following argument:
 - The provided LU Pair object

3.3.7.24 LUW Conversation Lost

The LUW Conversation Lost event MUST be signaled with the following arguments:

- An LU Pair object
- An LUW object

If the LUW Conversation Lost event is signaled, the Transaction Manager Communicating with an LU 6.2 Implementation Facet MUST perform the following actions:

- Set the **Is Conversation Lost** flag of the provided LUW object to TRUE.
- Signal the Recovery Work Ready event with the following arguments:
 - The provided LU Pair object
 - The Recovery Work Ready Reason set to LUW Recovery

4 Protocol Examples

The following sections describe several examples of common scenarios to illustrate the function of the MSDTC Connection Manager: OleTx Transaction Protocol Logical Unit Mainframe Extension. These protocol examples assume that an OleTx transports session (as specified in [MS-CMPO]) has already been established between the two participants.

Participants communicate with each other using OleTx multiplexing connections (as specified in [MS-CMP]) that are in turn layered on top of the OleTx transports infrastructure (as specified in [MS-CMPO]). In these examples, messages are sent from one participant to another by submitting a MESSAGE_PACKET to the underlying OleTx multiplexing layer, as specified in [MS-CMP] section 2.2.2.

4.1 LU Name Pair Configuration Scenario

This scenario shows how an LU 6.2 implementation (section 3.2) adds an LU Name Pair to the set of LU Name Pairs held by a transaction manager and then deletes it. The scenario begins by the LU 6.2 implementation establishing a transport session with a transaction manager and negotiating its connection resources.

4.1.1 Configuring an LU Name Pair

This packet sequence is initiated by starting a connection on a transport session between an LU 6.2 Implementation and a transaction manager.

The packet sequence starts when an LU 6.2 Implementation initiates a connection using CONNTYPE_TXUSER_DTCLUCONFIGURE.

Field	Value	Value description
MsgTag	0x00000005	MTAG_CONNECTION_REQ
fIsMaster	0x00000001	1
dwConnectionId	0x00000001	1
dwUserMsgType	0x00000018	CONNTYPE_TXUSER_DTCLUCONFIGURE
dwcbVarLenData	0x00000000	0
dwReserved1	0x00000000	0

An LU 6.2 Implementation then sends a TXUSER_DTCLURMCONFIGURE_MTAG_ADD user message that specifies the LU Name Pair. For this example, the LU 6.2 implementation requests to configure an LU Name Pair of 58 bytes that contains the Unicode characters "L"MSFT.L3160200 | MSFT.WNWCI22A".

Field	Value	Value description
MsgTag	0x00000FFF	MTAG_USER_MESSAGE
fIsMaster	0x00000001	1
dwConnectionId	0x00000001	1
dwUserMsgType	0x00004201	TXUSER_DTCLURMCONFIGURE_MTAG_ADD
dwcbVarLenData	0x00000040	64

Field	Value	Value description
dwReserved1	0xCD64CD64	dwReserved1:0xCD64CD64
LuNamePair: cbLength	0x0000003A	58
LuNamePair: rgbBlob	0x0053004D 0x00540046 0x004C002E 0x00310033 0x00300036 0x00300032 0x00200030 0x0020007C 0x0053004D 0x00540046 0x0057002E 0x0057004E 0x00490043 0x00320032 0x00000041	L"MSFT.L3160200 MSFT.WNWCI22A"

When the transaction manager receives the TXUSER_DTCLURMCONFIGURE_MTAG_ADD message from the LU 6.2 Implementation, the transaction manager attempts to configure the LU Name Pair. If the LU Name Pair is successfully configured, the transaction manager sends a TXUSER_DTCLURMCONFIGURE_MTAG_REQUEST_COMPLETED user message to the LU 6.2 implementation.

Field	Value	Value description
MsgTag	0x00000FFF	MTAG_USER_MESSAGE
fIsMaster	0x00000000	0
dwConnectionId	0x00000001	1
dwUserMsgType	0x00004203	TXUSER_DTCLURMCONFIGURE_MTAG_REQUEST_COMPLETED
dwcbVarLenData	0x00000000	0
dwReserved1	0xCD64CD64	dwReserved1:0xCD64CD64

When the LU 6.2 Implementation gets the TXUSER_DTCLURMCONFIGURE_MTAG_REQUEST_COMPLETED response from the transaction manager, no more user messages can be sent on this connection, and the LU 6.2 Implementation initiates the disconnect sequence.

4.1.2 Deleting an LU Name Pair

This packet sequence is initiated by starting a connection on a transport session between an LU 6.2 implementation (section 3.2) and a transaction manager.

The packet sequence starts when an LU 6.2 implementation initiates a connection by using CONNTYPE_TXUSER_DTCLUCONFIGURE.

Field	Value	Value description
MsgTag	0x00000005	MTAG_CONNECTION_REQ
fIsMaster	0x00000001	1
dwConnectionId	0x00000001	1
dwUserMsgType	0x00000018	CONNTYPE_TXUSER_DTCLUCONFIGURE
dwcbVarLenData	0x00000000	0
dwReserved1	0x00000000	0

The LU 6.2 implementation then sends a TXUSER_DTCLURMCONFIGURE_MTAG_DELETE user message that specifies the LU Name Pair that it had added previously. For this example, the LU 6.2 implementation requests to delete the LU Name Pair of 58 bytes that contains the Unicode characters "L"MSFT.L3160200 | MSFT.WNWCI22A".

Field	Value	Value description
MsgTag	0x00000FFF	MTAG_USER_MESSAGE
fIsMaster	0x00000001	1
dwConnectionId	0x00000001	1
dwUserMsgType	0x00004202	TXUSER_DTCLURMCONFIGURE_MTAG_DELETE
dwcbVarLenData	0x00000040	64
dwReserved1	0xCD64CD64	dwReserved1:0xCD64CD64
LuNamePair: cbLength	0x0000003A	58
LuNamePair: rgbBlob	0x0053004D 0x00540046 0x004C002E 0x00310033 0x00300036 0x00300032 0x00200030 0x0020007C 0x0053004D 0x00540046 0x0057002E 0x0057004E 0x00490043 0x00320032 0x00000041	L"MSFT.L3160200 MSFT.WNWCI22A"

When the transaction manager receives the TXUSER_DTCLURMCONFIGURE_MTAG_DELETE message from the LU 6.2 implementation, the transaction manager attempts to delete the LU Name Pair. If the LU Name Pair is successfully deleted, the transaction manager sends a TXUSER_DTCLURMCONFIGURE_MTAG_REQUEST_COMPLETED user message to the LU 6.2 implementation.

Field	Value	Value description
MsgTag	0x00000FFF	MTAG_USER_MESSAGE
fIsMaster	0x00000000	0
dwConnectionId	0x00000001	1
dwUserMsgType	0x00004203	TXUSER_DTCLURMCONFIGURE_MTAG_REQUEST_COMPLETED
dwcbVarLenData	0x00000000	0
dwReserved1	0xCD64CD64	dwReserved1:0xCD64CD64

When the LU 6.2 implementation gets the TXUSER_DTCLURMCONFIGURE_MTAG_REQUEST_COMPLETED response from its transaction manager, no more user messages can be sent on this connection, and the LU 6.2 implementation initiates the disconnect sequence.

4.2 Registering as the Recovery Process for an LU Name Pair Scenario

This scenario shows how an LU 6.2 implementation registers as the recovery process for an LU Name Pair with a transaction manager. The scenario begins by the LU 6.2 implementation establishing a transport session with a transaction manager and negotiating its connection resources. It assumes that the LU Name Pair for which the recovery process is being registered was configured with the transaction manager (section 4.1.1).

4.2.1 Registering the Recovery Process

This packet sequence is initiated by starting a connection on a transport session between an LU 6.2 implementation and a transaction manager.

The packet sequence starts when an LU 6.2 implementation initiates a connection by using CONNTYPE_TXUSER_DTCLURECOVERY.

Field	Value	Value description
MsgTag	0x00000005	MTAG_CONNECTION_REQ
fIsMaster	0x00000001	1
dwConnectionId	0x00000001	1
dwUserMsgType	0x00000019	CONNTYPE_TXUSER_DTCLURECOVERY
dwcbVarLenData	0x00000000	0
dwReserved1	0x00000000	0

The LU 6.2 implementation then sends a TXUSER_DTCLURMRECOVERY_MTAG_ATTACH user message that specifies an LU Name Pair that has been configured with the transaction manager. For this example, the LU 6.2 implementation requests to register as the recovery process for the LU Name Pair of 58 bytes that contains the Unicode characters "L"MSFT.L3160200 | MSFT.WNWCI22A".

Field	Value	Value description
MsgTag	0x00000FFF	MTAG_USER_MESSAGE
fIsMaster	0x00000001	1

Field	Value	Value description
dwConnectionId	0x00000001	1
dwUserMsgType	0x00004301	TXUSER_DTCLURMRECOVERY_MTAG_ATTACH
dwcbVarLenData	0x00000040	64
dwReserved1	0xCD64CD64	dwReserved1:0xCD64CD64
LuNamePair: cbLength	0x0000003A	58
LuNamePair: rgbBlob	0x0053004D 0x00540046 0x004C002E 0x00310033 0x00300036 0x00300032 0x00200030 0x0020007C 0x0053004D 0x00540046 0x0057002E 0x0057004E 0x00490043 0x00320032 0x00000041	L"MSFT.L3160200 MSFT.WNWC122A"

When the transaction manager receives the TXUSER_DTCLURMRECOVERY_MTAG_ATTACH message from the LU 6.2 implementation, the transaction manager attempts to register the connection's MSDTC Connection Manager: OleTx Transports Protocol (as specified in [MS-CMPO]) session for all Recovery Processing associated with the LU Name Pair. If the transaction manager successfully registers this connection, the transaction manager sends a TXUSER_DTCLURMRECOVERY_MTAG_REQUEST_COMPLETED user message to the LU 6.2 implementation.

Field	Value	Value description
MsgTag	0x00000FFF	MTAG_USER_MESSAGE
fIsMaster	0x00000000	0
dwConnectionId	0x00000001	1
dwUserMsgType	0x00004303	TXUSER_DTCLURMRECOVERY_MTAG_REQUEST_COMPLETED
dwcbVarLenData	0x00000000	0
dwReserved1	0xCD64CD64	dwReserved1:0xCD64CD64

When the LU 6.2 implementation receives the TXUSER_DTCLURMRECOVERY_MTAG_REQUEST_COMPLETED user message from the transaction manager, the LU 6.2 implementation maintains the connection so that it can receive notifications of the need to perform recovery work.

4.2.2 Unregistering the Recovery Process

To unregister from the recovery process, the LU 6.2 implementation initiates the disconnect sequence on the connection that it used to register as the recovery process.

4.3 Performing Cold Recovery for an LU Name Pair Scenario

This scenario shows how an LU 6.2 implementation performs cold recovery for an LU Name Pair with a transaction manager. The scenario begins by the LU 6.2 implementation establishing a transport session with a transaction manager and negotiating its connection resources. It assumes that the LU 6.2 implementation has already registered a connection as the recovery process for the LU Name Pair (section 4.2.1) and is maintaining that connection.

4.3.1 Performing Cold Recovery

This packet sequence is initiated by starting a connection on a transport session between an LU 6.2 implementation and a transaction manager.

The packet sequence starts when an LU 6.2 implementation initiates a connection by using CONNTYPE_TXUSER_DTCLURECOVERYINITIATEDBYDTC.

Field	Value	Value description
MsgTag	0x00000005	MTAG_CONNECTION_REQ
fIsMaster	0x00000001	1
dwConnectionId	0x00000003	3
dwUserMsgType	0x00000020	CONNTYPE_TXUSER_DTCLURECOVERYINITIATEDBYDTC
dwcbVarLenData	0x00000000	0
dwReserved1	0x00000000	0

The LU 6.2 implementation then sends a TXUSER_DTCLURECOVERYINITIATEDBYDTC_MTAG_GETWORK user message to the transaction manager that specifies the LU Name Pair with which the LU 6.2 implementation registered as the recovery process. For this example, the LU 6.2 implementation requests to obtain any recovery work related to the LU Name Pair of 58 bytes that contains the Unicode characters "L"MSFT.L3160200 | MSFT.WNWC122A".

Field	Value	Value description
MsgTag	0x00000FFF	MTAG_USER_MESSAGE
fIsMaster	0x00000001	1
dwConnectionId	0x00000003	3
dwUserMsgType	0x00004401	TXUSER_DTCLURECOVERYINITIATEDBYDTC_MTAG_GETWORK
dwcbVarLenData	0x00000040	64
dwReserved1	0xCD64CD64	dwReserved1:0xCD64CD64
LuNamePair: cbLength	0x0000003A	58
LuNamePair: rgbBlob	0x0053004D 0x00540046	L"MSFT.L3160200 MSFT.WNWC122A"

Field	Value	Value description
	0x004C002E 0x00310033 0x00300036 0x00300032 0x00200030 0x0020007C 0x0053004D 0x00540046 0x0057002E 0x0057004E 0x00490043 0x00320032 0x00000041	

When the transaction manager receives the TXUSER_DTCLURECOVERYINITIATEDBYDTC_MTAG_GETWORK user message from the LU 6.2 implementation, it attempts to determine whether there is any recovery work to do for the LU Name Pair. In this example, the transaction manager has never performed recovery with respect to the LU Name Pair, and sends a TXUSER_DTCLURECOVERYINITIATEDBYDTC_MTAG_WORK_TRANS user message to request cold recovery (**XIn** = DTCLUXLN_COLD). In this example, the message specifies a recovery sequence number set to 1, the **dwProtocol** set to 0, the transaction manager's log name ("A4201087-FED1-4F15-B06B-9E91CA89B11C"), and an empty **RemoteLog Name**.

Field	Value	Value description
MsgTag	0x00000FFF	MTAG_USER_MESSAGE
fIsMaster	0x00000000	0
dwConnectionId	0x00000003	3
dwUserMsgType	0x00004404	TXUSER_DTCLURECOVERYINITIATEDBYDTC_MTAG_WORK_TRANS
dwcbVarLenData	0x00000038	56
dwReserved1	0xCD64CD64	dwReserved1:0xCD64CD64
lRecoverySeqNum	0x00000001	1
XIn	0x00000001	DTCLUXLN_COLD
dwProtocol	0x00000000	0
OurLogName: cbLength	0x00000024	36
OurLogName: rgbBlob	0x30323461 0x37383031 0x6465662D 0x66342D31 0x622D3531 0x2D623630 0x31396539 0x39386163 0x63313162	"A4201087-FED1-4F15-B06B-9E91CA89B11C"

Field	Value	Value description
RemoteLogName: cbLength	0x00000000	0

When the LU 6.2 implementation receives the TXUSER_DTCLURECOVERYINITIATEDBYDTC_MTAG_WORK_TRANS user message, the LU 6.2 implementation attempts to exchange log names with the remote LU. For this example, the exchange is successful and the LU 6.2 implementation sends a TXUSER_DTCLURECOVERYINITIATEDBYDTC_MTAG_THEIR_XLN_RESPONSE user message to the transaction manager that specifies cold recovery ("Xln = DTCLUXLN_COLD"), and an 8-byte **RemoteLogName** (EBCDIC("0705CE30")).

Field	Value	Value description
MsgTag	0x00000FFF	MTAG_USER_MESSAGE
fIsMaster	0x00000001	1
dwConnectionId	0x00000003	3
dwUserMsgType	0x00004410	TXUSER_DTCLURECOVERYINITIATEDBYDTC_MTAG_THEIR_XLN_RESPONSE
dwcbVarLenData	0x00000014	20
dwReserved1	0xCD64CD64	dwReserved1:0xCD64CD64
Xln	0x00000001	DTCLUXLN_COLD
dwProtocol	0x00000000	0
RemoteLogName: cbLength	0x00000008	8
RemoteLogName: rgbBlob	0xF5F0F7F0 0xF0F3C5C3	EBCDIC("0705CE30")

When the transaction manager receives the TXUSER_DTCLURECOVERYINITIATEDBYDTC_MTAG_THEIR_XLN_RESPONSE user message, it verifies that the reported state of the remote LU is consistent with the transaction manager's state. For this example, the transaction manager sends a TXUSER_DTCLURECOVERYINITIATEDBYDTC_MTAG_CONFIRMATION_FOR_THEIR_XLN user message that specifies that it confirms the message (**XlnConfirmation** = DTCLUXLNCONFIRMATION_CONFIRM).

Field	Value	Value description
MsgTag	0x00000FFF	MTAG_USER_MESSAGE
fIsMaster	0x00000000 0	0
dwConnectionId	0x00000003 3	3
dwUserMsgType	0x00004411 1	TXUSER_DTCLURECOVERYINITIATEDBYDTC_MTAG_CONFIRMATION_FOR_THEIR_XLN
dwcbVarLenData	0x00000004 4	4
dwReserved1	0xCD64CD64	dwReserved1: 0xCD64CD64

Field	Value	Value description
	4	
XlnConfirmation	0x00000001	DTCLUXLNCONFIRMATION_CONFIRM

When the LU 6.2 implementation receives the TXUSER_DTCLURECOVERYINITIATEDBYDTC_MTAG_CONFIRMATION_FOR_THEIR_XLN user message, it sends a TXUSER_DTCLURECOVERYINITIATEDBYDTC_MTAG_CHECK_FOR_COMPARESTATES user message to the transaction manager to query whether recovery work is required for an LUW that involves the LU Name Pair.

Field	Value	Value description
MsgTag	0x00000FFF	MTAG_USER_MESSAGE
fIsMaster	0x00000001	1
dwConnectionId	0x00000003	3
dwUserMsgType	0x00004413	TXUSER_DTCLURECOVERYINITIATEDBYDTC_MTAG_CHECK_FOR_COMPARESTATES
dwcbVarLenData	0x00000000	0
dwReserved1	0xCD64CD64	dwReserved1: 0xCD64CD64

When the transaction manager receives the TXUSER_DTCLURECOVERYINITIATEDBYDTC_MTAG_CHECK_FOR_COMPARESTATES user message, it checks to see if a comparison of local and remote LUW state is required. For this example, the transaction manager sends a TXUSER_DTCLURECOVERYINITIATEDBYDTC_MTAG_NO_COMPARESTATES user message to the LU 6.2 implementation.

Field	Value	Value description
MsgTag	0x00000FFF	MTAG_USER_MESSAGE
fIsMaster	0x00000000	0
dwConnectionId	0x00000003	3
dwUserMsgType	0x00004415	TXUSER_DTCLURECOVERYINITIATEDBYDTC_MTAG_NO_COMPARESTATES
dwcbVarLenData	0x00000000	0
dwReserved1	0xCD64CD64	dwReserved1: 0xCD64CD64

When the LU 6.2 implementation receives the TXUSER_DTCLURECOVERYINITIATEDBYDTC_MTAG_NO_COMPARESTATES user message, no further messages are sent that use this connection and the LU 6.2 implementation initiates the disconnect sequence.

4.4 Enlisting in an OleTx Transaction as an LU 6.2 Implementation Scenario

This scenario shows how an LU 6.2 implementation enlists in an OleTx transaction, and then participates in the Two-Phase Commit protocol. The scenario begins by the LU 6.2 implementation

establishing a transport session with a transaction manager and negotiating its connection resources. It assumes that an LU 6.2 implementation has already registered a connection as the recovery process for the LU Name Pair Registering the Recovery Process (section 4.2.1), is maintaining that connection, and has performed recovery Performing Cold Recovery for an LU Name Pair Scenario (section 4.3). For this example, it is also assumed that a transaction program has begun an OleTx transaction and that it will commit the transaction (for more information, see [MS-DTCO] section 4.1).

4.4.1 Enlisting an LUW on an OleTx Transaction

This packet sequence is initiated by starting a connection on a transport session between an LU 6.2 implementation and a transaction manager.

Field	Value	Value description
MsgTag	0x00000005	MTAG_CONNECTION_REQ
fIsMaster	0x00000001	1
dwConnectionId	0x00000003	3
dwUserMsgType	0x00000016	CONNTYPE_TXUSER_DTCLURMENLISTMENT
dwcbVarLenData	0x00000000	0
dwReserved1	0xCD64CD64	dwReserved1: 0xCD64CD64

The LU 6.2 implementation then sends a TXUSER_DTCLURMENLISTMENT_MTAG_CREATE user message that specifies the OleTx transaction (**guidTx** = "A9B05F39-2368-4C99-94BC-7B5A4BB3F07D"), the LU Name Pair of 58 bytes that contains the Unicode characters "L"MSFT.L3160200 | MSFT.WNWCI22A"", and the LUW **LuTransId** of 130 bytes that contains four concatenated Unicode strings ("L"MSFT.L3160200"; L"07D73802F87D0001"; L"B2E7020300000001"; L"0000000000000003").

Field	Value	Value description
MsgTag	0x00000FFF	MTAG_USER_MESSAGE
fIsMaster	0x00000001	1
dwConnectionId	0x00000003	3
dwUserMsgType	0x00004101	TXUSER_DTCLURMENLISTMENT_MTAG_CREATE
dwcbVarLenData	0x000000D8	216
dwReserved1	0xCD64CD64	dwReserved1:0xCD64CD64
guidTx	0xA9B05F39 0x4C992368 0x5A7BBC94 0x7DF0B34B	A9B05F39-2368-4C99-94BC-7B5A4BB3F07D
LuNamePair: cbLength	0x0000003A	58
LuNamePair: rgbBlob	0x0053004D 0x00540046 0x004C002E 0x00310033 0x00300036 0x00300032	L"MSFT.L3160200 MSFT.WNWCI22A"

Field	Value	Value description
	0x00200030 0x0020007C 0x0053004D 0x00540046 0x0057002E 0x0057004E 0x00490043 0x00320032 0x00000041	
LuTransId: cbLength	0x00000082	130
LuTransId: rgbBlob	0x0053004D 0x00540046 0x004C002E 0x00310033 0x00300036 0x00300032 0x00000030 0x00370030 0x00370044 0x00380033 0x00320030 0x00380046 0x00440037 0x00300030 0x00310030 0x00420000 0x00450032 0x00300037 0x00300032 0x00300033 0x00300030 0x00300030 0x00300030 0x00300030 0x00000031 0x00300030 0x00300030 0x00300030 0x00300030 0x00300030 0x00300030 0x00300030 0x00330030 0x00000000	L"MSFT.L3160200" L"07D73802F87D0001" L"B2E7020300000001" L"0000000000000003"

When the transaction manager receives the TXUSER_DTCLURMENLISTMENT_MTAG_CREATE user message, it attempts to create an LU enlistment on the OleTx transaction, associating it with the LU Name Pair and the LUW **LuTransId**. For this example, the enlistment is successful and the transaction

manager sends a TXUSER_DTCLURMENLISTMENT_MTAG_REQUEST_COMPLETED user message to the LU 6.2 implementation.

Field	Value	Value description
MsgTag	0x00000FFF	MTAG_USER_MESSAGE
fIsMaster	0x00000000	0
dwConnectionId	0x00000003	3
dwUserMsgType	0x00004102	TXUSER_DTCLURMENLISTMENT_MTAG_REQUEST_COMPLETED
dwcbVarLenData	0x00000000	0
dwReserved1	0xCD64CD64	dwReserved1: 0xCD64CD64

When the LU 6.2 implementation (section 3.2) receives the TXUSER_DTCLURMENLISTMENT_MTAG_REQUEST_COMPLETED user message, it maintains the connection and waits for Two-Phase Commit message processing.

4.4.2 Participating in Two Phase Commit

When the OleTx transaction is committed, the transaction manager sends a TXUSER_DTCLURMENLISTMENT_MTAG_TO_LU_PREPARE user message to the LU 6.2 implementation.

Field	Value	Value description
MsgTag	0x00000FFF	MTAG_USER_MESSAGE
fIsMaster	0x00000000	0
dwConnectionId	0x00000004	4
dwUserMsgType	0x00004113	TXUSER_DTCLURMENLISTMENT_MTAG_TO_LU_PREPARE
dwcbVarLenData	0x00000000	0
dwReserved1	0xCD64CD64	dwReserved1: 0xCD64CD64

When the LU 6.2 implementation receives the TXUSER_DTCLURMENLISTMENT_MTAG_TO_LU_PREPARE user message, it attempts to complete Phase One preparation work. For this example, the LU 6.2 implementation successfully completes its preparation work and sends a TXUSER_DTCLURMENLISTMENT_MTAG_TO_DTC_REQUESTCOMMIT user message to the transaction manager.

Field	Value	Value description
MsgTag	0x00000FFF	MTAG_USER_MESSAGE
fIsMaster	0x00000001	1
dwConnectionId	0x00000004	4
dwUserMsgType	0x00004108	TXUSER_DTCLURMENLISTMENT_MTAG_TO_DTC_REQUESTCOMMIT
dwcbVarLenData	0x00000000	0
dwReserved1	0xCD64CD64	dwReserved1: 0xCD64CD64

When the transaction manager receives the TXUSER_DTCLURMENLISTMENT_MTAG_TO_DTC_REQUESTCOMMIT user message, it notes that the logical unit of work is prepared and awaits entry to Phase Two. For this example, the transaction manager decides that the transaction outcome is a commit outcome, and sends a TXUSER_DTCLURMENLISTMENT_MTAG_TO_LU_COMMITTED user message to the LU 6.2 implementation.

Field	Value	Value description
MsgTag	0x00000FFF	MTAG_USER_MESSAGE
fIsMaster	0x00000000	0
dwConnectionId	0x00000004	4
dwUserMsgType	0x00004111	TXUSER_DTCLURMENLISTMENT_MTAG_TO_LU_COMMITTED
dwcbVarLenData	0x00000000	0
dwReserved1	0xCD64CD64	dwReserved1: 0xCD64CD64

When the LU 6.2 implementation receives the TXUSER_DTCLURMENLISTMENT_MTAG_TO_LU_COMMITTED user message, it attempts to complete its commit processing. In this example, the commit processing succeeds and it sends a TXUSER_DTCLURMENLISTMENT_MTAG_TO_DTC_FORGET user message to the transaction manager.

Field	Value	Value description
MsgTag	0x00000FFF	MTAG_USER_MESSAGE
fIsMaster	0x00000001	1
dwConnectionId	0x00000004	4
dwUserMsgType	0x00004107	TXUSER_DTCLURMENLISTMENT_MTAG_TO_DTC_FORGET
dwcbVarLenData	0x00000000	0
dwReserved1	0xCD64CD64	dwReserved1: 0xCD64CD64

The LU 6.2 implementation then sends a TXUSER_DTCLURMENLISTMENT_MTAG_UNPLUG user message to the transaction manager.

Field	Value	Value description
MsgTag	0x00000FFF	MTAG_USER_MESSAGE
fIsMaster	0x00000001	1
dwConnectionId	0x00000004	4
dwUserMsgType	0x00004122	TXUSER_DTCLURMENLISTMENT_MTAG_UNPLUG
dwcbVarLenData	0x00000000	0
dwReserved1	0xCD64CD64	dwReserved1: 0xCD64CD64

The connection is now complete and the LU 6.2 implementation initiates the disconnect sequence.

4.5 Performing Warm Recovery for an LU Name Pair Scenario

This scenario shows how an LU 6.2 implementation performs warm recovery with a transaction manager. In this scenario, the LU 6.2 implementation recovers a transaction in the failed-to-notify state with the transaction manager. Such a scenario occurs when an LU 6.2 implementation fails to send a TXUSER_DTCLURMENLISTMENT_MTAG_TO_DTC_FORGET user message in response to a TXUSER_DTCLURMENLISTMENT_MTAG_TO_LU_COMMITTED user message from the transaction manager.

The scenario begins by the LU 6.2 implementation establishing a transport session with a transaction manager and negotiating its connection resources. It assumes that the LU 6.2 implementation has already registered a connection as the recovery process for the LU Name Pair Registering the Recovery Process (section 4.2.1) and is maintaining that connection.

4.5.1 Performing Warm Recovery

This packet sequence is initiated by starting a new connection on a transport session between an LU 6.2 implementation and a transaction manager.

The packet sequence starts when an LU 6.2 implementation initiates a connection by using CONNTYPE_TXUSER_DTCLURECOVERYINITIATEDBYDTC.

Field	Value	Value description
MsgTag	0x00000005	MTAG_CONNECTION_REQ
fIsMaster	0x00000001	1
dwConnectionId	0x00000003	3
dwUserMsgType	0x00000020	CONNTYPE_TXUSER_DTCLURECOVERYINITIATEDBYDTC
dwcbVarLenData	0x00000000	0
dwReserved1	0x00000000	0

The LU 6.2 implementation then sends a TXUSER_DTCLURECOVERYINITIATEDBYDTC_MTAG_GETWORK user message to the transaction manager that specifies the LU Name Pair with which the LU 6.2 implementation has registered as the recovery process. For this example, the LU 6.2 implementation requests to obtain any recovery work related to the LU Name Pair of 58 bytes that contains the Unicode characters "L"MSFT.L3160200 | MSFT.WNWC122A".

Field	Value	Value description
MsgTag	0x00000FFF	MTAG_USER_MESSAGE
fIsMaster	0x00000001	1
dwConnectionId	0x00000003	3
dwUserMsgType	0x00004401	TXUSER_DTCLURECOVERYINITIATEDBYDTC_MTAG_GETWORK
dwcbVarLenData	0x00000040	64
dwReserved1	0xCD64CD64	dwReserved1:0xCD64CD64
LuNamePair: cbLength	0x0000003A	58
LuNamePair: rgbBlob	0x0053004D	L"MSFT.L3160200 MSFT.WNWC122A"

Field	Value	Value description
	0x00540046 0x004C002E 0x00310033 0x00300036 0x00300032 0x00200030 0x0020007C 0x0053004D 0x00540046 0x0057002E 0x0057004E 0x00490043 0x00320032 0x00000041	

When the transaction manager receives the TXUSER_DTCLURECOVERYINITIATEDBYDTC_MTAG_GETWORK user message, it attempts to determine if there are any transactions that require recovery work associated with the LU Name Pair. For this example, the transaction manager determines that there are one or more transactions that require recovery work, and sends a TXUSER_DTCLURECOVERYINITIATEDBYDTC_MTAG_WORK_TRANS user message to the LU 6.2 implementation that specifies warm recovery (**tmXln** = DTCLUXLN_WARM), a recovery sequence number set to 1, the **dwProtocol** set to 0, the transaction manager's log name ("A4201087-FED1-4F15-B06B-9E91CA89B11C"), and an 8-byte Remote LU Log Name (EBCDIC("0705CE30")).

Field	Value	Value description
MsgTag	0x00000FFF	MTAG_USER_MESSAGE
fIsMaster	0x00000000	0
dwConnectionId	0x00000003	3
dwUserMsgType	0x00004404	TXUSER_DTCLURECOVERYINITIATEDBYDTC_MTAG_WORK_TRANS
dwcbVarLenData	0x00000040	64
dwReserved1	0xCD64CD64	dwReserved1:0xCD64CD64
lRecoverySeqNum	0x00000001	1
Xln	0x00000002	DTCLUXLN_WARM
dwProtocol	0x00000000	0
OurLogName: cbLength	0x00000024	36
OurLogName: rgbBlob	0x30323461 0x37383031 0x6465662D 0x66342D31 0x622D3531 0x2D623630 0x31396539	"A4201087-FED1-4F15-B06B-9E91CA89B11C"

Field	Value	Value description
	0x39386163 0x63313162	
RemoteLogName: cbLength	0x0000008	8
RemoteLogName: rgbBlob	0xF5F0F7F0 0xF0F3C5C3	EBCDIC("0705CE30")

When the LU 6.2 implementation receives the TXUSER_DTCLURECOVERYINITIATEDBYDTC_MTAG_WORK_TRANS user message, it attempts to initiate an exchange of Exchange Log Name (XLN) messages with the remote LU. For this example, the LU 6.2 implementation succeeds in this and sends a TXUSER_DTCLURECOVERYINITIATEDBYDTC_MTAG_CHECK_FOR_COMPARESTATES user message to the transaction manager.

Field	Value	Value description
MsgTag	0x00000FFF	MTAG_USER_MESSAGE
fIsMaster	0x00000001	1
dwConnectionId	0x00000003	3
dwUserMsgType	0x00004413	TXUSER_DTCLURECOVERYINITIATEDBYDTC_MTAG_CHECK_FOR_COMPARESTATES
dwcbVarLenData	0x00000000	0
dwReserved1	0xCD64CD64	dwReserved1:0xCD64CD64

When the transaction manager receives the TXUSER_DTCLURECOVERYINITIATEDBYDTC_MTAG_CHECK_FOR_COMPARESTATES user message, it locates an unresolved transaction associated with the LU Name Pair. For this example, the transaction manager locates a failed-to-notify transaction, and sends a TXUSER_DTCLURECOVERYINITIATEDBYDTC_MTAG_COMPARESTATES_INFO user message to the LU 6.2 implementation that specifies a **CompareStates** set to 1 (DTCLUCOMPARESTATE_COMMITTED), and an LUW **LuTransId** of 130 bytes that contains four concatenated Unicode strings ("L"MSFT.L3160200"; L"07D73802F87D0001"; L"B2E7020300000001"; L"0000000000000003").

Field	Value	Value description
MsgTag	0x00000FFF	MTAG_USER_MESSAGE
fIsMaster	0x00000000	0
dwConnectionId	0x00000003	3
dwUserMsgType	0x00004414	TXUSER_DTCLURECOVERYINITIATEDBYDTC_MTAG_COMPARESTATES_INFO
dwcbVarLenData	0x0000008C	140
dwReserved1	0xCD64CD64	dwReserved1:0xCD64CD64
CompareStates	0x00000001	DTCLUCOMPARESTATE_COMMITTED
LuTransId:	0x00000082	130

Field	Value	Value description
cbLength		
LuTransId: rgbBlob	0x0053004D 0x00540046 0x004C002E 0x00310033 0x00300036 0x00300032 0x00000030 0x00370030 0x00370044 0x00380033 0x00320030 0x00380046 0x00440037 0x00300030 0x00310030 0x00420000 0x00450032 0x00300037 0x00300032 0x00300033 0x00300030 0x00300030 0x00300030 0x00000031 0x00300030 0x00300030 0x00300030 0x00300030 0x00300030 0x00300030 0x00300030 0x00300030 0x00330030 0x00000000	L"MSFT.L3160200" L"07D73802F87D0001" L"B2E7020300000001" L"0000000000000003"

When the LU 6.2 implementation receives the TXUSER_DTCLURECOVERYINITIATEDBYDTC_MTAG_COMPARESTATES_INFO user message, it attempts to identify the LUW for which recovery is to be performed by using the LUW LuTransId. For this example, the LU 6.2 implementation identifies the LUW and initiates an exchange of Compare States messages with the remote LU. The LU 6.2 implementation then waits for an XLN message from the remote LU. In this example, an XLN message is received, and the LU 6.2 implementation sends a TXUSER_DTCLURECOVERYINITIATEDBYDTC_MTAG_THEIR_XLN_RESPONSE user message to the transaction manager that specifies warm recovery (**Xln** = DTCLUXLN_WARM), **dwProtocol** set to 0, and an 8-byte Remote LU Log Name (EBCDIC("0705CE30")).

Field	Value	Value description
MsgTag	0x00000FFF	MTAG_USER_MESSAGE
fIsMaster	0x00000001	1

Field	Value	Value description
dwConnectionId	0x00000003	3
dwUserMsgType	0x00004410	TXUSER_DTCLURECOVERYINITIATEDBYDTC_MTAG_THEIR_XLN_RESPONSE
dwcbVarLenData	0x00000014	20
dwReserved1	0xCD64CD64	dwReserved1:0xCD64CD64
Xln	0x00000002	DTCLUXLN_WARM
dwProtocol	0x00000000	0
RemoteLogName: cbLength	0x00000008	8
RemoteLogName: rgbBlob	0xF5F0F7F0 0xF0F3C5C3	EBCDIC("0705CE30")

When the transaction manager receives the TXUSER_DTCLURECOVERYINITIATEDBYDTC_MTAG_THEIR_XLN_RESPONSE user message, it attempts to check the consistency of its state with the reported state of the remote LU. For this example, the transaction manager finds no consistency problems, and sends a TXUSER_DTCLURECOVERYINITIATEDBYDTC_MTAG_CONFIRMATION_FOR_THEIR_XLN user message that specifies **XlnConfirmation** set to 1 (DTCLUXLNCONFIRMATION_CONFIRM).

Field	Value	Value description
MsgTag	0x00000FFF	MTAG_USER_MESSAGE
fIsMaster	0x00000000 0	0
dwConnectionId	0x00000003	3
dwUserMsgType	0x00004411	TXUSER_DTCLURECOVERYINITIATEDBYDTC_MTAG_CONFIRMATION_FOR_THEIR_XLN
dwcbVarLenData	0x00000004	4
dwReserved1	0xCD64CD64	dwReserved1:0xCD64CD64
XlnConfirmation	0x00000001	DDTCLUXLNCONFIRMATION_CONFIRM

When the LU 6.2 implementation receives the TXUSER_DTCLURECOVERYINITIATEDBYDTC_MTAG_CONFIRMATION_FOR_THEIR_XLN user message, it waits for a Compare States message from the remote LU. In this example, a Compare States message is received, and the information it carries is sent to the transaction manager by using a TXUSER_DTCLURECOVERYINITIATEDBYDTC_MTAG_THEIR_COMPARESTATES user message that specifies the **CompareStates** set to 1 (DTCLUCOMPARESTATE_COMMITTED).

Field	Value	Value description
MsgTag	0x00000FFF	MTAG_USER_MESSAGE
fIsMaster	0x00000001	1

Field	Value	Value description
dwConnectionId	0x00000003	3
dwUserMsgType	0x00004416	TXUSER_DTCLURECOVERYINITIATEDBYDTC_MTAG_THEIR_COMPARESTATES
dwcbVarLenData	0x00000004	4
dwReserved1	0xCD64CD64	dwReserved1:0xCD64CD64
XlnConfirmation	0x00000001	DTCLUCOMPARESTATE_COMMITTED

When the transaction manager receives the TXUSER_DTCLURECOVERYINITIATEDBYDTC_MTAG_THEIR_COMPARESTATES user message, it checks the consistency of the LUW state that it holds and the reported LUW state held by the remote LU. In this example, the transaction manager finds no inconsistency and sends a TXUSER_DTCLURECOVERYINITIATEDBYDTC_MTAG_CONFIRMATION_FOR_THEIR_COMPARESTATES user message to the LU 6.2 implementation that specifies **CompareStatesConfirmation** set to 1 (DTCLUCOMPARESTATESCONFIRMATION_CONFIRM).

Field	Value	Value description
MsgTag	0x0000FF	MTAG_USER_MESSAGE
fIsMaster	0x000000	0
dwConnectionId	0x00000003	3
dwUserMsgType	0x00004417	TXUSER_DTCLURECOVERYINITIATEDBYDTC_MTAG_CONFIRMATION_FOR_T HEIR_COMPARESTATES
dwcbVarLenData	0x00000004	4
dwReserved1	0xCD64CD64	dwReserved1:0xCD64CD64
CompareStatesConfirmation	0x00000001	DTCLUCOMPARESTATESCONFIRMATION_CONFIRM

When the LU 6.2 implementation receives the TXUSER_DTCLURECOVERYINITIATEDBYDTC_MTAG_CONFIRMATION_FOR_THEIR_COMPARESTATES user message, no more messages are to be sent on the connection, and the LU 6.2 implementation initiates the disconnect sequence.

5 Security

5.1 Security Considerations for Implementers

The transaction processing protocol that is defined by this specification is intended for use in an environment where all participants are trusted to collaborate in driving transactions toward a final outcome.

Misuse of this transaction processing protocol can enable participants to perform simple denial of service attacks on their transaction managers. Because transaction managers generally communicate with multiple participants simultaneously, this condition represents a denial of service to other participants.

Consequently, implementers need to take the following steps to ensure that transaction processing occurs in a secure environment:

- Each participant initializes MSDTC Connection Manager: OleTx Transports Protocol sessions by using Mutual Authentication, <8> as described in [MS-CMPO].
- No transaction remains In Doubt for a longer period of time than the application's higher-layer business logic accepts.
- An implementation has the option to further restrict its exposure to security vulnerabilities by initializing the **LU Transactions Enabled** flag, defined in section 3.2.1, to FALSE. <9>

6 (Updated Section) Appendix A: Product Behavior

The information in this specification is applicable to the following Microsoft products or supplemental software. References to product versions include updates to those products.

- Windows 2000 operating system
- Windows XP operating system
- Windows Server 2003 operating system
- Windows Vista operating system
- Windows Server 2008 operating system
- Windows 7 operating system
- Windows Server 2008 R2 operating system
- Windows 8 operating system
- Windows Server 2012 operating system
- Windows 8.1 operating system
- Windows Server 2012 R2 operating system
- Windows 10 operating system
- Windows Server 2016 operating system
- Windows Server operating system

▪ Windows Server 2019 operating system

Exceptions, if any, are noted in this section. If an update version, service pack or Knowledge Base (KB) number appears with a product name, the behavior changed in that update. The new behavior also applies to subsequent updates unless otherwise specified. If a product edition appears with the product version, behavior is different in that product edition.

Unless otherwise specified, any statement of optional behavior in this specification that is prescribed using the terms "SHOULD" or "SHOULD NOT" implies product behavior in accordance with the SHOULD or SHOULD NOT prescription. Unless otherwise specified, the term "MAY" implies that the product does not follow the prescription.

<1> Section 2.2.1.1: Windows sets the **dwReserved1** value to 0xCD64CD64.

<2> Section 2.2.3.1.8: The TXUSER_DTCLURMCONFIGURE_MTAG_ADD_LOG_FULL message is not supported in Windows 2000, Windows XP, Windows Server 2003, Windows Vista, and Windows Server 2008.

<3> Section 2.2.3.3.16: Windows limits the maximum number of enlistments per transaction to 64.

<4> Section 3.2.1: The **LU Transactions Enabled** flag is not supported in Windows 2000, Windows XP, Windows Server 2003, Windows Vista, and Windows Server 2008. Otherwise, in Windows, the DTCLU extension protocol is enabled by default.

<5> Section 3.3.2.1: Windows sets the value of the **LU Status Timer** to 30 seconds.

<6> Section 3.3.5.4.8: No applicable Windows releases perform any processing specified for the receipt of the

TXUSER_DTCLURECOVERYINITIATEDBYDTC_MTAG_ERROR_FROM_OUR_COMPARESTATES message. This message is processed as an invalid message, as specified in [MS-DTCO] section 3.1.6. Even though the state diagram CONNTYPE_TXUSER_DTCLURECOVERYINITIATEDBYDTC, Part 4 in section 3.3.1.5.21 shows the processing for receipt of this message, no versions of Windows perform this processing.

<7> Section 3.3.5.5.5: No applicable Windows releases perform any processing specified for the receipt of the TXUSER_DTCLURECOVERYINITIATEDBYLU_MTAG_ERROR_OF_OUR_COMPARESTATES message. This message is processed as an invalid message, as specified in [MS-DTCO] section 3.1.6. Even though the state diagram CONNTYPE_TXUSER_DTCLURECOVERYINITIATEDBYLU acceptor states in section 3.3.1.6.11 shows the processing for receipt of this message, no applicable Windows releases perform this processing.

<8> Section 5.1: A security level of No Authentication is used in Windows 2000 and Windows XP operating system Service Pack 1 (SP1). Otherwise, Mutual Authentication is used by default in applicable Windows releases.

<9> Section 5.1: The **LU Transactions Enabled** flag is not supported in Windows 2000, Windows XP, Windows Server 2003, Windows Vista, and Windows Server 2008. Otherwise, in Windows, the DTCLU extension protocol is enabled by default.

7 Change Tracking

This section identifies changes that were made to this document since the last release. Changes are classified as Major, Minor, or None.

The revision class **Major** means that the technical content in the document was significantly revised. Major changes affect protocol interoperability or implementation. Examples of major changes are:

- A document revision that incorporates changes to interoperability requirements.
- A document revision that captures changes to protocol functionality.

The revision class **Minor** means that the meaning of the technical content was clarified. Minor changes do not affect protocol interoperability or implementation. Examples of minor changes are updates to clarify ambiguity at the sentence, paragraph, or table level.

The revision class **None** means that no new technical changes were introduced. Minor editorial and formatting changes may have been made, but the relevant technical content is identical to the last released version.

The changes made to this document are listed in the following table. For more information, please contact dochelp@microsoft.com.

Section	Description	Revision class
6 Appendix A: Product Behavior	Added Windows Server 2019 to the list of applicable products.	Major

8 Index

A

Abstract data model
 LU 6.2 (section 3.1.1 61, section 3.2.1 62)
 transaction manager (section 3.1.1 61, section 3.3.1 104)
Applicability 23
Application connection types 30

C

Capability negotiation 23
Change tracking 197
Cold recovery for an LU Name Pair scenario 180
Completion 18
Connection types 30
CONNTYPE enumeration 29
CONNTYPE_TXUSER_DTCLUCONFIGURE 30
CONNTYPE_TXUSER_DTCLUCONFIGURE initiator states 63
CONNTYPE_TXUSER_DTCLURECOVERY 33
CONNTYPE_TXUSER_DTCLURECOVERY initiator states 65
CONNTYPE_TXUSER_DTCLURECOVERYINITIATEDBYDTC 44
CONNTYPE_TXUSER_DTCLURECOVERYINITIATEDBYDTC initiator states 70
CONNTYPE_TXUSER_DTCLURECOVERYINITIATEDBYLU 54
CONNTYPE_TXUSER_DTCLURECOVERYINITIATEDBYLU initiator states 75
CONNTYPE_TXUSER_DTCLURMENLISTMENT 35
CONNTYPE_TXUSER_DTCLURMENLISTMENT initiator states 67

D

Data model - abstract
 LU 6.2 (section 3.1.1 61, section 3.2.1 62)
 transaction manager (section 3.1.1 61, section 3.3.1 104)
DTCLU_VARLEN_BYTEARRAY packet 26
DTCLUCOMPARESTATE enumeration 26
DTCLUCOMPARESTATESCONFIRMATION enumeration 27
DTCLUCOMPARESTATESERROR enumeration 27
DTCLUCOMPARESTATESRESPONSE enumeration 28
DTCLUXLN enumeration 27
DTCLUXLNCONFIRMATION enumeration 27
DTCLUXLNERROR enumeration 28
DTCLUXLNRESPONSE enumeration 29

E

Enlistment 18
Enumerations 26
Examples
 enlisting in an OleTx transaction as an LU 6.2 implementation scenario 183
 LU Name Pair Configuration scenario 175
 overview 175
 performing cold recovery for an LU Name Pair scenario 180
 performing warm recovery for an LU Name Pair scenario 188
 registering as the recovery process for an LU Name Pair scenario 178

F

Fields - vendor-extensible 23

G

Glossary 13

H

Higher-layer triggered events

- LU 6.2 (section 3.1.5 62, section 3.2.4 78)
- transaction manager (section 3.1.5 62, section 3.3.4 125)

I

Implementation role - LU 6.2 22

Implementer - security considerations 194

Informative references 17

Initialization

- LU 6.2 (section 3.1.3 61, section 3.2.3 78)
- transaction manager (section 3.1.3 61, section 3.3.3 125)

Introduction 13

L

Local events

- LU 6.2 (section 3.1.8 62, section 3.2.7 104)
- transaction manager (section 3.1.8 62, section 3.3.7 161)

LU 6.2

- abstract data model (section 3.1.1 61, section 3.2.1 62)
- connection types relevant to 30
- higher-layer triggered events (section 3.1.5 62, section 3.2.4 78)
- implementation role 22
- initialization (section 3.1.3 61, section 3.2.3 78)
- local events (section 3.1.8 62, section 3.2.7 104)
- message processing (section 3.1.6 62, section 3.2.5 93)
- overview 61
- protocol version negotiation 61
- sequencing rules (section 3.1.6 62, section 3.2.5 93)
- timer events (section 3.1.7 62, section 3.2.6 104)
- timers (section 3.1.2 61, section 3.2.2 78)

LU Name Pair scenario

- configuration 175
- performing cold recovery for 180
- registering as the recovery process for 178
- warm recovery for 188

M

Message processing

- LU 6.2 (section 3.1.6 62, section 3.2.5 93)
- transaction manager (section 3.1.6 62, section 3.3.5 126)

MESSAGE_PACKET packet 25

Messages

- syntax 25
- transport 25

N

Normative references 16

O

OleTx transaction as an LU 6.2 implementation scenario - enlisting in an 183

Overview (synopsis) 17

P

Preconditions 23

Prerequisites 23

- Product behavior 195
- Protocol version negotiation
 - LU 6.2 61
 - transaction manager 61

R

- Recovery process for an LU Name Pair scenario - registering as the 178
- References 16
 - informative 17
 - normative 16
- Relationship to other protocols 22

S

- Scenarios 17
- Security
 - implementer considerations 194
- Security - implementer considerations 194
- Sequencing rules
 - LU 6.2 (section 3.1.6 62, section 3.2.5 93)
 - transaction manager (section 3.1.6 62, section 3.3.5 126)
- Standards assignments 24
- Structures - common 25
- Syntax 25

T

- Timer events
 - LU 6.2 (section 3.1.7 62, section 3.2.6 104)
 - transaction manager (section 3.1.7 62, section 3.3.6 161)
- Timers
 - LU 6.2 (section 3.1.2 61, section 3.2.2 78)
 - transaction manager (section 3.1.2 61, section 3.3.2 124)
- Tracking changes 197
- Transaction
 - enumerations 26
 - recovery 20
 - roles 21
- Transaction Manager
 - abstract data model (section 3.1.1 61, section 3.3.1 104)
 - higher-layer triggered events (section 3.1.5 62, section 3.3.4 125)
 - initialization (section 3.1.3 61, section 3.3.3 125)
 - local events (section 3.1.8 62, section 3.3.7 161)
 - message processing (section 3.1.6 62, section 3.3.5 126)
 - overview 61
 - protocol version negotiation 61
 - role 22
 - sequencing rules (section 3.1.6 62, section 3.3.5 126)
 - timer events (section 3.1.7 62, section 3.3.6 161)
 - timers (section 3.1.2 61, section 3.3.2 124)
- Transport 25
- Triggered events - higher-layer
 - LU 6.2 (section 3.1.5 62, section 3.2.4 78)
 - transaction manager (section 3.1.5 62, section 3.3.4 125)
- TXUSER_DTCLURECOVERYINITIATEDBYDTC_MTAG_CHECK_FOR_COMPARESTATES packet 50
- TXUSER_DTCLURECOVERYINITIATEDBYDTC_MTAG_COMPARESTATES_INFO packet 50
- TXUSER_DTCLURECOVERYINITIATEDBYDTC_MTAG_CONFIRMATION_FOR_THEIR_COMPARESTATES packet 52
- TXUSER_DTCLURECOVERYINITIATEDBYDTC_MTAG_CONFIRMATION_FOR_THEIR_XLN packet 49
- TXUSER_DTCLURECOVERYINITIATEDBYDTC_MTAG_CONFIRMATION_FROM_OUR_XLN packet 48
- TXUSER_DTCLURECOVERYINITIATEDBYDTC_MTAG_CONVERSATION_LOST packet 53
- TXUSER_DTCLURECOVERYINITIATEDBYDTC_MTAG_ERROR_FROM_OUR_COMPARESTATES packet 52
- TXUSER_DTCLURECOVERYINITIATEDBYDTC_MTAG_ERROR_FROM_OUR_XLN packet 50
- TXUSER_DTCLURECOVERYINITIATEDBYDTC_MTAG_GETWORK packet 45
- TXUSER_DTCLURECOVERYINITIATEDBYDTC_MTAG_GETWORK_NOT_FOUND packet 45

TXUSER_DTCLURECOVERYINITIATEDBYDTC_MTAG_LUSTATUS packet 47
TXUSER_DTCLURECOVERYINITIATEDBYDTC_MTAG_NEW_RECOVERY_SEQ_NUM packet 53
TXUSER_DTCLURECOVERYINITIATEDBYDTC_MTAG_NO_COMPARESTATES packet 51
TXUSER_DTCLURECOVERYINITIATEDBYDTC_MTAG_REQUESTCOMPLETE packet 47
TXUSER_DTCLURECOVERYINITIATEDBYDTC_MTAG_THEIR_COMPARESTATES packet 51
TXUSER_DTCLURECOVERYINITIATEDBYDTC_MTAG_THEIR_XLN_RESPONSE packet 48
TXUSER_DTCLURECOVERYINITIATEDBYDTC_MTAG_WORK_CHECKLUSTATUS packet 46
TXUSER_DTCLURECOVERYINITIATEDBYDTC_MTAG_WORK_TRANS packet 46
TXUSER_DTCLURECOVERYINITIATEDBYLU_MTAG_CONFIRMATION_OF_OUR_COMPARESTATES packet 58
TXUSER_DTCLURECOVERYINITIATEDBYLU_MTAG_CONFIRMATION_OF_OUR_XLN packet 56
TXUSER_DTCLURECOVERYINITIATEDBYLU_MTAG_CONVERSATION_LOST packet 59
TXUSER_DTCLURECOVERYINITIATEDBYLU_MTAG_ERROR_OF_OUR_COMPARESTATES packet 58
TXUSER_DTCLURECOVERYINITIATEDBYLU_MTAG_REQUESTCOMPLETE packet 59
TXUSER_DTCLURECOVERYINITIATEDBYLU_MTAG_RESPONSE_FOR_THEIR_COMPARESTATES packet 57
TXUSER_DTCLURECOVERYINITIATEDBYLU_MTAG_RESPONSE_FOR_THEIR_XLN packet 55
TXUSER_DTCLURECOVERYINITIATEDBYLU_MTAG_THEIR_COMPARESTATES packet 57
TXUSER_DTCLURECOVERYINITIATEDBYLU_MTAG_THEIR_XLN packet 54
TXUSER_DTCLURECOVERYINITIATEDBYLU_MTAG_THEIR_XLN_NOT_FOUND packet 60
TXUSER_DTCLURMCONFIGURE_MTAG_ADD packet 30
TXUSER_DTCLURMCONFIGURE_MTAG_ADD_DUPLICATE packet 31
TXUSER_DTCLURMCONFIGURE_MTAG_ADD_LOG_FULL packet 33
TXUSER_DTCLURMCONFIGURE_MTAG_DELETE packet 30
TXUSER_DTCLURMCONFIGURE_MTAG_DELETE_INUSE packet 32
TXUSER_DTCLURMCONFIGURE_MTAG_DELETE_NOT_FOUND packet 32
TXUSER_DTCLURMCONFIGURE_MTAG_DELETE_UNRECOVERED_TRANS packet 32
TXUSER_DTCLURMCONFIGURE_MTAG_REQUEST_COMPLETED packet 31
TXUSER_DTCLURMENLISTMENT_MTAG_CREATE packet 35
TXUSER_DTCLURMENLISTMENT_MTAG_CREATE_DUPLICATE_LU_TRANSID packet 42
TXUSER_DTCLURMENLISTMENT_MTAG_CREATE_LOG_FULL packet 41
TXUSER_DTCLURMENLISTMENT_MTAG_CREATE_LU_DOWN packet 43
TXUSER_DTCLURMENLISTMENT_MTAG_CREATE_LU_NO_RECOVERY_PROCESS packet 43
TXUSER_DTCLURMENLISTMENT_MTAG_CREATE_LU_NOT_FOUND packet 42
TXUSER_DTCLURMENLISTMENT_MTAG_CREATE_LU_RECOVERING packet 44
TXUSER_DTCLURMENLISTMENT_MTAG_CREATE_LU_RECOVERY_MISMATCH packet 44
TXUSER_DTCLURMENLISTMENT_MTAG_CREATE_TOO_LATE packet 40
TXUSER_DTCLURMENLISTMENT_MTAG_CREATE_TOO_MANY packet 41
TXUSER_DTCLURMENLISTMENT_MTAG_CREATE_TX_NOT_FOUND packet 40
TXUSER_DTCLURMENLISTMENT_MTAG_REQUEST_COMPLETED packet 36
TXUSER_DTCLURMENLISTMENT_MTAG_TO_DTC_BACKEDOUT packet 37
TXUSER_DTCLURMENLISTMENT_MTAG_TO_DTC_BACKOUT packet 37
TXUSER_DTCLURMENLISTMENT_MTAG_TO_DTC_COMMITTED packet 37
TXUSER_DTCLURMENLISTMENT_MTAG_TO_DTC_CONVERSATIONLOST packet 36
TXUSER_DTCLURMENLISTMENT_MTAG_TO_DTC_FORGET packet 38
TXUSER_DTCLURMENLISTMENT_MTAG_TO_DTC_REQUESTCOMMIT packet 38
TXUSER_DTCLURMENLISTMENT_MTAG_TO_LU_BACKEDOUT packet 39
TXUSER_DTCLURMENLISTMENT_MTAG_TO_LU_BACKOUT packet 39
TXUSER_DTCLURMENLISTMENT_MTAG_TO_LU_COMMITTED packet 39
TXUSER_DTCLURMENLISTMENT_MTAG_TO_LU_PREPARE packet 40
TXUSER_DTCLURMENLISTMENT_MTAG_UNPLUG packet 42
TXUSER_DTCLURMRECOVERY_MTAG_ATTACH packet 33
TXUSER_DTCLURMRECOVERY_MTAG_ATTACH_DUPLICATE packet 34
TXUSER_DTCLURMRECOVERY_MTAG_ATTACH_NOT_FOUND packet 35
TXUSER_DTCLURMRECOVERY_MTAG_REQUEST_COMPLETED packet 34

V

Vendor-extensible fields 23
Versioning 23

W

Warm recovery for an LU Name Pair scenario 188