

[MS-CIFS]: Common Internet File System (CIFS) Protocol

Intellectual Property Rights Notice for Open Specifications Documentation

- **Technical Documentation.** Microsoft publishes Open Specifications documentation for protocols, file formats, languages, standards as well as overviews of the interaction among each of these technologies.
- **Copyrights.** This documentation is covered by Microsoft copyrights. Regardless of any other terms that are contained in the terms of use for the Microsoft website that hosts this documentation, you may make copies of it in order to develop implementations of the technologies described in the Open Specifications and may distribute portions of it in your implementations using these technologies or your documentation as necessary to properly document the implementation. You may also distribute in your implementation, with or without modification, any schema, IDL's, or code samples that are included in the documentation. This permission also applies to any documents that are referenced in the Open Specifications.
- **No Trade Secrets.** Microsoft does not claim any trade secret rights in this documentation.
- **Patents.** Microsoft has patents that may cover your implementations of the technologies described in the Open Specifications. Neither this notice nor Microsoft's delivery of the documentation grants any licenses under those or any other Microsoft patents. However, a given Open Specification may be covered by Microsoft [Open Specification Promise](#) or the [Community Promise](#). If you would prefer a written license, or if the technologies described in the Open Specifications are not covered by the Open Specifications Promise or Community Promise, as applicable, patent licenses are available by contacting iplg@microsoft.com.
- **Trademarks.** The names of companies and products contained in this documentation may be covered by trademarks or similar intellectual property rights. This notice does not grant any licenses under those rights. For a list of Microsoft trademarks, visit www.microsoft.com/trademarks.
- **Fictitious Names.** The example companies, organizations, products, domain names, email addresses, logos, people, places, and events depicted in this documentation are fictitious. No association with any real company, organization, product, domain name, email address, logo, person, place, or event is intended or should be inferred.

Reservation of Rights. All other rights are reserved, and this notice does not grant any rights other than specifically described above, whether by implication, estoppel, or otherwise.

Tools. The Open Specifications do not require the use of Microsoft programming tools or programming environments in order for you to develop an implementation. If you have access to Microsoft programming tools and environments you are free to take advantage of them. Certain Open Specifications are intended for use in conjunction with publicly available standard specifications and network programming art, and assumes that the reader either is familiar with the aforementioned material or has immediate access to it.

Revision Summary

Date	Revision History	Revision Class	Comments
09/25/2009	1.0	Major	First Release.
11/06/2009	2.0	Major	Updated and revised the technical content.
12/18/2009	3.0	Major	Updated and revised the technical content.
01/29/2010	4.0	Major	Updated and revised the technical content.
03/12/2010	5.0	Major	Updated and revised the technical content.
04/23/2010	6.0	Major	Updated and revised the technical content.
06/04/2010	7.0	Major	Updated and revised the technical content.
07/16/2010	8.0	Major	Significantly changed the technical content.
08/27/2010	9.0	Major	Significantly changed the technical content.
10/08/2010	10.0	Major	Significantly changed the technical content.
11/19/2010	11.0	Major	Significantly changed the technical content.
01/07/2011	12.0	Major	Significantly changed the technical content.
02/11/2011	13.0	Major	Significantly changed the technical content.
03/25/2011	14.0	Major	Significantly changed the technical content.
05/06/2011	15.0	Major	Significantly changed the technical content.
06/17/2011	15.1	Minor	Clarified the meaning of the technical content.
09/23/2011	16.0	Major	Significantly changed the technical content.
12/16/2011	17.0	Major	Significantly changed the technical content.
03/30/2012	18.0	Major	Significantly changed the technical content.
07/12/2012	19.0	Major	Significantly changed the technical content.
10/25/2012	20.0	Major	Significantly changed the technical content.
01/31/2013	21.0	Major	Significantly changed the technical content.
08/08/2013	22.0	Major	Significantly changed the technical content.
11/14/2013	22.0	No change	No changes to the meaning, language, or formatting of the technical content.
02/13/2014	23.0	Major	Significantly changed the technical content.
05/15/2014	24.0	Major	Significantly changed the technical content.

Contents

1 Introduction	19
1.1 Glossary	19
1.2 References.....	22
1.2.1 Normative References.....	22
1.2.2 Informative References	23
1.3 Overview	26
1.4 Relationship to Other Protocols.....	28
1.5 Prerequisites/Preconditions	29
1.6 Applicability Statement.....	29
1.7 Versioning and Capability Negotiation.....	30
1.8 Vendor-Extensible Fields.....	32
1.9 Standards Assignments	32
2 Messages	33
2.1 Transport.....	33
2.1.1 NetBIOS-Based Transports	33
2.1.1.1 NetBIOS Frames (NBF) Protocol Transport	33
2.1.1.2 NetBIOS over TCP/UDP (NBT) Transport.....	34
2.1.1.3 NetBIOS over IPX/SPX (NBIPX) Transport.....	34
2.1.1.4 Other NetBIOS-Based Transports.....	34
2.1.2 Direct Hosting.....	34
2.1.2.1 Direct IPX Transport	34
2.1.3 Virtual Circuits	38
2.2 Message Syntax	38
2.2.1 Common Data Types	40
2.2.1.1 Character Sequences	41
2.2.1.1.1 File and Directory names.....	41
2.2.1.1.2 Pathnames	42
2.2.1.1.3 Wildcards.....	42
2.2.1.2 File Attributes	43
2.2.1.2.1 SMB_GEA.....	43
2.2.1.2.1.1 SMB_GEA_LIST	43
2.2.1.2.2 SMB_FEA	44
2.2.1.2.2.1 SMB_FEA_LIST.....	45
2.2.1.2.3 SMB_EXT_FILE_ATTR	46
2.2.1.2.4 SMB_FILE_ATTRIBUTES	47
2.2.1.3 Named Pipe Status (SMB_NMPIPE_STATUS)	48
2.2.1.4 Time	49
2.2.1.4.1 SMB_DATE	49
2.2.1.4.2 SMB_TIME.....	50
2.2.1.4.3 UTIME	50
2.2.1.5 Status Codes (SMB_ERROR)	50
2.2.1.6 Unique Identifiers	51
2.2.1.6.1 FID Generation	52
2.2.1.6.2 MID Generation	52
2.2.1.6.3 PID Generation	52
2.2.1.6.4 Connection ID (CID) Generation.....	53
2.2.1.6.5 Search ID (SID) Generation.....	53
2.2.1.6.6 SessionKey Generation	53
2.2.1.6.7 TID Generation	54

2.2.1.6.8	UID Generation	54
2.2.2	Defined Constants	54
2.2.2.1	SMB_COM Command Codes	54
2.2.2.2	Transaction Subcommand Codes	61
2.2.2.3	Information Level Codes	64
2.2.2.3.1	FIND Information Level Codes	64
2.2.2.3.2	QUERY_FS Information Level Codes.....	65
2.2.2.3.3	QUERY Information Level Codes.....	66
2.2.2.3.4	SET Information Level Codes	67
2.2.2.4	SMB Error Classes and Codes	67
2.2.2.5	Data Buffer Format Codes.....	79
2.2.3	SMB Message Structure	80
2.2.3.1	The SMB Header.....	80
2.2.3.2	Parameter Block	86
2.2.3.3	Data Block.....	87
2.2.3.4	Batched Messages ("AndX" Messages).....	87
2.2.3.4.1	Follow-on Commands	88
2.2.4	SMB Commands.....	88
2.2.4.1	SMB_COM_CREATE_DIRECTORY (0x00)	88
2.2.4.1.1	Request	88
2.2.4.1.2	Response	89
2.2.4.2	SMB_COM_DELETE_DIRECTORY (0x01)	91
2.2.4.2.1	Request	91
2.2.4.2.2	Response	92
2.2.4.3	SMB_COM_OPEN (0x02).....	94
2.2.4.3.1	Request	94
2.2.4.3.2	Response	97
2.2.4.4	SMB_COM_CREATE (0x03)	100
2.2.4.4.1	Request	101
2.2.4.4.2	Response	102
2.2.4.5	SMB_COM_CLOSE (0x04)	105
2.2.4.5.1	Request	106
2.2.4.5.2	Response	107
2.2.4.6	SMB_COM_FLUSH (0x05)	108
2.2.4.6.1	Request	108
2.2.4.6.2	Response	109
2.2.4.7	SMB_COM_DELETE (0x06).....	111
2.2.4.7.1	Request	111
2.2.4.7.2	Response	113
2.2.4.8	SMB_COM_RENAME (0x07).....	114
2.2.4.8.1	Request	114
2.2.4.8.2	Response	116
2.2.4.9	SMB_COM_QUERY_INFORMATION (0x08).....	118
2.2.4.9.1	Request	119
2.2.4.9.2	Response	120
2.2.4.10	SMB_COM_SET_INFORMATION (0x09)	122
2.2.4.10.1	Request	123
2.2.4.10.2	Response	125
2.2.4.11	SMB_COM_READ (0x0A).....	127
2.2.4.11.1	Request	127
2.2.4.11.2	Response	129
2.2.4.12	SMB_COM_WRITE (0x0B)	132
2.2.4.12.1	Request	133

2.2.4.12.2	Response	135
2.2.4.13	SMB_COM_LOCK_BYTE_RANGE (0x0C)	138
2.2.4.13.1	Request	139
2.2.4.13.2	Response	140
2.2.4.14	SMB_COM_UNLOCK_BYTE_RANGE (0x0D)	142
2.2.4.14.1	Request	142
2.2.4.14.2	Response	144
2.2.4.15	SMB_COM_CREATE_TEMPORARY (0x0E)	146
2.2.4.15.1	Request	146
2.2.4.15.2	Response	148
2.2.4.16	SMB_COM_CREATE_NEW (0x0F)	151
2.2.4.16.1	Request	151
2.2.4.16.2	Response	153
2.2.4.17	SMB_COM_CHECK_DIRECTORY (0x10)	155
2.2.4.17.1	Request	156
2.2.4.17.2	Response	157
2.2.4.18	SMB_COM_PROCESS_EXIT (0x11)	158
2.2.4.18.1	Request	158
2.2.4.18.2	Response	159
2.2.4.19	SMB_COM_SEEK (0x12)	160
2.2.4.19.1	Request	161
2.2.4.19.2	Response	162
2.2.4.20	SMB_COM_LOCK_AND_READ (0x13)	164
2.2.4.20.1	Request	165
2.2.4.20.2	Response	166
2.2.4.21	SMB_COM_WRITE_AND_UNLOCK (0x14)	170
2.2.4.21.1	Request	171
2.2.4.21.2	Response	173
2.2.4.22	SMB_COM_READ_RAW (0x1A)	176
2.2.4.22.1	Request	176
2.2.4.22.2	Response	178
2.2.4.23	SMB_COM_READ_MPX (0x1B)	179
2.2.4.23.1	Request	179
2.2.4.23.2	Response	181
2.2.4.24	SMB_COM_READ_MPX_SECONDARY (0x1C)	185
2.2.4.25	SMB_COM_WRITE_RAW (0x1D)	185
2.2.4.25.1	Request	186
2.2.4.25.2	Interim Server Response	189
2.2.4.25.3	Final Server Response	190
2.2.4.26	SMB_COM_WRITE_MPX (0x1E)	193
2.2.4.26.1	Request	194
2.2.4.26.2	Response	197
2.2.4.27	SMB_COM_WRITE_MPX_SECONDARY (0x1F)	200
2.2.4.28	SMB_COM_WRITE_COMPLETE (0x20)	201
2.2.4.29	SMB_COM_QUERY_SERVER (0x21)	201
2.2.4.30	SMB_COM_SET_INFORMATION2 (0x22)	201
2.2.4.30.1	Request	201
2.2.4.30.2	Response	203
2.2.4.31	SMB_COM_QUERY_INFORMATION2 (0x23)	204
2.2.4.31.1	Request	205
2.2.4.31.2	Response	206
2.2.4.32	SMB_COM_LOCKING_ANDX (0x24)	208
2.2.4.32.1	Request	209

2.2.4.32.2	Response	214
2.2.4.33	SMB_COM_TRANSACTION (0x25)	217
2.2.4.33.1	Request	217
2.2.4.33.2	Response	223
2.2.4.34	SMB_COM_TRANSACTION_SECONDARY (0x26)	227
2.2.4.34.1	Request	228
2.2.4.34.2	Response	231
2.2.4.35	SMB_COM_IOCTL (0x27)	231
2.2.4.35.1	Request	231
2.2.4.35.2	Response	235
2.2.4.36	SMB_COM_IOCTL_SECONDARY (0x28)	239
2.2.4.37	SMB_COM_COPY (0x29)	239
2.2.4.38	SMB_COM_MOVE (0x2A)	240
2.2.4.39	SMB_COM_ECHO (0x2B)	240
2.2.4.39.1	Request	240
2.2.4.39.2	Response	241
2.2.4.40	SMB_COM_WRITE_AND_CLOSE (0x2C)	243
2.2.4.40.1	Request	243
2.2.4.40.2	Response	245
2.2.4.41	SMB_COM_OPEN_ANDX (0x2D)	249
2.2.4.41.1	Request	249
2.2.4.41.2	Response	254
2.2.4.42	SMB_COM_READ_ANDX (0x2E)	259
2.2.4.42.1	Request	260
2.2.4.42.2	Response	262
2.2.4.43	SMB_COM_WRITE_ANDX (0x2F)	267
2.2.4.43.1	Request	267
2.2.4.43.2	Response	271
2.2.4.44	SMB_COM_NEW_FILE_SIZE (0x30)	276
2.2.4.45	SMB_COM_CLOSE_AND_TREE_DISC (0x31)	276
2.2.4.46	SMB_COM_TRANSACTION2 (0x32)	276
2.2.4.46.1	Request	276
2.2.4.46.2	Response	281
2.2.4.47	SMB_COM_TRANSACTION2_SECONDARY (0x33)	285
2.2.4.47.1	Request	285
2.2.4.47.2	Response	289
2.2.4.48	SMB_COM_FIND_CLOSE2 (0x34)	289
2.2.4.48.1	Request	289
2.2.4.48.2	Response	290
2.2.4.49	SMB_COM_FIND_NOTIFY_CLOSE (0x35)	291
2.2.4.50	SMB_COM_TREE_CONNECT (0x70)	291
2.2.4.50.1	Request	292
2.2.4.50.2	Response	294
2.2.4.51	SMB_COM_TREE_DISCONNECT (0x71)	296
2.2.4.51.1	Request	296
2.2.4.51.2	Response	297
2.2.4.52	SMB_COM_NEGOTIATE (0x72)	298
2.2.4.52.1	Request	298
2.2.4.52.2	Response	300
2.2.4.53	SMB_COM_SESSION_SETUP_ANDX (0x73)	307
2.2.4.53.1	Request	308
2.2.4.53.2	Response	313
2.2.4.54	SMB_COM_LOGOFF_ANDX (0x74)	317

2.2.4.54.1	Request	317
2.2.4.54.2	Response	318
2.2.4.55	SMB_COM_TREE_CONNECT_ANDX (0x75)	319
2.2.4.55.1	Request	320
2.2.4.55.2	Response	324
2.2.4.56	SMB_COM_SECURITY_PACKAGE_ANDX (0x7E)	327
2.2.4.57	SMB_COM_QUERY_INFORMATION_DISK (0x80)	327
2.2.4.57.1	Request	328
2.2.4.57.2	Response	329
2.2.4.58	SMB_COM_SEARCH (0x81)	331
2.2.4.58.1	Request	331
2.2.4.58.2	Response	334
2.2.4.59	SMB_COM_FIND (0x82)	338
2.2.4.59.1	Request	338
2.2.4.59.2	Response	341
2.2.4.60	SMB_COM_FIND_UNIQUE (0x83)	345
2.2.4.60.1	Request	345
2.2.4.60.2	Response	347
2.2.4.61	SMB_COM_FIND_CLOSE (0x84)	351
2.2.4.61.1	Request	351
2.2.4.61.2	Response	354
2.2.4.62	SMB_COM_NT_TRANSACT (0xA0)	356
2.2.4.62.1	Request	357
2.2.4.62.2	Response	361
2.2.4.63	SMB_COM_NT_TRANSACT_SECONDARY (0xA1)	365
2.2.4.63.1	Request	365
2.2.4.63.2	Response	370
2.2.4.64	SMB_COM_NT_CREATE_ANDX (0xA2)	370
2.2.4.64.1	Request	370
2.2.4.64.2	Response	379
2.2.4.65	SMB_COM_NT_CANCEL (0xA4)	385
2.2.4.65.1	Request	385
2.2.4.66	SMB_COM_NT_RENAME (0xA5)	387
2.2.4.66.1	Request	387
2.2.4.66.2	Response	388
2.2.4.67	SMB_COM_OPEN_PRINT_FILE (0xC0)	390
2.2.4.67.1	Request	390
2.2.4.67.2	Response	392
2.2.4.68	SMB_COM_WRITE_PRINT_FILE (0xC1)	394
2.2.4.68.1	Request	395
2.2.4.68.2	Response	396
2.2.4.69	SMB_COM_CLOSE_PRINT_FILE (0xC2)	398
2.2.4.69.1	Request	398
2.2.4.69.2	Response	399
2.2.4.70	SMB_COM_GET_PRINT_QUEUE (0xC3)	400
2.2.4.71	SMB_COM_READ_BULK (0xD8)	400
2.2.4.72	SMB_COM_WRITE_BULK (0xD9)	400
2.2.4.73	SMB_COM_WRITE_BULK_DATA (0xDA)	401
2.2.4.74	SMB_COM_INVALID (0xFE)	401
2.2.4.75	SMB_COM_NO_ANDX_COMMAND (0xFF)	401
2.2.5	Transaction Subcommands	401
2.2.5.1	TRANS_SET_NMPIPE_STATE (0x0001)	401
2.2.5.1.1	Request	402

2.2.5.1.2	Response	403
2.2.5.2	TRANS_RAW_READ_NMPIPE (0x0011)	404
2.2.5.2.1	Request	404
2.2.5.2.2	Response	405
2.2.5.3	TRANS_QUERY_NMPIPE_STATE (0x0021)	407
2.2.5.3.1	Request	407
2.2.5.3.2	Response	408
2.2.5.4	TRANS_QUERY_NMPIPE_INFO (0x0022)	409
2.2.5.4.1	Request	410
2.2.5.4.2	Response	411
2.2.5.5	TRANS_PEEK_NMPIPE (0x0023)	413
2.2.5.5.1	Request	413
2.2.5.5.2	Response	414
2.2.5.6	TRANS_TRANSACT_NMPIPE (0x0026)	417
2.2.5.6.1	Request	417
2.2.5.6.2	Response	418
2.2.5.7	TRANS_RAW_WRITE_NMPIPE (0x0031)	420
2.2.5.7.1	Request	420
2.2.5.7.2	Response	421
2.2.5.8	TRANS_READ_NMPIPE (0x0036)	423
2.2.5.8.1	Request	423
2.2.5.8.2	Response	424
2.2.5.9	TRANS_WRITE_NMPIPE (0x0037)	426
2.2.5.9.1	Request	426
2.2.5.9.2	Response	427
2.2.5.10	TRANS_WAIT_NMPIPE (0x0053)	428
2.2.5.10.1	Request	428
2.2.5.10.2	Response	429
2.2.5.11	TRANS_CALL_NMPIPE (0x0054)	430
2.2.5.11.1	Request	430
2.2.5.11.2	Response	432
2.2.5.12	TRANS_MAILSLLOT_WRITE (0x0001)	434
2.2.6	Transaction2 Subcommands	434
2.2.6.1	TRANS2_OPEN2 (0x0000)	434
2.2.6.1.1	Request	434
2.2.6.1.2	Response	437
2.2.6.2	TRANS2_FIND_FIRST2 (0x0001)	441
2.2.6.2.1	Request	441
2.2.6.2.2	Response	443
2.2.6.3	TRANS2_FIND_NEXT2 (0x0002)	445
2.2.6.3.1	Request	445
2.2.6.3.2	Response	448
2.2.6.4	TRANS2_QUERY_FS_INFORMATION (0x0003)	450
2.2.6.4.1	Request	450
2.2.6.4.2	Response	450
2.2.6.5	TRANS2_SET_FS_INFORMATION (0x0004)	451
2.2.6.6	TRANS2_QUERY_PATH_INFORMATION (0x0005)	452
2.2.6.6.1	Request	452
2.2.6.6.2	Response	453
2.2.6.7	TRANS2_SET_PATH_INFORMATION (0x0006)	455
2.2.6.7.1	Request	455
2.2.6.7.2	Response	456
2.2.6.8	TRANS2_QUERY_FILE_INFORMATION (0x0007)	457

2.2.6.8.1	Request	458
2.2.6.8.2	Response	459
2.2.6.9	TRANS2_SET_FILE_INFORMATION (0x0008).....	461
2.2.6.9.1	Request	461
2.2.6.9.2	Response	462
2.2.6.10	TRANS2_FSCTL (0x0009)	464
2.2.6.11	TRANS2_IOCTL2 (0x000A).....	464
2.2.6.12	TRANS2_FIND_NOTIFY_FIRST (0x000B).....	464
2.2.6.13	TRANS2_FIND_NOTIFY_NEXT (0x000C).....	464
2.2.6.14	TRANS2_CREATE_DIRECTORY (0x000D).....	464
2.2.6.14.1	Request	464
2.2.6.14.2	Response	465
2.2.6.15	TRANS2_SESSION_SETUP (0x000E)	467
2.2.6.16	TRANS2_GET_DFS_REFERRAL (0x0010)	468
2.2.6.16.1	Request	468
2.2.6.16.2	Response	468
2.2.6.17	TRANS2_REPORT_DFS_INCONSISTENCY (0x0011)	469
2.2.7	NT Transact Subcommands	469
2.2.7.1	NT_TRANSACT_CREATE (0x0001).....	469
2.2.7.1.1	Request	469
2.2.7.1.2	Response	477
2.2.7.2	NT_TRANSACT_IOCTL (0x0002)	483
2.2.7.2.1	Request	483
2.2.7.2.2	Response	484
2.2.7.3	NT_TRANSACT_SET_SECURITY_DESC (0x0003).....	486
2.2.7.3.1	Request	486
2.2.7.3.2	Response	488
2.2.7.4	NT_TRANSACT_NOTIFY_CHANGE (0x0004)	489
2.2.7.4.1	Request	489
2.2.7.4.2	Response	491
2.2.7.5	NT_TRANSACT_RENAME (0x0005).....	492
2.2.7.6	NT_TRANSACT_QUERY_SECURITY_DESC (0x0006).....	492
2.2.7.6.1	Request	493
2.2.7.6.2	Response	494
2.2.8	Information Levels	496
2.2.8.1	FIND Information Levels.....	497
2.2.8.1.1	SMB_INFO_STANDARD	497
2.2.8.1.2	SMB_INFO_QUERY_EA_SIZE	498
2.2.8.1.3	SMB_INFO_QUERY_EAS_FROM_LIST	499
2.2.8.1.4	SMB_FIND_FILE_DIRECTORY_INFO	500
2.2.8.1.5	SMB_FIND_FILE_FULL_DIRECTORY_INFO	501
2.2.8.1.6	SMB_FIND_FILE_NAMES_INFO	502
2.2.8.1.7	SMB_FIND_FILE_BOTH_DIRECTORY_INFO	503
2.2.8.2	QUERY_FS Information Levels.....	504
2.2.8.2.1	SMB_INFO_ALLOCATION.....	504
2.2.8.2.2	SMB_INFO_VOLUME	505
2.2.8.2.3	SMB_QUERY_FS_VOLUME_INFO	505
2.2.8.2.4	SMB_QUERY_FS_SIZE_INFO	505
2.2.8.2.5	SMB_QUERY_FS_DEVICE_INFO	506
2.2.8.2.6	SMB_QUERY_FS_ATTRIBUTE_INFO	508
2.2.8.3	QUERY Information Levels	509
2.2.8.3.1	SMB_INFO_STANDARD	509
2.2.8.3.2	SMB_INFO_QUERY_EA_SIZE	509

2.2.8.3.3	SMB_INFO_QUERY_EAS_FROM_LIST	510
2.2.8.3.4	SMB_INFO_QUERY_ALL_EAS	510
2.2.8.3.5	SMB_INFO_IS_NAME_VALID	511
2.2.8.3.6	SMB_QUERY_FILE_BASIC_INFO	511
2.2.8.3.7	SMB_QUERY_FILE_STANDARD_INFO	512
2.2.8.3.8	SMB_QUERY_FILE_EA_INFO	512
2.2.8.3.9	SMB_QUERY_FILE_NAME_INFO	512
2.2.8.3.10	SMB_QUERY_FILE_ALL_INFO	513
2.2.8.3.11	SMB_QUERY_FILE_ALT_NAME_INFO	514
2.2.8.3.12	SMB_QUERY_FILE_STREAM_INFO	514
2.2.8.3.13	SMB_QUERY_FILE_COMPRESSION_INFO	515
2.2.8.4	SET Information levels	516
2.2.8.4.1	SMB_INFO_STANDARD	516
2.2.8.4.2	SMB_INFO_SET_EAS	517
2.2.8.4.3	SMB_SET_FILE_BASIC_INFO	517
2.2.8.4.4	SMB_SET_FILE_DISPOSITION_INFO	518
2.2.8.4.5	SMB_SET_FILE_ALLOCATION_INFO	518
2.2.8.4.6	SMB_SET_FILE_END_OF_FILE_INFO	519
3	Protocol Details	520
3.1	Common Details	520
3.1.1	Abstract Data Model	520
3.1.1.1	Global	520
3.1.2	Timers	520
3.1.3	Initialization	520
3.1.4	Higher-Layer Triggered Events	520
3.1.4.1	Sending Any Message	520
3.1.4.1.1	Command Sequence Requirements	521
3.1.5	Processing Events and Sequencing Rules	522
3.1.5.1	Receiving Any Message	522
3.1.5.2	Algorithms for Challenge/Response Authentication	522
3.1.6	Timer Events	523
3.1.7	Other Local Events	523
3.2	Client Details	523
3.2.1	Abstract Data Model	523
3.2.1.1	Global	523
3.2.1.2	Per SMB Connection	525
3.2.1.3	Per SMB Session	527
3.2.1.4	Per Tree Connect	527
3.2.1.5	Per Unique Open	528
3.2.1.6	Per Unique Open Search	528
3.2.2	Timers	528
3.2.2.1	Request Expiration Timer	528
3.2.3	Initialization	528
3.2.4	Higher-Layer Triggered Events	530
3.2.4.1	Sending Any Message	530
3.2.4.1.1	Command Processing	531
3.2.4.1.2	Processing Options	531
3.2.4.1.3	Message Signing	531
3.2.4.1.4	Sending Any Batched ("AndX") Request	532
3.2.4.1.5	Sending Any Transaction	533
3.2.4.1.6	Accessing a Share in the DFS Namespace	536
3.2.4.2	Application Requests Connecting to a Share	537

3.2.4.2.1	Connection Establishment	538
3.2.4.2.2	Dialect Negotiation	539
3.2.4.2.3	Capabilities Negotiation.....	540
3.2.4.2.4	User Authentication	540
3.2.4.2.5	Connecting to the Share (Tree Connect)	542
3.2.4.3	Application Requests Creating a Directory	543
3.2.4.4	Application Requests Deleting a Directory	543
3.2.4.5	Application Requests Opening an Existing File	544
3.2.4.5.1	Compatibility Mode.....	546
3.2.4.5.2	FID Permissions	547
3.2.4.6	Application Requests to Create or Overwrite a File	547
3.2.4.7	Application Requests Closing a File	550
3.2.4.8	Application Requests Flushing File Data	550
3.2.4.9	Application Requests Deleting a File or Set of Files.....	550
3.2.4.10	Application Requests Renaming a File or Set of Files.....	551
3.2.4.11	Application Requests Creating a Hard Link to a File	552
3.2.4.12	Application Requests Querying File Attributes	552
3.2.4.13	Application Requests Setting File Attributes	554
3.2.4.14	Application Requests Reading from a File, Named Pipe, or Device	556
3.2.4.14.1	Client Requests Read Raw	558
3.2.4.14.2	Client Requests Multiplexed Read	559
3.2.4.15	Application Requests Writing to a File, Named Pipe, or Device	560
3.2.4.15.1	Client Requests Raw Write	562
3.2.4.15.2	Client Requests Multiplexed Write.....	563
3.2.4.16	Application Requests a Byte-Range Lock on a File	566
3.2.4.17	Application Requests the Release of a Byte-Range Lock on a File	567
3.2.4.18	Application Requests an Opportunistic Lock on a File	568
3.2.4.19	Application Requests Verifying a Directory Path	568
3.2.4.20	Client Notifies the Server of a Process Exit	569
3.2.4.21	Application Requests to Seek to a Location in a File.....	569
3.2.4.22	Application Requests Sending an IOCTL to a File or Device.....	569
3.2.4.23	Application Requests Testing Transport Layer Connection	570
3.2.4.24	Application Requests a Tree Disconnect (Unmount Share).....	570
3.2.4.25	Application Requests an SMB Session Logoff	570
3.2.4.26	Application Requests Querying File System Attributes.....	570
3.2.4.27	Application Requests a Directory Enumeration	571
3.2.4.28	Application Requests Canceling Pending Operations.....	572
3.2.4.29	Application Requests to Print a File.....	573
3.2.4.30	Application Requests Setting Named Pipe State	573
3.2.4.31	Application Requests Querying Named Pipe Handle State	573
3.2.4.32	Application Requests Querying Named Pipe Information.....	574
3.2.4.33	Application Requests Peeking at Named Pipe Data	574
3.2.4.34	Application Requests Executing a Transaction on a Named Pipe	574
3.2.4.35	Application Requests Waiting for Named Pipe Availability	574
3.2.4.36	Application Requests Named Pipe Exchange (Call).....	575
3.2.4.37	Application Requests to Read from a Named Pipe.....	575
3.2.4.38	Application Requests Writing to a Named Pipe	575
3.2.4.39	Application Requests Notification of Change in Directory Contents.....	576
3.2.4.40	Application Requests Querying Security Descriptors	576
3.2.4.41	Application Requests Setting Security Descriptors	576
3.2.4.42	Application Requests a Named RAP Transaction	577
3.2.4.43	DFS Subsystem Notifies That It Is Active	577
3.2.4.44	Application Requests Querying DFS Referrals	577

3.2.4.45	Application Requests Querying Cryptographic Session Key	577
3.2.4.46	Application Requests Number of Opens on a Tree Connect	578
3.2.5	Processing Events and Sequencing Rules.....	578
3.2.5.1	Receiving Any Message	578
3.2.5.1.1	Command Processing.....	579
3.2.5.1.2	Message Signing	579
3.2.5.1.3	Receiving any Batched ("AndX") Response	579
3.2.5.1.4	Receiving Any Transaction Response	580
3.2.5.2	Receiving an SMB_COM_NEGOTIATE Response	580
3.2.5.3	Receiving an SMB_COM_SESSION_SETUP_ANDX Response	581
3.2.5.4	Receiving an SMB_COM_TREE_CONNECT or SMB_COM_TREE_CONNECT_ANDX Response	582
3.2.5.5	Receiving an SMB_COM_OPEN Response	583
3.2.5.6	Receiving an SMB_COM_CREATE Response	583
3.2.5.7	Receiving an SMB_COM_CLOSE Response	583
3.2.5.8	Receiving an SMB_COM_QUERY_INFORMATION Response	584
3.2.5.9	Receiving an SMB_COM_READ Response	584
3.2.5.10	Receiving an SMB_COM_WRITE Response.....	584
3.2.5.11	Receiving an SMB_COM_CREATE_TEMPORARY Response	584
3.2.5.12	Receiving an SMB_COM_CREATE_NEW Response.....	584
3.2.5.13	Receiving an SMB_COM_SEEK Response.....	585
3.2.5.14	Receiving an SMB_COM_LOCK_AND_READ Response	585
3.2.5.15	Receiving an SMB_COM_WRITE_AND_UNLOCK Response	585
3.2.5.16	Receiving an SMB_COM_READ_RAW Response	585
3.2.5.17	Receiving an SMB_COM_READ_MPX Response.....	586
3.2.5.18	Receiving an SMB_COM_WRITE_RAW Response	586
3.2.5.19	Receiving an SMB_COM_WRITE_MPX Response	587
3.2.5.20	Receiving an SMB_COM_QUERY_INFORMATION2 Response.....	587
3.2.5.21	Receiving an SMB_COM_TRANSACTION Response.....	588
3.2.5.22	Receiving an SMB_COM_IOCTL Response	588
3.2.5.23	Receiving an SMB_COM_ECHO Response	588
3.2.5.24	Receiving an SMB_COM_WRITE_AND_CLOSE Response.....	588
3.2.5.25	Receiving an SMB_COM_OPEN_ANDX Response.....	588
3.2.5.26	Receiving an SMB_COM_READ_ANDX Response.....	589
3.2.5.27	Receiving an SMB_COM_WRITE_ANDX Response	589
3.2.5.28	Receiving an SMB_COM_TRANSACTION2 Response	589
3.2.5.29	Receiving an SMB_COM_FIND_CLOSE2 Response	589
3.2.5.30	Receiving an SMB_COM_TREE_DISCONNECT Response	590
3.2.5.31	Receiving an SMB_COM_LOGOFF_ANDX Response	590
3.2.5.32	Receiving an SMB_COM_QUERY_INFORMATION_DISK Response	590
3.2.5.33	Receiving an SMB_COM_SEARCH or SMB_COM_FIND Response.....	590
3.2.5.34	Receiving an SMB_COM_FIND_UNIQUE Response	590
3.2.5.35	Receiving an SMB_COM_NT_TRANSACT Response	591
3.2.5.36	Receiving an SMB_COM_NT_CREATE_ANDX Response.....	591
3.2.5.37	Receiving an SMB_COM_OPEN_PRINT_FILE Response	591
3.2.5.38	Receiving any SMB_COM_TRANSACTION Subcommand Response.....	591
3.2.5.38.1	Receiving a RAP Transaction Response.....	592
3.2.5.38.2	Receiving a TRANS_RAW_READ_NMPIPE Response.....	592
3.2.5.38.3	Receiving a TRANS_QUERY_NMPIPE_STATE Response	592
3.2.5.38.4	Receiving a TRANS_QUERY_NMPIPE_INFO Response	592
3.2.5.38.5	Receiving a TRANS_PEEK_NMPIPE Response.....	592
3.2.5.38.6	Receiving a TRANS_TRASACT_NMPIPE Response.....	592
3.2.5.38.7	Receiving a TRANS_RAW_WRITE_NMPIPE Response	593

3.2.5.38.8	Receiving a TRANS_READ_NMPIPE Response	593
3.2.5.38.9	Receiving a TRANS_WRITE_NMPIPE Response	593
3.2.5.38.10	Receiving a TRANS_CALL_NMPIPE Response	593
3.2.5.39	Receiving any SMB_COM_TRANSACTION2 Subcommand Response	593
3.2.5.39.1	Receiving a TRANS2_OPEN2 Response	593
3.2.5.39.2	Receiving a TRANS2_FIND_FIRST2 or TRANS2_FIND_NEXT2 Response	594
3.2.5.39.3	Receiving a TRANS2_QUERY_FS_INFORMATION Response	594
3.2.5.39.4	Receiving a TRANS2_QUERY_PATH_INFORMATION or TRANS2_QUERY_FILE_INFORMATION Response	594
3.2.5.39.5	Receiving a TRANS2_CREATE_DIRECTORY Response	594
3.2.5.39.6	Receiving a TRANS2_GET_DFS_REFERRAL Response	595
3.2.5.40	Receiving any SMB_COM_NT_TRANSACT Subcommand Response	595
3.2.5.40.1	Receiving an NT_TRANSACT_CREATE Response	595
3.2.5.40.2	Receiving an NT_TRANSACT_IOCTL Response	595
3.2.5.40.3	Receiving an NT_TRANSACT_NOTIFY_CHANGE Response	595
3.2.5.40.4	Receiving an NT_TRANSACT_QUERY_SECURITY_DESC Response	596
3.2.5.41	Receiving any OpLock Grant	596
3.2.5.42	Receiving an OpLock Break Notification	596
3.2.5.43	Receiving a STATUS_PATH_NOT_COVERED (ERRSRV/ERRbadpath) Error for an Object in DFS	597
3.2.6	Timer Events	597
3.2.6.1	Request Expiration Timer Event	597
3.2.7	Other Local Events	598
3.2.7.1	Handling a Transport Disconnect	598
3.3	Server Details	598
3.3.1	Abstract Data Model	598
3.3.1.1	Global	598
3.3.1.2	Per Share	601
3.3.1.3	Per SMB Connection	601
3.3.1.4	Per Pending SMB Command	604
3.3.1.5	Per SMB Session	604
3.3.1.6	Per Tree Connect	605
3.3.1.7	Per Unique Open	605
3.3.1.8	Per Unique Open Search	606
3.3.2	Timers	606
3.3.2.1	OpLock Break Acknowledgment Timer	606
3.3.2.2	Idle Connection Timer	606
3.3.2.3	Unused Open Search Timer	607
3.3.2.4	Unused Connection Timer	607
3.3.3	Initialization	607
3.3.4	Higher-Layer Triggered Events	608
3.3.4.1	Sending Any Message	608
3.3.4.1.1	Processing Options	608
3.3.4.1.2	Sending Any Error Response Message	609
3.3.4.2	Object Store Indicates an OpLock Break	609
3.3.4.3	DFS Subsystem Notifies That It Is Active	610
3.3.4.4	DFS Subsystem Notifies That a Share Is a DFS Share	610
3.3.4.5	DFS Subsystem Notifies That a Share Is Not a DFS Share	610
3.3.4.6	Application Requests the Session Key Associated with a Client Session	610
3.3.4.7	Application Requests the Security Context Associated with a Client Session	610
3.3.4.8	Server Application Requests Closing a Session	611
3.3.4.9	Server Application Registers a Share	611
3.3.4.10	Server Application Updates a Share	612

3.3.4.11	Server Application Deregisters a Share	612
3.3.4.12	Server Application Requests Querying a Share.....	612
3.3.4.13	Server Application Requests Closing an Open	613
3.3.4.14	Server Application Queries a Session.....	613
3.3.4.15	Server Application Queries a TreeConnect	614
3.3.4.16	Server Application Queries an Open	614
3.3.4.17	Server Application Requests Transport Binding Change.....	615
3.3.4.18	Server Service Enables the CIFS Server.....	615
3.3.4.19	Server Services Disables the CIFS Server	615
3.3.4.20	Server Service Pauses the CIFS Server.....	615
3.3.4.21	Server Services Resumes (Continues) the CIFS Server	616
3.3.4.22	Server Application Requests Updating the Server Configuration	616
3.3.4.23	Server Application Requests Server Statistics	616
3.3.5	Processing Events and Sequencing Rules.....	617
3.3.5.1	Accepting an Incoming Connection.....	617
3.3.5.2	Receiving Any Message	618
3.3.5.2.1	Command Processing.....	619
3.3.5.2.2	Processing Options	620
3.3.5.2.3	Message Signing	620
3.3.5.2.4	Receiving any Batched ("AndX") Request	620
3.3.5.2.5	Receiving Any Transaction Request	621
3.3.5.2.6	Supporting Shares in the DFS Namespace	622
3.3.5.2.7	Granting OpLocks.....	622
3.3.5.3	Receiving an SMB_COM_CREATE_DIRECTORY Request.....	622
3.3.5.4	Receiving an SMB_COM_DELETE_DIRECTORY Request.....	623
3.3.5.5	Receiving an SMB_COM_OPEN Request	624
3.3.5.6	Receiving an SMB_COM_CREATE Request	625
3.3.5.7	Receiving an SMB_COM_CLOSE Request	626
3.3.5.8	Receiving an SMB_COM_FLUSH Request.....	626
3.3.5.9	Receiving an SMB_COM_DELETE Request	626
3.3.5.10	Receiving an SMB_COM_RENAME Request	628
3.3.5.11	Receiving an SMB_COM_QUERY_INFORMATION Request	629
3.3.5.12	Receiving an SMB_COM_SET_INFORMATION Request.....	629
3.3.5.13	Receiving an SMB_COM_READ Request	630
3.3.5.14	Receiving an SMB_COM_WRITE Request.....	630
3.3.5.15	Receiving an SMB_COM_LOCK_BYTE_RANGE Request	631
3.3.5.16	Receiving an SMB_COM_UNLOCK_BYTE_RANGE Request	632
3.3.5.17	Receiving an SMB_COM_CREATE_TEMPORARY Request	632
3.3.5.18	Receiving an SMB_COM_CREATE_NEW Request.....	633
3.3.5.19	Receiving an SMB_COM_CHECK_DIRECTORY Request	634
3.3.5.20	Receiving an SMB_COM_PROCESS_EXIT Request	634
3.3.5.21	Receiving an SMB_COM_SEEK Request.....	635
3.3.5.22	Receiving an SMB_COM_LOCK_AND_READ Request	635
3.3.5.23	Receiving an SMB_COM_WRITE_AND_UNLOCK Request	636
3.3.5.24	Receiving an SMB_COM_READ_RAW Request	636
3.3.5.25	Receiving an SMB_COM_READ_MPX Request.....	638
3.3.5.26	Receiving an SMB_COM_WRITE_RAW Request	639
3.3.5.27	Receiving an SMB_COM_WRITE_MPX Request	640
3.3.5.28	Receiving an SMB_COM_QUERY_INFORMATION2 Request.....	641
3.3.5.29	Receiving an SMB_COM_SET_INFORMATION2 Request.....	642
3.3.5.30	Receiving an SMB_COM_LOCKING_ANDX Request	642
3.3.5.31	Receiving an SMB_COM_TRANSACTION Request.....	643
3.3.5.32	Receiving an SMB_COM_IOCTL Request.....	643

3.3.5.33	Receiving an SMB_COM_ECHO Request	644
3.3.5.34	Receiving an SMB_COM_WRITE_AND_CLOSE Request	644
3.3.5.35	Receiving an SMB_COM_OPEN_ANDX Request	645
3.3.5.36	Receiving an SMB_COM_READ_ANDX Request	647
3.3.5.37	Receiving an SMB_COM_WRITE_ANDX Request	648
3.3.5.38	Receiving an SMB_COM_TRANSACTION2 Request	649
3.3.5.39	Receiving an SMB_COM_FIND_CLOSE2 Request	650
3.3.5.40	Receiving an SMB_COM_TREE_CONNECT Request	650
3.3.5.41	Receiving an SMB_COM_TREE_DISCONNECT Request	651
3.3.5.42	Receiving an SMB_COM_NEGOTIATE Request	652
3.3.5.43	Receiving an SMB_COM_SESSION_SETUP_ANDX Request	652
3.3.5.44	Receiving an SMB_COM_LOGOFF_ANDX Request	654
3.3.5.45	Receiving an SMB_COM_TREE_CONNECT_ANDX Request	655
3.3.5.46	Receiving an SMB_COM_QUERY_INFORMATION_DISK Request	656
3.3.5.47	Receiving an SMB_COM_SEARCH or SMB_COM_FIND Request	657
3.3.5.48	Receiving an SMB_COM_FIND_UNIQUE Request	659
3.3.5.49	Receiving an SMB_COM_FIND_CLOSE Request	659
3.3.5.50	Receiving an SMB_COM_NT_TRANSACT Request	659
3.3.5.51	Receiving an SMB_COM_NT_CREATE_ANDX Request	660
3.3.5.52	Receiving an SMB_COM_NT_CANCEL Request	662
3.3.5.53	Receiving an SMB_COM_NT_RENAME Request	662
3.3.5.54	Receiving an SMB_COM_OPEN_PRINT_FILE Request	664
3.3.5.55	Receiving an SMB_COM_WRITE_PRINT_FILE Request	664
3.3.5.56	Receiving an SMB_COM_CLOSE_PRINT_FILE Request	664
3.3.5.57	Receiving any SMB_COM_TRANSACTION Subcommand Request	665
3.3.5.57.1	Receiving a RAP Transaction Request	666
3.3.5.57.2	Receiving a TRANS_SET_NMPIPE_STATE Request	667
3.3.5.57.3	Receiving a TRANS_RAW_READ_NMPIPE Request	667
3.3.5.57.4	Receiving a TRANS_QUERY_NMPIPE_STATE Request	667
3.3.5.57.5	Receiving a TRANS_QUERY_NMPIPE_INFO Request	668
3.3.5.57.6	Receiving a TRANS_PEEK_NMPIPE Request	668
3.3.5.57.7	Receiving a TRANS_TRANSACT_NMPIPE Request	668
3.3.5.57.8	Receiving a TRANS_RAW_WRITE_NMPIPE Request	668
3.3.5.57.9	Receiving a TRANS_READ_NMPIPE Request	669
3.3.5.57.10	Receiving a TRANS_WRITE_NMPIPE Request	669
3.3.5.57.11	Receiving a TRANS_WAIT_NMPIPE Request	669
3.3.5.57.12	Receiving a TRANS_CALL_NMPIPE Request	670
3.3.5.58	Receiving Any SMB_COM_TRANSACTION2 Subcommand Request	670
3.3.5.58.1	Receiving Any Information Level	670
3.3.5.58.2	Receiving a TRANS2_OPEN2 Request	671
3.3.5.58.3	Receiving a TRANS2_FIND_FIRST2 Request	672
3.3.5.58.4	Receiving a TRANS2_FIND_NEXT2 Request	673
3.3.5.58.5	Receiving a TRANS2_QUERY_FS_INFORMATION Request	673
3.3.5.58.6	Receiving a TRANS2_QUERY_PATH_INFORMATION Request	673
3.3.5.58.7	Receiving a TRANS2_SET_PATH_INFORMATION Request	674
3.3.5.58.8	Receiving a TRANS2_QUERY_FILE_INFORMATION Request	674
3.3.5.58.9	Receiving a TRANS2_SET_FILE_INFORMATION Request	674
3.3.5.58.10	Receiving a TRANS2_CREATE_DIRECTORY Request	674
3.3.5.58.11	Receiving a TRANS2_GET_DFS_REFERRAL Request	675
3.3.5.59	Receiving any SMB_COM_NT_TRANSACT Subcommand Request	675
3.3.5.59.1	Receiving an NT_TRANSACT_CREATE Request	675
3.3.5.59.2	Receiving an NT_TRANSACT_IOCTL Request	677
3.3.5.59.3	Receiving an NT_TRANSACT_SET_SECURITY_DESC Request	677

3.3.5.59.4	Receiving an NT_TRANSACT_NOTIFY_CHANGE Request	678
3.3.5.59.5	Receiving an NT_TRANSACT_QUERY_SECURITY_DESC Request	679
3.3.6	Timer Events	679
3.3.6.1	OpLock Break Acknowledgment Timer Event	679
3.3.6.2	Idle Connection Timer Event	679
3.3.6.3	Unused Open Search Timer Event	679
3.3.6.4	Unused Connection Timer Event	680
3.3.7	Other Local Events	680
3.3.7.1	Handling a Transport Disconnect	680
3.3.7.2	Server Disconnects a Connection	680
3.3.7.3	Handling an Incoming Transport Connection	680
3.4	Local Interface Details for RPC Client Applications	680
3.4.1	Abstract Data Model	681
3.4.2	Timers	681
3.4.3	Initialization	681
3.4.4	Higher-Layer Triggered Events	681
3.4.4.1	An RPC Client Application Opens a Named Pipe	681
3.4.4.2	An RPC Client Application Writes to a Named Pipe	683
3.4.4.3	An RPC Client Application Reads from a Named Pipe	683
3.4.4.4	An RPC Client Application Issues a Named Pipe Transaction	684
3.4.4.5	An RPC Client Application Closes a Named Pipe	684
3.4.4.6	An RPC Client Application Requests the Session Key for an Authenticated Context	685
3.4.4.7	A Local Client Application Initiates a Server Session	685
3.4.4.8	A Local Client Application Terminates a Server Session	685
3.4.4.9	A Local Client Application Queries DFS Referrals	686
3.4.4.10	A Local Client Application Requests a Connection to a Share	686
3.4.4.11	A Local Client Application Requests a Tree Disconnect	687
3.4.4.12	A Local Client Application Queries the Extended DFS Referral Capability	687
3.4.5	Message Processing Events and Sequencing Rules	688
3.4.6	Timer Events	688
3.4.7	Other Local Events	688
3.5	Local Interface Details for RPC Server Applications	688
3.5.1	Abstract Data Model	688
3.5.2	Timers	688
3.5.3	Initialization	688
3.5.4	Higher-Layer Triggered Events	688
3.5.4.1	An RPC Server Application Waits for Clients to Open a Named Pipe	688
3.5.4.2	An RPC Server Application Closes its Open to a Named Pipe	689
3.5.4.3	An RPC Server Application Requests the Security Context of a Client	689
3.5.4.4	An RPC Server Application Requests the Session Key of a Client	689
3.5.5	Message Processing Events and Sequencing Rules	689
3.5.6	Timer Events	689
3.5.7	Other Local Events	689
4	Protocol Examples	690
4.1	Negotiate and Tree Connect Example	690
4.2	Disconnect Example	690
4.3	Message Signing Example	691
4.4	Get File Attributes Example	692
4.5	Set File Attributes Example	693
4.6	Copy File from Share Example	695
4.7	Copy File to Share Example	696

5 Security	698
5.1 Security Considerations for Implementers.....	698
5.2 Index of Security Parameters	698
6 Appendix A: Product Behavior	699
7 Change Tracking	766
8 Index	769

1 Introduction

The Common Internet File System (CIFS) Protocol is a cross-platform, transport-independent protocol that provides a mechanism for client systems to use file and print services made available by server systems over a network.

CIFS is a dialect of the **Server Message Block (SMB)** protocol, which was originally developed by IBM Corporation and then further enhanced by Microsoft, IBM, Intel, 3Com, and others. There are several dialects of SMB. A standard for the SMB protocol, covering dialects prior to CIFS, was published by X/Open (now The Open Group) as [XOPEN-SMB].

The meaning of the term "CIFS" has changed since it was first introduced. It was originally used to indicate a proposed standard version of SMB based upon the design of the Windows NT 4.0 operating system and Windows 2000 operating system implementations. In some references, "CIFS" has been used as a name for the SMB protocol in general (all dialects) and, additionally, the suite of protocols that support and include SMB. In this document, the term "CIFS" is used specifically to identify the Windows **NT LAN Manager (NTLM)** dialect of SMB as designed for use with Windows: in particular, Windows NT Server 3.51 operating system and Windows NT Server 4.0 operating system, Windows NT Workstation 4.0 operating system, and Microsoft Windows 98 operating system.

This document defines the protocol as it was designed for Windows NT operating system. It also specifies the behaviors of Windows NT and Windows 98, with respect to optional behavior, and documents known errors and variances in implementation. Changes and enhancements made to the SMB protocol are documented in [\[MS-SMB\]](#).

Sections 1.8, 2, and 3 of this specification are normative and can contain the terms MAY, SHOULD, MUST, MUST NOT, and SHOULD NOT as defined in RFC 2119. Sections 1.5 and 1.9 are also normative but cannot contain those terms. All other sections and examples in this specification are informative.

1.1 Glossary

The following terms are defined in [\[MS-GLOS\]](#):

- 8.3 name**
- ASCII**
- authentication**
- blocking mode (of a named pipe)**
- broadcast**
- connection (1)**
- discretionary access control list (DACL)**
- disk**
- Distributed File System (DFS)**
- Distributed File System (DFS) link**
- Distributed File System (DFS) path**
- Distributed File System (DFS) referral**
- Distributed File System (DFS) referral request**
- Distributed File System (DFS) referral response**
- drive**
- encryption**
- endpoint**
- error code**

exchange
FID
file
file attribute
file system control (FSCTL)
guest account
handshake
Information Level
little-endian
mailslot
message mode
multiplexed request
named pipe
NBNS
NetBIOS
NetBIOS datagram service
NetBIOS name
network byte order
NT file system (NTFS)
NT LAN Manager (NTLM)
OEM character
OEM code page
OpLock break
opportunistic lock (OpLock)
path
pipe instance
pipe state
print job
process identifier (PID)
raw read (on a named pipe)
raw write (on a named pipe)
read-only
remote procedure call (RPC)
RPC client
RPC server
security context
security descriptor
Server Message Block (SMB)
session (2)
session key
share
share connect
SMB connection
SMB dialect
SMB session
system access control list (SACL)
Transmission Control Protocol (TCP)
Unicode
Unicode string
Universal Naming Convention (UNC)
virtual connection

The following terms are specific to this document:

byte mode: One of two kinds of **named pipe**, the other of which is **message mode**. In byte mode, the data sent or received on the named pipe does not have message boundaries but is treated as a continuous stream. [XOPEN-SMB] uses the term "stream mode" instead of "byte mode", and [\[SMB-LM1X\]](#) refers to byte mode as "byte stream mode".

Common Internet File System (CIFS): The "NT LM 0.12" / **NT LAN Manager** dialect of the **Server Message Block (SMB)** Protocol, as implemented in Windows NT. The "CIFS" name originated in the 1990's as part of an attempt to create an Internet standard for **SMB**, based upon the then-current Windows NT implementation.

deprecated: A deprecated feature is one that has been superseded in the protocol by a newer feature. Use of deprecated features is discouraged. Server implementations might need to implement deprecated features to support clients that negotiate earlier **SMB dialects**.

dialog: The exchange of messages between client and server over a given **SMB connection**.

Input/output control (IOCTL): Also known as I/O control. A command issued to a network device to alter or query the behavior and state of the device.

non-blocking mode (of a named pipe): Determines if input/output (I/O) operations on a **named pipe** will return to the caller without waiting for the data transfer to complete. When non-blocking mode is set, read requests return with all data available to be read from the named pipe, up to the maximum read size set in the request; write requests return after writing data to the named pipe without waiting for the data to be consumed.

object store: A system that provides the ability to create, query, modify, or apply policy to a local resource on behalf of a remote client. The object store is backed by a file system, a **named pipe**, or a **print job** that is accessed as a file.

obsolescent: An obsolescent feature has no replacement feature but is becoming obsolete. Use of obsolescent features is discouraged. Server implementations might need to implement obsolescent features in order to support clients that negotiate earlier **SMB dialects**.

obsolete: An **obsolete** feature is one that was introduced in an earlier dialect but that is no longer supported in the NT LAN Manager dialect. Support for **obsolete** features is to be avoided in new implementations.

open: A runtime object that corresponds to a currently established access to a specific file or a **named pipe** from a specific client to a specific server, using a specific user **security context**. Both clients and servers maintain **opens** that represent active accesses.

Server Service: The CIFS file sharing service. The **Server Service** registers a **NetBIOS** name with a suffix byte value of 0x20 and responds to **SMB commands**.

SMB command: A set of SMB messages that are exchanged in order to perform an operation. An **SMB** command is typically identified by a unique command code in the message headers, although some **SMB commands** require the use of secondary commands. Within this document, the term "command" means an **SMB command** unless otherwise stated.

SMB message: A protocol data unit. **SMB messages** are comprised of a header, a parameter section, and a data section. The latter two can be zero length. An **SMB message** is sometimes referred to simply as "an SMB". Within this document, the term "message" means an SMB message unless otherwise stated.

SMB transport: Any protocol that acts as a transport layer for the **SMB** Protocol.

tree connect: A connection between a **CIFS** client and a share on a remote **CIFS** server.

virtual circuit (VC): A transport-level connection between a **CIFS client** and a server. Some references use the term "virtual connection" instead of "virtual circuit".

MAY, SHOULD, MUST, SHOULD NOT, MUST NOT: These terms (in all caps) are used as described in [\[RFC2119\]](#). All statements of optional behavior use either MAY, SHOULD, or SHOULD NOT.

1.2 References

References to Microsoft Open Specifications documentation do not include a publishing year because links are to the latest version of the documents, which are updated frequently. References to other documents include a publishing year when one is available.

1.2.1 Normative References

We conduct frequent surveys of the normative references to assure their continued availability. If you have any issue with finding a normative reference, please contact dochelp@microsoft.com. We will assist you in finding the relevant information.

[IEEE802.2-1998] Institute of Electrical and Electronics Engineers, "Part 2: LAN/MAN Logical Link Control", IEEE Std 802.2, 1998. This standard is also called ISO/IEC 8802-2:1998, <http://standards.ieee.org/getieee802/802.2.html>

[MS-BRWS] Microsoft Corporation, "[Common Internet File System \(CIFS\) Browser Protocol](#)".

[MS-DFSC] Microsoft Corporation, "[Distributed File System \(DFS\): Referral Protocol](#)".

[MS-DFSNM] Microsoft Corporation, "[Distributed File System \(DFS\): Namespace Management Protocol](#)".

[MS-DTYP] Microsoft Corporation, "[Windows Data Types](#)".

[MS-ERREF] Microsoft Corporation, "[Windows Error Codes](#)".

[MS-FSCC] Microsoft Corporation, "[File System Control Codes](#)".

[MS-LSAD] Microsoft Corporation, "[Local Security Authority \(Domain Policy\) Remote Protocol](#)".

[MS-MSRP] Microsoft Corporation, "[Messenger Service Remote Protocol](#)".

[MS-NLMP] Microsoft Corporation, "[NT LAN Manager \(NTLM\) Authentication Protocol](#)".

[MS-RAP] Microsoft Corporation, "[Remote Administration Protocol](#)".

[MS-RPCE] Microsoft Corporation, "[Remote Procedure Call Protocol Extensions](#)".

[MS-SRVS] Microsoft Corporation, "[Server Service Remote Protocol](#)".

[NBF] Microsoft Corporation, "Comparison of Windows NT Network Protocols", November 2006, <http://support.microsoft.com/kb/q128233>

[NBF2CIFS] Evans, T. D., "NetBIOS, NetBEUI, NBF, NBT, NBIPX, SMB, CIFS Networking", July 2003, <http://timothydevans.me.uk/n2c.html>

[NETBEUI] IBM Corporation, "LAN Technical Reference: 802.2 and NetBIOS APIs", 1986, http://publibz.boulder.ibm.com/cgi-bin/bookmgr_OS390/BOOKS/BK8P7001/CCONTENTS

[RFC1001] Network Working Group, "Protocol Standard for a NetBIOS Service on a TCP/UDP Transport: Concepts and Methods", STD 19, RFC 1001, March 1987, <http://www.ietf.org/rfc/rfc1001.txt>

[RFC1002] Network Working Group, "Protocol Standard for a NetBIOS Service on a TCP/UDP Transport: Detailed Specifications", STD 19, RFC 1002, March 1987, <http://www.ietf.org/rfc/rfc1002.txt>

[RFC1321] Rivest, R., "The MD5 Message-Digest Algorithm", RFC 1321, April 1992, <http://www.ietf.org/rfc/rfc1321.txt>

[RFC2119] Bradner, S., "Key words for use in RFCs to Indicate Requirement Levels", BCP 14, RFC 2119, March 1997, <http://www.rfc-editor.org/rfc/rfc2119.txt>

[RFC2743] Linn, J., "Generic Security Service Application Program Interface Version 2, Update 1", RFC 2743, January 2000, <http://www.ietf.org/rfc/rfc2743.txt>

[RYAN] Ryan, R., and Ryan, B., "LAN Manager: A Programmer's Guide, Version 2", Microsoft Press, July 1990, ISBN: 1556151667.

[XOPEN-SMB] The Open Group, "Protocols for X/Open PC Interworking: SMB, Version 2", The Open Group, 1992, ISBN: 1872630456.

1.2.2 Informative References

[CIFS] Leach, P. and Naik, D., "A Common Internet File System (CIFS/1.0) Protocol", March 1997, <http://www.microsoft.com/about/legal/protocols/BSTD/CIFS/draft-leach-cifs-v1-spec-02.txt>

[ENSIGN] Microsoft Corporation, "How to enable SMB signing in Windows NT", <http://support.microsoft.com/kb/161372/>

[FSBO] Microsoft Corporation, "File System Behavior in the Microsoft Windows Environment", June 2008, <http://download.microsoft.com/download/4/3/8/43889780-8d45-4b2e-9d3a-c696a890309f/File%20System%20Behavior%20Overview.pdf>

[IBM-SMB] IBM Personal Computer Seminar Proceedings, "The IBM PC Network Program", vol 2, No 8, October 1984.

[IMPCIFS] Hertel, C. R., "Implementing CIFS - The Common Internet File System", Prentice Hall, August 2003, ISBN: 013047116X.

[KB102067] Microsoft Corporation, "SESSTIMEOUT Information", <http://support.microsoft.com/kb/102067>

[KB129202] Microsoft Corporation, "PC Ext: Explanation of Opportunistic Locking on Windows NT", <http://support.microsoft.com/kb/129202>

[KB143474] Microsoft Corporation, "Restricting information available to anonymous logon users", <http://support.microsoft.com/kb/143474>

[KB297684] Microsoft Corporation, "Mapped Drive Connection to Network Share May Be Lost", <http://support.microsoft.com/kb/297684>

[KB301673] Microsoft Corporation, "You cannot make more than one client connection over a NAT device", <http://www.tech-archive.net/Archive/Win2000/microsoft.public.win2000.networking/2004-06/1748.html>

[MSKB-320829] Microsoft Corporation, "How to modify the default SizReqBuf value in Windows 2000 and Windows Server 2003", November 2006, <http://support.microsoft.com/kb/320829>

[KB887429] Microsoft Corporation, "Overview of Server Message Block signing", Version 2.4, November 2007, <http://support.microsoft.com/kb/887429>

[MD5Collision] Klima, V., "Tunnels in Hash Functions: MD5 Collisions Within a Minute", March 2006, <http://eprint.iacr.org/2006/105.pdf>

[MS-FSA] Microsoft Corporation, "[File System Algorithms](#)".

[MS-GLOS] Microsoft Corporation, "[Windows Protocols Master Glossary](#)".

[MS-MAIL] Microsoft Corporation, "[Remote Mailslot Protocol](#)".

[MS-NBTE] Microsoft Corporation, "[NetBIOS over TCP \(NBT\) Extensions](#)".

[MS-SMB] Microsoft Corporation, "[Server Message Block \(SMB\) Protocol](#)".

[MS-SMB2] Microsoft Corporation, "[Server Message Block \(SMB\) Protocol Versions 2 and 3](#)".

[MS-WPO] Microsoft Corporation, "[Windows Protocols Overview](#)".

[MSBRWSE] Thompson IV, D. and McLaughlin, R., "MS Windows NT Browser", <https://www.microsoft.com/technet/archive/winntas/deploy/prodspecs/ntbrowse.mspx>

[MSDFS] Microsoft Corporation, "How DFS Works", March 2003, <http://technet.microsoft.com/en-us/library/cc782417%28WS.10%29.aspx>

[MSDN-CallNmdPipe] Microsoft Corporation, "CallNamedPipe function", [http://msdn.microsoft.com/en-us/library/aa365144\(VS.85\).aspx](http://msdn.microsoft.com/en-us/library/aa365144(VS.85).aspx)

[MSDN-CreateFile] Microsoft Corporation, "CreateFile", [http://msdn.microsoft.com/en-us/library/aa363858\(VS.85\).aspx](http://msdn.microsoft.com/en-us/library/aa363858(VS.85).aspx)

[MSDN-DiscntEndpoint] Microsoft Corporation, "Disconnecting an Endpoint-to-Endpoint Connection", [http://msdn.microsoft.com/en-us/library/ff545611\(v=VS.85\).aspx](http://msdn.microsoft.com/en-us/library/ff545611(v=VS.85).aspx)

[MSDN-ENPLAINTEXT] Microsoft Corporation, "EnablePlainTextPassword", <http://msdn.microsoft.com/en-us/library/cc939354.aspx>

[MSDN-GetNmdPipeHndState] Microsoft Corporation, "GetNamedPipeHandleState function", [http://msdn.microsoft.com/en-us/library/aa365443\(VS.85\).aspx](http://msdn.microsoft.com/en-us/library/aa365443(VS.85).aspx)

[MSDN-GetNmdPipeInfo] Microsoft Corporation, "GetNamedPipeInfo function", [http://msdn.microsoft.com/en-us/library/aa365445\(VS.85\).aspx](http://msdn.microsoft.com/en-us/library/aa365445(VS.85).aspx)

[MSDN-IMPERS] Microsoft Corporation, "Impersonation" <http://msdn.microsoft.com/en-us/library/ms691341.aspx>

[MSDN-IoCreateFile] Microsoft Corporation, "IoCreateFile", <http://msdn.microsoft.com/en-us/library/ff548418.aspx>

[MSDN-MakeEndpoint] Microsoft Corporation, "Making an Endpoint-to-Endpoint Connection", [http://msdn.microsoft.com/en-us/library/ff549239\(v=VS.85\).aspx](http://msdn.microsoft.com/en-us/library/ff549239(v=VS.85).aspx)

[MSDN-OBJ_ATTRIBUTES] Microsoft Corporation, "OBJECT_ATTRIBUTES structure", <http://msdn.microsoft.com/en-us/library/ff557749.aspx>

[MSDN-PkNmdPipe] Microsoft Corporation, "PeekNamedPipe function", [http://msdn.microsoft.com/en-us/library/aa365779\(VS.85\).aspx](http://msdn.microsoft.com/en-us/library/aa365779(VS.85).aspx)

[MSDN-RecErrorNotif] Microsoft Corporation, "Receiving Error Notifications", [http://msdn.microsoft.com/en-us/library/ff563300\(v=VS.85\).aspx](http://msdn.microsoft.com/en-us/library/ff563300(v=VS.85).aspx)

[MSDN-SDCTRLREQSTS] Microsoft Corporation, "Serial Device Control Requests", <http://msdn.microsoft.com/en-us/library/ff547466.aspx>

[MSDN-SNmPipeHdlSt] Microsoft Corporation, "SetNamedPipeHandleState function", [http://msdn.microsoft.com/en-us/library/aa365787\(VS.85\).aspx](http://msdn.microsoft.com/en-us/library/aa365787(VS.85).aspx)

[MSDN-TDIDeviceObj] Microsoft Corporation, "TDI Device Objects", [http://msdn.microsoft.com/en-us/library/ff565087\(v=VS.85\).aspx](http://msdn.microsoft.com/en-us/library/ff565087(v=VS.85).aspx)

[MSDN-TrnsactNmdPipe] Microsoft Corporation, "TransactNamedPipe function", [http://msdn.microsoft.com/en-us/library/aa365790\(VS.85\).aspx](http://msdn.microsoft.com/en-us/library/aa365790(VS.85).aspx)

[MSDN-TrnspDrvIntfc] Microsoft Corporation, "Transport Driver interface", [http://msdn.microsoft.com/en-us/library/ff565685\(v=VS.85\).aspx](http://msdn.microsoft.com/en-us/library/ff565685(v=VS.85).aspx)

[MSDN-WaitNmdPipe] Microsoft Corporation, "WaitNamedPipe function", [http://msdn.microsoft.com/en-us/library/aa365800\(VS.85\).aspx](http://msdn.microsoft.com/en-us/library/aa365800(VS.85).aspx)

[MSFT-IPXWAN] Microsoft Corporation, "IPX WAN Broadcasting", <http://technet.microsoft.com/en-us/library/cc957949.aspx>

[MSFT-NBNWLINK] Microsoft Corporation, "The NWLink IPX/SPX/NetBIOS Compatible Transport Protocol (NWLink)", January 2005, [http://technet.microsoft.com/en-us/library/cc782167\(WS.10\).aspx](http://technet.microsoft.com/en-us/library/cc782167(WS.10).aspx)

[MSFT-SecurityWatch] Microsoft Corporation, "Security Watch", <http://technet.microsoft.com/en-us/magazine/2006.08.securitywatch.aspx>

[MSFT-XEXTNP] Microsoft Corporation, "OpenNET/Microsoft Networks FILE SHARING PROTOCOL EXTENSIONS", Version 1.9, September 1986, <ftp://ftp.samba.org/pub/samba/SMB-info/xextnp.txt>

[MSKB-235717] Microsoft Corporation, "BUG: CallNamedPipe() API lpBytesRead Parameter Returns Bogus Number", Version 3.3, February 2007, <http://support.microsoft.com/kb/235717>

[MSKB-239869] Microsoft Corporation, "How to enable NTLM 2 authentication", Version 4.7, January 2007, <http://support.microsoft.com/kb/239869>

[MSKB-288358] Microsoft Corporation, "How to install the Active Directory Client Extension", Version 7.1, July 2007, <http://support.microsoft.com/kb/288358>

[MSLOT] Microsoft Corporation, "Mailslots", <http://msdn.microsoft.com/en-us/library/aa365576.aspx>

[NBGUIDE] Winston, G., "NetBIOS Specification", 2003, <http://www.netbiosguide.com/>

[NWLINK] Microsoft Corporation, "Description of Microsoft NWLINK IPX/SPX-Compatible Transport", October 2006, <http://support.microsoft.com/?kbid=203051>

[RAP] Leach, P. and Naik, D., "CIFS Remote Administration Protocol - Preliminary Draft", February 1997, <ftp://ftp.microsoft.com/developr/drg/CIFS/cifsrap2.txt>

[SMB-CORE] Microsoft Corporation, Intel Corporation, "Microsoft Networks / OpenNet", Document Version 2, November 1988, <ftp://ftp.microsoft.com/developr/drq/CIFS/SMB-CORE.PS>

[SMB-LM12] Microsoft Corporation, "Microsoft Networks SMB File Sharing Protocol Extensions", Version 3.0, Document Version 1.09, November 1989, <ftp://ftp.microsoft.com/developr/drq/CIFS/SMB.TXT>

[SMB-LM1X] Microsoft Corporation, "Microsoft Networks SMB File Sharing Protocol Extensions", Version 2.0, Document Version 3.3, November 1988, <ftp://ftp.microsoft.com/developr/drq/CIFS/SMB-LM1X.PS>

[SMB-LM20] Microsoft Corporation, "Microsoft Networks SMB File Sharing Protocol Extensions", Version 3.0, Document Version 1.11, June 1990, <ftp://ftp.microsoft.com/developr/drq/CIFS/SMB-LM20.PS>

[SMB-LM21] Microsoft Corporation, "Microsoft Networks SMB File Sharing Protocol Extensions", Document Version 3.4, February 1992, <ftp://ftp.microsoft.com/developr/drq/CIFS/SMB-LM21.DOC>

[SNIA] Storage Networking Industry Association, "Common Internet File System (CIFS) Technical Reference, Revision 1.0", March 2002, http://networks.cs.ucdavis.edu/~zhuk/research/sans/documents/CIFS-TR-1p00_FINAL.pdf

1.3 Overview

The Common Internet File System (CIFS) is a general-purpose network file system protocol. It provides clients with managed, concurrent access to files and directories hosted on server systems. It also provides access to print queues and interprocess communication services, and supports authenticated transport for remote procedure call subprotocols. With a few exceptions, CIFS is client-driven in that a client makes requests to which a server responds.

To this end, CIFS defines three entities: the **client**, the **server**, and the **application**. The client is an implementation of the protocol and originates most of the messages. The server is also an implementation of the protocol and provides the majority of the functionality described herein as a service. Remaining functionality is handled by a number of subsystems associated with CIFS. These include:

- Transaction processing subsystems (SMB Trans, SMB Trans2, and NT Trans)
- User authentication subsystem
- **Distributed File System (DFS)** processing subsystem
- **Remote Administration Protocol (RAP)** processing subsystem
- **Remote Procedure Call (RPC)** processing subsystem

These subsystems can be integrated into a CIFS server implementation or can be accessed as separate services via CIFS.

Although the client originates most exchanges in CIFS, it is not the triggering entity in most cases; that role is filled by the application. The application is an entity that needs support of the CIFS protocol, but does not directly implement the protocol. Instead, the application relies on the implementation of CIFS by the client to gain the benefits of the CIFS services, through an API or other access method that is not defined in this specification. The application can be a piece of software that fulfills purposes such as word processing or a graphic user interface to file management, but can be particular to CIFS.

Hereafter, the terms "client", "server", and "application" describe the aforementioned entities. This specification assumes that although the client and the application are independent entities, they are considered to be tightly bound as far as CIFS is concerned. There is no direct interaction between the application and the server, except through the client. As such, there is no independent role attributed to the application in this specification.

CIFS is a stateful protocol. It imposes state to maintain **security contexts**, cryptographic protections, and file access semantics such as locking and caching. CIFS allows multiple clients to concurrently share files and printers hosted by server systems, thus facilitating collaboration, efficient use of resources, and centralized management.

CIFS supports the following features:

- **Transport independence.** The CIFS protocol itself does not place any requirements upon the transport protocol that is used to pass SMB messages between the client and the server. CIFS is typically carried over a connection-oriented protocol, but connectionless protocols have been used as CIFS transports.
- **Flexible connectivity.** A single client can connect to multiple servers, and can make one or more connections to each server. The activity of multiple client processes can be multiplexed over a single connection.
- **Feature negotiation.** The dialect and the supported feature set of the protocol are negotiated on a per-connection basis.
- **Resource access.** A client can concurrently access multiple shared resources (files, named pipes, print queues) on the target server.
- **Security contexts.** A client can create and use one or more security contexts over a connection.
- **File access.** A client can open, read, write, modify, delete, and close multiple files on the target server. File sharing is managed by the server, so multiple clients can have the same file open at the same time.
- **Extended subprotocols.** CIFS supports a set of subprotocols that provide direct access to additional server functionality.
- **Named pipe interprocess communication.** A client can open, read, write, and close **named pipes** on the target server. Named pipes provide a communications path between client and server processes.
- **File and record locking, and safe caching.** CIFS supports file and record locking, as well as opportunistic locking of files to allow clients to cache data for better performance.
- **File, directory, and volume attributes.** CIFS provides the ability to query and (with limitations) set file, directory, and volume attributes, including extended attributes. CIFS also provides support for the use of **Access Control Lists (ACLs)**.
- **File and directory change notification.** CIFS clients can post a request to be notified when a change is made to a file within a directory or directory tree on the server.
- **Batched commands.** CIFS AndX messages can be chained together and executed in sequence on the server, avoiding multiple message round-trips.
- **Distributed File System (DFS) support.** The **DFS namespace** is supported. DFS provides a single consistent object naming scheme (a unified namespace) that can span a collection of different servers and shares. The DFS model employed is a referral-based model, which is

specified in [\[MS-DFSC\]](#). CIFS specifies the manner in which clients and servers receive and process referrals.

- **Remote Procedure Call Transport.** CIFS provides authenticated transport for remote procedure call protocols such as RPC [\[MS-RPCE\]](#) and RAP [\[MS-RAP\]](#).
- **Message verification.** CIFS supports message signing, as described in [\[KB887429\]](#), which is used to ensure that messages have not been modified in transit.
- **Unicode file name support.** CIFS supports both extended ASCII (OEM) character set and Unicode file names. CIFS supports **8.3 name** format file names, long file names using the extended ASCII character set (8-bit characters), and long file names in **Unicode**.

1.4 Relationship to Other Protocols

CIFS Transports

The CIFS protocol is transport-independent. It requires only a mechanism for sending and receiving the SMB messages that are specified in this document. CIFS is designed for use over reliable transport, and is most commonly carried over connection-oriented sessions. With only minor modifications, however, it is possible to use a connectionless transport to exchange CIFS messages.

The transport protocols most commonly used by CIFS fall into two basic categories: NetBIOS-based and Direct Hosting. NetBIOS-based transports include:

- NetBIOS over TCP/IP (NBT), as specified in [\[RFC1001\]](#) and [\[RFC1002\]](#).
- NetBIOS Frames Protocol (NBF), as specified in [\[NETBEUI\]](#).
- NetBIOS over IPX/SPX, known as NBIPX, and described in [\[MSFT-NBNWLINK\]](#).

NetBIOS-based transports provide three common services: a Name Service, a Datagram Service, and a Session Service. On DOS, OS/2, and Windows platforms, these three services are used to support a NetBIOS interface layer that is accessed via a common API. Implementation of the NetBIOS API is not required for CIFS.

It is also possible to build a direct interface between CIFS and an underlying network transport without the use of a NetBIOS interface layer. In Microsoft documentation, this is referred to as "Direct Hosting". CIFS on DOS, OS/2, and Windows systems supports Direct Hosting over the connectionless IPX protocol. IPX Direct Hosting is briefly described in the Understanding NWLink section of [\[MSFT-NBNWLINK\]](#).

Protocols Transported by CIFS

The following protocols use CIFS as a transport and provide CIFS clients with access to additional server functionality:

- The SMB Transaction, Transaction2, and NT Transaction subprotocols. These are **SMB/CIFS** extensions and are described within this document. The SMB Transaction subprotocol provides support for writing to and reading from named pipes.
- **Remote Administration Protocol (RAP)**, as specified in [\[MS-RAP\]](#). See also [\[RAP\]](#) and [\[XOPEN-SMB\]](#).
- The **Remote Procedure Call (RPC)** protocol over Named Pipes. SMB Transaction calls are used to perform I/O to named pipes. See [\[MS-RPCE\]](#) for more information on **RPC** Protocol Extensions.

Additional Related Protocols

- CIFS supports the Distributed File System (DFS) Namespace Referral Protocol, as specified in [\[MS-DFSC\]](#). For an overview of DFS, see [\[MSDFS\]](#). For management of DFS, see [\[MS-DFSNM\]](#).
- CIFS services are announced via the **CIFS Browser Protocol**. CIFS clients access **Local Master Browser Server** and **Backup Browser Server** nodes in order to retrieve a copy of the services list, known as the **Browse List**. The **CIFS Browser Protocol**, which is specified in [\[MS-BRWS\]](#), creates and maintains the **Browse List**. This protocol makes use of the Remote Mailslot protocol and RAP. The CIFS Browser Protocol does not use this specification directly, but is included here for completeness. For more information, see [\[MSBRWSE\]](#), [\[MS-RAP\]](#), and [\[MS-MAIL\]](#).
- The **Messenger Service**, which is documented in [\[MS-MSRP\]](#), is related to CIFS in that it uses messages that are formatted as SMB messages. Although they are formatted as SMB messages, Messenger Service messages are not part of the CIFS protocol.
- The CIFS server interacts with the Server Service Remote Protocol [\[MS-SRVS\]](#) for file server management and for synchronizing the information on **shares**, **sessions**, treeconnects, file **opens**, and server configurations. The synchronization mechanism is dependent on the CIFS server and the **server service** starting up and terminating at the same time.

CIFS Successors

The Server Message Block Version 1.0 (SMB) Protocol, as implemented in Windows 2000 operating system and above, is specified in [\[MS-SMB\]](#), which lists extensions, enhancements, and clarifications to this document. Note, however, that the protocol described in [\[MS-SMB\]](#) uses the same dialect identifier ("NT LM 0.12") as CIFS.

The Server Message Block Version 2.0 (SMB2) Protocol, in contrast, is an entirely new file sharing protocol based upon SMB concepts. SMB2 is specified in [\[MS-SMB2\]](#).

1.5 Prerequisites/Preconditions

CIFS requires an underlying network transport that is generally connection-oriented. With some minor modifications to CIFS protocol behavior, CIFS messages can be exchanged using a connectionless transport. If the transport is connection-oriented, the connection needs to be established before CIFS messages can be exchanged.

CIFS assumes that the server has one or more of the following local resources available:

- For file sharing services, a local file system or some other resource (such as a database) that can be presented as a file system. This resource is known as the **object store**.
- For printer services, a local print queue that spools print jobs to a printer.
- For interprocess communications using the named pipe abstraction, a file system that supports named pipes or a suitable emulation built into the CIFS server.

The server is also required to provide or have access to a password database for authentication. To support challenge/response authentication, the password database is required to store the **LAN Manager** (LM) and NT LAN Manager (NTLM) password hashes.

1.6 Applicability Statement

CIFS is a dialect of the SMB network file sharing protocol, designed to provide concurrent access to directories and files hosted on server systems. CIFS is applicable for all scenarios that involve

transferring files between client and server. It is also applicable for accessing centralized print queues, and for interprocess communications using named pipes.

1.7 Versioning and Capability Negotiation

The SMB Protocol supports dialect negotiation. A dialect is a version of the SMB Protocol that is generally defined in terms of additions and changes relative to a previous version. New SMB dialects typically provide new commands, can include modifications to previous commands, and are likely to include extensions to existing semantics. When the SMB Protocol starts up, its first task is to determine which dialect the client and server use to communicate. See the `SMB_COM_NEGOTIATE` command for a detailed description of the SMB dialect negotiation process.

In the protocol negotiation process, SMB dialects are identified by Dialect Identifier Strings. For example, the **Core Protocol** is identified by two strings: "PCLAN1.0" or "PC NETWORK PROGRAM 1.0". Either or both of these strings can be sent by the client. The CIFS dialect is also known as NT LAN Manager (or, simply NT LANMAN), and is identified by the dialect string "NT LM 0.12".

The earliest dialect of SMB is now referred to as the **Core Protocol** because, for many years, it represented the least common set of commands that were required to be implemented for interoperability--the "core" set. In CIFS, many older commands including some original **Core Protocol** commands have been declared **obsolete** and are no longer used. Others are listed as **deprecated** or **obsolescent**, which means that they are likely to become obsolete and are not recommended to be used by clients, even though it is recommended that servers support them.

The table below lists the most common or best-known dialects, as well as related documentation (if available).

SMB Dialects

Dialect name	Dialect Identifier String	Comments
Core Protocol	PCLAN1.0	The dialect supported by IBM Corporation in early implementations of the SMB Protocol. It is documented in [IBM-SMB].
Core Protocol	PC NETWORK PROGRAM 1.0	Represents the MSNET SMB Protocol, which is also known as the "core protocol". This dialect is identical to the "PCLAN1.0" dialect, and some versions of MSNET accept either dialect string. This dialect is documented in [SMB-CORE].
Xenix Extensions	xenix1.1	The "xenix1.1" dialect is documented in [MSFT-XEXTNP]. This dialect provides a set of extensions to SMB to support the XENIX operating system. Also known as the XENIX dialect.
Xenix Extensions	XENIX CORE	Another dialect supporting XENIX extensions, possibly the same as "xenix1.1". The "XENIX CORE" dialect string is sent in protocol negotiation performed by Windows NT and OS/2, among others.
CorePlus	MICROSOFT NETWORKS 1.03	This string denotes the "CorePlus" dialect, consisting of several minor extensions to the core protocol, including raw read and write commands and compound commands such as <code>SMB_COM_LOCK_AND_READ</code> and <code>SMB_COM_WRITE_AND_UNLOCK</code> . The CorePlus extensions are documented in [XOPEN-SMB].
LAN	LANMAN1.0	The LAN Manager 1.0 extended protocol was created to support OS/2

Dialect name	Dialect Identifier String	Comments
Manager 1.0		system functions and file system features. It is documented in [SMB-LM1X] and [XOPEN-SMB].
DOS LAN Manager 1.0	MICROSOFT NETWORKS 3.0	This is the DOS LAN Manager 1.0 extended protocol. It is identical to "LANMAN1.0", except that OS/2 error codes are translated to DOS error codes before being transmitted to the client.
LAN Manager 1.2	LANMAN1.2	The LAN Manager 1.2 extended protocol adds support for additional OS/2 commands and features to "LANMAN1.0". LAN Manager 1.2 is documented in [SMB-LM12] and [XOPEN-SMB].
LAN Manager 2.0	LM1.2X002	This represents the LAN Manager 2.0 extended protocol for OS/2. It is documented in [SMB-LM20] and [XOPEN-SMB]. Also known as the LANMAN2.0 dialect.
DOS LAN Manager 2.0	DOS LM1.2X002	This is the DOS version of LAN Manager 2.0. It is also documented in [SMB-LM20] and [XOPEN-SMB]. When this dialect is selected, OS/2 error codes are translated to DOS error codes by the server before transmission to the client. Also known as the DOS LANMAN2.0 dialect.
LAN Manager 2.1	LANMAN2.1	LAN Manager 2.1 extended protocol. The additions and changes with respect to LAN Manager 2.0 are documented in [SMB-LM21] .
DOS LAN Manager 2.1	DOS LANMAN2.1	DOS LAN Manager 2.1 extended protocol. This is, once again, identical to the OS/2 version of the dialect except that error codes are translated. See [SMB-LM21] .
NT LAN Manager	NT LM 0.12	NT LAN Manager extended protocol. This set of extensions was created to support Windows NT. OS/2 LAN Manager 2.1 features are also supported. This dialect was originally documented in [CIFS] . Also known as the NT LANMAN dialect.

Security Negotiation: During the initialization of the SMB session, the server indicates support for:

- Either user-oriented or resource-oriented access controls.
- Plaintext or challenge/response authentication.
- Message signing. If it is supported, the server indicates that it is required.

If the client or server requires message signing but the other node does not support it, then SMB session establishment fails. Similarly, if either node requires a higher level of authentication security than the other supports, session establishment fails. See the SMB_COM_NEGOTIATE command for a detailed description of security negotiation.

Feature Negotiation: The client and server can negotiate individual features on a per-connection or, in some cases, per-message basis:

- CIFS provides a mechanism for negotiating a specific set of Capabilities, including support for Unicode file names, 64-bit file offsets, and Opportunistic Locking. For the complete list of Capabilities, see the SMB_COM_NEGOTIATE command specification. Capabilities are negotiated at session startup.

- Each SMB message includes two bit fields (Flags and Flags2) that indicate whether a specific feature or option has been selected for use in that message. These fields are described in section [2.2.3.1](#).

1.8 Vendor-Extensible Fields

This protocol uses NTSTATUS values as defined in [\[MS-ERREF\]](#) section 2.3. Vendors are free to choose their own values for this field, as long as the C bit (0x20000000) is set, indicating that it is a customer code.

SMB command codes listed as **Reserved** or **Unused** can be defined in future versions of CIFS or new SMB dialects, and thus MUST NOT be used in any CIFS implementation. Similarly, fields (including bit fields) that are marked **Reserved** MUST NOT be used. Undefined transaction sub-command codes and undefined **Information Level** values are reserved for future use.

1.9 Standards Assignments

CIFS transports can have assigned port numbers or other assigned values. See the documentation for the specific transport for more information.

2 Messages

2.1 Transport

This section describes the transport protocols that are implemented by the operating systems discussed in section [1](#), and which are used in transporting SMB messages.[<1>](#) Other transports may be available from third parties. In this document, the transport layer is referred to generically as the "SMB transport". The server assigns an implementation-specific name to each transport, as specified in [\[MS-SRV5\]](#) section 2.2.4.96.

2.1.1 NetBIOS-Based Transports

The **Network Basic Input/Output System (NetBIOS)** is a software interface layer. NetBIOS is specified in [\[NETBEUI\]](#).[<2>](#) NetBIOS imposes semantic requirements on the underlying transport mechanism. NetBIOS-based transports MUST support three common services:

- The **NetBIOS name service**
- The **NetBIOS datagram service**
- The **NetBIOS session service**

The **NetBIOS name service** provides a mechanism for registering and releasing **NetBIOS names**. NetBIOS names are end-point addresses; each name represents an application or service running on a node on the network.

The NetBIOS datagram service provides connectionless, unreliable transport for unicast, multicast, and **broadcast** messages (datagrams).

The **NetBIOS session service** provides reliable, point-to-point transport. When using the **NetBIOS session service**, CIFS makes no higher-level attempts to ensure reliable, sequenced delivery of messages between the client and server. The underlying transport is responsible for detecting failures of either the client node or server node and for delivering failure indications to the client or server software so that resources can be freed and errors can be reported to applications.

The **NetBIOS session service** supports the following behavior:

- If the client generates malformed requests (for example, if messages received on the session do not begin with the '\xFF', 'S', 'M', 'B' protocol identifier string), a server can drop the transport connection to the client. The server SHOULD[<3>](#) first return an error message response with an SMB error class of ERRCMD (0xFF). If a server receives a hard error on the transport (such as a send failure) the transport connection to that client can be aborted.
- If a client has no open resources on the server (no open files, directories, search contexts, and so on), the server can terminate the transport connection. It is expected that the client implementation can automatically reconnect to the server. See section [3.3.2.2](#) for a description of the Idle Connection Timer.

For more information about NetBIOS, see [\[NBF2CIFS\]](#), [\[NBGUIDE\]](#), [\[XOPEN-SMB\]](#) Appendix E, [\[NBF\]](#), and [\[RYAN\]](#).

2.1.1.1 NetBIOS Frames (NBF) Protocol Transport

The **NetBIOS Frames (NBF)** protocol is a non-routable transport that provides NetBIOS services over IEEE 802.2 as specified in [\[NETBEUI\]](#). The **NBF NetBIOS session service** makes use of IEEE 802.2 Logical Link Control connection-oriented services (Type 2), as specified in [\[IEEE802.2-1998\]](#).

IBM Corporation first introduced the **NBF** protocol specification in 1985 (see [\[NETBEUI\]](#)). The **NBF** transport protocol is sometimes referred to as [NetBEUI \(NetBIOS Extended User Interface\)](#) in Microsoft documentation (for more information, see [\[NBF\]](#)).

2.1.1.2 NetBIOS over TCP/UDP (NBT) Transport

NetBIOS over TCP/UDP (NBT) is specified in [\[RFC1001\]](#) and [\[RFC1002\]](#). **NBT** provides a mapping of the required NetBIOS services to the **TCP** and **UDP** internet protocols. Because the underlying **IP** protocol is routable, **NBT** transport can provide NetBIOS services across an internetwork. However, special servers are required in order to maintain the coherency of the **NetBIOS name space** across multiple subnets. These are the **NetBIOS Name Server (NBNS)** and the **NetBIOS Datagram Distribution Server (NBDD)**.[<4>](#)

2.1.1.3 NetBIOS over IPX/SPX (NBIPX) Transport

Internetwork Packet Exchange/Sequenced Packet Exchange (IPX/SPX) is a network protocol suite provided by Novell. CIFS can use **NetBIOS over IPX/SPX (NBIPX)** as a transport for **SMB messages**.

Novell introduced an implementation of **NetBIOS over IPX** in 1986. Microsoft later provided its own **IPX/SPX/NetBIOS**-compatible transport, **NWLINK** (see [\[NWLINK\]](#)). **NBIPX** provides a mapping of the required NetBIOS services to IPX/SPX. The **NBIPX NetBIOS session service** is mapped to **SPX** sessions, while datagrams are sent using the connectionless IPX protocol. For more information on **NWLINK** and **NBIPX** components, see [\[NBF\]](#) and [\[NWLINK\]](#).

2.1.1.4 Other NetBIOS-Based Transports

Several other NetBIOS-based transports have been defined and/or implemented. Many of these are proprietary, and most have fallen out of common use.

TOP/NetBIOS provides a specification for NetBIOS service support over OSI protocols. This specification is available in Appendix E of [\[XOPEN-SMB\]](#).

2.1.2 Direct Hosting

Microsoft has also produced "Direct Hosting" transports, which bypass the NetBIOS interface layer.[<5>](#)

2.1.2.1 Direct IPX Transport

Direct IPX Transport (also known as **Direct Hosting IPX**) carries CIFS over IPX protocol without the use of the NetBIOS interface layer.

Unlike other transport protocols used with CIFS, the **Direct IPX Transport** protocol is asymmetric. Wherever possible, processing is moved from the server to the client so that the server can scale to a large number of clients efficiently. For example, the server does not initiate retransmission of lost responses. It is entirely up to the client to resend the request in the case of lost packets in either direction.

IPX is also a connectionless protocol, so CIFS itself provides mechanisms for ensuring sequential delivery of messages between the client and server, and for detecting and recovering from failures of either the client node or server node. To accomplish these goals, the [SMB Header \(section 2.2.3.1\)](#) is modified to include a connection identifier (**CID**) and a sequence number (**SequenceNumber**). The **CID** value is generated by the server and returned to the client in the

[SMB_COM_NEGOTIATE Response \(section 2.2.4.52.2\)](#). The client MUST use this **CID** in all future SMB exchanges with this server during this resource sharing session.

The **SequenceNumber** value is provided by the client. If the sequence number is zero, the command is known as an "unsequenced command" and the client MUST use the **PID** and **MID** fields to match a response message to the client process that generated the request. In particular, the client MUST ensure that it never has more than one distinct outstanding unsequenced request with the same **MID**.

Sequenced commands have nonzero **SequenceNumber** values. Sequenced commands are used for operations that cause state changes on the server which cannot be repeated. For example, file open, file close, or byte-range locking. Unsequenced commands are used for operations that can be performed as many times as necessary with the same result each time. For example, reading or writing to a disk file.

CIFS servers using **Direct IPX Transport** MUST maintain a small buffer for each client. This buffer is used to temporarily store the response information from the most recent sequenced command. If the client does not receive a response to a sequenced request it SHOULD resend the request. If the server has already processed the request, the response MUST still be in the buffer and can be resent. If the server did not receive the original request, it is able to process the retransmitted request. When the client sends the next sequenced command request, it signals that the previous sequenced response was received and that the buffer can be reused.

Because of the asymmetric nature of the **Direct IPX Transport**, the server allocates a limited amount of space for the response buffer. Therefore, the client MUST send all commands that have a "large" response size as unsequenced. Such commands include file read and directory search operations. If the response to a sequenced command is too large for the response buffer, the server MUST fail the request with ERRSRV/ERRerror.

SMB Transactions are capable of transferring large amounts of data from the server to the client. Transactions can be used to change server state and so MUST NOT be sent as unsequenced commands. There are ways for clients to organize the commands to work around this limitation. Transactions can contain multi-part requests and/or multi-part responses. The sizes of the response messages can be adjusted to fit within the response buffer. Therefore, SMB Transactions are handled as a set of sequenced commands.

Section [3.2.4.1.5](#) describes SMB Transactions as used over connection-oriented transports. Transaction processing is modified when CIFS is carried over a connectionless transport, such as **Direct IPX Transport**.

When transactions are carried over a connectionless transport, each request message is sent as a sequenced command. Each message MUST have a consistent **MID** value and a nonzero **SequenceNumber** value that increases by one with each new message in the transaction. The server MUST respond to each request message, except the last one, with a response indicating that the server is ready for the next secondary request. For the initial transaction request message and all subsequent transaction secondary requests, except for the last request message, the server MUST send an interim response.

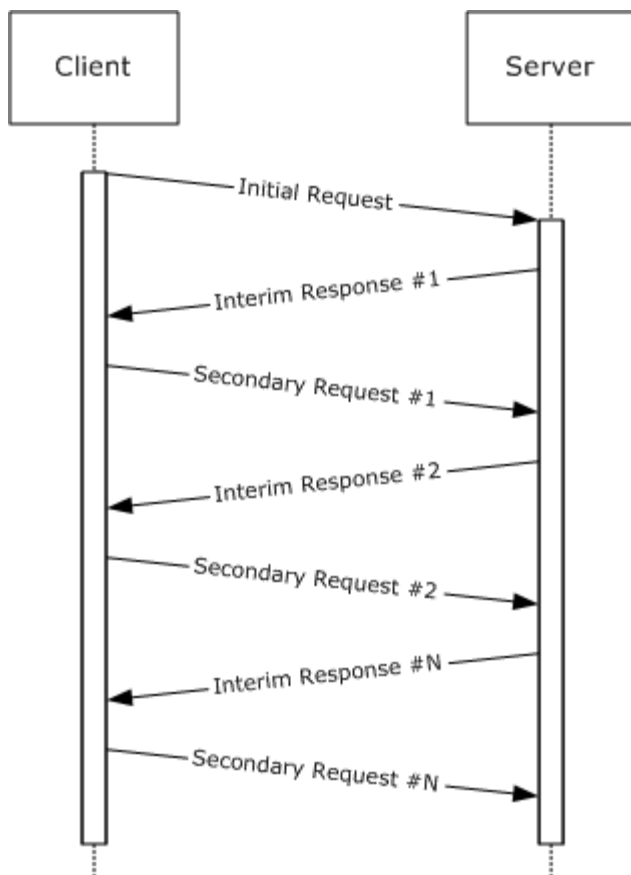

Figure 1: CIFS transaction messages over connectionless transport

When the last transaction request has been received by the server, the server MUST respond with a final response message, as described in section 3.2.4.1.5. However, if there are multiple final response messages, then the client MUST respond to each of the final response messages, except the last one, by sending an empty secondary request message. No parameters or data are transferred to the server in these messages. They are used only as acknowledgments to indicate that the response message has been received. These acknowledgment messages contain the following information:

- **ParameterDisplacement** is set to the number of parameter bytes that the client has received from the server so far in this transaction.
- **DataDisplacement** is set to the number of data bytes that the client has received from the server so far in this transaction.
- **ParameterCount**, **ParameterOffset**, **DataCount**, and **DataOffset** MUST be set to zero.

When the transaction has been completed, the client MUST send another sequenced command to the server. This indicates to the server that all of the transaction final response messages have been received and that the parameter and data transfer is complete. Resources allocated to the transaction command may then be released by the server.

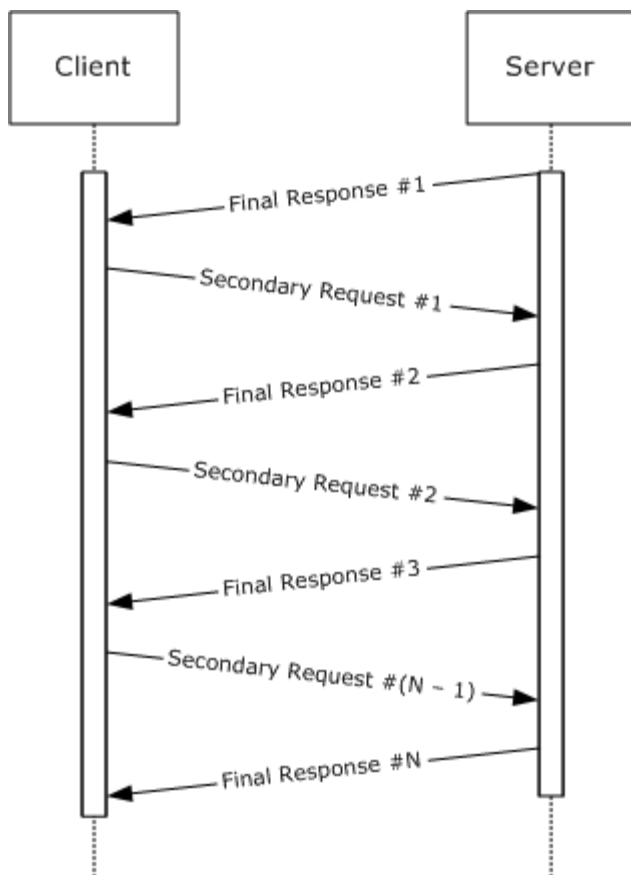

Figure 2: CIFS transaction completion messages over connectionless transport

For sequenced commands, the server requires that the sequence numbers are nonzero, start at 1, and increase by one for each new sequenced command. At $65535 (2^{16} - 1)$, the sequence wraps to 0x0001, not 0x0000. Sequenced command requests that have an incorrect sequence number **MUST** be ignored.

If the **CID** value is incorrect, the server **MUST** fail the request with ERRSRV/ERRinvsess. If the server is currently processing a command that matches either the sequence number (for sequenced commands) or the **MID** (for unsequenced commands) of a new request, the server **MUST** respond with ERRSRV/ERRworking. The values of ERRinvsess (0x0010) and ERRworking (0x0011) are defined only for the **Direct IPX Transport**.

The server waits to receive commands from the client periodically; if no commands are received, the server treats the client as no longer running and closes the **SMB session**. This includes closing file handles and releasing any resources allocated on behalf of the client. Clients **SHOULD**, at minimum, send an [SMB_COM_ECHO \(section 2.2.4.39\)](#) to the server every few minutes. The server **MUST NOT** disconnect clients that have been inactive less than 5 minutes.<6>

Direct IPX Transport can be used in situations in which multiple low-bandwidth connections are multiplexed together (for example, by using multiple telephone modems in parallel). CIFS provides special SMB commands, such as [SMB_COM_READ_MPX \(section 2.2.4.23\)](#), for these environments. These commands, and the **Direct IPX Transport** itself, are obsolescent.

See [\[MSFT-IPXWAN\]](#) for more information on **Direct IPX Transport**.

2.1.3 Virtual Circuits

In CIFS, a **virtual circuit (VC)** represents a transport-level connection between a client and a server. VCs are of use in situations in which multiple physical connections are being combined to provide improved overall bandwidth for an **SMB connection**. For example, VCs make it possible to multiplex SMB messages from a single SMB connection over multiple dial-up modem connections in order to increase throughput. Virtual circuits are rarely used over connection-oriented transports such as **NBT**; they are typically associated with connectionless transports such as **Direct-hosting IPX**. VC multiplexing is performed at the command level, with the exception of the SMB_COM_READ_MPX and SMB_COM_WRITE_MPX commands, which are specifically designed to be multiplexed.

VCs are established using the SMB_COM_SESSION_SETUP_ANDX command, and are combined based upon the **SessionKey** provided in the SMB_COM_NEGOTIATE response.<7> Every VC created between a client and server pair using the same **SessionKey** is considered to be part of the same SMB connection. Each VC thus created MUST have a unique **VcNumber** in the SMB_COM_SESSION_SETUP_ANDX request that is used to establish it. The first VC created SHOULD have a **VcNumber** of zero (0). The implementation-defined maximum number of virtual circuits that the client can establish per SMB connection is indicated by the **MaxNumberVcs** field in the server's SMB_COM_NEGOTIATE response.<8>

A **VcNumber** of zero (0) has special significance. It is possible for a connectionless transport to not provide any indication of failure when a client fails or is reset. A virtual circuit with a **VcNumber** of zero (0), regardless of the **SessionKey** value, is defined to indicate to the server that the client has abandoned all previous virtual circuits and that the server MUST close those VCs as well, ensuring proper cleanup of resources.<9> This behavior can have unintended consequences in situations where separate applications running on the same client establish individual connections to the same server, or in cases in which multiple clients connect to a single server through a **Network Address Translation (NAT)** device (see [KB301673] for a detailed explanation). In these situations, each connection attempt from the same client (or NAT device) can cause all others from that client to be disconnected. To avoid this, clients can use a **VcNumber** of greater than or equal to one, or servers MAY be configured to bypass special processing of **VcNumber** zero over connection-oriented transports.

2.2 Message Syntax

The CIFS Protocol is composed of, and driven by, **SMB commands**. SMB commands are comprised of SMB message exchanges between the client and the server. SMB commands can be categorized by functionality as follows.

Session management	Transaction subprotocol
SMB_COM_NEGOTIATE	SMB_COM_TRANSACTION
SMB_COM_SESSION_SETUP_ANDX	SMB_COM_TRANSACTION_SECONDARY
SMB_COM_TREE_CONNECT	SMB_COM_TRANSACTION2
SMB_COM_TREE_CONNECT_ANDX	SMB_COM_TRANSACTION2_SECONDARY
SMB_COM_TREE_DISCONNECT	SMB_COM_NT_TRANSACT
SMB_COM_LOGOFF_ANDX	SMB_COM_NT_TRANSACT_SECONDARY

File/directory access methods	Read/write/lock methods
SMB_COM_CREATE_DIRECTORY SMB_COM_DELETE_DIRECTORY SMB_COM_OPEN SMB_COM_OPEN_ANDX SMB_COM_CREATE SMB_COM_CREATE_NEW SMB_COM_CREATE_TEMPORARY SMB_COM_NT_CREATE_ANDX SMB_COM_CLOSE SMB_COM_DELETE	SMB_COM_FLUSH SMB_COM_SEEK SMB_COM_READ SMB_COM_LOCK_AND_READ SMB_COM_LOCK_BYTE_RANGE SMB_COM_UNLOCK_BYTE_RANGE SMB_COM_LOCKING_ANDX SMB_COM_READ_ANDX SMB_COM_READ_RAW SMB_COM_READ_MPX SMB_COM_WRITE SMB_COM_WRITE_AND_CLOSE SMB_COM_WRITE_AND_UNLOCK SMB_COM_WRITE_ANDX SMB_COM_WRITE_RAW SMB_COM_WRITE_COMPLETE SMB_COM_WRITE_MPX

Query directory information	Query/set attributes methods
SMB_COM_CHECK_DIRECTORY SMB_COM_SEARCH SMB_COM_FIND SMB_COM_FIND_UNIQUE SMB_COM_FIND_CLOSE SMB_COM_FIND_CLOSE2	SMB_COM_RENAME SMB_COM_NT_RENAME SMB_COM_QUERY_INFORMATION SMB_COM_SET_INFORMATION SMB_COM_QUERY_INFORMATION_DISK SMB_COM_QUERY_INFORMATION2 SMB_COM_SET_INFORMATION2

Printing methods	Other
SMB_COM_OPEN_PRINT_FILE SMB_COM_WRITE_PRINT_FILE SMB_COM_CLOSE_PRINT_FILE	SMB_COM_ECHO SMB_COM_PROCESS_EXIT SMB_COM_NT_CANCEL SMB_COM_INVALID SMB_COM_IOCTL SMB_COM_NO_ANDX_COMMAND

CIFS has evolved over time. As a result, some commands have become obsolete and other commands have been proposed but never implemented. The client MUST NOT use the commands listed in the table below. The server SHOULD return implementation-specific error codes in response to receiving any of these command requests.

Obsolete	Reserved but not implemented
SMB_COM_COPY	SMB_COM_CLOSE_AND_TREE_DISC
SMB_COM_MOVE	SMB_COM_FIND_NOTIFY_CLOSE
SMB_COM_READ_MPX_SECONDARY	SMB_COM_IOCTL_SECONDARY
SMB_COM_SECURITY_PACKAGE_ANDX	SMB_COM_NEW_FILE_SIZE
SMB_COM_WRITE_MPX_SECONDARY	SMB_COM_QUERY_SERVER
SMB_COM_GET_PRINT_QUEUE	SMB_COM_READ_BULK
	SMB_COM_WRITE_BULK
	SMB_COM_WRITE_BULK_DATA

Specifications for the commands listed in the preceding tables are located in section [2.2.3](#).

An SMB message is the payload packet encapsulated in a transport packet. SMB messages are divided into three blocks: a fixed-length SMB Header (section [2.2.3.1](#)), and two variable-length blocks called SMB Parameters (section [2.2.3.2](#)) and SMB Data (section [2.2.3.3](#)).

Unless otherwise specified, multiple-byte fields (SHORT, USHORT, LONG, and so on) in an SMB message MUST be transmitted in little-endian order (least-significant byte first). Unless otherwise indicated, numeric fields are integers of the specified byte length.

In dialects prior to NT LAN Manager, data alignment was not a consideration in SMB messages. Commands introduced in the NT LAN Manager dialect, however, can include fixed or variable-length padding fields used to align succeeding fields to 16-bit or 32-bit boundaries. **Unicode strings**, also introduced in NT LAN Manager, MUST be aligned to 16-bit boundaries unless otherwise noted.

Unless otherwise noted, fields marked as "reserved" SHOULD be set to zero when sent and MUST be ignored on receipt. These fields are reserved for future protocol expansion and MUST NOT be used for implementation-specific functionality. When it is necessary to insert padding bytes into a buffer for data alignment purposes, such bytes SHOULD be set to 0x00 when sent and MUST be ignored on receipt.

CIFS defines a set of data types and data structures that are commonly used across multiple commands in the protocol. These are specified in section [2.2.1](#). Some data structures exist that are used only in one or two commands. Those are specified in their respective command's subsection of section [2.2.4](#). All data types encountered in sections [2](#) and [3](#) that are not defined in section [2.2](#) are found in [\[MS-DTYP\]](#).

Unless otherwise noted, when an error occurs the server MUST return a response SMB message with a proper status code in the header (see section [2.2.3.1](#)). Error responses SHOULD be sent with empty SMB Parameters and SMB Data blocks (**WordCount** and **ByteCount** fields set to zero; see sections [2.2.3.2](#) and [2.2.3.3](#) respectively).

CIFS defines a number of constants, including CIFS-specific error codes, which are commonly used across multiple commands in the protocol. The CIFS specific error codes include STATUS_INVALID_SMB and all status code constants with names beginning with STATUS_SMB_ and STATUS_OS2. These status codes are specified in section [2.2.2.4](#). All other constants in section [2](#) and [3](#) that begin with STATUS_ are defined in [\[MS-ERREF\]](#) section 2.3.

2.2.1 Common Data Types

CIFS makes use of the following data types and structures from [\[MS-DTYP\]](#):

- [BOOLEAN](#)

- [NTSTATUS](#)
- [UCHAR](#)
- [ULONG](#)
- [USHORT](#)
- [WCHAR](#)
- [FILETIME](#)
- [LARGE_INTEGER](#)
- [SECURITY_DESCRIPTOR](#)

In addition, CIFS defines its own data types and structures, as specified in the following subsections.

2.2.1.1 Character Sequences

In all dialects prior to NT LAN Manager, all character sequences were encoded using the **OEM character set** (extended ASCII). The NT LAN Manager dialect introduced support for Unicode, which is negotiated during protocol negotiation and session setup. The use of **Unicode characters** is indicated on a per-message basis by setting the `SMB_FLAGS2_UNICODE` flag in the `SMB_Header.Flags2` field. All Unicode characters **MUST** be in UTF-16LE encoding.

In CIFS, character sequences are transmitted over the wire as arrays of either `UCHAR` (for **OEM characters**) or `WCHAR` (for Unicode characters). Throughout this document, null-terminated character sequence fields that may be encoded in either Unicode or OEM characters (depending on the result of Unicode capability negotiation) are labeled as **SMB_STRING** fields.

Unless otherwise noted, when a Unicode string is passed it **MUST** be aligned to a 16-bit boundary with respect to the beginning of the [SMB Header \(section 2.2.3.1\)](#). In the case where the string does not naturally fall on a 16-bit boundary, a null padding byte **MUST** be inserted, and the string **MUST** begin at the next address. For **Core Protocol** messages in which a buffer format byte precedes a Unicode string, the padding byte is found after the buffer format byte.

String fields that restrict character encoding to OEM characters only, even if Unicode support has been negotiated, are labeled as **OEM_STRING**. Some examples of strings that are never passed in Unicode are:

- The dialect strings in the [SMB_COM_NEGOTIATE \(section 2.2.4.52\)](#) command.
- The service name string in the [SMB_COM_TREE_CONNECT_ANDX \(section 2.2.4.55\)](#) command.

2.2.1.1.1 File and Directory names

Dialects prior to **LAN Manager 2.0** required that file and directory names adhere to the 8.3 name format. Names of this format consist of two parts: a basename of no more than eight characters, and an extension of no more than three characters. The basename and extension are separated by a "." (period). All characters are legal in the basename and extension except:

- The space character (0x20)
- "\[!:\+|<>=;?;*,

The **LAN Manager 2.0** dialect introduced the `SMB_FLAGS2_KNOWS_LONG_NAMES` flag. If a client or server sets this flag in its messages, this indicates that they are not bound by the 8.3 name convention and support long file and directory names. Long names have **MUST** a total length of less than 255 characters. The following characters are illegal in a long name:

- `"\[:+|<>=;?;*,`

A "." (period) is treated as a delimiter of file name components. The 8.3 name format uses the period to separate the filename from the file extension.

2.2.1.1.2 Pathnames

CIFS makes use of the pathname structure as defined in [\[MS-FSCC\]](#) section 2.1.5, with the following restrictions:

Pathnames **MUST** adhere to the **Universal Naming Convention (UNC)**. The <sharename> component of a UNC-compliant pathname **MUST** adhere to the restrictions of a Share Name structure as defined in [\[MS-FSCC\]](#) section 2.1.6, with an additional note that it **MAY** be subject to the restrictions of file and directory names (section [2.2.1.1.1](#)). The <filename> component of a UNC-compliant pathname **MAY** be zero or more name components separated by the "\" (backslash) character. All name components of a pathname **MUST** adhere to the restrictions of file and directory names as specified in section [2.2.1.1.1](#).

If a pathname points to an object or device in **DFS**, it is a **DFS Path** and certain restrictions apply as specified in [\[MS-DFSC\]](#) section 2.2.1. A client that recognizes DFS **SHOULD** set the `SMB_FLAGS2_DFS` flag in the [SMB Header \(section 2.2.3.1\)](#) in all SMB requests using a DFS Path, and the server **SHOULD** resolve it within the **DFS namespace**.

2.2.1.1.3 Wildcards

Some SMB requests allow wildcards to be used in a file name. Wildcards allow a client to operate on a number of files as a unit without having to separately enumerate the files and operate on them individually. [<10>](#)

Two wild card characters, the question mark and the asterisk, are used to match files whose names are selected by the wildcard string used as a selection criterion. The "?" (question mark) character matches a single character. If a file name selection criterion contains one or more "?" characters, then exactly that number of characters is matched by the wildcards. For example, the criterion "??x" matches "abx" but not "abcx" or "ax", because the two file names do not have enough characters preceding the literal. When a file name criterion has "?" characters trailing a literal, then the match is made with specified number of characters or less. For example, the criterion "x??" matches "xab", "xa", and "x", but not "xabc". If only "?" characters are present in the file name selection criterion, then the match is made as if the criterion contained "?" characters trailing a literal. The "*" (asterisk) character matches an entire file name. A null or empty specification criterion also selects all file names. For example, "*.abc" or ".abc" match any file with an extension of "abc". "*.*", "*", or empty string("") match all files in a directory.

If the negotiated dialect is NT LAN Manager or later, and the filename in the client request contains any of the following wildcards, the server **SHOULD** translate them as follows and the server **MUST** use the resulting string to attempt the file operation:

- Translate the ? literal to >
- Translate the . literal to " if it is immediately followed by a ? or a *
- Translate the * literal to < if it is immediately followed by a .

2.2.1.2 File Attributes

CIFS makes use of three distinct methods for encoding file attributes:

- Extended Attributes ([SMB_GEA \(section 2.2.1.2.1\)](#) and [SMB_FEA \(section 2.2.1.2.2\)](#))
- Extended File Attributes ([SMB_EXT_FILE_ATTR \(section 2.2.1.2.3\)](#))
- File Attributes ([SMB_FILE_ATTRIBUTES \(section 2.2.1.2.4\)](#))

2.2.1.2.1 SMB_GEA

The SMB_GEA data structure is used in Transaction2 subcommand requests to request specific extended attribute (EA) name/value pairs by name. This structure is used when the SMB_INFO_QUERY_EAS_FROM_LIST information level is specified. "GEA" stands for "get extended attribute".

```
SMB_GEA
{
    UCHAR    AttributeNameLengthInBytes;

    UCHAR AttributeName[AttributeNameLengthInBytes + 1];
}
```

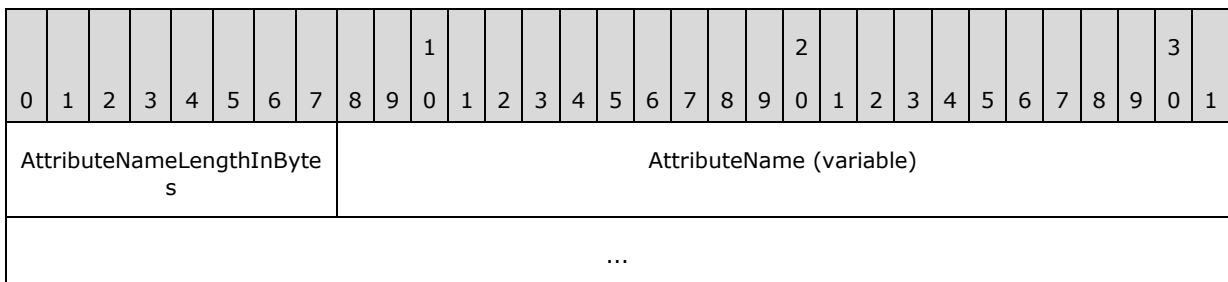

AttributeNameLengthInBytes (1 byte): This field MUST contain the length, in bytes (excluding the trailing null padding byte), of the AttributeName field.

AttributeName (variable): This field contains the name, in extended ASCII (OEM) characters, of an extended attribute. The length of the name MUST NOT exceed 255 bytes. An additional byte is added to store a null padding byte. This field MAY be interpreted as an OEM_STRING.

2.2.1.2.1.1 SMB_GEA_LIST

The SMB_GEA_LIST data structure is used to send a concatenated list of [SMB_GEA \(section 2.2.1.2.1\)](#) structures.

```
SMB_GEA_LIST
{
    ULONG SizeOfListInBytes;
    UCHAR GEAList[];
}
```

0	1	2	3	4	5	6	7	8	9	10	11	12	13	14	15	16	17	18	19	20	21	22	23	24	25	26	27	28	29	30	31
SizeOfListInBytes																															
GEAList (variable)																															
...																															

SizeOfListInBytes (4 bytes): This field MUST contain the total size of the **GEAList** field, plus the size of the **SizeOfListInBytes** field (4 bytes).<11>

GEAList (variable): A concatenated list of SMB_GEA (section 2.2.1.2.1) structures.

2.2.1.2.2 SMB_FEA

The SMB_FEA data structure is used in Transaction2 subcommands and in the NT_TRANSACT_CREATE subcommand to encode an extended attribute (EA) name/value pair. "FEA" stands for "full extended attribute".<12>

```
SMB_FEA
{
    UCHAR      ExtendedAttributeFlag;
    UCHAR      AttributeNameLengthInBytes;
    USHORT     AttributeValueLengthInBytes;
    UCHAR      AttributeName[AttributeNameLengthInBytes + 1];
    UCHAR      AttributeValue[AttributeValueLengthInBytes];
}
```

0	1	2	3	4	5	6	7	8	9	10	11	12	13	14	15	16	17	18	19	20	21	22	23	24	25	26	27	28	29	30	31
ExtendedAttributeFlag								AttributeNameLengthInBytes								AttributeValueLengthInBytes															
AttributeName (variable)																															
...																															
AttributeValue (variable)																															
...																															

ExtendedAttributeFlag (1 byte): This is a bit field. Only the 0x80 bit is defined.

Name and Bitmask	Meaning
0x7F	Reserved.

Name and Bitmask	Meaning
FILE_NEED_EA 0x80	<p>If set (1), this bit indicates that extended attribute (EA) support is required on this file. Otherwise, EA support is not required. If this flag is set, the file to which the EA belongs cannot be properly interpreted without understanding the associated extended attributes.</p> <p>A CIFS client that supports EAs can set this bit when adding an EA to a file residing on a server that also supports EAs. The server MUST NOT allow this bit to be set on an EA associated with directories.</p> <p>If this bit is set on any EA associated with a file on the server, the server MUST reject client requests to open the file (except to truncate the file) if the SMB_FLAGS2_EAS flag is not set in the request header. In this case, the server SHOULD fail this request with STATUS_ACCESS_DENIED (ERRDOS/ERRnoaccess) in the Status field of the SMB Header (section 2.2.3.1) in the server response.</p>

AttributeNameLengthInBytes (1 byte): This field MUST contain the length, in bytes, of the **AttributeName** field (excluding the trailing null byte).

AttributeValueLengthInBytes (2 bytes): This field MUST contain the length, in bytes, of the **AttributeValue** field.

AttributeName (variable): This field contains the name, in extended ASCII (OEM) characters, of an extended attribute. The length of the name MUST NOT exceed 255 bytes. An additional byte is added to store a null padding byte. This field MAY be interpreted as an OEM_STRING.

AttributeValue (variable): This field contains the value of an extended file attribute. The value is expressed as an array of extended ASCII (OEM) characters. This array MUST NOT be null-terminated, and its length MUST NOT exceed 65,535 bytes.

2.2.1.2.2.1 SMB_FEA_LIST

The SMB_FEA_LIST data structure is used to send a concatenated list of [SMB_FEA \(section 2.2.1.2.2\)](#) structures.

```
SMB_FEA_LIST
{
    ULONG SizeOfListInBytes;
    UCHAR FEAList[];
}
```

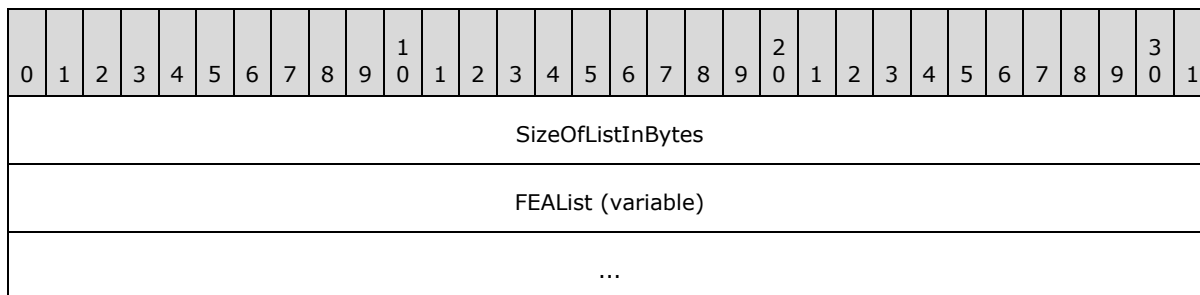

SizeOfListInBytes (4 bytes): This field MUST contain the total size of the **FEAList** field, plus the size of the **SizeOfListInBytes** field (4 bytes). [<13>](#)

FEAList (variable): A concatenated list of SMB_FEA structures.

2.2.1.2.3 SMB_EXT_FILE_ATTR

A 32-bit field containing encoded file attribute values and file access behavior flag values. The attribute and flag value names are for reference purposes only. If ATTR_NORMAL (see following) is set as the requested attribute value, it MUST be the only attribute value set. Including any other attribute value causes the ATTR_NORMAL value to be ignored. Any combination of the flag values (see following) is acceptable. <14>

This type is declared as follows:

```
typedef DWORD SMB_EXT_FILE_ATTR;
```

Name and bitmask	Meaning
ATTR_READONLY 0x00000001	The file is read only. Applications can read the file but cannot write to it or delete it.
ATTR_HIDDEN 0x00000002	The file is hidden. It is not to be included in an ordinary directory listing.
ATTR_SYSTEM 0x00000004	The file is part of or is used exclusively by the operating system.
ATTR_DIRECTORY 0x00000010	The file is a directory.
ATTR_ARCHIVE 0x00000020	The file has not been archived since it was last modified. Applications use this attribute to mark files for backup or removal.
ATTR_NORMAL 0x00000080	The file has no other attributes set. This attribute is valid only if used alone.
ATTR_TEMPORARY 0x00000100	The file is temporary. This is a hint to the cache manager that it does not need to flush the file to backing storage.
ATTR_COMPRESSED 0x00000800	The file or directory is compressed. For a file, this means that all of the data in the file is compressed. For a directory, this means that compression is the default for newly created files and subdirectories.
POSIX_SEMANTICS 0x01000000	Indicates that the file is to be accessed according to POSIX rules. This includes allowing multiple files with names differing only in case, for file systems that support such naming. <15>
BACKUP_SEMANTICS 0x02000000	Indicates that the file is being opened or created for a backup or restore operation. The server SHOULD allow the client to override normal file security checks, provided it has the necessary permission to do so.
DELETE_ON_CLOSE 0x04000000	Requests that the server delete the file immediately after all of its handles have been closed.
SEQUENTIAL_SCAN 0x08000000	Indicates that the file is to be accessed sequentially from beginning to end. <16>
RANDOM_ACCESS	Indicates that the application is designed to access the file randomly. The server

Name and bitmask	Meaning
0x10000000	can use this flag to optimize file caching.
NO_BUFFERING 0x20000000	Requests that the server open the file with no intermediate buffering or caching; the server might not honor the request. The application MUST meet certain requirements when working with files opened with FILE_FLAG_NO_BUFFERING. File access MUST begin at offsets within the file that are integer multiples of the volume's sector size and MUST be for numbers of bytes that are integer multiples of the volume's sector size. For example, if the sector size is 512 bytes, an application can request reads and writes of 512, 1024, or 2048 bytes, but not of 335, 981, or 7171 bytes.
WRITE_THROUGH 0x80000000	Instructs the operating system to write through any intermediate cache and go directly to the file. The operating system can still cache write operations, but cannot lazily flush them.

2.2.1.2.4 SMB_FILE_ATTRIBUTES

An unsigned 16-bit field that defines the basic file attributes supported by the SMB Protocol. In addition, exclusive search attributes (those Names prefixed with SMB_SEARCH_ATTRIBUTE) are defined for use when searching for files within a directory.

Name and bitmask	Description
SMB_FILE_ATTRIBUTE_NORMAL 0x0000	Normal file.
SMB_FILE_ATTRIBUTE_READONLY 0x0001	Read-only file.
SMB_FILE_ATTRIBUTE_HIDDEN 0x0002	Hidden file.
SMB_FILE_ATTRIBUTE_SYSTEM 0x0004	System file.
SMB_FILE_ATTRIBUTE_VOLUME 0x0008	Volume Label.
SMB_FILE_ATTRIBUTE_DIRECTORY 0x0010	Directory file.
SMB_FILE_ATTRIBUTE_ARCHIVE 0x0020	File changed since last archive.
SMB_SEARCH_ATTRIBUTE_READONLY 0x0100	Search for Read-only files.
SMB_SEARCH_ATTRIBUTE_HIDDEN 0x0200	Search for Hidden files.
SMB_SEARCH_ATTRIBUTE_SYSTEM 0x0400	Search for System files.

Name and bitmask	Description
SMB_SEARCH_ATTRIBUTE_DIRECTORY 0x1000	Search for Directory files.
SMB_SEARCH_ATTRIBUTE_ARCHIVE 0x2000	Search for files that have changed since they were last archived.
Other 0xC8C0	Reserved.

2.2.1.3 Named Pipe Status (SMB_NMPIPE_STATUS)

The **SMB_NMPIPE_STATUS** data type is a 16-bit field that encodes the status of a named pipe. Any combination of the following flags **MUST** be valid. The **ReadMode** and **NamedPipeType** bit fields are defined as 2-bit integers. Subfields marked **Reserved** **SHOULD** be set to zero by the server and **MUST** be ignored by the client.

This type is declared as follows:

```
typedef unsigned SHORT SMB_NMPIPE_STATUS;
```

Name and bitmask	Meaning
ICount 0x000FF	An 8-bit unsigned integer that gives the maximum number of instances the named pipe can have.
ReadMode 0x0300	0 This bit field indicates the client read mode for the named pipe. This bit field has no effect on writes to the named pipe. A value of zero indicates that the named pipe was opened in or set to byte mode by the client. 1 A value of 1 indicates that the client opened or set the named pipe to message mode . 2,3 Reserved. Bit 0x0200 MUST be ignored.
NamedPipeType 0x0C00	0 This bit field indicates the type of the named pipe when the named pipe was created by the server. A value of zero indicates that the named pipe was created as a byte mode pipe. 1 The named pipe was created by the server as a message mode pipe. 2,3 Reserved. Bit 0x0800 MUST be ignored.
0x3000	Reserved. MUST be ignored.
Endpoint	0

Name and bitmask	Meaning
0x4000	Client-side end of the named pipe. The SMB server MUST clear the Endpoint bit (set it to zero) when responding to the client request because the CIFS client is a consumer requesting service from the named pipe. When this bit is clear, it indicates that the client is accessing the consumer endpoint. 1 Indicates the server end of the pipe.
Nonblocking 0x8000	0 A named pipe read or raw read request will wait (block) until sufficient data to satisfy the read request becomes available, or until the request is canceled. A named pipe write or raw write request blocks until its data is consumed, if the write request length is greater than zero. 1 A read or a raw read request returns all data available to be read from the named pipe, up to the maximum read size set in the request. Write operations return after writing data to named pipes without waiting for the data to be consumed. Named pipe non-blocking raw writes are not allowed. Raw writes MUST be performed in blocking mode.

2.2.1.4 Time

In addition to making use of the [FILETIME](#) data type, CIFS defines three more data types for encoding time:

- [SMB_DATE \(section 2.2.1.4.1\)](#)
- [SMB_TIME \(section 2.2.1.4.2\)](#)
- [UTIME \(section 2.2.1.4.3\)](#)

2.2.1.4.1 SMB_DATE

This is a 16-bit value in little-endian byte order used to encode a date. An SMB_DATE value SHOULD be interpreted as follows. The date is represented in the local time zone of the server. The following field names are provided for reference only.

Field name and bitmask	Description
YEAR 0xFE00	The year. Add 1980 to the resulting value to return the actual year. <17>
MONTH 0x01E0	The month. Values range from 1 to 12.
DAY 0x001F	The date. Values range from 1 to 31.

2.2.1.4.2 SMB_TIME

This is a 16-bit value in little-endian byte order used to encode a time of day. The SMB_TIME value is usually accompanied by an [SMB_DATE \(section 2.2.1.4.1\)](#) value that indicates what date corresponds with the specified time. An SMB_TIME value SHOULD be interpreted as follows. The field names below are provided for reference only. The time is represented in the local time zone of the server.

Field name and bitmask	Description
HOUR 0xF800	The hours. Values range from 0 to 23.
MINUTES 0x07E0	The minutes. Values range from 0 to 59.
SECONDS 0x001F	The seconds. Values MUST represent two-second increments.

2.2.1.4.3 UTIME

This is a 32-bit unsigned integer in little-endian byte order indicating the number of seconds since Jan 1, 1970, 00:00:00.0.

This type is declared as follows:

```
typedef unsigned int UTIME;
```

2.2.1.5 Status Codes (SMB_ERROR)

An SMB_ERROR MUST be interpreted in one of two ways, depending on the capabilities negotiated between client and server: either as an NTSTATUS value (a 32-bit value in little-endian byte order used to encode an error message, as defined in [\[MS-ERREF\]](#) section 2.3), or as an SMBSTATUS value (as defined following).

```
SMBSTATUS
{
    UCHAR  ErrorClass;
    UCHAR  Reserved;
    USHORT ErrorCode;
}
```

0	1	2	3	4	5	6	7	8	9	0	1	2	3	4	5	6	7	8	9	0	1	2	3	4	5	6	7	8	9	0	1
ErrorClass								Reserved								ErrorCode															

ErrorClass (1 byte): An SMB error class code.

Reserved (1 byte): This field is reserved and MUST be ignored by both server and client.

ErrorCode (2 bytes): An SMB error code.

The set of NTSTATUS values defined in [MS-ERREF] is extended in this document to include 32-bit CIFS-specific error codes. Each CIFS-specific error code is wire-identical to the equivalent SMBSTATUS ErrorClass/ErrorCode pair, as listed in section 2.2.2.4. CIFS-specific error codes can be interpreted by the client either as 32-bit values or as SMBSTATUS values. <18>

2.2.1.6 Unique Identifiers

CIFS unique identifiers are used in to represent open files, authenticated users, SMB sessions, and so on within the protocol. To be a "unique identifier", an identifier MUST be unique with respect to other identifiers of the same type within the same context. The following is a list of unique identifiers used in CIFS and their relevant contexts:

- **FID (File ID):** A file handle, representing an open file on the server. A FID returned from an Open or Create operation MUST be unique within an SMB connection.
- **MID (Multiplex ID):** The MID is assigned by the client. All messages include a MID along with a PID (process ID, see below) to uniquely identify groups of commands belonging to the same logical thread of operation on the client node. The client MAY use the PID/MID pair to demultiplex command responses and to identify outstanding requests that are pending on the server (see SMB_COM_NT_CANCEL). In earlier SMB Protocol dialects, the MID was defined as a number that uniquely identified a protocol request and response within a process (see [SMB-LM1X], section 1). In CIFS, except where noted, a client MAY have multiple outstanding requests (within the limit set by the **MaxMPXCount** connection value) with the same PID and MID values. Clients inform servers of the creation of a new thread simply by introducing a new MID into the **dialog**.
- **PID (Process ID):** The PID is assigned by the client. The client SHOULD <19> set this to a value that identifies the process on the client node that initiated the request. The server MUST return both the PID and the MID to the client in any response to a client request. Clients inform servers of the creation of a new process simply by introducing a new PID into the dialog. In CIFS, the PID is a 32-bit value constructed by combining two 16-bit fields (**PIDLow** and **PIDHigh**) in the [SMB Header \(section 2.2.3.1\)](#).
- **SessionKey:** A Session Key is returned in the SMB_COM_NEGOTIATE response received during establishment of the SMB connection. This Session Key is used to logically bind separate virtual circuits (VCs) together. This Session Key is not used in any authentication or message signing. It is returned to the server in the SMB_COM_SESSION_SETUP_ANDX request messages that are used to create SMB sessions.
- **SessionKey:** The term "Session Key" also refers to a cryptographic secret key used to perform challenge/response authentication and is also used in the message signing algorithm. For each SMB session, the Session Key is the LM or NTLM password hash used in the generation of the response from the server-supplied challenge. The Session Key used in the first successful user authentication (non-anonymous, non-guest) becomes the signing Session Key for the SMB connection.
- **CID (Connection ID):** If a connectionless transport is in use, the Connection ID (CID) is generated by the server and passed in the SMB Header of every subsequent SMB message to identify the SMB connection to which the message belongs.
- **SID (Search ID):** A search ID (also known as a SID) is similar to a FID. It identifies an open directory search, the state of which is maintained on the server. Open SIDs MUST be unique to the SMB connection.

- **TID (Tree ID):** A TID represents an open connection to a share, otherwise known as a tree connect. An open TID **MUST** be unique within an SMB connection.
- **UID (User ID):** A UID represents an authenticated SMB session (including those created using anonymous or guest authentication). Some implementations refer to this value as a Virtual User ID (VUID) to distinguish it from the user IDs used by the underlying account management system.

2.2.1.6.1 FID Generation

File IDs (**FIDs**) are generated on CIFS servers. The generation of **FIDs** **MUST** satisfy the following constraints:

- The **FID** **MUST** be a 16-bit opaque value.
- The **FID** **MUST** be unique within a specified client/server SMB connection.
- The **FID** **MUST** remain valid for the lifetime of the SMB connection on which the open request is performed, or until the client sends a request to the server to close the **FID**.
- Once a **FID** has been closed, the value can be reused for another create or open request.
- The value 0xFFFF **MUST NOT** be used as a valid **FID**. All other possible values for **FID**, including zero (0x0000) are valid. The value 0xFFFF is used to specify all **FIDs** or no **FID**, depending upon the context in which it is used.

2.2.1.6.2 MID Generation

Multiplex IDs (**MIDs**) are generated on CIFS clients. The generation of **MIDs** **MUST** satisfy the following constraints:

- The **MID** **MUST** be a 16-bit opaque value.
- The **MID** **MUST** be unique with respect to a valid client **PID** over a single SMB connection.
- The **PID/MID** pair **MUST** remain valid as long as there are outstanding requests on the server identified by that **PID/MID** pair.
- The value 0xFFFF **MUST NOT** be used as a valid **MID**. All other possible values for **MID**, including zero (0x0000), are valid. The value 0xFFFF is used in an OpLock Break Notification request, which is an [SMB_COM_LOCKING_ANDX Request \(section 2.2.4.32.1\)](#) sent from the server.

2.2.1.6.3 PID Generation

Process IDs (**PIDs**) are generated on the CIFS client. The generation of **PIDs** **MUST** satisfy the following constraints:

- The **PID** **MUST** be a 32-bit opaque value. The **PID** value is transferred in two fields (**PIDHigh** and **PIDLow**) in the [SMB Header \(section 2.2.3.1\)](#).
- The **PID** **MUST** be unique within a specified client/server SMB connection.
- The **PID** **MUST** remain valid as long as there are outstanding client requests at the server.
- The value 0xFFFF **MUST NOT** be used as a valid **PIDLow**. All other possible values for **PID**, including zero (0x0000), are valid. The **PIDLow** value 0xFFFF is used in an OpLock Break

Notification request, which is an [SMB_COM_LOCKING_ANDX Request \(section 2.2.4.32.1\)](#) sent from the server.

In earlier dialects of the SMB Protocol, the **PID** value was a 16-bit unsigned value. The NT LAN Manager dialect introduced the use of the **PIDHigh** header field to extend the **PID** value to 32 bits.

2.2.1.6.4 Connection ID (CID) Generation

In order to support CIFS over connectionless transport, such as Direct IPX, CIFS servers MUST support the generation of Connection IDs (**CIDs**). The generation of **CIDs** MUST satisfy the following constraints:

- The **CID** MUST be a 16-bit opaque value.
- The **CID** MUST be unique across all SMB connections carried over connectionless transports.
- The **CID** MUST remain valid for the lifetime of the SMB connection.
- Once the connection has been closed, the **CID** value can be reused for another SMB connection.
- The values 0x0000 and 0xFFFF MUST NOT be used as valid **CIDs**. All other possible values for **CID** are valid.

2.2.1.6.5 Search ID (SID) Generation

Search IDs (**SIDs**) are generated on CIFS servers. The generation of **SIDs** MUST satisfy the following constraints:

- The **SID** MUST be a 16-bit opaque value for a specific [TRANS2_FIND_FIRST2 Request \(section 2.2.6.2.1\)](#).
- The **SID** MUST be unique for a specified client/server SMB connection.
- The **SID** MUST remain valid for the lifetime of the SMB connection while the search operation is being performed, or until the client sends a request to the server to close the SID.
- Once a **SID** has been closed, the value can be reused by another TRANS2_FIND_FIRST2 Request.
- The value 0xFFFF MUST NOT be used as a valid **SID**. All other possible values for **SID**, including zero (0x0000), are valid. The value 0xFFFF is reserved.

The acronym **SID** is also used to indicate a session ID. The two usages appear in completely different contexts.

2.2.1.6.6 SessionKey Generation

The term session key, in this context, does not refer to the cryptographic session keys used in authentication and message signing. Rather, it refers to the **SessionKey** unique identifier sent by the server in the [SMB_COM_NEGOTIATE Response \(section 2.2.4.52.2\)](#).

Virtual circuit session keys (**SessionKeys**) are generated on CIFS servers. The generation of **SessionKeys** SHOULD satisfy the following constraints: <20>

- The **SessionKey** MUST be a 32-bit opaque value generated by the CIFS server for a particular SMB connection, and returned in the SMB_COM_NEGOTIATE Response for that connection.

- The **SessionKey** MUST be unique for a specified client/server SMB connection.
- The **SessionKey** MUST remain valid for the lifetime of the SMB connection.
- Once the SMB connection has been closed, the **SessionKey** value can be reused.
- There are no restrictions on the permitted values of **SessionKey**. A value of 0x00000000 suggests, but does not require, that the server ignore the **SessionKey**.

2.2.1.6.7 TID Generation

Tree IDs (**TIDs**) are generated on CIFS servers. The generation of **TIDs** MUST satisfy the following constraints:

- The **TID** MUST be a 16-bit opaque value.
- The **TID** MUST be unique within a specified client/server SMB connection.
- The **TID** MUST remain valid for the lifetime of the SMB connection on which the tree connect request is performed, or until the client sends a request to the server to close the **TID**.
- Once a **TID** has been closed, the value can be reused in the response to another tree connect request.
- The value 0xFFFF MUST NOT be used as a valid **TID**. All other possible values for **TID**, including zero (0x0000), are valid. The value 0xFFFF is used to specify all **TIDs** or no **TID**, depending upon the context in which it is used.

2.2.1.6.8 UID Generation

User IDs (**UIDs**) are generated on CIFS servers. The generation of **UIDs** MUST satisfy the following constraints:

- The **UID** MUST be a 16-bit opaque value.
- The **UID** MUST be unique for a specified client/server SMB connection.
- The **UID** MUST remain valid for the lifetime of the SMB connection on which the authentication is performed, or until the client sends a request to the server to close the **UID** (to log off the user).
- Once a **UID** has been closed, the value can be reused in the response to another authentication request.
- The value 0xFFFE was declared reserved in the LAN Manager 1.0 documentation, so a value of 0xFFFE SHOULD NOT be used as a valid **UID**.[<21>](#) All other possible values for a **UID**, excluding zero (0x0000), are valid.

2.2.2 Defined Constants

2.2.2.1 SMB_COM Command Codes

Following is a listing of all SMB commands used in CIFS and their associated command codes, as well as additional useful information. The table reads as follows:

NT LAN Manager name and pre-NT LAN Manager name: Current name of command and alternate name used in older documentation, if available. If a code or code range is marked **Unused**, it is undefined and reserved for future use. If a code or code range is marked **Reserved**, it

is or was reserved for a specific purpose. Both of these indicate that client implementations SHOULD NOT send messages using any of those command codes.

Code: An SMB command code.

Description: A short description of the command. If a code or code range is marked as Reserved, this field lists its intended use.

Status: Current status of the command's usage (Deprecated, Obsolescent, or Obsolete) as used in this context.

- C = Currently used
- D = Deprecated
- O = Obsolescent
- X = Obsolete
- N = Not implemented - The command code was reserved and in some cases documented, but the command was never implemented.

Earliest dialect: Earliest known dialect in which this command appears.

NT LAN Manager name and pre-NT LAN Manager name	Code	Description	Status	Earliest dialect
SMB_COM_CREATE_DIRECTORY (section 2.2.4.1) SMBmkdir	0x00	Create a new directory.	D	CORE
SMB_COM_DELETE_DIRECTORY (section 2.2.4.2) SMBrmdir	0x01	Delete an empty directory.	C	CORE
SMB_COM_OPEN (section 2.2.4.3) SMBopen	0x02	Open a file.	D	CORE
SMB_COM_CREATE (section 2.2.4.4) SMBcreate	0x03	Create or open a file.	D	CORE
SMB_COM_CLOSE (section 2.2.4.5) SMBclose	0x04	Close a file.	C	CORE
SMB_COM_FLUSH (section 2.2.4.6) SMBflush	0x05	Flush data for a file, or all files associated with a client, PID pair.	C	CORE
SMB_COM_DELETE (section 2.2.4.7) SMBunlink	0x06	Delete a file.	C	CORE
SMB_COM_RENAME (section 2.2.4.8) SMBmv	0x07	Rename a file or set of files.	C	CORE
SMB_COM_QUERY_INFORMATION (section 2.2.4.9) SMBgetattr	0x08	Get file attributes.	D	CORE

NT LAN Manager name and pre-NT LAN Manager name	Code	Description	Status	Earliest dialect
SMB_COM_SET_INFORMATION (section 2.2.4.10) SMBsetattr	0x09	Set file attributes.	D	CORE
SMB_COM_READ (section 2.2.4.11) SMBread	0x0A	Read from a file.	D	CORE
SMB_COM_WRITE (section 2.2.4.12) SMBwrite	0x0B	Write to a file.	D	CORE
SMB_COM_LOCK_BYTE_RANGE (section 2.2.4.13) SMBlock	0x0C	Request a byte-range lock on a file.	D	CORE
SMB_COM_UNLOCK_BYTE_RANGE (section 2.2.4.14) SMBunlock	0x0D	Release a byte-range lock on a file.	D	CORE
SMB_COM_CREATE_TEMPORARY (section 2.2.4.15) SMBctemp	0x0E	Create a temporary file.	O	CORE
SMB_COM_CREATE_NEW (section 2.2.4.16) SMBmknew	0x0F	Create and open a new file.	D	CORE
SMB_COM_CHECK_DIRECTORY (section 2.2.4.17) SMBchkpth	0x10	Verify that the specified pathname resolves to a directory. Listed as SMBchkpath in some documentation.	C	CORE
SMB_COM_PROCESS_EXIT (section 2.2.4.18) SMBexit	0x11	Indicate process exit.	O	CORE
SMB_COM_SEEK (section 2.2.4.19) SMBlseek	0x12	Set the current file pointer within a file.	O	CORE
SMB_COM_LOCK_AND_READ (section 2.2.4.20) SMBlockread	0x13	Lock and read a byte-range within a file.	D	CorePlus
SMB_COM_WRITE_AND_UNLOCK (section 2.2.4.21) SMBwriteunlock	0x14	Write and unlock a byte-range within a file.	D	CorePlus
Unused	0x15 ... 0x19			
SMB_COM_READ_RAW (section 2.2.4.22)	0x1A	Read a block in raw mode.	D	CorePlus

NT LAN Manager name and pre-NT LAN Manager name	Code	Description	Status	Earliest dialect
SMBreadBraw				
SMB_COM_READ_MPX (section 2.2.4.23) SMBreadBmpx	0x1B	Multiplexed block read. Listed as SMBreadmpx in some documentation.	O	LANMAN1.0
SMB_COM_READ_MPX_SECONDARY (section 2.2.4.24) SMBreadBs	0x1C	Multiplexed block read, secondary request.	X	LANMAN1.0
SMB_COM_WRITE_RAW (section 2.2.4.25) SMBwriteBraw	0x1D	Write a block in raw mode.	D	CorePlus
SMB_COM_WRITE_MPX (section 2.2.4.26) SMBwriteBmpx	0x1E	Multiplexed block write.	O	LANMAN1.0
SMB_COM_WRITE_MPX_SECONDARY (section 2.2.4.27) SMBwriteBs	0x1F	Multiplexed block write, secondary request.	X	LANMAN1.0
SMB_COM_WRITE_COMPLETE (section 2.2.4.28) SMBwriteC	0x20	Raw block write, final response.	D	LANMAN1.0
SMB_COM_QUERY_SERVER (section 2.2.4.29)	0x21	Reserved, but not implemented. Also known as SMB_COM_QUERY_INFORMATION_SRV.	N	
SMB_COM_SET_INFORMATION2 (section 2.2.4.30) SMBsetattrE	0x22	Set an extended set of file attributes.	D	LANMAN1.0
SMB_COM_QUERY_INFORMATION2 (section 2.2.4.31) SMBgetattrE	0x23	Get an extended set of file attributes.	D	LANMAN1.0
SMB_COM_LOCKING_ANDX (section 2.2.4.32) SMBlockingX	0x24	Lock multiple byte ranges; AndX chaining.	C	LANMAN1.0
SMB_COM_TRANSACTION (section 2.2.4.33) SMBtrans	0x25	Transaction.	C	LANMAN1.0
SMB_COM_TRANSACTION_SECONDARY (section 2.2.4.34) SMBtranss	0x26	Transaction secondary request.	C	LANMAN1.0
SMB_COM_IOCTL (section 2.2.4.35) SMBioctl	0x27	Pass an I/O Control function request to the server.	O	LANMAN1.0

NT LAN Manager name and pre-NT LAN Manager name	Code	Description	Status	Earliest dialect
SMB_COM_IOCTL_SECONDARY (section 2.2.4.36) SMBioctl	0x28	IOCTL secondary request.	N	LANMAN1.0
SMB_COM_COPY (section 2.2.4.37) SMBcopy	0x29	Copy a file or directory.	X	LANMAN1.0
SMB_COM_MOVE (section 2.2.4.38) SMBmove	0x2A	Move a file or directory.	X	LANMAN1.0
SMB_COM_ECHO (section 2.2.4.39) SMBecho	0x2B	Echo request (ping).	C	LANMAN1.0
SMB_COM_WRITE_AND_CLOSE (section 2.2.4.40) SMBwriteclose	0x2C	Write to and close a file.	D	LANMAN1.0
SMB_COM_OPEN_ANDX (section 2.2.4.41) SMBopenX	0x2D	Extended file open with AndX chaining.	D	LANMAN1.0
SMB_COM_READ_ANDX (section 2.2.4.42) SMBreadX	0x2E	Extended file read with AndX chaining.	C	LANMAN1.0
SMB_COM_WRITE_ANDX (section 2.2.4.43) SMBwriteX	0x2F	Extended file write with AndX chaining.	C	LANMAN1.0
SMB_COM_NEW_FILE_SIZE (section 2.2.4.44)	0x30	Reserved, but not implemented. Also known as SMB_COM_SET_NEW_SIZE.	N	
SMB_COM_CLOSE_AND_TREE_DISC (section 2.2.4.45)	0x31	Close an open file and tree disconnect.	N	NT LANMAN
SMB_COM_TRANSACTION2 (section 2.2.4.46) SMBtrans2	0x32	Transaction 2 format request/response.	C	LANMAN1.2
SMB_COM_TRANSACTION2_SECONDARY (section 2.2.4.47) SMBtrans2	0x33	Transaction 2 secondary request.	C	LANMAN1.2
SMB_COM_FIND_CLOSE2 (section 2.2.4.48) SMBfindclose	0x34	Close an active search.	C	LANMAN1.2
SMB_COM_FIND_NOTIFY_CLOSE (section 2.2.4.49) SMBfindnclose	0x35	Notification of the closure of an active search.	N	LANMAN1.2
Unused	0x36			

NT LAN Manager name and pre-NT LAN Manager name	Code	Description	Status	Earliest dialect
	... 0x5F			
Reserved	0x60 ... 0x6F	This range of codes was reserved for use by the "xenix1.1" dialect of SMB. See [MSFT-XEXTNP] . [XOPEN-SMB] page 41 lists this range as "Reserved for proprietary dialects."	X	XENIX
SMB_COM_TREE_CONNECT (section 2.2.4.50) SMBtcon	0x70	Tree connect.	D	CORE
SMB_COM_TREE_DISCONNECT (section 2.2.4.51) SMBtdis	0x71	Tree disconnect.	C	CORE
SMB_COM_NEGOTIATE (section 2.2.4.52) SMBnegprot	0x72	Negotiate protocol dialect.	C	CORE
SMB_COM_SESSION_SETUP_ANDX (section 2.2.4.53) SMBsesssetupX	0x73	Session Setup with AndX chaining.	C	LANMAN1.0
SMB_COM_LOGOFF_ANDX (section 2.2.4.54) SMBulogoffX	0x74	User logoff with AndX chaining.	C	LANMAN1.2
SMB_COM_TREE_CONNECT_ANDX (section 2.2.4.55) SMBtconX	0x75	Tree connect with AndX chaining.	C	LANMAN1.0
Unused	0x76 ... 0x7D			
SMB_COM_SECURITY_PACKAGE_ANDX (section 2.2.4.56) SMBsecpkgX	0x7E	Negotiate security packages with AndX chaining.	X	LANMAN1.0
Unused	0x7F			
SMB_COM_QUERY_INFORMATION_DISK (section 2.2.4.57) SMBdskattr	0x80	Retrieve file system information from the server.	D	CORE
SMB_COM_SEARCH (section 2.2.4.58) SMBsearch	0x81	Directory wildcard search.	D	CORE
SMB_COM_FIND (section 2.2.4.59)	0x82	Start or continue an extended	D	LANMAN1.

NT LAN Manager name and pre-NT LAN Manager name	Code	Description	Status	Earliest dialect
SMBffirst		wildcard directory search.		0
SMB_COM_FIND_UNIQUE (section 2.2.4.60) SMBfunique	0x83	Perform a one-time extended wildcard directory search.	D	LANMAN1.0
SMB_COM_FIND_CLOSE (section 2.2.4.61) SMBfclose	0x84	End an extended wildcard directory search.	D	LANMAN1.0
Unused	0x85 ... 0x9F			
SMB_COM_NT_TRANSACT (section 2.2.4.62)	0xA0	NT format transaction request/response.	C	NT LANMAN
SMB_COM_NT_TRANSACT_SECONDARY (section 2.2.4.63)	0xA1	NT format transaction secondary request.	C	NT LANMAN
SMB_COM_NT_CREATE_ANDX (section 2.2.4.64)	0xA2	Create or open a file or a directory.	C	NT LANMAN
Unused	0xA3			
SMB_COM_NT_CANCEL (section 2.2.4.65)	0xA4	Cancel a request currently pending at the server.	C	NT LANMAN
SMB_COM_NT_RENAME (section 2.2.4.66)	0xA5	File rename with extended semantics.	O	NT LANMAN
Unused	0xA6 ... 0xBF			
SMB_COM_OPEN_PRINT_FILE (section 2.2.4.67) SMBsplopen	0xC0	Create a print queue spool file.	C	CORE
SMB_COM_WRITE_PRINT_FILE (section 2.2.4.68) SMBsplwr	0xC1	Write to a print queue spool file.	D	CORE
SMB_COM_CLOSE_PRINT_FILE (section 2.2.4.69) SMBsplclose	0xC2	Close a print queue spool file.	D	CORE
SMB_COM_GET_PRINT_QUEUE (section 2.2.4.70) SMBsplretq	0xC3	Request print queue information.	X	CORE
Unused	0xC			

NT LAN Manager name and pre-NT LAN Manager name	Code	Description	Status	Earliest dialect
	4 ... 0xCF			
Reserved	0xD 0 ... 0xD 7	Messenger Service command codes. This range is reserved for use by the SMB Messenger Service. See [MS-MSRPI] , and section 6 of [SMB-CORE] .	O	CORE
SMB_COM_READ_BULK (section 2.2.4.71)	0xD 8	Reserved, but not implemented.	N	
SMB_COM_WRITE_BULK (section 2.2.4.72)	0xD 9	Reserved, but not implemented.	N	
SMB_COM_WRITE_BULK_DATA (section 2.2.4.73)	0xD A	Reserved, but not implemented.	N	
Unused	0xD B ... 0xF D			
SMB_COM_INVALID (section 2.2.4.74) SMBinvalid	0xFE	As the name suggests, this command code is a designated invalid command and SHOULD NOT be used.	C	LANMAN1.0
SMB_COM_NO_ANDX_COMMAND (section 2.2.4.75)	0xFF	Also known as the "NIL" command. It identifies the end of an AndX Chain, and is only valid in that context. See section 2.2.3.4 .	C	LANMAN1.0

2.2.2.2 Transaction Subcommand Codes

Transaction Codes used with [SMB_COM_TRANSACTION \(section 2.2.4.46\)](#):

Name	Code	Description	Status	Earliest dialect
TRANS_MAILSLLOT_WRITE (section 2.2.5.12)	0x0001	Allows a client to write data to a specific mailslot on the server.	C	LANMAN1.0
TRANS_SET_NMPIPE_STATE (section 2.2.5.1)	0x0001	Used to set the read mode and non-blocking mode of a specified named pipe.	C	LANMAN1.0
TRANS_RAW_READ_NMPIPE (section 2.2.5.2)	0x0011	Allows for a raw read of data from a named pipe. This method of reading data from a named pipe ignores message boundaries even if the pipe was	D	LANMAN1.0

Name	Code	Description	Status	Earliest dialect
		set up as a message mode pipe.		
TRANS_QUERY_NMPIPE_STATE (section 2.2.5.3)	0x0021	Allows for a client to retrieve information about a specified named pipe.	C	LANMAN1.0
TRANS_QUERY_NMPIPE_INFO (section 2.2.5.4)	0x0022	Used to retrieve pipe information about a named pipe.	C	LANMAN1.0
TRANS_PEEK_NMPIPE (section 2.2.5.5)	0x0023	Used to copy data out of a named pipe without removing it from the named pipe.	C	LANMAN1.0
TRANS_TRANSACT_NMPIPE (section 2.2.5.6)	0x0026	Used to execute a transacted exchange against a named pipe. This transaction has a constraint that it can be used only on a duplex, message-type pipe.	C	LANMAN1.0
TRANS_RAW_WRITE_NMPIPE (section 2.2.5.7)	0x0031	Allows for a raw write of data to a named pipe. Raw writes to named pipes put bytes directly into a pipe, regardless of whether it is a message mode pipe or byte mode pipe.	D	LANMAN1.0
TRANS_READ_NMPIPE (section 2.2.5.8)	0x0036	Allows a client to read data from a named pipe.	C	NT LANMAN
TRANS_WRITE_NMPIPE (section 2.2.5.9)	0x0037	Allows a client to write data to a named pipe.	C	NT LANMAN
TRANS_WAIT_NMPIPE (section 2.2.5.10)	0x0053	Allows a client to be notified when the specified named pipe is available to be connected to.	C	LANMAN1.0
TRANS_CALL_NMPIPE (section 2.2.5.11)	0x0054	Connect to a named pipe, issue a write to the named pipe, issue a read from the named pipe, and close the named pipe.	C	LANMAN1.0

The meaning of the SMB_COM_TRANSACTION subcommand codes is defined by the resource being accessed. For example, the 0x0001 subcommand code is interpreted as TRANS_MAILSLLOT_WRITE if the operation is being performed on a mailslot. The same code is interpreted as a TRANS_SET_NMPIPE_STATE (section 2.2.5.1) if the operation is performed on a named pipe.

Transaction Codes used with SMB_COM_TRANSACTION2 (section 2.2.4.46):

Name	Code	Description	Status	Earliest dialect
TRANS2_OPEN2 (section 2.2.6.1)	0x0000	Open or create a file and set extended attributes on the file.	C	NT LANMAN
TRANS2_FIND_FIRST2 (section 2.2.6.2)	0x0001	Begin a search for files	C	NT LANMAN

Name	Code	Description	Status	Earliest dialect
		within a directory or for a directory.		
TRANS2_FIND_NEXT2 (section 2.2.6.3)	0x0002	Continue a search for files within a directory or for a directory.	C	NT LANMAN
TRANS2_QUERY_FS_INFORMATION (section 2.2.6.4)	0x0003	Request information about a file system on the server.	C	LANMAN2.0
TRANS2_SET_FS_INFORMATION (section 2.2.6.5)	0x0004		N	LANMAN2.0
TRANS2_QUERY_PATH_INFORMATION (section 2.2.6.6)	0x0005	Get information about a specific file or directory using a path.	C	LANMAN2.0
TRANS2_SET_PATH_INFORMATION (section 2.2.6.7)	0x0006	Set the standard and extended attribute information of a specific file or directory using a path.	C	LANMAN2.0
TRANS2_QUERY_FILE_INFORMATION (section 2.2.6.8)	0x0007	Get information about a specific file or directory using a FID .	C	LANMAN2.0
TRANS2_SET_FILE_INFORMATION (section 2.2.6.9)	0x0008	Set the standard and extended attribute information of a specific file or directory using a FID .	C	LANMAN2.0
TRANS2_FSCTL (section 2.2.6.10)	0x0009		N	LANMAN2.0
TRANS2_IOCTL2 (section 2.2.6.11)	0x000a		N	NT LANMAN
TRANS2_FIND_NOTIFY_FIRST (section 2.2.6.12)	0x000b		X	LANMAN2.0
TRANS2_FIND_NOTIFY_NEXT (section 2.2.6.13)	0x000c		X	LANMAN2.0
TRANS2_CREATE_DIRECTORY (section 2.2.6.14)	0x000d	Create a new directory and optionally set the extended attribute information.	C	LANMAN2.0
TRANS2_SESSION_SETUP (section 2.2.6.15)	0x000e		N	NT LANMAN
TRANS2_GET_DFS_REFERRAL (section 2.2.6.16)	0x0010	Request a DFS referral for a file or directory. See [MS-DFSC] section 2.2.2 for details.	C	NT LANMAN

Name	Code	Description	Status	Earliest dialect
TRANS2_REPORT_DFS_INCONSISTENCY (section 2.2.6.17)	0x0011		N	NT LANMAN

Transaction codes used with [SMB_COM_NT_TRANSACT](#) (section 2.2.4.62):

Name	Code	Description	Status	Earliest dialect
NT_TRANSACT_CREATE (section 2.2.7.1)	0x0001	Used to create or open a file or directory when extended attributes (EAs) or a security descriptor (SD) are to be applied.	C	NT LANMAN
NT_TRANSACT_IOCTL (section 2.2.7.2)	0x0002	Allows device and file system control functions to be transferred transparently from client to server.	C	NT LANMAN
NT_TRANSACT_SET_SECURITY_DESC (section 2.2.7.3)	0x0003	Allows a client to change the security descriptor for a file.	C	NT LANMAN
NT_TRANSACT_NOTIFY_CHANGE (section 2.2.7.4)	0x0004	Notifies the client when the directory specified by FID is modified. It also returns the names of any files that changed.	C	NT LANMAN
NT_TRANSACT_RENAME (section 2.2.7.5)	0x0005		N	
NT_TRANSACT_QUERY_SECURITY_DESC (section 2.2.7.6)	0x0006	Allows a client to retrieve the security descriptor for a file.	C	NT LANMAN

2.2.2.3 Information Level Codes

The SMB protocol uses information levels in several Transaction2 subcommands to allow clients to query or set information about files, devices, and underlying object stores on servers. The following lists of information levels are organized based on their intended purpose: finding files or devices and related information, querying a specific file or device for information, setting file or device information, and querying object store information.

A small number of information levels (most notably SMB_INFO_STANDARD and the other LANMAN2.0 information levels) share the same name across multiple categories. This indicates that these information levels share similar, or at times identical, structures, but are distinct in their intended purposes.

2.2.2.3.1 FIND Information Level Codes

FIND information levels are used in [TRANS2_FIND_FIRST2](#) (section 2.2.6.2) and [TRANS2_FIND_NEXT2](#) (section 2.2.6.3) subcommand requests to indicate the level of information that a server MUST respond with for each file matching the request's search criteria.

Name	Code	Meaning	Dialect
SMB_INFO_STANDARD	0x0001	Return creation, access, and last write timestamps, size and file attributes along with the file name.	LANMAN2.0
SMB_INFO_QUERY_EA_SIZE	0x0002	Return the SMB_INFO_STANDARD data along with the size of a file's extended attributes (EAs).	LANMAN2.0
SMB_INFO_QUERY_EAS_FROM_LIST	0x0003	Return the SMB_INFO_QUERY_EA_SIZE data along with a specific list of a file's EAs. The requested EAs are provided in the Trans2_Data block of the request.	LANMAN2.0
SMB_FIND_FILE_DIRECTORY_INFO	0x0101	Return 64-bit format versions of: creation, access, last write, and last attribute change timestamps; size. In addition, return extended file attributes and file name.	NT LANMAN
SMB_FIND_FILE_FULL_DIRECTORY_INFO	0x0102	Returns the SMB_FIND_FILE_DIRECTORY_INFO data along with the size of a file's EAs.	NT LANMAN
SMB_FIND_FILE_NAMES_INFO	0x0103	Returns the name(s) of the file(s).	NT LANMAN
SMB_FIND_FILE_BOTH_DIRECTORY_INFO	0x0104	Returns a combination of the data from SMB_FIND_FILE_FULL_DIRECTORY_INFO and SMB_FIND_FILE_NAMES_INFO.	NT LANMAN

2.2.2.3.2 QUERY_FS Information Level Codes

QUERY_FS information levels are used in [TRANS2_QUERY_FS_INFORMATION \(section 2.2.6.4\)](#) subcommand requests to indicate the level of information that a server MUST respond with for the underlying object store indicated in the request.

Name	Code	Meaning	Dialect
SMB_INFO_ALLOCATION	0x0001	Query file system allocation unit information.	LANMAN2.0
SMB_INFO_VOLUME	0x0002	Query volume name and serial number.	LANMAN2.0
SMB_QUERY_FS_VOLUME_INFO	0x0102	Query the creation timestamp, serial number, and Unicode-encoded volume label.	NT LANMAN
SMB_QUERY_FS_SIZE_INFO	0x0103	Query 64-bit file system allocation unit information.	NT LANMAN
SMB_QUERY_FS_DEVICE_INFO	0x0104	Query a file system's underlying device type and characteristics.	NT LANMAN
SMB_QUERY_FS_ATTRIBUTE_INFO	0x0105	Query file system attributes.	NT LANMAN

2.2.2.3.3 QUERY Information Level Codes

QUERY information levels are used in [TRANS2_QUERY_PATH_INFORMATION \(section 2.2.6.6\)](#) and [TRANS2_QUERY_FILE_INFORMATION \(section 2.2.6.8\)](#) subcommand requests to indicate the level of information that a server MUST respond with for the file or directory indicated in the request.

Name	Code	Description	Dialect
SMB_INFO_STANDARD	0x0001	Query creation, access, and last write timestamps, size and file attributes.	LANMAN2.0
SMB_INFO_QUERY_EA_SIZE	0x0002	Query the SMB_INFO_STANDARD data along with the size of the file's extended attributes (EAs).	LANMAN2.0
SMB_INFO_QUERY_EAS_FROM_LIST	0x0003	Query a file's specific EAs by attribute name.	LANMAN2.0
SMB_INFO_QUERY_ALL_EAS	0x0004	Query all of a file's EAs.	LANMAN2.0
SMB_INFO_IS_NAME_VALID	0x0006	Validate the syntax of the path provided in the request. Not supported for TRANS2_QUERY_FILE_INFORMATION.	LANMAN2.0
SMB_QUERY_FILE_BASIC_INFO	0x0101	Query 64-bit create, access, write, and change timestamps along with extended file attributes.	NT LANMAN
SMB_QUERY_FILE_STANDARD_INFO	0x0102	Query size, number of links, if a delete is pending, and if the path is a directory.	NT LANMAN
SMB_QUERY_FILE_EA_INFO	0x0103	Query the size of the file's EAs.	NT LANMAN
SMB_QUERY_FILE_NAME_INFO	0x0104	Query the long file name in Unicode format.	NT LANMAN
SMB_QUERY_FILE_ALL_INFO	0x0107	Query the SMB_QUERY_FILE_BASIC_INFO, SMB_FILE_QUERY_STANDARD_INFO, SMB_FILE_EA_INFO, and SMB_QUERY_FILE_NAME_INFO data as well as access flags, access mode, and alignment information in a single request.	NT LANMAN
SMB_QUERY_FILE_ALT_NAME_INFO	0x0108	Query the 8.3 file name. <22>	NT LANMAN
SMB_QUERY_FILE_STREAM_INFO	0x0109	Query file stream information.	NT LANMAN
SMB_QUERY_FILE_COMPRESSION_INFO	0x010B	Query file compression information.	NT LANMAN

2.2.2.3.4 SET Information Level Codes

SET information levels are used in [TRANS2_SET_PATH_INFORMATION \(section 2.2.6.7\)](#) and [TRANS2_SET_FILE_INFORMATION \(section 2.2.6.9\)](#) subcommand requests to indicate what level of information is being set on the file or directory in the request.

Name	Code	Description	Dialect
SMB_INFO_STANDARD	0x0001	Set creation, access, and last write timestamps.	LANMAN2.0
SMB_INFO_SET_EAS	0x0002	Set a specific list of extended attributes (EAs).	LANMAN2.0
SMB_SET_FILE_BASIC_INFO	0x0101	Set 64-bit create, access, write, and change timestamps along with extended file attributes. Not supported for TRANS2_SET_PATH_INFORMATION (section 2.2.6.7).	NT LANMAN
SMB_SET_FILE_DISPOSITION_INFO	0x0102	Set whether or not the file is marked for deletion. Not supported for TRANS2_SET_PATH_INFORMATION (section 2.2.6.7).	NT LANMAN
SMB_SET_FILE_ALLOCATION_INFO	0x0103	Set file allocation size. Not supported for TRANS2_SET_PATH_INFORMATION (section 2.2.6.7).	NT LANMAN
SMB_SET_FILE_END_OF_FILE_INFO	0x0104	Set file EOF offset. Not supported for TRANS2_SET_PATH_INFORMATION (section 2.2.6.7).	NT LANMAN

2.2.2.4 SMB Error Classes and Codes

This section provides an overview of status codes that can be returned by the SMB commands listed in this document, including mappings between the NTSTATUS codes used in the NT LAN Manager dialect, the SMBSTATUS class/code pairs used in earlier SMB dialects, and common POSIX equivalents. The POSIX error code mappings are based upon those used in the Xenix server implementation. This is not an exhaustive listing and MUST NOT be considered normative.

Each command and subcommand description also includes a list of status codes that are returned by CIFS-compliant servers. Individual implementations can return status codes from their underlying operating systems; it is up to the implementer to decide how to interpret those status codes.

The listing below is organized by SMBSTATUS Error Class. It shows SMBSTATUS Error Code values and a general description, as well as mappings from NTSTATUS values ([\[MS-ERREF\]](#) section 2.3.1) and POSIX-style error codes where possible. Note that multiple NTSTATUS values can map to a single SMBSTATUS value.

SUCCESS Class 0x00

Error code	NTSTATUS values	POSIX equivalent	Description
SUCCESS 0x0000	STATUS_OK	0	Everything worked, no problems.

ERRDOS Class 0x01

Error code	NTSTATUS values	POSIX equivalent	Description
ERRbadfunc 0x0001	STATUS_NOT_IMPLEMENTED 0xC0000002 STATUS_INVALID_DEVICE_REQUEST 0xC0000010 STATUS_ILLEGAL_FUNCTION 0xC00000AF	EINVAL	Invalid Function.
ERRbadfile 0x0002	STATUS_NO_SUCH_FILE 0xC000000F STATUS_NO_SUCH_DEVICE 0xC000000E STATUS_OBJECT_NAME_NOT_FOUND 0xC0000034	ENOENT	File not found.
ERRbadpath 0x0003	STATUS_OBJECT_PATH_INVALID 0xC0000039 STATUS_OBJECT_PATH_NOT_FOUND 0xC000003A STATUS_OBJECT_PATH_SYNTAX_BAD 0xC000003B STATUS_DFS_EXIT_PATH_FOUND 0xC000009B STATUS_REDIRATOR_NOT_STARTED 0xC00000FB	ENOENT	A component in the path prefix is not a directory.
ERRnofids 0x0004	STATUS_TOO_MANY_OPENED_FILES 0xC000011F	EMFILE	Too many open files. No FIDs are available.
ERRnoaccess 0x0005	STATUS_ACCESS_DENIED 0xC0000022 STATUS_INVALID_LOCK_SEQUENCE 0xC000001E STATUS_INVALID_VIEW_SIZE 0xC000001F STATUS_ALREADY_COMMITTED 0xC0000021 STATUS_PORT_CONNECTION_REFUSED 0xC0000041 STATUS_THREAD_IS_TERMINATING 0xC000004B STATUS_DELETE_PENDING	EPERM	Access denied.

Error code	NTSTATUS values	POSIX equivalent	Description
	0xC0000056 STATUS_PRIVILEGE_NOT_HELD 0xC0000061 STATUS_LOGON_FAILURE 0xC000006D STATUS_FILE_IS_A_DIRECTORY 0xC00000BA STATUS_FILE_RENAMED 0xC00000D5 STATUS_PROCESS_IS_TERMINATING 0xC000010A STATUS_DIRECTORY_NOT_EMPTY 0xC0000101 STATUS_CANNOT_DELETE 0xC0000121 STATUS_FILE_DELETED 0xC0000123		
ERRbadfid 0x0006	STATUS_SMB_BAD_FID 0x00060001 STATUS_INVALID_HANDLE 0xC0000008 STATUS_OBJECT_TYPE_MISMATCH 0xC0000024 STATUS_PORT_DISCONNECTED 0xC0000037 STATUS_INVALID_PORT_HANDLE 0xC0000042 STATUS_FILE_CLOSED 0xC0000128 STATUS_HANDLE_NOT_CLOSABLE 0xC0000235	EBADF	Invalid FID.
ERRbadmcb 0x0007			Memory Control Blocks were destroyed.
ERRnomem 0x0008	STATUS_SECTION_TOO_BIG 0xC0000040 STATUS_TOO_MANY_PAGING_FILES 0xC0000097 STATUS_INSUFF_SERVER_RESOURCES 0xC0000205	ENOMEM	Insufficient server memory to perform the requested operation.

Error code	NTSTATUS values	POSIX equivalent	Description
ERRbadmem 0x0009		EFAULT	The server performed an invalid memory access (invalid address).
ERRbadenv 0x000A			Invalid environment.
ERRbadformat 0x000B			Invalid format.
ERRbadaccess 0x000C	STATUS_OS2_INVALID_ACCESS 0x000C0001 STATUS_ACCESS_DENIED 0xC00000CA		Invalid open mode.
ERRbaddata 0x000D	STATUS_DATA_ERROR 0xC000009C	E2BIG	Bad data. (May be generated by IOCTL calls on the server.)
ERRbaddrive 0x000F		ENXIO	Invalid drive specified.
ERRremcd 0x0010	STATUS_DIRECTORY_NOT_EMPTY 0xC0000101		Remove of directory failed because it was not empty.
ERRdiffdevice 0x0011	STATUS_NOT_SAME_DEVICE 0xC00000D4	EXDEV	A file system operation (such as a rename) across two devices was attempted.
ERRnofiles 0x0012	STATUS_NO_MORE_FILES 0x80000006		No (more) files found following a file search command.

Error code	NTSTATUS values	POSIX equivalent	Description
ERRgeneral 0x001F	STATUS_UNSUCCESSFUL 0xC0000001		General error.
ERRbadshare 0x0020	STATUS_SHARING_VIOLATION 0xC0000043	ETXTBSY	Sharing violation. A requested open mode conflicts with the sharing mode of an existing file handle.
ERRlock 0x0021	STATUS_FILE_LOCK_CONFLICT 0xC0000054 STATUS_LOCK_NOT_GRANTED 0xC0000055	EDEADLOCK	A lock request specified an invalid locking mode, or conflicted with an existing file lock.
ERReof 0x0026	STATUS_END_OF_FILE 0xC0000011	EEOF	Attempted to read beyond the end of the file.
ERRrunsup 0x0032	STATUS_NOT_SUPPORTED 0XC00000BB		This command is not supported by the server.
ERRfileexists 0x0050	STATUS_OBJECT_NAME_COLLISION 0xC0000035	EEXIST	An attempt to create a file or directory failed because an object with the same pathname already exists.
ERRinvalidparam 0x0057	STATUS_INVALID_PARAMETER 0xC000000D		A parameter supplied with the message is

Error code	NTSTATUS values	POSIX equivalent	Description
			invalid.
ERRunknownlevel 0x007C	STATUS_OS2_INVALID_LEVEL 0x007C0001		Invalid information level.
ERRinvalidseek 0x0083	STATUS_OS2_NEGATIVE_SEEK 0x00830001		An attempt was made to seek to a negative absolute offset within a file.
ERROR_NOT_LOCKED 0x009E	STATUS_RANGE_NOT_LOCKED 0xC000007E		The byte range specified in an unlock request was not locked.
ERROR_NO_MORE_SEARCH_HANDLES 0x0071	STATUS_OS2_NO_MORE_SIDS 0x00710001		Maximum number of searches has been exhausted.
ERROR_CANCEL_VIOLATION 0x00AD	STATUS_OS2_CANCEL_VIOLATION 0x00AD0001		No lock request was outstanding for the supplied cancel region.
ERROR_ATOMIC_LOCKS_NOT_SUPPORTED 0x00AE	STATUS_OS2_ATOMIC_LOCKS_NOT_SUPPORTED 0x00AE0001		The file system does not support atomic changes to the lock type.
ERRbadpipe 0x00E6	STATUS_INVALID_INFO_CLASS 0xC0000003 STATUS_INVALID_PIPE_STATE 0xC00000AD STATUS_INVALID_READ_MODE 0xC00000B4		Invalid named pipe.

Error code	NTSTATUS values	POSIX equivalent	Description
ERROR_CANNOT_COPY 0x010A	STATUS_OS2_CANNOT_COPY 0x010A0001		The copy functions cannot be used.
ERRpipebusy 0x00E7	STATUS_INSTANCE_NOT_AVAILABLE 0xC00000AB STATUS_PIPE_NOT_AVAILABLE 0xC00000AC STATUS_PIPE_BUSY 0xC00000AE		All instances of the designated named pipe are busy.
ERRpipeclosing 0x00E8	STATUS_PIPE_CLOSING 0xC00000B1 STATUS_PIPE_EMPTY 0xC00000D9		The designated named pipe is in the process of being closed.
ERRnotconnected 0x00E9	STATUS_PIPE_DISCONNECTED 0xC00000B0		The designated named pipe exists, but there is no server process listening on the server side.
ERRmoredata 0x00EA	STATUS_BUFFER_OVERFLOW 0x80000005 STATUS_MORE_PROCESSING_REQUIRED 0xC0000016		There is more data available to read on the designated named pipe.
ERRbadealist 0x00FF			Inconsistent extended attribute list.
ERROR_EAS_DIDNT_FIT 0x0113	STATUS_EA_TOO_LARGE 0xC0000050 STATUS_OS2_EAS_DIDNT_FIT 0x01130001		Either there are no extended attributes,

Error code	NTSTATUS values	POSIX equivalent	Description
			or the available extended attributes did not fit into the response.
ERROR_EAS_NOT_SUPPORTED 0x011A	STATUS_EAS_NOT_SUPPORTED 0xC000004F		The server file system does not support Extended Attributes.
ERROR_EA_ACCESS_DENIED 0x03E2	STATUS_OS2_EA_ACCESS_DENIED 0x03E20001		Access to the extended attribute was denied.
ERR_NOTIFY_ENUM_DIR 0x03FE	STATUS_NOTIFY_ENUM_DIR 0x0000010C		More changes have occurred within the directory than will fit within the specified Change Notify response buffer.

ERRSRV Class 0x02

Error code	NTSTATUS values	POSIX equivalent	Description
ERRerror 0x0001	STATUS_INVALID_SMB 0x00010002		Unspecified server error. <23>
ERRbadpw 0x0002	STATUS_WRONG_PASSWORD 0xC000006A		Invalid password.
ERRbadpath 0x0003	STATUS_PATH_NOT_COVERED 0xC0000257		DFS pathname not on local server.
ERRaccess 0x0004	STATUS_NETWORK_ACCESS_DENIED 0xC00000CA	EACCES	Access denied. The specified UID does not have permission to execute the

Error code	NTSTATUS values	POSIX equivalent	Description
			requested command within the current context (TID).
ERRinvtid 0x0005	STATUS_NETWORK_NAME_DELETED 0xC00000C9 STATUS_SMB_BAD_TID 0x00050002		The TID specified in the command was invalid. Earlier documentation, with the exception of [SNIA] , refers to this error code as ERRinvid (Invalid Network Path Identifier). [SNIA] uses both names. <24>
ERRinvnetname 0x0006	STATUS_BAD_NETWORK_NAME 0xC00000CC		Invalid server name in Tree Connect.
ERRinvdevice 0x0007	STATUS_BAD_DEVICE_TYPE 0xC00000CB		A printer request was made to a non-printer device or, conversely, a non-printer request was made to a printer device.
ERRinvsess 0x0010			Invalid Connection ID (CID). This error code is only defined when the Direct IPX connectionless transport is in use.
ERRworking 0x0011			A command with matching MID or SequenceNumber is currently being processed. This error code is defined only when the Direct IPX connectionless transport is in use.
ERRnotme 0x0012			Incorrect NetBIOS Called Name when starting an SMB session over Direct IPX. This error code is only defined when the Direct IPX connectionless transport is in use.
ERRbadcmd	STATUS_SMB_BAD_COMMAND		An unknown SMB

Error code	NTSTATUS values	POSIX equivalent	Description
0x0016	0x00160002		command code was received by the server.
ERRqfull 0x0031	STATUS_PRINT_QUEUE_FULL 0xC00000C6		Print queue is full - too many queued items.
ERRqtoobig 0x0032	STATUS_NO_SPOOL_SPACE 0xC00000C7		Print queue is full - no space for queued item, or queued item too big.
ERRqeof 0x0033			End Of File on print queue dump.
ERRinvpfid 0x0034	STATUS_PRINT_CANCELLED 0xC00000C8		Invalid FID for print file.
ERRsmbcmd 0x0040	STATUS_NOT_IMPLEMENTED 0xC0000002		Unrecognized SMB command code.
ERRsrverror 0x0041	STATUS_UNEXPECTED_NETWORK_ERROR 0xC00000C4		Internal server error.
ERRfilespecs 0x0043			The FID and pathname contain incompatible values.
ERRbadpermits 0x0045	STATUS_NETWORK_ACCESS_DENIED 0xC00000CA		An invalid combination of access permissions for a file or directory was presented. The server cannot set the requested attributes.
ERRsetattrmode 0x0047			The attribute mode presented in a set mode request was invalid.
ERRtimeout 0x0058	STATUS_UNEXPECTED_NETWORK_ERROR 0xC00000C4 STATUS_IO_TIMEOUT 0xC00000B5		Operation timed out.
ERRnoresource 0x0059	STATUS_REQUEST_NOT_ACCEPTED 0xC00000D0		No resources currently available for this SMB request.
ERRtoomanyuids 0x005A	STATUS_TOO_MANY_SESSIONS 0xC00000CE		Too many UIDs active for this SMB connection .

Error code	NTSTATUS values	POSIX equivalent	Description
ERRbaduid 0x005B	STATUS_SMB_BAD_UID 0x005B0002		The UID specified is not known as a valid ID on this server session.
ERRnotconnected 0x00E9	STATUS_PIPE_DISCONNECTED 0xC00000B0	EPIPE	Write to a named pipe with no reader.
ERRusempx 0x00FA	STATUS_SMB_USE_MPX 0x00FA0002		Temporarily unable to support RAW mode transfers. Use MPX mode.
ERRusestd 0x00FB	STATUS_SMB_USE_STANDARD 0x00FB0002		Temporarily unable to support RAW or MPX mode transfers. Use standard read/write.
ERRcontmpx 0x00FC	STATUS_SMB_CONTINUE_MPX 0x00FC0002		Continue in MPX mode. This error code is reserved for future use.
ERRaccountExpired 0x08BF	STATUS_ACCOUNT_DISABLED 0xC0000072 STATUS_ACCOUNT_EXPIRED 0xC0000193		User account on the target machine is disabled or has expired.
ERRbadClient 0x08C0	STATUS_INVALID_WORKSTATION 0xC0000070		The client does not have permission to access this server.
ERRbadLogonTime 0x08C1	STATUS_INVALID_LOGON_HOURS 0xC000006F		Access to the server is not permitted at this time.
ERRpasswordExpired 0x08C2	STATUS_PASSWORD_EXPIRED 0xC0000071 STATUS_PASSWORD_MUST_CHANGE 0xC0000224		The user's password has expired.
ERRnosupport 0xFFFF	STATUS_SMB_NO_SUPPORT 0xFFFF0002		Function not supported by the server.

ERRHRD Class 0x03

Error code	NTSTATUS values	POSIX equivalent	Description
ERRnowrite 0x0013	STATUS_MEDIA_WRITE_PROTECTED 0xC00000A2	EROFS	Attempt to modify a read-only file system.

Error code	NTSTATUS values	POSIX equivalent	Description
ERRbadunit 0x0014		ENODEV	Unknown unit.
ERRnotready 0x0015	STATUS_NO_MEDIA_IN_DEVICE 0xC0000013	EUCLEAN	Drive not ready.
ERRbadcmd 0x0016	STATUS_INVALID_DEVICE_STATE 0xC0000184		Unknown command.
ERRdata 0x0017	STATUS_DATA_ERROR 0xC000003E STATUS_CRC_ERROR 0xC000003F	EIO	Data error (incorrect CRC).
ERRbadreq 0x0018	STATUS_DATA_ERROR 0xC000003E	ERANGE	Bad request structure length.
ERRseek 0x0019			Seek error.
ERRbadmedia 0x001A	STATUS_DISK_CORRUPT_ERROR 0xC0000032		Unknown media type.
ERRbadsector 0x001B	STATUS_NONEXISTENT_SECTOR 0xC0000015		Sector not found.
ERRnopaper 0x001C	STATUS_DEVICE_PAPER_EMPTY 0x8000000E		Printer out of paper.
ERRwrite 0x001D			Write fault.
ERRread 0x001E			Read fault.
ERRgeneral 0x001F			General hardware failure.
ERRbadshare 0x0020	STATUS_SHARING_VIOLATION 0xC0000043	ETXTBSY	An attempted open operation conflicts with an existing open.
ERRlock 0x0021	STATUS_FILE_LOCK_CONFLICT 0xC0000054	EDEADLOCK	A lock request specified an invalid locking mode, or conflicted with an existing file lock.
ERRwrongdisk 0x0022	STATUS_WRONG_VOLUME 0xC0000012		The wrong disk was found in a drive.
ERRFCBUnavail 0x0023			No server-side File Control Blocks are available to

Error code	NTSTATUS values	POSIX equivalent	Description
			process the request.
ERRsharebufexc 0x0024			A sharing buffer has been exceeded.
ERRdiskfull 0x0027	STATUS_DISK_FULL 0xC000007F	ENOSPC	No space on file system.

ERRCMD Class 0xFF

The ERRCMD error class is used to indicate that the server received a command that was not in the SMB format. No error codes are defined for use with the ERRCMD (0xFF) class. [<25>](#)

2.2.2.5 Data Buffer Format Codes

Data buffer format codes are used to identify the type and format of the fields that immediately follow them in the data block of SMB messages. See section [2.2.3.3](#) for a description of the data block.

In **Core Protocol** commands, every field in the data block (following the **ByteCount** field) is preceded by a one-byte buffer format field. Commands introduced in dialects subsequent to the **Core Protocol** typically do not include buffer format fields unless they are intended as an extension to an existing command. For example, [SMB_COM_FIND \(section 2.2.4.59\)](#) was introduced in the **LAN Manager 1.0** dialect in order to improve the semantics of the [SMB_COM_SEARCH \(section 2.2.4.58\)](#) **Core Protocol** command. Both commands share the same request and response message structures, including the buffer format fields.

Data block fields that are preceded by buffer format codes take one of two basic forms:

- A null-terminated string or
- A structure consisting of a two-byte length field followed by an array of bytes:

```
struct
{
    USHORT Length;
    UCHAR Data[Length];
}
```

Buffer format code	Name	Format of the field that follows
0x01	Data Buffer	A two-byte USHORT value indicating the length of the data buffer. The data buffer follows immediately after the length field.
0x02	Dialect String	A null-terminated OEM_STRING . This format code is used only in the SMB_COM_NEGOTIATE (section 2.2.4.52) command to identify SMB dialect strings.
0x03	Pathname	A null-terminated string representing a file system path. In the NT LAN Manager dialect, the string is of type SMB_STRING unless otherwise specified.

Buffer format code	Name	Format of the field that follows
0x04	SMB String	A null-terminated string. In the NT LAN Manager dialect, the string is of type SMB_STRING unless otherwise specified.
0x05	Variable Block	A two-byte USHORT value indicating the length of the variable block. The variable block follows immediately after the length field.

2.2.3 SMB Message Structure

SMB Messages are divisible into three parts:

- A fixed-length header
- A variable length parameter block
- A variable length data block

The header identifies the message as an SMB message, specifies the command to be executed, and provides context. In a response message, the header also includes status information that indicates whether (and how) the command succeeded or failed.

The parameter block is a short array of two-byte values (words), while the data block is an array of up to 64 KB in size. The structure and contents of these blocks are specific to each SMB message.

SMB messages are structured this way because the protocol was originally conceived of as a rudimentary remote procedure call system. The parameter values were meant to represent the parameters passed into a function. The data section would contain larger structures or data buffers, such as the block of data to be written using an SMB_COM_WRITE command. Although the protocol has evolved over time, this differentiation has been generally maintained.

2.2.3.1 The SMB Header

The SMB_Header structure is a fixed 32-bytes in length.

```
SMB_Header
{
    UCHAR Protocol[4];
    UCHAR Command;
    SMB_ERROR Status;
    UCHAR Flags;
    USHORT Flags2;
    USHORT PIDHigh;
    UCHAR SecurityFeatures[8];
    USHORT Reserved;
    USHORT TID;
    USHORT PIDLow;
    USHORT UID;
    USHORT MID;
}
```

0	1	2	3	4	5	6	7	8	9	10	11	12	13	14	15	16	17	18	19	20	21	22	23	24	25	26	27	28	29	30	31
Protocol																															
Command										Status																					
...										Flags										Flags2											
PIDHigh																SecurityFeatures															
...																															
...																Reserved															
TID																PIDLow															
UID																MID															

Protocol (4 bytes): This field MUST contain the 4-byte literal string '\xFF', 'S', 'M', 'B', with the letters represented by their respective ASCII values in the order shown. In the earliest available SMB documentation, this field is defined as a one byte message type (0xFF) followed by a three byte server type identifier.

Command (1 byte): A one-byte command code. Defined SMB command codes are listed in section [2.2.2.1](#).

Status (4 bytes): A 32-bit field used to communicate error messages from the server to the client.

Flags (1 byte): An 8-bit field of 1-bit flags describing various features in effect for the message.

Name and bitmask	Description	Earliest dialect
SMB_FLAGS_LOCK_AND_READ_OK 0x01	This bit is set (1) in the SMB_COM_NEGOTIATE (0x72) Response (section 2.2.4.52.2) if the server supports SMB_COM_LOCK_AND_READ (0x13) (section 2.2.4.20) and SMB_COM_WRITE_AND_UNLOCK (0x14) (section 2.2.4.21) commands.	LANMAN1.0
SMB_FLAGS_BUF_AVAIL 0x02	Obsolete When set (on an SMB request being sent to the server), the client guarantees that there is a receive buffer posted such that a send without acknowledgment can be used by the server to respond to the client's request. This behavior is specific to an obsolete	LANMAN1.0

Name and bitmask	Description	Earliest dialect
	transport. This bit MUST be set to zero by the client and MUST be ignored by the server.	
Reserved 0x04	This flag MUST be set to zero by the client and MUST be ignored by the server.	LANMAN1.0
SMB_FLAGS_CASE_INSENSITIVE 0x08	Obsolete If this bit is set then all pathnames in the SMB SHOULD be treated as case-insensitive. <26>	LANMAN1.0
SMB_FLAGS_CANONICALIZED_PATHS 0x10	Obsolescent When set in session setup, this bit indicates that all paths sent to the server are already in canonical format. That is, all file and directory names are composed of valid file name characters in all upper-case, and that the path segments are separated by backslash characters ('\').	LANMAN1.0
SMB_FLAGS_OPLOCK 0x20	Obsolescent This bit has meaning only in the deprecated SMB_COM_OPEN (0x02) Request (section 2.2.4.3.1) , SMB_COM_CREATE (0x03) Request (section 2.2.4.4.1) , and SMB_COM_CREATE_NEW (0x0F) Request (section 2.2.4.16.1) messages, where it is used to indicate that the client is requesting an Exclusive OpLock. It SHOULD be set to zero by the client, and ignored by the server, in all other SMB requests. If the server grants this OpLock request, then this bit SHOULD remain set in the corresponding response SMB to indicate to the client that the OpLock request was granted.	LANMAN1.0
SMB_FLAGS_OPBATCH 0x40	Obsolescent This bit has meaning only in the deprecated SMB_COM_OPEN (0x02) Request (section 2.2.4.3.1) , SMB_COM_CREATE (0x03) Request (section 2.2.4.4.1) , and SMB_COM_CREATE_NEW (0x0F) Request (section 2.2.4.16.1) messages, where it is used to indicate that the client is requesting a Batch OpLock. It SHOULD be set to zero by the client, and ignored by the server, in all other SMB requests. If the server grants this OpLock request, then this bit SHOULD remain set in the corresponding response SMB to indicate to the client that the OpLock request was	LANMAN1.0

Name and bitmask	Description	Earliest dialect
	granted. If the SMB_FLAGS_OPLOCK bit is clear (0), then the SMB_FLAGS_OPBATCH bit is ignored.	
SMB_FLAGS_REPLY 0x80	When on, this message is being sent from the server in response to a client request. The Command field usually contains the same value in a protocol request from the client to the server as in the matching response from the server to the client. This bit unambiguously distinguishes the message as a server response.	LANMAN1.0

Flags2 (2 bytes): A 16-bit field of 1-bit flags that represent various features in effect for the message. Unspecified bits are reserved and MUST be zero.

Name and bitmask	Description	Earliest dialect
SMB_FLAGS2_LONG_NAMES 0x0001	If the bit is set, the message MAY contain long file names. If the bit is clear then file names in the message MUST adhere to the 8.3 naming convention. If set in a client request for directory enumeration, the server MAY return long names (that is, names that are not 8.3 names) in the response to this request. If not set in a client request for directory enumeration, the server MUST return only 8.3 names in the response to this request. This flag indicates that in a direct enumeration request, paths returned by the server are not restricted to 8.3 names format. This bit field SHOULD be set to 1 when the negotiated dialect is LANMAN2.0 or later.	LANMAN2.0
SMB_FLAGS2_EAS 0x0002	If the bit is set, the client is aware of extended attributes (EAs). The client MUST set this bit if the client is aware of extended attributes. In response to a client request with this flag set, a server MAY include extended attributes in the response. This bit field SHOULD be set to 1 when the negotiated dialect is LANMAN2.0 or later.	LANMAN1.2
SMB_FLAGS2_SMB_SECURITY_SIGNATURE 0x0004	If set by the client, the client is requesting signing (if signing is not yet active) or the message being sent	NT LANMAN

Name and bitmask	Description	Earliest dialect
	<p>is signed. This bit is used on the SMB header of an SMB_COM_SESSION_SETUP_ANDX (section 2.2.4.53) client request to indicate that the client supports signing and that the server can choose to enforce signing on the connection based on its configuration.</p> <p>To turn on signing for a connection, the server MUST set this flag and also sign the SMB_COM_SESSION_SETUP_ANDX Response (section 2.2.4.53), after which all of the traffic on the connection (except for OpLock Break notifications) MUST be signed. In the SMB header of other CIFS client requests, the setting of this bit indicates that the packet has been signed. This bit field SHOULD be set to 1 when the negotiated dialect is NT LANMAN or later.</p>	
SMB_FLAGS2_IS_LONG_NAME 0x0040	Reserved but not implemented.	NT LANMAN
SMB_FLAGS2_DFS 0x1000	If the bit is set, any pathnames in this SMB SHOULD be resolved in the Distributed File System (DFS).	NT LANMAN
SMB_FLAGS2_PAGING_IO 0x2000	<p>This flag is useful only on a read request. If the bit is set, then the client MAY read the file if the client does not have read permission but does have execute permission. This bit field SHOULD be set to 1 when the negotiated dialect is LANMAN2.0 or later. This bit field SHOULD be set to 1 when the negotiated dialect is LANMAN2.0 or later. This flag is also known as SMB_FLAGS2_READ_IF_EXECUTE.</p>	NT LANMAN
SMB_FLAGS2_NT_STATUS 0x4000	<p>If this bit is set in a client request, the server MUST return errors as 32-bit NTSTATUS codes in the response. If it is clear, the server SHOULD return errors in SMBSTATUS format.</p> <p>If this bit is set in the server response, the Status field in the header is formatted as an NTSTATUS code; else, it is in SMBSTATUS format.</p>	NT LANMAN
SMB_FLAGS2_UNICODE	If set in a client request or server response, each field that contains a	NT LANMAN

Name and bitmask	Description	Earliest dialect
0x8000	string in this SMB message MUST be encoded as an array of 16-bit Unicode characters, unless otherwise specified. If this bit is clear, each of these fields MUST be encoded as an array of OEM characters. This bit field SHOULD be set to 1 when the negotiated dialect is NT LANMAN.	

PIDHigh (2 bytes): If set to a nonzero value, this field represents the high-order bytes of a process identifier (**PID**). It is combined with the **PIDLow** field below to form a full **PID**.

SecurityFeatures (8 bytes): This 8-byte field has three possible interpretations.

In the case that security signatures are negotiated (see [SMB_COM_NEGOTIATE \(0x72\)](#) (section 2.2.4.52), the following format MUST be observed.

```
SecurityFeatures
{
    UCHAR SecuritySignature[8];
}
```



SecuritySignature (8 bytes): If SMB signing has been negotiated, this field MUST contain an 8-byte cryptographic message signature that can be used to detect whether the message was modified while in transit. The use of message signing is mutually exclusive with connectionless transport.

In the case that CIFS is being transported over a connectionless transport (see section [2.1.2.1](#)), the following format MUST be observed.

```
SecurityFeatures
{
    ULONG Key;
    USHORT CID;
    USHORT SequenceNumber;
}
```

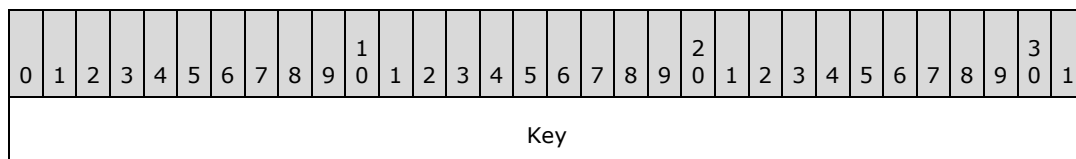

CID	SequenceNumber
-----	----------------

Key (4 bytes): An encryption key used for validating messages over connectionless transports.

CID (2 bytes): A connection identifier (**CID**).

SequenceNumber (2 bytes): A number used to identify the sequence of a message over connectionless transports.

Finally, if neither of the above two cases applies, the **SecurityFeatures** field is treated as a reserved field, which **MUST** be set to zero by the client and **MUST** be ignored by the server.

Reserved (2 bytes): This field is reserved and **SHOULD** be set to 0x0000.

TID (2 bytes): A tree identifier (**TID**).

PIDLow (2 bytes): The lower 16-bits of the **PID**.

UID (2 bytes): A user identifier (**UID**).

MID (2 bytes): A multiplex identifier (**MID**).

2.2.3.2 Parameter Block

SMB was originally designed as a rudimentary remote procedure call protocol, and the parameter block was defined as an array of "one word (two byte) fields containing SMB command dependent parameters". In the CIFS dialect, however, the **SMB_Parameters.Words** array can contain any arbitrary structure. The format of the **SMB_Parameters.Words** structure is defined individually for each command message. The size of the **Words** array is still measured as a count of byte pairs.

The general format of the parameter block is as follows.

```
SMB_Parameters
{
    UCHAR WordCount;
    USHORT Words[WordCount] (variable);
}
```

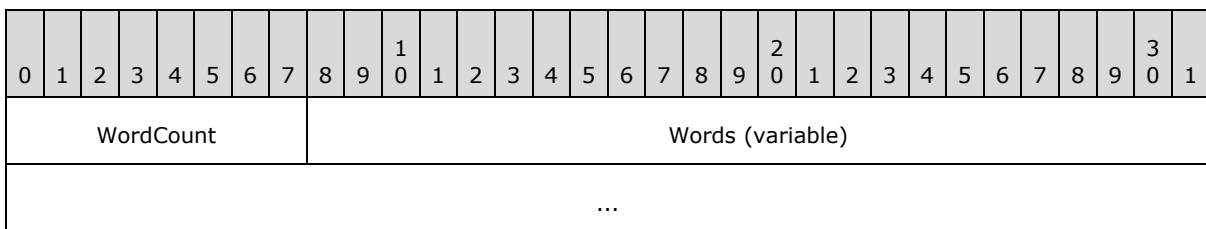

WordCount (1 byte): The size, in two-byte words, of the **Words** field. This field can be zero, indicating that the **Words** field is empty. Note that within the fixed 32 bytes of an [SMB Header \(section 2.2.3.1\)](#), the **WordCount** field is one byte, causing the **Words** field to be unaligned.

Words (variable): The message-specific parameters structure. The size of this field **MUST** be (2 x **WordCount**) bytes. If **WordCount** is 0x00, this field is not included.

2.2.3.3 Data Block

The general structure of the data block is similar to that of the Parameter block, except that the length of the buffer portion is measured in bytes.

```
SMB_Data
{
  USHORT ByteCount;
  UCHAR Bytes[ByteCount] (variable);
}
```

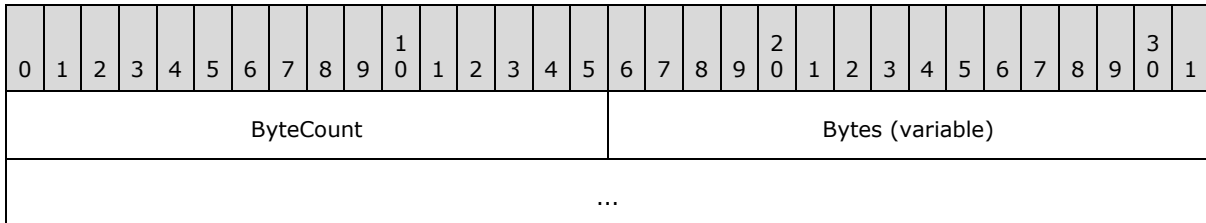

ByteCount (2 bytes): The size, in bytes, of the **Bytes** field. This field can be 0x0000, indicating that the **Bytes** field is empty. Because the **SMB_Parameters.Words** field is unaligned and the **SMB_Data.ByteCount** field is two bytes in size, the first byte of **SMB_Data.Bytes** is also unaligned.

Bytes (variable): The message-specific data structure. The size of this field MUST be **ByteCount** bytes. If **ByteCount** is 0x0000, this field is not included.

2.2.3.4 Batched Messages ("AndX" Messages)

Batched messages using the AndX construct were introduced in the LAN Manager 1.0 dialect. Batched messages reduce the number of messages required to complete a series of commands by sending multiple command requests or responses in a single message. SMB commands that apply the AndX construct are known as "AndX Commands", and are identified by the NT LAN Manager convention of appending "_ANDX" to the command name. Messages of this type are known as AndX Messages.

In AndX Messages, only one [SMB Header \(section 2.2.3.1\)](#) is sent. The header is then followed by zero or more Parameter and Data block pairs, each corresponding to an additional command request/response. There is no limit on the number of block pairs in a message specifically, only on the total message size. The total size of a Batched Message MUST NOT exceed the negotiated **MaxBufferSize**. AndX Messages contain a construct, conceptually similar to a linked-list, that is used to connect the batched block pairs. The resulting list is referred to as an AndX Chain. The structure of this construct is shown below.

```
AndX
{
  UCHAR AndXCommand;
  UCHAR AndXReserved;
  USHORT AndXOffset;
}
```

0	1	2	3	4	5	6	7	8	9	10	11	12	13	14	15	16	17	18	19	20	21	22	23	24	25	26	27	28	29	30	31
AndXCommand										AndXReserved										AndXOffset											

AndXCommand (1 byte): The command code associated with the next block pair in the AndX Chain.

AndXReserved (1 byte): This field is reserved and MUST be 0x00.

AndXOffset (2 bytes): The offset in bytes, relative to the start of the SMB Header, of the next Parameter block in the AndX Message. This offset is independent of any other size parameters or offsets within the command. This offset can point to a location past the end of the current block pair.

The AndX construct is located at the start of the Parameter block of an AndX command request/response.

An AndX Chain is considered terminated when its last command is either a non-AndX SMB command or an AndX SMB command with the AndXCommand field set to [SMB_COM_NO_ANDX_COMMAND](#) (section 2.2.4.75) (0xFF, representing the chain terminator). The SMB_COM_NO_ANDX_COMMAND command code is not used in any other context.

2.2.3.4.1 Follow-on Commands

Each AndX Command has a specific list of commands that can follow it in an AndX Chain. Each command's list of permitted follow-on commands is documented in the command's corresponding subsection of section 2.2.4, SMB Commands.

2.2.4 SMB Commands

2.2.4.1 SMB_COM_CREATE_DIRECTORY (0x00)

This is an original **Core Protocol** command. This command is deprecated. Clients SHOULD use the TRANS2_CREATE_DIRECTORY subcommand.

The Create Directory command creates a new directory on the server, relative to a connected share. The client MUST provide a valid UID and TID, as well as the pathname (relative to the TID) of the directory to be created.

Servers MUST require clients to have, at minimum, create permission within the parent directory in order to create a new directory. The creator's access rights to the new directory are determined by local policy on the server.

2.2.4.1.1 Request

```
SMB_Parameters
{
    UCHAR WordCount;
}
SMB_Data
{
    USHORT ByteCount;
    Bytes
    {
```



```

    UCHAR    BufferFormat;
    SMB_STRING DirectoryName;
}
}

```

SMB_Header:

TID (2 bytes): A valid TID MUST be provided. The TID represents the root of the directory tree in which the new directory is created.

UID (2 bytes): A valid UID MUST be provided. At minimum, the user MUST have create permission for the subtree that is to contain the new directory. The creator's access rights to the new directory are determined by local policy on the server.

SMB_Parameters:

WordCount (1 byte): This field MUST be 0x00. No parameters are sent by this message.

SMB_Data:

ByteCount (2 bytes): This field MUST be greater than or equal to 0x0002.

Bytes (variable): The message-specific data structure as follows:

0	1	2	3	4	5	6	7	8	9	10	11	12	13	14	15	16	17	18	19	20	21	22	23	24	25	26	27	28	29	30	31					
BufferFormat										DirectoryName (variable)																										
...																																				

BufferFormat (1 byte): This field MUST be 0x04.

DirectoryName (variable): A null-terminated string giving the full pathname, relative to the supplied **TID**, of the directory to be created.

2.2.4.1.2 Response

```

SMB_Parameters
{
    UCHAR    WordCount;
}
SMB_Data
{
    USHORT  ByteCount;
}

```

0	1	2	3	4	5	6	7	8	9	10	11	12	13	14	15	16	17	18	19	20	21	22	23	24	25	26	27	28	29	30	31					
SMB_Parameters										SMB_Data																										

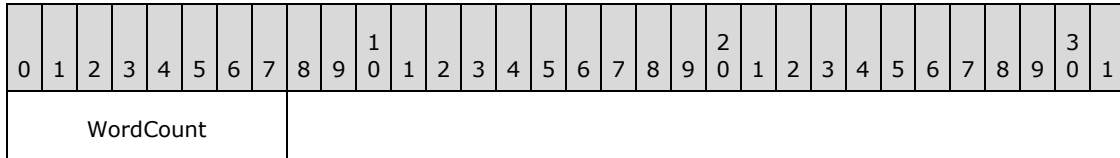
SMB_Parameters (1 byte):

WordCount (1 byte): This field MUST be 0x00. No parameters are sent by this message.

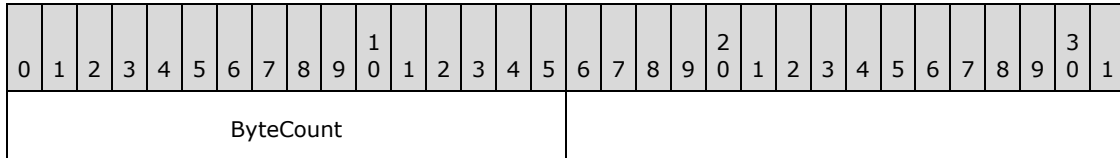
SMB_Data (2 bytes):

ByteCount (2 bytes): This field MUST be 0x0000. No data is sent by this message.

Error Codes

SMB error class	SMB error code	NT status code	POSIX equivalent	Description
ERRDOS (0x01)	ERRbadpath (0x0003)	STATUS_OBJECT_PATH_SYNTAX_BAD (0xC000003B)	ENOENT	The path syntax is invalid.
ERRDOS (0x01)	ERRbadpath (0x0003)	STATUS_OBJECT_NAME_INVALID (0xC0000033)	ENOENT	Object Name invalid.
ERRDOS (0x01)	ERRbadpath (0x0003)	STATUS_OBJECT_PATH_NOT_FOUND (0xC000003A)	ENOENT	The path does not exist.
ERRDOS (0x01)	ERRnoaccess (0x0005)	STATUS_ACCESS_DENIED (0xC0000022)	EACCESS	A component of the path-prefix denied search permission.
ERRDOS (0x01)	ERRnoaccess (0x0005)		ENOSPC	The parent directory is full.
ERRDOS (0x01)	ERRnoaccess (0x0005)		EMLINK	There are too many links to the parent directory.
ERRDOS (0x01)	ERRnomem (0x0008)	STATUS_INSUFF_SERVER_RESOURCES (0xC0000205) STATUS_NO_MEMORY (0xC0000017)	ENOMEM	The server is out of resources.
ERRDOS (0x01)	ERRfileexists (0x0050)	STATUS_OBJECT_NAME_COLLISION (0xC0000035)	EEXIST	The specified directory already exists.
ERRSRV	ERRerror	STATUS_INVALID_SMB		Invalid SMB. Not

SMB error class	SMB error code	NT status code	POSIX equivalent	Description
(0x02)	(0x0001)	(0x00010002)		enough parameter bytes were sent.
ERRSRV (0x02)	ERRinvtid (0x0005)	STATUS_SMB_BAD_TID (0x00050002)		The TID is no longer valid.
ERRSRV (0x02)	ERRbaduid (0x005B)	STATUS_SMB_BAD_UID (0x005B0002)		The UID supplied is not known to the session, or the user identified by the UID does not have sufficient privileges.
ERRHRD (0x03)	ERRnowrite (0x0013)	STATUS_MEDIA_WRITE_PROTECTED (0xC00000A2)	EROFS	Attempt to write to a read-only file system.
ERRHRD (0x03)	ERRdata (0x0017)	STATUS_DATA_ERROR (0xC000003E)	EIO	Disk I/O error.

2.2.4.2 SMB_COM_DELETE_DIRECTORY (0x01)

This is an original **Core Protocol** command.

This command is used to delete an empty directory.

2.2.4.2.1 Request

```

SMB_Parameters
{
    UCHAR WordCount;
}
SMB_Data
{
    USHORT ByteCount;
    Bytes
    {
        UCHAR      BufferFormat;
        SMB_STRING DirectoryName;
    }
}

```

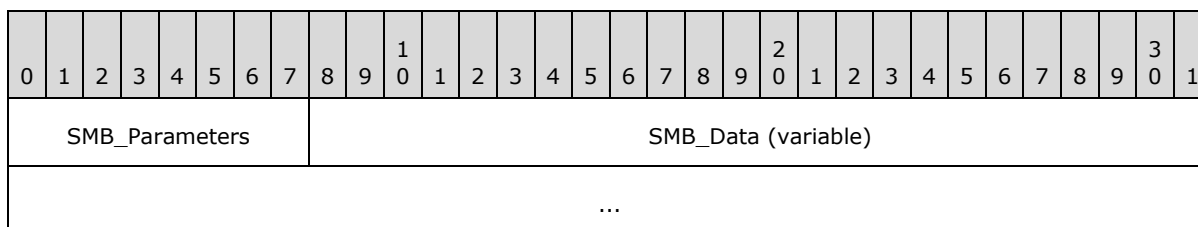

SMB_Parameters (1 byte):

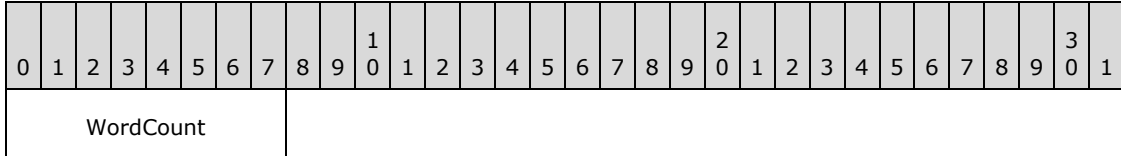

WordCount (1 byte): This field MUST be 0x00. No parameters are sent by this message.

SMB_Data (variable):

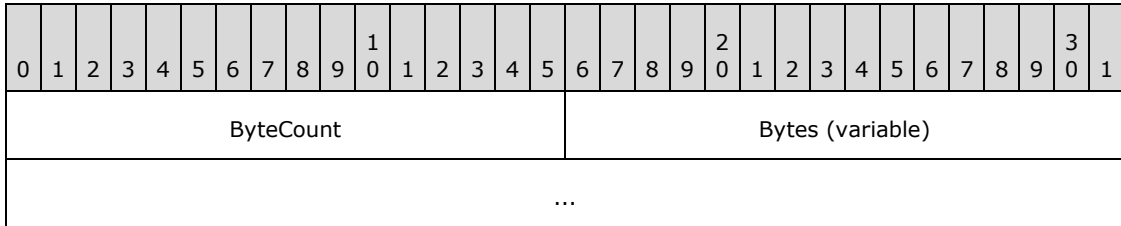

ByteCount (2 bytes): This field MUST be greater than or equal to 0x0002.

Bytes (variable):

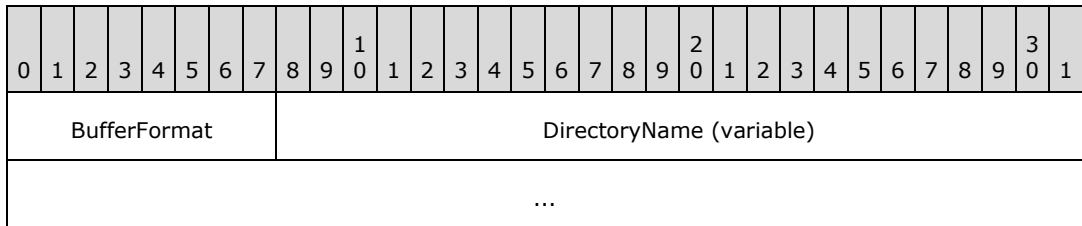

BufferFormat (1 byte): This field MUST contain the value 0x04.

DirectoryName (variable): A null-terminated string that contains the full pathname, relative to the supplied **TID**, of the directory to be deleted.

2.2.4.2.2 Response

```

SMB_Parameters
{
    UCHAR WordCount;
}
SMB_Data
{
    USHORT ByteCount;
}

```

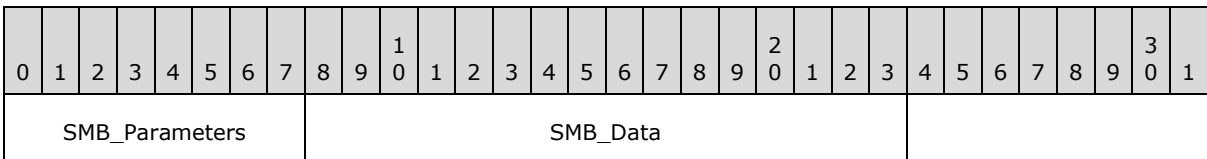

SMB_Parameters (1 byte):

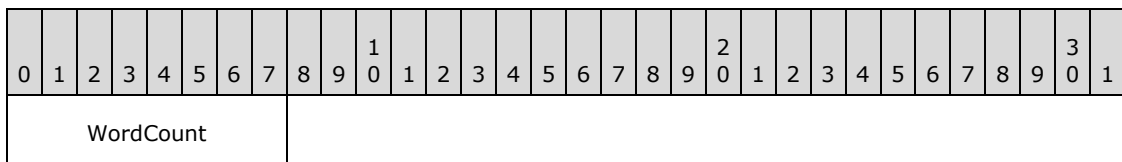

WordCount (1 byte): This field MUST be 0x00. No parameters are sent by this message.

SMB_Data (2 bytes):

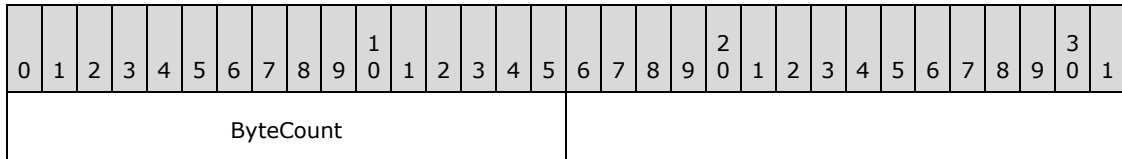

ByteCount (2 bytes): This field MUST be 0x0000. No data is sent by this message.

Error Codes

SMB error class	SMB error code	NT status code	POSIX equivalent	Description
ERRDOS (0x01)	ERRbadfile (0x0002)	STATUS_NO_SUCH_FILE (0xC000000F)	ENOENT	The directory was not found.
ERRDOS (0x01)	ERRbadpath (0x0003)	STATUS_OBJECT_PATH_SYNTAX_BAD (0xC000003B)	ENOENT	The path syntax is invalid.
ERRDOS (0x01)	ERRbadpath (0x0003)	STATUS_OBJECT_PATH_INVALID (0xC0000039)	ENOTDIR	A component of the path-prefix was not a directory.
ERRDOS (0x01)	ERRbadpath (0x0003)	STATUS_OBJECT_PATH_NOT_FOUND (0xC000003A)	ENOENT	The path does not exist.
ERRDOS (0x01)	ERRnoaccess (0x0005)	STATUS_ACCESS_DENIED (0xC0000022)	EACCESS	A component of the path-prefix denied search permission.
ERRDOS (0x01)	ERRnoaccess (0x0005)	STATUS_CANNOT_DELETE (0xC0000121)	EBUSY	The directory is in use.
ERRDOS (0x01)	ERRnoaccess (0x0005)	STATUS_DIRECTORY_NOT_EMPTY (0xC0000101)	EEXIST	The directory is not empty.
ERRDOS (0x01)	ERRbadshare (0x0020)	STATUS_SHARING_VIOLATION (0xC0000043)	ETXTBSY	Sharing violation.
ERRSRV (0x02)	ERRerror (0x0001)	STATUS_INVALID_SMB (0x00010002)		Invalid SMB. Not enough parameter bytes were sent.

SMB error class	SMB error code	NT status code	POSIX equivalent	Description
ERRSRV (0x02)	ERRinvtid (0x0005)	STATUS_SMB_BAD_TID (0x00050002)		The TID is no longer valid.
ERRSRV (0x02)	ERRnomem (0x0008)	STATUS_INSUFF_SERVER_RESOURCES (0xC0000205)	ENOMEM	The server is out of resources.
ERRSRV (0x02)	ERRbaduid (0x005B)	STATUS_SMB_BAD_UID (0x005B0002)		The UID supplied is not known to the session.
ERRHRD (0x03)	ERRnowrite (0x0013)	STATUS_MEDIA_WRITE_PROTECTED (0xC00000A2)	EROFS	Attempt to write to a read-only file system.
ERRHRD (0x03)	ERRdata (0x0017)	STATUS_DATA_ERROR (0xC000003E)	EIO	Disk I/O error.

2.2.4.3 SMB_COM_OPEN (0x02)

This is an original **Core Protocol** command. This command has been deprecated. Client implementations SHOULD use SMB_COM_NT_CREATE_ANDX.

This request is used to open an existing regular file. This command MUST NOT be used to open directories or named pipes. The command includes the pathname of the file, relative to the TID, that the client wishes to open. If the command is successful, the server response MUST include a FID. The client MUST supply the FID in subsequent operations on the file.

2.2.4.3.1 Request

```

SMB_Parameters
{
    UCHAR    WordCount;
    Words
    {
        USHORT           AccessMode;
        SMB_FILE_ATTRIBUTES SearchAttributes;
    }
}
SMB_Data
{
    USHORT ByteCount;
    Bytes
    {
        UCHAR           BufferFormat;
        SMB_STRING FileName;
    }
}

```

SMB_Header:

Flags (1 byte):

Name and bitmask	Description
SMB_FLAGS_OPLOCK 0x20	If set, the client is requesting an Exclusive Opportunistic Lock (OpLock) on the file.
SMB_FLAGS_OPBATCH 0x40	If set, the client is requesting a Batch Exclusive OpLock on the file. The SMB_FLAGS_OPLOCK bit MUST be set if this bit is set.

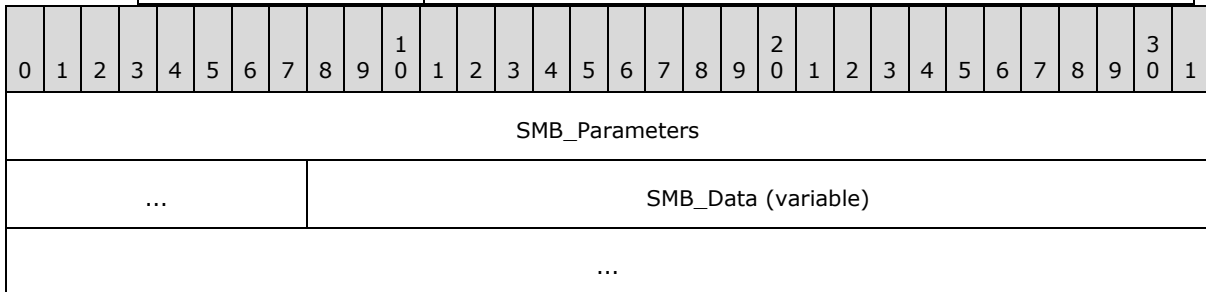

SMB_Parameters (5 bytes):

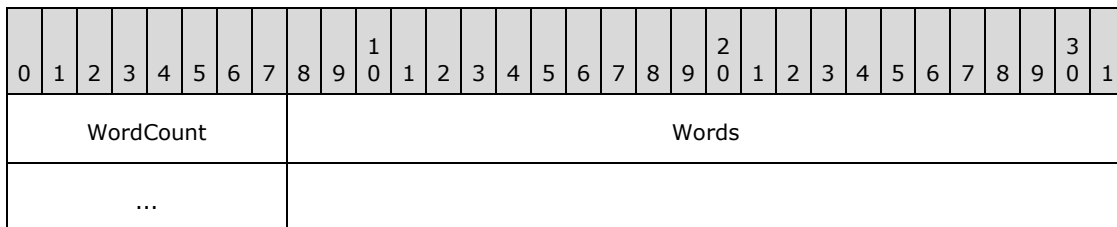

WordCount (1 byte): This field MUST be 0x02.

Words (4 bytes): The message-specific parameters structure.

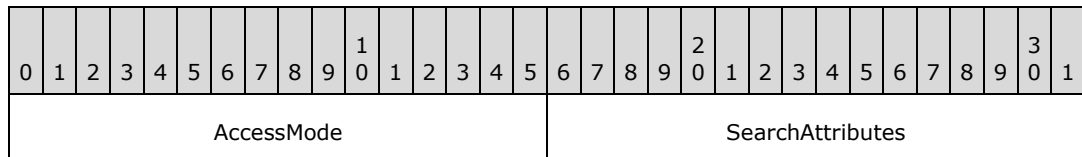

AccessMode (2 bytes): A 16-bit field for encoding the requested access mode. See section [3.2.4.5.1](#) for a discussion on sharing modes.

Name and bitmask	Values	Meaning
AccessMode 0x0007	0	Open for reading
	1	Open for writing
	2	Open for reading and writing
	3	Open for execution
	4 - 7	Reserved. For compatibility with older dialects, the server MUST return STATUS_OS2_INVALID_ACCESS (ERRDOS/ERRbadaccess) if these values are requested.

Name and bitmask	Values	Meaning
0x0008	Reserved. MUST be ignored by the server.	
SharingMode 0x0070	0	Compatibility mode
	1	Deny read/write/execute to others (exclusive use requested)
	2	Deny write to others
	3	Deny read/execute to others
	4	Deny nothing to others
0x0080	Reserved	
ReferenceLocality 0x0700	0	Unknown locality of reference
	1	Mainly sequential access
	2	Mainly random access
	3	Random access with some locality
	4 - 7	Undefined
0x0800	Reserved	
CacheMode 0x1000	0	Perform caching on file
	1	Do not cache the file
0x2000	Reserved	
WritethroughMode 0x4000	0	Write-through mode. If this bit is set, no read ahead or write behind is allowed on this file or device. When the response is returned, data is expected to be on the disk or device.
	1	
0x8000	Reserved	

SearchAttributes (2 bytes): Specifies the type of file. This field is used as a search mask. Both the **FileName** and the **SearchAttributes** of a file MUST match in order for the file to be opened. <28>

SMB_Data (variable):

0	1	2	3	4	5	6	7	8	9	10	11	12	13	14	15	16	17	18	19	20	21	22	23	24	25	26	27	28	29	30	31
ByteCount																Bytes (variable)															
...																															

ByteCount (2 bytes): This field MUST be greater than or equal to 0x0002.

Bytes (variable): The message-specific data structure, which follows.

0	1	2	3	4	5	6	7	8	9	0	1	2	3	4	5	6	7	8	9	0	1	2	3	4	5	6	7	8	9	0	1		
BufferFormat										FileName (variable)																							
...																																	

BufferFormat (1 byte): A buffer format identifier. The value of this field MUST be 0x04.

FileName (variable): A null-terminated string containing the file name of the file to be opened.

2.2.4.3.2 Response

```

SMB_Parameters
{
  UCHAR WordCount;
  Words
  {
    USHORT          FID;
    SMB_FILE_ATTRIBUTES FileAttrs;
    UTIME           LastModified;
    ULONG          FileSize;
    USHORT         AccessMode;
  }
}
SMB_Data
{
  USHORT ByteCount;
}

```

0	1	2	3	4	5	6	7	8	9	0	1	2	3	4	5	6	7	8	9	0	1	2	3	4	5	6	7	8	9	0	1		
SMB_Parameters																																	
...																																	
...																																	
...																												SMB_Data					
...																																	

SMB_Parameters (15 bytes):

0	1	2	3	4	5	6	7	8	9	0	1	2	3	4	5	6	7	8	9	0	1	2	3	4	5	6	7	8	9	0	1
WordCount										Words																					

...
...
...

WordCount (1 byte): This field MUST be 0x07. The length, in 2-byte words, of the remaining **SMB_Parameters**.

Words (14 bytes):

0	1	2	3	4	5	6	7	8	9	10	11	12	13	14	15	16	17	18	19	20	21	22	23	24	25	26	27	28	29	30	31
FID										FileAttrs																					
LastModified																															
FileSize																															
AccessMode																															

FID (2 bytes): The FID returned for the open file.

FileAttrs (2 bytes): The set of attributes currently assigned to the file. This field is formatted in the same way as the **SearchAttributes** field in the request.

LastModified (4 bytes): The time of the last modification to the opened file.

FileSize (4 bytes): The current size of the opened file, in bytes.

AccessMode (2 bytes): A 16-bit field for encoding the granted access mode. This field is formatted in the same way as the Request equivalent.

SMB_Data (2 bytes):

0	1	2	3	4	5	6	7	8	9	10	11	12	13	14	15	16	17	18	19	20	21	22	23	24	25	26	27	28	29	30	31
ByteCount																															

ByteCount (2 bytes): This field MUST be 0x0000. No data is sent by this message.

Error Codes

SMB error class	SMB error code	NT status code	POSIX equivalent	Description
ERRDOS	ERRbadfile (0x0002)	STATUS_NO_SUCH_FILE (0xC000000F)	ENOENT	The named file was not found.

SMB error class	SMB error code	NT status code	POSIX equivalent	Description
(0x01)				
ERRDOS (0x01)	ERRbadpath (0x0003)	STATUS_OBJECT_PATH_SYNTAX_BAD (0xC000003B)	ENOENT	The file path syntax is invalid.
ERRDOS (0x01)	ERRnofids (0x0004)	STATUS_OS2_TOO_MANY_OPEN_FILES (0x00040001) STATUS_TOO_MANY_OPENED_FILES (0xC000011F)	ENFILE	Too many open files, no more FIDs available.
ERRDOS (0x01)	ERRbadpath (0x0003)	STATUS_OBJECT_PATH_INVALID (0xC0000039)	ENOTDIR	A component of the path-prefix was not a directory.
ERRDOS (0x01)	ERRnoaccess (0x0005)	STATUS_ACCESS_DENIED (0xC0000022)	EACCESS	A component of the path-prefix denied search permission OR the requested access permission is denied for the file OR an open mode failure occurred.
ERRDOS (0x01)	ERRnoaccess (0x0005)	STATUS_FILE_IS_A_DIRECTORY (0xC00000BA)	EISDIR	Named file is an existing directory and requested open mode is write or read/write.
ERRDOS (0x01)	ERRnoaccess (0x0005)	STATUS_ACCESS_DENIED (0xC0000022)	ETXTBSY	File is an executable binary file that is being executed and requested access permission specifies write or read/write.
ERRDOS (0x01)	ERRnomem (0x0008)	STATUS_INSUFF_SERVER_RESOURCES (0xC0000205)	ENOMEM	The server is out of resources.
ERRDOS (0x01)	ERRbadaccess (0x000C)	STATUS_OS2_INVALID_ACCESS (0x000C0001)		The Reserved bit (0x0008) in the AccessMode.AccessMode subfield was set (1) in the request.
ERRDOS (0x01)	ERRbadshare (0x0020)	STATUS_SHARING_VIOLATION (0xC0000043)	EAGAIN	File exists, mandatory file/record locking is set, and there are outstanding record locks on the file.
ERRSRV (0x02)	ERRerror (0x0001)	STATUS_INVALID_SMB (0x00010002)		Invalid SMB. Not enough parameter bytes were sent.

SMB error class	SMB error code	NT status code	POSIX equivalent	Description
ERRSRV (0x02)	ERRerror (0x0001)		EFAULT	The path points outside the allocated address space of the process.
ERRSRV (0x02)	ERRerror (0x0001)		EINTR	A signal was caught during the open operation.
ERRSRV (0x02)	ERRerror (0x0001)		ENXIO	Generic server open failure.
ERRSRV (0x02)	ERRerror (0x0001)	STATUS_ACCESS_DENIED (0xC0000022)	EROFS	The named file resides on a read-only file system and the requested access permission is write or read/write.
ERRSRV (0x02)	ERRaccess (0x0004)	STATUS_NETWORK_ACCESS_DENIED (0xC00000CA)		Permission conflict between the requested permission and permissions for the shared resource; for example, open for write of a file in a read-only file system subtree.
ERRSRV (0x02)	ERRinvtid (0x0005)	STATUS_SMB_BAD_TID (0x00050002)		The TID is no longer valid.
ERRSRV (0x02)	ERRinvdevice (0x0007)	STATUS_BAD_DEVICE_TYPE (0xC00000CB)		A file creation request was made to a share that is not a file system subtree.
ERRSRV (0x02)	ERRbaduid (0x005B)	STATUS_SMB_BAD_UID (0x005B0002)		The UID supplied is not known to the session.
ERRHRD (0x03)	ERRnowrite (0x0013)	STATUS_MEDIA_WRITE_PROTECTED (0xC00000A2)	EROFS	Attempt to write to a read-only file system.
ERRHRD (0x03)	ERRdata (0x0017)	STATUS_DATA_ERROR (0xC000003E)	EIO	Disk I/O error.

2.2.4.4 SMB_COM_CREATE (0x03)

This is an original **Core Protocol** command. This command is deprecated. Implementations SHOULD use SMB_COM_NT_CREATE_ANDX.

This command is used to create and open a new file or open and truncate an existing file to zero length. The FID that is returned can be used in subsequent read, write, lock, unlock, and close messages. This command MUST NOT be used to create directories or named pipes. The request includes the pathname of the file relative to the supplied TID that the client wishes to create. If the

command is successful, the server response MUST include a FID. The client MUST supply the FID in subsequent operations on the file. The client MUST have write permission on the file's parent directory in order to create a new file, or write permissions on the file itself in order to truncate the file. The client's access permissions on a newly created file MUST be read/write. Access permissions on truncated files are not modified. The file is opened in read/write/compatibility mode.

2.2.4.4.1 Request

```
SMB_Parameters
{
  UCHAR WordCount;
  Words
  {
    SMB_FILE_ATTRIBUTES FileAttributes;
    UTIME CreationTime;
  }
}
SMB_Data
{
  USHORT ByteCount;
  Bytes
  {
    UCHAR BufferFormat;
    SMB_STRING FileName;
  }
}
```

SMB_Header:

TID (2 bytes): A valid Tree Identifier obtained from a previously successful message exchange.

UID (2 bytes): A valid User Identifier that MUST be the same value as the User Identifier associated with the current SMB Session.

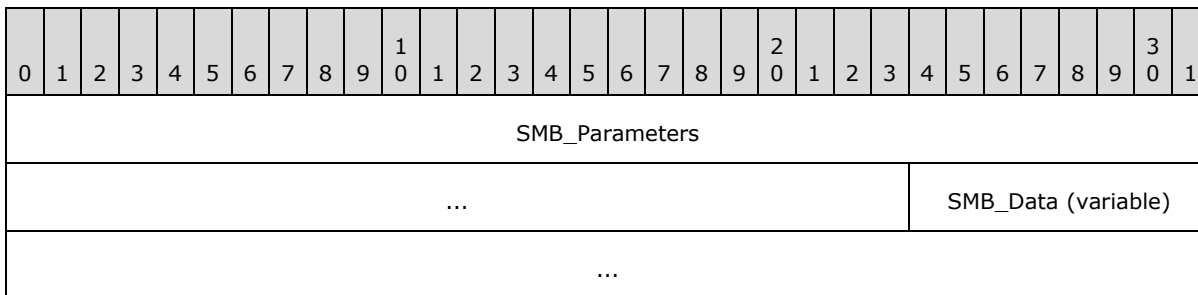

SMB_Parameters (7 bytes):

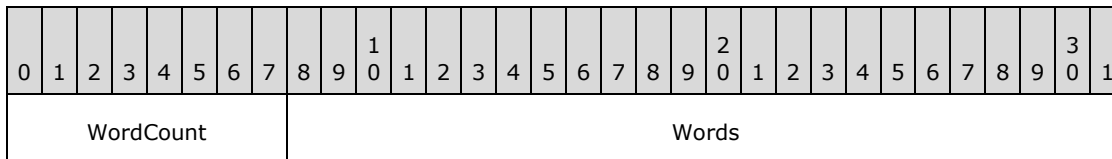

...

WordCount (1 byte): This field MUST be 0x03.

Words (6 bytes):

0	1	2	3	4	5	6	7	8	9	10	11	12	13	14	15	16	17	18	19	20	21	22	23	24	25	26	27	28	29	30	31
FileAttributes																CreationTime															
...																															

FileAttributes (2 bytes): A 16-bit field of 1-bit flags that represent the file attributes to assign to the file if it is created successfully.

CreationTime (4 bytes): The time that the file was created, represented as the number of seconds since Jan 1, 1970, 00:00:00.0.

SMB_Data (variable):

0	1	2	3	4	5	6	7	8	9	10	11	12	13	14	15	16	17	18	19	20	21	22	23	24	25	26	27	28	29	30	31
ByteCount																Bytes (variable)															
...																															

ByteCount (2 bytes): This field MUST be greater than or equal to 0x0002.

Bytes (variable):

0	1	2	3	4	5	6	7	8	9	10	11	12	13	14	15	16	17	18	19	20	21	22	23	24	25	26	27	28	29	30	31
BufferFormat										FileName (variable)																					
...																															

BufferFormat (1 byte): This field MUST be 0x04.

FileName (variable): A null-terminated string that represents the fully qualified name of the file relative to the supplied TID to create or truncate on the server.

2.2.4.4.2 Response

```
SMB_Parameters
{
    UCHAR WordCount;
    Words
```

```

    {
        USHORT FID;
    }
}
SMB_Data
{
    USHORT ByteCount;
}

```

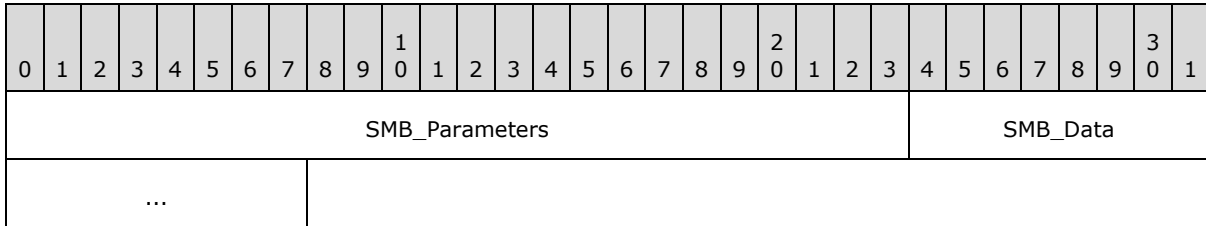

SMB_Parameters (3 bytes):

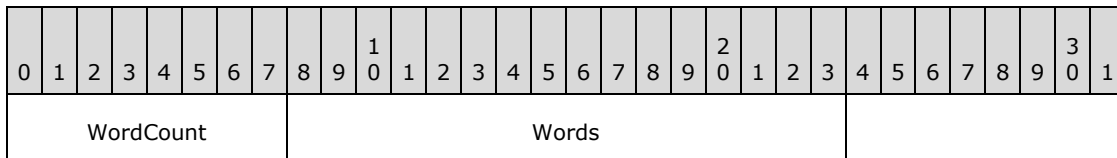

WordCount (1 byte): This field MUST be 0x01.

Words (2 bytes):

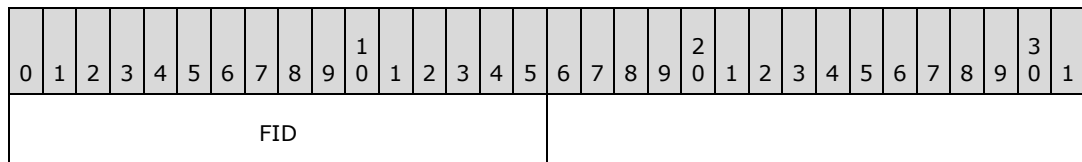

FID (2 bytes): The **FID** representing the file on the server. This value MUST be supplied in the **FID** field of the [SMB Header \(section 2.2.3.1\)](#) in subsequent requests that manipulate the file.

SMB_Data (2 bytes):

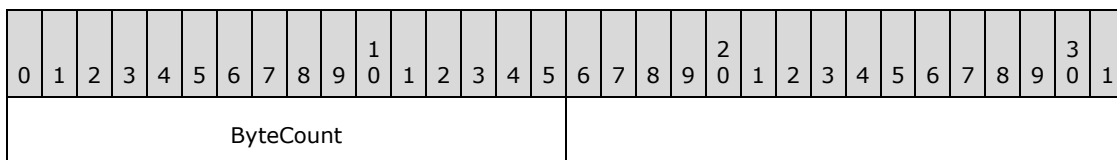

ByteCount (2 bytes): This field MUST be 0x0000. No data is sent by this message.

Error Codes

SMB error class	SMB error code	NT status code	POSIX equivalent	Description
ERRDOS (0x01)	ERRbadfile (0x0002)	STATUS_OBJECT_NAME_NOT_FOUND (0xC0000034)	ENOENT	The named file was not found.
ERRDOS (0x01)	ERRbadpath (0x0003)	STATUS_OBJECT_PATH_SYNTAX_BAD (0xC000003B)	ENOENT	The file path syntax is invalid.
ERRDOS (0x01)	ERRnofids (0x0004)	STATUS_OS2_TOO_MANY_OPEN_FILES (0x00040001) STATUS_TOO_MANY_OPENED_FILES (0xC000011F)	EMFILE	Too many open files, no more FIDs available.
ERRDOS (0x01)	ERRbadpath (0x0003)	STATUS_OBJECT_PATH_INVALID (0xC0000039)	ENOTDIR	A component of the path-prefix was not a directory.
ERRDOS (0x01)	ERRnoaccess (0x0005)	STATUS_ACCESS_DENIED (0xC0000022)	EACCESS	A component of the path-prefix denied search permission OR requested access permission is denied for the file OR open mode failure.
ERRDOS (0x01)	ERRnoaccess (0x0005)	STATUS_FILE_IS_A_DIRECTORY (0xC00000BA)	EISDIR	Named file is an existing directory and requested open mode is write or read/write.
ERRDOS (0x01)	ERRnoaccess (0x0005)	STATUS_ACCESS_DENIED (0xC0000022)	ETXTBSY	File is an executable binary file that is being executed and requested access permission specifies write or read/write.
ERRDOS (0x01)	ERRnomem (0x0008)	STATUS_INSUFF_SERVER_RESOURCES (0xC0000205)	ENOMEM	The server is out of resources.
ERRSRV (0x02)	ERRbadshare (0x0020)	STATUS_SHARING_VIOLATION (0xC0000043)	EAGAIN	File exists, mandatory file/record locking is set, and there are outstanding record locks on the file.
ERRSRV (0x02)	ERRerror (0x0001)	STATUS_INVALID_SMB (0x00010002)		Invalid SMB. Not enough parameter bytes were sent.

SMB error class	SMB error code	NT status code	POSIX equivalent	Description
ERRSRV (0x02)	ERRerror (0x0001)		EFAULT	Path points outside the allocated address space of the process.
ERRSRV (0x02)	ERRerror (0x0001)		EINTR	A signal was caught during the open operation.
ERRSRV (0x02)	ERRerror (0x0001)		ENXIO	Generic server open failure.
ERRSRV (0x02)	ERRerror (0x0001)	STATUS_ACCESS_DENIED (0xC0000022)	EROFS	Named file resides on read-only file system and requested access permission is write or read/write.
ERRSRV (0x02)	ERRaccess (0x0004)	STATUS_NETWORK_ACCESS_DENIED (0xC00000CA)		Permission conflict between requested permission and permissions for the shared resource; for example, open for write of a file in a read-only file system subtree.
ERRSRV (0x02)	ERRinvtid (0x0005)	STATUS_SMB_BAD_TID (0x00050002)		The TID is no longer valid.
ERRSRV (0x02)	ERRinvdevice (0x0007)	STATUS_BAD_DEVICE_TYPE (0xC00000CB)		File creation request made to a share that is not a file system subtree.
ERRSRV (0x02)	ERRbaduid (0x005B)	STATUS_SMB_BAD_UID (0x005B0002)		The UID supplied is not known to the session.
ERRHRD (0x03)	ERRnowrite (0x0013)	STATUS_MEDIA_WRITE_PROTECTED (0xC00000A2)	EROFS	Attempt to write to a read-only file system.
ERRHRD (0x03)	ERRdata (0x0017)	STATUS_DATA_ERROR (0xC000003E)	EIO	Disk I/O error.

2.2.4.5 SMB_COM_CLOSE (0x04)

This is an original **Core Protocol** command.

This command is used by the client to close an instance of an object associated with a valid FID.

2.2.4.5.1 Request

```

SMB_Parameters
{
  UCHAR WordCount;
  Words
  {
    USHORT FID;
    UTIME LastTimeModified;
  }
}
SMB_Data
{
  USHORT ByteCount;
}

```

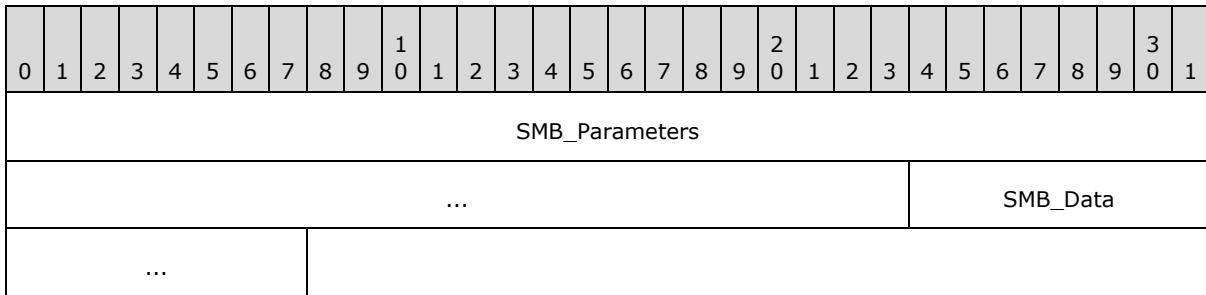

SMB_Parameters (7 bytes):

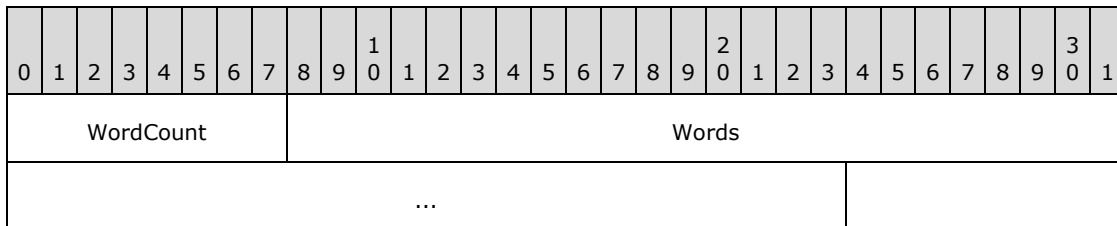

WordCount (1 byte): This field MUST be 0x03.

Words (6 bytes):

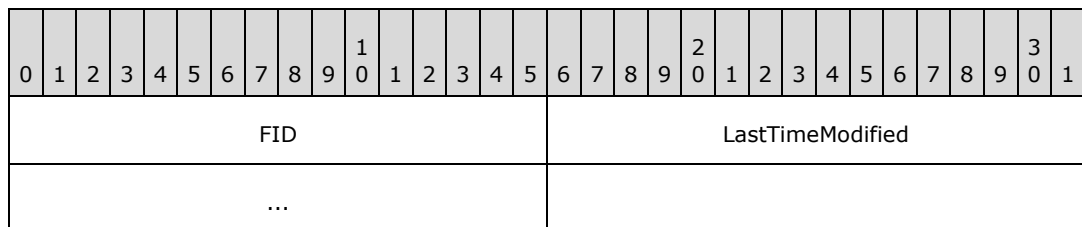

FID (2 bytes): The FID of the object to be closed.

LastTimeModified (4 bytes): A time value encoded as the number of seconds since January 1, 1970 00:00:00.0. The client can request that the last modification time for the file be updated to this time value. A value of 0x00000000 or 0xFFFFFFFF results in the server not updating the last modification time.

SMB_Data (2 bytes):

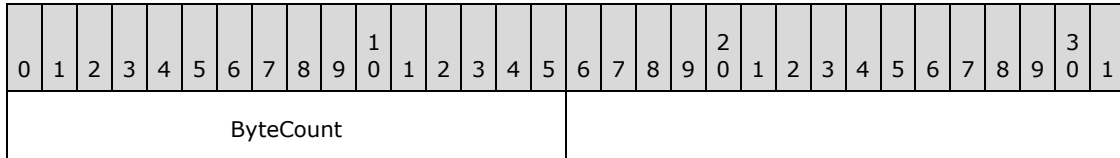

ByteCount (2 bytes): This field MUST be 0x0000. No data is sent by this message.

2.2.4.5.2 Response

```
SMB_Parameters
{
    UCHAR WordCount;
}
SMB_Data
{
    USHORT ByteCount;
}
```

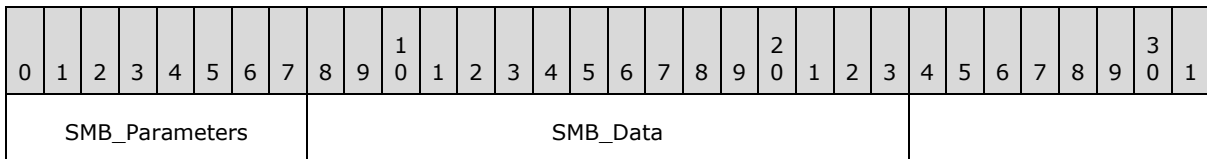

SMB_Parameters (1 byte):

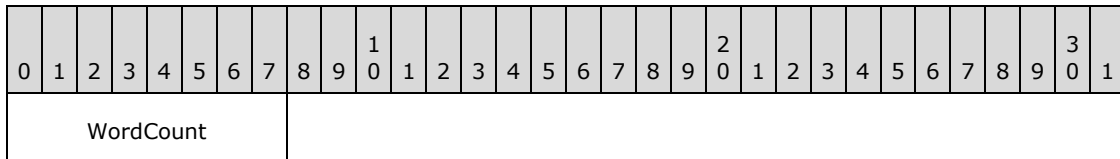

WordCount (1 byte): This field MUST be 0x00. No parameters are sent by this message.

SMB_Data (2 bytes):

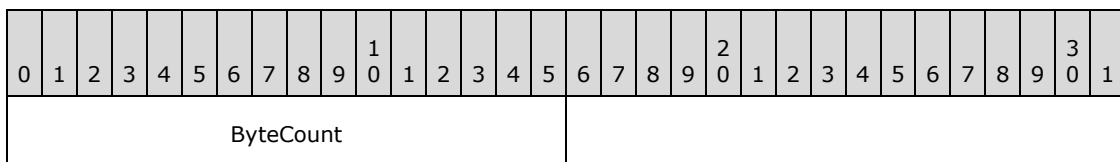

ByteCount (2 bytes): This field MUST be 0x00. No data is sent by this message

Error Codes

SMB error class	SMB error code	NT status code	POSIX equivalent	Description
ERRDOS	ERRbadfid	STATUS_INVALID_HANDLE	ENFILE	The FID is invalid.

SMB error class	SMB error code	NT status code	POSIX equivalent	Description
(0x01)	(0x0006)	(0xC0000008) STATUS_SMB_BAD_FID (0x00060001)		
ERRSRV (0x02)	ERRerror (0x0001)	STATUS_INVALID_SMB (0x00010002)		The TID specified in the command is invalid.
ERRSRV (0x02)	ERRinvtid (0x0005)	STATUS_SMB_BAD_TID (0x00050002)		The TID specified in the command is invalid.
ERRSRV (0x02)	ERRinvdevice (0x0007)	STATUS_BAD_DEVICE_TYPE (0xC00000CB)		Invalid attempt to close an open spool file. OR Invalid device - printer request made to a non-printer connection or non-printer request made to a printer connection.
ERRSRV (0x02)	ERRbaduid (0x005B)	STATUS_SMB_BAD_UID (0x005B0002)		The UID specified is not known as a valid ID on this server session, or the user identified by the UID does not have sufficient privileges.

2.2.4.6 SMB_COM_FLUSH (0x05)

This is an original **Core Protocol** command.

This command requests that the server flush data and allocation information for a specified file or for all open files under the session.

2.2.4.6.1 Request

```

SMB_Parameters
{
    UCHAR WordCount;
    Words
    {
        USHORT FID;
    }
}
SMB_Data
{
    USHORT ByteCount;
}

```

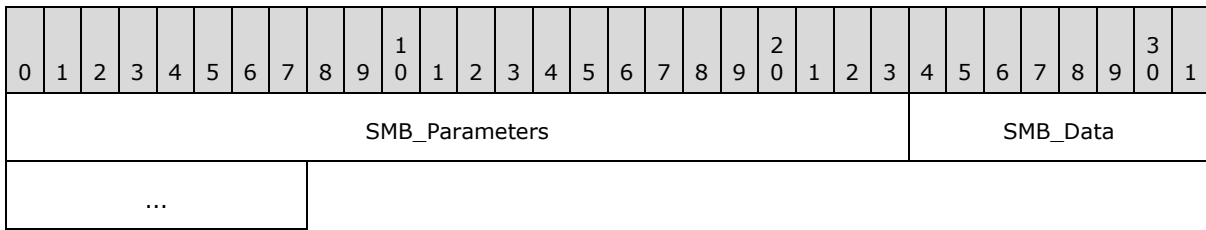

SMB_Parameters (3 bytes):

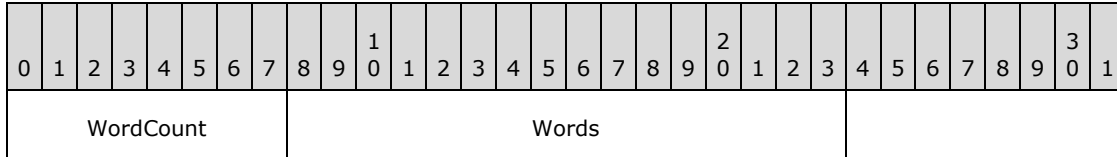

WordCount (1 byte): This field MUST be 0x01.

Words (2 bytes):

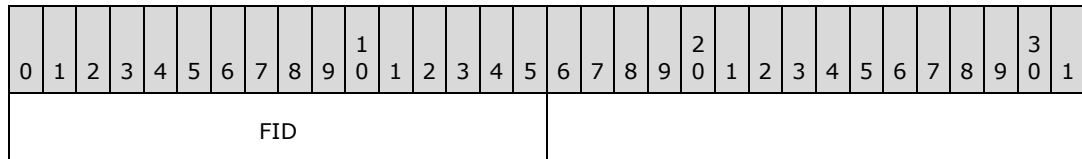

FID (2 bytes): The FID of the file to be flushed. If this field is set to 0xFFFF (65535), all files opened by the same PID within the SMB connection are to be flushed.

SMB_Data (2 bytes):

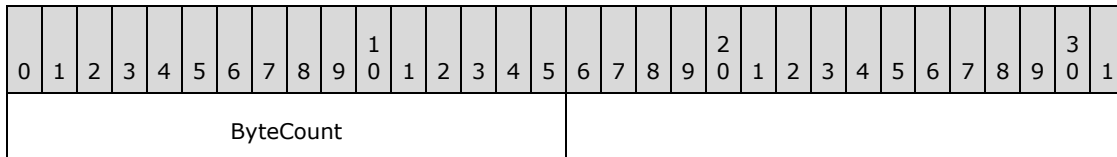

ByteCount (2 bytes): This field MUST be 0x0000. No data is sent by this message.

2.2.4.6.2 Response

```

SMB_Parameters
{
    UCHAR WordCount;
}
SMB_Data
{
    USHORT ByteCount;
}

```

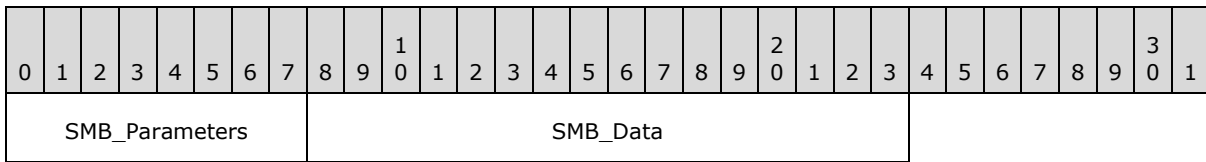

SMB_Parameters (1 byte):

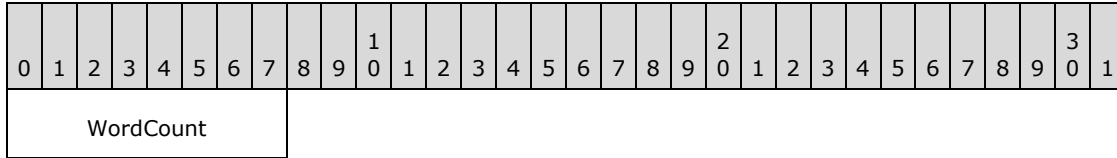

WordCount (1 byte): This field MUST be 0x00. No parameters are sent by this message.

SMB_Data (2 bytes):

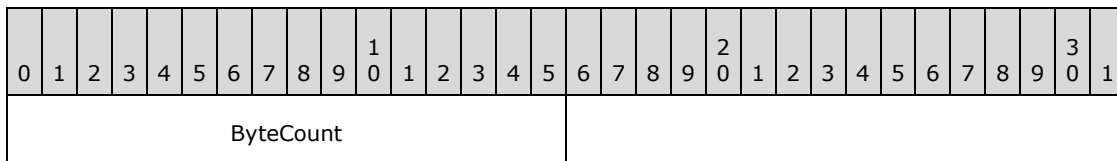

ByteCount (2 bytes): This field MUST be 0x0000. No data is sent by this message.

Error Codes

SMB error class	SMB error code	NT status code	POSIX equivalent	Description
ERRDOS (0x01)	ERRbadfid (0x0006)	STATUS_INVALID_HANDLE (0xC0000008) STATUS_SMB_BAD_FID (0x00060001)	ENFILE	Attempt to read from a FID that the server does not have open.
ERRDOS (0x01)	ERRnoaccess (0x0005)	STATUS_ACCESS_DENIED (0xC0000022)	EACCESS	The client does not have write permissions.
ERRSRV (0x02)	ERRerror (0x0001)	STATUS_INVALID_SMB (0x00010002)		The TID specified in the command is invalid.
ERRSRV (0x02)	ERRinvtid (0x0005)	STATUS_SMB_BAD_TID (0x00050002)		The TID specified in the command is invalid.
ERRSRV (0x02)	ERRbaduid (0x005B)	STATUS_SMB_BAD_UID (0x005B0002)		The UID specified is not known as a valid ID on this server session,

SMB error class	SMB error code	NT status code	POSIX equivalent	Description
				or the user identified by the UID does not have sufficient privileges.
ERRHRD (0x03)	ERRnowrite (0x0013)	STATUS_MEDIA_WRITE_PROTECTED (0xC00000A2)	EROFS	Attempt to write to a read-only file system.
ERRHRD (0x03)	ERRdata (0x0017)	STATUS_DATA_ERROR (0xC000003E)	EIO	Disk I/O error.
ERRHRD (0x03)	ERRdiskfull(0x0027)	STATUS_DISK_FULL(0xC000007F)	ENOSPC	The file system is full.

2.2.4.7 SMB_COM_DELETE (0x06)

This is an original **Core Protocol** command.

This command is used by the client to delete one or more regular files. It supports the use of wildcards in file names, allowing for deletion of multiple files in a single request.

2.2.4.7.1 Request

```

SMB_Parameters
{
    UCHAR WordCount;
    Words
    {
        SMB_FILE_ATTRIBUTES SearchAttributes;
    }
}
SMB_Data
{
    USHORT ByteCount;
    Bytes
    {
        UCHAR BufferFormat;
        SMB_STRING FileName;
    }
}

```

SMB_Header:

Flags2 (2 bytes): USHORT

Name and bitmask	Relevance
SMB_FLAGS2_LONG_NAMES 0x0001	Wildcard pattern matching behavior. If this flag is not set, wildcard patterns MUST compare against 8.3 names only. If a file has a long name, the wildcard pattern MUST be compared to that file's 8.3 name. If this flag is set, file names can be long file names and wildcard patterns MUST compare against the long file name of a file if it is available.

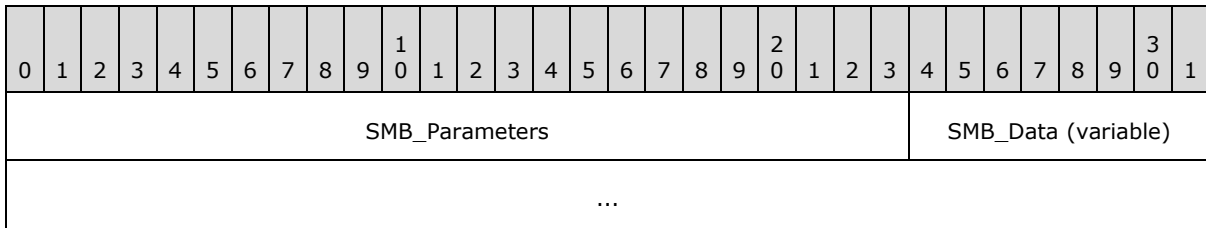

SMB_Parameters (3 bytes):

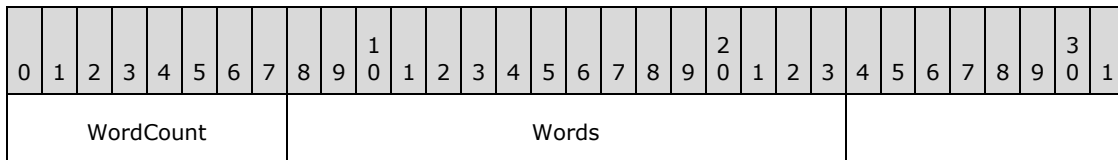

WordCount (1 byte): This field MUST be 0x01.

Words (2 bytes):

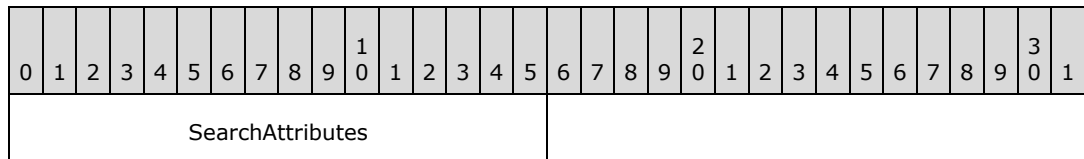

SearchAttributes (2 bytes): The file attributes of the file(s) to be deleted. If the value of this field is 0x0000, then only normal files MUST be matched for deletion. If the System or Hidden attributes MUST be specified, then entries with those attributes are matched in addition to the normal files. Read-only files MUST NOT be deleted. The read-only attribute of the file MUST be cleared before the file can be deleted.

SMB_Data (variable):

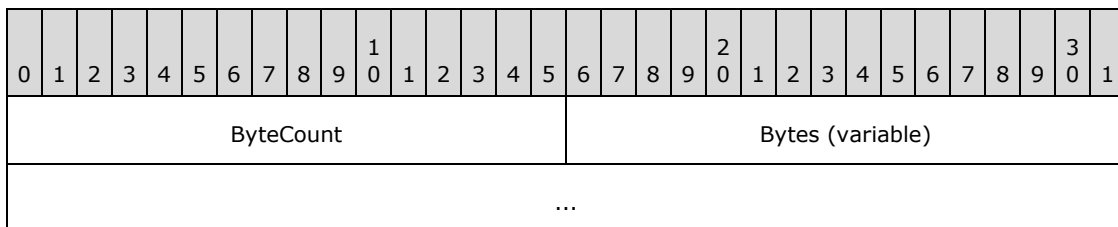

ByteCount (2 bytes): This field MUST be greater than or equal to 0x0002.

Bytes (variable):

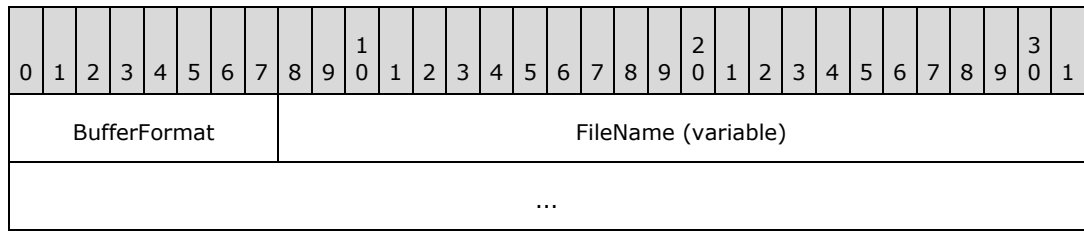

BufferFormat (1 byte): This field MUST be 0x04.

FileName (variable): The pathname of the file(s) to be deleted, relative to the supplied **TID**. Wildcards MAY be used in the filename component of the path.

2.2.4.7.2 Response

```
SMB_Parameters
{
    UCHAR WordCount;
}
SMB_Data
{
    USHORT ByteCount;
}
```

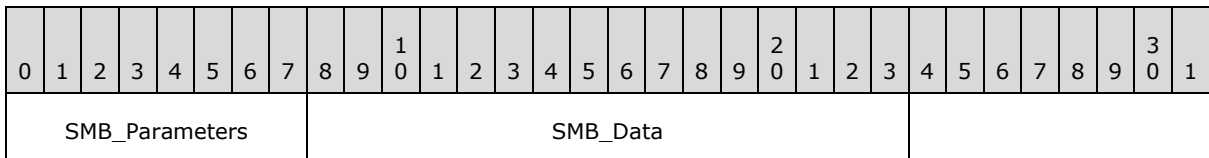

SMB_Parameters (1 byte):

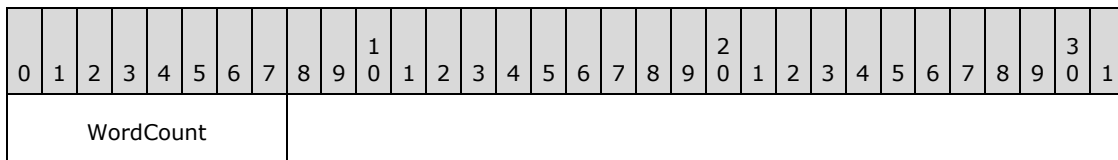

WordCount (1 byte): This field MUST be 0x00. No parameters are sent by this message.

SMB_Data (2 bytes):

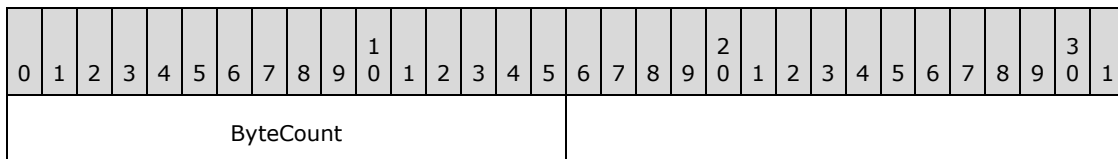

ByteCount (2 bytes): This field MUST be 0x0000. No data is sent by this message.

Error Codes

SMB error class	SMB error code	NT status code	POSIX equivalent	Description
ERRDOS (0x01)	ERRbadfile (0x0002)	STATUS_NO_SUCH_FILE (0xC000000F)	ENOENT	The named file was not found.
ERRDOS (0x01)	ERRbadpath (0x0003)	STATUS_OBJECT_PATH_SYNTAX_BAD (0xC000003B)	ENOENT	The file path syntax is invalid.
ERRDOS (0x01)	ERRnoaccess (0x0005)	STATUS_ACCESS_DENIED (0xC0000022)	EPERM	Access denied.
ERRSRV (0x02)	ERRerror (0x0001)	STATUS_INVALID_SMB (0x00010002)		Invalid SMB. Not enough parameter bytes were sent.
ERRSRV (0x02)	ERRinvtid (0x0005)	STATUS_SMB_BAD_TID (0x00050002)		The TID is no longer valid.
ERRSRV (0x02)	ERRnomem (0x0008)	STATUS_INSUFF_SERVER_RESOURCES (0xC0000205)	ENOMEM	The server is out of resources.
ERRSRV (0x02)	ERRbaduid (0x005B)	STATUS_SMB_BAD_UID (0x005B0002)		The UID supplied is not known to the session.
ERRHRD (0x03)	ERRnowrite (0x0013)	STATUS_MEDIA_WRITE_PROTECTED (0xC00000A2)	EROFS	Attempt to write to a read-only file system.

2.2.4.8 SMB_COM_RENAME (0x07)

This is an original **Core Protocol** command.

This command changes the name of one or more files or directories. It supports the use of wildcards in file names, allowing the renaming of multiple files in a single request.

2.2.4.8.1 Request

```

SMB_Parameters
{
    UCHAR WordCount;
    Words
    {
        SMB_FILE_ATTRIBUTES SearchAttributes;
    }
}
SMB_Data
{
    USHORT ByteCount;
    Bytes
    {
        UCHAR          BufferFormat1;
    }
}

```

```

SMB_STRING OldFileName;
UCHAR      BufferFormat2;
SMB_STRING NewFileName;
}
}

```

SMB_Header:

Flags2 (2 bytes): USHORT

Name and bitmask	Relevance
SMB_FLAGS2_LONG_NAMES 0x0001	Wildcard pattern matching behavior. If this flag is not set, wildcard patterns MUST compare against 8.3 names only. If a file has a long name, the wildcard pattern MUST be compared to that file's 8.3 name. If this flag is set, file names MAY be long file names and wildcard patterns MUST compare against the long file name of a file if it is available.

TID (2 bytes): This field MUST contain a valid TID.

UID (2 bytes): This field MUST contain a valid UID.

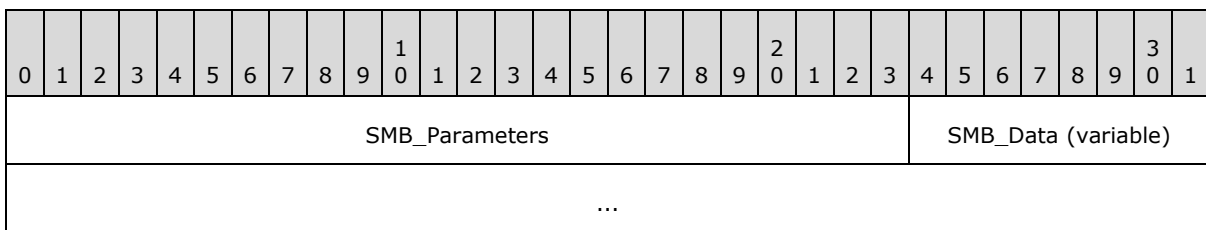

SMB_Parameters (3 bytes):

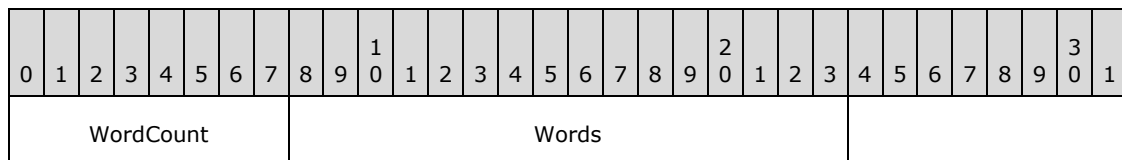

WordCount (1 byte): This field MUST be 0x01.

Words (2 bytes):

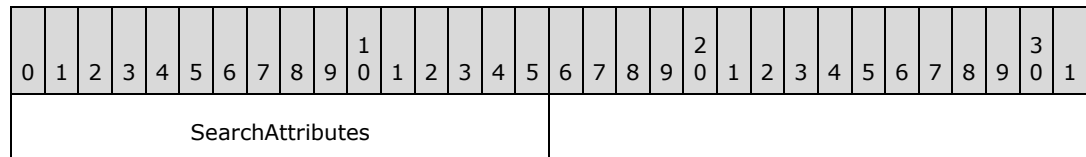

SearchAttributes (2 bytes): Indicates the file attributes that the file(s) to be renamed MUST have. If the value of this field is 0x0000, then only normal files MUST be matched to be renamed. If the System or Hidden attributes are specified, then entries with those attributes MAY be matched in

addition to the normal files. Read-only files MUST NOT be renamed. The read-only attribute of the file MUST be cleared before it can be renamed.

SMB_Data (variable):

0	1	2	3	4	5	6	7	8	9	10	11	12	13	14	15	16	17	18	19	20	21	22	23	24	25	26	27	28	29	30	31
ByteCount																Bytes (variable)															
...																															

ByteCount (2 bytes): This field MUST be greater than or equal to 0x0002.

Bytes (variable):

0	1	2	3	4	5	6	7	8	9	10	11	12	13	14	15	16	17	18	19	20	21	22	23	24	25	26	27	28	29	30	31
BufferFormat1										OldFileName (variable)																					
...																															
BufferFormat2										NewFileName (variable)																					
...																															

BufferFormat1 (1 byte): This field MUST be 0x04.

OldFileName (variable): A null-terminated string that contains the name of the file or files to be renamed. Wildcards MAY be used in the filename component of the path.

BufferFormat2 (1 byte): This field MUST be 0x04.

NewFileName (variable): A null-terminated string containing the new name(s) to be given to the file(s) that matches OldFileName or the name of the destination directory into which the files matching OldFileName MUST be moved.

2.2.4.8.2 Response

```
SMB_Parameters
{
    UCHAR WordCount;
}
SMB_Data
{
    USHORT ByteCount;
}
```

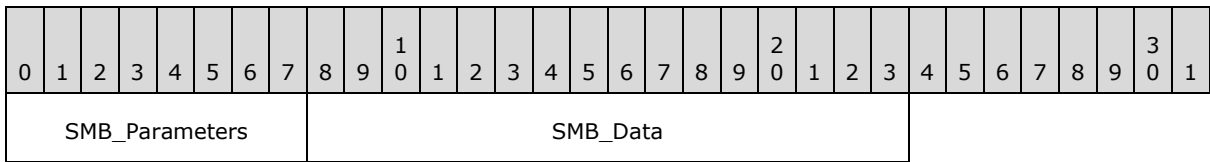

SMB_Parameters (1 byte):

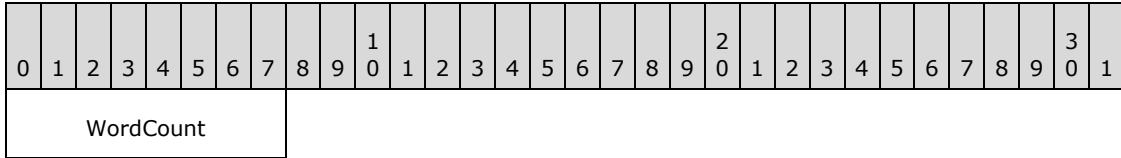

WordCount (1 byte): This field MUST be 0x00. No parameters are sent by this message.

SMB_Data (2 bytes):

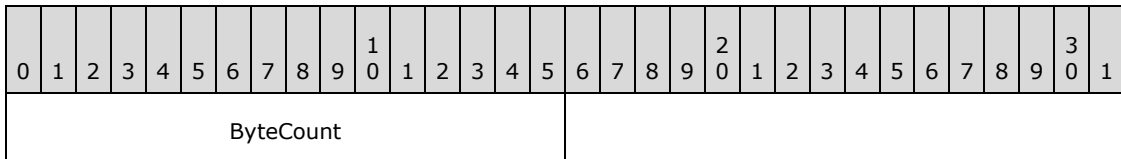

ByteCount (2 bytes): This field MUST be 0x0000. No data is sent by this message.

Error Codes

SMB error class	SMB error code	NT status code	POSIX equivalent	Description
ERRDOS (0x01)	ERRbadfile (0x0002)	STATUS_NO_SUCH_FILE (0xC000000F)	ENOENT	File not found.
ERRDOS (0x01)	ERRbadpath (0x0003)	STATUS_OBJECT_PATH_SYNTAX_BAD (0xC000003B)	ENOENT	A component in the path prefix is not a directory.
ERRDOS (0x01)	ERRnoaccess (0x0005)	STATUS_ACCESS_DENIED (0xC0000022)	EPERM	The new file already exists.
ERRDOS (0x01)	ERRnoaccess (0x0005)			The directory is full.
ERRDOS (0x01)	ERRnoaccess (0x0005)			The old path is the mounted point for a file system.
ERRDOS (0x01)	ERRnoaccess (0x0005)			The old path is the last link to an executing program.
ERRDOS (0x01)	ERRdiffdevice (0x0011)	STATUS_NOT_SAME_DEVICE (0xC00000D4)	EXDEV	The new path is on a different file

SMB error class	SMB error code	NT status code	POSIX equivalent	Description
				system.
ERRDOS (0x01)	ERRbadshare (0x0020)	STATUS_SHARING_VIOLATION (0xC0000043)	ETXTBSY	Sharing violation. A requested open mode conflicts with the sharing mode of an existing file handle.
ERRDOS (0x01)	ERRfileexists (0x0051)	STATUS_OBJECT_NAME_COLLISION (0xC0000035)	EEXIST	The new file name already exists.
ERRSRV (0x02)	ERRerror (0x0001)	STATUS_INVALID_SMB (0x00010002)		Invalid SMB. The request contains a packaging or value error.
ERRSRV (0x02)	ERRaccess (0x0004)	STATUS_NETWORK_ACCESS_DENIED (0xC00000CA)	EACCES	Access denied. The specified UID does not have permission to execute the requested command within the current context (TID).
ERRSRV (0x02)	ERRaccess (0x0004)			An attempt was made to change a volume label.
ERRSRV (0x02)	ERRinvtid (0x0005)	STATUS_SMB_BAD_TID (0x00050002)		The TID specified in the command was invalid.
ERRSRV (0x02)	ERRnomem (0x0008)	STATUS_INSUFF_SERVER_RESOURCES (0xC0000205)	ENOMEM	The server is out of resources.
ERRSRV (0x02)	ERRbaduid (0x005B)	STATUS_SMB_BAD_UID (0x005B0002)		The UID specified is not known as a valid ID on this server session.
ERRHRD (0x03)	ERRnowrite (0x0013)	STATUS_MEDIA_WRITE_PROTECTED (0x0C00000A2)	EROFS	Attempt to modify a read-only file system.

2.2.4.9 SMB_COM_QUERY_INFORMATION (0x08)

This is an original **Core Protocol** command. This command is deprecated. New client implementations SHOULD use the [SMB_COM_TRANSACTION2 \(section 2.2.4.46\)](#) subcommand [TRANS2_QUERY_PATH_INFORMATION \(section 2.2.6.6\)](#) instead.

This command MAY be sent by a client to obtain attribute information about a file using the name and path to the file. No **FID** is required.

2.2.4.9.1 Request

```
SMB_Parameters
{
  UCHAR WordCount;
}
SMB_Data
{
  USHORT ByteCount;
  Bytes
  {
    UCHAR BufferFormat;
    SMB_STRING FileName;
  }
}
```

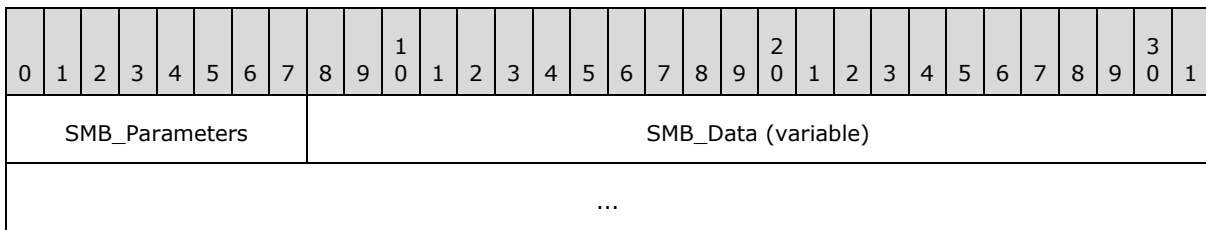

SMB_Parameters (1 byte):

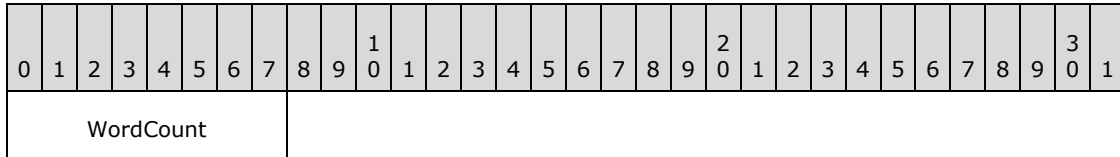

WordCount (1 byte): This field MUST be 0x00. No parameters are sent by this message.

SMB_Data (variable):

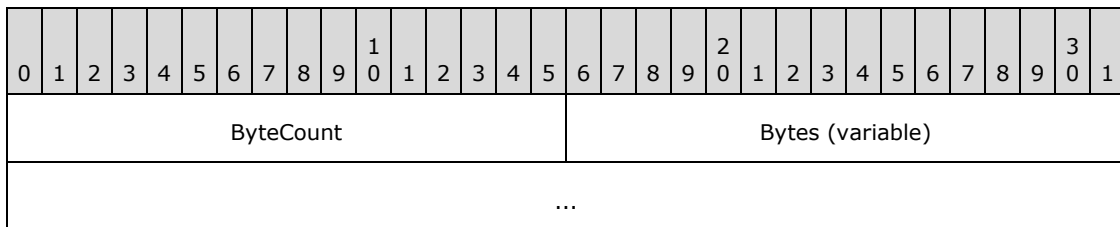

ByteCount (2 bytes): This field MUST be greater than or equal to 0x0002.

Bytes (variable):

0	1	2	3	4	5	6	7	8	9	0	1	2	3	4	5	6	7	8	9	0	1	2	3	4	5	6	7	8	9	0	1		
BufferFormat										FileName (variable)																							
...																																	

BufferFormat (1 byte): This field MUST be 0x04.

FileName (variable): A null-terminated string that represents the fully qualified name of the file relative to the supplied **TID**. This is the file for which attributes are queried and returned.

2.2.4.9.2 Response

```

SMB_Parameters
{
  UCHAR  WordCount;
  Words
  {
    SMB_FILE_ATTRIBUTES FileAttributes;
    UTIME                LastWriteTime;
    ULONG               FileSize;
    USHORT              Reserved[5];
  }
}
SMB_Data
{
  USHORT ByteCount;
}

```

0	1	2	3	4	5	6	7	8	9	0	1	2	3	4	5	6	7	8	9	0	1	2	3	4	5	6	7	8	9	0	1		
SMB_Parameters																																	
...																																	
...																																	
...																																	
...																																	
...										SMB_Data																							

SMB_Parameters (21 bytes):

0	1	2	3	4	5	6	7	8	9	10	11	12	13	14	15	16	17	18	19	20	21	22	23	24	25	26	27	28	29	30	31					
WordCount										Words																										
...																																				
...																																				
...																																				
...																																				
...																																				

WordCount (1 byte): This field MUST be 0x0A.

Words (20 bytes):

0	1	2	3	4	5	6	7	8	9	10	11	12	13	14	15	16	17	18	19	20	21	22	23	24	25	26	27	28	29	30	31
FileAttributes																LastWriteTime															
...																FileSize															
...																Reserved															
...																															
...																															

FileAttributes (2 bytes): This field is a 16-bit unsigned bit field encoded as **SMB_FILE_ATTRIBUTES** (see section [2.2.1.2.4](#)).

LastWriteTime (4 bytes): The time of the last write to the file.

FileSize (4 bytes): This field contains the size of the file, in bytes. Because this size is limited to 32 bits, this command is inappropriate for files whose size is too large.

Reserved (10 bytes): This field is reserved, and all entries MUST be set to 0x00.

SMB_Data (2 bytes):

0	1	2	3	4	5	6	7	8	9	10	11	12	13	14	15	16	17	18	19	20	21	22	23	24	25	26	27	28	29	30	31
ByteCount																															

ByteCount (2 bytes): This field MUST be 0x0000. No data is sent by this message.

Error Codes

SMB error class	SMB error code	NT status code	POSIX equivalent	Description
ERRDOS (0x01)	ERRbadfile (0x0002)	STATUS_NO_SUCH_FILE (0xC000000F)	ENOENT	The file does not exist.
ERRDOS (0x01)	ERRbadpath (0x0003)	STATUS_OBJECT_PATH_NOT_FOUND (0xC000003A)	ENOENT	The file path syntax is invalid.
ERRDOS (0x01)	ERRnoaccess (0x0005)	STATUS_ACCESS_DENIED (0xC0000022)	EPERM	Access denied.
ERRDOS (0x01)	ERRnomem (0x0008)	STATUS_INSUFF_SERVER_RESOURCES (0xC0000022)	EPERM	Access denied.
ERRSRV (0x02)	ERRerror (0x0001)	STATUS_INVALID_SMB (0x00010002)		Invalid SMB. Not enough parameter bytes were sent.
ERRSRV (0x02)	ERRaccess (0x0004)	STATUS_NETWORK_ACCESS_DENIED (0xC00000CA)		The specified UID does not have permission to execute the requested command within the context of the TID .
ERRSRV (0x02)	ERRinvtid (0x0005)	STATUS_SMB_BAD_TID (0x00050002)		The TID is no longer valid.
ERRSRV (0x02)	ERRbaduid (0x005B)	STATUS_SMB_BAD_UID (0x005B0002)		The UID supplied is not known to the session.
ERRHRD (0x03)	ERRnotready (0x0015)	STATUS_NO_MEDIA_IN_DEVICE (0x0xC0000013)		Share represents a removable device and there is no media present in the device.
ERRHRD (0x03)	ERRdata (0x0017)	STATUS_DATA_ERROR (0xC000003E)	EIO	Disk I/O error.

2.2.4.10 SMB_COM_SET_INFORMATION (0x09)

This is an original **Core Protocol** command. This command is deprecated. New client implementations SHOULD use the [SMB_COM_TRANSACTION2 \(section 2.2.4.46\)](#) subcommand [TRANS2_SET_PATH_INFORMATION \(section 2.2.6.7\)](#) instead.

This command MAY be sent by a client to change the attribute information of a regular file or directory.

FileName MUST be the fully qualified name of the file relative to the **TID**. Support of all parameters is optional. A server that does not implement one of the parameters MUST ignore that field. If the **LastWriteTime** field contains 0x00000000, then the file's **LastWriteTime** MUST NOT be changed.

2.2.4.10.1 Request

```

SMB_Parameters
{
  UCHAR WordCount;
  Words
  {
    SMB_FILE_ATTRIBUTES FileAttributes;
    UTIME                LastWriteTime;
    USHORT               Reserved[5];
  }
}
SMB_Data
{
  USHORT ByteCount;
  Bytes
  {
    UCHAR      BufferFormat;
    SMB_STRING FileName;
  }
}

```

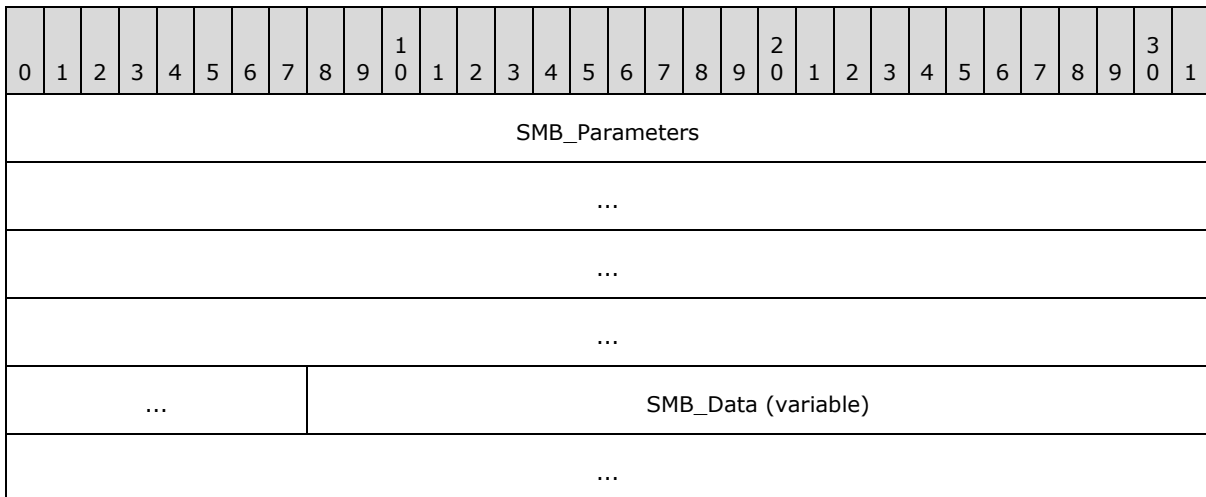

SMB_Parameters (17 bytes):

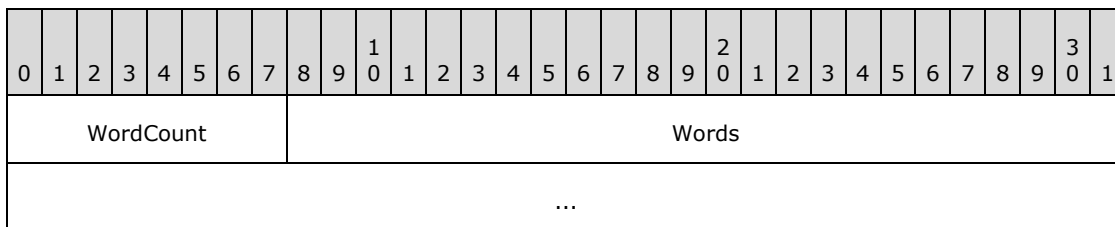

...
...
...

WordCount (1 byte): This field MUST be 0x08.

Words (16 bytes):

0	1	2	3	4	5	6	7	8	9	10	11	12	13	14	15	16	17	18	19	20	21	22	23	24	25	26	27	28	29	30	31
FileAttributes										LastWriteTime																					
...										Reserved																					
...																															
...																															

FileAttributes (2 bytes): This field is a 16-bit unsigned bit field encoded as SMB_FILE_ATTRIBUTES (section 2.2.4.10.1)

LastWriteTime (4 bytes): The time of the last write to the file.

Reserved (10 bytes): This field is reserved, and all bytes MUST be set to 0x00.

SMB_Data (variable):

0	1	2	3	4	5	6	7	8	9	10	11	12	13	14	15	16	17	18	19	20	21	22	23	24	25	26	27	28	29	30	31
ByteCount										Bytes (variable)																					
...																															

ByteCount (2 bytes): This field MUST be greater than or equal to 0x0002.

Bytes (variable):

0	1	2	3	4	5	6	7	8	9	10	11	12	13	14	15	16	17	18	19	20	21	22	23	24	25	26	27	28	29	30	31
BufferFormat										FileName (variable)																					
...																															

BufferFormat (1 byte): This field MUST be 0x04.

FileName (variable): A null-terminated string that represents the fully qualified name of the file relative to the supplied **TID**. This is the file for which attributes are set.

2.2.4.10.2 Response

```
SMB_Parameters
{
  UCHAR WordCount;
}
SMB_Data
{
  USHORT ByteCount;
}
```

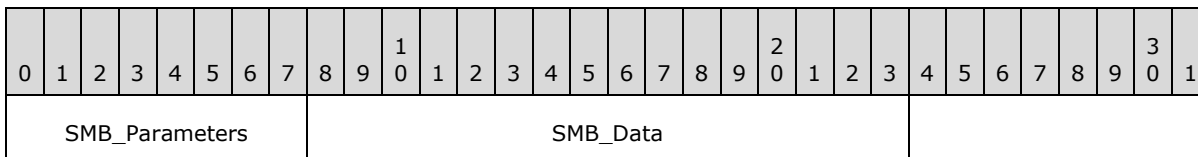

SMB_Parameters (1 byte):

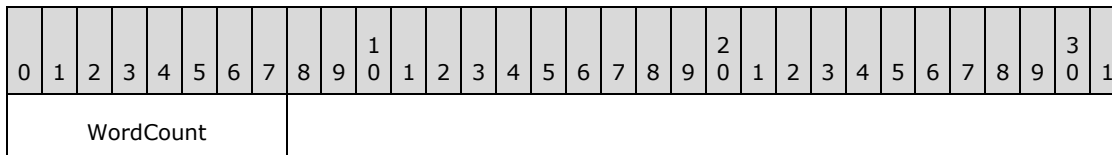

WordCount (1 byte): This field MUST be 0x00. No parameters are sent by this message.

SMB_Data (2 bytes):

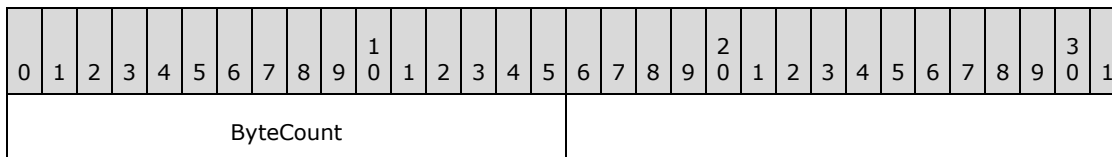

ByteCount (2 bytes): This field MUST be 0x0000. No data is sent by this message.

Error Codes

SMB error class	SMB error code	NT status code	POSIX equivalent	Description
ERRDOS (0x01)	ERRbadfile (0x0002)	STATUS_NO_SUCH_FILE (0xC000000F)	ENOENT	The file was not found.
ERRDOS (0x01)	ERRbadpath (0x0003)	STATUS_OBJECT_PATH_SYNTAX_BAD (0xC000003B)	ENOTDIR	A portion of the path is not a directory.
ERRDOS	ERRnoaccess	STATUS_ACCESS_DENIED	EPERM	Read permission denied on a

SMB error class	SMB error code	NT status code	POSIX equivalent	Description
(0x01)	(0x0005)	(0xC0000022)		portion of the path.
ERRDOS (0x01)	ERRnomem (0x0008)	STATUS_INSUFF_SERVER_RESOURCES (0xC0000205) STATUS_NO_MEMORY (0xC0000017)	ENOMEM	The server is out of resources.
ERRDOS (0x01)	ERRinvalidparam (0x0057)	STATUS_INVALID_PARAMETER (0xC000000D)		One of the attributes in FileAttributes was invalid.
ERRSRV (0x02)	ERRerror (0x0001)	STATUS_INVALID_SMB (0x00010002)		Invalid SMB. Error in request format or session has not been established.
ERRSRV (0x02)	ERRaccess (0x0004)	STATUS_NETWORK_ACCESS_DENIED (0xC00000CA)		Access denied. The specified UID does not have permission to execute the requested command within the current context (TID).
ERRSRV (0x02)	ERRinvtid (0x0005)	STATUS_SMB_BAD_TID (0x00050002)		The TID is no longer valid or the tree connect is closing.
ERRSRV (0x02)	ERRinvtid (0x0005)	STATUS_ACCESS_DENIED (0xC0000022)		Share type does not match share type of TID OR the null session is not allowed to access the TID.
ERRSRV (0x02)	ERRbaduid (0x005B)	STATUS_SMB_BAD_UID (0x005B0002)		The UID supplied is not known to the session.
ERRHRD (0x03)	ERRnotready (0x0015)	STATUS_NO_MEDIA_IN_DEVICE (0x0xC0000013)		Share represents a removable device and there is no media present in the device.

SMB error class	SMB error code	NT status code	POSIX equivalent	Description
ERRHRD (0x03)	ERRdata (0x0017)	STATUS_DATA_ERROR (0xC000003E)	EIO	Disk I/O error.

2.2.4.11 SMB_COM_READ (0x0A)

This is an original **Core Protocol** command. This command is deprecated. Clients SHOULD use [SMB_COM_READ_ANDX \(section 2.2.4.42\)](#).

This command is used to read bytes from a regular file. If the client has negotiated a protocol that supports named pipes or directly accessible devices, this command can also be used to read from those objects. The end of file condition is indicated by the server returning fewer bytes than the client requested. A read request starting at or beyond the end of the file returns zero bytes. If a read requests more data than can be placed in a message of **MaxBufferSize** for the SMB connection, the server MUST abort the connection to the client. Because this client request supports 32-bit offsets only, it is inappropriate for files that have 64-bit offsets. The client MUST have at least read access to the file.

2.2.4.11.1 Request

```
SMB_Parameters
{
    UCHAR    WordCount;
    Words
    {
        SHORT    FID;
        USHORT   CountOfBytesToRead;
        ULONG    ReadOffsetInBytes;
        USHORT   EstimateOfRemainingBytesToBeRead;
    }
}
SMB_Data
{
    USHORT    ByteCount;
}
```

SMB_Header

Flags2 (2 bytes):

Name and bitmask	Relevance
SMB_FLAGS2_READ_IF_EXECUTE 0x2000	If the bit is set and client has execute permission on the file, then the client MAY read the file even if the client does not have READ permission. This flag is also known as SMB_FLAGS2_PAGING_IO.

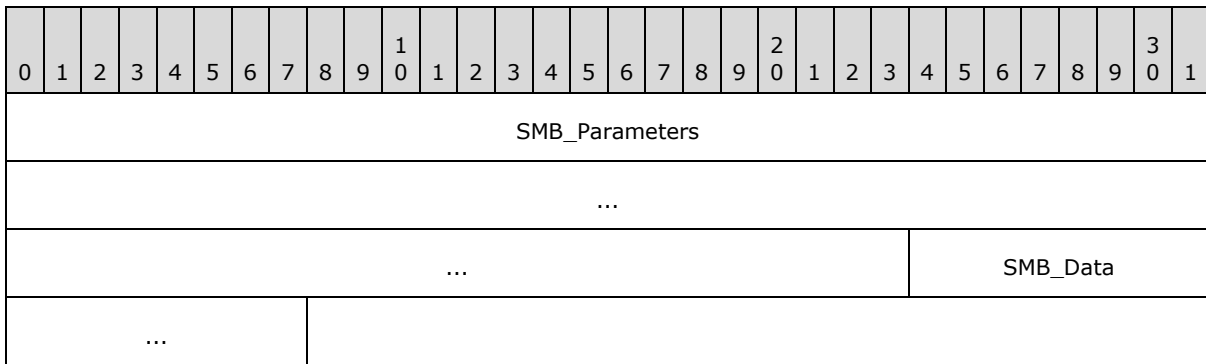

SMB_Parameters (11 bytes):

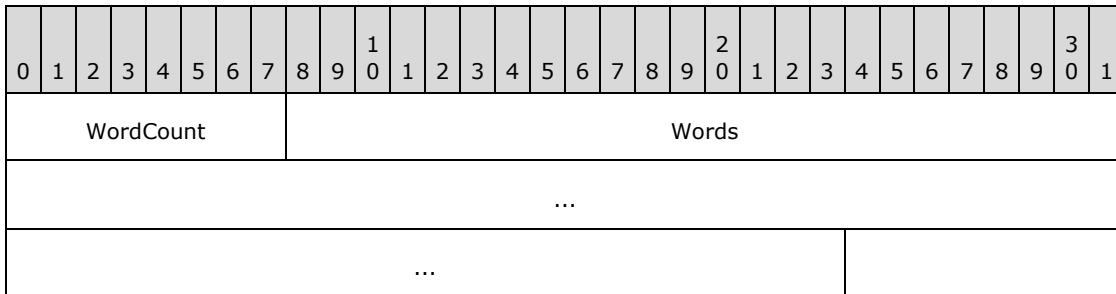

WordCount (1 byte): This field MUST be 0x05.

Words (10 bytes):

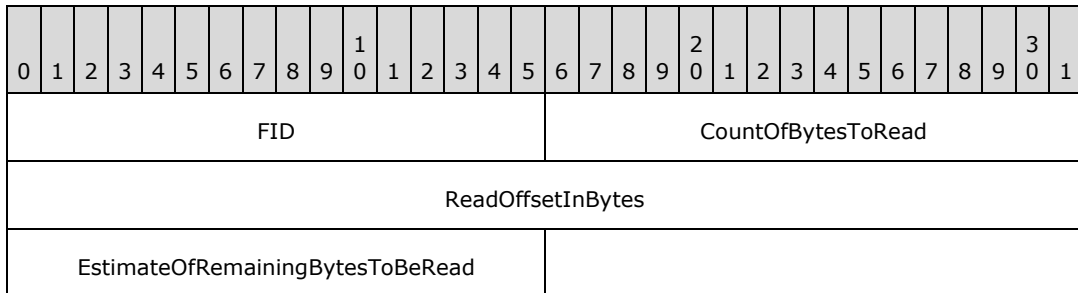

FID (2 bytes): This field MUST be a valid 16-bit signed integer indicating the file from which the data MUST be read.

CountOfBytesToRead (2 bytes): This field is a 16-bit unsigned integer indicating the number of bytes to be read from the file. The client MUST ensure that the amount of data requested will fit in the negotiated maximum buffer size.

ReadOffsetInBytes (4 bytes): This field is a 32-bit unsigned integer indicating the offset, in number of bytes, from which to begin reading from the file. The client MUST ensure that the amount of data requested fits in the negotiated maximum buffer size. Because this field is limited to 32 bits, this command is inappropriate for files having 64-bit offsets.

EstimateOfRemainingBytesToBeRead (2 bytes): This field is a 16-bit unsigned integer indicating the remaining number of bytes that the client intends to read from the file. This is an advisory field and MAY be 0x0000.

SMB_Data (2 bytes):

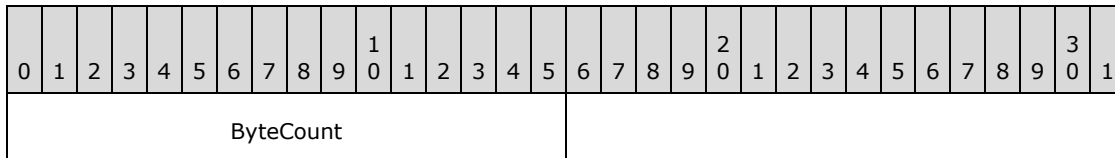

ByteCount (2 bytes): This field MUST be 0x0000. No data is sent by this message.

2.2.4.11.2 Response

```

SMB_Parameters
{
    UCHAR    WordCount;
    Words
    {
        USHORT CountOfBytesReturned;
        USHORT Reserved[4];
    }
}
SMB_Data
{
    USHORT ByteCount;
    Bytes
    {
        UCHAR    BufferFormat;
        USHORT CountOfBytesRead;
        UCHAR    Bytes[CountOfBytesRead];
    }
}
    
```

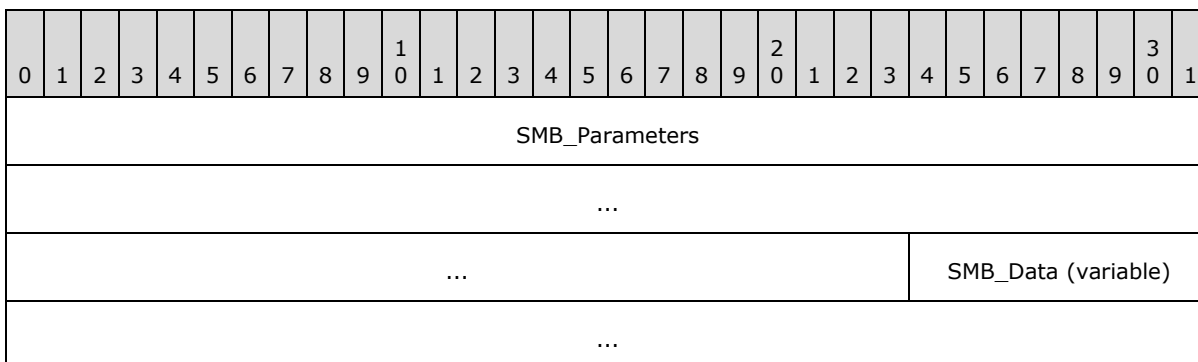

SMB_Parameters (11 bytes):

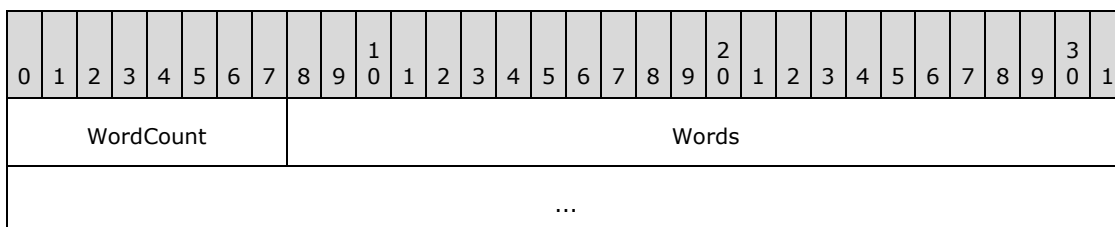

...

WordCount (1 byte): This field MUST be 0x05.

Words (10 bytes):

0	1	2	3	4	5	6	7	8	9	10	11	12	13	14	15	16	17	18	19	20	21	22	23	24	25	26	27	28	29	30	31
CountOfBytesReturned																Reserved															
...																															
...																															

CountOfBytesReturned (2 bytes): The actual number of bytes returned to the client. This MUST be equal to **CountOfBytesToRead** unless the end of file was reached before reading **CountOfBytesToRead** bytes or the **ReadOffsetInBytes** pointed at or beyond the end of file.

Reserved (8 bytes): Reserved. All bytes MUST be 0x00.

SMB_Data (variable):

0	1	2	3	4	5	6	7	8	9	10	11	12	13	14	15	16	17	18	19	20	21	22	23	24	25	26	27	28	29	30	31
ByteCount																															

ByteCount (2 bytes): This field MUST be 0x0003 + **CountOfBytesRead**.

Bytes:

0	1	2	3	4	5	6	7	8	9	10	11	12	13	14	15	16	17	18	19	20	21	22	23	24	25	26	27	28	29	30	31
BufferFormat								CountOfBytesRead																Bytes (variable)							
...																															

BufferFormat (1 byte): This field MUST be 0x01.

CountOfBytesRead (2 bytes): The number of bytes read that are contained in the following array of bytes.

Bytes (variable): The actual bytes read from the file.

Error Codes

SMB error class	SMB error code	NT status code	POSIX equivalent	Description
ERRDOS (0x01)	ERRnoaccess (0x0005)	STATUS_ALREADY_COMMITTED (0xC0000021)	ENOLCK	Attempt to read from a portion of the file that the server determines has been locked or has been opened in deny-read mode.
ERRDOS (0x01)	ERRbadfid (0x0006)	STATUS_INVALID_HANDLE (0xC0000008) STATUS_SMB_BAD_FID (0x00060001)	ENFILE	Attempt to read from a FID that the server does not have open.
ERRDOS (0x01)	ERRnomem (0x0008)	STATUS_INSUFF_SERVER_RESOURCES (0xC0000205)	ENOMEM	The server is out of resources.
ERRDOS (0x01)	ERRbadaccess (0x000C)	STATUS_ACCESS_DENIED (0xC0000022)		Read permission required.
ERRDOS (0x01)	ERRlock (0x0021)	STATUS_FILE_LOCK_CONFLICT (0xC0000054) STATUS_LOCK_NOT_GRANTED (0xC0000055)	EAGAIN	The requested byte range was already locked by a different process (PID).
ERRDOS (0x01)	ERReof (0x0026)	STATUS_END_OF_FILE (0xC0000011)		Attempted to read beyond the end of the file.
ERRDOS (0x01)	ERRmoredata (0x00EA)	STATUS_BUFFER_OVERFLOW (0x80000005)		The message on a message mode named pipe exceeds the requested number of bytes. The server MUST send a full SMB_COM_READ response with this error code. The requested number of bytes are read and returned to the client.
ERRSRV (0x02)	ERRerror (0x0001)		EBADF	The FID was validated by the server but unacceptable to the system.
ERRSRV (0x02)	ERRerror (0x0001)		EDEADLK	The read would block and deadlock would result.

SMB error class	SMB error code	NT status code	POSIX equivalent	Description
ERRSRV (0x02)	ERRerror (0x0001)	STATUS_INVALID_SMB (0x00010002)		A corrupt request has been encountered.
ERRSRV (0x02)	ERRinvdevice (0x0007)	STATUS_BAD_DEVICE_TYPE (0xC00000CB)		Attempt to read from an open spool file.
ERRSRV (0x02)	ERRinvtid (0x0005)	STATUS_SMB_BAD_TID (0x00050002)		Invalid TID in request.
ERRSRV (0x02)	ERRbaduid (0x005B)	STATUS_SMB_BAD_UID (0x005B0002)		The UID specified is not known as a valid ID for this session, or the user identified by the UID does not have sufficient privileges.
ERRHRD (0x03)	ERRdata (0x0017)	STATUS_DATA_ERROR (0xC000003E)	EIO	A problem has occurred in the physical I/O.
ERRHRD (0x03)	ERRread (0x001E)		ENXIO	The device associated with the file descriptor is a block-special or character-special file and the value of the file pointer is out of range.

2.2.4.12 SMB_COM_WRITE (0x0B)

This is an original **Core Protocol** command. This command is deprecated. Clients SHOULD use the SMB_COM_WRITE_ANDX command. Support for named pipes and I/O devices was introduced in the **LAN Manager 1.0** dialect.

This command is used to write bytes to a regular file. If the client has negotiated a protocol dialect that supports named pipes, mailslots, or directly accessible devices, this command MAY also be used to write to those object. This command MAY also be used to truncate a file to a specified point or to extend a file beyond its current size. The command MUST include a valid TID and FID in the request. This command supports 32-bit offsets only and is inappropriate for files having 64-bit offsets. The client SHOULD use SMB_COM_WRITE_ANDX to write to files requiring a 64-bit file offset.

When FID represents a disk file and the request specifies a byte range (WriteOffsetInBytes) beyond the current end of file, the file MUST be extended. Any bytes between the previous end of file and the requested offset are initialized to 0x00. When a write specifies a length (CountOfBytesToWrite) of 0x0000, the file is truncated (or extended) to the length specified by the offset.

The client MUST have at least write access to the file.

2.2.4.12.1 Request

```

SMB_Parameters
{
  UCHAR WordCount;
  Words
  {
    USHORT FID;
    USHORT CountOfBytesToWrite;
    ULONG WriteOffsetInBytes;
    USHORT EstimateOfRemainingBytesToBeWritten;
  }
}
SMB_Data
{
  USHORT ByteCount;
  Bytes
  {
    UCHAR BufferFormat;
    USHORT DataLength;
    UCHAR Data[ CountOfBytesToWrite ];
  }
}

```

SMB_Header:

TID (2 bytes): This field MUST contain a valid TID.

UID (2 bytes): This field MUST contain a valid UID.

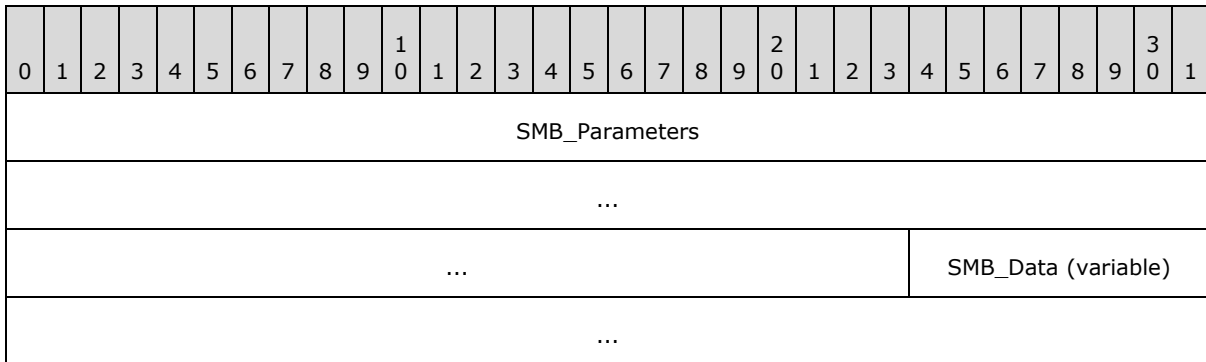

SMB_Parameters (11 bytes):

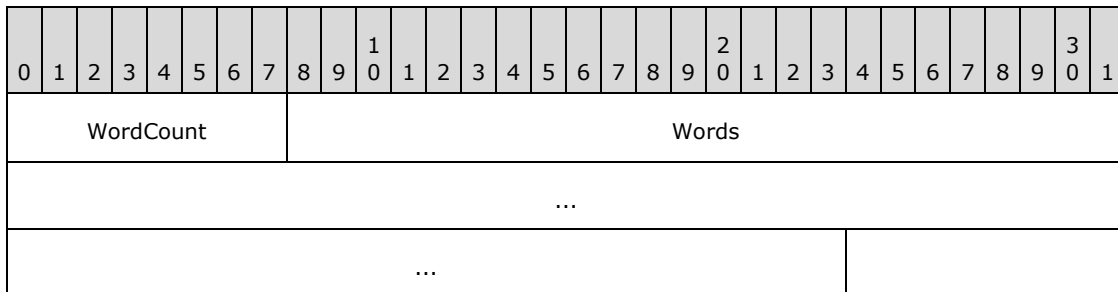

WordCount (1 byte): This field MUST be 0x05.

Words (10 bytes):

0	1	2	3	4	5	6	7	8	9	10	11	12	13	14	15	16	17	18	19	20	21	22	23	24	25	26	27	28	29	30	31
FID																CountOfBytesToWrite															
WriteOffsetInBytes																															
EstimateOfRemainingBytesToBeWritten																															

FID (2 bytes): This field MUST be a valid 16-bit unsigned integer indicating the file to which the data MUST be written.

CountOfBytesToWrite (2 bytes): This field is a 16-bit unsigned integer indicating the number of bytes to be written to the file. The client MUST ensure that the amount of data sent can fit in the negotiated maximum buffer size.

WriteOffsetInBytes (4 bytes): This field is a 32-bit unsigned integer indicating the offset, in number of bytes, from the beginning of the file at which to begin writing to the file. The client MUST ensure that the amount of data sent fits in the negotiated maximum buffer size. Because this field is limited to 32 bits, this command is inappropriate for files that have 64-bit offsets.

EstimateOfRemainingBytesToBeWritten (2 bytes): This field is a 16-bit unsigned integer indicating the remaining number of bytes that the client anticipates to write to the file. This is an advisory field and can be 0x0000. This information can be used by the server to optimize cache behavior.

SMB_Data (variable):

0	1	2	3	4	5	6	7	8	9	10	11	12	13	14	15	16	17	18	19	20	21	22	23	24	25	26	27	28	29	30	31
ByteCount																Bytes (variable)															
...																															

ByteCount (2 bytes): This field MUST be greater than or equal to 0x0003. The total value represents the size of the **BufferFormat** field in bytes plus the size of the **DataLength** field in bytes plus the value of the **CountOfBytesToWrite** field. See [Data Buffer Format Codes \(section 2.2.2.5\)](#) for a complete description of data buffer format codes and their usages.

Bytes (variable):

0	1	2	3	4	5	6	7	8	9	10	11	12	13	14	15	16	17	18	19	20	21	22	23	24	25	26	27	28	29	30	31
BufferFormat										DataLength										Data (variable)											

...

BufferFormat (1 byte): This field MUST be 0x01.

DataLength (2 bytes): This field MUST match **SMB_Parameters.CountOfBytesToWrite**.

Data (variable): The raw bytes to be written to the file.

2.2.4.12.2 Response

```
SMB_Parameters
{
  UCHAR WordCount;
  Words
  {
    USHORT CountOfBytesWritten;
  }
}
SMB_Data
{
  USHORT ByteCount;
}
```

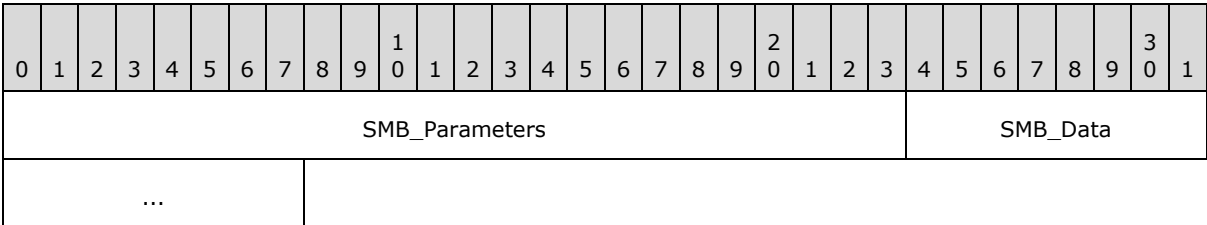

SMB_Parameters (3 bytes):

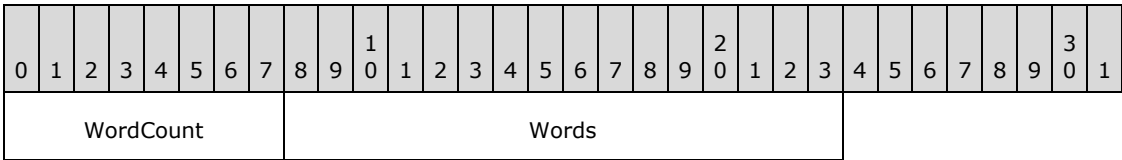

WordCount (1 byte): This field MUST be 0x01.

Words (2 bytes):

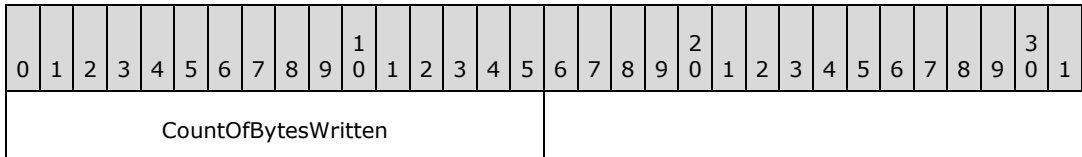

CountOfBytesWritten (2 bytes): Indicates the actual number of bytes written to the file. For successful writes, this MUST equal the CountOfBytesToWrite in the client Request. If the number of bytes written differs from the number requested and no error is indicated, then the server has no resources available to satisfy the complete write.

SMB_Data (2 bytes):

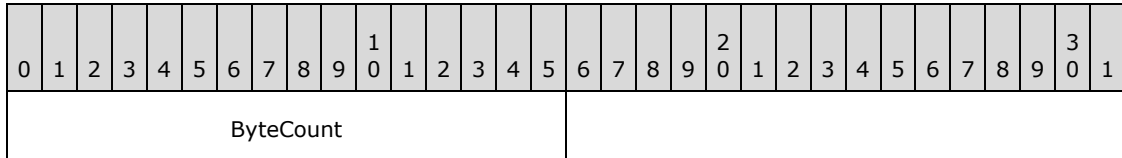

ByteCount (2 bytes): This field MUST be 0x0000. No data is sent by this message.

Error Codes

SMB error class	SMB error code	NT status code	POSIX equivalent	Description
SUCCESS (0x00)	SUCCESS (0x0000)		EFBIG	The file has grown too large and no more data can be written to the file. A Count of zero (0x0000) MUST be returned to the client in the server response. This indicates to the client that the file system is full.
SUCCESS (0x00)	SUCCESS (0x0000)		NOSPC	No space on the file system. The server MUST return a zero (0x0000) in the Count field of the response. This indicates that the file system is full.
ERRDOS (0x01)	ERRnoaccess (0x0005)		EAGAIN	Resources for I/O on the server are temporarily exhausted.
ERRDOS (0x01)	ERRnoaccess (0x0005)	STATUS_ALREADY_COMMITTED (0xC0000021)	ENOLCK	A record lock has been taken on the file or the client has attempted to write to a portion of the

SMB error class	SMB error code	NT status code	POSIX equivalent	Description
				file that the server determines has been locked, opened in deny-write mode, or opened in read-only mode.
ERRDOS (0x01)	ERRbadfid (0x0006)	STATUS_INVALID_HANDLE (0xC0000008) STATUS_SMB_BAD_FID (0x00060001)	ENFILE	Invalid FID, or FID mapped to a valid server FID but it was not acceptable to the operating system.
ERRDOS (0x01)	ERRnomem (0x0008)	STATUS_INSUFF_SERVER_RESOURCES (0xC0000205) STATUS_NO_MEMORY (0xC0000017)	ENOMEM	The server is out of resources.
ERRDOS (0x01)	ERRbadaccess (0x000C)	STATUS_ACCESS_DENIED (0xC0000022)		Write permission required.
ERRDOS (0x01)	ERRlock (0x0021)	STATUS_FILE_LOCK_CONFLICT (0xC0000054)		The requested byte range was already locked by a different process (PID).
ERRDOS (0x01)	ERRnotconnected (0x00E9)	STATUS_PIPE_DISCONNECTED (0xC00000B0)	EPIPE	Write to a named pipe with no reader.
ERRSRV (0x02)	ERRerror (0x0001)		EDEADLK	The write would block due to locking and deadlock would result.
ERRSRV (0x02)	ERRerror (0x0001)		ERANGE	Attempted write size is outside of the minimum or maximum ranges that can be written to the supplied FID.

SMB error class	SMB error code	NT status code	POSIX equivalent	Description
ERRSRV (0x02)	ERRerror (0x0001)	STATUS_INVALID_SMB (0x00010002)		A corrupt or invalid SMB request was received.
ERRSRV (0x02)	ERRinvtid (0x0005)	STATUS_SMB_BAD_TID (0x00050002)		Invalid TID in request.
ERRSRV (0x02)	ERRqfull (0x0031)	STATUS_PRINT_QUEUE_FULL (0xC00000C6)		Print queue is full - too many queued items.
ERRSRV (0x02)	ERRqtoobig (0x0032)	STATUS_NO_SPOOL_SPACE (0xC00000C7)		Print queue is full - too many queued items.
ERRSRV (0x02)	ERRbaduid (0x005B)	STATUS_SMB_BAD_UID (0x005B0002)		The UID specified is not a valid ID on this server session, or the user identified by the UID does not have sufficient privileges.
ERRHRD (0x03)	ERRdata (0x0017)	STATUS_DATA_ERROR (0xC000003E)	EIO	A problem has occurred in the physical I/O.
ERRHRD (0x03)	ERRwrite (0x001D)		ENXIO	The device associated with the file descriptor is a block-special or character-special file, and the value of the file pointer is out of range.
ERRHRD (0x03)	ERRdiskfull (0x0027)	STATUS_DISK_FULL (0xC000007F)	ENOSPC	The file system is full.

2.2.4.13 SMB_COM_LOCK_BYTE_RANGE (0x0C)

This is an original **Core Protocol** command. This command is deprecated. Clients SHOULD use the [SMB_COM_LOCKING_ANDX \(section 2.2.4.32\)](#) command.

This command is not compatible with files having greater than 32-bit offsets. The SMB_COM_LOCKING_ANDX command introduced in the **LAN Manager 1.0** dialect was modified in the NT LAN Manager dialect to support files that have 64-bit offsets. SMB_COM_LOCKING_ANDX is the preferred method of locking and unlocking byte ranges for clients that negotiate the **LAN**

Manager 1.0 dialect or later. The client MUST negotiate NT LAN Manager or later dialect to access the support for 64-bit file offsets.

This command is used to explicitly lock a contiguous range of bytes in an open regular file. More than one non-overlapping byte range can be locked in any specified file. Locks prevent attempts to lock, read, or write the locked portion of the file by other clients or **PIDs**. Overlapping locks MUST be failed with STATUS_LOCK_NOT_GRANTED (ERRDOS/ERRlock). Offsets beyond the current end of file are allowed to be locked. Such locks MUST NOT cause allocation of additional file space. Locks MUST be unlocked only by the client **PID** that performed the lock.

Because this client request supports 32-bit offsets only, it is inappropriate for files that have 64-bit offsets. The client MUST have at least read access to the file.

2.2.4.13.1 Request

```
SMB_Parameters
{
  UCHAR  WordCount;
  Words
  {
    USHORT  FID;
    ULONG   CountOfBytesToLock;
    ULONG   LockOffsetInBytes;
  }
}
SMB_Data
{
  USHORT  ByteCount;
}
```

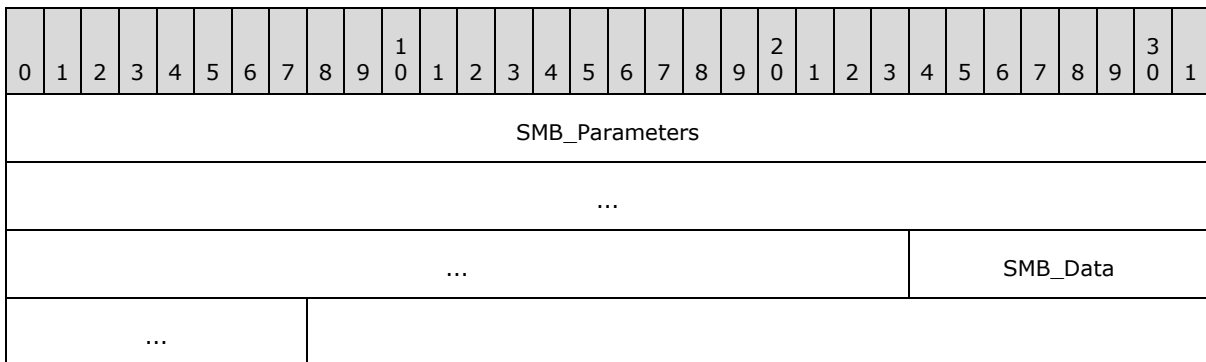

SMB_Parameters (11 bytes):

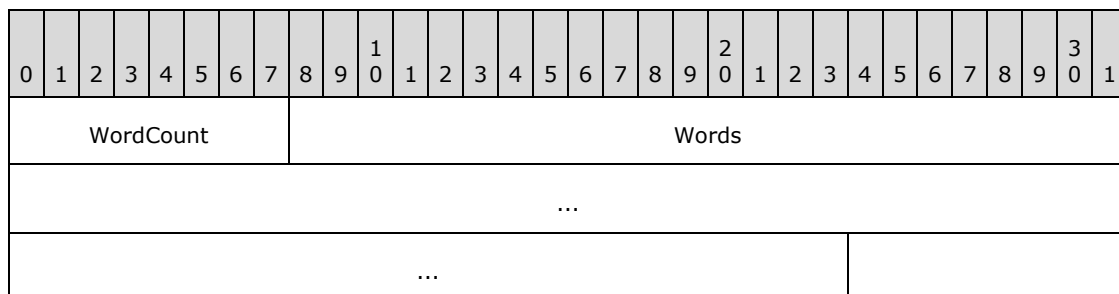

WordCount (1 byte): This field MUST be 0x05.

Words (10 bytes):

0	1	2	3	4	5	6	7	8	9	10	11	12	13	14	15	16	17	18	19	20	21	22	23	24	25	26	27	28	29	30	31
FID																CountOfBytesToLock															
...																LockOffsetInBytes															
...																															

FID (2 bytes): This field MUST be a valid 16-bit unsigned integer indicating the file from which the data MUST be read.

CountOfBytesToLock (4 bytes): This field is a 32-bit unsigned integer indicating the number of contiguous bytes to be locked.

LockOffsetInBytes (4 bytes): This field is a 32-bit unsigned integer indicating the offset, in number of bytes, from which to begin the lock. Because this field is limited to 32 bits, this command is inappropriate for files that have 64-bit offsets.

SMB_Data (2 bytes):

0	1	2	3	4	5	6	7	8	9	10	11	12	13	14	15	16	17	18	19	20	21	22	23	24	25	26	27	28	29	30	31
ByteCount																															

ByteCount (2 bytes): This field MUST be 0x0000. No data is sent by this message.

2.2.4.13.2 Response

```
SMB_Parameters
{
    UCHAR WordCount;
}
SMB_Data
{
    USHORT ByteCount;
}
```

0	1	2	3	4	5	6	7	8	9	10	11	12	13	14	15	16	17	18	19	20	21	22	23	24	25	26	27	28	29	30	31
SMB_Parameters										SMB_Data																					

SMB_Parameters (1 byte):

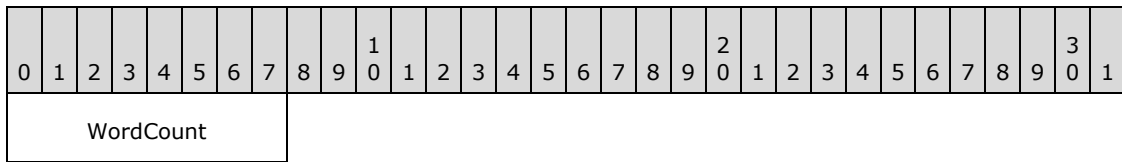

WordCount (1 byte): This field MUST be 0x00. No parameters are sent by this message.

SMB_Data (2 bytes):

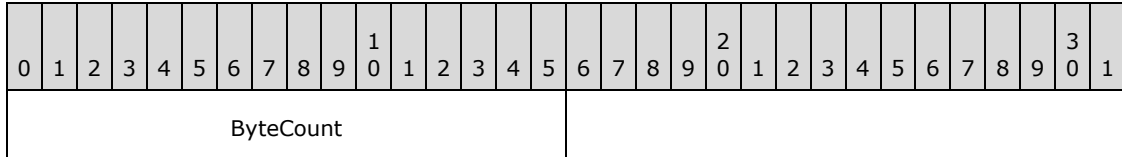

ByteCount (2 bytes): This field MUST be 0x0000. No data is sent by this message.

Error Codes

SMB error class	SMB error code	NT status code	POSIX equivalent	Description
ERRDOS (0x01)	ERRnoaccess (0x0005)	STATUS_ACCESS_DENIED	EACCESS	File access rights do not match requested locks.
ERRDOS (0x01)	ERRbadfid (0x0006)	STATUS_INVALID_HANDLE (0xC0000008) STATUS_SMB_BAD_FID (0x00060001)	ENFILE	Attempt to read from a FID that the server does not have open.
ERRDOS (0x01)	ERRnomem (0x0008)	STATUS_INSUFF_SERVER_RESOURCES (0xC0000205)	ENOMEM	Insufficient server resources to place the lock.
ERRDOS (0x01)	ERRlock (0x0021)	STATUS_FILE_LOCK_CONFLICT (0xC0000054)	EACCESS	The intended byte range has already been locked.
ERRSRV (0x02)	ERRerror (0x0001)		EBADF	A valid FID was rejected by the underlying system.
ERRSRV (0x02)	ERRerror (0x0001)		EDEADLK	The lock request would block and cause a deadlock with another process.
ERRSRV (0x02)	ERRerror (0x0001)	STATUS_INVALID_SMB (0x00010002)		Invalid SMB.
ERRSRV (0x02)	ERRinvdevice (0x0007)	STATUS_BAD_DEVICE_TYPE (0xC00000CB)		Attempt to lock a non-regular file such as a named

SMB error class	SMB error code	NT status code	POSIX equivalent	Description
				pipe.
ERRSRV (0x02)	ERRinvtid (0x0005)	STATUS_SMB_BAD_TID (0x00050002)		Invalid TID in request.
ERRSRV (0x02)	ERRbaduid (0x005B)	STATUS_SMB_BAD_UID (0x005B0002)		The UID specified is not a valid ID for this session, or the user identified by the UID does not have sufficient privileges.
ERRHRD (0x03)	ERRdata (0x0017)	STATUS_DATA_ERROR (0xC000003E)	EIO	Disk I/O error.

2.2.4.14 SMB_COM_UNLOCK_BYTE_RANGE (0x0D)

This is an original **Core Protocol** command. This command is deprecated. Clients SHOULD use the [SMB_COM_LOCKING_ANDX \(section 2.2.4.32\)](#) command.

This command is not compatible with files having greater than 32-bit offsets. The SMB_COM_LOCKING_ANDX command introduced in the **LAN Manager 1.0** dialect was modified in the NT LAN Manager dialect to support files having 64-bit offsets. SMB_COM_LOCKING_ANDX is the preferred method of locking and unlocking byte ranges for clients that negotiate the **LAN Manager 1.0** dialect or later. The client MUST negotiate the NT LAN Manager or later dialect to access the support for 64-bit file offsets.

This command is used to explicitly unlock a contiguous range of bytes in an open regular file. The byte range specified MUST be exactly the same as that specified in a previous successful lock request from the same CIFS client and process; the FID and PID MUST be the same as the lock request. An unlock request for a range that was not locked is treated as an error.

If the server cannot immediately (within 200-300 milliseconds) grant the unlock on the byte range, an error MUST be returned to the client. Because this client request supports 32-bit offsets only, it is inappropriate for files that have 64-bit offsets. The client MUST have at least read access to the file.

2.2.4.14.1 Request

```
SMB_Parameters
{
  UCHAR  WordCount;
  Words
  {
    SHORT  FID;
    ULONG  CountOfBytesToUnlock;
    ULONG  UnlockOffsetInBytes;
  }
}
SMB_Data
{
  USHORT  ByteCount;
}
```

}

SMB_Header:

TID (2 bytes): This field MUST contain a valid **TID**, and the **TID** MUST be the same **TID** used in the [SMB Header \(section 2.2.3.1\)](#) when the block range was locked.

UID (2 bytes): This field MUST contain a valid UID, and the UID MUST be the same UID used in the SMB Header when the block range was locked.

PID (2 bytes): This field MUST contain a valid **PID**, and the **PID** MUST be the same **PID** used in the SMB Header when the block range was locked.

0	1	2	3	4	5	6	7	8	9	10	11	12	13	14	15	16	17	18	19	20	21	22	23	24	25	26	27	28	29	30	31
SMB_Parameters																															
...																															
...																								SMB_Data							
...																															

SMB_Parameters (11 bytes):

0	1	2	3	4	5	6	7	8	9	10	11	12	13	14	15	16	17	18	19	20	21	22	23	24	25	26	27	28	29	30	31
WordCount											Words																				
...																															
...																															

WordCount (1 byte): This field MUST be 0x05.

Words (10 bytes):

0	1	2	3	4	5	6	7	8	9	10	11	12	13	14	15	16	17	18	19	20	21	22	23	24	25	26	27	28	29	30	31
FID											CountOfBytesToUnlock																				
...											UnlockOffsetInBytes																				
...																															

FID (2 bytes): This field MUST be a valid 16-bit signed integer indicating the file from which the data MUST be read.

CountOfBytesToUnlock (4 bytes): This field is a 32-bit unsigned integer indicating the number of contiguous bytes to be unlocked.

UnlockOffsetInBytes (4 bytes): This field is a 32-bit unsigned integer indicating the offset, in number of bytes, from which to begin the unlock. Because this field is limited to 32-bits, this command is inappropriate for files that have 64-bit offsets.

SMB_Data (2 bytes):

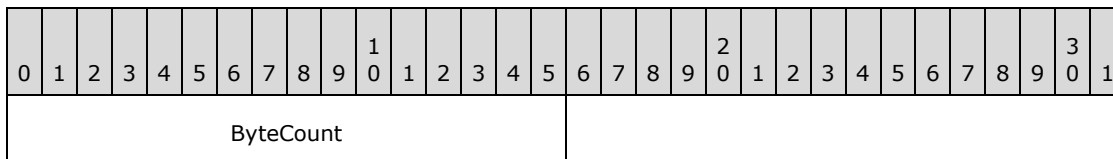

ByteCount (2 bytes): This field MUST be 0x0000. No data is sent by this message.

2.2.4.14.2 Response

```
SMB_Parameters
{
  UCHAR WordCount;
}
SMB_Data
{
  USHORT ByteCount;
}
```

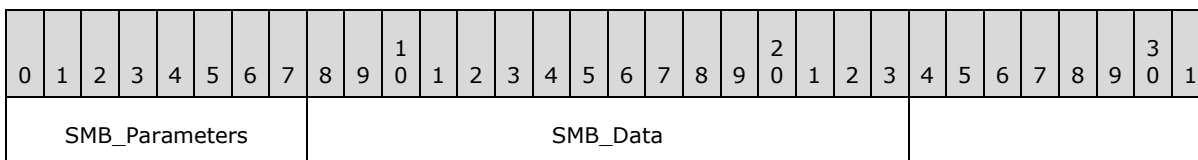

SMB_Parameters (1 byte):

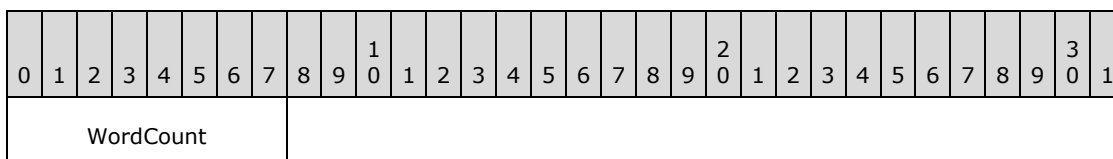

WordCount (1 byte): This field MUST be 0x00. No parameters are sent by this message.

SMB_Data (2 bytes):

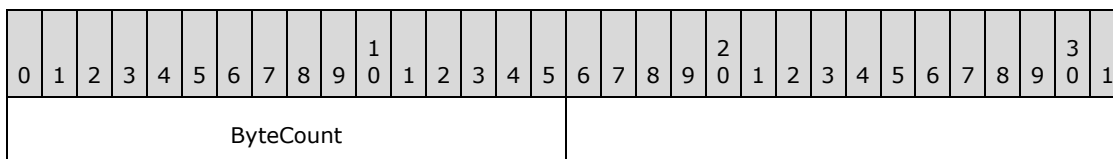

ByteCount (2 bytes): This field MUST be 0x0000. No data is sent by this message.

Error Codes

SMB error class	SMB error code	NT status code	POSIX equivalent	Description
ERRDOS (0x01)	ERRnoaccess (0x0005)	STATUS_ACCESS_DENIED (0xC0000022)	EACCESS	File access rights do not match requested locks.
ERRDOS (0x01)	ERRbadfid (0x0006)	STATUS_INVALID_HANDLE (0xC0000008) STATUS_SMB_BAD_FID (0x00060001)	ENFILE	Attempt to read from a FID that the server does not have open.
ERRDOS (0x01)	ERRnomem (0x0008)	STATUS_INSUFF_SERVER_RESOURCES (0xC0000205)	ENOLOCK	Insufficient server resources to place the lock.
ERRDOS (0x01)	ERRlock (0x0021)	STATUS_FILE_LOCK_CONFLICT (0xC0000054)	EACCESS	The intended byte range has already been locked by another process.
ERRDOS (0x01)	ERROR_NOT_LOCKED (0x009E)	STATUS_RANGE_NOT_LOCKED (0xC000007E)		The byte range specified in an unlock request was not locked.
ERRSRV (0x02)	ERRerror (0x0001)		EBADF	A valid FID was rejected by the underlying system.
ERRSRV (0x02)	ERRerror (0x0001)		EDEADLK	The lock request would block and cause a deadlock with another process.
ERRSRV (0x02)	ERRerror (0x0001)	STATUS_INVALID_SMB (0x00010002)		Invalid SMB.

SMB error class	SMB error code	NT status code	POSIX equivalent	Description
ERRSRV (0x02)	ERRinvdevice (0x0007)	STATUS_BAD_DEVICE_TYPE (0xC00000CB)		Attempt to lock a non-regular file such as a named pipe.
ERRSRV (0x02)	ERRinvtid (0x0005)	STATUS_SMB_BAD_TID (0x00050002)		Invalid TID in request.
ERRSRV (0x02)	ERRbaduid (0x005B)	STATUS_SMB_BAD_UID (0x005B0002)		The UID specified is not defined as a valid ID for this session

2.2.4.15 SMB_COM_CREATE_TEMPORARY (0x0E)

This is an original **Core Protocol** command. This command is obsolescent.

This command is used to create a file for temporary use by the client. The message includes the directory (see **DirectoryName** following) in which the client requests to create the temporary file. The server generates a file name that is unique within the supplied directory. The supplied directory **MUST** be relative to the supplied valid TID in the [SMB Header \(section 2.2.3.1\)](#). The client **MUST** have write permission on the directory in order to create the temporary file. If successful, the **FID** returned by the server **MAY** be used in subsequent file operation messages. The client **MUST** supply this FID in subsequent operations on the temporary file. The file is opened in compatibility mode with read and write permissions for the client. The server does not automatically delete the temporary file after the client closes the file. The client **MUST** delete the file when it is no longer needed.

2.2.4.15.1 Request

```

SMB_Parameters
{
    UCHAR WordCount;
    Words
    {
        SMB_FILE_ATTRIBUTES FileAttributes;
        UTIME                CreationTime;
    }
}
SMB_Data
{
    USHORT ByteCount;
    Bytes
    {
        UCHAR          BufferFormat;
        SMB_STRING DirectoryName;
    }
}

```

0	1	2	3	4	5	6	7	8	9	10	11	12	13	14	15	16	17	18	19	20	21	22	23	24	25	26	27	28	29	30	31
SMB_Parameters																															
...																								SMB_Data (variable)							
...																															

SMB_Parameters (7 bytes):

0	1	2	3	4	5	6	7	8	9	10	11	12	13	14	15	16	17	18	19	20	21	22	23	24	25	26	27	28	29	30	31
WordCount										Words																					
...																															

WordCount (1 byte): This field MUST be 0x03.

Words (6 bytes):

0	1	2	3	4	5	6	7	8	9	10	11	12	13	14	15	16	17	18	19	20	21	22	23	24	25	26	27	28	29	30	31
FileAttributes																CreationTime															
...																															

FileAttributes (2 bytes): This field SHOULD be ignored by the server.

CreationTime (4 bytes): The time that the file was created, represented as the number of seconds since Jan 1, 1970, 00:00:00.0.

SMB_Data (variable):

0	1	2	3	4	5	6	7	8	9	10	11	12	13	14	15	16	17	18	19	20	21	22	23	24	25	26	27	28	29	30	31
ByteCount																Bytes (variable)															
...																															

ByteCount (2 bytes): This field MUST be greater than or equal to 0x0002.

Bytes (variable):

0	1	2	3	4	5	6	7	8	9	0	1	2	3	4	5	6	7	8	9	0	1	2	3	4	5	6	7	8	9	0	1		
BufferFormat										DirectoryName (variable)																							
...																																	

BufferFormat (1 byte): This field MUST be 0x04.

DirectoryName (variable): A null-terminated string that represents the fully qualified name of the directory relative to the supplied **TID** in which to create the temporary file.

2.2.4.15.2 Response

The response format is different from the original **Core Protocol**. For the original response format, refer to [\[SNIA\]](#) or [\[XOPEN-SMB\]](#).

```

SMB_Parameters
{
  UCHAR WordCount;
  Words
  {
    USHORT FID;
  }
}
SMB_Data
{
  USHORT ByteCount;
  Bytes
  {
    UCHAR TemporaryFileName[ByteCount];
  }
}

```

0	1	2	3	4	5	6	7	8	9	0	1	2	3	4	5	6	7	8	9	0	1	2	3	4	5	6	7	8	9	0	1		
SMB_Parameters																				SMB_Data (variable)													
...																																	

SMB_Parameters (3 bytes):

0	1	2	3	4	5	6	7	8	9	0	1	2	3	4	5	6	7	8	9	0	1	2	3	4	5	6	7	8	9	0	1
WordCount										Words																					

WordCount (1 byte): This field MUST be 0x01.

Words (2 bytes):

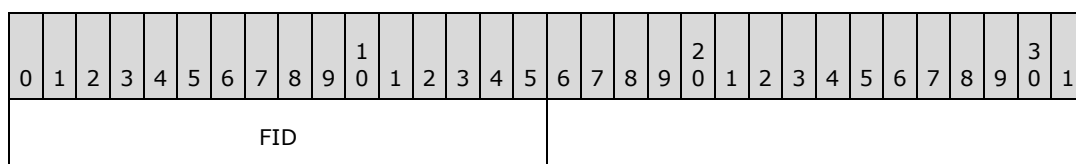

FID (2 bytes): The **FID** representing the file on the server. This value **MUST** be supplied in the **FID** field of the [SMB Header \(section 2.2.3.1\)](#) in subsequent requests that manipulate the file.

SMB_Data (variable):

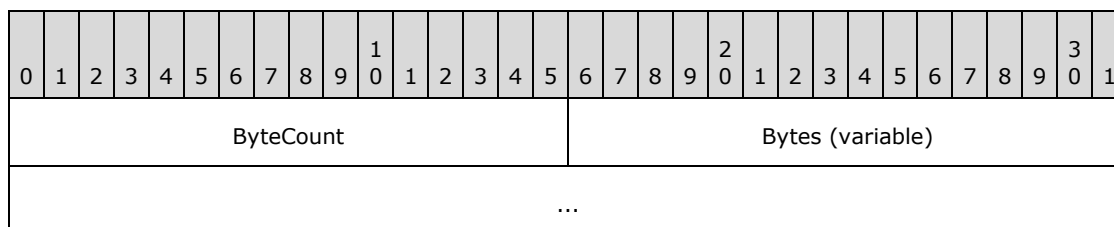

ByteCount (2 bytes): This field **MUST** be greater than or equal to 0x0002.

Bytes (variable):

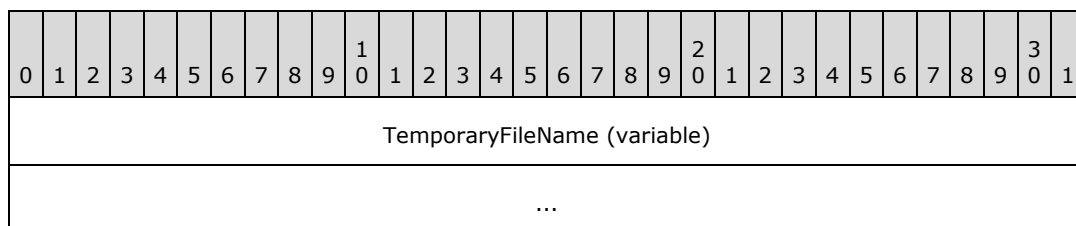

TemporaryFileName (variable): A null-terminated string that contains the temporary file name generated by the server. [<29>](#) The string **SHOULD** be a null-terminated array of ASCII characters.

Error Codes

SMB error class	SMB error code	NT status code	POSIX equivalent	Description
ERRDOS (0x01)	ERRbadfile (0x0002)	STATUS_NO_SUCH_FILE (0xC000000F)	ENOENT	The named directory was not found.
ERRDOS (0x01)	ERRbadpath (0x0003)	STATUS_OBJECT_PATH_SYNTAX_BAD (0xC000003B)	ENOENT	The file path syntax is invalid.
ERRDOS (0x01)	ERRbadpath (0x0003)	STATUS_OBJECT_PATH_INVALID (0xC0000039)	ENOTDIR	A component of the path-prefix was not a directory.
ERRDOS (0x01)	ERRnofids (0x0004)	STATUS_OS2_TOO_MANY_OPEN_FILES (0x00040001) STATUS_TOO_MANY_OPENED_FILES	EMFILE	Too many open files. No more FIDs available.

SMB error class	SMB error code	NT status code	POSIX equivalent	Description
		(0xC000011F)		
ERRDOS (0x01)	ERRnoaccess (0x0005)	STATUS_ACCESS_DENIED (0xC0000022)	EACCESS	A component of the path-prefix denied search permission OR requested access permission is denied for the directory.
ERRDOS (0x01)	ERRnomem (0x0008)	STATUS_INSUFF_SERVER_RESOURCES (0xC0000205) DOS	ENOMEM	The server is out of resources.
ERRDOS (0x01)	ERRinvalidname (0x007B)	STATUS_OBJECT_NAME_COLLISION (0xC00000BA)		Temporary file could not be created because a unique name could not be generated.
ERRSRV (0x02)	ERRerror (0x0001)	STATUS_INVALID_SMB (0x00010002)		Invalid SMB. The wrong number of parameter bytes was sent.
ERRSRV (0x02)	ERRerror (0x0001)		EFAULT	Path points outside the allocated address space of the process.
ERRSRV (0x02)	ERRerror (0x0001)		EINTR	A signal was caught during the open operation.
ERRSRV (0x02)	ERRerror (0x0001)		ENXIO	Generic server open failure.
ERRSRV (0x02)	ERRaccess (0x0004)	STATUS_NETWORK_ACCESS_DENIED (0xC00000CA)		Permission conflict between requested permission and permissions for the shared resource: for example, open for write of a file in a read-only file system subtree.
ERRSRV (0x02)	ERRinvtid (0x0005)	STATUS_SMB_BAD_TID (0x00050002)		The TID is no longer valid.

SMB error class	SMB error code	NT status code	POSIX equivalent	Description
ERRSRV (0x02)	ERRinvdevice (0x0007)	STATUS_BAD_DEVICE_TYPE (0xC00000CB)		File creation request made to a share that is not a file system subtree.
ERRSRV (0x02)	ERRbaduid (0x005B)	STATUS_SMB_BAD_UID (0X005B0002)		The UID supplied is not defined for the session, or the user identified by the UID does not have sufficient privileges.
ERRHRD (0x03)	ERRnowrite (0x0013)	STATUS_MEDIA_WRITE_PROTECTED (0xC00000A2)	EROFS	Attempt to write to a read-only file system.
ERRHRD (0x03)	ERRdata (0x0017)	STATUS_DATA_ERROR (0xC000003E)	EIO	Disk I/O error.

2.2.4.16 SMB_COM_CREATE_NEW (0x0F)

This is an original **Core Protocol** command. This command is deprecated. Implementations SHOULD use SMB_COM_NT_CREATE_ANDX.

This command is used to create a new file. It MUST NOT truncate or overwrite an existing file. If a file with the requested pathname already exists, the command MUST fail. This command MUST NOT be used to create directories or named pipes.

The request message includes the pathname of the file relative to the supplied TID that the client requests to create. If the command is successful, the server response MUST include a valid FID. The client MUST supply the FID in subsequent operations on the file, such as read, write, lock, unlock, and close. The client MUST have write permission on the file's parent directory in order to create a new file. The client's access permissions on a newly created file MUST be read/write. The file is opened in read/write/compatibility mode. Server support of the client-supplied **CreationTime**(see section [2.2.4.16.1](#)) is optional.

2.2.4.16.1 Request

```

SMB_Parameters
{
    UCHAR WordCount;
    Words
    {
        SMB_FILE_ATTRIBUTES FileAttributes;
        UTIME CreationTime;
    }
}
SMB_Data
{

```

```

USHORT ByteCount;
Bytes
{
    UCHAR BufferFormat;
    SMB_STRING FileName;
}
}

```

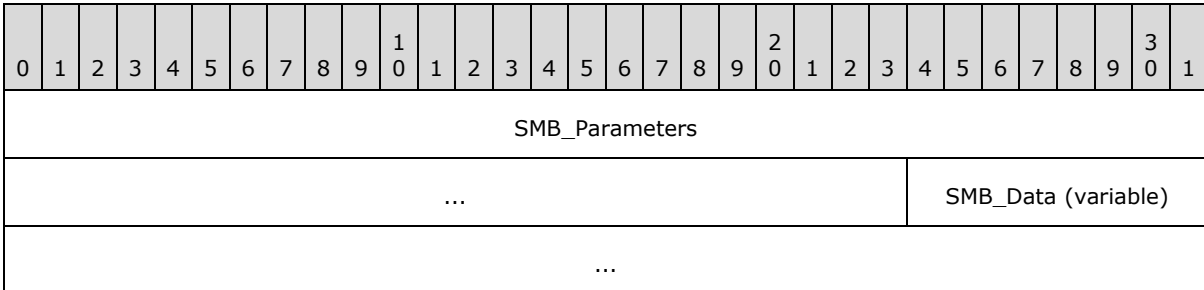

SMB_Parameters (7 bytes):

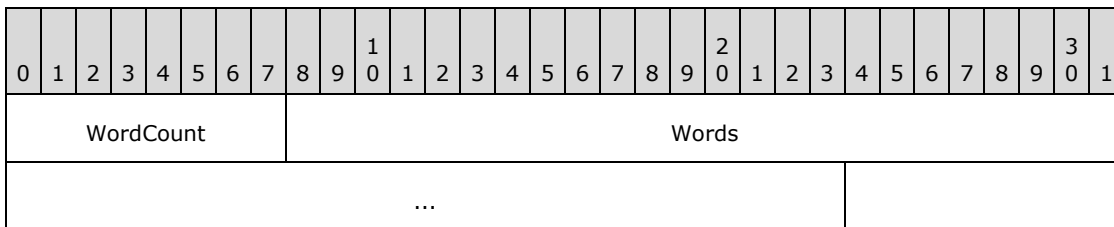

WordCount (1 byte): This field MUST be 0x03.

Words (6 bytes):

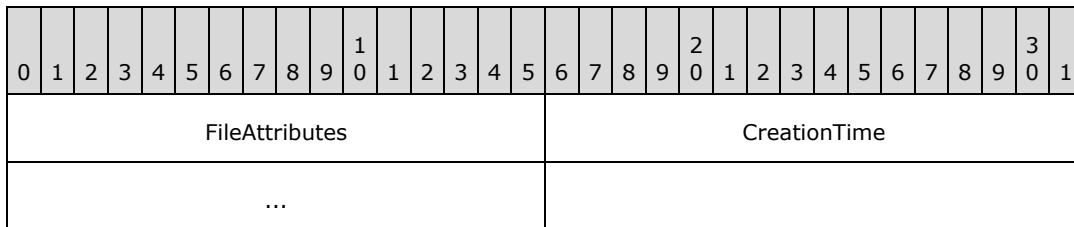

FileAttributes (2 bytes): A 16-bit field of 1-bit flags that represent the file attributes to assign to the file if it is created successfully.

CreationTime (4 bytes): The time that the file was created on the client, represented as the number of seconds since Jan 1, 1970, 00:00:00.0.

SMB_Data (variable):

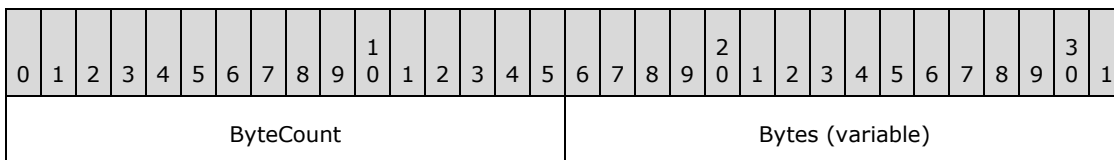

...

ByteCount (2 bytes): This field MUST be greater than or equal to 0x0002.

Bytes (variable):

0	1	2	3	4	5	6	7	8	9	1	0	1	2	3	4	5	6	7	8	9	2	0	1	2	3	4	5	6	7	8	9	3	0	1
BufferFormat										FileName (variable)																								
...																																		

BufferFormat (1 byte): MUST be 0x04, the format code for an SMB_STRING.

FileName (variable): A null-terminated string that contains the fully qualified name of the file, relative to the supplied TID, to create on the server.

2.2.4.16.2 Response

```
SMB_Parameters
{
  UCHAR WordCount;
  Words
  {
    USHORT FID;
  }
}
SMB_Data
{
  USHORT ByteCount;
}
```

0	1	2	3	4	5	6	7	8	9	1	0	1	2	3	4	5	6	7	8	9	2	0	1	2	3	4	5	6	7	8	9	3	0	1			
SMB_Parameters																					SMB_Data																
...																																					

SMB_Parameters (3 bytes):

0	1	2	3	4	5	6	7	8	9	1	0	1	2	3	4	5	6	7	8	9	2	0	1	2	3	4	5	6	7	8	9	3	0	1
WordCount										Words																								

WordCount (1 byte): This field MUST be 0x01.

Words (2 bytes):

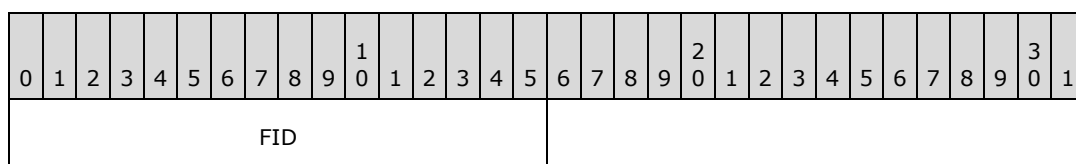

FID (2 bytes): The **FID** representing the file on the server. This value **MUST** be supplied in subsequent requests that manipulate the file.

SMB_Data (2 bytes):

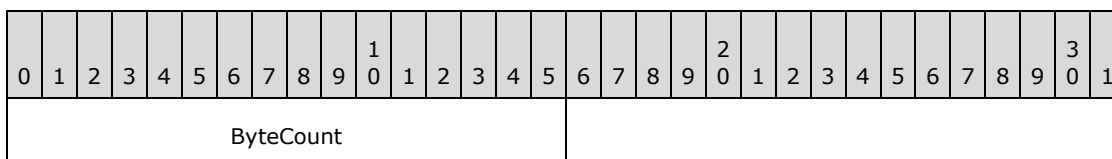

ByteCount (2 bytes): This field **MUST** be 0x0000. No data is sent by this message.

Error Codes

SMB error class	SMB error code	NT status code	POSIX equivalent	Description
ERRDOS (0x01)	ERRbadpath (0x0003)	STATUS_OBJECT_PATH_SYNTAX_BAD (0xC000003B)	ENOENT	The file path syntax is invalid.
ERRDOS (0x01)	ERRbadpath (0x0003)	STATUS_OBJECT_PATH_INVALID (0xC0000039)	ENOTDIR	A component of the path-prefix was not a directory.
ERRDOS (0x01)	ERRnofids (0x0004)	STATUS_TOO_MANY_OPENED_FILES (0xC000011F)	EMFILE	Too many open files; no more FIDs available.
ERRDOS (0x01)	ERRnoaccess (0x0005)	STATUS_ACCESS_DENIED (0xC0000022)	EACCESS	A component of the path-prefix denied search permission OR requested access permission is denied for the file OR open mode failure.
ERRDOS (0x01)	ERRnomem (0x0008)	STATUS_INSUFF_SERVER_RESOURCES (0xC0000205)	ENOMEM	The server is out of resources.
ERRDOS (0x01)	ERRfileexists (0x0050)	STATUS_OBJECT_NAME_COLLISION (0xC0000035)	EEXIST	The specified file already exists.
ERRSRV (0x02)	ERRerror (0x0001)	STATUS_INVALID_SMB (0x00010002)		Invalid SMB. Not enough parameter bytes were sent.
ERRSRV	ERRerror		EFAULT	Path points outside the allocated

SMB error class	SMB error code	NT status code	POSIX equivalent	Description
(0x02)	(0x0001)			address space of the process.
ERRSRV (0x02)	ERRerror (0x0001)		EINTR	A signal was caught during the open operation.
ERRSRV (0x02)	ERRerror (0x0001)		ENXIO	Generic server open failure.
ERRSRV (0x02)	ERRerror (0x0001)	STATUS_ACCESS_DENIED (0xC0000022)	EROFS	Named file resides on read-only file system and requested access permission is write or read/write.
ERRSRV (0x02)	ERRaccess (0x0004)	STATUS_NETWORK_ACCESS_DENIED (0xC00000CA)		Permission conflict between requested permission and permissions for the shared resource: for example, open for write of a file in a read-only file system subtree.
ERRSRV (0x02)	ERRinvtid (0x0005)	STATUS_SMB_BAD_TID (0x00050002)		The TID is no longer valid.
ERRSRV (0x02)	ERRinvdevice (0x0007)	STATUS_BAD_DEVICE_TYPE (0xC00000CB)		File creation request made to a share that is not a file system subtree.
ERRSRV (0x02)	ERRbaduid (0x005B)	STATUS_SMB_BAD_UID (0x005B0002)		The UID supplied is not defined for the session, or the user identified by the UID does not have sufficient privileges.
ERRHRD (0x03)	ERRnowrite (0x0013)	STATUS_MEDIA_WRITE_PROTECTED (0xC00000A2)	EROFS	Attempt to write to a read-only file system.
ERRHRD (0x03)	ERRdata (0x0017)	STATUS_DATA_ERROR (0xC000003E)	EIO	Disk I/O error.

2.2.4.17 SMB_COM_CHECK_DIRECTORY (0x10)

This is an original **Core Protocol** command.

This command is used to verify that a specified path resolves to a valid directory on the server.

2.2.4.17.1 Request

```
SMB_Parameters
{
  UCHAR WordCount;
}
SMB_Data
{
  USHORT ByteCount;
  Bytes
  {
    UCHAR BufferFormat;
    SMB_STRING DirectoryName;
  }
}
```

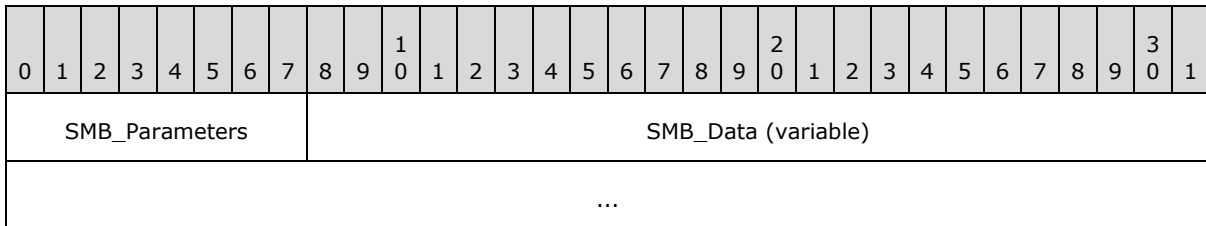

SMB_Parameters (1 byte):

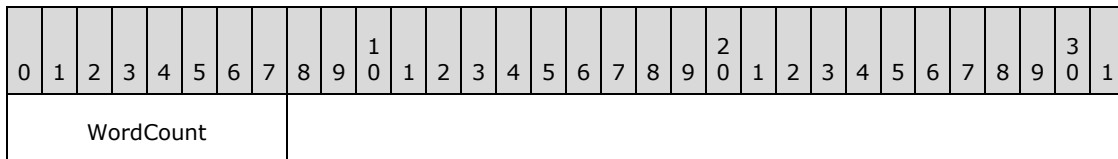

WordCount (1 byte): This field MUST be 0x00. No parameters are sent by this message.

SMB_Data (variable):

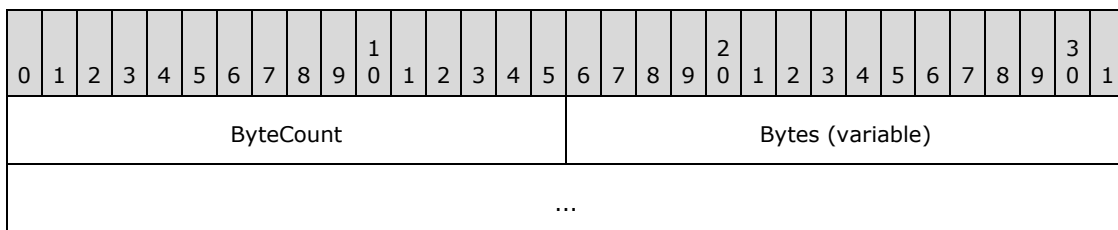

ByteCount (2 bytes): This field MUST be greater than or equal to 0x0002.

Bytes (variable):

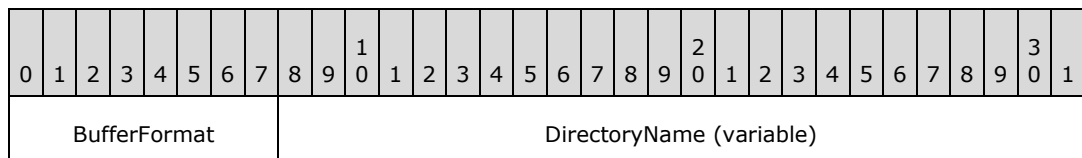

...

BufferFormat (1 byte): This field MUST be 0x04. This is a buffer type indicator that identifies the next field as an SMB_STRING.

DirectoryName (variable): A null-terminated character string giving the pathname to be tested.

2.2.4.17.2 Response

```
SMB_Parameters
{
  UCHAR WordCount;
}
SMB_Data
{
  USHORT ByteCount;
}
```

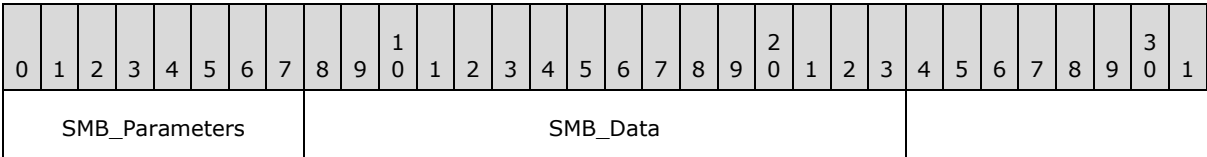

SMB_Parameters (1 byte):

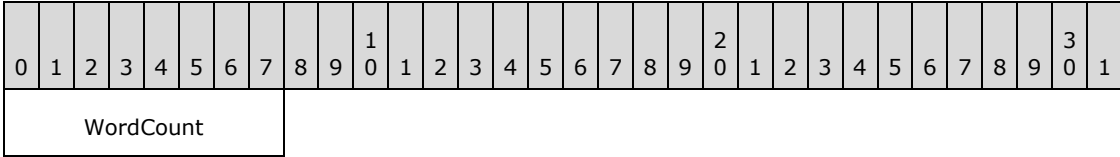

WordCount (1 byte): This field MUST be 0x00. No parameters are sent by this message.

SMB_Data (2 bytes):

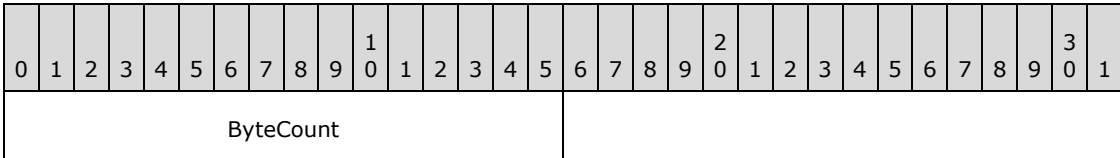

ByteCount (2 bytes): This field MUST be 0x0000. No data is sent by this message.

Error Codes

SMB error class	SMB error code	NT status code	POSIX equivalent	Description
ERRDOS (0x01)	ERRbadfile (0x0002)	STATUS_NO_SUCH_FILE (0xC000000F)	ENOENT	The directory was not found.
ERRDOS	ERRbadpath	STATUS_OBJECT_PATH_NOT_FOUND	ENOENT	The path does not

SMB error class	SMB error code	NT status code	POSIX equivalent	Description
(0x01)	(0x0003)	(0xC000003A)		exist or a component of the path is not a directory.
ERRDOS (0x01)	ERRbadpath (0x0003)	STATUS_OBJECT_PATH_SYNTAX_BAD (0xC000003B)	ENOENT	The directory path syntax is invalid.
ERRDOS (0x01)	ERRnoaccess (0x0005)	STATUS_ACCESS_DENIED (0xC0000022)	EACCESS	A component of the path-prefix denied search permission.
ERRDOS (0x01)	ERRnomem (0x0008)	STATUS_INSUFF_SERVER_RESOURCES (0xC0000205)	ENOMEM	The server is out of resources.
ERRSRV (0x02)	ERRerror (0x0001)	STATUS_INVALID_SMB (0x00010002)		Invalid SMB. Not enough parameter bytes were sent.
ERRSRV (0x02)	ERRinvtid (0x0005)	STATUS_SMB_BAD_TID (0x00050002)		The TID is no longer valid.
ERRSRV (0x02)	ERRbaduid (0x005B)	STATUS_SMB_BAD_UID (0x005B0002)		The UID supplied is not known to the session, or the user identified by the UID does not have sufficient privileges.
ERRHRD (0x03)	ERRdata (0x0017)	STATUS_DATA_ERROR (0xC000003E)	EIO	Disk I/O error.

2.2.4.18 SMB_COM_PROCESS_EXIT (0x11)

This is an original **Core Protocol** command. This command is obsolescent. It was declared obsolete in the **LAN Manager 1.0** dialect (see [\[SMB-LM1X1\]](#)) but continues to be included in later documentation. [\[CIFS\]](#) lists this command as obsolescent, and that designation is retained here.

An SMB_COM_PROCESS_EXIT request is sent by the client to indicate the catastrophic failure of a client process. Upon receiving an SMB_COM_PROCESS_EXIT request, the server **MUST** close any resources owned by the Process ID (PID) listed in the request header.

2.2.4.18.1 Request

```
SMB_Parameters
{
    UCHAR WordCount;
    SMB_Data
    {
        USHORT ByteCount;
    }
}
```

SMB_Header:

PIDLow (2 bytes): The lowest-order two bytes of the process ID, as an unsigned short.

PIDHigh (2 bytes): If 32-bit PID values are in use, this field MUST contain the two highest-order bytes. If the client is using 16-bit PIDs, then this field MUST be zero.

The server MUST calculate the actual PID by multiplying the value of **SMB_Header.PIDHigh** by 2^{16} and adding the result to the value of **SMB_Header.PIDLow**.

In **Core Protocol**, open files (identified by FIDs) and any locks on those files were considered "owned" by the client process. Starting with the LAN Manager 1.0 dialect, FIDs are no longer associated with PIDs. The client MAY allow open file handles to be shared between multiple processes. CIFS clients SHOULD NOT send SMB_COM_PROCESS_EXIT requests. Instead, CIFS clients SHOULD perform all process cleanup operations, sending individual file close operations as needed.

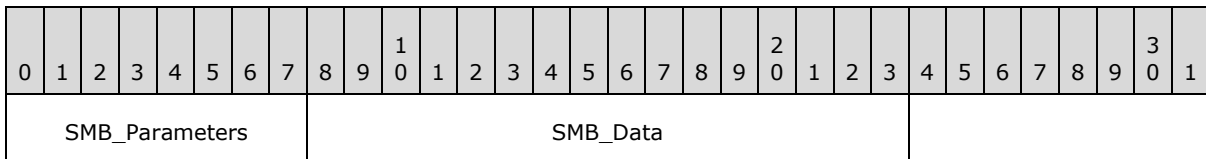

SMB_Parameters (1 byte):

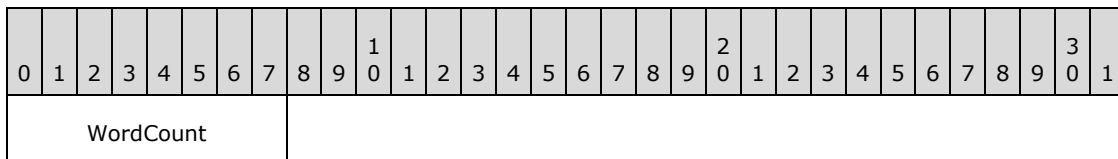

WordCount (1 byte): MUST be 0x00. No parameters are sent.

SMB_Data (2 bytes):

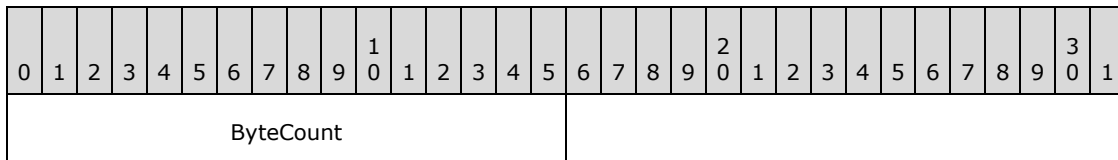

ByteCount (2 bytes): MUST be 0x0000. No data bytes are sent.

2.2.4.18.2 Response

```
SMB_Parameters
{
    UCHAR WordCount;
SMB_Data
{
    USHORT ByteCount;
}
```

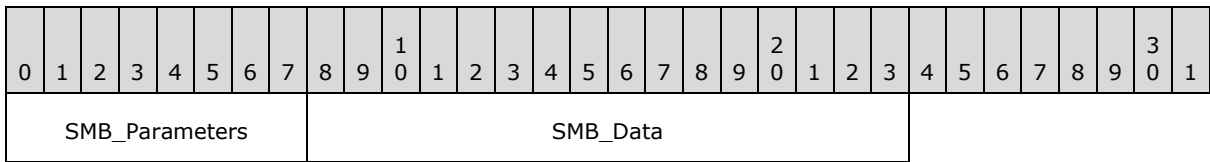

SMB_Parameters (1 byte):

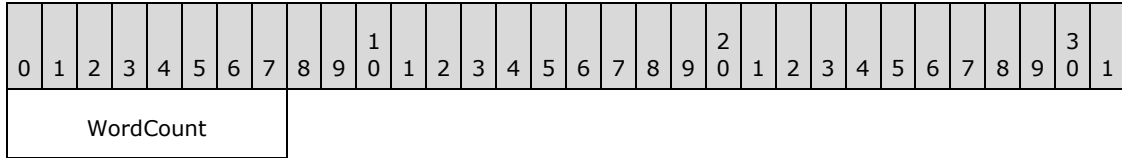

WordCount (1 byte): MUST be 0x00. No parameters are returned.

SMB_Data (2 bytes):

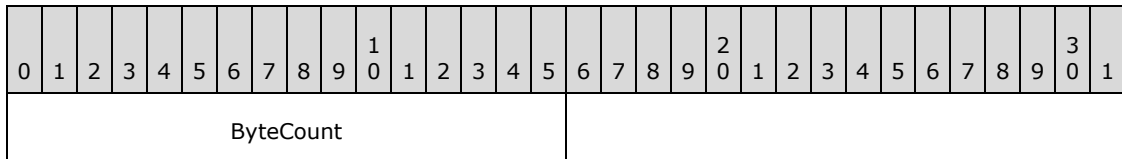

ByteCount (2 bytes): MUST be 0x0000. No data bytes are returned.

Error Codes

SMB error class	SMB error code	NT status code	Description
ERRSRV (0x02)	ERRerror (0x0001)	STATUS_INVALID_SMB (0x00010002)	Invalid SMB. There is no session established.
ERRSRV (0x02)	ERRbaduid (0x005B)	STATUS_SMB_BAD_UID (0x005B0002)	The UID supplied is not defined to the session.

2.2.4.19 SMB_COM_SEEK (0x12)

This is an original **Core Protocol** command. This command is obsolescent.

SMB_COM_SEEK is used to position a file pointer associated with an open FID within a regular file. SMB_COM_SEEK can also be used to retrieve the current value of the file pointer, which is maintained by the server. The file pointer value returned in the SMB_COM_SEEK response is an unsigned 32-bit value, representing the absolute offset (in bytes) from the start of the file. It is possible to seek beyond the end of the file, but an attempt to seek to a negative offset (a position before the start of the file) sets the offset to zero (0). An offset of zero represents the start of the file.

It is not necessary to use SMB_COM_SEEK to position the file pointer before sending a read or write request. CIFS read and write command requests contain an offset field. Read and write operations also change the value of the file pointer, setting it equal to the requested offset plus the number of bytes read or written.

Since SMB_COM_SEEK is not required in order to set the file pointer before a read or write operation, its utility is fairly limited. It MAY be used to retrieve the current file pointer or, by seeking to the current end-of-file, to retrieve the file size. It is not appropriate for use with very large files (those that are near or above 4 gigabytes in size).

2.2.4.19.1 Request

```
SMB_Parameters
{
  UCHAR WordCount;
  Words
  {
    USHORT FID;
    USHORT Mode;
    LONG Offset;
  }
}
SMB_Data
{
  USHORT ByteCount;
}
```

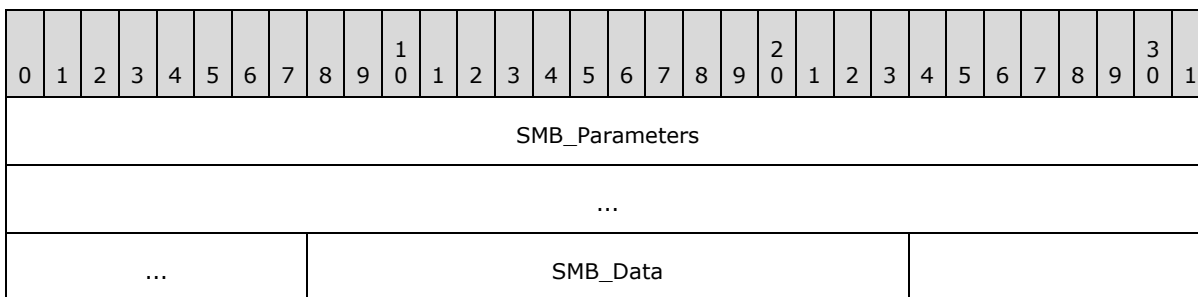

SMB_Parameters (9 bytes):

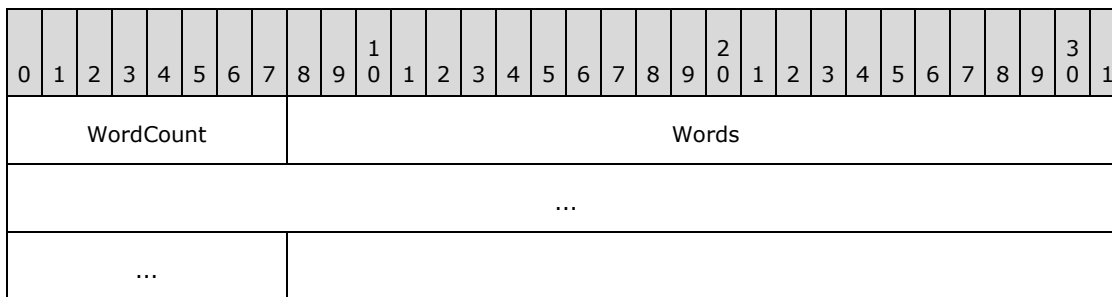

WordCount (1 byte): This field MUST be 0x0004.

Words (8 bytes):

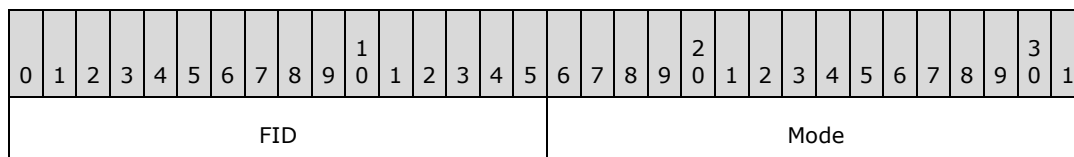

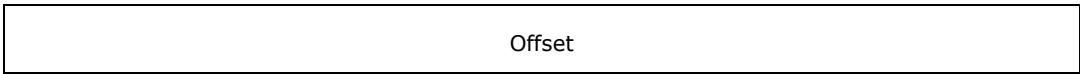

FID (2 bytes): The File ID of the open file within which to seek.

Mode (2 bytes): The seek mode. Possible values are as follows.

Value	Meaning
0x0000	Seek from the start of the file.
0x0001	Seek from the current position.
0x0002	Seek from the end of the file.

The "current position" is the offset specified in a previous seek request, or the offset plus data length specified in a previous read or write request, whichever is most recent. The next successful read, write, or seek command changes the position of the file pointer.

Offset (4 bytes): A 32-bit signed long value indicating the file position, relative to the position indicated in **Mode**, to which to set the updated file pointer. The value of **Offset** ranges from -2 gigabytes to +2 gigabytes ((-2**31) to (2**31 -1) bytes).<30>

SMB_Data (2 bytes):

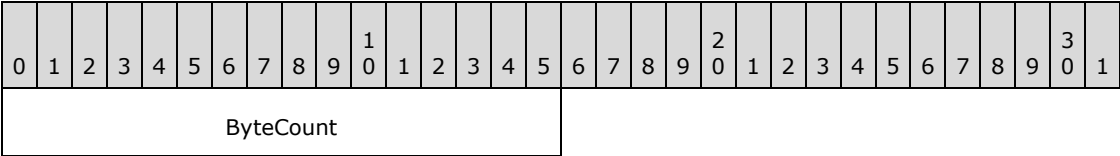

ByteCount (2 bytes): This field MUST be 0x0000. No data is sent by this message.

2.2.4.19.2 Response

```

SMB_Parameters
{
  UCHAR WordCount;
  Words
  {
    ULONG Offset;
  }
}
SMB_Data
{
  USHORT ByteCount;
}

```

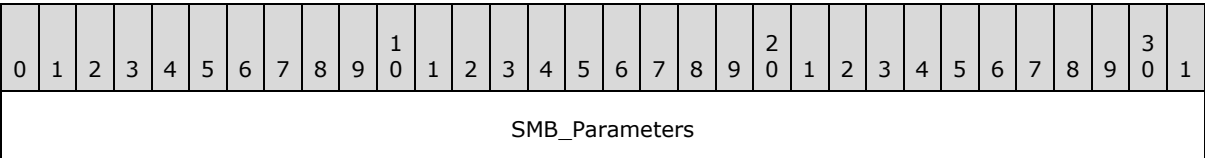

...	SMB_Data
-----	----------

SMB_Parameters (5 bytes):

0	1	2	3	4	5	6	7	8	9	10	11	12	13	14	15	16	17	18	19	20	21	22	23	24	25	26	27	28	29	30	31
WordCount										Words																					
...																															

WordCount (1 byte): This field MUST be 0x0002.

Words (4 bytes):

0	1	2	3	4	5	6	7	8	9	10	11	12	13	14	15	16	17	18	19	20	21	22	23	24	25	26	27	28	29	30	31
Offset																															

Offset (4 bytes): A 32-bit unsigned value indicating the absolute file position relative to the start of the file at which the file pointer is currently set. The value of **Offset** ranges from 0 to 4 gigabytes (0 to 2**32 - 1 bytes).

A seek that results in a file position value that cannot be expressed in 32 bits MUST set **Offset** to the least significant 32 bits. [<31>](#)

SMB_Data (2 bytes):

0	1	2	3	4	5	6	7	8	9	10	11	12	13	14	15	16	17	18	19	20	21	22	23	24	25	26	27	28	29	30	31
ByteCount																															

ByteCount (2 bytes): This field MUST be 0x0000. No data is sent by this message.

The response returns the new file pointer in **Offset**, expressed as the number of bytes from the start of the file. The **Offset** MAY be beyond the current end of file. An attempt to seek to before the start of file sets the current file pointer to the start of the file (0x00000000).

Error Codes

SMB error class	SMB error code	NT status code	POSIX equivalent	Description
ERRDOS (0x01)	ERRbadfid (0x0006)	STATUS_INVALID_HANDLE (0xC0000008) STATUS_SMB_BAD_FID	ENFILE	Invalid FID , or FID mapped to a valid server FID , but it was

SMB error class	SMB error code	NT status code	POSIX equivalent	Description
		(0x00060001)		not acceptable to the operating system.
ERRDOS (0x01)	ERRnomem (0x0008)	STATUS_INSUFF_SERVER_RESOURCES (0xC0000205)	ENOMEM	The server is out of resources.
ERRDOS (0x01)	ERReof (0x0026)	STATUS_END_OF_FILE (0xC0000011)	EEOF	The end of the file is beyond where the client can read; file is larger than 4GB.
ERRDOS (0x01)	ERRinvalidparam (0x0057)	STATUS_INVALID_PARAMETER (0xC000000D)	EEOF	The Mode field value is out of range.
ERRDOS (0x01)	ERRinvalidseek (0x0083)	STATUS_OS2_NEGATIVE_SEEK (0x00830001)		An attempt was made to seek to a negative absolute offset within a file.
ERRSRV (0x02)	ERRerror (0x0001)	STATUS_INVALID_SMB (0x00010002)		A corrupt SMB request was received.
ERRSRV (0x02)	ERRinvtid (0x0005)	STATUS_SMB_BAD_TID (0x00050002)		Invalid TID in request.
ERRSRV (0x02)	ERRinvdevice (0x0007)	STATUS_BAD_DEVICE_TYPE (0xC00000CB)		Invalid file type. Attempt to seek in a non-regular file.
ERRSRV (0x02)	ERRbaduid (0x005B)	STATUS_SMB_BAD_UID (0x005B0002)		The UID specified is not defined as a valid ID on this server session, or the user identified by the UID does not have sufficient privileges.

2.2.4.20 SMB_COM_LOCK_AND_READ (0x13)

This command was introduced in the **CorePlus** dialect, but is often listed as part of the **LAN Manager 1.0** dialect. This command is deprecated. Clients SHOULD use the [SMB_COM_LOCKING_ANDX \(section 2.2.4.32\)](#) command.

This command is used to explicitly lock and read bytes from a regular file. The byte range requested is first locked and then read. The lock type is an exclusive read/write lock. If the server cannot

immediately grant the lock on the byte range an error MUST be returned to the client. If the lock cannot be obtained the server SHOULD NOT read the bytes.

The end of file condition is indicated by the server returning fewer bytes than the client has requested. A read request starting at or beyond the end of the file returns zero bytes. If a read requests more data than can be placed in a message of **MaxBufferSize** for the SMB connection, the server will abort the connection to the client. This client request is inappropriate for files having 64-bit offsets since it supports 32-bit offsets only. The client MUST have at least read access to the file.

2.2.4.20.1 Request

```
SMB_Parameters
{
  UCHAR  WordCount;
  Words
  {
    USHORT  FID;
    USHORT  CountOfBytesToRead;
    ULONG   ReadOffsetInBytes;
    USHORT  EstimateOfRemainingBytesToBeRead;
  }
}
SMB_Data
{
  USHORT  ByteCount;
}
```

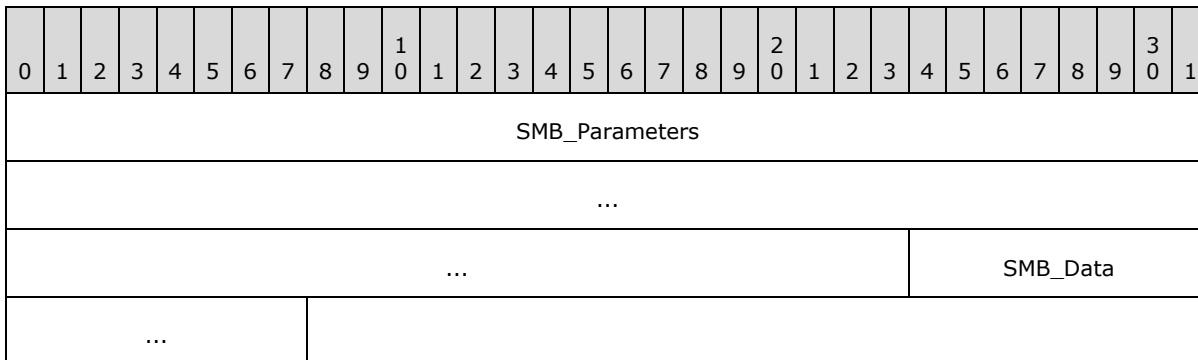

SMB_Parameters (11 bytes):

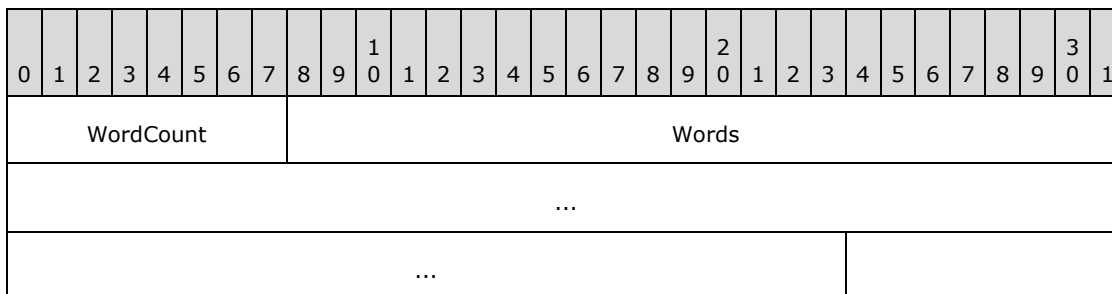

WordCount (1 byte): This field MUST be 0x05.

Words (10 bytes):

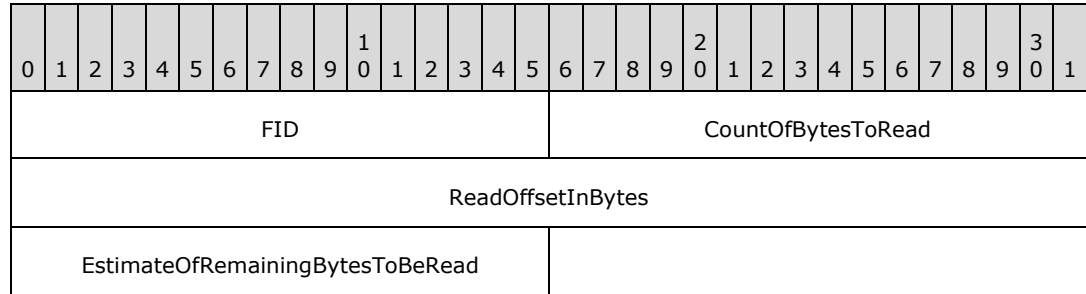

FID (2 bytes): This field MUST be a valid 16-bit unsigned integer indicating the file from which the data MUST be read.

CountOfBytesToRead (2 bytes): This field is a 16-bit unsigned integer indicating the number of bytes to be read from the file. The client MUST ensure that the amount of data requested will fit in the negotiated maximum buffer size.

ReadOffsetInBytes (4 bytes): This field is a 32-bit unsigned integer indicating the offset in number of bytes from which to begin reading from the file. The client MUST ensure that the amount of data requested fits in the negotiated maximum buffer size. Because this field is limited to 32 bits, this command is inappropriate for files that have 64-bit offsets.

EstimateOfRemainingBytesToBeRead (2 bytes): This field is a 16-bit unsigned integer indicating the remaining number of bytes that the client has designated to be read from the file. This is an advisory field and can be zero.

SMB_Data (2 bytes):

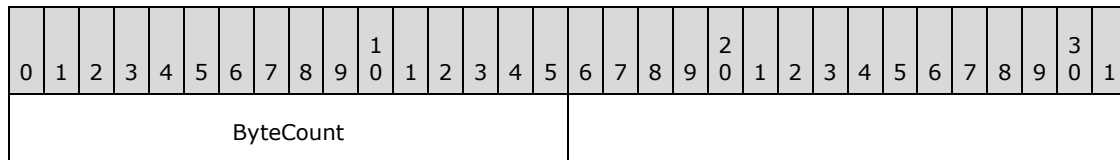

ByteCount (2 bytes): This field MUST be 0x0000. No data is sent by this message.

2.2.4.20.2 Response

```
SMB_Parameters
{
  UCHAR  WordCount;
  Words
  {
    USHORT CountOfBytesReturned;
    USHORT Reserved[4];
  }
}
SMB_Data
{
  USHORT ByteCount;
  Bytes
  {
    UCHAR  BufferType;
    USHORT CountOfBytesRead;
  }
}
```

```

    UCHAR Bytes[CountOfBytesRead];
}
}

```

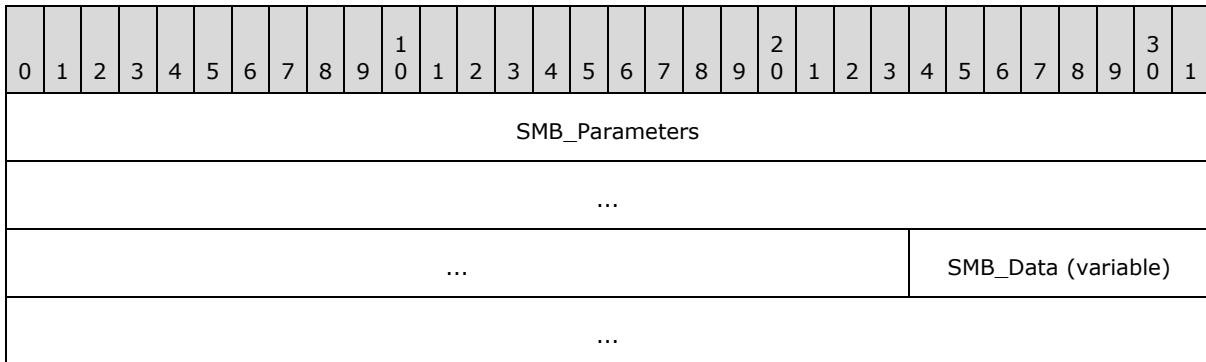

SMB_Parameters (11 bytes):

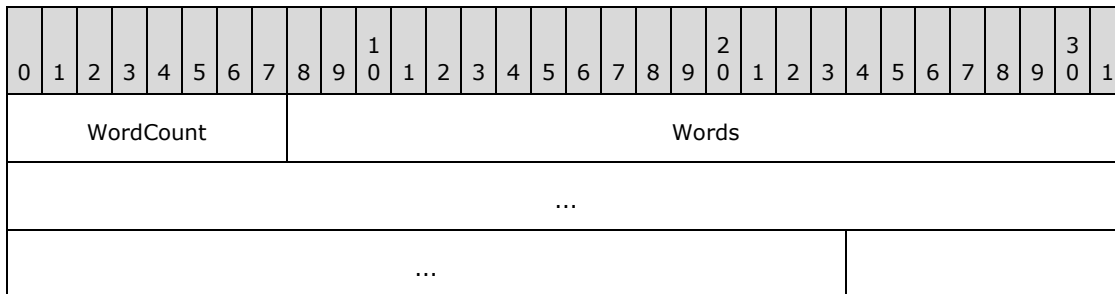

WordCount (1 byte): This field MUST be 0x05.

Words (10 bytes):

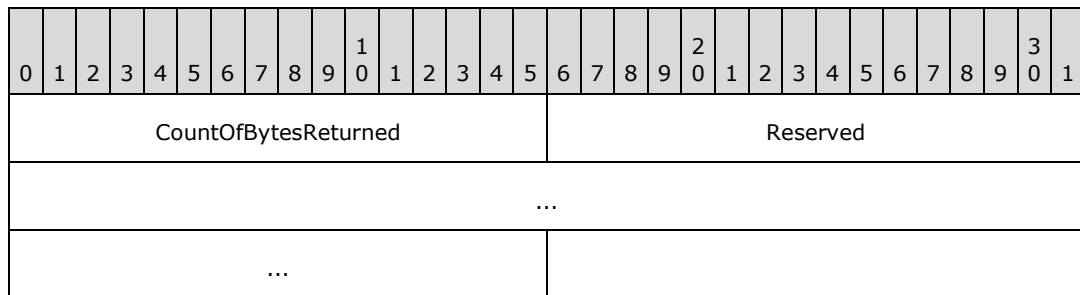

CountOfBytesReturned (2 bytes): The actual number of bytes returned to the client. This MUST be equal to **CountOfBytesToRead** unless the end of file was reached before reading **CountOfBytesToRead** bytes or the **ReadOffsetInBytes** pointed at or beyond the end of file.

Reserved (8 bytes): Reserved. All bytes MUST be 0x00.

SMB_Data (variable):

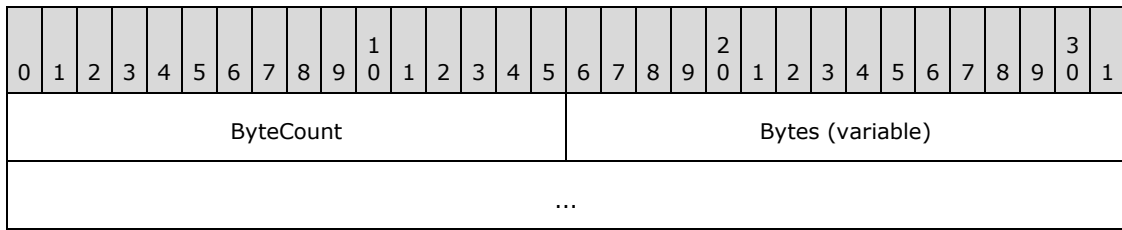

ByteCount (2 bytes): This field MUST be 0x0003 + CountOfBytesRead.

Bytes (variable):

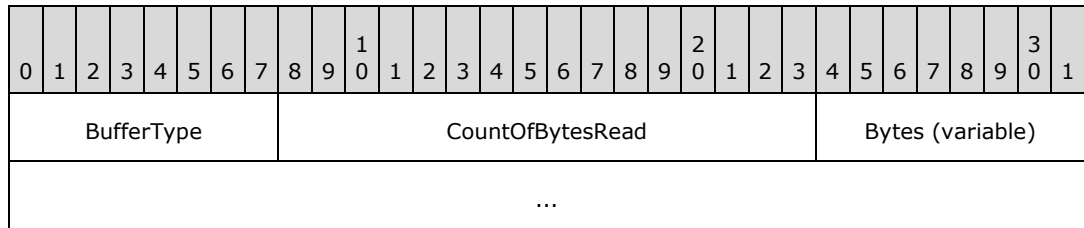

BufferType (1 byte): This field MUST be 0x01.

CountOfBytesRead (2 bytes): The number of bytes read that are contained in the following array of bytes.

Bytes (variable): The array of bytes read from the file. The array is not null-terminated.

Error Codes

SMB error class	SMB error code	NT status code	POSIX equivalent	Description
ERRDOS (0x01)	ERRnoaccess (0x0001)	STATUS_INVALID_DEVICE_REQUEST (0xC0000010)	EINVAL	Attempt to lock a non-regular file such as a named pipe.
ERRDOS (0x01)	ERRnoaccess (0x0005)	STATUS_ACCESS_DENIED (0xC0000022)	EACCESS	File access rights do not match requested locks.
ERRDOS (0x01)	ERRnoaccess (0x0005)	STATUS_ALREADY_COMMITTED (0xC0000021)	ENOLCK	Attempt to read from a portion of the file that the server determines has been locked or has been opened in deny-read mode.
ERRDOS (0x01)	ERRbadfid (0x0006)	STATUS_INVALID_HANDLE (0xC0000008) STATUS_SMB_BAD_FID (0x00060001)	ENFILE	Attempt to read from a FID that the server does not have open.

SMB error class	SMB error code	NT status code	POSIX equivalent	Description
ERRDOS (0x01)	ERRnomem (0x0008)	STATUS_INSUFF_SERVER_RESOURCES (0xC0000205)	ENOMEM	The server is out of resources.
ERRDOS (0x01)	ERRbadaccess (0x000C)	STATUS_ACCESS_DENIED (0xC0000022)		Read permission required.
ERRDOS (0x01)	ERRlock (0x0021)	STATUS_FILE_LOCK_CONFLICT (0xC0000054)	EACCESS	The intended byte range has already been locked.
ERRDOS (0x01)	ERRlock (0x0021)	STATUS_FILE_LOCK_CONFLICT (0xC0000054) STATUS_LOCK_NOT_GRANTED (0xC0000055)	EAGAIN	The requested byte range was already locked by a different process (PID).
ERRDOS (0x01)	ERReof (0x0026)	STATUS_END_OF_FILE (0xC0000011)		Attempted to read beyond the end of the file.
ERRSRV (0x02)	ERRerror (0x0001)	STATUS_INVALID_SMB (0x00010002)		A corrupt or invalid request has been encountered.
ERRSRV (0x02)	ERRerror (0x0001)		EBADF	A valid FID was rejected by the underlying system.
ERRSRV (0x02)	ERRerror (0x0001)		EDEADLK	The lock request would block and cause a deadlock with another process.
ERRSRV (0x02)	ERRinvdevice (0x0007)	STATUS_BAD_DEVICE_TYPE (0xC00000CB)		Attempt to lock a non-regular file such as a named pipe.
ERRSRV (0x02)	ERRinvtid (0x0005)	STATUS_SMB_BAD_TID (0x00050002)		Invalid TID in request.
ERRSRV (0x02)	ERRbaduid (0x005B)	STATUS_SMB_BAD_UID (0x005B0002)		The UID specified is not defined as a valid ID for this session, or the user identified by the UID does not have sufficient privileges.
ERRSRV (0x02)	ERRmoredata (0x00EA)	STATUS_BUFFER_OVERFLOW (0x80000005)		The number of bytes read from the named pipe

SMB error class	SMB error code	NT status code	POSIX equivalent	Description
				exceeds the requested number of bytes. The data was returned to the client in the response.
ERRHRD (0x03)	ERRdata (0x0017)	STATUS_DATA_ERROR (0xC000003E)	EIO	A problem has occurred in the physical I/O.
ERRHRD (0x03)	ERRread (0x001E)		ENXIO	The device associated with the file descriptor is a block-special or character-special file and the value of the file pointer is out of range.

2.2.4.21 SMB_COM_WRITE_AND_UNLOCK (0x14)

This command was introduced in the **CorePlus** dialect, but is often listed as part of the **LAN Manager 1.0** dialect. This command is deprecated. Clients SHOULD use the [SMB_COM_LOCKING_ANDX \(section 2.2.4.32\)](#) command.

The write and unlock command has the effect of writing to a range of bytes and then unlocking them. This command is usually associated with an earlier usage of [SMB_COM_LOCK_AND_READ \(section 2.2.4.20\)](#) on the same range of bytes. The server's response field **ByteCountWritten** indicates the number of bytes actually written.

Aside from the lack of special handling of zero-length writes, this request behaves in an identical fashion to the [SMB_COM_WRITE \(section 2.2.4.12\)](#) command followed by a core protocol [SMB_COM_UNLOCK_BYTE_RANGE](#) command. Support for this SMB command is optional. A server SHOULD set bit 0 in the [SMB Header \(section 2.2.3.1\)](#) **Flags** field of the [SMB_COM_NEGOTIATE \(section 2.2.4.52\)](#) response to indicate to the client that the command is supported. If the command sends a message of length greater than the **MaxBufferSize** for the **TID** specified, the server MAY abort the connection to the client. If an error occurs on the write, the bytes remain locked.

This command supports only 32-bit offsets and is inappropriate for files having 64-bit offsets. The client SHOULD use [SMB_COM_WRITE_ANDX \(section 2.2.4.43\)](#) to write to files requiring 64-bit file offsets.

When **FID** represents a disk file and the request specifies a byte range beyond the current end of file, the file MUST be extended. Any bytes between the previous end of file and the requested offset are initialized to zero (0x00). When a write specifies a count of zero, the file is not truncated or extended to the length specified by the offset.

The client MUST have at least write access to the file.

2.2.4.21.1 Request

```

SMB_Parameters
{
  UCHAR  WordCount;
  Words
  {
    USHORT FID;
    USHORT CountOfBytesToWrite;
    ULONG  WriteOffsetInBytes;
    USHORT EstimateOfRemainingBytesToBeWritten;
  }
}
SMB_Data
{
  USHORT ByteCount;
  Bytes
  {

    UCHAR  BufferFormat;
    USHORT DataLength;
    UCHAR  Data[DataLength];
  }
}

```

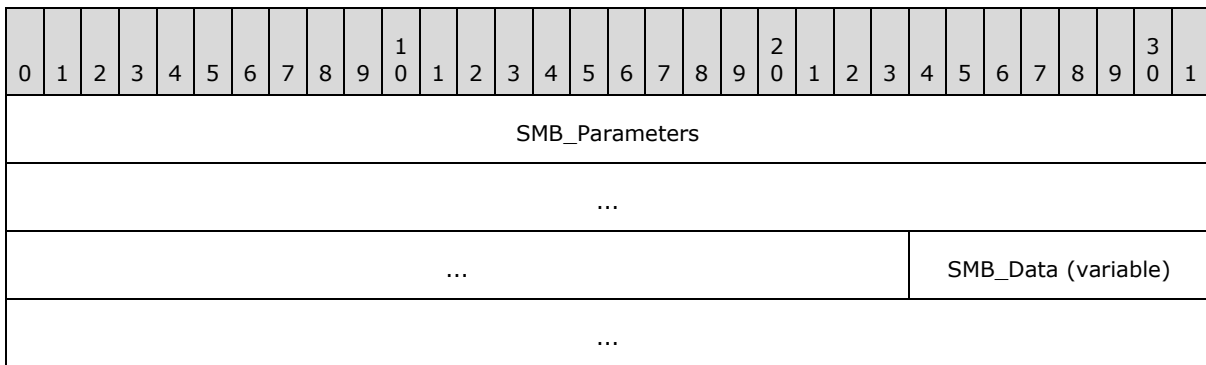

SMB_Parameters (11 bytes):

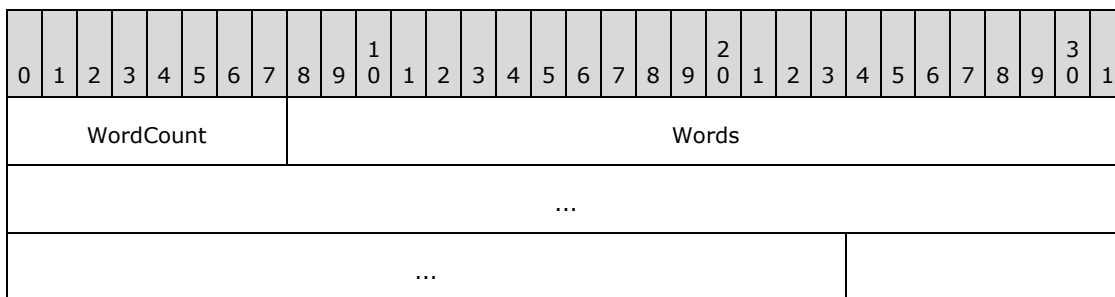

WordCount (1 byte): This field MUST be 0x05.

Words (10 bytes):

0	1	2	3	4	5	6	7	8	9	10	11	12	13	14	15	16	17	18	19	20	21	22	23	24	25	26	27	28	29	30	31
FID																CountOfBytesToWrite															
WriteOffsetInBytes																															
EstimateOfRemainingBytesToBeWritten																															

FID (2 bytes): This field MUST be a valid 16-bit unsigned integer indicating the file to which the data MUST be written.

CountOfBytesToWrite (2 bytes): This field is a 16-bit unsigned integer indicating the number of bytes to be written to the file. The client MUST ensure that the amount of data sent can fit in the negotiated maximum buffer size.

WriteOffsetInBytes (4 bytes): This field is a 32-bit unsigned integer indicating the offset, in number of bytes, from the beginning of the file at which to begin writing to the file. The client MUST ensure that the amount of data sent can fit in the negotiated maximum buffer size. Because this field is limited to 32 bits, this command is inappropriate for files that have 64-bit offsets.

EstimateOfRemainingBytesToBeWritten (2 bytes): This field is a 16-bit unsigned integer indicating the remaining number of bytes that the client designates to write to the file. This is an advisory field and MAY be zero. This information can be used by the server to optimize cache behavior.

SMB_Data (variable):

0	1	2	3	4	5	6	7	8	9	10	11	12	13	14	15	16	17	18	19	20	21	22	23	24	25	26	27	28	29	30	31
ByteCount																Bytes (variable)															
...																															

ByteCount (2 bytes): This field MUST be greater than or equal to 0x0003. The total value represents the size of the **BufferFormat** field in bytes plus the size of the **DataLength** field in bytes plus the value of the **CountOfBytesToWrite** field. See [Data Buffer Format Codes \(section 2.2.2.5\)](#) for a complete description of data buffer format codes and their usages.

Bytes (variable):

0	1	2	3	4	5	6	7	8	9	10	11	12	13	14	15	16	17	18	19	20	21	22	23	24	25	26	27	28	29	30	31
BufferFormat										DataLength																Data (variable)					
...																															

BufferFormat (1 byte): This field MUST be 0x01.

DataLength (2 bytes): This field MUST be **CountOfBytesToWrite**.

Data (variable): The raw bytes to be written to the file.

2.2.4.21.2 Response

```
SMB_Parameters
{
  UCHAR WordCount;
  Words
  {
    USHORT CountOfBytesWritten;
  }
}
SMB_Data
{
  USHORT ByteCount;
}
```

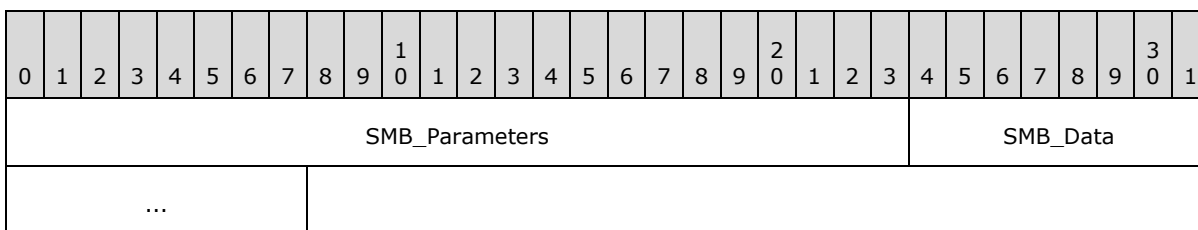

SMB_Parameters (3 bytes):

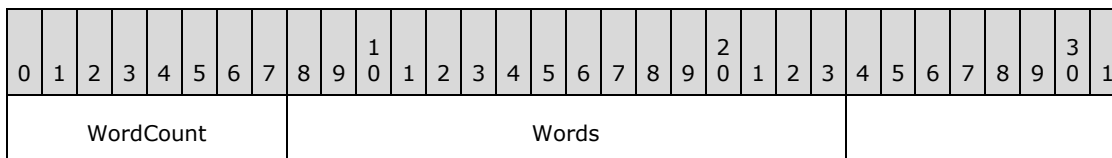

WordCount (1 byte): This field MUST be 0x01.

Words (2 bytes):

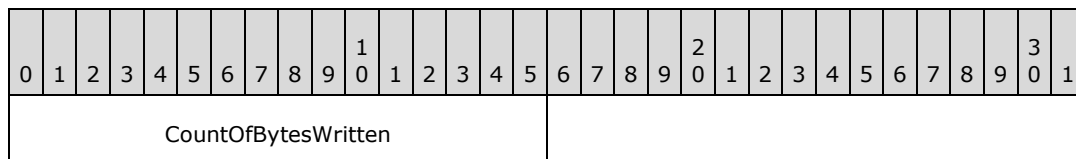

CountOfBytesWritten (2 bytes): Indicates the actual number of bytes written to the file. For successful writes, this MUST equal the **CountOfBytesToWrite** in the client Request. If the number of bytes written differs from the number requested and no error is indicated, then the server has no resources available to satisfy the complete write.

SMB_Data (2 bytes):

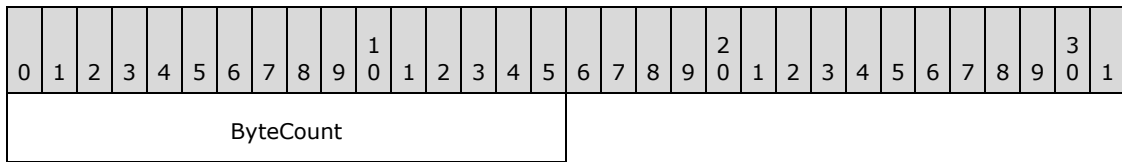

ByteCount (2 bytes): This field MUST be 0x0000. No data is sent by this message.

Error Codes

SMB error class	SMB error code	NT status code	POSIX equivalent	Description
SUCCESS (0x00)	SUCCESS (0x0000)		EFBIG	The file has grown too large and no more data can be written to the file. A CountOfBytesWritten of zero (0x0000) MUST be returned to the client in the server response. This indicates to the client that the file system is full.
SUCCESS (0x00)	SUCCESS (0x0000)		NOSPC	No space on the file system. The server MUST return a zero (0x0000) in the CountOfBytesWritten field of the response. This indicates that the file system is full.
ERRDOS (0x01)	ERRnoaccess (0x0005)		EAGAIN	Resources for I/O on the server are temporarily exhausted.
ERRDOS (0x01)	ERRnoaccess (0x0005)	STATUS_ACCESS_DENIED (0xC0000022)	EACCESS	File access rights do not match requested locks.
ERRDOS (0x01)	ERRnoaccess (0x0005)	STATUS_ALREADY_COMMITTED (0xC0000021)	ENOLCK	A record lock has been taken on the file or the client has attempted to write to a portion of the file that the server detects has been locked, opened in deny-write mode, or opened in read-only mode.

SMB error class	SMB error code	NT status code	POSIX equivalent	Description
ERRDOS (0x01)	ERRbadfid (0x0006)	STATUS_INVALID_HANDLE (0xC0000008) STATUS_SMB_BAD_FID (0x00060001)	ENFILE	Invalid FID , or FID mapped to a valid server FID , but it was not acceptable to the operating system.
ERRDOS (0x01)	ERRnomem (0x0008)	STATUS_INSUFF_SERVER_RESOURCES (0xC0000205) STATUS_NO_MEMORY (0xC0000017)	ENOMEM	The server is out of resources.
ERRDOS (0x01)	ERRbadaccess (0x000C)	STATUS_ACCESS_DENIED (0xC0000022)		Write permission required.
ERRDOS (0x01)	ERRlock (0x0021)	STATUS_FILE_LOCK_CONFLICT (0xC0000054) STATUS_LOCK_NOT_GRANTED (0xC0000055)		The requested byte range was already locked by a different process (PID).
ERRDOS (0x01)	ERROR_NOT_LOCKED (0x009E)	STATUS_RANGE_NOT_LOCKED (0xC000007E)		The byte range specified in an unlock request was not locked.
ERRSRV (0x02)	ERRerror (0x0001)		EDEADLK	The write would block due to locking and deadlock would result.
ERRSRV (0x02)	ERRerror (0x0001)		ERANGE	Attempted write size is outside of the minimum or maximum ranges that can be written to the supplied FID .
ERRSRV (0x02)	ERRerror (0x0001)	STATUS_INVALID_SMB (0x00010002)		A corrupt or invalid SMB request was received.
ERRSRV (0x02)	ERRinvtid (0x0005)	STATUS_SMB_BAD_TID (0x00050002)		Invalid TID in request.
ERRSRV (0x02)	ERRinvdevice (0x0007)	STATUS_BAD_DEVICE_TYPE (0xC00000CB)		Attempt to unlock a non-regular file such as a named pipe.
ERRSRV (0x02)	ERRqfull (0x0031)	STATUS_PRINT_QUEUE_FULL (0xC00000C6)		Print queue is full - too many queued items.

SMB error class	SMB error code	NT status code	POSIX equivalent	Description
ERRSRV (0x02)	ERRqtoobig (0x0032)	STATUS_NO_SPOOL_SPACE (0xC00000C7)		Print queue is full - too many queued items.
ERRSRV (0x02)	ERRbaduid (0x005B)	STATUS_SMB_BAD_UID (0x005B0002)		The UID specified is not defined as a valid ID on this server session, or the user identified by the UID does not have sufficient privileges.
ERRHRD (0x03)	ERRdata (0x0017)	STATUS_DATA_ERROR (0xC000003E)	EIO	A problem has occurred in the physical I/O.
ERRHRD (0x03)	ERRwrite (0x001D)		ENXIO	The device associated with the file descriptor is a block-special or character-special file and the value of the file pointer is out of range.
ERRHRD (0x03)	ERRdiskfull (0x0027)	STATUS_DISK_FULL (0xC000007F)	ENOSPC	The file system is full.

2.2.4.22 SMB_COM_READ_RAW (0x1A)

This command was introduced in the **CorePlus** dialect, but is often listed as part of the **LAN Manager 1.0** dialect. This command is deprecated. Clients SHOULD use the SMB_COM_READ_ANDX command.

The server indicates support by setting the CAP_RAW_MODE capabilities bit in the SMB_COM_NEGOTIATE response.

2.2.4.22.1 Request

```
SMB_Parameters
{
  UCHAR  WordCount;
  Words
  {
    USHORT FID;
    ULONG  Offset;
    USHORT MaxCountOfBytesToReturn;
    USHORT MinCountOfBytesToReturn;
    ULONG  Timeout;
    USHORT Reserved;
    ULONG  OffsetHigh (optional);
  }
}
```



```

SMB_Data
{
    USHORT ByteCount;
}

```

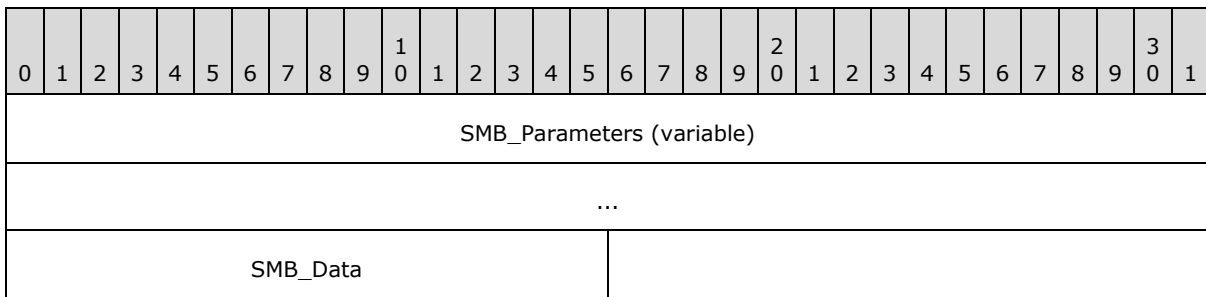

SMB_Parameters (variable):

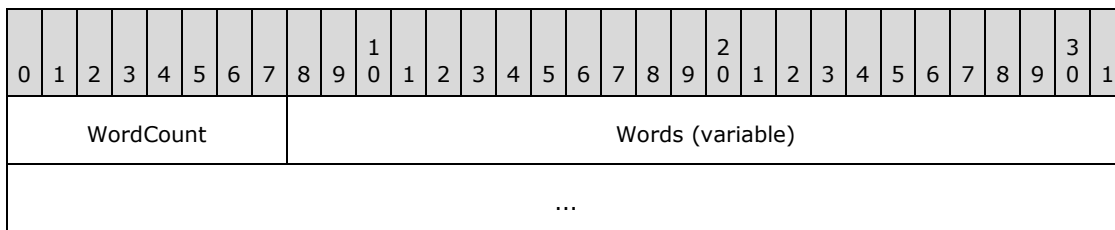

WordCount (1 byte): This field MUST be either 0x08 or 0x0A.

Words (variable):

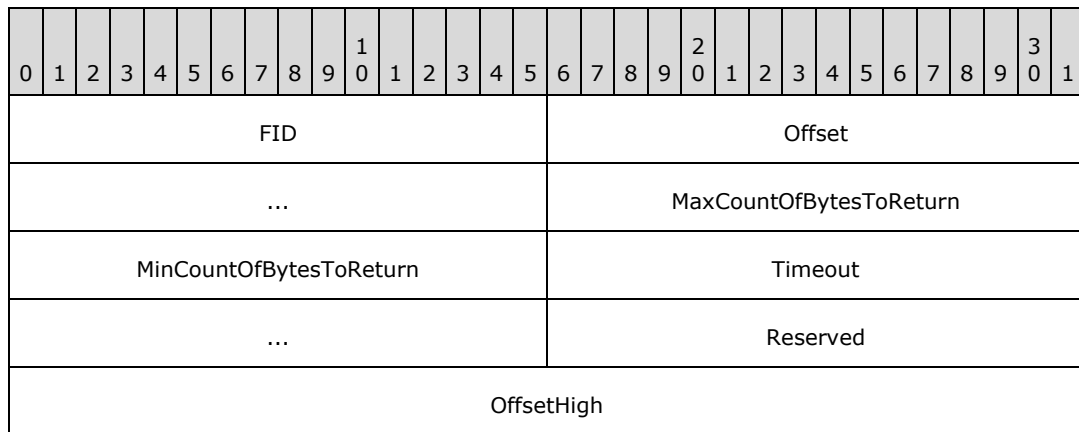

FID (2 bytes): This field MUST be a valid 16-bit signed integer indicating the file from which the data MUST be read.

Offset (4 bytes): The offset, in bytes, from the start of the file at which the read MUST begin. This is the lower 32 bits of a 64-bit value if the **WordCount** is 0x0A.

MaxCountOfBytesToReturn (2 bytes): The requested maximum number of bytes to read from the file and return to the client. The value MAY exceed the negotiated buffer size.

MinCountOfBytesToReturn (2 bytes): The requested minimum number of bytes to read from the file and return to the client. This field is used only when reading from a named pipe or a device. It is ignored when reading from a standard file.

Timeout (4 bytes): The number of milliseconds that the server is requested to wait while processing this command. This field is optionally honored only when reading from a named pipe or I/O device. It does not apply when reading from a regular file.

Reserved (2 bytes): This field SHOULD be set to 0x0000.

OffsetHigh (4 bytes): This field is optional, and is included only when **WordCount** is 0x0A. This field is the upper 32 bits of the offset, in bytes, from the start of the file at which the read MUST start. This field allows the client request to specify 64-bit file offsets.

SMB_Data (2 bytes):

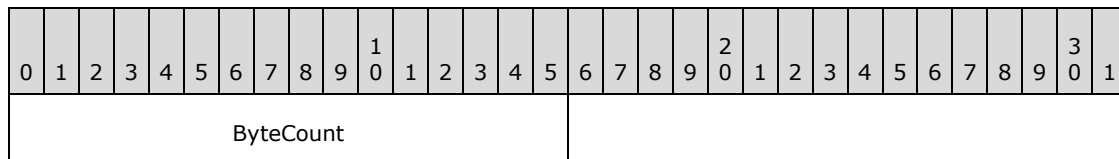

ByteCount (2 bytes): The length in bytes of the remaining SMB_Data. This field MUST be 0x0000.

2.2.4.22.2 Response

The server MUST not return the typical response data when responding to this request. The server MUST respond with one message containing the raw data being read from the file or named pipe. The server relies on the transport layer to provide the client with the length, in bytes, of the received message. This enables the client to request up to 65,535 bytes of data and receive it directly into an arbitrary buffer space. The amount of data requested is expected to be larger than the negotiated buffer size for this session. If the client request is to read more bytes than the file or named pipe contains, the size of the returned server message MUST be the number of bytes actually read from the file or named pipe. When the number of bytes returned to the client in the unformatted raw message is less than the bytes requested, this outcome indicates to the client that the end of file (EOF) has been reached.

Because the server does not return the typical response data, the SMB Protocol cannot guarantee that the client can associate the server response data (message) with the correct corresponding client request. Therefore, the client MUST guarantee that there are and will be no other requests from the client to the server for the duration of the [SMB_COM_READ_RAW \(section 2.2.4.22\)](#) command's processing.

Because the server does not provide the typical response data, it cannot provide error information when an error occurs. In the event of an error, the server MUST return zero bytes to the client. The client is then responsible for issuing an alternative file I/O command request that provides the typical server response data. The client SHOULD send [SMB_COM_READ_ANDX \(section 2.2.4.42\)](#) to determine the cause of the error. The server MUST then respond with the appropriate status and error information. It is up to the client to take appropriate action to recover from the error. Care needs to be taken when interpreting the server returning 0 bytes to the client, because this condition is also used to indicate that the EOF has been reached.

2.2.4.23 SMB_COM_READ_MPX (0x1B)

This command was introduced in the **LAN Manager 1.0** dialect. This command is obsolescent. The command was redesigned for NT LAN Manager. This document describes only the NT LAN Manager behavior. See section [2.1.2.1](#) for more information.

This is a specialized read command intended to maximize the performance of reading large blocks of data from a regular file while allowing for other operations to take place between the client and the server. This command is valid only when using a multiplexed session (see section [2.1.3](#)). The server MUST respond to the command request with one or more response messages until the requested amount of data has been returned or an error occurs. Each server response MUST contain the **TID**, **UID**, **PID**, **MID** and **CID** of the original client request and the **Offset** and **Count** describing the returned data (see the Response format following).

The client has received all of the data bytes when the sum of the **DataLength** fields received in each response equals the total amount of data bytes expected (the smallest **Count** received). This allows the protocol to work even if the responses are received out of sequence.

As is true in SMB_COM_READ, the total number of bytes returned can be less than the number requested only if a read specifies bytes beyond the current file size and FID refers to a disk file. In this case, only the bytes that exist MUST be returned. A read completely beyond the end of file MUST result in a single response with a **Count** value of 0x0000. If the total number of bytes returned is less than the number of bytes requested, this indicates end of file (if reading other than a standard blocked disk file, only zero bytes returned indicates end of file).

Once started, the Read Block Multiplexed operation is expected to go to completion. The client is expected to receive all the responses generated by the server. Conflicting commands (such as file close) MUST NOT be sent to the server while a multiplexed operation is in progress.

This command supports 32-bit file offsets only. Servers MAY [<32>](#) support this command. If the server supports this command, it MUST set the CAP_MPX_MODE (0x00000002) bit in the **Capabilities** field of the response to SMB Protocol negotiation on connectionless transports.

2.2.4.23.1 Request

```
SMB_Parameters
{
  UCHAR  WordCount;
  Words
  {
    USHORT FID;
    ULONG  Offset;
    USHORT MaxCountOfBytesToReturn;
    USHORT MinCountOfBytesToReturn;
    ULONG  Timeout;
    USHORT Reserved;
  }
}
SMB_Data
{
  USHORT ByteCount;
}
```

[SMB Header:](#)

CID (2 bytes): This field MUST contain the Connection ID (CID) of the connectionless transport session.

MID (2 bytes): This field MUST contain a valid MID that MUST be unique to this request within the client's session.

0	1	2	3	4	5	6	7	8	9	10	11	12	13	14	15	16	17	18	19	20	21	22	23	24	25	26	27	28	29	30	31
SMB_Parameters																															
...																															
...																															
...																															
...																SMB_Data															

SMB_Parameters (17 bytes):

0	1	2	3	4	5	6	7	8	9	10	11	12	13	14	15	16	17	18	19	20	21	22	23	24	25	26	27	28	29	30	31
WordCount										Words																					
...																															
...																															
...																															
...																															

WordCount (1 byte): This field MUST be 0x08. The length, in two-byte words, of the remaining SMB_Parameters.

Words (16 bytes):

0	1	2	3	4	5	6	7	8	9	10	11	12	13	14	15	16	17	18	19	20	21	22	23	24	25	26	27	28	29	30	31
FID																Offset															
...																MaxCountOfBytesToReturn															
MinCountOfBytesToReturn																Timeout															

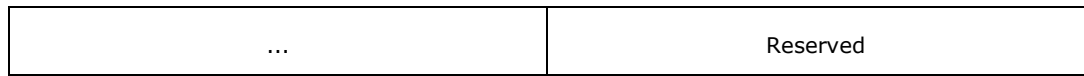

FID (2 bytes): This field MUST be a valid 16-bit unsigned integer indicating the file from which the data MUST be read.

Offset (4 bytes): The offset, in bytes, from the start of the file at which the read begins.

MaxCountOfBytesToReturn (2 bytes): The requested maximum number of bytes to read from the file and return to the client. The value MAY exceed the negotiated buffer size.

MinCountOfBytesToReturn (2 bytes): The requested minimum number of bytes to read from the file and return to the client. This field is used only when reading from a named pipe or a device. It MUST be ignored when reading from a standard file.

Timeout (4 bytes): The number of milliseconds that the server is requested to wait while processing this command. This field is optionally honored only when reading from a named pipe or I/O device. It does not apply when reading from a regular file.

Reserved (2 bytes): This field SHOULD be set to 0x0000.

SMB_Data (2 bytes):

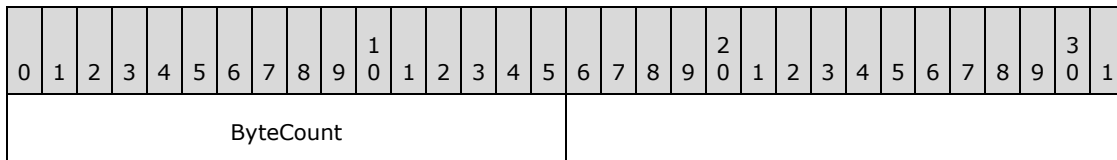

ByteCount (2 bytes): This field MUST be 0x0000. No data is sent by this message.

2.2.4.23.2 Response

```

SMB_Parameters
{
  UCHAR WordCount;
  Words
  {
    ULONG Offset;
    USHORT Count;
    USHORT Remaining;
    USHORT DataCompactionMode;
    USHORT Reserved;
    USHORT DataLength;
    USHORT DataOffset;
  }
}
SMB_Data
{
  USHORT ByteCount;
  Bytes
  {
    UCHAR Pad[];
    UCHAR Data[DataLength];
  }
}

```

0	1	2	3	4	5	6	7	8	9	10	11	12	13	14	15	16	17	18	19	20	21	22	23	24	25	26	27	28	29	30	31
SMB_Parameters																															
...																															
...																															
...																															
...																SMB_Data (variable)															
...																															

SMB_Parameters (17 bytes):

0	1	2	3	4	5	6	7	8	9	10	11	12	13	14	15	16	17	18	19	20	21	22	23	24	25	26	27	28	29	30	31
WordCount										Words																					
...																															
...																															
...																															
...																															

WordCount (1 byte): This field MUST be 0x08. The length, in two-byte words, of the remaining **SMB_Parameters**.

Words (16 bytes):

0	1	2	3	4	5	6	7	8	9	10	11	12	13	14	15	16	17	18	19	20	21	22	23	24	25	26	27	28	29	30	31
Offset																															
Count																Remaining															
DataCompactionMode																Reserved															
DataLength																DataOffset															

Offset (4 bytes): The offset, in bytes, from the start of the file at which the read occurred.

Count (2 bytes): The total number of bytes designated to be returned in all responses to this request. This value usually starts at **MaxCountOfBytesToReturn**, but can be an overestimate. The overestimate can be reduced while the read is in progress. The last response generated by the server MUST contain the actual total number of bytes read and sent to the client in all of the responses. If the value in the last response is less than **MaxCountOfBytesToReturn**, the end of file was encountered during the read. If this value is exactly zero (0x0000), the original **Offset** into the file began at or after the end of file; in this case, only one response MUST be generated. The value of the field can (and usually does) exceed the negotiated buffer size.

Remaining (2 bytes): This integer MUST be -1 for regular files. For I/O devices or named pipes, this indicates the number of bytes remaining to be read from the file after the bytes returned in the response were de-queued. Servers SHOULD return 0xFFFF if they do not support this function on I/O devices or named pipes.

DataCompactionMode (2 bytes): Not used and MUST be 0x0000.

Reserved (2 bytes): This field MUST be set to 0x0000.

DataLength (2 bytes): This field is the number of bytes read and included in the response. The value of this field MUST NOT cause the message to exceed the client's maximum buffer size as specified in **MaxBufferSize** of the [SMB_COM_SESSION_SETUP_AND_X \(section 2.2.4.53\)](#) client request.

DataOffset (2 bytes): The offset, in bytes, from the beginning of the [SMB Header \(section 2.2.3.1\)](#) to the start of the **Buffer** field in the **SMB_Data** block.

SMB_Data (variable):

0	1	2	3	4	5	6	7	8	9	10	11	12	13	14	15	16	17	18	19	20	21	22	23	24	25	26	27	28	29	30	31
ByteCount																Bytes (variable)															
...																															

ByteCount (2 bytes): The length, in bytes, of the remaining SMB_Data. The length MUST be between **DataLength** and **DataLength** + 0x0003.

Bytes (variable):

0	1	2	3	4	5	6	7	8	9	10	11	12	13	14	15	16	17	18	19	20	21	22	23	24	25	26	27	28	29	30	31
Pad (variable)																															
...																															
Buffer (variable)																															
...																															

Pad (variable): Padding bytes to align data on a proper address boundary. The **DataOffset** field points to the first byte after this field.

Buffer (variable): The bytes read from the file.

Error Codes

SMB error class	SMB error code	NT status code	POSIX equivalent	Description
ERRDOS (0x01)	ERRnoaccess (0x0005)	STATUS_ALREADY_COMMITTED (0xC0000021)	ENOLCK	Attempt to read from a portion of the file that the server detects has been locked or has been opened in deny-read.
ERRDOS (0x01)	ERRbadfid (0x0006)	STATUS_INVALID_HANDLE (0xC0000008) STATUS_SMB_BAD_FID (0x00060001)	ENFILE	Attempt to read from a FID that the server does not have open.
ERRDOS (0x01)	ERRnomem (0x0008)	STATUS_INSUFF_SERVER_RESOURCES (0xC0000205)	ENOMEM	The server is out of resources.
ERRDOS (0x01)	ERRbadaccess (0x000C)	STATUS_ACCESS_DENIED (0xC0000022)		Read permission required.
ERRDOS (0x01)	ERRlock (0x0021)	STATUS_FILE_LOCK_CONFLICT (0xC0000054) STATUS_LOCK_NOT_GRANTED (0xC0000055)	EAGAIN	The requested byte range was already locked by a different process (PID).
ERRDOS (0x01)	ERReof (0x0026)	STATUS_END_OF_FILE (0xC0000011)		Attempted to read beyond the end of the file.
ERRSRV (0x02)	ERRerror (0x0001)		EBADF	The FID was validated by the server but unacceptable to the system.
ERRSRV (0x02)	ERRerror (0x0001)		EDEADLK	The read would block and deadlock would result.
ERRSRV (0x02)	ERRerror (0x0001)	STATUS_INVALID_SMB (0x00010002)		A corrupt request has been encountered.
ERRSRV (0x02)	ERRinvdevice (0x0007)	STATUS_BAD_DEVICE_TYPE (0xC00000CB)		Attempt to read from an open spool file.

SMB error class	SMB error code	NT status code	POSIX equivalent	Description
ERRSRV (0x02)	ERRinvtid (0x0005)	STATUS_SMB_BAD_TID (0x00050002)		Invalid TID in request.
ERRSRV (0x02)	ERRbaduid (0x005B)	STATUS_SMB_BAD_UID (0x005B0002)		The UID specified is not defined as a valid ID for this session, or the user identified by the UID does not have sufficient privileges.
ERRSRV (0x02)	ERRuseSTD (0x00FB)	STATUS_SMB_USE_STD (0x00FB0002)		This command is not supported for the FID at this time. Use a standard read command.
ERRHRD (0x03)	ERRdata (0x0017)	STATUS_DATA_ERROR (0xC000003E)	EIO	A problem has occurred in the physical I/O.
ERRHRD (0x03)	ERRread (0x001E)		ENXIO	The device associated with the file descriptor is a block-special or character-special file and the value of the file pointer is out of range.

2.2.4.24 SMB_COM_READ_MPX_SECONDARY (0x1C)

This command was introduced in the **LAN Manager 1.0** dialect (see [\[SMB-LM1X\]](#) section 9.2.13). It was rendered obsolete in the NT LAN Manager dialect.

This command is no longer used in conjunction with the SMB_COM_READ_MPX command. Clients SHOULD NOT send requests using this command code. Servers receiving requests with this command code SHOULD return STATUS_NOT_IMPLEMENTED (ERRDOS/ERRbadfunc). [<33>](#)

2.2.4.25 SMB_COM_WRITE_RAW (0x1D)

This command was introduced in the **CorePlus** dialect, but is often listed as part of the **LAN Manager 1.0** dialect. This command is deprecated. Clients SHOULD use the [SMB_COM_WRITE_ANDX \(section 2.2.4.43\)](#) command.

Server support of this command is optional. The server MUST indicate support for Raw Read/Write using the CAP_RAW_MODE Capabilities bit during protocol negotiation.

SMB_COM_WRITE_RAW is a specialized write command intended to maximize performance when writing large blocks of data to an open regular file, a named pipe, a device, or spooled output. The

command permits a client to send a large unformatted data (raw byte) message over the **SMB transport** without requiring the usual SMB request format. It also permits a client to send messages in excess of the maximum buffer size established during session setup.

The server MUST accept an unformatted data message of up to 65,535 bytes in length. The server MUST allow the client [SMB_COM_WRITE_RAW Request \(section 2.2.4.25.1\)](#) to include an unformatted message. The client MAY send part of the data to be written along with the SMB_COM_WRITE_RAW Request.

2.2.4.25.1 Request

```

SMB_Parameters
{
  UCHAR  WordCount;
  Words
  {
    USHORT FID;
    USHORT CountOfBytes;
    USHORT Reserved1;
    ULONG  Offset;
    ULONG  Timeout;
    USHORT WriteMode;
    ULONG  Reserved2;
    USHORT DataLength;
    USHORT DataOffset;
    ULONG  OffsetHigh (optional);
  }
}
SMB_Data
{
  USHORT ByteCount;
  Words
  {
    UCHAR Pad[];
    UCHAR Data[DataLength];
  }
}

```

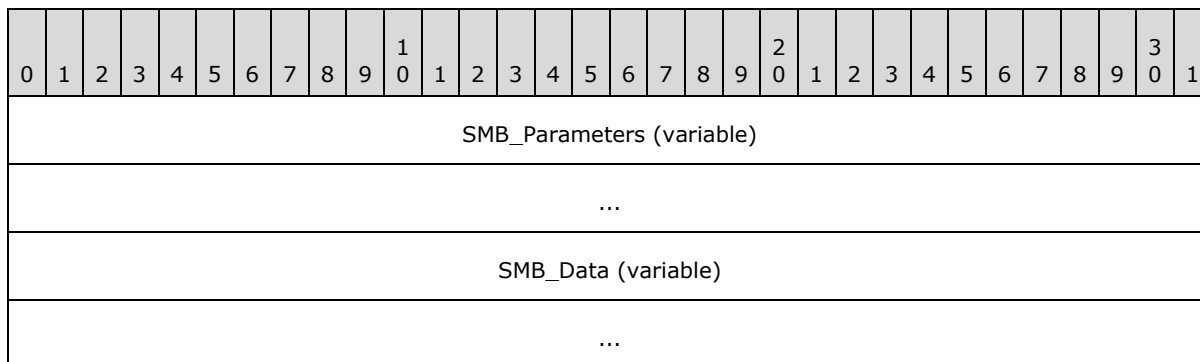

SMB_Parameters (variable):

0	1	2	3	4	5	6	7	8	9	10	11	12	13	14	15	16	17	18	19	20	21	22	23	24	25	26	27	28	29	30	31					
WordCount										Words (variable)																										
...																																				

WordCount (1 byte): This field MUST be 0x0C or 0x0E

Words (variable):

0	1	2	3	4	5	6	7	8	9	10	11	12	13	14	15	16	17	18	19	20	21	22	23	24	25	26	27	28	29	30	31					
FID										CountOfBytes																										
Reserved1										Offset																										
...										Timeout																										
...										WriteMode																										
Reserved2																																				
DataLength																	DataOffset																			
OffsetHigh																																				

FID (2 bytes): This field MUST be a valid 16-bit unsigned integer indicating the file, named pipe, or device to which the data MUST be written.

CountOfBytes (2 bytes): The total number of bytes to be written to the file during the entire dialog. The value MAY exceed the maximum buffer size (**MaxBufferSize**) established for the session.

Reserved1 (2 bytes): This field is reserved and MUST be ignored by the server.

Offset (4 bytes): The offset, in bytes, from the start of the file at which the write SHOULD begin. If **WordCount** is 0x0E, this is the lower 32 bits of a 64-bit value.

Timeout (4 bytes): This field is the time-out, in milliseconds, to wait for the write to complete. This field is optionally honored only when writing to a named pipe or I/O device. It does not apply and MUST be 0x00000000 when writing to a regular file.

WriteMode (2 bytes): A 16-bit field containing flags defined as follows. The flag names below are provided for reference only.

Name and bitmask	Meaning
WritethroughMode	If set, the server MUST NOT respond to the client before the

Name and bitmask	Meaning
0x0001	data is written to disk (write-through).
ReadBytesAvailable 0x0002	If set, the server SHOULD set the Interim Response Response.SMB_Parameters.Available field correctly for writes to named pipes or I/O devices.
NamedPipeRaw 0x0004	Applicable to named pipes only. If set, the named pipe MUST be written to in raw mode (no translation; the opposite of message mode).
NamedPipeStart 0x0008	Applicable to named pipes only. If set, this data is the start of a message.

If **WritethroughMode** is not set, this SMB is assumed to be a form of write behind (cached write). The SMB transport layer guarantees delivery of raw data from the client. If an error occurs at the server end, all bytes MUST be received and discarded. If an error occurs while writing data to disk (such as disk full) the next access to the file handle (another write, close, read, etc.) MUST result in an error, reporting this situation.

If **WritethroughMode** is set, the server MUST receive the data, write it to disk and then send a Final Server Response (section [2.2.4.25.3](#)) indicating the result of the write. The total number of bytes successfully written MUST also be returned in the **SMB_Parameters.Count** field of the response.

Reserved2 (4 bytes): This field MUST be 0x00000000.

DataLength (2 bytes): This field is the number of bytes included in the SMB_Data block that are to be written to the file.

DataOffset (2 bytes): This field is the offset, in bytes, from the start of the [SMB Header \(section 2.2.3.1\)](#) to the start of the data to be written to the file from the **Data[]** field. Specifying this offset allows the client to efficiently align the data buffer.

OffsetHigh (4 bytes): If **WordCount** is 0x0E, this is the upper 32 bits of the 64-bit offset in bytes from the start of the file at which the write MUST start. Support of this field is optional.

SMB_Data (variable):

0	1	2	3	4	5	6	7	8	9	10	11	12	13	14	15	16	17	18	19	20	21	22	23	24	25	26	27	28	29	30	31
ByteCount										Bytes (variable)																					
...																															

ByteCount (2 bytes): This field MUST be greater than or equal to 0x0000.

Bytes (variable):

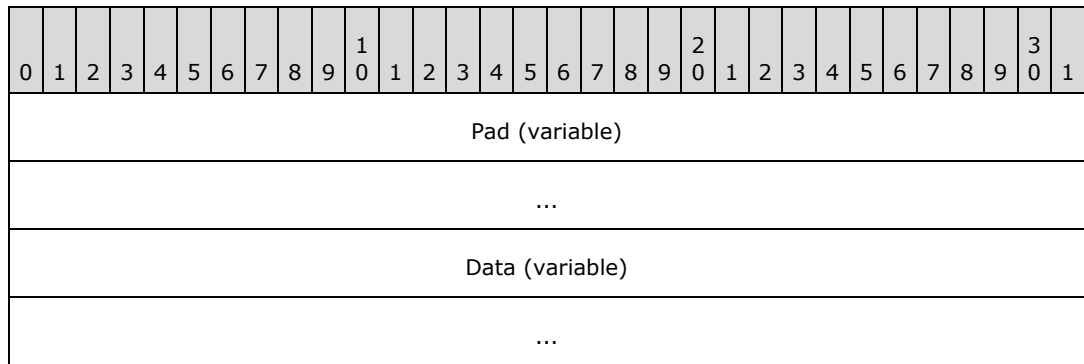

Pad (variable): Padding bytes for the client to align the data on an appropriate boundary for transfer of the SMB transport. The server MUST ignore these bytes.

Data (variable): The bytes to be written to the file.

2.2.4.25.2 Interim Server Response

```

SMB_Parameters
{
  UCHAR WordCount;
  Words
  {
    USHORT Available;
  }
}
SMB_Data
{
  USHORT ByteCount;
}

```

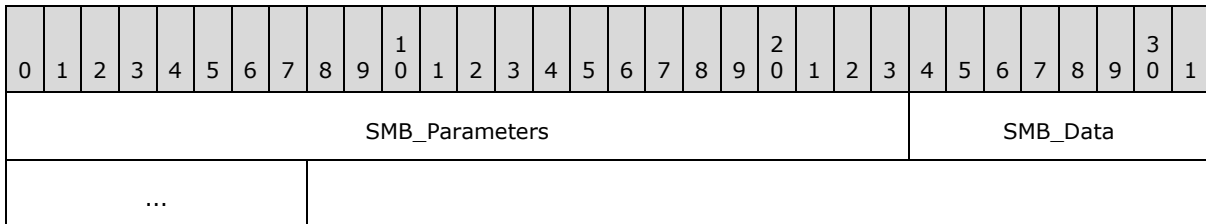

SMB_Parameters (3 bytes):

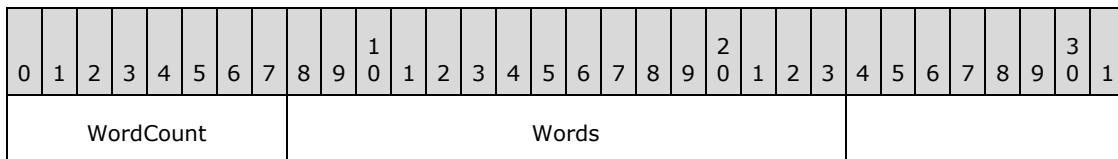

WordCount (1 byte): This field MUST be 0x01.

Words (2 bytes):

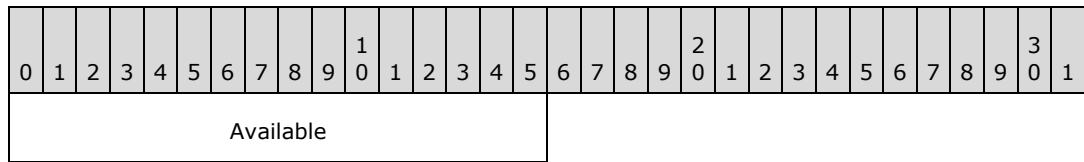

Available (2 bytes): This field is valid when writing to named pipe or I/O devices. This field indicates the number of bytes remaining to be written after the requested write was completed. If the client writes to a disk file, this field MUST be set to 0xFFFF. <34>

SMB_Data (2 bytes):

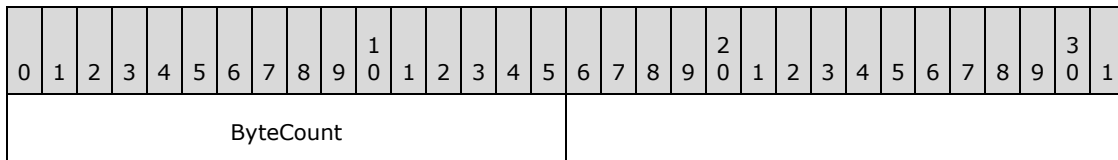

ByteCount (2 bytes): This field MUST be 0x0000. No data is sent by this message.

2.2.4.25.3 Final Server Response

```
SMB_Parameters
{
  UCHAR WordCount;
  Words
  {
    USHORT Count;
  }
}
SMB_Data
{
  USHORT ByteCount;
}
```

SMB Header:

Command (1 byte): This field MUST contain the [SMB_COM_WRITE_COMPLETE](#) (section 2.2.4.28) command code of 0x20.

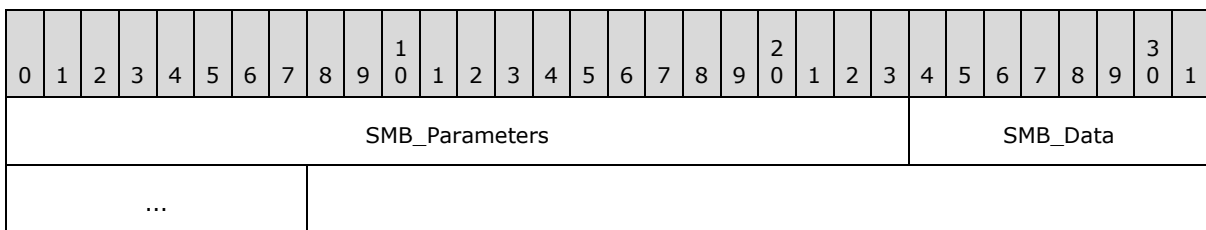

SMB_Parameters (3 bytes):

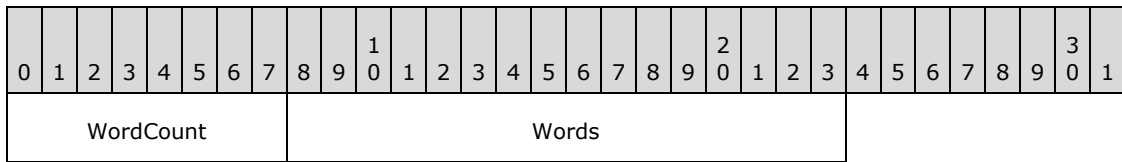

WordCount (1 byte): This field MUST be 0x01.

Words (2 bytes):

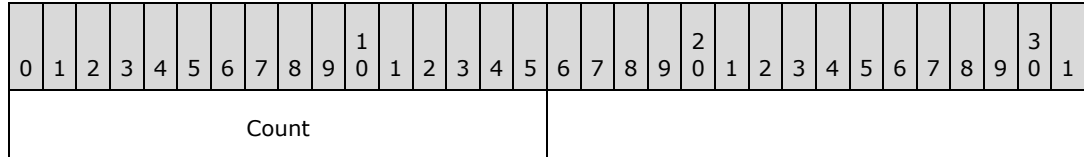

Count (2 bytes): This field contains the total number of bytes written to the file by the server.

SMB_Data (2 bytes):

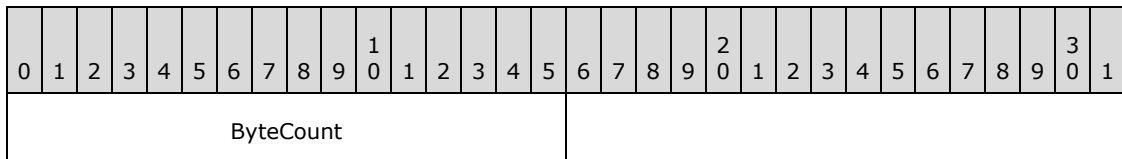

ByteCount (2 bytes): This field MUST be 0x0000. No data is sent by this message.

Error Codes

SMB error class	SMB error code	NT status code	POSIX equivalent	Description
SUCCESS (0x00)	SUCCESS (0x0)	STATUS_SUCCESS (0x00000000)	EFBIG	The file has grown too large and no more data can be written to the file. A Count of zero (0x0000) MUST be returned to the client in the server response. This indicates to the client that the file system is full.
SUCCESS (0x00)	SUCCESS (0x0)	STATUS_SUCCESS (0x00000000)	NOSPC	No space on the file system. The server MUST return a zero (0x0000) in the Count field of the response. This indicates that the file system is full.
ERRDOS (0x01)	ERRnoaccess (0x0005)		EAGAIN	Resources for I/O on the server are temporarily exhausted.

SMB error class	SMB error code	NT status code	POSIX equivalent	Description
ERRDOS (0x01)	ERRnoaccess (0x0005)	STATUS_ALREADY_COMMITTED (0xC0000021)	ENOLCK	A record lock has been taken on the file or the client has attempted to write to a portion of the file that the server knows has been locked, opened in deny-write mode, or opened in read-only mode.
ERRDOS (0x01)	ERRbadfid (0x0006)	STATUS_INVALID_HANDLE (0xC0000008) STATUS_SMB_BAD_FID (0x00060001)	ENFILE	Invalid FID, or FID mapped to a valid server FID but it was not acceptable to the operating system.
ERRDOS (0x01)	ERRnomem (0x0008)	STATUS_INSUFF_SERVER_RESOURCES (0xC0000205)	ENOMEM	The server is out of resources.
ERRDOS (0x01)	ERRbadaccess (0x000C)	STATUS_ACCESS_DENIED (0xC0000022)		Write permission required. The UID provided does not have write permission on the specified FID.
ERRDOS (0x01)	ERRlock (0x0021)	STATUS_FILE_LOCK_CONFLICT (0xC0000054) STATUS_LOCK_NOT_GRANTED (0xC0000055)		The requested byte range was already locked by a different process (PID).
ERRDOS (0x01)	ERRnotconnected (0x00E9)	STATUS_PIPE_DISCONNECTED (0xC00000B0)	EPIPE	Write to a named pipe with no reader.
ERRSRV (0x02)	ERRerror (0x0001)		EDEADLK	The write would block due to locking and deadlock would result.
ERRSRV (0x02)	ERRerror (0x0001)		ERANGE	Attempted write size is outside of the minimum or maximum ranges that can be written to the supplied FID.
ERRSRV (0x02)	ERRerror (0x0001)	STATUS_INVALID_SMB (0x00010002)		A corrupt SMB request was received. In addition to other causes, this status is sent if the value of the DataLength field is invalid with respect to

SMB error class	SMB error code	NT status code	POSIX equivalent	Description
				either the CountOfBytes field or the number of bytes in the SMB_Data_Bytes.Data field.
ERRSRV (0x02)	ERRinvtid (0x0005)	STATUS_SMB_BAD_TID (0x00050002)		Invalid TID in request.
ERRSRV (0x02)	ERRqfull (0x0031)	STATUS_PRINT_QUEUE_FULL (0xC00000C6)		Print queue is full - too many queued items.
ERRSRV (0x02)	ERRqtoobig (0x0032)	STATUS_NO_SPOOL_SPACE (0xC00000C7)		Print queue is full - too many queued items.
ERRSRV (0x02)	ERRbaduid (0x005B)	STATUS_SMB_BAD_UID (0x005B0002)		The UID specified is not known as a valid ID on this server session, or the user identified by the UID does not have sufficient privileges.
ERRSRV (0x02)	ERRusestd (0x00FB)	STATUS_SMB_USE_STANDARD (0x00FB0002)		Write MPX support is not available. Use a standard write request.
ERRHRD (0x03)	ERRdata (0x0017)	STATUS_DATA_ERROR (0xC000003E)	EIO	A problem has occurred in the physical I/O.
ERRHRD (0x03)	ERRwrite (0x001D)		ENXIO	The device associated with the file descriptor is a block-special or character-special file and the value of the file pointer is out of range.
ERRHRD (0x03)	ERRdiskfull (0x0027)	STATUS_DISK_FULL (0xC000007F)	ENOSPC	The file system is full.

2.2.4.26 SMB_COM_WRITE_MPX (0x1E)

This command was introduced in the **LAN Manager 1.0** dialect and is obsolescent. The command was redesigned for NT LAN Manager. This document describes only the NT LAN Manager behavior. See section [2.1.2.1](#) for more information.

SMB_COM_WRITE_MPX is used to maximize performance when writing a large block of data from the client to the server. This command is valid only when using a multiplexed session over a connectionless transport; see section [2.1.3](#). The **TID**, **PID**, **UID**, **MID**, and **CID** MUST be identical in all requests and responses in a given SMB_COM_WRITE_MPX exchange.

This command supports 32-bit file offsets only. Server support of this command is optional. If the server supports this command, it MUST set the CAP_MPX_MODE bit in the **Capabilities** field of the response to SMB Protocol negotiation. <35>

2.2.4.26.1 Request

```
SMB_Parameters
{
  UCHAR WordCount;
  Words
  {
    USHORT FID;
    USHORT TotalByteCount;
    USHORT Reserved;
    ULONG ByteOffsetToBeginWrite;
    ULONG Timeout;
    USHORT WriteMode;
    ULONG RequestMask;
    USHORT DataLength;
    USHORT DataOffset;
  }
}
SMB_Data
{
  USHORT ByteCount;
  Bytes
  {
    UCHAR Pad[];
    UCHAR Buffer[DataLength];
  }
}
```

SMB Header:

SequenceNumber (2 bytes): This field MUST be zero (0x0000) unless the request is the last request in the multiplexed write sequence, in which case it MUST be a nonzero value. The nonzero value indicates to the server that this is the last request of the sequence and the server MUST respond by sending an [SMB_COM_WRITE_MPX Response \(section 3.2.5.19\)](#).

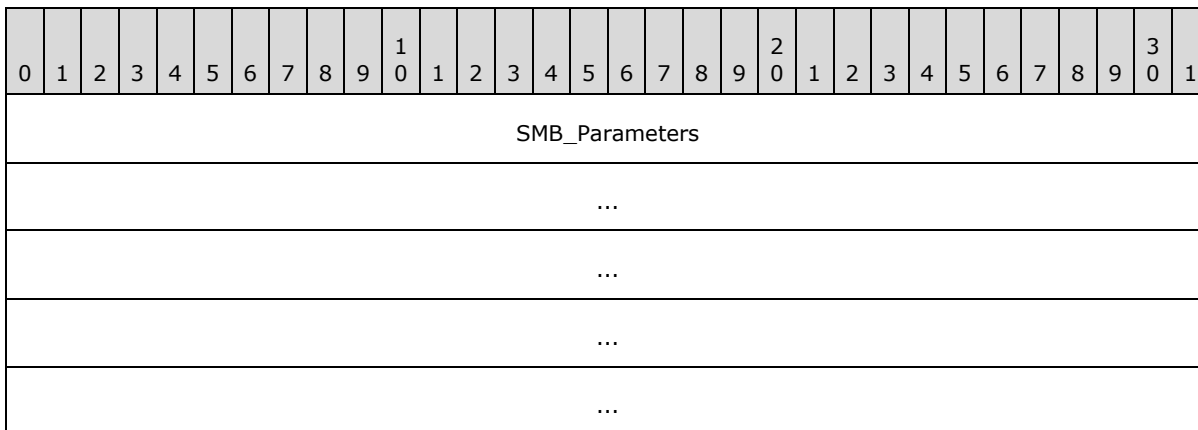

...	
...	SMB_Data (variable)
...	

SMB_Parameters (25 bytes):

0	1	2	3	4	5	6	7	8	9	10	11	12	13	14	15	16	17	18	19	20	21	22	23	24	25	26	27	28	29	30	31
WordCount										Words																					
...																															
...																															
...																															
...																															
...																															
...																															

WordCount (1 byte): This field MUST be 0x0C. The length, in two-byte words, of the remaining **SMB_Parameters**.

Words (24 bytes):

0	1	2	3	4	5	6	7	8	9	10	11	12	13	14	15	16	17	18	19	20	21	22	23	24	25	26	27	28	29	30	31
FID																TotalByteCount															
Reserved																ByteOffsetToBeginWrite															
...																Timeout															
...																WriteMode															
RequestMask																															
DataLength																DataOffset															

FID (2 bytes): This field MUST be a valid 16-bit unsigned integer indicating the file to which the data should be written.

TotalByteCount (2 bytes): The requested total number of bytes to write to the file. The value MAY exceed the negotiated buffer size.

Reserved (2 bytes): The server MUST ignore this value.

ByteOffsetToBeginWrite (4 bytes): The offset, in bytes, from the start of the file at which the write should begin. This value indicates the offset at which to write the data contained in the **SMB_Data.Bytes.Buffer** field of the same message.

Timeout (4 bytes): This field MUST be ignored by the server. <36>

WriteMode (2 bytes): A 16-bit field containing flags defined as follows.

Name and bitmask	Meaning
WritethroughMode 0x0001	If set, the server MUST NOT respond to the client before the data is written to disk.
ConnectionlessMode 0x0080	If set, this flag indicates that messages are being sent over a connectionless transport. This flag MUST be set.

If **WritethroughMode** is not set, the server is assumed to be performing a form of write behind (cached writing). The SMB transport layer guarantees delivery of all secondary requests from the client. If an error occurs at the server end, all bytes received MUST be ignored and discarded. If an error such as disk full occurs while writing data to disk, the next access of the file handle (another write, close, read, and so on). MUST return the fact that the error occurred. The value of this error status MUST be the same for all requests that are part of the same write operation.

If **WritethroughMode** is set, the server MUST receive the data, write it to disk, and then send a final response indicating the result of the write.

RequestMask (4 bytes): This field is a bit mask indicating this SMB request's identity to the server. The server's response MUST contain the logical OR of all of the **RequestMask** values received. This response MUST be generated.

DataLength (2 bytes): This field value is the number of data bytes included in this request.

DataOffset (2 bytes): This field value is the offset, in bytes, from the start of the SMB Header (section 2.2.3.1) to the start of the data buffer.

SMB_Data (variable):

0	1	2	3	4	5	6	7	8	9	10	11	12	13	14	15	16	17	18	19	20	21	22	23	24	25	26	27	28	29	30	31
ByteCount										Bytes (variable)																					
...																															

ByteCount (2 bytes): This field MUST be greater than or equal to 0x0001.

Bytes (variable):

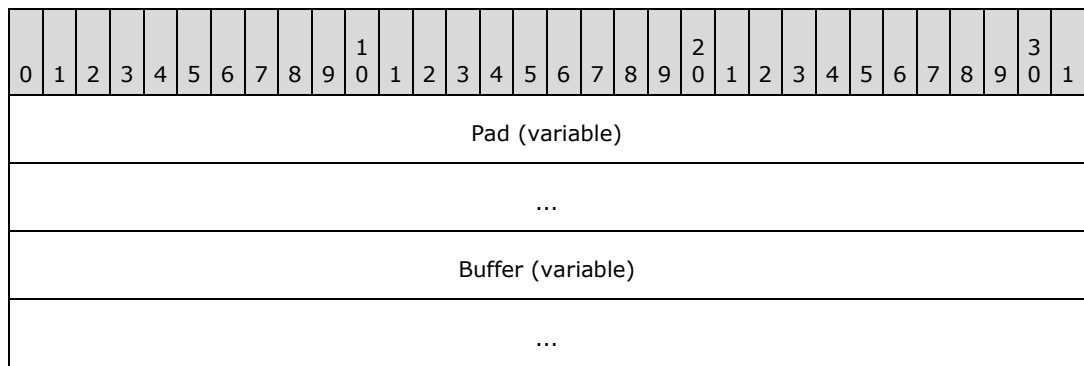

Pad (variable): Null padding bytes to align **Buffer** to a 16- or 32-bit boundary.

Buffer (variable): The raw data, in bytes, that is to be written to the file.

2.2.4.26.2 Response

```

SMB_Parameters
{
    UCHAR WordCount;
    Words
    {
        ULONG ResponseMask;
    }
}
SMB_Data
{
    USHORT ByteCount;
}

```

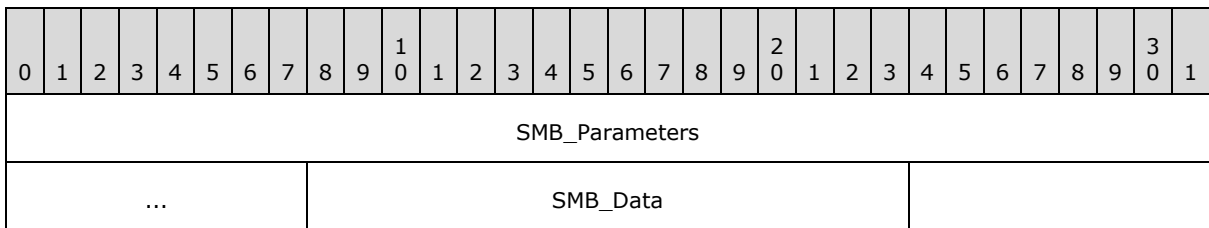

SMB_Parameters (5 bytes):

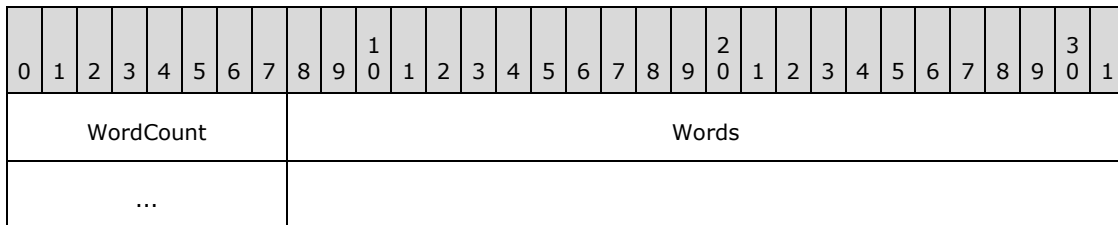

WordCount (1 byte): This field MUST be 0x02.

Words (4 bytes):

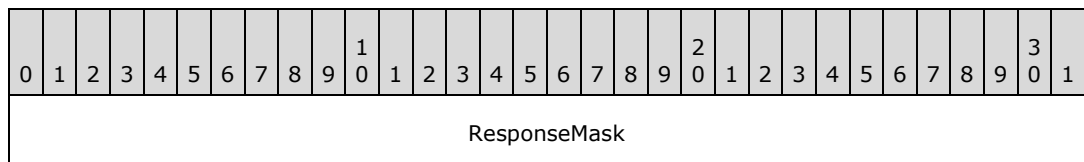

ResponseMask (4 bytes): This field is the logical OR-ing of the **RequestMask** value contained in each [SMB_COM_WRITE_MPX \(section 2.2.4.26\)](#) received since the last sequenced SMB_COM_WRITE_MPX. The server responds only to the final (sequenced) command. This response contains the accumulated **ResponseMask** from all successfully received requests. The client uses the **ResponseMask** received to determine which packets, if any, MUST be retransmitted.

SMB_Data (2 bytes):

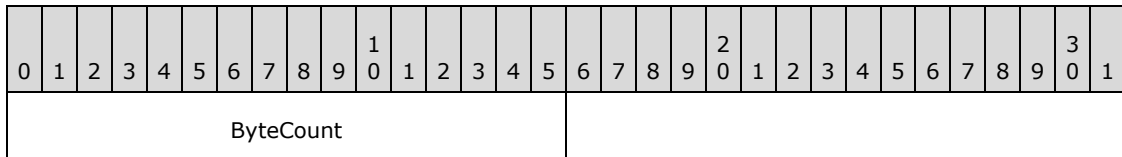

ByteCount (2 bytes): This field MUST be 0x0000. No data is sent by this message.

Error Codes

If the **WritethroughMode** flag is clear in the client requests (particularly the sequenced request), the server SHOULD return a response upon receiving the sequenced request. Any data not yet written MUST be written after the response has been sent. Any errors generated after the server has sent the SMB_COM_WRITE_MPX response MUST be saved and returned the next time that the FID is referenced.

SMB error class	SMB error code	NT status code	POSIX equivalent	Description
SUCCESS (0x00)	SUCCESS (0x0)	STATUS_SUCCESS (0x00000000)	EFBIG	The file has grown too large and no more data can be written to the file. A Count of zero (0x0000) MUST be returned to the client in the server response. This indicates to the client that the file system is full.
SUCCESS (0x00)	SUCCESS (0x0)	STATUS_SUCCESS (0x00000000)	NOSPC	No space on the file system. The server MUST return a zero (0x0000) in the Count field of the response. This indicates that the file system is full.

SMB error class	SMB error code	NT status code	POSIX equivalent	Description
ERRDOS (0x01)	ERRnoaccess (0x0005)		EAGAIN	Resources for I/O on the server are temporarily exhausted.
ERRDOS (0x01)	ERRnoaccess (0x0005)	STATUS_ACCESS_DENIED (0xC0000022)		The client does not have write permission.
ERRDOS (0x01)	ERRbadfid (0x0006)	STATUS_INVALID_HANDLE (0xC0000008) STATUS_SMB_BAD_FID (0x00060001)	ENFILE	Invalid FID, or FID mapped to a valid server FID but it was not acceptable to the operating system.
ERRDOS (0x01)	ERRnomem (0x0008)	STATUS_INSUFF_SERVER_RESOURCES (0xC0000205)	ENOMEM	The server is out of resources.
ERRDOS (0x01)	ERRbadaccess (0x000C)	STATUS_ACCESS_DENIED (0xC0000022)		Write permission required.
ERRDOS (0x01)	ERRlock (0x0021)	STATUS_FILE_LOCK_CONFLICT (0xC0000054)		The requested byte range was already locked by a different process (PID).
ERRSRV (0x02)	ERRerror (0x0001)		EDEADLK	The write would block due to locking and deadlock would result.
ERRSRV (0x02)	ERRerror (0x0001)		ERANGE	Attempted write size is outside of the minimum or maximum ranges that can be written to the supplied FID.
ERRSRV (0x02)	ERRerror (0x0001)	STATUS_INVALID_SMB (0x00010002)		A corrupt or invalid SMB request was received.
ERRSRV (0x02)	ERRinvtid (0x0005)	STATUS_SMB_BAD_TID (0x00050002)		Invalid TID in request.
ERRSRV (0x02)	ERRqfull (0x0031)	STATUS_PRINT_QUEUE_FULL (0xC00000C6)		Print queue is full - too many queued items.
ERRSRV	ERRqtoobig	STATUS_NO_SPOOL_SPACE		Print queue is full

SMB error class	SMB error code	NT status code	POSIX equivalent	Description
(0x02)	(0x0032)	(0xC00000C7)		- too many queued items.
ERRSRV (0x02)	ERRbaduid (0x005B)	STATUS_SMB_BAD_UID (0x005B0002)		The UID specified is not known as a valid ID on this server session, or the user identified by the UID does not have sufficient privileges.
ERRSRV (0x02)	ERRuseSTD (0x00FB)	STATUS_SMB_USE_STANDARD (0x00FB0002)		Not a datagram or connectionless transport OR the FID is not a disk file OR print queue client MUST use standard write commands.
ERRHRD (0x03)	ERRdata (0x0017)	STATUS_DATA_ERROR (0xC000003E)	EIO	A problem has occurred in the physical I/O.
ERRHRD (0x03)	ERRwrite (0x001D)		ENXIO	The device associated with the file descriptor is a block-special or character-special file and the value of the file pointer is out of range.
ERRHRD (0x03)	ERRgeneral (0x001F)	STATUS_CANCELLED (0xC0000120)		A transport error occurred and the request was canceled.
ERRHRD (0x03)	ERRdiskfull (0x0027)	STATUS_DISK_FULL (0xC000007F)	ENOSPC	The file system is full.

2.2.4.27 SMB_COM_WRITE_MPX_SECONDARY (0x1F)

This command was introduced in the **LAN Manager 1.0** dialect (see [\[SMB-LM1X\]](#) section 9.2.22). It was rendered obsolete in the NT LAN Manager dialect.

This command is no longer used in conjunction with the [SMB_COM_WRITE_MPX \(section 2.2.4.26\)](#) command. Clients SHOULD NOT send requests using this command code, and servers receiving requests with this command code SHOULD return STATUS_NOT_IMPLEMENTED (ERRDOS/ERRbadfunc).<37>

2.2.4.28 SMB_COM_WRITE_COMPLETE (0x20)

This command was introduced in **LAN Manager 1.0** dialect (see [\[SMB-LM1X\]](#) section 9.2.22). This command is deprecated. This command is sent by the server as the final response of an [SMB_COM_WRITE_RAW \(section 2.2.4.25\)](#) command sequence.

2.2.4.29 SMB_COM_QUERY_SERVER (0x21)

This command was introduced in the **NT LAN Manager** dialect, and was reserved but not implemented.

Clients SHOULD NOT send requests using this command code, and servers receiving requests with this command code SHOULD return STATUS_NOT_IMPLEMENTED (ERRDOS/ERRbadfunc).<38>

2.2.4.30 SMB_COM_SET_INFORMATION2 (0x22)

This command was introduced in the **LAN Manager 1.0** dialect. This command is deprecated. New client implementations SHOULD use the [SMB_COM_TRANSACTION2 \(section 2.2.4.46\)](#) subcommand [TRANS2_SET_FILE_INFORMATION \(section 2.2.6.9\)](#).

This command MAY be sent by a client to set attribute information about an open file. The client MUST provide a valid **FID** in the [SMB Header \(section 2.2.3.1\)](#). The **FID** SHOULD have been acquired through a previously successful use of one of the SMB commands for opening a file. The client MUST have at least write permission on the file. The target file is updated from the values specified in the request. A date or time value of 0 indicates to the server that the values MUST NOT be changed. This command allows the client to set more attribute information for the file than the [SMB_COM_SET_INFORMATION \(section 2.2.4.10\)](#) command.

2.2.4.30.1 Request

```
SMB_Parameters
{
    UCHAR    WordCount;
    Words
    {
        USHORT    FID;
        SMB_DATE  CreateDate;
        SMB_TIME  CreationTime;
        SMB_DATE  LastAccessDate;
        SMB_TIME  LastAccessTime;
        SMB_DATE  LastWriteDate;
        SMB_TIME  LastWriteTime;
    }
}
SMB_Data
{
    USHORT    ByteCount;
}
```

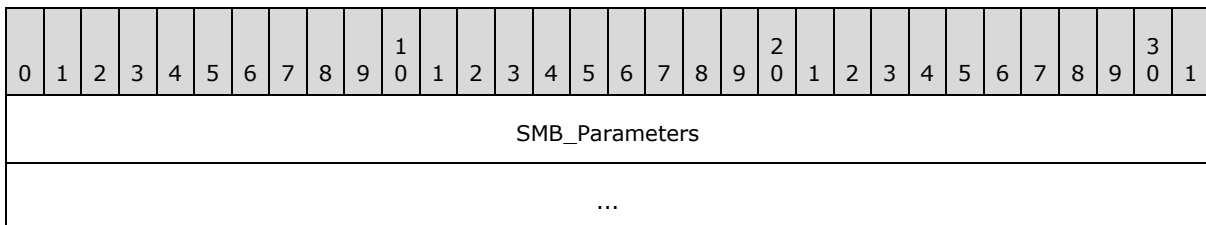

...	
...	SMB_Data
...	

SMB_Parameters (15 bytes):

0	1	2	3	4	5	6	7	8	9	10	11	12	13	14	15	16	17	18	19	20	21	22	23	24	25	26	27	28	29	30	31
WordCount										Words																					
...																															
...																															
...																															

WordCount (1 byte): This field MUST be 0x07.

Words (14 bytes):

0	1	2	3	4	5	6	7	8	9	10	11	12	13	14	15	16	17	18	19	20	21	22	23	24	25	26	27	28	29	30	31
FID										CreateDate																					
CreateTime										LastAccessDate																					
LastAccessTime										LastWriteDate																					
LastWriteTime																															

FID (2 bytes): This is the FID representing the file for which attributes are to be set.

CreateDate (2 bytes): This is the date when the file was created.

CreateTime (2 bytes): This is the time on **CreateDate** when the file was created.

LastAccessDate (2 bytes): This is the date when the file was last accessed.

LastAccessTime (2 bytes): This is the time on **LastAccessDate** when the file was last accessed.

LastWriteDate (2 bytes): This is the date when data was last written to the file.

LastWriteTime (2 bytes): This is the time on **LastWriteDate** when data was last written to the file.

SMB_Data (2 bytes):

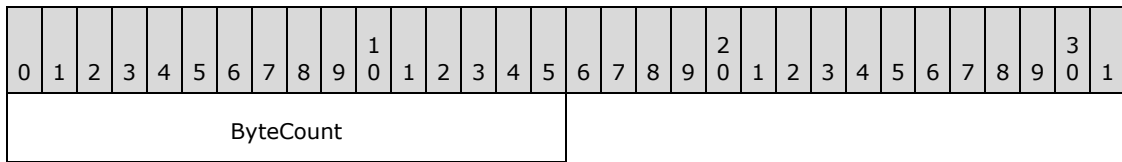

ByteCount (2 bytes): This field MUST be 0x0000. No data is sent by this message.

2.2.4.30.2 Response

```
SMB_Parameters
{
  UCHAR WordCount;
}
SMB_Data
{
  USHORT ByteCount;
}
```

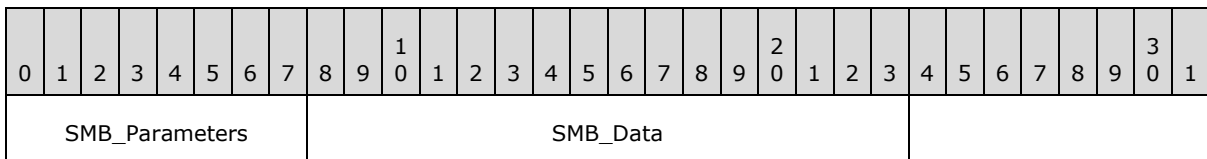

SMB_Parameters (1 byte):

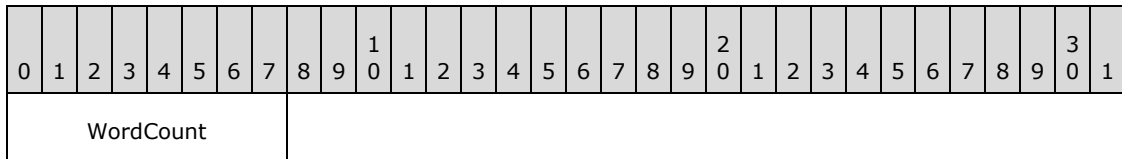

WordCount (1 byte): This field MUST be 0x00. No parameters are sent by this message.

SMB_Data (2 bytes):

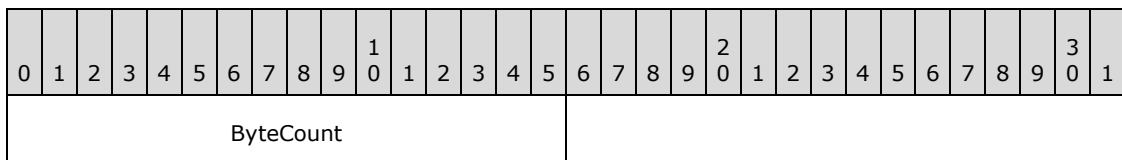

ByteCount (2 bytes): This field MUST be 0x0000. No data is sent by this message.

Error Codes

SMB error class	SMB error code	NT status code	POSIX equivalent	Description
ERRDOS (0x01)	ERRnoaccess (0x0005)	STATUS_ACCESS_DENIED (0xC0000022)	EACCESS	Access denied, no write access.
ERRDOS	ERRbadfid	STATUS_INVALID_HANDLE	ENFILE	The FID supplied is

SMB error class	SMB error code	NT status code	POSIX equivalent	Description
(0x01)	(0x0006)	(0xC0000008) STATUS_SMB_BAD_FID (0x00060001)		invalid.
ERRDOS (0x01)	ERRnomem (0x0008)	STATUS_INSUFF_SERVER_RESOURCES (0xC0000205)	ENOMEM	The server is out of resources.
ERRSRV (0x02)	ERRerror (0x0001)	STATUS_INVALID_SMB (0x00010002)		Invalid SMB. Not enough parameter bytes were sent.
ERRSRV (0x02)	ERRerror (0x0001)		EINTR	The operation was interrupted by the system.
ERRSRV (0x02)	ERRaccess (0x0004)	STATUS_NETWORK_ACCESS_DENIED (0xC00000CA)	EACCESS	Write access denied on a portion of the shared path.
ERRSRV (0x02)	ERRinvtid (0x0005)	STATUS_SMB_BAD_TID (0x00050002)		The TID is no longer valid.
ERRSRV (0x02)	ERRinvdevice (0x0007)	STATUS_BAD_DEVICE_TYPE (0xC00000CB)		The FID does not specify a disk resource; printer or other.
ERRSRV (0x02)	ERRbaduid (0x005B)	STATUS_SMB_BAD_UID (0x005B0002)		The UID supplied is not known to the session, or the user identified by the UID does not have sufficient privileges.
ERRHRD (0x03)	ERRnowrite (0x0013)	STATUS_MEDIA_WRITE_PROTECTED (0xC00000A2)	EROFS	The FID supplied is on write-protected media.
ERRHRD (0x03)	ERRdata (0x0017)	STATUS_DATA_ERROR (0xC000003E)	EIO	Disk I/O error.

2.2.4.31 SMB_COM_QUERY_INFORMATION2 (0x23)

This command was introduced in the **LAN Manager 1.0** dialect. This command is deprecated. New client implementations SHOULD use the SMB_COM_TRANSACTION2 subcommand TRANS2_QUERY_FILE_INFORMATION.

This command MAY be sent by a client to obtain attribute information about an open file. The client MUST provide a valid **FID** in the SMB Request. The FID SHOULD have been acquired through a previously successful use of one of the SMB commands for opening a file. This command provides more information about the file than the SMB_COM_QUERY_INFORMATION command. The server

response is limited to providing a 32-bit file size in bytes and is inappropriate for files exceeding that size.

2.2.4.31.1 Request

```
SMB_Parameters
{
  UCHAR WordCount;
  Words
  {
    USHORT FID;
  }
}
SMB_Data
{
  USHORT ByteCount;
}
```

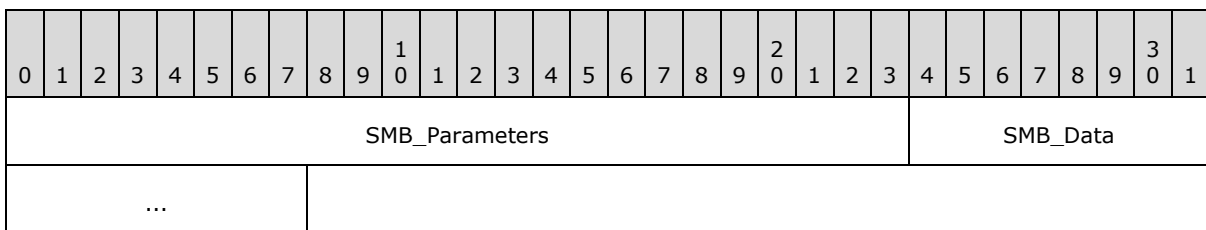

SMB_Parameters (3 bytes):

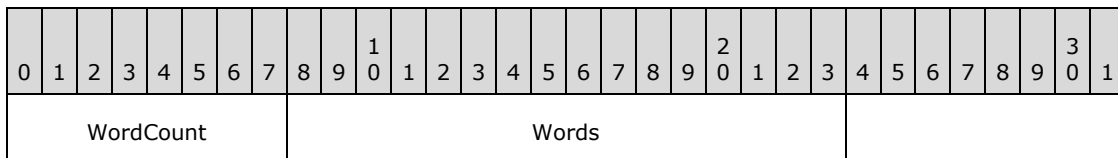

WordCount (1 byte): This field MUST be 0x01.

Words (2 bytes):

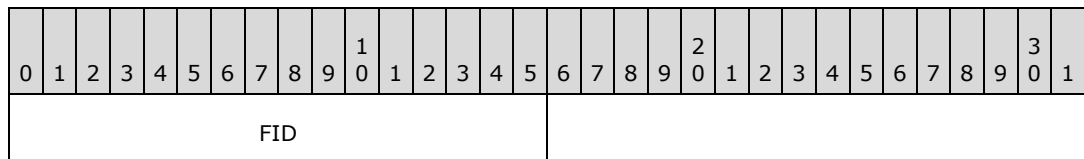

FID (2 bytes): This field MUST be a valid FID that the client has obtained through a previous SMB command that successfully opened the file.

SMB_Data (2 bytes):

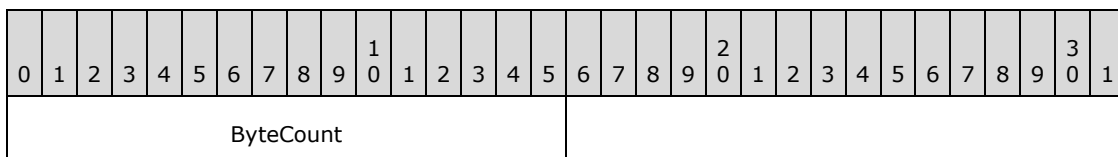

ByteCount (2 bytes): This field MUST be 0x0000. No data is sent by this message.

2.2.4.31.2 Response

```

SMB_Parameters
{
  UCHAR    WordCount;
  Words
  {
    SMB_DATE      CreateDate;
    SMB_TIME      CreationTime;
    SMB_DATE      LastAccessDate;
    SMB_TIME      LastAccessTime;
    SMB_DATE      LastWriteDate;
    SMB_TIME      LastWriteTime;
    ULONG         FileDataSize;
    ULONG         FileAllocationSize;
    SMB_FILE_ATTRIBUTES FileAttributes;
  }
}
SMB_Data
{
  USHORT ByteCount;
}

```

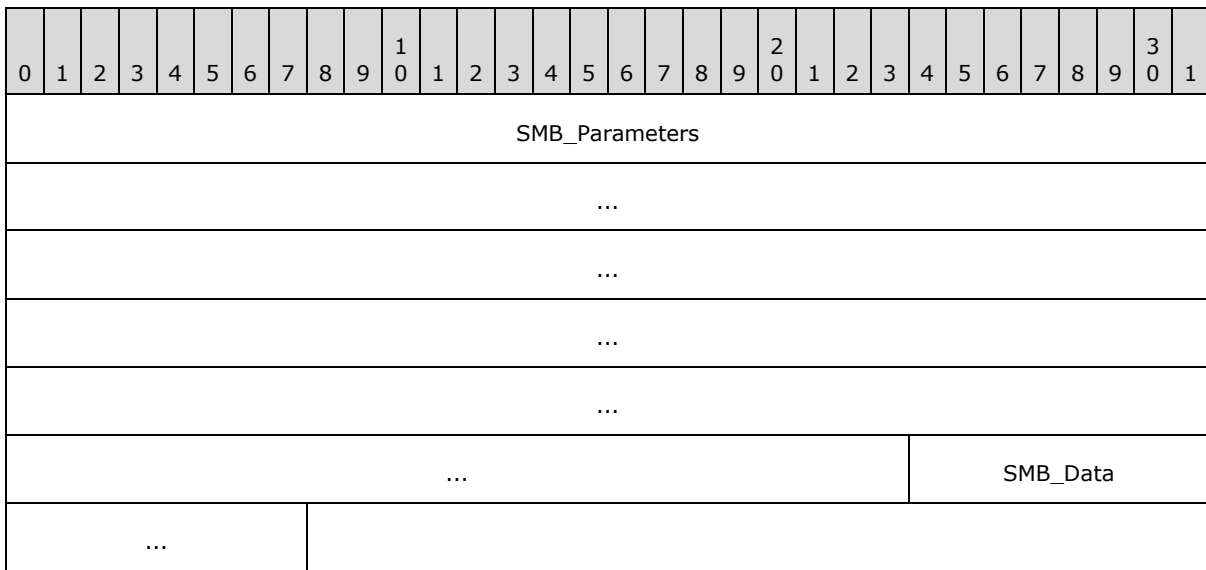

SMB_Parameters (23 bytes):

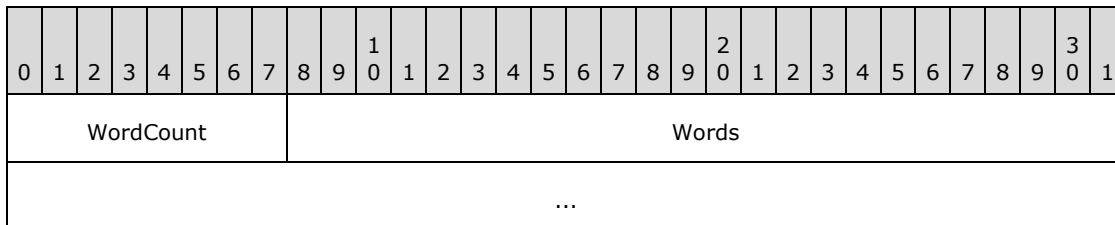

...
...
...
...

WordCount (1 byte): This field MUST be 0x0B.

Words (22 bytes):

0	1	2	3	4	5	6	7	8	9	0	1	2	3	4	5	6	7	8	9	0	1	2	3	4	5	6	7	8	9	0	1
CreateDate											CreateTime																				
LastAccessDate											LastAccessTime																				
LastWriteDate											LastWriteTime																				
FileDataSize																															
FileAllocationSize																															
FileAttributes																															

CreateDate (2 bytes): This field is the date when the file was created.

CreateTime (2 bytes): This field is the time on **CreateDate** when the file was created.

LastAccessDate (2 bytes): This field is the date when the file was last accessed.

LastAccessTime (2 bytes): This field is the time on **LastAccessDate** when the file was last accessed.

LastWriteDate (2 bytes): This field is the date when data was last written to the file.

LastWriteTime (2 bytes): This field is the time on **LastWriteDate** when data was last written to the file.

FileDataSize (4 bytes): This field contains the number of bytes in the file, in bytes. Because this size is limited to 32 bits, this command is inappropriate for files whose size is too large.

FileAllocationSize (4 bytes): This field contains the allocation size of the file, in bytes. Because this size is limited to 32 bits, this command is inappropriate for files whose size is too large.

FileAttributes (2 bytes): This field is a 16-bit unsigned bit field encoding the attributes of the file.

SMB_Data (2 bytes):

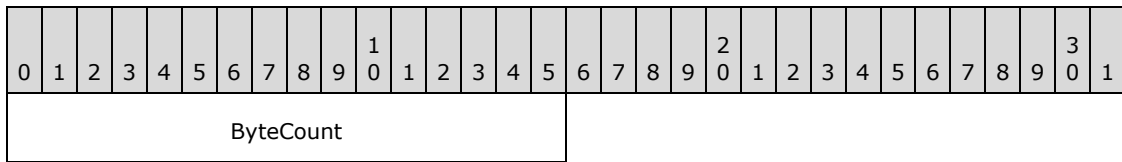

ByteCount (2 bytes): This field MUST be 0x0000. No data is sent by this message.

Error Codes

SMB error class	SMB error code	NT status code	POSIX equivalent	Description
ERRDOS (0x01)	ERRnoaccess (0x0005)	STATUS_ACCESS_DENIED (0xC0000022)	EPERM	Access denied, no read permission on FID.
ERRDOS (0x01)	ERRbadfid (0x0006)	STATUS_INVALID_HANDLE (0xC0000008) STATUS_SMB_BAD_FID (0x00060001)	ENFILE	The FID supplied is not valid.
ERRDOS (0x01)	ERRnomem (0x0008)	STATUS_INSUFF_SERVER_RESOURCES (0xC0000205)	ENOMEM	The server is out of resources.
ERRSRV (0x02)	ERRerror (0x0001)	STATUS_INVALID_SMB (0x00010002)		Invalid SMB. Not enough parameter bytes were sent.
ERRSRV (0x02)	ERRaccess (0x0004)	STATUS_NETWORK_ACCESS_DENIED (0xC00000CA)	EACCESS	A component in the path denied the required permission.
ERRSRV (0x02)	ERRinvtid (0x0005)	STATUS_SMB_BAD_TID (0x00050002)		The TID is no longer valid.
ERRSRV (0x02)	ERRbaduid (0x005B)	STATUS_SMB_BAD_UID (0x005B0002)		The UID supplied is not defined to the session, or the user identified by the UID does not have sufficient privileges.
ERRHRD (0x03)	ERRdata (0x0017)	STATUS_DATA_ERROR (0xC000003E)	EIO	Disk I/O error.

2.2.4.32 SMB_COM_LOCKING_ANDX (0x24)

This command was introduced in the **LAN Manager 1.0** dialect. The **LAN Manager 1.0** version of this command is not compatible with files that have greater than 32-bit offsets. The support for files that have 64-bit offsets was introduced into this command in the NT LAN Manager dialect.

This command is used to explicitly lock and/or unlock a contiguous range of bytes in a regular file. More than one non-overlapping byte range can be locked and/or unlocked on an open file. Locks prevent attempts to lock, read, or write the locked portion of the file by other processes using a separate file handle (FID). Any process using the same FID specified in the request that obtained the lock has access to the locked bytes.

SMB_COM_LOCKING_ANDX (section 2.2.4.32) is also used by the server to send OpLock break notification messages to the client, and by the client to acknowledge the OpLock break. This is the one instance in the CIFS Protocol in which the server sends a request.

The following are the commands that can follow an SMB_COM_LOCKING_ANDX (section 2.2.4.32) in an AndX chain:

- [SMB_COM_CLOSE \(section 2.2.4.5\)](#)
- [SMB_COM_FLUSH \(section 2.2.4.6\)](#)
- SMB_COM_LOCKING_ANDX
- [SMB_COM_READ \(section 2.2.4.11\)](#)
- [SMB_COM_READ_ANDX \(section 2.2.4.42\)](#)
- [SMB_COM_WRITE \(section 2.2.4.12\)](#)
- [SMB_COM_WRITE_ANDX \(section 2.2.4.43\)](#)

2.2.4.32.1 Request

```
SMB_Parameters
{
    UCHAR    WordCount;
    Words
    {
        UCHAR    AndXCommand;
        UCHAR    AndXReserved;
        USHORT   AndXOffset;
        USHORT   FID;
        UCHAR    TypeOfLock;
        UCHAR    NewOpLockLevel;
        ULONG    Timeout;
        USHORT   NumberOfRequestedUnlocks;
        USHORT   NumberOfRequestedLocks;
    }
}

SMB_Data
{
    USHORT   ByteCount;
    Bytes
    {
        LOCKING_ANDX_RANGE Unlocks[NumberOfRequestedUnlocks];
        LOCKING_ANDX_RANGE Locks[NumberOfRequestedLocks];
    }
}
```

SMB_Header: Flags (1 byte): If the server sends an OpLock Break Notification to a client holding an OpLock, the SMB_FLAGS_REPLY bit (0x80) MUST be clear (0) to indicate that the message is a request. This is the only instance in the protocol in which the server sends a request message.

0	1	2	3	4	5	6	7	8	9	10	11	12	13	14	15	16	17	18	19	20	21	22	23	24	25	26	27	28	29	30	31
SMB_Parameters																															
...																															
...																															
...																															
...																SMB_Data (variable)															
...																															

SMB_Parameters (17 bytes):

0	1	2	3	4	5	6	7	8	9	10	11	12	13	14	15	16	17	18	19	20	21	22	23	24	25	26	27	28	29	30	31
WordCount										Words																					
...																															
...																															
...																															
...																															

WordCount (1 byte): This field MUST be 0x08.

Words (16 bytes):

0	1	2	3	4	5	6	7	8	9	10	11	12	13	14	15	16	17	18	19	20	21	22	23	24	25	26	27	28	29	30	31
AndXCommand										AndXReserved						AndXOffset															
FID																TypeOfLock						NewOpLockLevel									
Timeout																															

NumberOfRequestedUnlocks	NumberOfRequestedLocks
--------------------------	------------------------

AndXCommand (1 byte): The command code for the next SMB command in the packet. This value MUST be set to 0xFF if there are no additional SMB commands in the client request packet.

AndXReserved (1 byte): A reserved field. This MUST be set to 0x00 when this request is sent, and the server MUST ignore this value when the message is received.

AndXOffset (2 bytes): This field MUST be set to the offset, in bytes, from the start of the [SMB Header \(section 2.2.3.1\)](#) to the start of the **WordCount** field in the next SMB command in this packet. This field is valid only if the **AndXCommand** field is not set to 0xFF. If **AndXCommand** is 0xFF, this field MUST be ignored by the server.

FID (2 bytes): This field MUST be a valid 16-bit unsigned integer indicating the file from which the data SHOULD be read.

TypeOfLock (1 byte): This field is an 8-bit unsigned integer bit mask indicating the nature of the lock request and the format of the **LOCKING_ANDX_RANGE** data. If the negotiated protocol is NT LAN Manager or later, CAP_LARGE_FILES was negotiated and LARGE_FILES bit is set, then the **Locks** and **Unlocks** arrays are in the large file 64-bit offset **LOCKING_ANDX_RANGE** format. This allows specification of 64-bit offsets for very large files.

If **TypeOfLock** has the SHARED_LOCK bit set, the lock is specified as a shared read-only lock. If shared read-only locks cannot be supported by a server, the server SHOULD map the lock to an exclusive lock for both read and write. Locks for both read and write messages in which **TypeOfLock** bit READ_WRITE_LOCK is set SHOULD be prohibited by the server, and the server SHOULD return an implementation-specific error to the client. If **TypeOfLock** has the CHANGE_LOCKTYPE bit set, the client is requesting that the server atomically change the lock type from a shared lock to an exclusive lock, or vice versa. If the server cannot do this in an atomic fashion, the server MUST reject this request and return an implementation-specific error to the client. Closing a file with locks still in force causes the locks to be released in a nondeterministic order.

If the **Locks** vector contains one and only one entry (**NumberOfRequestedLocks** == 1) and **TypeOfLock** has the **CANCEL_LOCK** bit set, the client is requesting that the server cancel a previously requested but unacknowledged lock. This allows the client to cancel lock requests that can wait forever to complete (see **Timeout** below).

Lock type and bitmask	Meaning
READ_WRITE_LOCK 0x00	Request for an exclusive read and write lock.
SHARED_LOCK 0x01	Request for a shared read-only lock.
OPLOCK_RELEASE 0x02	When sent from the server to the client in an OpLock Break Notification, this bit indicates to the client that an OpLock change has occurred on the FID supplied in the request. The client MUST set this bit when sending the OpLock Break Request message acknowledging the OpLock Break.
CHANGE_LOCKTYPE 0x04	Request to atomically change the lock type from a shared lock to an exclusive lock or vice versa for the specified Locks .<39>

Lock type and bitmask	Meaning
CANCEL_LOCK 0x08	Request to cancel all outstanding lock requests for the specified FID and PID . <40>
LARGE_FILES 0x10	Indicates that the LOCKING_ANDX_RANGE format is the 64-bit file offset version. If this flag is not set, then the LOCKING_ANDX_RANGE format is the 32-bit file offset version.

NewOpLockLevel (1 byte): This field is valid only in [SMB_COM_LOCKING_ANDX \(0x24\)](#) (section 2.2.4.32) SMB requests sent from the server to the client in response to a change in an existing OpLock's state. This field is an 8-bit unsigned integer indicating the OpLock level now in effect for the **FID** in the request. If **NewOpLockLevel** is 0x00, the client possesses no OpLocks on the file at all. If **NewOpLockLevel** is 0x01, then the client possesses a Level II OpLock.

Timeout (4 bytes): This field is a 32-bit unsigned integer value. **Timeout** is the maximum amount of time to wait, in milliseconds, for the byte range(s) specified in **Locks** to become locked. A **Timeout** value of 0x00000000 indicates that the server fails immediately if any lock range specified is already locked and cannot be locked by this request. A **Timeout** value of -1 (0xFFFFFFFF) indicates that the server waits as long as it takes (wait forever) for each byte range specified to become unlocked so that it can be locked by this request. Any other value of **Timeout** specifies the maximum number of milliseconds to wait for all lock ranges specified in **Locks** to become available and to be locked by this request.

NumberOfRequestedUnlocks (2 bytes): This field is a 16-bit unsigned integer value containing the number of entries in the **Unlocks** array.

NumberOfRequestedLocks (2 bytes): This field is a 16-bit unsigned integer value containing the number of entries in the **Locks** array.

SMB_Data (variable):

0	1	2	3	4	5	6	7	8	9	10	11	12	13	14	15	16	17	18	19	20	21	22	23	24	25	26	27	28	29	30	31
ByteCount																Bytes (variable)															
...																															

ByteCount (2 bytes): This field MUST be greater than or equal to 0x0000.

Bytes (variable):

0	1	2	3	4	5	6	7	8	9	10	11	12	13	14	15	16	17	18	19	20	21	22	23	24	25	26	27	28	29	30	31
Unlocks (variable)																															
...																															

Locks (variable)
...

Unlocks (variable): An array of byte ranges to be unlocked. If 32-bit offsets are being used, this field uses **LOCKING_ANDX_RANGE32** (see below) and is (10 * **NumberOfRequestedUnlocks**) bytes in length. If 64-bit offsets are being used, this field uses **LOCKING_ANDX_RANGE64** (see below) and is (20 * **NumberOfRequestedUnlocks**) bytes in length.

Locks (variable): An array of byte ranges to be locked. If 32-bit offsets are being used, this field uses **LOCKING_ANDX_RANGE32** (see following) and is (10 * **NumberOfRequestedLocks**) bytes in length. If 64-bit offsets are being used, this field uses **LOCKING_ANDX_RANGE64** (see following) and is (20 * **NumberOfRequestedLocks**) bytes in length.

The **LOCKING_ANDX_RANGE32** data type has the following structure.

```
LOCKING_ANDX_RANGE32
{
    USHORT  PID;
    ULONG   ByteOffset;
    ULONG   LengthInBytes;
}
```

PID (2 bytes): The PID of the process requesting the locking change.

ByteOffset (4 bytes): The 32-bit unsigned integer value that is the offset into the file at which the locking change MUST begin.

LengthInBytes (4 bytes): The 32-bit unsigned integer value that is the number of bytes, beginning at **OffsetInBytes**, that MUST be locked or unlocked.

The **LOCKING_ANDX_RANGE64** data type has the following structure.

```
LOCKING_ANDX_RANGE64
{
    USHORT  PID;
    USHORT  Pad;
    ULONG   ByteOffsetHigh;
    ULONG   ByteOffsetLow;
    ULONG   LengthInBytesHigh;
    ULONG   LengthInBytesLow;
}
```

PID (2 bytes): The PID of the process requesting the locking change.

Pad (2 bytes): This field pads the structure to **DWORD** alignment and MUST be zero (0x0000).

OffsetInBytesHigh (4 bytes): The 32-bit unsigned integer value that is the high 32 bits of a 64-bit offset into the file at which the locking change MUST begin.

OffsetInBytesLow (4 bytes): The 32-bit unsigned integer value that is the low 32 bits of a 64-bit offset into the file at which the locking change MUST begin.

LengthInBytesHigh (4 bytes): The 32-bit unsigned integer value that is the high 32 bits of a 64-bit value specifying the number of bytes that MUST be locked or unlocked.

LengthInBytesLow (4 bytes): The 32-bit unsigned integer value that is the low 32 bits of a 64-bit value specifying the number of bytes that MUST be locked or unlocked.

2.2.4.32.2 Response

```
SMB_Parameters
{
  UCHAR WordCount;
  UCHAR AndXCommand;
  UCHAR AndXReserved;
  UCHAR AndXOffset;
}
SMB_Data
{
  USHORT ByteCount;
}
```

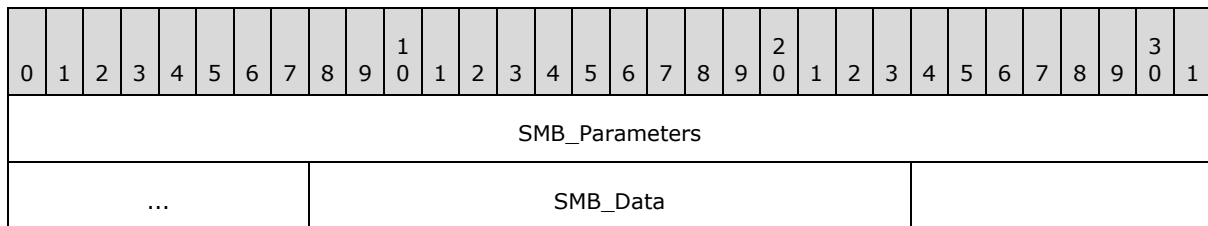

SMB_Parameters (5 bytes):

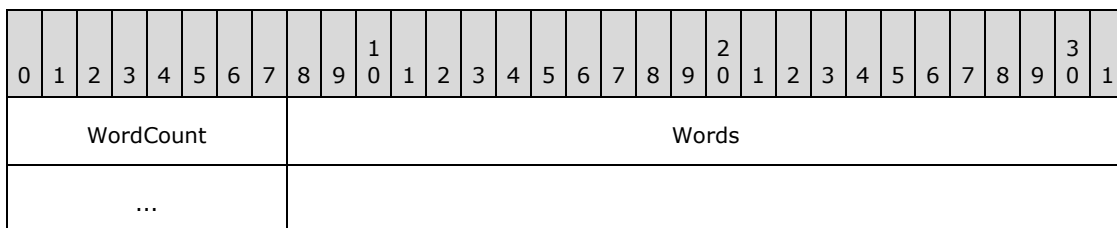

WordCount (1 byte): This field MUST be 0x02.

Words (4 bytes):

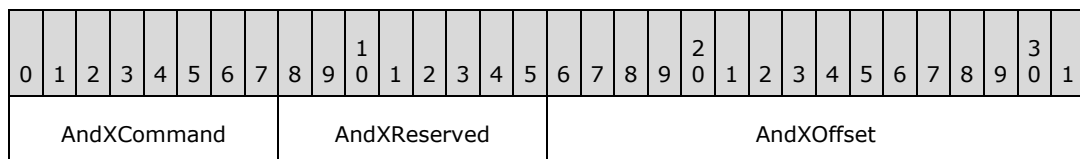

AndXCommand (1 byte): The command code for the next SMB command in the packet. This value MUST be set to 0xFF if there are no additional SMB command responses in the server response packet.

AndXReserved (1 byte): A reserved field. This MUST be set to 0x00 when this response is sent, and the client MUST ignore this field.

AndXOffset (2 bytes): This field MUST be set to the offset, in bytes, from the start of the [SMB Header \(section 2.2.3.1\)](#) to the start of the WordCount field in the next SMB command response in this packet. This field is valid only if the AndXCommand field is not set to 0xFF. If AndXCommand is 0xFF, this field MUST be ignored by the client.

SMB_Data (2 bytes):

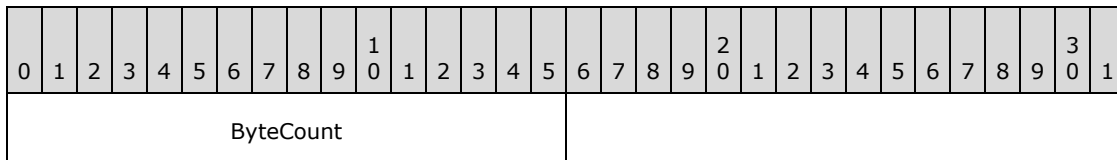

ByteCount (2 bytes): This field MUST be 0x0000. No data is sent by this message.

Error Codes

SMB error class	SMB error code	NT status code	POSIX equivalent	Description
ERRDOS (0x01)	ERRnoaccess (0x0005)	STATUS_ACCESS_DENIED (0xC0000022)	EACCESS	File access rights do not match requested locks.
ERRDOS (0x01)	ERRbadfid (0x0006)	STATUS_INVALID_HANDLE (0xC0000008) STATUS_SMB_BAD_FID (0x00060001)	ENFILE	Attempt to read from a FID that the server does not have open.
ERRDOS (0x01)	ERRnomem (0x0008)	STATUS_INSUFF_SERVER_RESOURCE (0xC0000205)	ENOMEM	Insufficient server resources to place the lock.
ERRDOS (0x01)	ERRlock (0x0021)	STATUS_FILE_LOCK_CONFLICT (0xC0000054)	EACCESS	The intended byte range has already been locked.
ERRDOS (0x01)	ERRlock (0x0021)		ENOLOCK	Insufficient server resources to place the lock.
ERRDOS (0x01)	ERROR_NOT_LOCKED (0x009E)	STATUS_RANGE_NOT_LOCKED (0xC000007E)		The byte range specified in an unlock request

SMB error class	SMB error code	NT status code	POSIX equivalent	Description
				was not locked.
ERRDOS (0x01)	ERROR_CANCEL_VIOLATION 0x00AD	STATUS_OS2_CANCEL_VIOLATION 0x00AD0001		No lock request was outstanding for the supplied cancel region.
ERRSRV (0x02)	ERRerror (0x0001)		EBADF	A valid FID was rejected by the underlying system.
ERRSRV (0x02)	ERRerror (0x0001)		EDEADLK	The lock request would block and cause a deadlock with another process.
ERRSRV (0x02)	ERRerror (0x0001)	STATUS_INVALID_SMB (0x00010002)		Invalid SMB. Not enough parameter bytes were sent or the ANDX command is invalid.
ERRSRV (0x02)	ERRinvdevice (0x0007)	STATUS_BAD_DEVICE_TYPE (0xC00000CB)		Attempt to lock a non-regular file such as a named pipe.
ERRSRV (0x02)	ERRinvtid (0x0005)	STATUS_SMB_BAD_TID (0x00050002)		Invalid TID in request.
ERRSRV (0x02)	ERRbaduid (0x005B)	STATUS_SMB_BAD_UID (0x005B0002)		The UID specified is not defined as a valid ID for this session, or the user identified

SMB error class	SMB error code	NT status code	POSIX equivalent	Description
				by the UID does not have sufficient privileges.
ERRHRD (0x03)	ERRdata (0x0017)	STATUS_DATA_ERROR (0xC000003E)	EIO	Disk I/O error.

2.2.4.33 SMB_COM_TRANSACTION (0x25)

This command was introduced in the **LAN Manager 1.0** dialect.

This command serves as the transport for the Transaction Subprotocol Commands. These commands operate on mailslots and named pipes, which are interprocess communication endpoints within the CIFS file system. If the size in bytes of the request exceeds the **MaxBufferSize** established during session setup, then the transaction **MUST** use the [SMB_COM_TRANSACTION_SECONDARY \(section 2.2.4.34\)](#) SMB to send the additional command data.

Transaction Subprotocol Command messages can exceed the maximum size of a single SMB message as determined by the value of the **MaxBufferSize** session parameter. If this is the case, then the client **MUST** use one or more [SMB_COM_TRANSACTION_SECONDARY Requests \(section 2.2.4.34.1\)](#) to transfer the transaction **SMB_Data.Trans_Data** and **SMB_Data.Trans_Parameter** bytes that did not fit in the initial message.

The client indicates that it has not sent all of the **SMB_Data.Trans_Data** bytes by setting **DataCount** to a value less than **TotalDataCount**. Similarly, if **ParameterCount** is less than **TotalParameterCount**, the client has more **SMB_Data.Trans_Parameters** bytes to send. Parameter bytes **SHOULD** take precedence over Data bytes, and clients **SHOULD** attempt to send as many bytes as possible in each message. Servers **SHOULD** be prepared, however, to accept **SMB_Data.Trans_Parameters** and **SMB_Data.Trans_Data** bytes in any order, in large or small amounts.

For both the request and the response, the position and length of the **SMB_Data.Trans_Parameters** and **SMB_Data.Trans_Data** fields is determined by the values of the **SMB_Parameters.ParameterOffset**, **SMB_Parameters.ParameterCount**, **SMB_Parameters.DataOffset**, and **SMB_Parameters.DataCount** fields. In addition, the **SMB_Parameters.ParameterDisplacement** and **SMB_Parameters.DataDisplacement** fields can be used to change the order in which subranges of bytes are transferred. Servers **SHOULD** transfer bytes in order and give precedence to **SMB_Data.Trans_Parameters** bytes. Clients **SHOULD** be prepared to reconstruct transaction **SMB_Data.Trans_Parameters** and **SMB_Data.Trans_Data**, regardless of the order or locations in which they are delivered.

2.2.4.33.1 Request

```
SMB_Parameters
{
    UCHAR    WordCount;
    Words
    {
```

```

USHORT TotalParameterCount;
USHORT TotalDataCount;
USHORT MaxParameterCount;
USHORT MaxDataCount;
UCHAR MaxSetupCount;
UCHAR Reserved1;
USHORT Flags;
ULONG Timeout;
USHORT Reserved2;
USHORT ParameterCount;
USHORT ParameterOffset;
USHORT DataCount;
USHORT DataOffset;
UCHAR SetupCount;
UCHAR Reserved3;
USHORT Setup[SetupCount];
}
}
SMB_Data
{
USHORT ByteCount;
Bytes
{
SMB_STRING Name;
UCHAR Pad1[];
UCHAR Trans_Parameters[ParameterCount];
UCHAR Pad2[];
UCHAR Trans_Data[DataCount];
}
}
}

```

SMB_Header:

The **PID**, **MID**, **TID**, and **UID** MUST be the same for all requests and responses that are part of the same transaction.

TID (2 bytes): If the transaction request is being sent as a class 2 mailslot message, this field MUST have a value of 0xFFFF. The mailslot receiver MAY ignore the TID in the request. In all other cases, this field MUST contain a valid TID. The TID MUST refer to the IPC\$ share.

UID (2 bytes): If the transaction request is being sent as a class 2 mailslot message, this field MUST have a value of 0xFFFF. The mailslot receiver MAY ignore the UID in the request. In all other cases, this field MUST contain a valid UID.

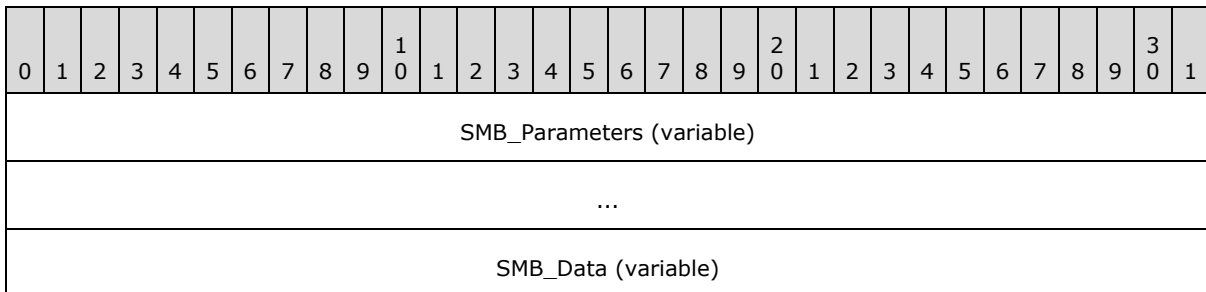

...

SMB_Parameters (variable):

The SMB_Parameters section of the [SMB_COM_TRANSACTION](#) request contains the information to manage the transaction along with flags and setup information that provide the context for the execution of the operation on the server.

0	1	2	3	4	5	6	7	8	9	10	11	12	13	14	15	16	17	18	19	20	21	22	23	24	25	26	27	28	29	30	31		
WordCount										Words (variable)																							
...																																	

WordCount (1 byte): This field MUST be **Words.SetupCount** (see below) plus 14 (0x0E). This value represents the total number of parameter words and MUST be greater than or equal to 14 (0x0E).

Words (variable):

0	1	2	3	4	5	6	7	8	9	10	11	12	13	14	15	16	17	18	19	20	21	22	23	24	25	26	27	28	29	30	31		
TotalParameterCount										TotalDataCount																							
MaxParameterCount										MaxDataCount																							
MaxSetupCount					Reserved1					Flags																							
Timeout																																	
Reserved2										ParameterCount																							
ParameterOffset										DataCount																							
DataOffset										SetupCount					Reserved3																		
Setup (variable)																																	
...																																	

TotalParameterCount (2 bytes): The total number of transaction parameter bytes the client expects to send to the server for this request. Parameter bytes for a transaction are carried within the **SMB_Data.Trans_Parameters** field of the SMB_COM_TRANSACTION request. If the size of all of the required **SMB_Data.Trans_Parameters** for a given transaction causes the request to exceed the **MaxBufferSize** established during session setup, then the client MUST NOT send all of the parameters in one request. The client MUST break up the parameters and send additional requests using the SMB_COM_TRANSACTION_SECONDARY command to send the additional

parameters. Any single request MUST NOT exceed the **MaxBufferSize** established during session setup. The client indicates to the server to expect additional parameters, and thus at least one SMB_COM_TRANSACTION_SECONDARY, by setting **ParameterCount** (see following) to be less than **TotalParameterCount**. See SMB_COM_TRANSACTION_SECONDARY for more information.

TotalDataCount (2 bytes): The total number of transaction data bytes that the client attempts to send to the server for this request. Data bytes of a transaction are carried within the **SMB_Data.Trans_Data** field of the SMB_COM_TRANSACTION request. If the size of all of the required **SMB_Data.Trans_Data** for a given transaction causes the request to exceed the **MaxBufferSize** established during session setup, then the client MUST NOT send all of the data in one request. The client MUST break up the data and send additional requests using the SMB_COM_TRANSACTION_SECONDARY command to send the additional data. Any single request MUST NOT exceed the **MaxBufferSize** established during session setup. The client indicates to the server to expect additional data, and thus at least one SMB_COM_TRANSACTION_SECONDARY, by setting **DataCount** (see following) to be less than **TotalDataCount**. See SMB_COM_TRANSACTION_SECONDARY for more information.

MaxParameterCount (2 bytes): The maximum number of **SMB_Data.Trans_Parameters** bytes that the client accepts in the transaction response. The server MUST NOT return more than this number of bytes in the **SMB_Data.Trans_Parameters** field of the response.

MaxDataCount (2 bytes): The maximum number of **SMB_Data.Trans_Data** bytes that the client accepts in the transaction response. The server MUST NOT return more than this number of bytes in the **SMB_Data.Trans_Data** field.

MaxSetupCount (1 byte): The maximum number of bytes that the client accepts in the **Setup** field of the transaction response. The server MUST NOT return more than this number of bytes in the **Setup** field.

Reserved1 (1 byte): A padding byte. This field MUST be 0x00. Existing CIFS implementations MAY combine this field with **MaxSetupCount** to form a USHORT. If **MaxSetupCount** is defined as a USHORT, the high order byte MUST be 0x00.

Flags (2 bytes): A set of bit flags that alter the behavior of the requested operation. Unused bit fields MUST be set to zero by the client sending the request, and MUST be ignored by the server receiving the request. The client can set either or both of the following bit flags.

Name and bitmask	Meaning
DISCONNECT_TID 0x0001	If set, following the completion of the operation the server MUST disconnect the tree connect associated with the tree identifier (TID) field received in the SMB Header (section 2.2.3.1) of this request. The client SHOULD NOT send a subsequent SMB_COM_TREE_DISCONNECT for this tree connect.
NO_RESPONSE 0x0002	This is a one-way transaction. The server MUST attempt to complete the transaction, but MUST NOT send a response to the client. <41>

Timeout (4 bytes): The value of this field MUST be the maximum number of milliseconds that the server SHOULD wait for completion of the transaction before generating a time-out and returning a response to the client. The client SHOULD set this field to 0x00000000 to indicate that no time-out is expected. A value of 0x00000000 indicates that the server returns an error if the resource is not immediately available. If the operation does not complete within the specified time, the server MAY abort the request and send a failure response. [<42>](#)

Reserved2 (2 bytes): Reserved. This field MUST be 0x0000 in the client request. The server MUST ignore the contents of this field.

ParameterCount (2 bytes): The number of transaction parameter bytes that the client attempts to send to the server in this request. Parameter bytes for a transaction are carried within the **SMB_Data.Trans_Parameters** field of the SMB_COM_TRANSACTION request. If the transaction request fits within a single SMB_COM_TRANSACTION request (the request size does not exceed **MaxBufferSize**), then this value SHOULD be equal to **TotalParameterCount**. Otherwise, the sum of the **ParameterCount** values in the primary and secondary transaction request messages MUST be equal to the smallest **TotalParameterCount** value reported to the server. If the value of this field is less than the value of **TotalParameterCount**, then at least one SMB_COM_TRANSACTION_SECONDARY message MUST be used to transfer the remaining transaction **SMB_Data.Trans_Parameters** bytes. The **ParameterCount** field MUST be used to determine the number of transaction **SMB_Data.Trans_Parameters** bytes that are contained within the SMB_COM_TRANSACTION message.

ParameterOffset (2 bytes): This field MUST contain the number of bytes from the start of the SMB Header to the start of the **SMB_Data.Trans_Parameters** field. Server implementations MUST use this value to locate the transaction parameter block within the request. If **ParameterCount** is zero, the client/server MAY set this field to zero. <43>

DataCount (2 bytes): The number of transaction data bytes that the client sends to the server in this request. Data bytes for a transaction are carried within the **SMB_Data.Trans_Data** field of the SMB_COM_TRANSACTION request. If the transaction request fits within a single SMB_COM_TRANSACTION request (the request size does not exceed **MaxBufferSize**), then this value SHOULD be equal to **TotalDataCount**. Otherwise, the sum of the **DataCount** values in the primary and secondary transaction request messages MUST be equal to the smallest **TotalDataCount** value reported to the server. If the value of this field is less than the value of **TotalDataCount**, then at least one SMB_COM_TRANSACTION_SECONDARY message MUST be used to transfer the remaining transaction **SMB_Data.Trans_Data** bytes. The **DataCount** field MUST be used to determine the number of transaction **SMB_Data.Trans_Data** bytes contained within the SMB_COM_TRANSACTION message.

DataOffset (2 bytes): This field MUST be the number of bytes from the start of the SMB Header of the request to the start of the **SMB_Data.Trans_Data** field. Server implementations MUST use this value to locate the transaction data block within the request. If **DataCount** is zero, the client/server MAY <44> set this field to zero.

SetupCount (1 byte): This field MUST be the number of setup words that are included in the transaction request.

Reserved3 (1 byte): A padding byte. This field MUST be 0x00. Existing CIFS implementations MAY combine this field with **SetupCount** to form a USHORT. If **SetupCount** is defined as a USHORT, the high order byte MUST be 0x00.

Setup (variable): An array of two-byte words that provides transaction context to the server. The size and content of the array are specific to individual subcommands.

SMB_Data (variable):

The SMB_Data section of the SMB_COM_TRANSACTION request contains the parameters and data that are the input to the transaction operation on the server. SMB_COM_TRANSACTION also includes a Name string that MAY identify the resource (a specific Mailslot or Named Pipe) against which the operation is performed.

0	1	2	3	4	5	6	7	8	9	0	1	2	3	4	5	6	7	8	9	0	1	2	3	4	5	6	7	8	9	0	1		
ByteCount																Bytes (variable)																	
...																																	

ByteCount (2 bytes): The number of bytes in the **Bytes** array that follows.

Bytes (variable):

0	1	2	3	4	5	6	7	8	9	0	1	2	3	4	5	6	7	8	9	0	1	2	3	4	5	6	7	8	9	0	1		
Name (variable)																																	
...																																	
Pad1 (variable)																																	
...																																	
Trans_Parameters (variable)																																	
...																																	
Pad2 (variable)																																	
...																																	
Data (variable)																																	
...																																	

Name (variable): The pathname of the mailslot or named pipe to which the transaction subcommand applies, or a client-supplied identifier that provides a name for the transaction. See the individual SMB_COM_TRANSACTION subprotocol subcommand descriptions for information about the value set for each subcommand. If the field is not specified in the section for the subcommands, the field SHOULD be set to \pipe\. If SMB_FLAGS2_UNICODE is set in the **Flags2** field of the SMB Header (section [2.2.3.1](#)) of the request, this field MUST be a null-terminated array of 16-bit Unicode characters which MUST be aligned to start on a 2-byte boundary from the start of the SMB header. Otherwise, this field MUST be a null-terminated array of OEM characters. The **Name** field MUST be the first field in this section.

Pad1 (variable): This field SHOULD be used as an array of padding bytes to align the following field to a 4-byte boundary. relative to the start of the SMB Header. This constraint can cause this field to be a zero-length field. This field SHOULD be set to zero by the client/server, and MUST be ignored by the server/client.

Trans_Parameters (variable): Transaction parameter bytes. See the individual SMB_COM_TRANSACTION subprotocol subcommands descriptions for information on the parameters sent for each subcommand.

Pad2 (variable): This field SHOULD be used as an array of padding bytes to align the following field to a 4-byte boundary. relative to the start of the SMB Header. This can cause this field to be a zero-length field. This field SHOULD be set to zero by the client/server, and MUST be ignored by the server/client.

Data (variable): Transaction data bytes. See the individual SMB_COM_TRANSACTION subprotocol subcommands descriptions for information on the data sent for each subcommand.

2.2.4.33.2 Response

The SMB_COM_TRANSACTION response has two possible formats. The standard format is used to return the results of the completed transaction. A shortened interim response message is sent following the initial SMB_COM_TRANSACTION request if the server determines that at least one SMB_COM_TRANSACTION_SECONDARY request message is expected from the client.

Whenever a transaction request is split across multiple SMB requests, the server MUST evaluate the initial SMB_COM_TRANSACTION request to determine whether or not it has the resources necessary to process the transaction. It MUST also check for any other errors that it can detect and then send back an interim response. If the interim response returns SUCCESS, then the client MUST send the next request of the transaction to the server. If the interim response reports an error, the client MUST NOT send the next request of the transaction to the server and SHOULD take appropriate action based on the error information included in the interim response.

The format of the SMB_COM_TRANSACTION Interim Server Response message is an [SMB Header \(section 2.2.3.1\)](#) with an empty **SMB_Parameters** and **SMB_Data** section.

SMB_Parameters.WordCount and **SMB_Data.ByteCount** MUST be 0x00 and 0x0000, respectively. Error codes are returned in the **SMB_Header.Status** field.

```
SMB_Parameters
{
    UCHAR WordCount;
}
SMB_Data
{
    USHORT ByteCount;
}
```

If no error is returned in the SMB_COM_TRANSACTION Interim Server Response, the transaction can proceed. The client sends as many SMB_COM_TRANSACTION_SECONDARY requests as required in order to transfer the remainder of the transaction subcommand **SMB_Data.Trans_Parameters** and **SMB_Data.Trans_Data**. The server processes the transaction and replies with one or more SMB_COM_TRANSACTION response messages.

```
SMB_Parameters
{
    UCHAR WordCount;
    Words
    {
        USHORT TotalParameterCount;
        USHORT TotalDataCount;
    }
}
```

```

USHORT Reserved1;
USHORT ParameterCount;
USHORT ParameterOffset;
USHORT ParameterDisplacement;
USHORT DataCount;
USHORT DataOffset;
USHORT DataDisplacement;
UCHAR SetupCount;
UCHAR Reserved2;
USHORT Setup[SetupCount];
}
}
SMB_Data
{
USHORT ByteCount;
Bytes
{
UCHAR Pad1[];
UCHAR Trans_Parameters[ParameterCount];
UCHAR Pad2[];
UCHAR Trans_Data[DataCount];
}
}
}

```

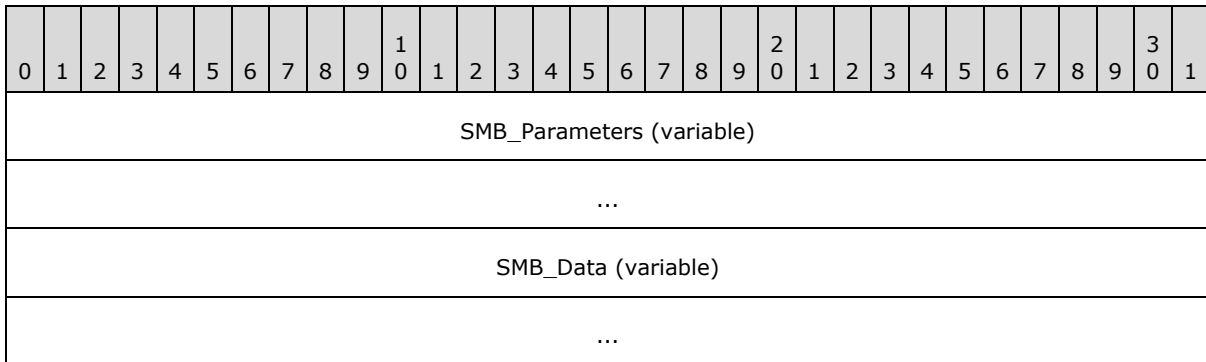

SMB_Parameters (variable):

The SMB_Parameters section of the SMB_COM_TRANSACTION response contains information used to manage the transfer of the transaction response. It can also contain additional information that can include subcommand return codes or state information returned by the server. See the individual subprotocol subcommands for details.

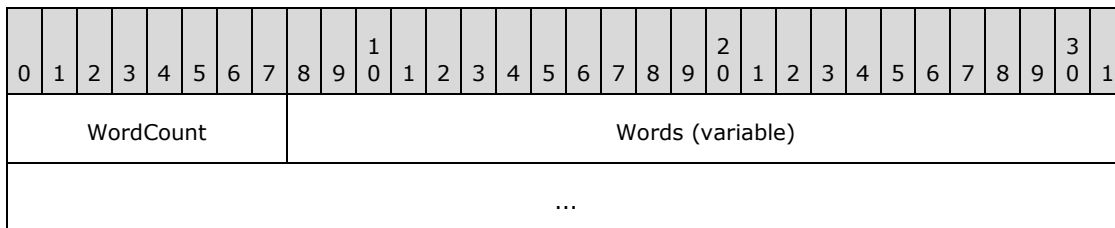

WordCount (1 byte): The value of **Words.SetupCount** plus 10 (0x0A). This value represents the total number of SMB parameter words and MUST be greater than or equal to 10 (0x0A).

Words (variable):

0	1	2	3	4	5	6	7	8	9	0	1	2	3	4	5	6	7	8	9	0	1	2	3	4	5	6	7	8	9	0	1
TotalParameterCount										TotalDataCount																					
Reserved1										ParameterCount																					
ParameterOffset										ParameterDisplacement																					
DataCount										DataOffset																					
DataDisplacement										SetupCount					Reserved2																
Setup (variable)																															
...																															

TotalParameterCount (2 bytes): The total number of transaction parameter bytes that the server expects to send to the client for this response. Parameter bytes for a transaction are carried within the **SMB_Data.Trans_Parameters** field of the SMB_COM_TRANSACTION response. If the size of all of the required **SMB_Data.Trans_Parameters** for a given transaction causes the response to exceed the **MaxBufferSize** established during session setup, then the server MUST NOT send all of the parameters in one response. The server MUST break up the parameters and send additional responses using the SMB_COM_TRANSACTION command to send the additional parameters. Any single response MUST NOT exceed the **MaxBufferSize** established during session setup. The server indicates to the client to expect additional parameters in at least one more SMB_COM_TRANSACTION response by setting **ParameterCount** (see following) to be less than **TotalParameterCount**.

TotalDataCount (2 bytes): The total number of transaction data bytes that the server expects to send to the client for this response. Data bytes of a transaction are carried within the **SMB_Data.Trans_Data** field of the SMB_COM_TRANSACTION response. If the size of all of the required **SMB_Data.Trans_Data** for a given transaction causes the response to exceed the **MaxBufferSize** established during session setup, then the server MUST NOT send all of the data in one response. The server MUST break up the data and send additional responses using the SMB_COM_TRANSACTION command to send the additional data. Any single response MUST NOT exceed the **MaxBufferSize** established during session setup. The server indicates to the client to expect additional data in at least one more SMB_COM_TRANSACTION response by setting **DataCount** (see following) to be less than **TotalDataCount**.

Reserved1 (2 bytes): Reserved. This field MUST be 0x0000 in the client request. The server MUST ignore the contents of this field.

ParameterCount (2 bytes): The number of transaction parameter bytes being sent in this response. If the transaction fits within a single SMB_COM_TRANSACTION response, then this value MUST be equal to **TotalParameterCount**. Otherwise, the sum of the **ParameterCount** values in the transaction response messages MUST be equal to the smallest **TotalParameterCount** value reported by the server. The **ParameterCount** field MUST be used to determine the number of transaction parameter bytes contained within the response.

ParameterOffset (2 bytes): This field MUST contain the number of bytes from the start of the SMB Header to the start of the **SMB_Data.Trans_Parameters** field. Client implementations MUST use this value to locate the transaction parameter block within the response. If **ParameterCount** is zero, the client/server MAY set this field to zero. <45>

ParameterDisplacement (2 bytes): The offset, in bytes, relative to all of the transaction parameter bytes in this transaction response at which this block of parameter bytes SHOULD be placed. This value MUST be used by the client to correctly reassemble the transaction response parameters when the response messages are received out of order.

DataCount (2 bytes): The number of transaction data bytes being sent in this response. If the transaction response fits within a single SMB_COM_TRANSACTION, then this value MUST be equal to **TotalDataCount**. Otherwise, the sum of the **DataCount** values in the primary and secondary transaction responses MUST be equal to the smallest **TotalDataCount** value reported to the client. If the value of this field is less than the value of **TotalDataCount**, then at least one additional SMB_COM_TRANSACTION response MUST be used to transfer the remaining data bytes.

DataOffset (2 bytes): This field MUST be the number of bytes from the start of the SMB Header of the response to the start of the **SMB_Data.Trans_Data** field. Client implementations MUST use this value to locate the transaction data block within the response. If **DataCount** is zero, the client/server MAY set this field to zero. <46>

DataDisplacement (2 bytes): The offset, in bytes, relative to all of the transaction data bytes in this transaction response at which this block of data bytes SHOULD be placed. This value MUST be used by the client to correctly reassemble the transaction data when the response messages are received out of order.

SetupCount (1 byte): The number of setup words that are included in the transaction response.

Reserved2 (1 byte): A padding byte. This field MUST be 0x00. Existing CIFS implementations can combine this field with **SetupCount** to form a USHORT. If **SetupCount** is defined as a USHORT, the high order byte MUST be zero.

Setup (variable): An array of two-byte words that provides transaction results from the server. The size and content of the array are specific to individual subprotocol subcommands.

SMB_Data (variable):

The SMB_Data section of the SMB_COM_TRANSACTION response contains the parameters and data generated by the transaction subcommand.

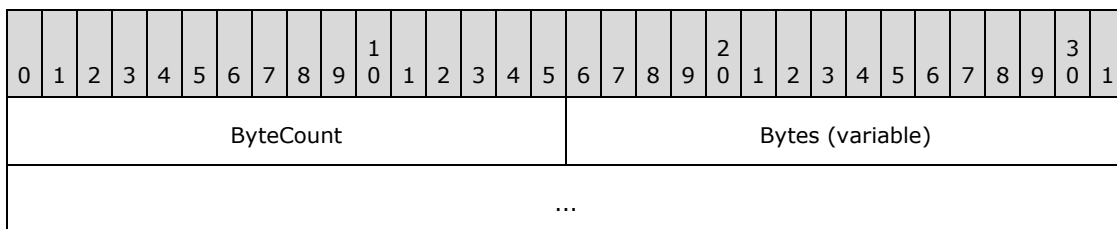

ByteCount (2 bytes): The number of bytes in the **SMB_Data.Bytes** array that follows.

Bytes (variable):

0	1	2	3	4	5	6	7	8	9	10	11	12	13	14	15	16	17	18	19	20	21	22	23	24	25	26	27	28	29	30	31
Pad1 (variable)																															
...																															
Trans_Parameters (variable)																															
...																															
Pad2 (variable)																															
...																															
Trans_Data (variable)																															
...																															

Pad1 (variable): This field SHOULD be used as an array of padding bytes to align the following field to a 4-byte boundary relative to the start of the SMB Header (section 2.2.3.1), This can cause this field to be a zero-length field. This field SHOULD be set to zero by the client/server, and MUST be ignored by the server/client.

Trans_Parameters (variable): Transaction parameter bytes. See the individual SMB_COM_TRANSACTION subcommand descriptions for information on parameters returned by the server for each subcommand.

Pad2 (variable): This field SHOULD be used as an array of padding bytes to align the following field to a 4-byte boundary relative to the start of the SMB Header. This constraint can cause this field to be a zero-length field. This field SHOULD be set to zero by the client/server and MUST be ignored by the server/client.

Trans_Data (variable): Transaction data bytes. See the individual SMB_COM_TRANSACTION subcommand descriptions for information on data returned by the server for each subcommand.

Error Codes

The errors returned from calls to SMB_COM_TRANSACTION are specific to the subcommand being executed. See the documentation for the individual subcommands for more detailed information.

2.2.4.34 SMB_COM_TRANSACTION_SECONDARY (0x26)

This command was introduced in the **LAN Manager 1.0** dialect.

The SMB_COM_TRANSACTION_SECONDARY command is used to complete a data transfer initiated by an SMB_COM_TRANSACTION Request.

For both the request and the response, the positions and lengths of the **SMB_Data.Trans_Parameters** and **SMB_Data.Trans_Data** fields are determined by the values of the **SMB_Parameters.ParameterOffset**, **SMB_Parameters.ParameterCount**, **SMB_Parameters.DataOffset**, and **SMB_Parameters.DataCount** fields. In addition, the

SMB_Parameters.ParameterDisplacement and **SMB_Parameters.DataDisplacement** fields can be used to change the order in which subranges of bytes are transferred. Servers SHOULD transfer bytes in order and give precedence to **SMB_Data.Trans_Parameters** bytes. Clients SHOULD be prepared to reconstruct transaction **SMB_Data.Trans_Parameters** and **SMB_Data.Trans_Data**, regardless of the order or locations in which they are delivered.

2.2.4.34.1 Request

```

SMB_Parameters
{
  UCHAR WordCount;
  Words
  {
    USHORT TotalParameterCount;
    USHORT TotalDataCount;
    USHORT ParameterCount;
    USHORT ParameterOffset;
    USHORT ParameterDisplacement;
    USHORT DataCount;
    USHORT DataOffset;
    USHORT DataDisplacement;
  }
}
SMB_Data
{
  USHORT ByteCount;
  Bytes
  {
    UCHAR Pad1[];
    UCHAR Trans_Parameters[ParameterCount];
    UCHAR Pad2[];
    UCHAR Trans_Data[DataCount];
  }
}

```

SMB_Header:

This command MUST be sent following a successful [SMB_COM_TRANSACTION \(section 2.2.4.33\)](#) Intermediate Response from the server. The **PID**, **MID**, **TID**, and **UID** MUST be the same for all requests and responses that are part of the same transaction.

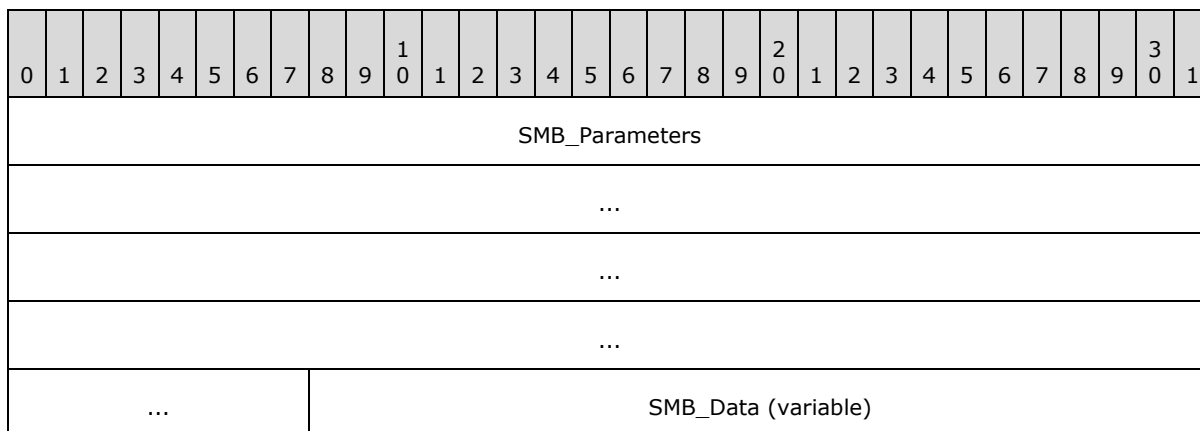

...

SMB_Parameters (17 bytes):

0	1	2	3	4	5	6	7	8	9	10	11	12	13	14	15	16	17	18	19	20	21	22	23	24	25	26	27	28	29	30	31		
WordCount										Words																							
...																																	
...																																	
...																																	
...																																	

WordCount (1 byte): This field MUST be 0x08.

Words (16 bytes):

0	1	2	3	4	5	6	7	8	9	10	11	12	13	14	15	16	17	18	19	20	21	22	23	24	25	26	27	28	29	30	31
TotalParameterCount										TotalDataCount																					
ParameterCount										ParameterOffset																					
ParameterDisplacement										DataCount																					
DataOffset										DataDisplacement																					

TotalParameterCount (2 bytes): The total number of transaction parameter bytes to be sent to the server over the course of this transaction. This value MAY be less than or equal to the **TotalParameterCount** in preceding request messages that are part of the same transaction. This value represents transaction parameter bytes, not SMB parameter words.

TotalDataCount (2 bytes): The total number of transaction data bytes to be sent to the server over the course of this transaction. This value MAY be less than or equal to the **TotalDataCount** in preceding request messages that are part of the same transaction. This value represents transaction data bytes, not SMB data bytes.

ParameterCount (2 bytes): The number of transaction parameter bytes being sent in the SMB message. This value MUST be less than **TotalParameterCount**. The sum of the **ParameterCount** values across all of the request messages in a transaction MUST be equal to the **TotalParameterCount** reported in the last request message of the transaction.

ParameterOffset (2 bytes): The offset, in bytes, from the start of the SMB_Header to the transaction parameter bytes contained in this SMB message. This MUST be the number of bytes from the start of the SMB message to the start of the **SMB_Data.Bytes.Trans_Parameters** field.

Server implementations MUST use this value to locate the transaction parameter block within the SMB message. If ParameterCount is zero, the client/server MAY set this field to zero. <47>

ParameterDisplacement (2 bytes): The offset, relative to all of the transaction parameter bytes sent to the server in this transaction, at which this block of parameter bytes MUST be placed. This value can be used by the server to correctly reassemble the transaction parameters even if the SMB request messages are received out of order.

DataCount (2 bytes): The number of transaction data bytes being sent in this SMB message. This value MUST be less than the value of **TotalDataCount**. The sum of the **DataCount** values across all of the request messages in a transaction MUST be equal to the smallest **TotalDataCount** value reported to the server.

DataOffset (2 bytes): The offset, in bytes, from the start of the SMB_Header to the transaction data bytes contained in this SMB message. This MUST be the number of bytes from the start of the SMB message to the start of the **SMB_Data.Bytes.Trans_Data** field. Server implementations MUST use this value to locate the transaction data block within the SMB message. If DataCount is zero, the client/server MAY set this field to zero. <48>

DataDisplacement (2 bytes): The offset, relative to all of the transaction data bytes sent to the server in this transaction, at which this block of parameter bytes MUST be placed. This value can be used by the server to correctly reassemble the transaction data block even if the SMB request messages are received out of order.

SMB_Data (variable):

The SMB_Data section of the SMB_COM_TRANSACTION_SECONDARY request contains parameters and data bytes being sent to the server.

0	1	2	3	4	5	6	7	8	9	10	11	12	13	14	15	16	17	18	19	20	21	22	23	24	25	26	27	28	29	30	31
ByteCount											Bytes (variable)																				
...																															

ByteCount (2 bytes): The number of bytes in the **SMB_Data.Bytes** array, which follows.

Bytes (variable):

0	1	2	3	4	5	6	7	8	9	10	11	12	13	14	15	16	17	18	19	20	21	22	23	24	25	26	27	28	29	30	31
Pad1 (variable)																															
...																															
Trans_Parameters (variable)																															
...																															

Pad2 (variable)
...
Trans_Data (variable)
...

Pad1 (variable): This field SHOULD be used as an array of padding bytes to align the following field to a 4-byte boundary relative to the start of the [SMB Header \(section 2.2.3.1\)](#). This constraint can cause this field to be a zero-length field. This field SHOULD be set to zero by the client/server and MUST be ignored by the server/client.

Trans_Parameters (variable): Transaction parameter bytes.

Pad2 (variable): This field SHOULD be used as an array of padding bytes to align the following field to a 4-byte boundary relative to the start of the SMB Header. This constraint can cause this field to be a zero-length field. This field SHOULD be set to zero by the client/server and MUST be ignored by the server/client.

Trans_Data (variable): Transaction data bytes.

2.2.4.34.2 Response

There is no response message defined for the SMB_COM_TRANSACTION_SECONDARY request.

Error Codes

Since there is no response to an SMB_COM_TRANSACTION_SECONDARY request, there are no error codes defined.

2.2.4.35 SMB_COM_IOCTL (0x27)

This command was introduced in the **LAN Manager 1.0** dialect. It was rendered obsolescent in the NT LAN Manager dialect. NT LAN Manager also removed the transaction-like behavior that supported multiple request and response messages to complete an IOCTL. The command now supports a single request followed by a single response.

This command delivers a device- or file-specific IOCTL request to a server, and a device- or file-specific IOCTL response to the requester. The target file or device is identified by the FID in the request. The request defines a function that is specific to a particular device type on a particular server type. Therefore, the functions supported are not defined by the protocol, but by the systems on which the CIFS implementations execute. The protocol simply provides a means of delivering the requests and accepting the responses. [<49>](#)

2.2.4.35.1 Request

```
SMB_Parameters
{
    UCHAR   WordCount;
    Words
    {
        USHORT FID;
        USHORT Category;
    }
}
```

```

USHORT Function;
USHORT TotalParameterCount;
USHORT TotalDataCount;
USHORT MaxParameterCount;
USHORT MaxDataCount;
ULONG Timeout;
USHORT Reserved;
USHORT ParameterCount;
USHORT ParameterOffset;
USHORT DataCount;
USHORT DataOffset;
}
}
SMB_Data
{
USHORT ByteCount;
Bytes
{
  UCHAR Pad1[];
  UCHAR Parameters[ParameterCount];
  UCHAR Pad2[];
  UCHAR Data[DataCount];
}
}

```

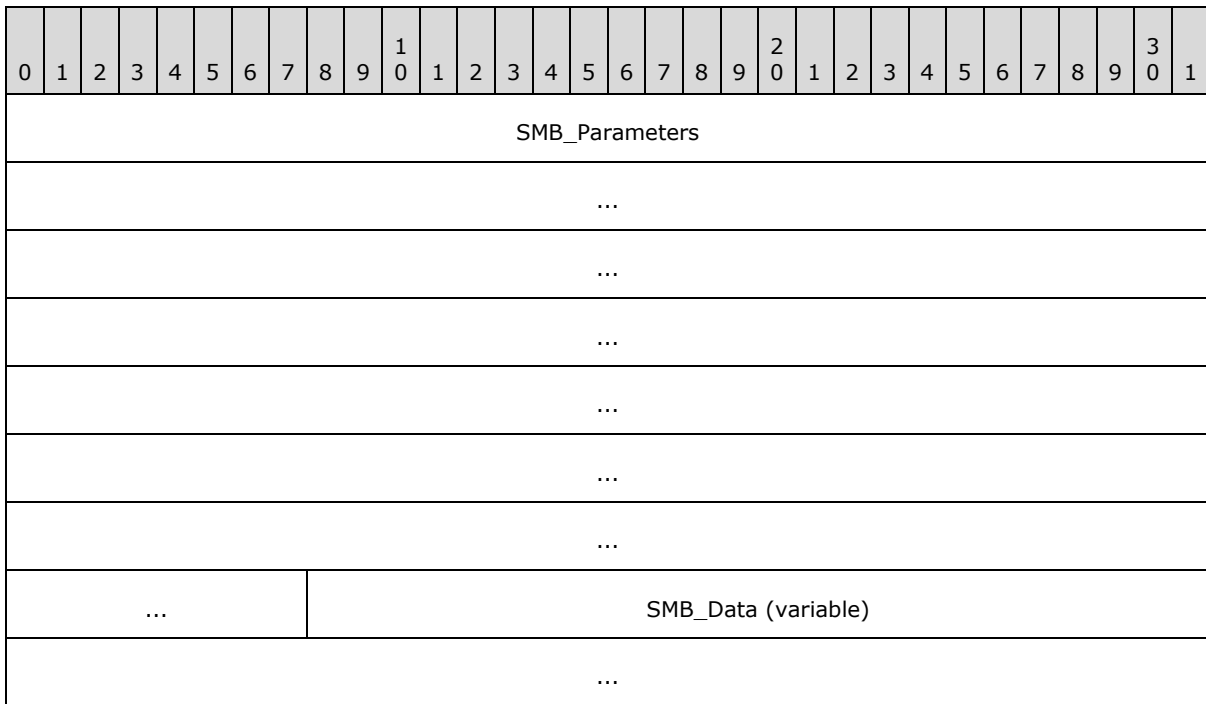

SMB_Parameters (29 bytes):

0	1	2	3	4	5	6	7	8	9	10	11	12	13	14	15	16	17	18	19	20	21	22	23	24	25	26	27	28	29	30	31						
WordCount										Words																											
...																																					
...																																					
...																																					
...																																					
...																																					
...																																					
...																																					

WordCount (1 byte): This value of this field MUST be set to 0x0E.

Words (28 bytes):

0	1	2	3	4	5	6	7	8	9	10	11	12	13	14	15	16	17	18	19	20	21	22	23	24	25	26	27	28	29	30	31
FID										Category																					
Function										TotalParameterCount																					
TotalDataCount										MaxParameterCount																					
MaxDataCount										Timeout																					
...										Reserved2																					
ParameterCount										ParameterOffset																					
DataCount										DataOffset																					

FID (2 bytes): The FID of the device or file to which the IOCTL is to be sent.

Category (2 bytes): The implementation-dependent device category for the request.

Function (2 bytes): The implementation-dependent device function for the request.

TotalParameterCount (2 bytes): The total number of IOCTL parameter bytes that the client sends to the server in this request. Parameter bytes for an IOCTL are carried within the

SMB_Data.Parameters field of the SMB_COM_IOCTL request. This value MUST be the same as **ParameterCount**.

TotalDataCount (2 bytes): The total number of IOCTL data bytes that the client sends to the server in this request. Data bytes for an IOCTL are carried within the **SMB_Data.Data** field of the SMB_COM_IOCTL request. This value MUST be the same as **DataCount**.

MaxParameterCount (2 bytes): The maximum number of **SMB_Data.Parameters** bytes that the client accepts in the IOCTL response. The server MUST NOT return more than this number of bytes in the **SMB_Data.Parameters** field of the response.

MaxDataCount (2 bytes): The maximum number of **SMB_Data.Data** bytes that the client accepts in the IOCTL response. The server MUST NOT return more than this number of bytes in the **SMB_Data.Data** field.

Timeout (4 bytes): The value of this field MUST be the maximum number of milliseconds that the server SHOULD wait for completion of the transaction before generating a time-out and returning a response to the client. The client SHOULD set this to 0x00000000 to indicate that no time-out is expected. A value of 0x00000000 indicates that the server returns an error if the resource is not immediately available. If the operation does not complete within the specified time, the server aborts the request and sends a failure response.

Reserved2 (2 bytes): Reserved. This field MUST be 0x0000 in the client request. The server MUST ignore the contents of this field.

ParameterCount (2 bytes): The number of IOCTL parameter bytes that the client sends to the server in this request. Parameter bytes for an IOCTL are carried within the **SMB_Data.Parameters** field of the SMB_COM_IOCTL request. This value MUST be the same as **TotalParameterCount**.

ParameterOffset (2 bytes): The client SHOULD set the value of this field to 0x0000. The server MUST ignore the value of this field.

DataCount (2 bytes): The total number of IOCTL data bytes that the client sends to the server in this request. Data bytes for an IOCTL are carried within the **SMB_Data.Data** field of the SMB_COM_IOCTL request. This value MUST be the same as **TotalDataCount**.

DataOffset (2 bytes): The client SHOULD set the value of this field to 0x0000. The server MUST ignore the value of this field.

SMB_Data (variable):

The **SMB_Data** section of the SMB_COM_IOCTL Request (section 2.2.4.35.1) contains the parameters and data that are the input to the IOCTL operation on the server.

0	1	2	3	4	5	6	7	8	9	10	11	12	13	14	15	16	17	18	19	20	21	22	23	24	25	26	27	28	29	30	31
ByteCount																Bytes (variable)															
...																															

ByteCount (2 bytes): The number of bytes in the **Bytes** array that follows.

Bytes (variable):

0	1	2	3	4	5	6	7	8	9	0	1	2	3	4	5	6	7	8	9	0	1	2	3	4	5	6	7	8	9	0	1		
Pad1 (variable)																																	
...																																	
Parameters (variable)																																	
...																																	
Pad2 (variable)																																	
...																																	
Data (variable)																																	
...																																	

Pad1 (variable): An array of padding bytes used to align the next field to a 2-byte or 4-byte boundary.

Parameters (variable): IOCTL parameter bytes. The contents are implementation-dependent.

Pad2 (variable): An array of padding bytes, used to align the next field to a 2-byte or 4-byte boundary.

Data (variable): Transaction data bytes. The contents are implementation-dependent.

2.2.4.35.2 Response

```

SMB_Parameters
{
    UCHAR    WordCount;
    Words
    {
        USHORT TotalParameterCount;
        USHORT TotalDataCount;
        USHORT ParameterCount;
        USHORT ParameterOffset;
        USHORT ParameterDisplacement;
        USHORT DataCount;
        USHORT DataOffset;
        USHORT DataDisplacement;
    }
}
SMB_Data
{
    USHORT ByteCount;
    Bytes
    {
        UCHAR    Pad1[];
        UCHAR    Parameters[ParameterCount];
    }
}

```

```

    UCHAR Pad2[];
    UCHAR Data[DataCount];
}
}

```

0	1	2	3	4	5	6	7	8	9	10	11	12	13	14	15	16	17	18	19	20	21	22	23	24	25	26	27	28	29	30	31
SMB_Parameters (variable)																															
...																															
SMB_Data (variable)																															
...																															

SMB_Parameters (variable):

The SMB_Parameters section of the SMB_COM_IOCTL response contains information that is used to manage the transfer of the IOCTL response. It can also contain additional information that can include IOCTL return codes or state information returned by the server. Such information is **CIFS** implementation-dependent.

0	1	2	3	4	5	6	7	8	9	10	11	12	13	14	15	16	17	18	19	20	21	22	23	24	25	26	27	28	29	30	31
WordCount										Words (variable)																					
...																															

WordCount (1 byte): The value of this field MUST be set to 0x08.

Words (variable):

0	1	2	3	4	5	6	7	8	9	10	11	12	13	14	15	16	17	18	19	20	21	22	23	24	25	26	27	28	29	30	31
TotalParameterCount																TotalDataCount															
ParameterCount																ParameterOffset															
ParameterDisplacement																DataCount															
DataOffset																DataDisplacement															

TotalParameterCount (2 bytes): The total number of IOCTL parameter bytes that the server sends to the client in this response. Parameter bytes for an IOCTL are carried within the **SMB_Data.Parameters** field of the SMB_COM_IOCTL request. This value MUST be the same as

ParameterCount, and this value MUST be less than or equal to the **MaxParameterCount** field value in the client's request.

TotalDataCount (2 bytes): The total number of IOCTL data bytes that the server sends to the client in this response. Data bytes for an IOCTL are carried within the **SMB_Data.Data** field of the SMB_COM_IOCTL request. This value MUST be the same as **DataCount**, and this value MUST be less than or equal to the **MaxDataCount** field value in the client's request.

ParameterCount (2 bytes): The total number of IOCTL parameter bytes that the server sends to the client in this response. Parameter bytes for an IOCTL are carried within the **SMB_Data.Parameters** field of the SMB_COM_IOCTL request. This value MUST be the same as **TotalParameterCount** and this value MUST be less than or equal to the **MaxParameterCount** field value in the client's request.

ParameterOffset (2 bytes): This field MUST contain the number of bytes from the start of the [SMB Header \(section 2.2.3.1\)](#) to the start of the **SMB_Data.Parameters** field. Client implementations MUST use this value to locate the IOCTL parameter block within the response.

ParameterDisplacement (2 bytes): The server SHOULD set the value of this field to 0x0000. The client MUST ignore the value of this field.

DataCount (2 bytes): The total number of IOCTL data bytes that the server sends to the client in this response. Data bytes for an IOCTL are carried within the **SMB_Data.Data** field of the SMB_COM_IOCTL request. This value MUST be the same as **TotalDataCount**, and this value MUST be less than or equal to the **MaxDataCount** field value of the client's request.

DataOffset (2 bytes): This field MUST be the number of bytes from the start of the SMB Header of the response to the start of the **SMB_Data.Data** field. Client implementations MUST use this value to locate the IOCTL data block within the response.

DataDisplacement (2 bytes): The server SHOULD set the value of this field to 0x0000. The client MUST ignore the value of this field.

SMB_Data (variable):

The SMB_Data section of the SMB_COM_IOCTL response contains the parameters and data generated by the IOCTL command.

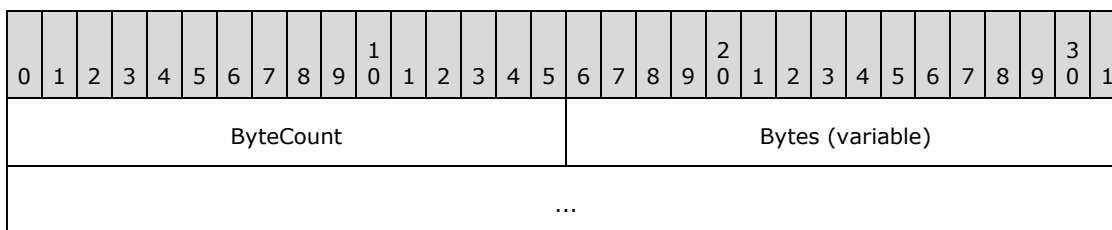

ByteCount (2 bytes): The number of bytes in the **SMB_Data.Bytes** array, which follows.

Bytes (variable):

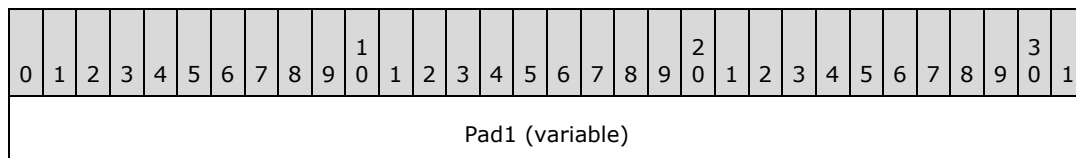

...
Parameters (variable)
...
Pad2 (variable)
...
Data (variable)
...

Pad1 (variable): An array of padding bytes used to align the next field to a 16- or 32-bit boundary.

Parameters (variable): IOCTL parameter bytes. The contents are implementation-dependent.

Pad2 (variable): An array of padding bytes used to align the next field to a 16- or 32-bit boundary.

Data (variable): IOCTL data bytes. The contents are implementation-dependent.

Error Codes

The errors returned from calls to SMB_COM_IOCTL are implementation-dependent. The list below provides a summary of error codes returned by the IOCTL mechanism.

SMB error class	SMB error code	NT status code	POSIX equivalent	Description
ERRDOS (0x01)	ERRbadfunc (0x0001)	STATUS_NOT_IMPLEMENTED (0xC0000002)		Requested category and function are not implemented by the server.
ERRDOS (0x01)	ERRnoaccess (0x0005)	STATUS_ACCESS_DENIED (0xC0000022)	EACCESS	File access rights do not match requested locks.
ERRDOS (0x01)	ERRbadfid (0x0006)	STATUS_INVALID_HANDLE (0xC0000008) STATUS_SMB_BAD_FID (0x00060001)	ENFILE	Attempt to read from a FID that the server does not have open.
ERRDOS (0x01)	ERRnomem (0x0008)	STATUS_INSUFF_SERVER_RESOURCES (0xC0000205)	ENOMEM	Insufficient server resources to place the lock.
ERRDOS	ERRrunsup	STATUS_NOT_SUPPORTED		Requested

SMB error class	SMB error code	NT status code	POSIX equivalent	Description
(0x01)	(0x0032)	(0xC00000BB)		category and function are not supported by the server.
ERRSRV (0x02)	ERRerror (0x0001)			Unspecified error.
ERRSRV (0x02)	ERRerror (0x0001)	STATUS_INVALID_SMB (0x00010002)		Invalid SMB.
ERRSRV (0x02)	ERRerror (0x0004)		EACCES	Access denied.
ERRSRV (0x02)	ERRinvtid (0x0005)	STATUS_SMB_BAD_TID (0x00050002)		Invalid TID in request.
ERRSRV (0x02)	ERRbaduid (0x005B)	STATUS_SMB_BAD_UID (0x005B0002)		The UID specified is not known as a valid ID for this session, or the user identified by the UID does not have sufficient privileges.
ERRSRV (0x02)	ERRmoredata (0x00EA)	STATUS_BUFFER_OVERFLOW (0xC0000005)		There is more data available (on the specified named pipe) than can be returned in this transaction.
ERRSRV (0x02)	ERRnosupport (0xFFFF)	STATUS_SMB_NO_SUPPORT (0xFFFF0002)		The command is not supported by the server. <50>

2.2.4.36 SMB_COM_IOCTL_SECONDARY (0x28)

This command was introduced in the **LAN Manager 1.0** dialect (see [\[SMB-LM1X\]](#) section 9.2.7). It was rendered obsolete in the NT LAN Manager dialect and is considered reserved but not implemented. Clients SHOULD NOT send requests using this command code, and servers receiving requests with this command code MUST return STATUS_NOT_IMPLEMENTED (ERRDOS/ERRbadfunc).

This command is a companion to SMB_COM_IOCTL, which has been deprecated. Please see [SMB_COM_IOCTL \(section 2.2.4.35\)](#) for more information.

2.2.4.37 SMB_COM_COPY (0x29)

This command was introduced in the **LAN Manager 1.0** dialect (see [\[SMB-LM1X\]](#) section 9.2.1 and [\[XOPEN-SMB\]](#) sections 14.1 and 15.2). It was rendered obsolete in the NT LAN Manager dialect.

This command was used to perform server-side file copies, but is no longer used. Clients SHOULD NOT send requests using this command code. Servers receiving requests with this command code SHOULD return STATUS_NOT_IMPLEMENTED (ERRDOS/ERRbadfunc).<51>

2.2.4.38 SMB_COM_MOVE (0x2A)

This command was introduced in the **LAN Manager 1.0** dialect (see [\[SMB-LM1X\]](#) section 9.2.10 and [\[XOPEN-SMB\]](#) section 14.4). It was rendered obsolete in the NT LAN Manager dialect.

This command was used to move files on the server, but is no longer in use. Clients SHOULD NOT send requests using this command code. Servers receiving requests with this command code SHOULD<52> return STATUS_NOT_IMPLEMENTED (ERRDOS/ERRbadfunc).

2.2.4.39 SMB_COM_ECHO (0x2B)

This command was introduced in the **LAN Manager 1.0** dialect.

The SMB_COM_ECHO command is sent by the client to test the transport layer connection with the server.

2.2.4.39.1 Request

```
SMB_Parameters
{
    UCHAR WordCount;
    Words
    {
        USHORT EchoCount;
    }
}
SMB_Data
{
    USHORT ByteCount;
    Bytes
    {
        UCHAR Data[ByteCount];
    }
}
```

SMB_Header:

TID (2 bytes): This field MUST contain a valid TID or 0xFFFF.<53>

0	1	2	3	4	5	6	7	8	9	10	11	12	13	14	15	16	17	18	19	20	21	22	23	24	25	26	27	28	29	30	31
SMB_Parameters																								SMB_Data (variable)							
...																															

SMB_Parameters (3 bytes):

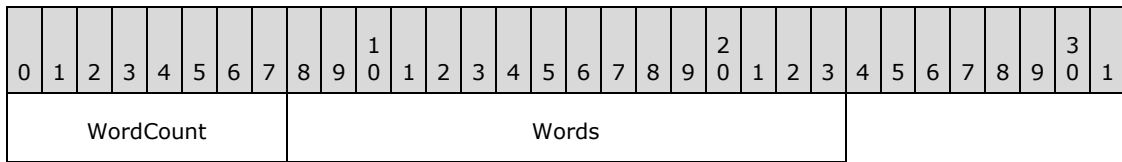

WordCount (1 byte): This field MUST be 0x01.

Words (2 bytes):

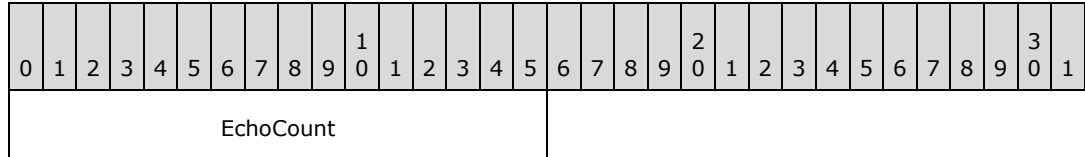

EchoCount (2 bytes): USHORT The number of times that the server SHOULD echo the contents of the **SMB_Data.Data** field.

SMB_Data (variable):

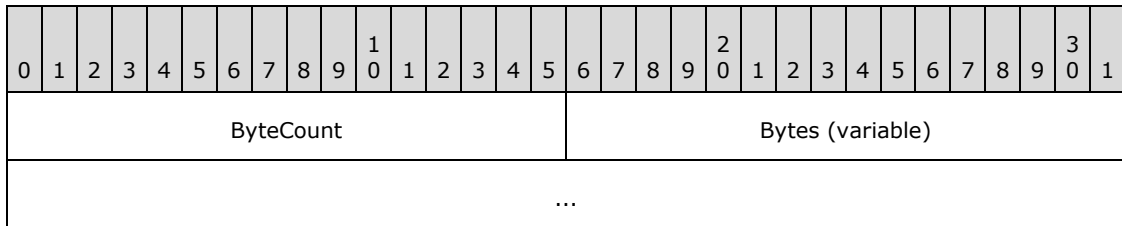

ByteCount (2 bytes): This field MUST be greater than or equal to 0x0000, indicating the number of bytes of data.

Bytes (variable):

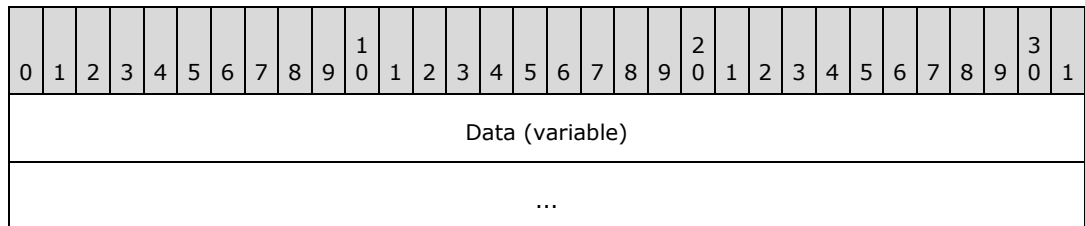

Data (variable): Data to echo.

2.2.4.39.2 Response

```

SMB_Parameters
{
    UCHAR WordCount;
    Words
    {
        USHORT SequenceNumber;
    }
}
SMB_Data

```

```

{
USHORT ByteCount;
Bytes
{
    UCHAR Data[ByteCount];
}
}

```

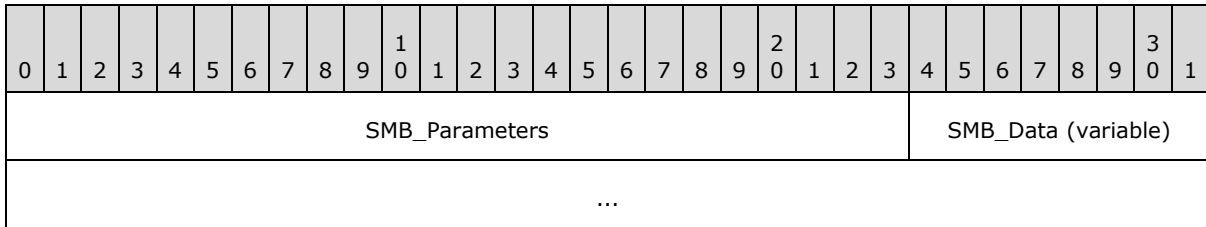

SMB_Parameters (3 bytes):

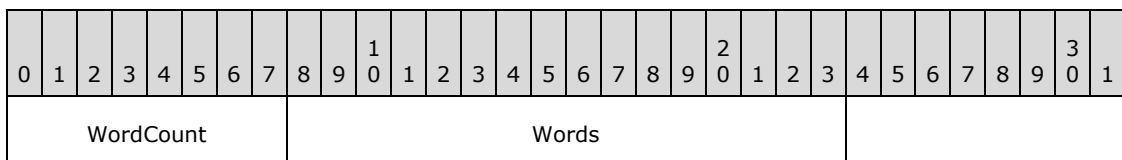

WordCount (1 byte): This field MUST be 0x01.

Words (2 bytes):

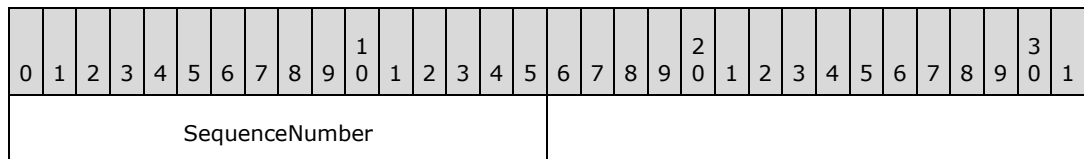

SequenceNumber (2 bytes): The sequence number of this echo response message. [<54>](#)

SMB_Data (variable):

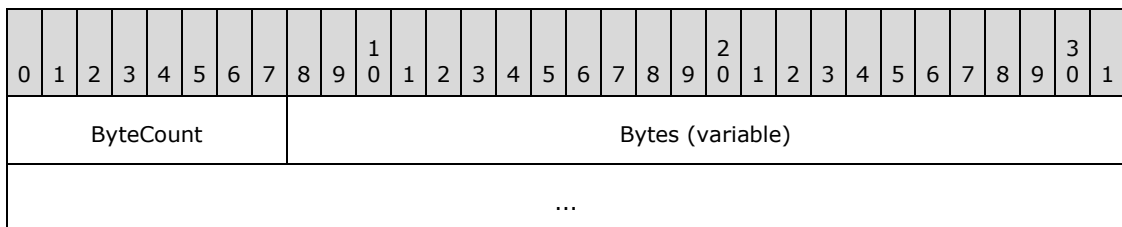

ByteCount (1 byte): This field MUST be the same as it was in the request.

Bytes (variable):

0	1	2	3	4	5	6	7	8	9	0	1	2	3	4	5	6	7	8	9	0	1	2	3	4	5	6	7	8	9	0	1
Data (variable)																															
...																															

Data (variable): This field MUST be the same as it was in the request.

Error Codes

SMB error class	SMB error code	NT status code	POSIX equivalent	Description
ERRSRV (0x02)	ERRinvtid (0x0005)	STATUS_SMB_BAD_TID (0x00050002)		The TID specified in the command was invalid.

2.2.4.40 SMB_COM_WRITE_AND_CLOSE (0x2C)

This command was introduced in the **LAN Manager 1.0** dialect. This command is deprecated. Clients SHOULD <55> use the [SMB_COM_WRITE_ANDX \(section 2.2.4.43\)](#) command.

This write and close command has the effect of writing to a range of bytes and then closing the file associated with the supplied FID. This command behaves identically to an [SMB_COM_WRITE \(section 2.2.4.12\)](#) command followed by an [SMB_COM_CLOSE \(section 2.2.4.5\)](#) command. See SMB_COM_WRITE and SMB_COM_CLOSE for more details. This command supports two request formats: one with six parameter words and one with 12 parameter words.

This command supports 32-bit offsets only and is inappropriate for files having 64-bit offsets. The client SHOULD use SMB_COM_WRITE_ANDX to write to files requiring 64-bit file offsets.

The client MUST have at least write access to the file. If an error is returned by the underlying object store, the server SHOULD still close the file.

2.2.4.40.1 Request

```
SMB_Parameters
{
  UCHAR WordCount;
  Words
  {
    USHORT FID;
    USHORT CountOfBytesToWrite;
    ULONG WriteOffsetInBytes;
    UTIME LastWriteTime;
    ULONG Reserved[3] (optional);
  }
}
SMB_Data
{
  USHORT ByteCount;
  Bytes
  {
```

```

    UCHAR Pad;
    UCHAR Data[CountOfBytesToWrite];
}
}

```

SMB_Header:

TID (2 bytes): This field MUST contain a valid TID.

UID (2 bytes): This field MUST contain a valid UID.

0	1	2	3	4	5	6	7	8	9	10	11	12	13	14	15	16	17	18	19	20	21	22	23	24	25	26	27	28	29	30	31
SMB_Parameters (variable)																															
...																															
SMB_Data (variable)																															
...																															

SMB_Parameters (variable):

0	1	2	3	4	5	6	7	8	9	10	11	12	13	14	15	16	17	18	19	20	21	22	23	24	25	26	27	28	29	30	31
WordCount										Words (variable)																					
...																															

WordCount (1 byte): This field MUST be either 0x06 or 0x0C.

Words (variable):

0	1	2	3	4	5	6	7	8	9	10	11	12	13	14	15	16	17	18	19	20	21	22	23	24	25	26	27	28	29	30	31
FID										CountOfBytesToWrite																					
WriteOffsetInBytes																															
LastWriteTime																															
Reserved																															
...																															

...

FID (2 bytes): This field MUST be a valid 16-bit unsigned integer indicating the file to which the data SHOULD be written.

CountOfBytesToWrite (2 bytes): This field is a 16-bit unsigned integer indicating the number of bytes to be written to the file. The client MUST ensure that the amount of data sent can fit in the negotiated maximum buffer size. If the value of this field is zero (0x0000), the server MUST truncate or extend the file to match the **WriteOffsetInBytes**.

WriteOffsetInBytes (4 bytes): This field is a 32-bit unsigned integer indicating the offset, in number of bytes, from the beginning of the file at which to begin writing to the file. The client MUST ensure that the amount of data sent can fit in the negotiated maximum buffer size. Because this field is limited to 32-bits, this command is inappropriate for files that have 64-bit offsets.

LastWriteTime (4 bytes): This field is a 32-bit unsigned integer indicating the number of seconds since Jan 1, 1970, 00:00:00.0. The server SHOULD set the last write time of the file represented by the FID to this value. If the value is zero (0x00000000), the server SHOULD use the current local time of the server to set the value. Failure to set the time MUST NOT result in an error response from the server.

Reserved (12 bytes): This field is optional. This field is reserved, and all entries MUST be zero (0x00000000). This field is used only in the 12-word version of the request.

SMB_Data (variable):

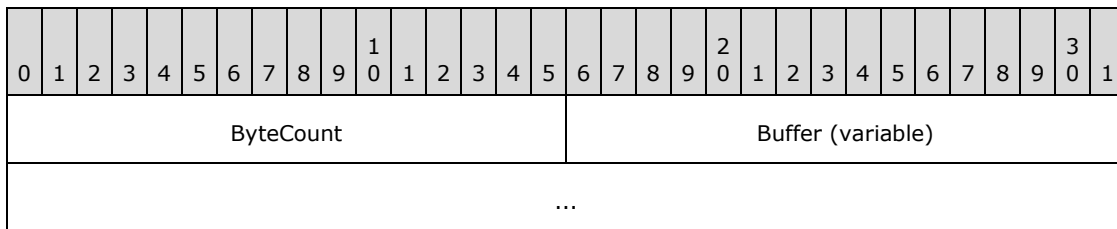

ByteCount (2 bytes): This field MUST be 0x0001 + **CountOfBytesToWrite**.

Buffer (variable):

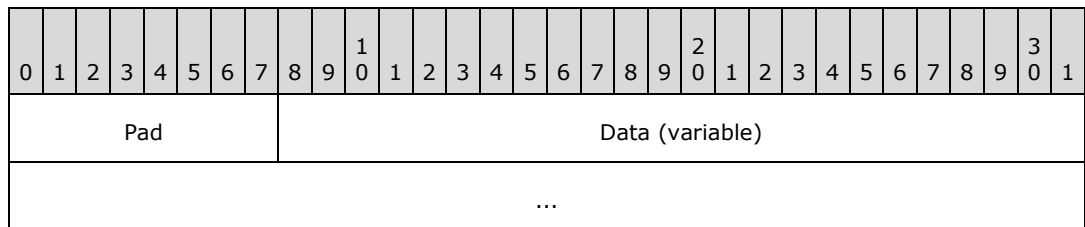

Pad (1 byte): The value of this field SHOULD be ignored. This is padding to force the byte alignment to a double word boundary.

Data (variable): The raw bytes to be written to the file.

2.2.4.40.2 Response

```

SMB_Parameters
{
    UCHAR WordCount;
    Words
    {
        USHORT CountOfBytesWritten;
    }
}
SMB_Data
{
    USHORT ByteCount;
}

```

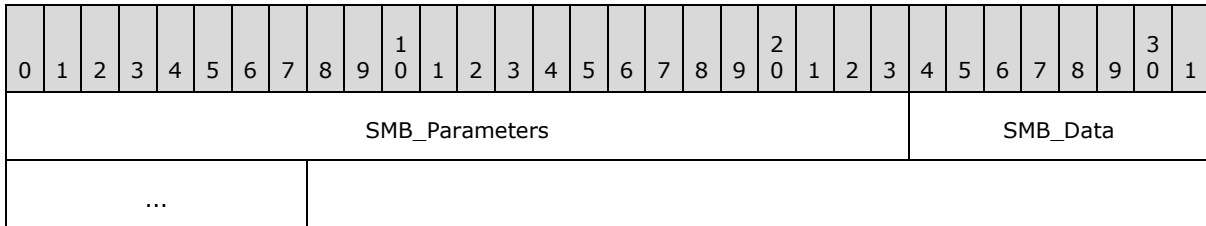

SMB_Parameters (3 bytes):

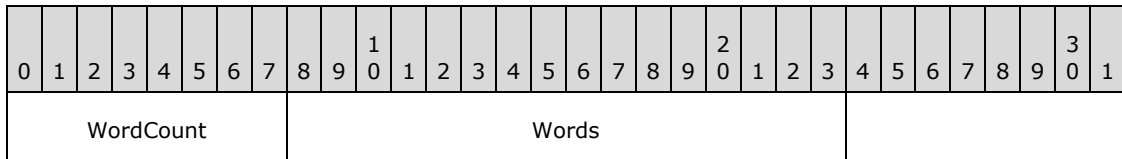

WordCount (1 byte): This field MUST be 0x01.

Words (2 bytes):

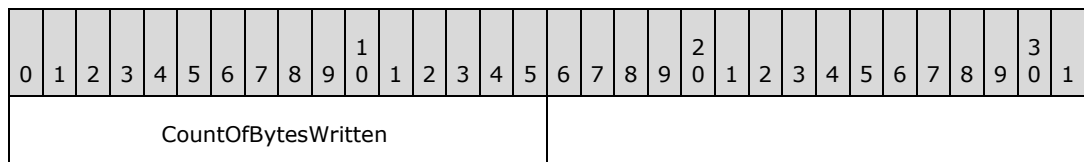

CountOfBytesWritten (2 bytes): Indicates the actual number of bytes written to the file. For successful writes, this MUST equal the **CountOfBytesToWrite** in the client's request. If the number of bytes written differs from the number requested and no error is indicated, then the server has no resources available with which to satisfy the complete write.

SMB_Data (2 bytes):

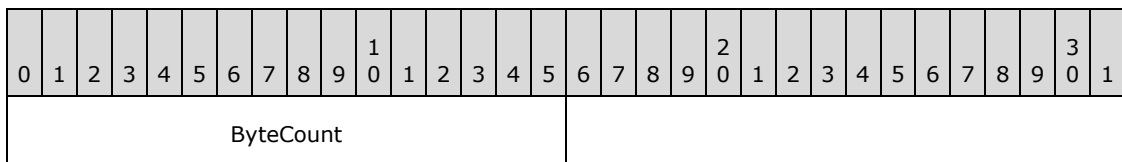

ByteCount (2 bytes): This field MUST be 0x0000. No data is sent by this message. [<56>](#)

Error Codes

SMB error class	SMB error code	NT status code	POSIX equivalent	Description
ERRDOS (0x01)	ERRnoaccess (0x0005)		EAGAIN	Resources for I/O on the server are temporarily exhausted.
ERRDOS (0x01)	ERRnoaccess (0x0005)	STATUS_ALREADY_COMMITTED (0xC0000021)	ENOLCK	A record lock has been taken on the file or the client has attempted to write to a portion of the file that the server detects has been locked, opened in deny-write mode, or opened in read-only mode.
ERRDOS (0x01)	ERRbadfid (0x0006)	STATUS_INVALID_HANDLE (0xC0000008) STATUS_SMB_BAD_FID (0x00060001)	ENFILE	Invalid FID, or FID mapped to a valid server FID but it was not acceptable to the operating system.
ERRDOS (0x01)	ERRnomem (0x0008)	STATUS_INSUFF_SERVER_RESOURCES (0xC0000205) STATUS_NO_MEMORY (0xC0000017)	ENOMEM	The server is out of resources.
ERRDOS (0x01)	ERRbadaccess (0x000C)	STATUS_ACCESS_DENIED (0xC0000022)		Write permission required.
ERRDOS (0x01)	ERRlock (0x0021)	STATUS_FILE_LOCK_CONFLICT (0xC0000054)		The requested byte range was already locked by a different process (PID).
ERRDOS (0x01)	ERRnotconnected (0x00E9)	STATUS_PIPE_DISCONNECTED (0xC00000B0)	EPIPE	Write to a named pipe with no reader.
ERRSRV (0x02)	ERRerror (0x0001)		EDEADLK	The write would block due to locking and deadlock would

SMB error class	SMB error code	NT status code	POSIX equivalent	Description
				result.
ERRSRV (0x02)	ERRerror (0x0001)		ERANGE	Attempted write size is outside of the minimum or maximum ranges that can be written to the supplied FID.
ERRSRV (0x02)	ERRerror (0x0001)	STATUS_INVALID_SMB (0x00010002)		A corrupt SMB request was received.
ERRSRV (0x02)	ERRinvtid (0x0005)	STATUS_SMB_BAD_TID (0x00050002)		Invalid TID in request.
ERRSRV (0x02)	ERRqfull (0x0031)	STATUS_PRINT_QUEUE_FULL (0xC00000C6)		Print queue is full - too many queued items.
ERRSRV (0x02)	ERRqtoobig (0x0032)	STATUS_NO_SPOOL_SPACE (0xC00000C7)		Print queue is full - too many queued items.
ERRSRV (0x02)	ERRbaduid (0x005B)	STATUS_SMB_BAD_UID (0x005B0002)		The UID specified is not known as a valid ID on this server session, or the user identified by the UID does not have sufficient privileges.
ERRHRD (0x03)	ERRdata (0x0017)	STATUS_DATA_ERROR (0xC000003E)	EIO	A problem has occurred in the physical I/O.
ERRHRD (0x03)	ERRwrite (0x001D)		ENXIO	The device associated with the file descriptor is a block-special or character-special file, and the value of the file pointer is out of range.
ERRHRD (0x03)	ERRdiskfull (0x0027)	STATUS_DISK_FULL (0xC000007F)	ENOSPC EFBIG	The file system is full, or the file has grown too large and no

SMB error class	SMB error code	NT status code	POSIX equivalent	Description
				more data can be written to the file.

2.2.4.41 SMB_COM_OPEN_ANDX (0x2D)

This command was introduced in the **LAN Manager 1.0** dialect.

This command is used to create and open a new file or open an existing regular file and chain additional messages along with the request. See section [3.2.4.1.1](#) for details on chaining commands. The command includes the pathname relative to the **TID** of the file, named pipe, or device that the client attempts to open. If the command is successful, the server response **MUST** include a valid **FID**. The client **MUST** supply the **FID** in subsequent operations on the object.

The following are the commands that can follow an SMB_COM_OPEN_ANDX in an AndX chain:

- [SMB_COM_READ \(section 2.2.4.11\)](#)
- [SMB_COM_READ_ANDX \(section 2.2.4.42\)](#)
- [SMB_COM_IOCTL \(section 2.2.4.35\)](#)
- [SMB_COM_NO_ANDX_COMMAND \(section 2.2.4.75\)](#)

2.2.4.41.1 Request

```

SMB_Parameters
{
    UCHAR WordCount;
    Words
    {
        UCHAR    AndXCommand;
        UCHAR    AndXReserved;
        USHORT   AndXOffset;
        USHORT   Flags;
        USHORT   AccessMode;
        SMB_FILE_ATTRIBUTES SearchAttrs;
        SMB_FILE_ATTRIBUTES FileAttrs;
        UTIME    CreationTime;
        USHORT   OpenMode;
        ULONG    AllocationSize;
        ULONG    Timeout;
        USHORT   Reserved[2];
    }
}
SMB_Data
{
    USHORT ByteCount;
    Bytes
    {
        SMB_STRING FileName;
    }
}

```

0	1	2	3	4	5	6	7	8	9	10	11	12	13	14	15	16	17	18	19	20	21	22	23	24	25	26	27	28	29	30	31
SMB_Parameters																															
...																															
...																															
...																															
...																															
...																															
...																															
...																								SMB_Data (variable)							
...																															

SMB_Parameters (31 bytes):

0	1	2	3	4	5	6	7	8	9	10	11	12	13	14	15	16	17	18	19	20	21	22	23	24	25	26	27	28	29	30	31
WordCount										Words																					
...																															
...																															
...																															
...																															
...																															
...																															
...																															

WordCount (1 byte): This field MUST be 0x0F.

Words (30 bytes):

0	1	2	3	4	5	6	7	8	9	10	11	12	13	14	15	16	17	18	19	20	21	22	23	24	25	26	27	28	29	30	31
AndXCommand										AndXReserved										AndXOffset											
Flags																AccessMode															
SearchAttrs																FileAttrs															
CreationTime																															
OpenMode																AllocationSize															
...																Timeout															
...																Reserved															
...																															

AndXCommand (1 byte): The command code for the next SMB command in the packet. This value MUST be set to 0xFF if there are no additional SMB commands in the client request packet.

AndXReserved (1 byte): A reserved field. This field MUST be 0x00 when the message is sent, and the server MUST ignore this value when the message is received.

AndXOffset (2 bytes): This field MUST be set to the offset, in bytes, from the start of the [SMB Header \(section 2.2.3.1\)](#) to the start of the **WordCount** field in the next SMB command in this packet. This field is valid only if the AndXCommand field is not set to 0xFF. If AndXCommand is 0xFF, this field MUST be ignored by the server.

Flags (2 bytes): A 16-bit field of flags for requesting attribute data and locking.

Name and bitmask	Description
REQ_ATTRIB 0x0001	If this bit is set, the client requests that the file attribute data in the response be populated. All fields after the FID in the response are also populated. If this bit is not set, all fields after the FID in the response are zero.
REQ_OPLOCK 0x0002	Client requests an exclusive OpLock on the file.
REQ_OPLOCK_BATCH 0x0004	Client requests a Batch OpLock on the file.

AccessMode (2 bytes): A 16-bit field for encoding the requested access mode. See section [3.2.4.5.1](#) for a discussion on sharing modes.

Name and bitmask	Values	Meaning
AccessMode 0x0007	0	Open for reading
	1	Open for writing
	2	Open for reading and writing
	3	Open for execution
0x0008	Reserved	
SharingMode 0x0070	0	Compatibility mode
	1	Deny read/write/execute to others (exclusive use requested)
	2	Deny write to others
	3	Deny read/execute to others
	4	Deny nothing to others
0x0080	Reserved	
ReferenceLocality 0x0700	0	Unknown locality of reference
	1	Mainly sequential access
	2	Mainly random access
	3	Random access with some locality
	4 - 7	Undefined
0x0800	Reserved	
CacheMode 0x1000	0	Perform caching on file
	1	Do not cache the file
0x2000	Reserved	
WritethroughMode 0x4000	0	Write-through mode. If this flag is set, no read ahead or write behind allowed on this file or device. When the response is returned, data is expected to be on the target disk or device.
	1	
0x8000	Reserved	

SearchAttrs (2 bytes): The set of attributes that the file MUST have in order to be found. If none of the attribute bytes is set, the file attributes MUST refer to a regular file. <57>

FileAttrs (2 bytes): The set of attributes that the file is to have if the file needs to be created. If none of the attribute bytes is set, the file attributes MUST refer to a regular file.

CreationTime (4 bytes): A 32-bit integer time value to be assigned to the file as the time of creation if the file is created.

OpenMode (2 bytes): A 16-bit field that controls the way a file SHOULD be treated when it is opened for use by certain extended SMB requests.

Name and bitmask	Values	Meaning
FileExistsOpts 0x0003	0	The request SHOULD fail and an error returned indicating the prior existence of the file.
	1	The file is to be appended.
	2	The file is to be truncated to zero (0) length.
	3	Reserved
CreateFile 0x0010	0	If the file does not exist, return an error.
	1	If the file does not exist, create it.

All other bits are reserved, SHOULD NOT be used by the client, and MUST be ignored by the server.

AllocationSize (4 bytes): The number of bytes to reserve on file creation or truncation. This field MAY be ignored by the server.

Timeout (4 bytes): This field is a 32-bit unsigned integer value containing the number of milliseconds to wait on a blocked open request before returning without successfully opening the file.

Reserved (4 bytes): This field is reserved and MUST be 0x00000000.

SMB_Data (variable):

0	1	2	3	4	5	6	7	8	9	10	11	12	13	14	15	16	17	18	19	20	21	22	23	24	25	26	27	28	29	30	31
ByteCount																Bytes (variable)															
...																															

ByteCount (2 bytes): This field MUST be greater than or equal to 0x0002.

Bytes (variable):

0	1	2	3	4	5	6	7	8	9	10	11	12	13	14	15	16	17	18	19	20	21	22	23	24	25	26	27	28	29	30	31
FileName (variable)																															
...																															

FileName (variable): A buffer containing the name of the file to be opened.

2.2.4.41.2 Response

The server MUST populate the **FID** field only, unless the client has requested file attribute data by setting bit 0 of the **Flags** field in the request. If file attribute data is not requested, all fields following the **FID** in the response MUST be set to zero.

```

SMB_Parameters
{
  UCHAR WordCount;
  Words
  {
    UCHAR          AndXCommand;
    UCHAR          AndXReserved;
    USHORT         AndXOffset;
    USHORT         FID;
    SMB_FILE_ATTRIBUTES FileAttrs;
    UTIME          LastWriteTime;
    ULONG          FileDataSize;
    USHORT         AccessRights;
    USHORT         ResourceType;
    SMB_NMPIPE_STATUS NMPipeStatus;
    USHORT         OpenResults;
    USHORT         Reserved[3];
  }
}
SMB_Data
{
  USHORT ByteCount;
}

```

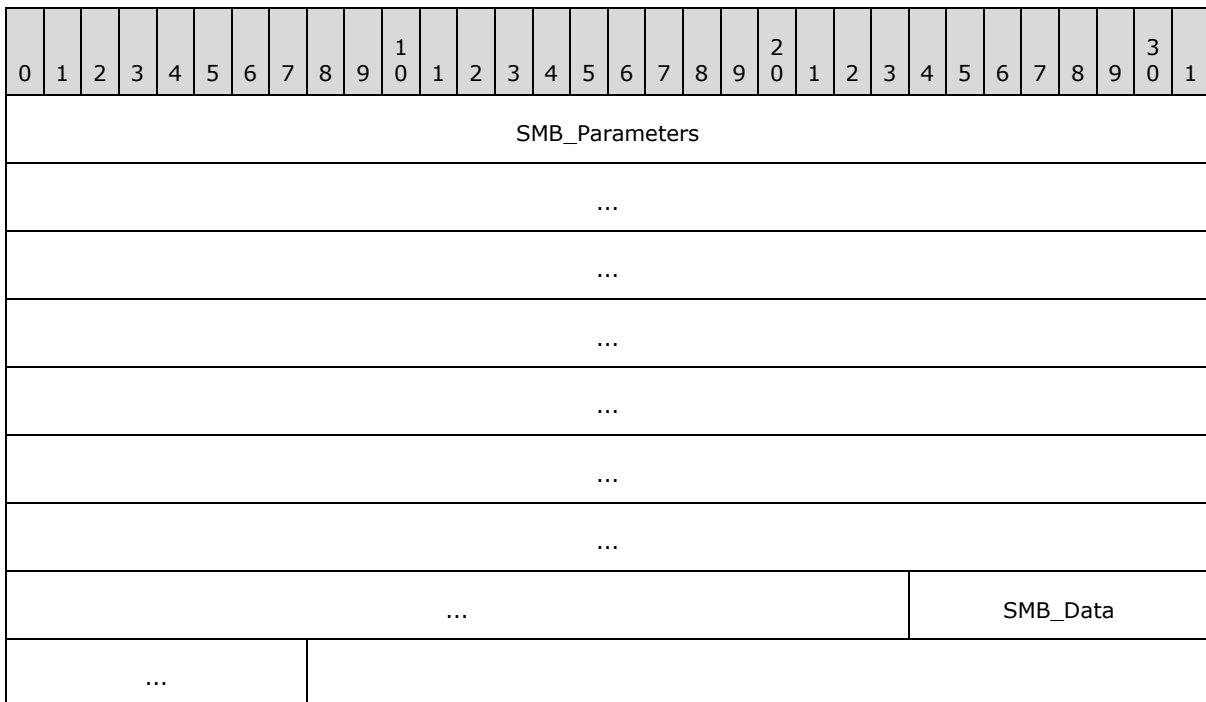

SMB_Parameters (31 bytes):

0	1	2	3	4	5	6	7	8	9	10	11	12	13	14	15	16	17	18	19	20	21	22	23	24	25	26	27	28	29	30	31					
WordCount										Words																										
...																																				
...																																				
...																																				
...																																				
...																																				
...																																				
...																																				

WordCount (1 byte): This field MUST be 0x0F.

Words (30 bytes):

0	1	2	3	4	5	6	7	8	9	10	11	12	13	14	15	16	17	18	19	20	21	22	23	24	25	26	27	28	29	30	31
AndXCommand										AndXReserved										AndXOffset											
FID															FileAttrs																
LastWriteTime																															
FileDataSize																															
AccessRights															ResourceType																
NMPipeStatus															OpenResults																
Reserved																															
...																															

AndXCommand (1 byte): The command code for the next SMB command in the packet. This value MUST be set to 0xFF if there are no additional SMB command responses in the server response packet.

AndXReserved (1 byte): A reserved field. This MUST be set to 0x00 when this response is sent, and the client MUST ignore this field.

AndXOffset (2 bytes): This field MUST be set to the offset, in bytes, from the start of the [SMB Header \(section 2.2.3.1\)](#) to the start of the **WordCount** field in the next SMB command response in this packet. This field is valid only if the **AndXCommand** field is not set to 0xFF. If **AndXCommand** is 0xFF, this field MUST be ignored by the client.

FID (2 bytes): A valid FID representing the open instance of the file.

FileAttrs (2 bytes): The actual file system attributes of the file. If none of the attribute bytes is set, the file attributes refer to a regular file.

LastWriteTime (4 bytes): A 32-bit integer time value of the last modification to the file.

FileDataSize (4 bytes): The number of bytes in the file. This field is advisory and MAY be used.

AccessRights (2 bytes): A 16-bit field that shows granted access rights to the file.

Name and value	Meaning
SMB_DA_ACCESS_READ 0x0000	Read-only Access
SMB_DA_ACCESS_WRITE 0x0001	Write-only Access
SMB_DA_ACCESS_READ_WRITE 0x0002	Read/Write Access

All other values are reserved and MUST NOT be used.

ResourceType (2 bytes): A 16-bit field that shows the resource type opened.

Name and value	Meaning
FileTypeDisk 0x0000	Disk file or directory.
FileTypeByteModePipe 0x0001	Byte mode named pipe.
FileTypeMessageModePipe 0x0002	Message-mode named pipe.
FileTypePrinter 0x0003	Printer device.
FileTypeCommDevice 0x0004	Character-mode device. When an extended protocol has been negotiated, this value allows a device to be opened for driver-level I/O. This provides direct access to real-time and interactive devices such as modems, scanners, and so on.
FileTypeUnknown 0xFFFF	Unknown file type.

All other values are reserved and MUST NOT be used.

NMPipeStatus (2 bytes): A 16-bit field that contains the status of the named pipe if the resource type opened is a named pipe.

This field is formatted as an [SMB NMPIPE STATUS \(section 2.2.1.3\)](#).

OpenResults (2 bytes): A 16-bit field that shows the results of the open operation.

Name and bitmask	Values	Meaning
OpenResult 0x0003	1	The file existed and was opened.
	2	The file did not exist and was therefore created.
	3	The file existed and was truncated.
	Other	Reserved
LockStatus 0x8000	0	No OpLock was requested, the OpLock could not be granted, or the server does not support OpLocks.
	1	An OpLock was requested by the client and was granted by the server.

Reserved (6 bytes): All entries MUST be 0x0000.

SMB_Data (2 bytes):

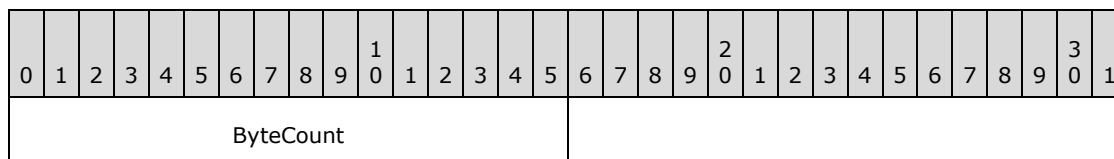

ByteCount (2 bytes): This field MUST be 0x0000. No data is sent by this message.

Error Codes

SMB error class	SMB error code	NT status code	POSIX equivalent	Description
ERRDOS (0x01)	ERRbadfile (0x0002)	STATUS_NO_SUCH_FILE (0xC000000F)	ENOENT	The named file was not found.
ERRDOS (0x01)	ERRbadpath (0x0003)	STATUS_OBJECT_PATH_SYNTAX_BAD (0xC000003B)	ENOENT	The file path syntax is invalid.
ERRDOS (0x01)	ERRbadpath (0x0003)	STATUS_OBJECT_PATH_INVALID (0xC0000039)	ENOTDIR	A component of the path-prefix was not a directory.
ERRDOS	ERRnofids	STATUS_OS2_TOO_MANY_OPEN_	ENFILE	Too many open files, no more

SMB error class	SMB error code	NT status code	POSIX equivalent	Description
S (0x01)	(0x0004)	FILES (0x00040001) STATUS_TOO_MANY_OPENED_FILES (0xC000011F)		FIDs available.
ERRDOS (0x01)	ERRnoaccess (0x0005)	STATUS_ACCESS_DENIED (0xC0000022)	EACCESS	A component of the path-prefix denied search permission OR requested access permission is denied for the file OR open mode failure.
ERRDOS (0x01)	ERRnoaccess (0x0005)	STATUS_FILE_IS_A_DIRECTORY (0xC00000BA)	EISDIR	Named file is an existing directory and requested open mode is write or read/write.
ERRDOS (0x01)	ERRnomem (0x0008)	STATUS_INSUFF_SERVER_RESOURCES (0xC0000205)	ENOMEM	The server is out of resources.
ERRDOS (0x01)	ERRbadshare (0x0020)	STATUS_SHARING_VIOLATION (0xC0000043)	EAGAIN	File exists, mandatory file/record locking is set, and there are outstanding record locks on the file.
ERRSRV (0x02)	ERRerror (0x0001)	STATUS_INVALID_SMB (0x00010002)		Invalid SMB. Not enough parameter bytes were sent or the ANDX command is invalid.
ERRSRV (0x02)	ERRerror (0x0001)		EFAULT	Path points outside the allocated address space of the process.
ERRSRV (0x02)	ERRerror (0x0001)		EINTR	A signal was caught during the open operation.
ERRSRV (0x02)	ERRerror (0x0001)		ENXIO	Generic server open failure
ERRSRV (0x02)	ERRerror (0x0001)		EEXIST	The file could not be created because another file with attributes that do not match those specified in the SMB_Parameters.Words.File_Attrs field already exists and has a conflicting name.
ERRSRV (0x02)	ERRerror (0x0001)		EMFILE	The maximum number of file descriptors available on the server for this session are currently open.

SMB error class	SMB error code	NT status code	POSIX equivalent	Description
ERRSRV (0x02)	ERRerror (0x0001)		ENOSPC	No space left on device. The system is out of resources required to create the file.
ERRSRV (0x02)	ERRerror (0x0001)		EROFS	Read-Only File System. Write or read/write access was requested on a file existing within a read-only file system.
ERRSRV (0x02)	ERRerror (0x0001)		ETXTBSY	Text file is busy. Write or read/write access was requested on a batch script that is currently being executed.
ERRSRV (0x02)	ERRerror (0x0001)	STATUS_ACCESS_DENIED (0xC0000022)	EROFS	Named file resides on read-only file system, and requested access permission is write or read/write.
ERRSRV (0x02)	ERRaccess (0x0004)	STATUS_NETWORK_ACCESS_DENIED (0xC00000CA)		Permission conflict between requested permission and permissions for the shared resource: for example, open for write of a file in a read-only file system subtree.
ERRSRV (0x02)	ERRinvtid (0x0005)	STATUS_SMB_BAD_TID (0x00050002)		The TID is no longer valid.
ERRSRV (0x02)	ERRinvdevice (0x0007)	STATUS_BAD_DEVICE_TYPE (0xC00000CB)		Server does not support the requested device type.
ERRSRV (0x02)	ERRbaduid (0x005B)	STATUS_SMB_BAD_UID (0x005B0002)		The UID supplied is not defined to the session, or the user identified by the UID does not have sufficient privileges.
ERRHRD (0x03)	ERRnowrite (0x0013)	STATUS_MEDIA_WRITE_PROTECTED (0xC00000A2)	EROFS	Attempt to write to a read-only file system.
ERRHRD (0x03)	ERRdata (0x0017)	STATUS_DATA_ERROR (0xC000003E)	EIO	Disk I/O error.

2.2.4.42 SMB_COM_READ_ANDX (0x2E)

This command was introduced in the **LAN Manager 1.0** dialect. Extensions to this command were added with the introduction of the NT LAN Manager dialect.

This command is used to read bytes from a regular file, a named pipe, or a directly accessible device such as a serial port (COM) or printer port (LPT). If the client negotiates the NT LAN Manager dialect or later, the client SHOULD use the 12-parameter words version of the request, as this version allows specification of 64-bit file offsets. This is the only read command that supports 64-bit file offsets.

The following are the commands that can follow an SMB_COM_READ_ANDX in an AndX chain:

- [SMB_COM_CLOSE \(section 2.2.4.5\)](#)

2.2.4.42.1 Request

```
SMB_Parameters
{
  UCHAR  WordCount;
  Words
  {
    UCHAR  AndXCommand;
    UCHAR  AndXReserved;
    USHORT AndXOffset;
    USHORT FID;
    ULONG  Offset;

    USHORT MaxCountOfBytesToReturn;
    USHORT MinCountOfBytesToReturn;
    ULONG  Timeout;
    USHORT Remaining;
    ULONG  OffsetHigh (optional);
  }
}
SMB_Data
{
  USHORT ByteCount;
}
```

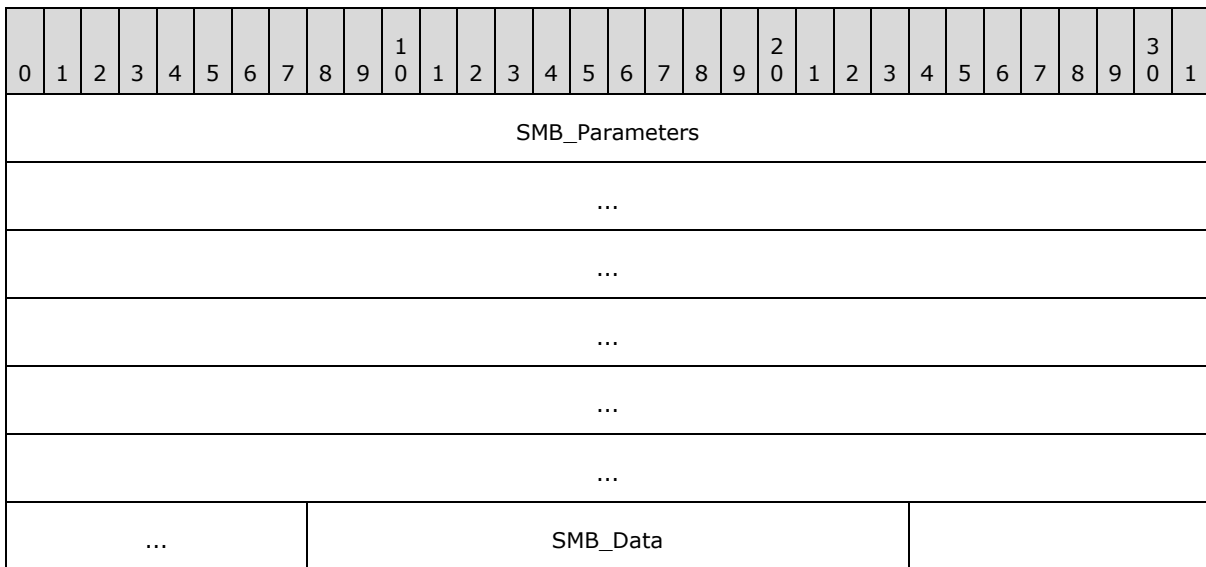

SMB_Parameters (25 bytes):

0	1	2	3	4	5	6	7	8	9	10	11	12	13	14	15	16	17	18	19	20	21	22	23	24	25	26	27	28	29	30	31					
WordCount										Words																										
...																																				
...																																				
...																																				
...																																				
...																																				
...																																				

WordCount (1 byte): This field MUST be either 0x0A or 0x0C.

Words (24 bytes):

0	1	2	3	4	5	6	7	8	9	10	11	12	13	14	15	16	17	18	19	20	21	22	23	24	25	26	27	28	29	30	31
AndXCommand										AndXReserved										AndXOffset											
FID										Offset																					
...										MaxCountOfBytesToReturn																					
MinCountOfBytesToReturn										Timeout																					
...										Remaining																					
OffsetHigh																															

AndXCommand (1 byte): The command code for the next SMB command in the packet. This value MUST be set to 0xFF if there are no additional SMB commands in the client request packet.

AndXReserved (1 byte): A reserved field. This MUST be set to 0x00 when this request is sent, and the server MUST ignore this value when the message is received.

AndXOffset (2 bytes): This field MUST be set to the offset in bytes from the start of the [SMB Header \(section 2.2.3.1\)](#) to the start of the **WordCount** field in the next SMB command in this packet. This field is valid only if the **AndXCommand** field is not set to 0xFF. If **AndXCommand** is 0xFF, this field MUST be ignored by the server.

FID (2 bytes): This field MUST be a valid FID indicating the file from which the data MUST be read.

Offset (4 bytes): If **WordCount** is 0x0A, this field represents a 32-bit offset, measured in bytes, of where the read MUST start relative to the beginning of the file. If **WordCount** is 0x0C, this field represents the lower 32 bits of a 64-bit offset.

MaxCountOfBytesToReturn (2 bytes): The maximum number of bytes to read. A single request MUST NOT return more data than permitted by the maximum negotiated buffer size (**MaxBufferSize**) for the session unless CAP_LARGE_READX has been negotiated as specified in sections [2.2.4.53.1](#) and [3.3.5.43](#). If **MaxCountOfBytesToReturn** would cause the total size of the response message to exceed the maximum negotiated buffer size, the server MUST return only the number of bytes that fit within the maximum negotiated buffer size.

MinCountOfBytesToReturn (2 bytes): The requested minimum number of bytes to return. This field is used only when reading from a named pipe or a device. It is ignored when reading from a standard file.

Timeout (4 bytes): This field represents the amount of time, in milliseconds, that a server MUST wait before sending a response. It is used only when reading from a named pipe or I/O device and does not apply when reading from a regular file.

Remaining (2 bytes): Count of bytes remaining to satisfy client's read request. This field is not used in the **NT LAN Manager** dialect. Clients MUST set this field to 0x0000, and servers MUST ignore it.

OffsetHigh (4 bytes): This field is optional. If **WordCount** is 0x0A this field is not included in the request. If **WordCount** is 0x0C this field represents the upper 32 bits of a 64-bit offset, measured in bytes, of where the read SHOULD start relative to the beginning of the file.

SMB_Data (2 bytes):

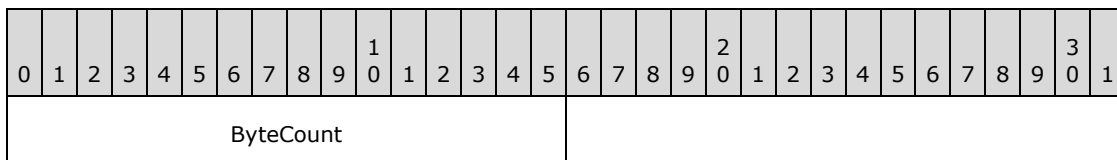

ByteCount (2 bytes): This field MUST be 0x0000. No data is sent by this message.

2.2.4.42.2 Response

```
SMB_Parameters
{
  UCHAR  WordCount;
  Words
  {
    UCHAR  AndXCommand;
    UCHAR  AndXReserved;
    USHORT AndXOffset;
    USHORT Available;
    USHORT DataCompactionMode;
    USHORT Reserved1;
    USHORT DataLength;
    USHORT DataOffset;
    USHORT Reserved2[5];
  }
}
SMB_Data
{
```

```

USHORT ByteCount;
Bytes
{
    UCHAR Pad[] (optional);
    UCHAR Data[DataLength];
}
}

```

0	1	2	3	4	5	6	7	8	9	10	11	12	13	14	15	16	17	18	19	20	21	22	23	24	25	26	27	28	29	30	31
SMB_Parameters																															
...																															
...																															
...																															
...																															
...																															
...																SMB_Data (variable)															
...																															

SMB_Parameters (25 bytes):

0	1	2	3	4	5	6	7	8	9	10	11	12	13	14	15	16	17	18	19	20	21	22	23	24	25	26	27	28	29	30	31
WordCount										Words																					
...																															
...																															
...																															
...																															
...																															
...																															

WordCount (1 byte): This field MUST be 0x0C.

Words (24 bytes):

0	1	2	3	4	5	6	7	8	9	10	11	12	13	14	15	16	17	18	19	20	21	22	23	24	25	26	27	28	29	30	31
AndXCommand										AndXReserved										AndXOffset											
Available										DataCompactionMode																					
Reserved1										DataLength																					
DataOffset										Reserved2																					
...																															
...																															

AndXCommand (1 byte): The command code for the next SMB command in the packet. This value MUST be set to [SMB_COM_NO_ANDX_COMMAND \(section 2.2.4.75\)](#) (0xFF) if there are no additional SMB command responses in the server response packet. <58>

AndXReserved (1 byte): A reserved field. This MUST be set to 0x00 when this response is sent, and the client MUST ignore this field.

AndXOffset (2 bytes): This field MUST be set to the offset in bytes from the start of the [SMB Header \(section 2.2.3.1\)](#) to the start of the **WordCount** field in the next SMB command response in this packet. This field is valid only if the **AndXCommand** field is not set to SMB_COM_NO_ANDX_COMMAND (0xFF). If **AndXCommand** is SMB_COM_NO_ANDX_COMMAND, this field MUST be ignored by the client. <59>

Available (2 bytes): This field is valid when reading from named pipes. This field indicates the number of bytes remaining to be read after the requested read was completed.

DataCompactionMode (2 bytes): Reserved and SHOULD be 0x0000.

Reserved1 (2 bytes): This field MUST be 0x0000.

DataLength (2 bytes): The number of data bytes included in the response. If this value is less than the value in the **Request.SMB_Parameters.MaxCountOfBytesToReturn** field, it indicates that the read operation has reached the end of the file (EOF).

DataOffset (2 bytes): The offset in bytes from the header of the read data.

Reserved2 (10 bytes): Reserved. All entries MUST be 0x0000. The last 5 words are reserved in order to make the SMB_COM_READ_ANDX Response (section 2.2.4.42.2) the same size as the [SMB_COM_WRITE_ANDX Response \(section 2.2.4.43.2\)](#).

SMB_Data (variable):

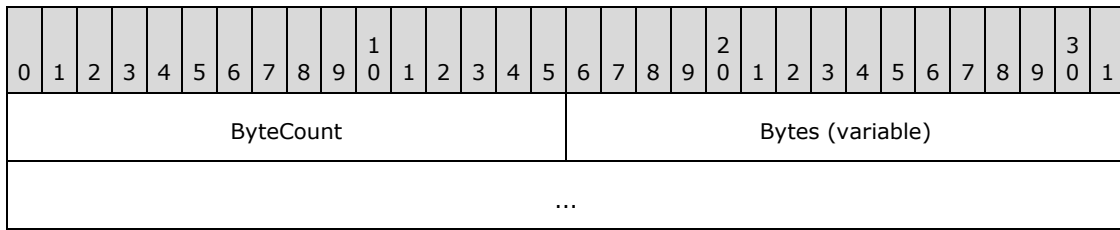

ByteCount (2 bytes): This field MUST be greater than or equal to 0x0000.

Bytes (variable):

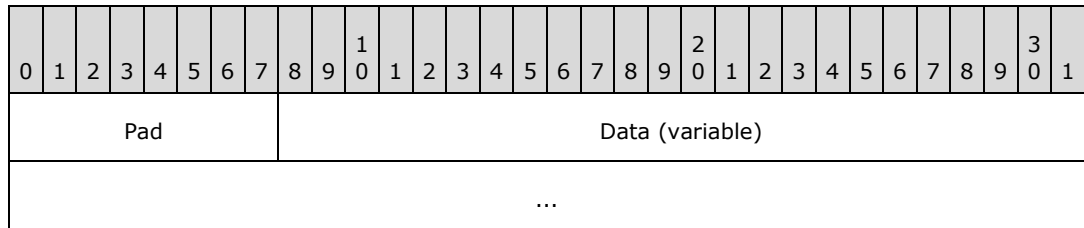

Pad (1 byte): This field is optional. When using the NT LAN Manager dialect, this field can be used to align the **Data** field to a 16-bit boundary relative to the start of the SMB Header. If **Unicode strings** are being used, this field MUST be present. When used, this field MUST be one padding byte long.

Data (variable): The actual bytes read in response to the request.

Error Codes

SMB error class	SMB error code	NT status code	POSIX equivalent	Description
ERRDOS (0x01)	ERRnoaccess (0x0005)	STATUS_ALREADY_COMMITTED (0xC0000021)	ENOLCK	Attempt to read from a portion of the file that the server detects has been locked or been opened in deny-read.
ERRDOS (0x01)	ERRbadfid (0x0006)	STATUS_INVALID_HANDLE (0xC0000008) STATUS_SMB_BAD_FID (0x00060001)	ENFILE	Attempt to read from a FID that the server does not have open.
ERRDOS (0x01)	ERRnomem (0x0008)	STATUS_INSUFF_SERVER_RESOURCES (0xC0000205)	ENOMEM	The server is out of resources.
ERRDOS (0x01)	ERRbadaccess (0x000C)	STATUS_ACCESS_DENIED (0xC0000022)		Invalid open mode for the attempted operation.
ERRDOS (0x01)	ERRlock (0x0021)	STATUS_FILE_LOCK_CONFLICT (0xC0000054)	EAGAIN	The requested byte range was

SMB error class	SMB error code	NT status code	POSIX equivalent	Description
		STATUS_LOCK_NOT_GRANTED (0xC0000055)		already locked by a different process (PID).
ERRDOS (0x01)	ERReof (0x0026)	STATUS_END_OF_FILE (0xC0000011)		Attempted to read beyond the end of the file. <60>
ERRDOS (0x01)	ERRpipebusy (0x00E7)	STATUS_PIPE_BUSY (0xC00000AE)	EAGAIN	Attempted to read from a busy pipe.
ERRDOS (0x01)	ERRpipeclosing (0x00E8)	STATUS_PIPE_EMPTY (0xC00000D9)		Attempted to read from an empty pipe.
ERRDOS (0x01)	ERRmoredata (0x00EA)	STATUS_BUFFER_OVERFLOW (0x80000005)		The message on a message mode named pipe exceeds the requested number of bytes. The server MUST send a full SMB_COM_READ response with this error code. The requested number of bytes are read and returned to the client.
ERRSRV (0x02)	ERRerror (0x0001)		EBADF	The FID was validated by the server but unacceptable to the system.
ERRSRV (0x02)	ERRerror (0x0001)		EDEADLK	The read would block and deadlock would result.
ERRSRV (0x02)	ERRerror (0x0001)	STATUS_INVALID_SMB (0x00010002)		A corrupt request has been encountered.
ERRSRV (0x02)	ERRinvdevice (0x0007)	STATUS_BAD_DEVICE_TYPE (0xC00000CB)		Attempt to read from an open spool file.
ERRSRV (0x02)	ERRinvtid (0x0005)	STATUS_SMB_BAD_TID (0x00050002)		Invalid TID in request.
ERRSRV (0x02)	ERRtimeout (0x0058)			The requested operation on a

SMB error class	SMB error code	NT status code	POSIX equivalent	Description
				named pipe or an I/O device has timed out.
ERRSRV (0x02)	ERRbaduid (0x005B)	STATUS_SMB_BAD_UID (0x005B0002)		The UID specified is not defined as a valid ID for this session, or the user identified by the UID does not have sufficient privileges.
ERRHRD (0x03)	ERRdata (0x0017)	STATUS_DATA_ERROR (0xC000003E)	EIO	A problem has occurred in the physical I/O.
ERRHRD (0x03)	ERRread (0x001E)		ENXIO	The device associated with the file descriptor is a block-special or character-special file and the value of the file pointer is out of range.

2.2.4.43 SMB_COM_WRITE_ANDX (0x2F)

This command was introduced in the **LAN Manager 1.0** dialect.

This request is used to write bytes to a regular file, a named pipe, or a directly accessible I/O device such as a serial port (COM) or printer port (LPT). If the client negotiates the NT LAN Manager dialect or later the client SHOULD use the 14-parameter word version of the request, as this version allows specification of 64-bit file offsets. This is the only write command that supports 64-bit file offsets.

The following are the commands that can follow an SMB_COM_WRITE_ANDX in an AndX chain:

- [SMB_COM_READ \(section 2.2.4.11\)](#)
- [SMB_COM_READ_ANDX \(section 2.2.4.42\)](#)
- [SMB_COM_LOCK_AND_READ \(section 2.2.4.20\)](#)
- [SMB_COM_CLOSE \(section 2.2.4.5\)](#)

2.2.4.43.1 Request

```
SMB_Parameters
{
  UCHAR  WordCount;
  Words
  {
    UCHAR  AndXCommand;
```

```

    UCHAR  AndXReserved;
    USHORT AndXOffset;
    USHORT FID;
    ULONG  Offset;
    ULONG  Timeout;
    USHORT WriteMode;
    USHORT Remaining;
    USHORT Reserved;
    USHORT DataLength;
    USHORT DataOffset;
    ULONG  OffsetHigh (optional);
}
}
SMB_Data
{
    USHORT ByteCount;
    Bytes
    {
        UCHAR Pad;
        UCHAR Data[DataLength];
    }
}

```

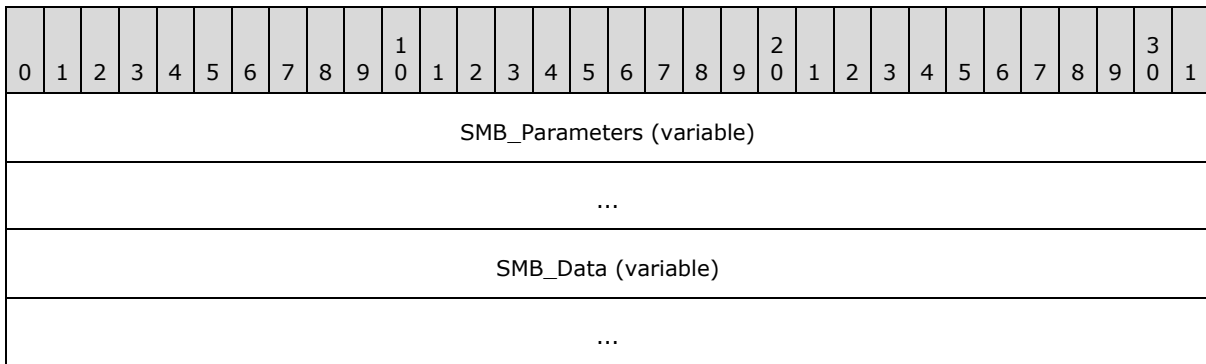

SMB_Parameters (variable):

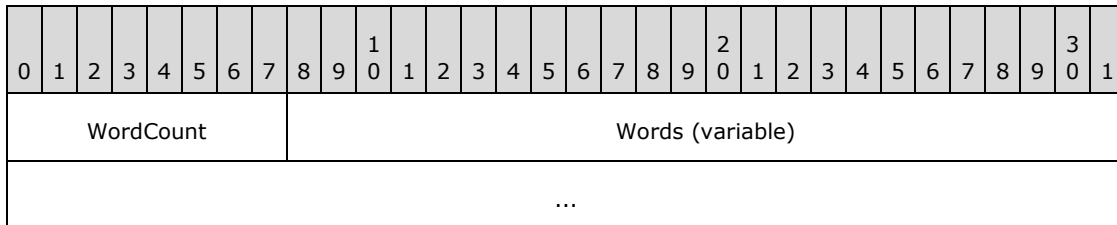

WordCount (1 byte): This field MUST be either 0x0C or 0x0E.

Words (variable):

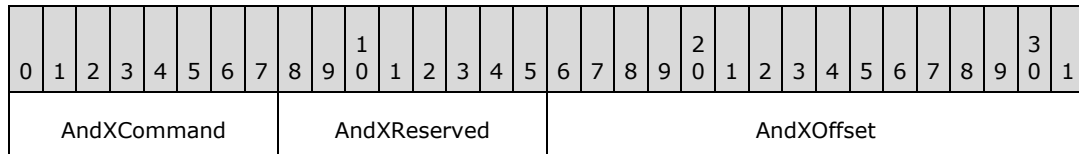

FID	Offset
...	Timeout
...	WriteMode
Remaining	Reserved
DataLength	DataOffset
OffsetHigh	

AndXCommand (1 byte): The command code for the next SMB command in the packet. This value MUST be set to 0xFF if there are no additional SMB commands in the client request packet.

AndXReserved (1 byte): A reserved field. This MUST be set to 0x00 when this request is sent, and the server MUST ignore this value when the message is received.

AndXOffset (2 bytes): This field MUST be set to the offset in bytes from the start of the [SMB Header \(section 2.2.3.1\)](#) to the start of the **WordCount** field in the next SMB command in this packet. This field is valid only if the AndXCommand field is not set to 0xFF. If AndXCommand is 0xFF, this field MUST be ignored by the server.

FID (2 bytes): This field MUST be a valid FID indicating the file to which the data SHOULD be written.

Offset (4 bytes): If **WordCount** is 0x0C, this field represents a 32-bit offset, measured in bytes, of where the write SHOULD start relative to the beginning of the file. If **WordCount** is 0xE, this field represents the lower 32 bits of a 64-bit offset.

Timeout (4 bytes): This field is the time-out, in milliseconds, to wait for the write to complete. This field is used only when writing to a named pipe or an I/O device. It does not apply and MUST be 0x00000000 when writing to a regular file.

WriteMode (2 bytes): A 16-bit field containing flags defined as follows:

Name and bitmask	Meaning
WritethroughMode 0x0001	If set the server MUST NOT respond to the client before the data is written to disk (write-through).
ReadBytesAvailable 0x0002	If set the server SHOULD set the Response.SMB_Parameters.Available field correctly for writes to named pipes or I/O devices.
RAW_MODE 0x0004	Applicable to named pipes only. If set, the named pipe MUST be written to in raw mode (no translation).
MSG_START 0x0008	Applicable to named pipes only. If set, this data is the start of a message.

Remaining (2 bytes): This field is an advisory field telling the server approximately how many bytes are to be written to this file before the next non-write operation. It SHOULD include the number of bytes to be written by this request. The server MAY either ignore this field or use it to perform optimizations. If a pipe write spans multiple requests, the client SHOULD set this field to the number of bytes remaining to be written. <61>

Reserved (2 bytes): This field MUST be 0x0000.

DataLength (2 bytes): This field is the number of bytes included in the **SMB_Data** that are to be written to the file.

DataOffset (2 bytes): The offset in bytes from the start of the SMB Header (section 2.2.3.1) to the start of the data that is to be written to the file. The offset is relative to the start of the SMB Header (section 2.2.3.1), regardless of the command request's position in an AndX chain. Specifying this offset allows a client to efficiently align the data buffer.

The **DataOffset** field can be used to relocate the **SMB_Data.Bytes.Data** block to the end of the message, even if the message is a multi-part AndX chain. If the **SMB_Data.Bytes.Data** block is relocated, the contents of **SMB_Data.Bytes** will not be contiguous.

Consider, for example, an SMB_COM_WRITE_ANDX + SMB_COM_CLOSE AndX chain. The client can specify a value for **SMB_Parameters.Words.DataOffset** that relocates the **SMB_Data.Bytes.Data** block to the end of the message, beyond the SMB_COM_CLOSE, even though the **Data** block is part of the SMB_COM_WRITE_ANDX request. In this case, the message would be structured as follows:

- The SMB Header (section 2.2.3.1), with a command code of SMB_COM_WRITE_ANDX.
- The complete **SMB_Parameters** block of the SMB_COM_WRITE_ANDX.
- The **SMB_Data** block of the SMB_COM_WRITE_ANDX:
 - The value of **SMB_Data.ByteCount** is equal to 1 + **SMB_Parameters.Words.DataLength**. The additional 1 byte is to account for the **SMB_Data.Bytes.Pad** byte.
 - The **SMB_Data.Bytes.Pad** byte.
 - The **SMB_Data.Bytes.Data** block is not included because it has been relocated.
- The **SMB_Parameters** block of the SMB_COM_CLOSE follows immediately after the **SMB_Data.Bytes.Pad** byte of the SMB_COM_WRITE_ANDX. The location of the **SMB_Parameters** block of the SMB_COM_CLOSE, relative to the start of the SMB Header (section 2.2.3.1), is specified by the offset given in the **SMB_Parameters.AndXOffset** field of the SMB_COM_WRITE_ANDX portion of the message.
- The **SMB_Data** block of the SMB_COM_CLOSE (consisting of a **ByteCount** of 0x0000).
- Optional padding follows the **SMB_Data** block of the SMB_COM_CLOSE. If present, the padding is used to align the **SMB_Data.Bytes.Data** block to a 16- or 32-bit boundary.
- The **SMB_Data.Bytes.Data** block, which is **SMB_Parameters.Words.DataLength** bytes in length. The location of the **SMB_Data.Bytes.Data** block within the message, relative to the start of the SMB Header (section 2.2.3.1), is indicated by the

SMB_Parameters.Words.DataOffset field in the SMB_COM_WRITE_ANDX portion of the request.

OffsetHigh (4 bytes): This field is optional. If **WordCount** is 0x0C, this field is not included in the request. If **WordCount** is 0x0E, this field represents the upper 32 bits of a 64-bit offset, measured in bytes, of where the write SHOULD start relative to the beginning of the file.

SMB_Data (variable):

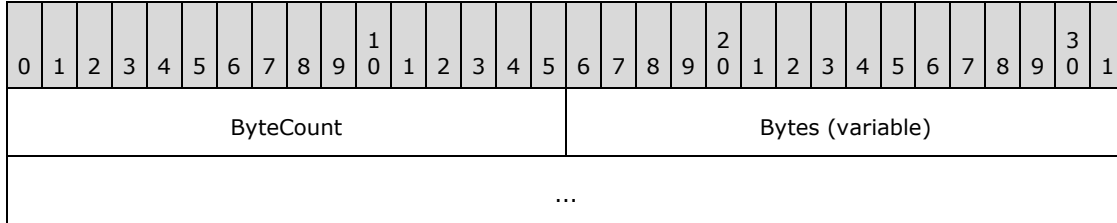

ByteCount (2 bytes): This field MUST be greater than or equal to 0x0001.

Bytes (variable):

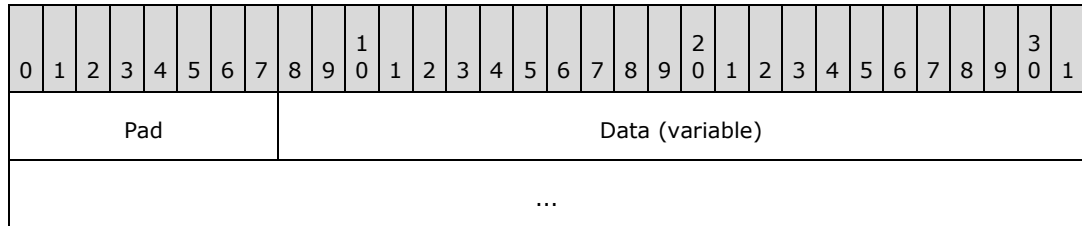

Pad (1 byte): Padding byte that MUST be ignored.

Data (variable): The bytes to be written to the file.

2.2.4.43.2 Response

```

SMB_Parameters
{
    UCHAR    WordCount;
    Words
    {
        UCHAR    AndXCommand;
        UCHAR    AndXReserved;
        USHORT   AndXOffset;
        USHORT   Count;
        USHORT   Available;

        ULONG    Reserved;
    }
}
SMB_Data
{
    USHORT   ByteCount;
}

```

0	1	2	3	4	5	6	7	8	9	10	11	12	13	14	15	16	17	18	19	20	21	22	23	24	25	26	27	28	29	30	31
SMB_Parameters																															
...																															
...																															
...																SMB_Data (variable)															
...																															

SMB_Parameters (13 bytes):

0	1	2	3	4	5	6	7	8	9	10	11	12	13	14	15	16	17	18	19	20	21	22	23	24	25	26	27	28	29	30	31
WordCount										Words																					
...																															
...																															
...																															

WordCount (1 byte): This field MUST be 0x06. The length in two-byte words of the remaining SMB_Parameters.

Words (12 bytes):

0	1	2	3	4	5	6	7	8	9	10	11	12	13	14	15	16	17	18	19	20	21	22	23	24	25	26	27	28	29	30	31
AndXCommand										AndXReserved										AndXOffset											
Count																Available															
Reserved																															

AndXCommand (1 byte): The command code for the next SMB command in the packet. This value MUST be set to 0xFF if there are no additional SMB command responses in the server response packet.

AndXReserved (1 byte): A reserved field. This MUST be set to 0x00 when this response is sent, and the client MUST ignore this field.

AndXOffset (2 bytes): This field MUST be set to the offset in bytes from the start of the [SMB Header \(section 2.2.3.1\)](#) to the start of the **WordCount** field in the next SMB command response in

this packet. This field is valid only if the **AndXCommand** field is not set to 0xFF. If **AndXCommand** is 0xFF, this field MUST be ignored by the client.

Count (2 bytes): The number of bytes written to the file.

Available (2 bytes): This field is valid when writing to named pipes or I/O devices. This field indicates the number of bytes remaining to be written after the requested write was completed. If the client wrote to a disk file, this field MUST be set to 0xFFFF. <62>

Reserved (4 bytes): This field MUST be 0x00000000.

SMB_Data (variable):

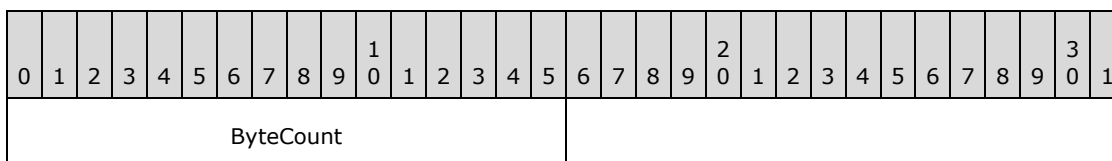

ByteCount (2 bytes): This field MUST be 0x0000. No data is sent by this message.

Error Codes

SMB error class	SMB error code	NT status code	POSIX equivalent	Description
SUCCESS (0x00)	SUCCESS (0x0000)	STATUS_SUCCESS (0x00000000)	EFBIG	The file has grown too large and no more data can be written to the file. A Count of zero (0x0000) MUST be returned to the client in the server response. This indicates to the client that the file system is full.
SUCCESS (0x00)	SUCCESS (0x0000)	STATUS_SUCCESS (0x00000000)	NOSPC	No space on the file system. The server MUST return a zero (0x0000) in the Count field of the response. This indicates that the file system is full.
ERRDOS	ERRnoaccess		EAGAIN	Resources for

SMB error class	SMB error code	NT status code	POSIX equivalent	Description
(0x01)	(0x0005)			I/O on the server are temporarily exhausted.
ERRDOS (0x01)	ERRlock (0x0021)	STATUS_FILE_LOCK_CONFLICT (0xC0000054)	ENOLCK	A record lock has been taken on the file or the client has attempted to write to a portion of the file that the server detects has been locked.
ERRDOS (0x01)	ERRbadfid (0x0006)	STATUS_INVALID_HANDLE (0xC0000008) STATUS_SMB_BAD_FID (0x00060001)	ENFILE	Invalid FID, or FID mapped to a valid server FID but it was not acceptable to the operating system.
ERRDOS (0x01)	ERRnomem (0x0008)	STATUS_INSUFF_SERVER_RESOURCES (0xC0000205)	ENOMEM	The server is out of resources.
ERRDOS (0x01)	ERRbadaccess (0x000C)	STATUS_ACCESS_DENIED (0xC0000022)		Write permission required.
ERRDOS (0x01)	ERRlock (0x0021)	STATUS_FILE_LOCK_CONFLICT (0xC0000054)		The requested byte range was already locked by a different process (PID).
ERRDOS (0x01)	ERRpipebusy (0x00E7)	STATUS_PIPE_BUSY (0xC00000AE)	EAGAIN	Attempted to read from a busy pipe.
ERRDOS (0x01)	ERRnotconnected (0x00E9)	STATUS_PIPE_DISCONNECTED (0xC00000B0)	EPIPE	Write to a named pipe with no reader.
ERRSRV (0x02)	ERRerror (0x0001)		EDEADLK	The write would block due to locking and deadlock would result.
ERRSRV	ERRerror		ERANGE	Attempted write size is

SMB error class	SMB error code	NT status code	POSIX equivalent	Description
(0x02)	(0x0001)			outside of the minimum or maximum ranges that can be written to the supplied FID.
ERRSRV (0x02)	ERRerror (0x0001)	STATUS_INVALID_SMB (0x00010002)		A corrupt or invalid SMB request was received.
ERRSRV (0x02)	ERRinvtid (0x0005)	STATUS_SMB_BAD_TID (0x00050002)		Invalid TID in request.
ERRSRV (0x02)	ERRqfull (0x0031)	STATUS_PRINT_QUEUE_FULL (0xC00000C6)		Print queue is full--too many queued items.
ERRSRV (0x02)	ERRqtoobig (0x0032)	STATUS_NO_SPOOL_SPACE (0xC00000C7)		Print queue is full--too many queued items.
ERRSRV (0x02)	ERRbaduid (0x005B)	STATUS_SMB_BAD_UID (0x005B0002)		The UID specified is not known as a valid ID on this server session, or the user identified by the UID does not have sufficient privileges.
ERRHRD (0x03)	ERRdata (0x0017)	STATUS_DATA_ERROR (0xC000003E)	EIO	A problem has occurred in the physical I/O.
ERRHRD (0x03)	ERRwrite (0x001D)		ENXIO	The device associated with the file descriptor is a block-special or character-special file and the value of the file pointer is out of range.
ERRHRD (0x03)	ERRdiskfull (0x0027)	STATUS_DISK_FULL (0xC000007F)	ENOSPC	The file system is full.

2.2.4.44 SMB_COM_NEW_FILE_SIZE (0x30)

This command was **reserved but not implemented**. It was also never defined. It is listed in [\[SNIA\]](#), but it is not defined in that document and does not appear in any other references.

Clients SHOULD NOT send requests using this command code, and servers receiving requests with this command code SHOULD return STATUS_NOT_IMPLEMENTED (ERRDOC/ERRbadfunc). [<63>](#)

2.2.4.45 SMB_COM_CLOSE_AND_TREE_DISC (0x31)

This command was introduced in the NT LAN Manager dialect, and was **reserved but not implemented**.

Clients SHOULD NOT send requests using this command code. Servers receiving requests with this command code SHOULD return STATUS_NOT_IMPLEMENTED (ERRDOS/ERRbadfunc). [<64>](#)

2.2.4.46 SMB_COM_TRANSACTION2 (0x32)

This command was introduced in the **LAN Manager 1.2** dialect.

SMB_COM_TRANSACTION2 subcommands provide support for a richer set of server-side file system semantics. The "Trans2 subcommands", as they are called, allow clients to set and retrieve Extended Attribute key/value pairs, make use of long file names (longer than the original 8.3 format names), and perform directory searches, among other tasks.

The client indicates that it has not sent all of the **Data** bytes by setting **DataCount** to a value less than **TotalDataCount**. Similarly, if **ParameterCount** is less than **TotalParameterCount**, then the client has more **Parameter** bytes to send. **Parameter** bytes SHOULD be sent before **Data** bytes, and clients SHOULD attempt to send as many bytes as possible in each message. Servers SHOULD be prepared, however, to accept **Parameters** and **Data** in any order, in large or small amounts.

For both the request and the response, the positions and lengths of the **SMB_Data.Trans2_Parameters** and **SMB_Data.Trans2_Data** fields are determined by the values of the **SMB_Parameters.ParameterOffset**, **SMB_Parameters.ParameterCount**, **SMB_Parameters.DataOffset**, and **SMB_Parameters.DataCount** fields. In addition, the **SMB_Parameters.ParameterDisplacement** and **SMB_Parameters.DataDisplacement** fields can be used to change the order in which subranges of bytes are transferred. Servers SHOULD transfer bytes in order and give precedence to **SMB_Data.Trans2_Parameters** bytes. Clients SHOULD be prepared to reconstruct transaction **SMB_Data.Trans2_Parameters** and **SMB_Data.Trans2_Data**, regardless of the order or locations in which they are delivered.

2.2.4.46.1 Request

The SMB_COM_TRANSACTION2 request format is identical to that of the SMB_COM_TRANSACTION request. The differences are in the subcommands supported, and in the purposes and usages of some of the fields.

```
SMB_Parameters
{
    UCHAR    WordCount;
    Words
    {
        USHORT TotalParameterCount;
        USHORT TotalDataCount;
        USHORT MaxParameterCount;
        USHORT MaxDataCount;
    }
}
```

```

    UCHAR   MaxSetupCount;
    UCHAR   Reserved1;
    USHORT  Flags;
    ULONG   Timeout;
    USHORT  Reserved2;
    USHORT  ParameterCount;
    USHORT  ParameterOffset;
    USHORT  DataCount;
    USHORT  DataOffset;
    UCHAR   SetupCount;
    UCHAR   Reserved3;
    USHORT  Setup[SetupCount];
}
}
SMB_Data
{
    USHORT  ByteCount;
    Bytes
    {
        SMB_STRING Name;
        UCHAR   Pad1[];
        UCHAR   Trans2_Parameters[ParameterCount];
        UCHAR   Pad2[];
        UCHAR   Trans2_Data[DataCount];
    }
}

```

SMB_Header:

The **Command** for the initial request and for all responses MUST be SMB_COM_TRANSACTION2 (0x32). The **Command** for secondary request messages that are part of the same transaction MUST be SMB_COM_TRANSACTION2_SECONDARY (0x33). The **PID**, **MID**, **TID**, and **UID** MUST be the same for all requests and responses that are part of the same transaction.

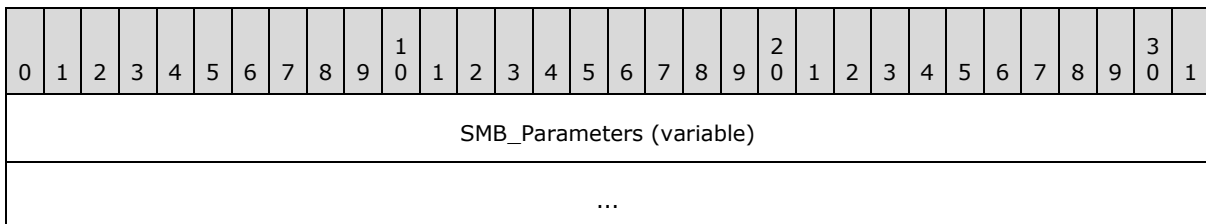

SMB_Parameters (variable):

The SMB_Parameters section of the SMB_COM_TRANSACTION2 request contains the information used to manage the transaction itself. It also contains flags and setup information that provide context for the execution of the operation on the server side.

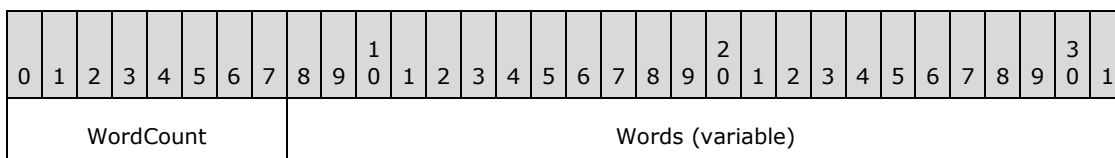

...
SMB_Data (variable)
...

WordCount (1 byte): The value of **Words.SetupCount** plus 14 (0x0E). This value represents the total number of SMB parameter words and MUST be greater than or equal to 14 (0x0E).

Words (variable):

0	1	2	3	4	5	6	7	8	9	10	11	12	13	14	15	16	17	18	19	20	21	22	23	24	25	26	27	28	29	30	31
TotalParameterCount														TotalDataCount																	
MaxParameterCount														MaxDataCount																	
MaxSetupCount							Reserved1							Flags																	
Timeout																															
Reserved2														ParameterCount																	
ParameterOffset														DataCount																	
DataOffset														SetupCount							Reserved3										
Setup (variable)																															
...																															

TotalParameterCount (2 bytes): The total number of SMB_COM_TRANSACTION2 parameter bytes to be sent in this transaction request. This value MAY be reduced in any or all subsequent SMB_COM_TRANSACTION2_SECONDARY requests that are part of the same transaction. This value represents transaction parameter bytes, not SMB parameter words. Transaction parameter bytes are carried in the SMB_Data block of the SMB_COM_TRANSACTION2 request.

TotalDataCount (2 bytes): The total number of SMB_COM_TRANSACTION2 data bytes to be sent in this transaction request. This value MAY be reduced in any or all subsequent SMB_COM_TRANSACTION2_SECONDARY requests that are part of the same transaction. This value represents transaction data bytes, not SMB data bytes.

MaxParameterCount (2 bytes): The maximum number of parameter bytes that the client will accept in the transaction reply. The server MUST NOT return more than this number of parameter bytes.

MaxDataCount (2 bytes): The maximum number of data bytes that the client will accept in the transaction reply. The server MUST NOT return more than this number of data bytes.

MaxSetupCount (1 byte): The maximum number of setup bytes that the client will accept in the transaction reply. The server MUST NOT return more than this number of setup bytes.

Reserved1 (1 byte): A padding byte. This field MUST be zero. Existing CIFS implementations MAY combine this field with **MaxSetupCount** to form a USHORT. If **MaxSetupCount** is defined as a USHORT, the high order byte MUST be 0x00.

Flags (2 bytes): A set of bit flags that alter the behavior of the requested operation. Unused bit fields MUST be set to zero by the client sending the request, and MUST be ignored by the server receiving the request. The client MAY set either or both of the following bit flags:

Name and bitmask	Meaning
DISCONNECT_TID 0x0001	If set, following the completion of the operation the server MUST disconnect the tree connect associated with the tree identifier (TID) field received in the SMB Header (section 2.2.3.1) of this request. The client SHOULD NOT send a subsequent SMB_COM_TREE_DISCONNECT for this tree connect.
NO_RESPONSE 0x0002	This is a one-way transaction. The server MUST attempt to complete the transaction, but SHOULD NOT send a response to the client. <65>

Timeout (4 bytes): The number of milliseconds that the server waits for completion of the transaction before generating a time-out. A value of 0x00000000 indicates that the operation is not blocked. [<66>](#)

Reserved2 (2 bytes): Reserved. This field MUST be 0x0000 in the client request. The server MUST ignore the contents of this field.

ParameterCount (2 bytes): The number of transaction parameter bytes being sent in this SMB message. If the transaction fits within a single SMB_COM_TRANSACTION2 request, then this value MUST be equal to **TotalParameterCount**. Otherwise, the sum of the **ParameterCount** values in the primary and secondary transaction request messages MUST be equal to the smallest **TotalParameterCount** value reported to the server. If the value of this field is less than the value of **TotalParameterCount**, then at least one SMB_COM_TRANSACTION2_SECONDARY message MUST be used to transfer the remaining parameter bytes. The **ParameterCount** field MUST be used to determine the number of transaction parameter bytes contained within the SMB_COM_TRANSACTION2 message.

ParameterOffset (2 bytes): The offset, in bytes, from the start of the SMB_Header to the transaction parameter bytes. This MUST be the number of bytes from the start of the SMB message to the start of the **SMB_Data.Bytes.Parameters** field. Server implementations MUST use this value to locate the transaction parameter block within the SMB message. If **ParameterCount** is zero, the client/server MAY set this field to zero. [<67>](#)

DataCount (2 bytes): The number of transaction data bytes being sent in this SMB message. If the transaction fits within a single SMB_COM_TRANSACTION2 request, then this value MUST be equal to **TotalDataCount**. Otherwise, the sum of the **DataCount** values in the primary and secondary transaction request messages MUST be equal to the smallest **TotalDataCount** value reported to the server. If the value of this field is less than the value of **TotalDataCount**, then at least one SMB_COM_TRANSACTION2_SECONDARY message MUST be used to transfer the remaining data bytes.

DataOffset (2 bytes): The offset, in bytes, from the start of the SMB Header (section 2.2.3.1) to the transaction data bytes. This MUST be the number of bytes from the start of the SMB message to the start of the **SMB_Data.Bytes.Data** field. Server implementations MUST use this value to locate the transaction data block within the SMB message. If **DataCount** is zero, the client/server MAY set this field to zero. <68>

SetupCount (1 byte): The number of setup words that are included in the transaction request.

Reserved3 (1 byte): A padding byte. This field MUST be 0x00. Existing CIFS implementations MAY combine this field with **SetupCount** to form a USHORT. If **SetupCount** is defined as a USHORT, the high order byte MUST be 0x00.

Setup (variable): An array of two-byte words that provide transaction context to the server. The size and content of the array are specific to individual subcommands. SMB_COM_TRANSACTION2 messages MAY exceed the maximum size of a single SMB message (as determined by the value of the **MaxBufferSize** session parameter). If this is the case, then the client MUST use one or more SMB_COM_TRANSACTION2_SECONDARY messages to transfer transaction **Data** and **Parameter** bytes that did not fit in the initial message.

SMB_Data (variable):

0	1	2	3	4	5	6	7	8	9	10	11	12	13	14	15	16	17	18	19	20	21	22	23	24	25	26	27	28	29	30	31
ByteCount																Bytes (variable)															
...																															

ByteCount (2 bytes): The number of bytes in the **SMB_Data.Bytes** array.

Bytes (variable): The **Name** field MUST be the first field in this section. The locations and sizes of all other fields, including the padding, are determined by the values of **ParameterOffset**, **ParameterCount**, **DataOffset**, and **DataCount**. The server SHOULD be able to read the **Parameters** and **Data** regardless of their locations within the **SMB_Data** section of the message.

0	1	2	3	4	5	6	7	8	9	10	11	12	13	14	15	16	17	18	19	20	21	22	23	24	25	26	27	28	29	30	31
Name (variable)																															
...																															
Pad1 (variable)																															
...																															
Trans2_Parameters (variable)																															
...																															
Pad2 (variable)																															

...
Trans2_Data (variable)
...

Name (variable): This field is present but not used in SMB_COM_TRANSACTION2 requests. If Unicode support has been negotiated, then this field MUST be aligned to a 16-bit boundary and MUST consist of two terminating null characters. If Unicode support has not been negotiated this field will contain only one terminating null character. The **Name** field MUST be the first field in this section.

Pad1 (variable): This field MUST be used as an array of padding bytes to align the following field to a 4-byte boundary relative to the start of the SMB Header (section 2.2.3.1). This constraint can cause this field to be a zero-length field. This field SHOULD be set to zero by the client/server and MUST be ignored by the server/client.

Trans2_Parameters (variable): Transaction parameter bytes. See the individual SMB_COM_TRANSACTION2 subcommand descriptions for information on parameters sent for each subcommand.

Pad2 (variable): This field MUST be used as an array of padding bytes to align the following field to a 4-byte boundary relative to the start of the SMB Header. This constraint can cause this field to be a zero-length field. This field SHOULD be set to zero by the client/server and MUST be ignored by the server/client.

Trans2_Data (variable): Transaction data bytes. See the individual SMB_COM_TRANSACTION2 subcommand descriptions for information on data sent for each subcommand.

2.2.4.46.2 Response

The SMB_COM_TRANSACTION2 response has two possible formats. The standard format is used to return the results of the completed transaction. A shortened interim response message is sent following the initial SMB_COM_TRANSACTION2 request if secondary request messages (SMB_COM_TRANSACTION2_SECONDARY) are pending. Whenever a transaction request is split across multiple SMB requests, the server MUST evaluate the initial SMB_COM_TRANSACTION2 request to determine whether or not it has the resources necessary to process the transaction. It MUST also check for any other errors it can detect based upon the initial request, and then send back an interim response. The interim response advises the client as to whether it can send the rest of the transaction to the server.

Interim Response

The format of the SMB_COM_TRANSACTION2 Interim Server Response message MUST be an [SMB Header \(section 2.2.3.1\)](#) with an empty **Parameter** and **Data** section, and the **WordCount** and **ByteCount** fields MUST be zero. Error codes MUST be returned in the **SMB_Header.Status** field if errors occur.

```
SMB_Parameters
{
    UCHAR    WordCount;
}
SMB_Data
{
```

```

USHORT ByteCount;
}

```

If no error is returned in the SMB_COM_TRANSACTION2 Interim Server Response, the transaction MAY proceed. The client can send as many SMB_COM_TRANSACTION2_SECONDARY messages as needed in order to transfer the remainder of the transaction subcommand. The server MUST process the transaction and MUST reply with one or more SMB_COM_TRANSACTION2 response messages.

Final Response

```

SMB_Parameters
{
  UCHAR WordCount;
  Words
  {
    USHORT TotalParameterCount;
    USHORT TotalDataCount;
    USHORT Reserved1;
    USHORT ParameterCount;
    USHORT ParameterOffset;
    USHORT ParameterDisplacement;
    USHORT DataCount;
    USHORT DataOffset;
    USHORT DataDisplacement;
    UCHAR SetupCount;
    UCHAR Reserved2;
    USHORT Setup[SetupCount];
  }
}
SMB_Data
{
  USHORT ByteCount;
  Bytes
  {
    UCHAR Pad1[];
    UCHAR Trans2_Parameters[ParameterCount];
    UCHAR Pad2[];
    UCHAR Trans2_Data[DataCount];
  }
}

```

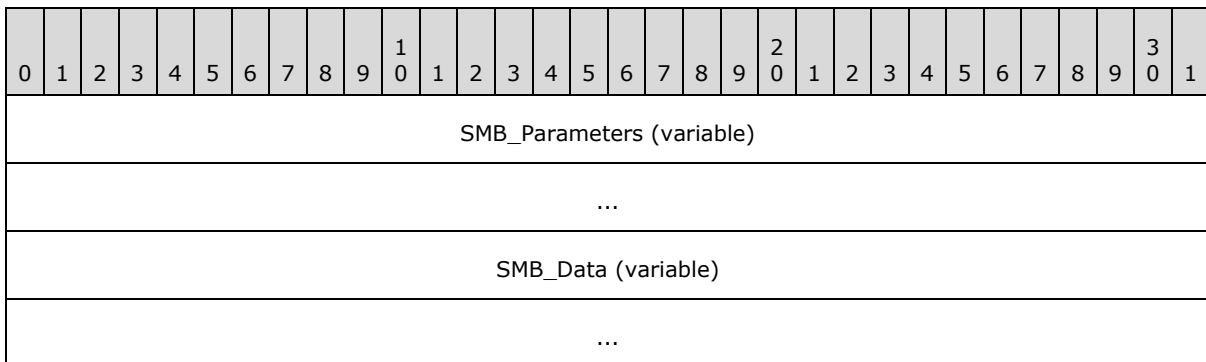

SMB_Parameters (variable):

0	1	2	3	4	5	6	7	8	9	10	11	12	13	14	15	16	17	18	19	20	21	22	23	24	25	26	27	28	29	30	31					
WordCount										Words (variable)																										
...																																				

WordCount (1 byte): The value of **Words.SetupCount** plus 10 (0x0A). This value represents the total number of SMB parameter words and MUST be greater than or equal to 10 (0x0A).

Words (variable):

0	1	2	3	4	5	6	7	8	9	10	11	12	13	14	15	16	17	18	19	20	21	22	23	24	25	26	27	28	29	30	31
TotalParameterCount										TotalDataCount																					
Reserved1										ParameterCount																					
ParameterOffset										ParameterDisplacement																					
DataCount										DataOffset																					
DataDisplacement										SetupCount										Reserved2											
Setup (variable)																															
...																															

TotalParameterCount (2 bytes): The total number of SMB_COM_TRANSACTION2 parameter bytes to be sent in this transaction response. This value can be reduced in any or all subsequent SMB_COM_TRANSACTION2 responses that are part of the same transaction. This value represents transaction parameter bytes, not SMB parameter words. Transaction parameter bytes are carried within in the SMB_data block.

TotalDataCount (2 bytes): The total number of SMB_COM_TRANSACTION2 data bytes to be sent in this transaction response. This value MAY be reduced in any or all subsequent SMB_COM_TRANSACTION2 responses that are part of the same transaction. This value represents transaction data bytes, not SMB data bytes.

Reserved1 (2 bytes): Reserved. This field MUST be 0x0000 in the client request. The server MUST ignore the contents of this field.

ParameterCount (2 bytes): The number of transaction parameter bytes being sent in this SMB message. If the transaction fits within a single SMB_COM_TRANSACTION2 response, this value MUST be equal to **TotalParameterCount**. Otherwise, the sum of the **ParameterCount** values in the transaction response messages MUST be equal to the smallest **TotalParameterCount** value

reported by the server. The **ParameterCount** field MUST be used to determine the number of transaction parameter bytes contained within the SMB message.

ParameterOffset (2 bytes): The offset, in bytes, from the start of the SMB_Header to the transaction parameter bytes. This MUST be the number of bytes from the start of the SMB message to the start of the **SMB_Data.Bytes.Parameters** field. Server implementations MUST use this value to locate the transaction parameter block within the SMB message. If **ParameterCount** is zero, the client/server MAY set this field to zero. <69>

ParameterDisplacement (2 bytes): The offset relative to all of the transaction parameter bytes in this transaction response at which this block of parameter bytes MUST be placed. This value MAY be used by the client to correctly reassemble the transaction parameters even if the SMB response messages are received out of order.

DataCount (2 bytes): The number of transaction data bytes being sent in this SMB message. If the transaction fits within a single SMB_COM_TRANSACTION2 response, then this value MUST be equal to **TotalDataCount**. Otherwise, the sum of the **DataCount** values in the transaction response messages MUST be equal to the smallest **TotalDataCount** value reported by the server.

DataOffset (2 bytes): The offset, in bytes, from the start of the SMB_Header to the transaction data bytes. This MUST be the number of bytes from the start of the SMB message to the start of the **SMB_Data.Bytes.Data** field. Server implementations MUST use this value to locate the transaction data block within the SMB message. If **DataCount** is zero, the client/server MAY set this field to zero. <70>

DataDisplacement (2 bytes): The offset relative to all of the transaction data bytes in this transaction response at which this block of data bytes MUST be placed. This value MAY be used by the client to correctly reassemble the transaction data even if the SMB response messages are received out of order.

SetupCount (1 byte): The number of setup words that are included in the transaction response.

Reserved2 (1 byte): A padding byte. This field MUST be 0x00. If **SetupCount** is defined as a USHORT, the high order byte MUST be 0x00.

Setup (variable): An array of two-byte words that provides transaction results from the server. The size and content of the array are specific to individual subcommands.

SMB_Data (variable):

The SMB_Data section of the SMB_COM_TRANSACTION2 response contains the parameters and data generated by the transaction subcommand.

0	1	2	3	4	5	6	7	8	9	10	11	12	13	14	15	16	17	18	19	20	21	22	23	24	25	26	27	28	29	30	31		
ByteCount										Bytes (variable)																							
...																																	

ByteCount (2 bytes): The number of bytes in the **SMB_Data.Bytes** array, which follows.

Bytes (variable):

0	1	2	3	4	5	6	7	8	9	0	1	2	3	4	5	6	7	8	9	0	1	2	3	4	5	6	7	8	9	0	1
Pad1 (variable)																															
...																															
Trans2_Parameters (variable)																															
...																															
Pad2 (variable)																															
...																															
Trans2_Data (variable)																															
...																															

Pad1 (variable): This field SHOULD be used as an array of padding bytes to align the following field to a 4-byte boundary relative to the start of the SMB Header (section 2.2.3.1). This can cause this field to be a zero-length field. This field SHOULD be set to zero by the client/server and MUST be ignored by the server/client.

Trans2_Parameters (variable): Transaction parameter bytes. See the individual SMB_COM_TRANSACTION2 subcommand descriptions for information on parameters returned by the server for each subcommand.

Pad2 (variable): This field SHOULD be used as an array of padding bytes to align the following field to a 4 byte boundary relative to the start of the SMB Header. This constraint can cause this field to be a zero-length field. This field SHOULD be set to zero by the client/server and MUST be ignored by the server/client.

Trans2_Data (variable): Transaction data bytes. See the individual SMB_COM_TRANSACTION2 subcommand descriptions for information on data returned by the server for each subcommand. [<71>](#)

2.2.4.47 SMB_COM_TRANSACTION2_SECONDARY (0x33)

This command was introduced in the **LAN Manager 1.2** dialect.

The SMB_COM_TRANSACTION2_SECONDARY command is used to complete a data transfer initiated by an SMB_COM_TRANSACTION2 request.

2.2.4.47.1 Request

The SMB_COM_TRANSACTION2_SECONDARY request message differs from the [SMB_COM_TRANSACTION_SECONDARY Request \(section 2.2.4.34.1\)](#) by the addition of the **FID** field in the **SMB_Parameters.Words** section.

SMB_Parameters

```

{
  UCHAR WordCount;
  Words
  {
    USHORT TotalParameterCount;
    USHORT TotalDataCount;
    USHORT ParameterCount;
    USHORT ParameterOffset;
    USHORT ParameterDisplacement;
    USHORT DataCount;
    USHORT DataOffset;
    USHORT DataDisplacement;
    USHORT FID;
  }
}
SMB_Data
{
  USHORT ByteCount;
  Bytes
  {
    UCHAR Pad1[];
    UCHAR Trans2_Parameters[ParameterCount];
    UCHAR Pad2[];
    UCHAR Trans2_Data[DataCount];
  }
}

```

SMB_Header:

This command **MUST** be sent following a successful SMB_COM_TRANSACTION2 Intermediate Response from the server. The **PID**, **MID**, **TID**, and **UID** **MUST** be the same for all requests and responses that are part of the same transaction.

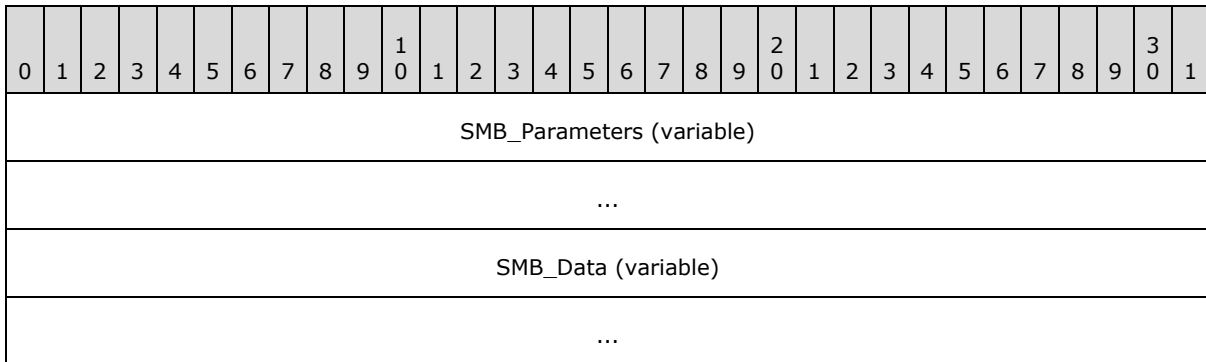

SMB_Parameters (variable):

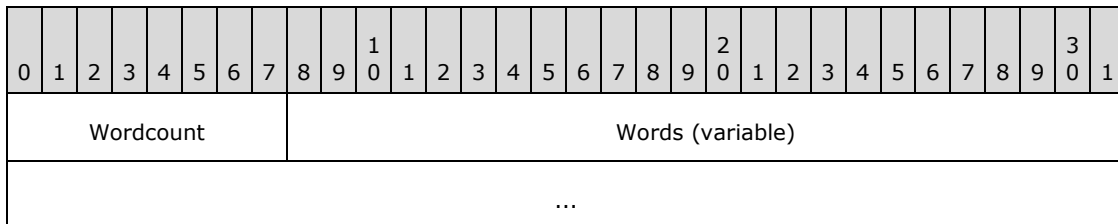

Wordcount (1 byte): This value represents the total number of SMB parameter words and MUST be 0x09.

Words (variable):

0	1	2	3	4	5	6	7	8	9	0	1	2	3	4	5	6	7	8	9	0	1	2	3	4	5	6	7	8	9	0	1		
TotalParameterCount																TotalDataCount																	
ParameterCount																ParameterOffset																	
ParameterDisplacement																DataCount																	
DataOffset																DataDisplacement																	
FID																																	

TotalParameterCount (2 bytes): The total number of transaction parameter bytes to be sent to the server over the course of this transaction. This value MAY be less than or equal to the **TotalParameterCount** in preceding request messages that are part of the same transaction. This value represents transaction parameter bytes, not SMB parameter words.

TotalDataCount (2 bytes): The total number of transaction data bytes to be sent to the server over the course of this transaction. This value MAY be less than or equal to the **TotalDataCount** in preceding request messages that are part of the same transaction. This value represents transaction data bytes, not SMB data bytes.

ParameterCount (2 bytes): The number of transaction parameter bytes being sent in the SMB message. This value MUST be less than **TotalParameterCount**. The sum of the **ParameterCount** values across all of the request messages in a transaction MUST be equal to the **TotalParameterCount** reported in the last request message of the transaction.

ParameterOffset (2 bytes): The offset, in bytes, from the start of the SMB_Header to the transaction parameter bytes contained in this SMB message. This MUST be the number of bytes from the start of the SMB message to the start of the **SMB_Data.Bytes.Trans2_Parameters** field. Server implementations MUST use this value to locate the transaction parameter block within the SMB message. If **ParameterCount** is zero, the client/server MAY set this field to zero. [<72>](#)

ParameterDisplacement (2 bytes): The offset relative to all of the transaction parameter bytes sent to the server in this transaction at which this block of parameter bytes SHOULD be placed. This value can be used by the server to correctly reassemble the transaction parameters even if the SMB request messages are received out of order.

DataCount (2 bytes): The number of transaction data bytes being sent in this SMB message. This value MUST be less than the value of **TotalDataCount**. The sum of the **DataCount** values across all of the request messages in a transaction MUST be equal to the smallest TotalDataCount value reported to the server.

DataOffset (2 bytes): The offset, in bytes, from the start of the SMB_Header to the transaction data bytes contained in this SMB message. This MUST be the number of bytes from the start of the SMB message to the start of the **SMB_Data.Bytes.Trans2_Data** field. Server implementations MUST use this value to locate the transaction data block within the SMB message. If **DataCount** is zero, the client/server MAY set this field to zero. [<73>](#)

DataDisplacement (2 bytes): The offset relative to all of the transaction data bytes sent to the server in this transaction at which this block of parameter bytes SHOULD be placed. This value MAY be used by the server to correctly reassemble the transaction data block even if the SMB request messages are received out of order.

FID (2 bytes): Either a valid File ID returned by a previous Open or Create operation, or 0xFFFF. A **FID** value of 0xFFFF is, by definition, an invalid **FID** and indicates that no **FID** is being sent in this request. See the individual descriptions of the Trans2 subcommands for specific information on the use of this field.

SMB_Data (variable):

The SMB_Data section of the SMB_COM_TRANSACTION2_SECONDARY request contains parameters and data bytes being sent to the server.

0	1	2	3	4	5	6	7	8	9	10	11	12	13	14	15	16	17	18	19	20	21	22	23	24	25	26	27	28	29	30	31
ByteCount																Bytes (variable)															
...																															

ByteCount (2 bytes): The number of bytes in the **SMB_Data.Bytes** array, which follows.

Bytes (variable):

0	1	2	3	4	5	6	7	8	9	10	11	12	13	14	15	16	17	18	19	20	21	22	23	24	25	26	27	28	29	30	31
Pad1 (variable)																															
...																															
Trans2_Parameters (variable)																															
...																															
Pad2 (variable)																															
...																															
Trans2_Data (variable)																															
...																															

Pad1 (variable): This field SHOULD be used as an array of padding bytes to align the following field to a 4-byte boundary relative to the start of the [SMB Header \(section 2.2.3.1\)](#). This constraint can cause this field to be a zero-length field. This field SHOULD be set to zero by the client/server and MUST be ignored by the server/client.

Trans2_Parameters (variable): Transaction parameter bytes.

Pad2 (variable): This field SHOULD be used as an array of padding bytes to align the following field to a 4-byte boundary relative to the start of the SMB Header. This constraint can cause this field to be a zero-length field. This field SHOULD be set to zero by the client/server and MUST be ignored by the server/client.

Trans2_Data (variable): Transaction data bytes.

2.2.4.47.2 Response

There is no response message defined for the SMB_COM_TRANSACTION2_SECONDARY request.

Error Codes

Since there is no response to an SMB_COM_TRANSACTION2_SECONDARY request, there are no error codes defined.

2.2.4.48 SMB_COM_FIND_CLOSE2 (0x34)

This command was introduced in the **LAN Manager 1.2** dialect.

The SMB_COM_FIND_CLOSE2 command is used to close a search handle that was created by a TRANS2_FIND_FIRST2 subcommand. Closing the search handle allows the server to release any resources associated with the handle.

2.2.4.48.1 Request

```
SMB_Parameters
{
    UCHAR   WordCount;
    Words
    {
        USHORT SearchHandle;
    }
}
SMB_Data
{
    USHORT ByteCount;
}
```

SMB_Header:

TID (2 bytes): A valid **TID** MUST be provided. The **TID** MUST refer to a connected server share.

UID (2 bytes): A valid **UID** MUST be provided and MUST match the UID used to initiate the directory search.

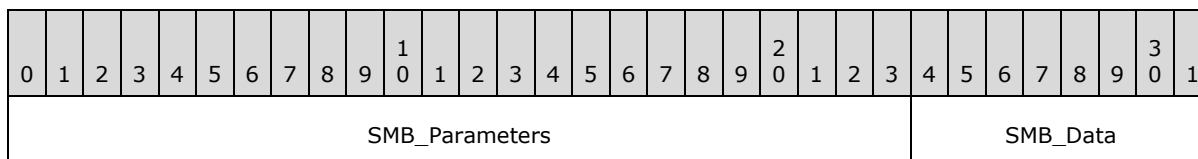

...

SMB_Parameters (3 bytes):

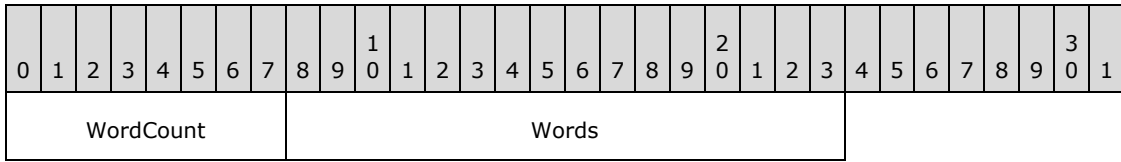

WordCount (1 byte): This field MUST be 0x01.

Words (2 bytes):

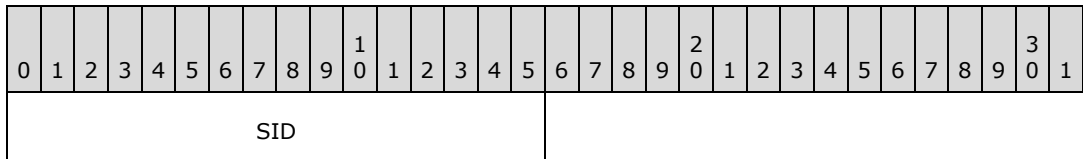

SID (2 bytes): A search handle, also known as a Search ID (SID). This MUST be the **SID** value returned in the initial TRANS2_FIND_FIRST2 subcommand request.

SMB_Data (2 bytes):

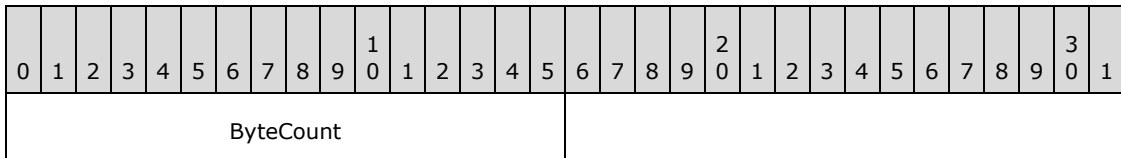

ByteCount (2 bytes): This field MUST be 0x0000. No data is sent by this message.

2.2.4.48.2 Response

```
SMB_Parameters
{
    UCHAR WordCount;
}
SMB_Data
{
    USHORT ByteCount;
}
```

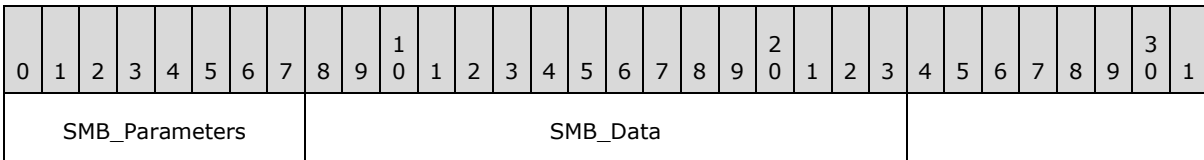

SMB_Parameters (1 byte):

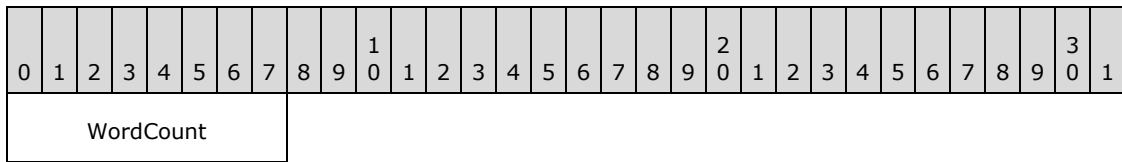

WordCount (1 byte): This field MUST be 0x00. No parameters are sent by this message.

SMB_Data (2 bytes):

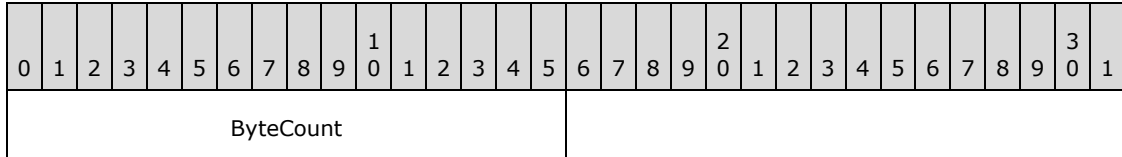

ByteCount (2 bytes): This field MUST be 0x0000. No data is sent by this message.

Error Codes

SMB error class	SMB error code	NT status code	POSIX equivalent	Description
ERRDOS (0x01)	ERRbadfid (0x0006)	STATUS_INVALID_HANDLE (0xC0000008) STATUS_SMB_BAD_FID (0x00060001)	ENFILE	The search handle is invalid.
ERRSRV (0x02)	ERRerror (0x0001)	STATUS_INVALID_SMB (0x00010002)		Invalid or corrupt SMB.
ERRSRV (0x02)	ERRbaduid (0x005B)	STATUS_SMB_BAD_UID (0x005B0002)		The UID supplied is not defined for the session.

2.2.4.49 SMB_COM_FIND_NOTIFY_CLOSE (0x35)

This command was introduced in the **LAN Manager 1.2** dialect (see [XOPEN-SMB] section 15.3), and was **reserved but not implemented**.

This command was intended to close a directory search handle that was created by a TRANS2_FIND_NOTIFY_FIRST subcommand request to the server. The TRANS2_FIND_NOTIFY_FIRST and TRANS2_FIND_NOTIFY_NEXT subcommands were also not implemented.

Clients SHOULD NOT send requests using this command code, and servers receiving requests with this command code MUST return STATUS_NOT_IMPLEMENTED (ERRDOS/ERRbadfunc).

2.2.4.50 SMB_COM_TREE_CONNECT (0x70)

This is an original **Core Protocol** command. **This command has been deprecated.** Client Implementations SHOULD use SMB_COM_TREE_CONNECT_ANDX.

This command is used to establish a client connection to a server share. The share is identified by name, and the connection, once established, is identified by a TID which is returned to the client.

2.2.4.50.1 Request

```

SMB_Parameters
{
    UCHAR    WordCount;
}
SMB_Data
{
    USHORT  ByteCount;
    Bytes
    {
        UCHAR    BufferFormat1;
        OEM_STRING Path;
        UCHAR    BufferFormat2;
        OEM_STRING Password;
        UCHAR    BufferFormat3;
        OEM_STRING Service;
    }
}

```

SMB_Header

Flags2 (2 bytes): The SMB_FLAGS2_UNICODE flag bit SHOULD be zero. Servers MUST ignore the SMB_FLAGS2_UNICODE flag and interpret strings in this request as OEM_STRING strings. [<74>](#)

TID (2 bytes): This field MUST be ignored by the server.

UID (2 bytes): This field represents an authenticated user. If the server is operating in share level access control mode, then the UID is ignored. If the server is operating in user level access control mode, then the server MUST validate the UID.

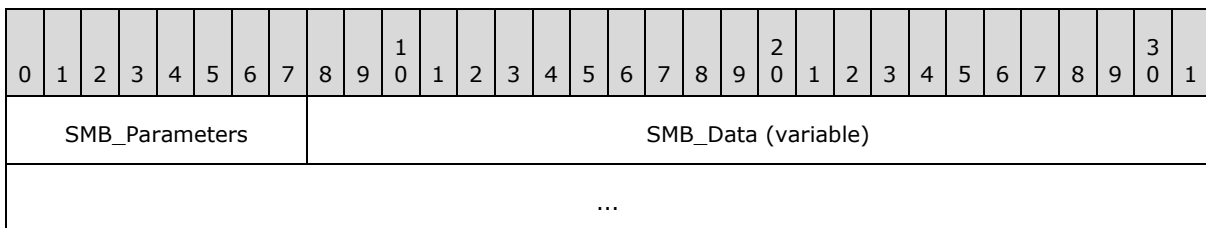

SMB_Parameters (1 byte):

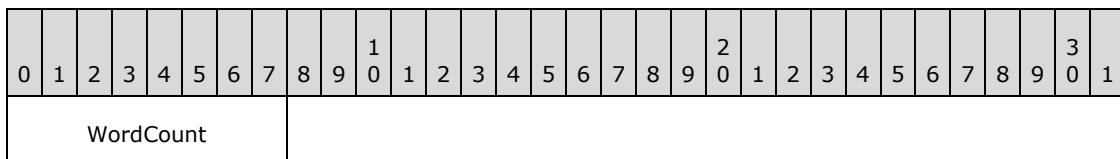

WordCount (1 byte): This field MUST be 0x00. No parameters are sent by this message.

SMB_Data (variable):

0	1	2	3	4	5	6	7	8	9	0	1	2	3	4	5	6	7	8	9	0	1	2	3	4	5	6	7	8	9	0	1		
ByteCount																Bytes (variable)																	
...																																	

ByteCount (2 bytes): This field MUST be greater than or equal to 0x0006.

Bytes (variable):

0	1	2	3	4	5	6	7	8	9	0	1	2	3	4	5	6	7	8	9	0	1	2	3	4	5	6	7	8	9	0	1						
BufferFormat1										Path (variable)																											
...																																					
BufferFormat2										Password (variable)																											
...																																					
BufferFormat3										Service (variable)																											
...																																					

BufferFormat1 (1 byte): A buffer format identifier. The value of this field MUST be 0x04.

Path (variable): A null-terminated string that represents the server and share name of the resource to which the client is attempting to connect. This field MUST be encoded using Universal Naming Convention (UNC) syntax. The string MUST be a null-terminated array of OEM characters, even if the client and server have negotiated to use Unicode strings.

A share path in UNC syntax would be represented by a string in the following form:

```
\\server\share
```

BufferFormat2 (1 byte): A buffer format identifier. The value of this field MUST be 0x04.

Password (variable): A null-terminated string that represents a share password in plaintext form. The string MUST be a null-terminated array of OEM characters, even if the client and server have negotiated to use Unicode strings.

BufferFormat3 (1 byte): A buffer format identifier. The value of this field MUST be 0x04.

Service (variable): A null-terminated string representing the type of resource that the client intends to access. This field MUST be a null-terminated array of OEM characters, even if the client and server have negotiated to use Unicode strings. The valid values for this field are as follows:

Service String	Description
"A:"	Disk Share
"LPT1:"	Printer Share
"IPC"	Named Pipe
"COMM"	Serial Communications device
"?????"	Matches any type of device or resource

2.2.4.50.2 Response

```

SMB_Parameters
{
  UCHAR WordCount;
  Words
  {
    USHORT MaxBufferSize;
    USHORT TID;
  }
}
SMB_Data
{
  USHORT ByteCount;
}

```

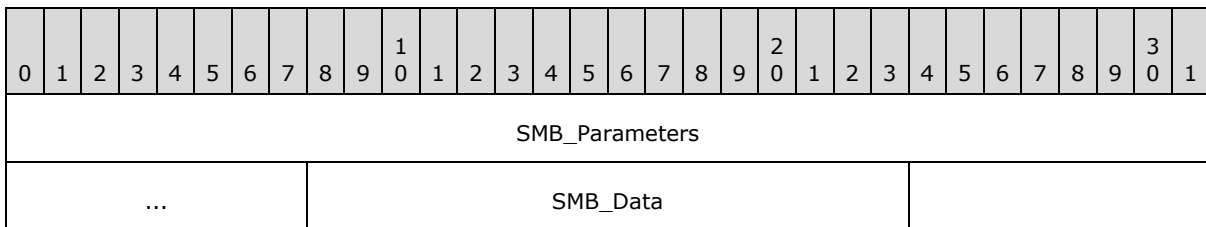

SMB_Parameters (5 bytes):

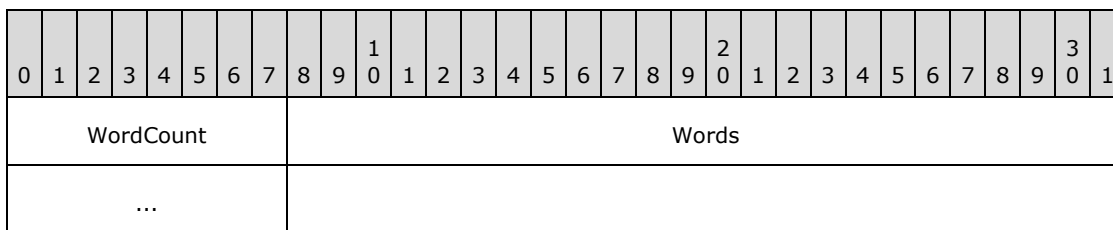

WordCount (1 byte): This field MUST be set to 0x02.

Words (4 bytes):

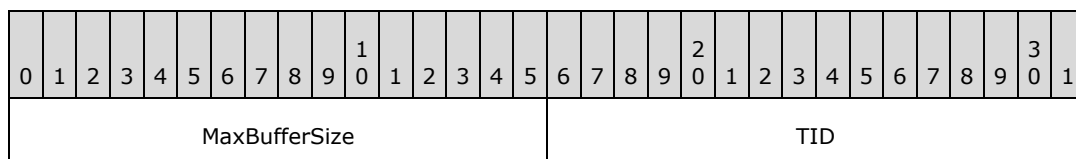

MaxBufferSize (2 bytes): The maximum size, in bytes, of the largest SMB message that the server can receive. This is the size of the largest SMB message that the client can send to the server. SMB message size includes the size of the [SMB Header \(section 2.2.3.1\)](#), parameter, and data blocks. This size MUST NOT include any transport-layer framing or other transport-layer data.

TID (2 bytes): The newly generated Tree ID, used in subsequent CIFS client requests to refer to a resource relative to the **SMB_Data.Bytes.Path** specified in the request. Most access to the server requires a valid **TID**, whether the resource is password protected or not. The value 0xFFFF is reserved; the server MUST NOT return a **TID** value of 0xFFFF.

SMB_Data (2 bytes):

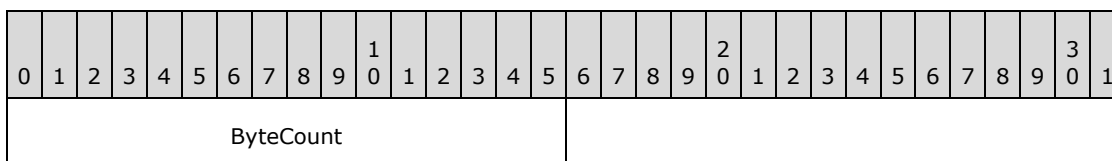

ByteCount (2 bytes): This field MUST be 0x0000. No data is sent by this message.

Error Codes

SMB error class	SMB error code	NT status code	POSIX equivalent	Description
ERRDOS (0x01)	ERRbadpath (0x0003)	STATUS_OBJECT_PATH_NOT_FOUND (0xC000003A)	ENOENT	The share path does not reference a valid resource.
ERRDOS (0x01)	ERRnoaccess (0x0005)	STATUS_LOGON_FAILURE (0xC000006D)	EPERM	The server rejected the client logon attempt.
ERRDOS (0x01)	ERRnomem (0x0008)	STATUS_INSUFF_SERVER_RESOURCES (0xC0000205)	ENOMEM	The server is out of resources. Out of memory or TIDs .
ERRDOS (0x01)	ERRnosuchshare (0x0043)	STATUS_BAD_NETWORK_NAME (0xC00000CC)		The server is temporarily paused.
ERRDOS (0x01)	ERRpaused (0x0046)	STATUS_SHARING_PAUSED (0xC00000CF)		The server is temporarily paused.
ERRDOS (0x01)	ERRreqnotaccep (0x0047)	STATUS_REQUEST_NOT_ACCEPTED (0xC00000D0)		The server has no more connections available.
ERRDOS (0x01)	ERRinvalidparam (0x0057)	STATUS_INVALID_PARAMETER (0xC000000D)		Tree connect request after request to end

SMB error class	SMB error code	NT status code	POSIX equivalent	Description
				session or internal error.
ERRSRV (0x02)	ERRerror (0x0001)	STATUS_INVALID_SMB (0x00010002)		Invalid SMB. Not enough parameter bytes were sent. Did the client omit a session setup?
ERRSRV (0x02)	ERRbadpw (0x0002)	STATUS_LOGON_FAILURE (0xC000006D)		Incorrect password during logon attempt.
ERRSRV (0x02)	ERRaccess (0x0004)	STATUS_ACCESS_DENIED (0xC0000022)		The user is not authorized to access the resource.
ERRSRV (0x02)	ERRinvnetname (0x0006)	STATUS_BAD_NETWORK_NAME (0xC00000CC)		The share path is not valid.
ERRSRV (0x02)	ERRinvdevice (0x0007)	STATUS_BAD_DEVICE_TYPE (0xC00000CB)		Resource type invalid. Value of Service field in the request was invalid.
ERRSRV (0x02)	ERRbaduid (0x005B)	STATUS_SMB_BAD_UID (0x005B0002)		The UID supplied is not defined to the session.

2.2.4.51 SMB_COM_TREE_DISCONNECT (0x71)

This is an original **Core Protocol** command.

This command is used to logically disconnect client access to a server resource. The resource sharing connection is identified by the TID in the [SMB Header \(section 2.2.3.1\)](#), and the TID is invalidated. It MUST NOT be recognized if used by the client in subsequent requests. All open files, directories, and other resources that exist within the resource identified by the TID are released. Locks on files or directories within the shared resource are also released.

2.2.4.51.1 Request

```
SMB_Parameters
{
    UCHAR WordCount;
}
SMB_Data
{
    USHORT ByteCount;
}
```

SMB_Header

TID (2 bytes): The Tree ID of the resource connection to be closed.

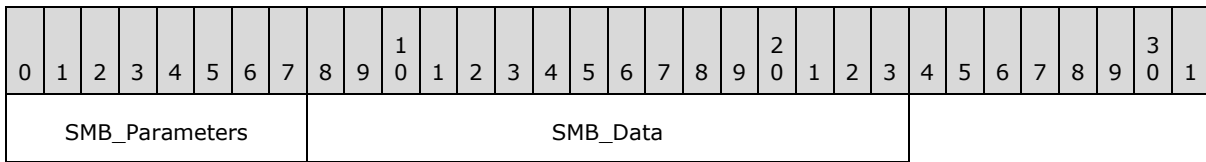

SMB_Parameters (1 byte):

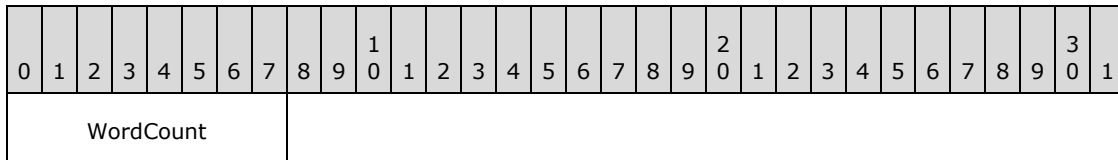

WordCount (1 byte): This field MUST be 0x00. No parameters are sent by this message.

SMB_Data (2 bytes):

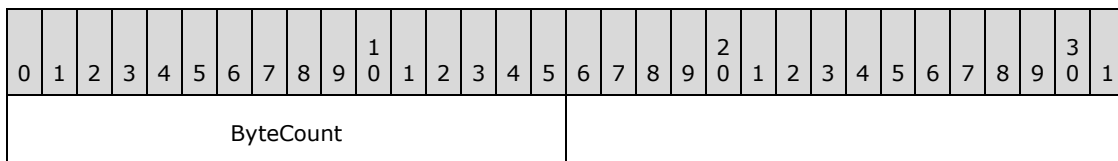

ByteCount (2 bytes): This field MUST be 0x0000. No data is sent by this message.

2.2.4.51.2 Response

```

SMB_Parameters
{
    UCHAR WordCount;
}
SMB_Data
{
    USHORT ByteCount;
}
    
```

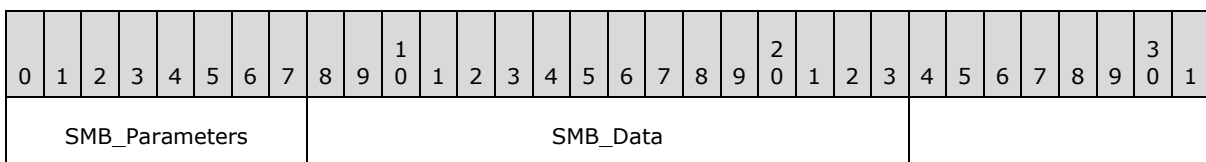

SMB_Parameters (1 byte):

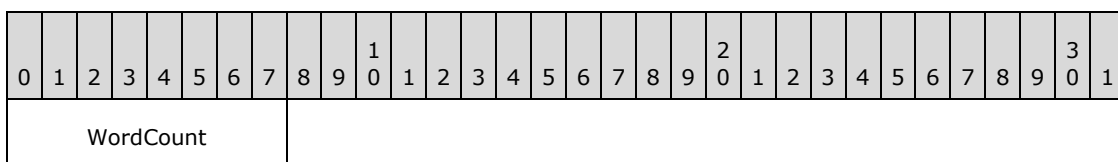

WordCount (1 byte): This field MUST be 0x00. No parameters are sent by this message.

SMB_Data (2 bytes):

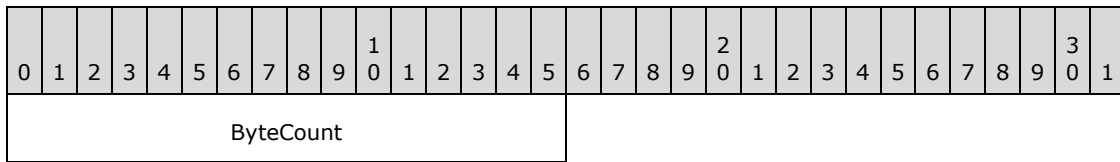

ByteCount (2 bytes): This field MUST be 0x0000. No data is sent by this message.

Error Codes

SMB error class	SMB error code	NT status code	POSIX equivalent	Description
ERRSRV (0x02)	ERRerror (0x0001)	STATUS_INVALID_SMB (0x00010002)		The client sent a badly formatted SMB_COM_TREE_DISCONNECT request.
ERRSRV (0x02)	ERRbadtid (0x0005)	STATUS_SMB_BAD_TID (0x00050002)		The TID specified in the request is invalid.
ERRSRV (0x02)	ERRbaduid (0x005B)	STATUS_SMB_BAD_UID (0x005B0002)		The UID supplied is not known to the session, or the user identified by the UID does not have sufficient privileges.

2.2.4.52 SMB_COM_NEGOTIATE (0x72)

This is an original **Core Protocol** command.

This command is used to initiate an SMB connection between the client and the server. An SMB_COM_NEGOTIATE exchange MUST be completed before any other SMB messages are sent to the server.

There MUST be only one SMB_COM_NEGOTIATE exchange per SMB connection. Subsequent SMB_COM_NEGOTIATE requests received by the server MUST be rejected with error responses. The server MUST NOT take any other action.

2.2.4.52.1 Request

```

SMB_Parameters
{
    UCHAR WordCount;
}
SMB_Data
{
    USHORT ByteCount;
    Bytes
    {
        UCHAR Dialects[];
    }
}

```

SMB_Header

CID (2 bytes): If the transport is connectionless (for example, Direct IPX Transport), then this field MUST be 0x0000.

TID (2 bytes): The **TID** is uninitialized at this point and MUST be ignored by the server. <75>

UID (2 bytes): The **UID** is uninitialized at this point and MUST be ignored by the server. <76>

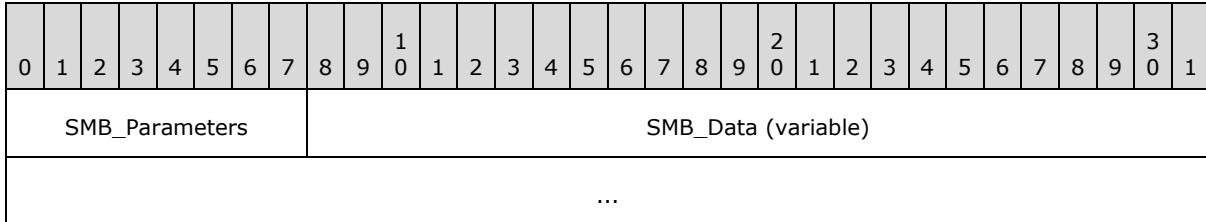

SMB_Parameters (1 byte):

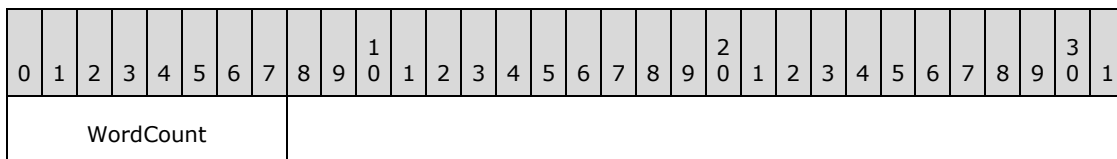

WordCount (1 byte): This field MUST be 0x00. No parameters are sent by this message.

SMB_Data (variable):

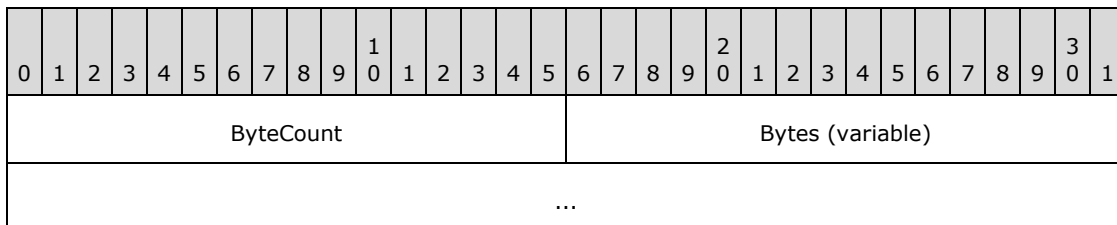

ByteCount (2 bytes): This field MUST be greater than or equal to 0x0002.

Bytes (variable):

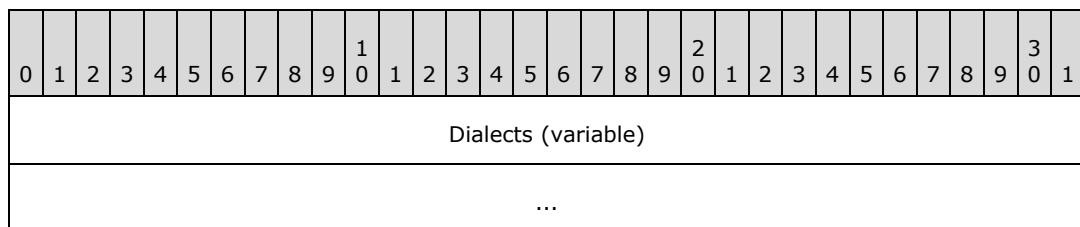

Dialects (variable): This is a variable length list of dialect identifiers in order of preference from least to most preferred. The client MUST list only dialects that it supports. The structure of the list entries is as follows:

SMB_Dialect

```

{
    UCHAR      BufferFormat;
    OEM_STRING DialectString;
}

```

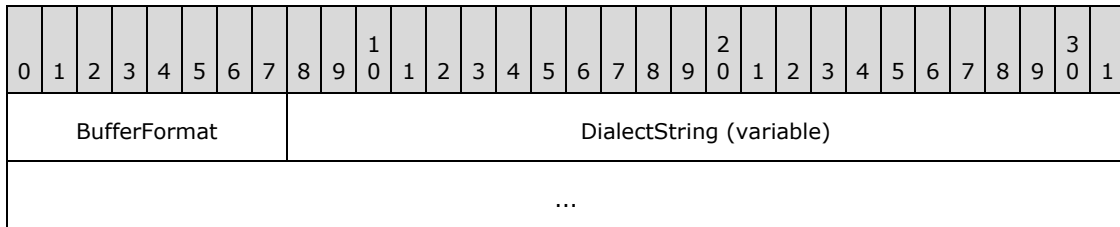

BufferFormat (1 byte): This field MUST be 0x02. This is a buffer format indicator that identifies the next field as a null-terminated array of characters.

DialectString (variable): A null-terminated string identifying an SMB dialect. A list of common dialects is presented in section [1.7](#).

2.2.4.52.2 Response

The server's response is dependent upon the dialect, if any, that the server has selected.

- If the server is returning an error, the **WordCount** and **ByteCount** SHOULD be 0x00 and 0x0000, respectively.
- If the server has selected the **Core Protocol** dialect, or if none of the offered protocols is supported by the server, then **WordCount** MUST be 0x01 and the dialect index (the selected dialect) MUST be returned as the only parameter.
- If the server has selected any dialect from **LAN Manager 1.0** through **LAN Manager 2.1**, **WordCount** MUST be 0x0D. See [XOPEN-SMB] for a specification of the LAN Manager dialects other than **LAN Manager 2.1**. [\[SMB-LM21\]](#) provides documentation on the extensions to the **LAN Manager 2.0** dialect that define the **LAN Manager 2.1** dialect.
- If the server has selected the **NT LAN Manager** dialect, then **WordCount** MUST be 0x11.

Other dialects can return an [SMB_COM_NEGOTIATE \(section 2.2.4.52\)](#) response using different formats. The value of **WordCount** MUST, therefore, be considered variable until the dialect has been determined. All dialects MUST return the **DialectIndex** as the first entry in the **SMB_Parameters.Words** array. That is, the structure returned by the Core Protocol is the common minimum. That structure is as follows.

```

SMB_Parameters
{
    UCHAR  WordCount;
    Words
    {
        USHORT DialectIndex;
    }
}
SMB_Data
{
    USHORT ByteCount;
}

```

SMB_Header

CID (2 bytes): If the underlying transport is connectionless (for example, Direct IPX), the Connection ID (CID) is returned by the server.

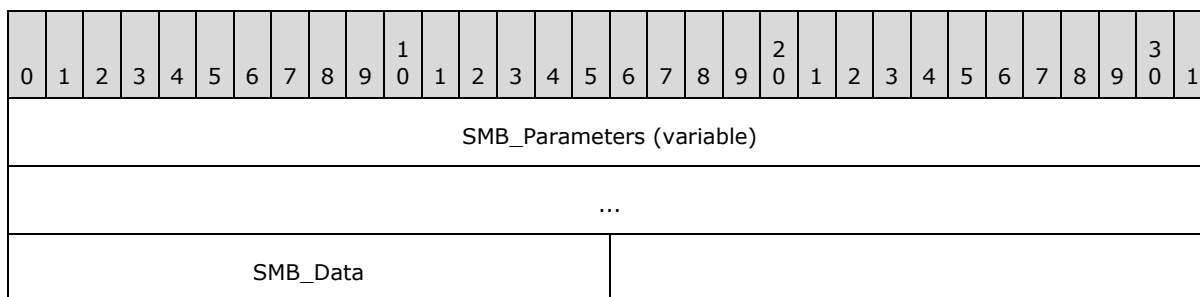

SMB_Parameters (variable):

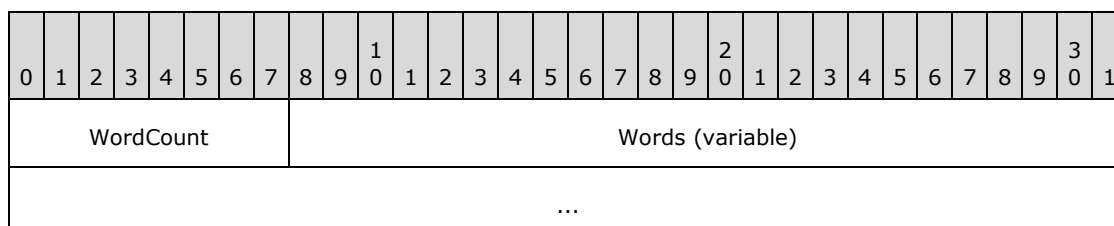

WordCount (1 byte): The value of this field MUST be greater than or equal to 0x01.

Words (variable):

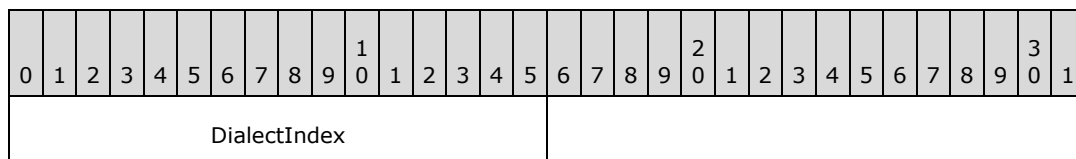

DialectIndex (2 bytes): The index of the dialect selected by the server from the list presented in the request. Dialect entries are numbered starting with 0x0000, so a **DialectIndex** value of 0x0000 indicates that the first entry in the list has been selected. If the server does not support any of the listed dialects, it MUST return a **DialectIndex** of 0xFFFF.

SMB_Data (2 bytes):

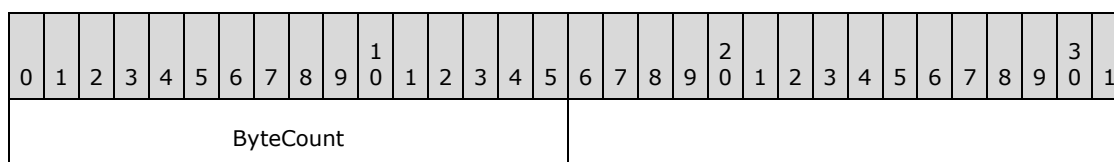

ByteCount (2 bytes): The value of this field MUST be set to 0x0000.

If the negotiated dialect is **NT LAN Manager**, the structure of the SMB_COM_NEGOTIATE response is as follows.

SMB_Parameters

```

{
  UCHAR WordCount;
  Words
  {
    USHORT  DialectIndex;
    UCHAR   SecurityMode;
    USHORT  MaxMpxCount;
    USHORT  MaxNumberVcs;
    ULONG   MaxBufferSize;
    ULONG   MaxRawSize;
    ULONG   SessionKey;
    ULONG   Capabilities;
    FILETIME SystemTime;
    SHORT   ServerTimeZone;
    UCHAR   ChallengeLength;
  }
}
SMB_Data
{
  USHORT ByteCount;
  Bytes
  {
    UCHAR Challenge[];
    SMB_STRING DomainName[];
  }
}

```

SMB_Header

CID (2 bytes): If the underlying transport is connectionless (for example, Direct IPX Transport), the Connection ID (CID) is returned by the server.

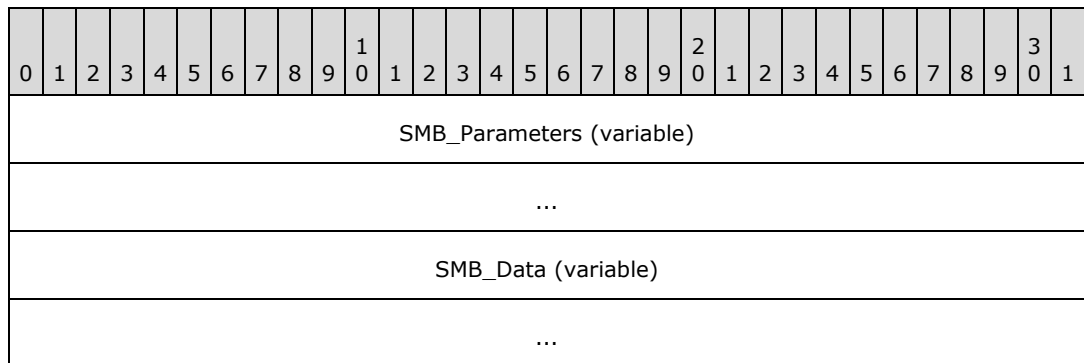

SMB_Parameters (variable):

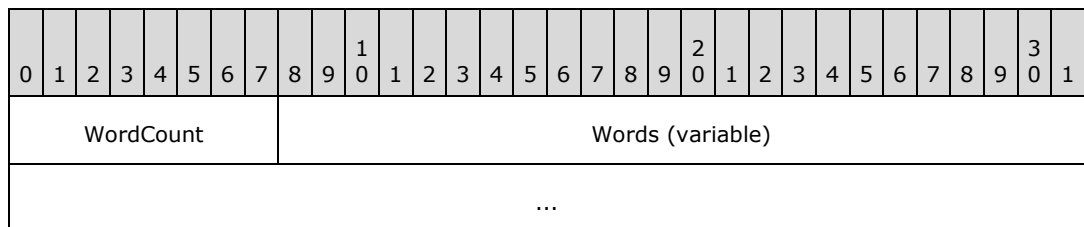

WordCount (1 byte): The value of this field MUST be 0x11.

Words (variable):

0	1	2	3	4	5	6	7	8	9	10	11	12	13	14	15	16	17	18	19	20	21	22	23	24	25	26	27	28	29	30	31
DialectIndex											SecurityMode										MaxMpxCount										
...										MaxNumberVcs																MaxBufferSize					
...																										MaxRawSize					
...																										SessionKey					
...																										Capabilities					
...																										SystemTime					
...																															
...																						ServerTimeZone									
...										ChallengeLength																					

DialectIndex (2 bytes): The index of the dialect selected by the server from the list presented in the request. Dialect entries are numbered starting with 0x0000, so a **DialectIndex** value of 0x0000 indicates the first entry in the list. If the server does not support any of the listed dialects, it MUST return a **DialectIndex** of 0xFFFF.

SecurityMode (1 byte): An 8-bit field indicating the security modes supported or required by the server, as follows:

Name and bitmask	Meaning
NEGOTIATE_USER_SECURITY 0x01	If clear (0), the server supports only Share Level access control. If set (1), the server supports only User Level access control.
NEGOTIATE_ENCRYPT_PASSWORDS 0x02	If clear, the server supports only plaintext password authentication. If set, the server supports challenge/response authentication.<77>
NEGOTIATE_SECURITY_SIGNATURES_ENABLE D 0x04	If clear, the server does not support SMB security signatures. If set, the server supports SMB security signatures for this connection.<78>
NEGOTIATE_SECURITY_SIGNATURES_REQUIRE D	If clear, the security signatures are optional

Name and bitmask	Meaning
0x08	for this connection. If set, the server requires security signatures. This bit MUST be clear if the NEGOTIATE_SECURITY_SIGNATURES_ENABLE D bit is clear.
Reserved 0xF0	The remaining bits are reserved and MUST be zero.

MaxMpxCount (2 bytes): The maximum number of outstanding SMB operations that the server supports. This value includes existing OpLocks, the NT_TRANSACT_NOTIFY_CHANGE subcommand, and any other commands that are pending on the server. If the negotiated **MaxMpxCount** is 0x0001, then OpLock support MUST be disabled for this session. The **MaxMpxCount** MUST be greater than 0x0000. This parameter has no specific relationship to the SMB_COM_READ_MPX and SMB_COM_WRITE_MPX commands. <79>

MaxNumberVcs (2 bytes): The maximum number of virtual circuits that can be established between the client and the server as part of the same SMB session. <80>

MaxBufferSize (4 bytes): The maximum size, in bytes, of the largest SMB message that the server can receive. This is the size of the largest SMB message that the client can send to the server. SMB message size includes the size of the SMB header, parameter, and data blocks. This size does not include any transport-layer framing or other transport-layer data. The server SHOULD <81> provide a **MaxBufferSize** of 4356 bytes, and MUST be a multiple of 4 bytes. If CAP_RAW_MODE is negotiated, the SMB_COM_WRITE_RAW command can bypass the **MaxBufferSize** limit. Otherwise, SMB messages sent to the server MUST have a total size less than or equal to the **MaxBufferSize** value. This includes AndX chained messages.

MaxRawSize (4 bytes): This value specifies the maximum message size when the client sends an [SMB_COM_WRITE_RAW Request \(section 2.2.4.25.1\)](#), and the maximum message size that the server MUST NOT exceed when sending an [SMB_COM_READ_RAW Response \(section 2.2.4.22.2\)](#). This value is significant only if CAP_RAW_MODE is negotiated. <82>

SessionKey (4 bytes): The server SHOULD set the value to a token generated for the connection, as specified in [SessionKey Generation \(section 2.2.1.6.6\)](#).

Capabilities (4 bytes): A 32-bit field providing a set of server capability indicators. This bit field is used to indicate to the client which features are supported by the server. Any value not listed in the following table is unused. The server MUST set the unused bits to 0 in a response, and the client MUST ignore these bits.

Name and bitmask	Meaning
CAP_RAW_MODE 0x00000001	The server supports SMB_COM_READ_RAW and SMB_COM_WRITE_RAW requests. Raw mode is not supported over connectionless transports.
CAP_MPX_MODE 0x00000002	The server supports SMB_COM_READ_MPX and SMB_COM_WRITE_MPX requests. MPX mode is supported only over connectionless transports.
CAP_UNICODE 0x00000004	The server supports UTF-16LE Unicode strings.

Name and bitmask	Meaning
CAP_LARGE_FILES 0x00000008	The server supports 64-bit file offsets.
CAP_NT_SMB 0x00000010	The server supports SMB commands particular to the NT LAN Manager dialect.
CAP_RPC_REMOTE_APIS 0x00000020	The server supports the use of Microsoft remote procedure call (MS-RPC) for remote API calls. Similar functionality would otherwise require use of the legacy Remote Administration Protocol, as specified in [MS-RAP] .
CAP_STATUS32 0x00000040	The server is capable of responding with 32-bit status codes in the Status field of the SMB Header (section 2.2.3.1) (for more information, see 2.2.3.1). CAP_STATUS32 is also sometimes referred to as CAP_NT_STATUS.
CAP_LEVEL_II_OPLOCKS 0x00000080	The server supports level II opportunistic locks (OpLocks).
CAP_LOCK_AND_READ 0x00000100	The server supports the SMB_COM_LOCK_AND_READ command request.
CAP_NT_FIND 0x00000200	The server supports the TRANS2_FIND_FIRST2, TRANS2_FIND_NEXT2, and FIND_CLOSE2 command requests. This bit SHOULD be set if CAP_NT_SMB is set. <83>
CAP_BULK_TRANSFER 0x00000400	This value was reserved but not implemented and MUST be zero. <84>
CAP_COMPRESSED_DATA 0x00000800	This value was reserved but not implemented and MUST be zero. <85>
CAP_DFS 0x00001000	The server is aware of the DFS Referral Protocol, as specified in [MS-DFSC] , and can respond to Microsoft DFS referral requests. For more information, see sections 2.2.6.16.1 and 2.2.6.16.2 .
CAP_QUADWORD_ALIGNED 0x00002000	This value was reserved but not implemented and MUST be zero. <86>
CAP_LARGE_READX 0x00004000	The server supports large read operations. This capability affects the maximum size, in bytes, of the server buffer for sending an SMB_COM_READ_ANDX response to the client. When this capability is set by the server (and set by the client in the SMB_COM_SESSION_SETUP_ANDX request), the maximum server buffer size for sending data can be up to 65,535 bytes rather than the MaxBufferSize field. Therefore, the server can send a single SMB_COM_READ_ANDX response to the client up to this size.

SystemTime (8 bytes): The number of 100-nanosecond intervals that have elapsed since January 1, 1601, in Coordinated Universal Time (UTC) format. <87>

ServerTimeZone (2 bytes): **SHORT** A signed 16-bit signed integer that represents the server's time zone, in minutes, from UTC. The time zone of the server **MUST** be expressed in minutes, plus or minus, from UTC. <88>

ChallengeLength (1 byte): This field **MUST** be 0x00 or 0x08. The length of the random challenge used in challenge/response authentication. If the server does not support challenge/response authentication, this field **MUST** be 0x00. This field is often referred to in older documentation as **EncryptionKeyLength**.

SMB_Data (variable):

0	1	2	3	4	5	6	7	8	9	10	11	12	13	14	15	16	17	18	19	20	21	22	23	24	25	26	27	28	29	30	31
ByteCount																Bytes (variable)															
...																															

ByteCount (2 bytes): This field **MUST** be greater than or equal to 0x0001. If CAP_UNICODE has been negotiated, it **MUST** be greater than or equal to 0x0002.

Bytes (variable):

0	1	2	3	4	5	6	7	8	9	10	11	12	13	14	15	16	17	18	19	20	21	22	23	24	25	26	27	28	29	30	31
Challenge (variable)																															
...																															
DomainName (variable)																															
...																															

Challenge (variable): An array of unsigned bytes that **MUST** be **ChallengeLength** bytes long and **MUST** represent the server challenge. This array **MUST NOT** be null-terminated. This field is often referred to in older documentation as **EncryptionKey**.

DomainName (variable): The null-terminated name of the NT domain or workgroup to which the server belongs. <89>

Error Codes

SMB error class	SMB error code	NT status code	POSIX equivalent	Description
ERRSRV (0x02)	ERRerror (0x0001)	STATUS_INVALID_SMB (0x00010002)		The command was already sent.

2.2.4.53 SMB_COM_SESSION_SETUP_ANDX (0x73)

This command was introduced in the **LAN Manager 1.0** dialect. The formats of the request and response messages have changed since the command was first defined. The CIFS format, as defined for the NT LAN Manager dialect, is presented here. This format **MUST** be used when the NT LAN Manager dialect has been negotiated.

This command is used to configure an SMB session. If the server is operating in user level access control mode, then at least one SMB_COM_SESSION_SETUP_ANDX **MUST** be sent in order to perform a user logon to the server and to establish a valid UID.

In CIFS, it is a protocol violation to issue an SMB_COM_TREE_CONNECT or SMB_COM_TREE_CONNECT_ANDX request before an SMB_COM_SESSION_SETUP_ANDX command has been successfully executed, even if the server is operating in Share Level Access Control mode. Including an SMB_COM_TREE_CONNECT_ANDX batched request in an AndX chain (section [2.2.3.4](#)) following an SMB_COM_SESSION_SETUP_ANDX request is sufficient to fulfill this requirement. [<90>](#) Anonymous authentication is also sufficient to fulfill this requirement.

Multiple SMB_COM_SESSION_SETUP_ANDX commands are permitted within an SMB connection, either to establish additional UIDs or to create additional virtual circuits.

The following are the commands that can follow an SMB_COM_SESSION_SETUP_ANDX with an SMB_COM_TREE_CONNECT_ANDX (section [2.2.4.55](#)) in an AndX chain:

- [SMB_COM_OPEN \(section 2.2.4.3\)](#)
- [SMB_COM_OPEN_ANDX \(section 2.2.4.41\)](#)
- [SMB_COM_CREATE \(section 2.2.4.4\)](#)
- [SMB_COM_CREATE_NEW \(section 2.2.4.16\)](#)
- [SMB_COM_CREATE_DIRECTORY \(section 2.2.4.1\)](#)
- [SMB_COM_DELETE \(section 2.2.4.7\)](#)
- [SMB_COM_DELETE_DIRECTORY \(section 2.2.4.2\)](#)
- [SMB_COM_FIND \(section 2.2.4.59\)](#)
- [SMB_COM_FIND_UNIQUE \(section 2.2.4.60\)](#)
- [SMB_COM_RENAME \(section 2.2.4.8\)](#)
- [SMB_COM_NT_RENAME \(section 2.2.4.66\)](#)
- [SMB_COM_CHECK_DIRECTORY \(section 2.2.4.17\)](#)
- [SMB_COM_QUERY_INFORMATION \(section 2.2.4.9\)](#)
- [SMB_COM_SET_INFORMATION \(section 2.2.4.10\)](#)
- [SMB_COM_OPEN_PRINT_FILE \(section 2.2.4.67\)](#)
- [SMB_COM_TRANSACTION \(section 2.2.4.33\)](#)

2.2.4.53.1 Request

```

SMB_Parameters
{
  UCHAR  WordCount;
  Words
  {
    UCHAR  AndXCommand;
    UCHAR  AndXReserved;
    USHORT AndXOffset;
    USHORT MaxBufferSize;
    USHORT MaxMpxCount;
    USHORT VcNumber;
    ULONG  SessionKey;
    USHORT OEMPasswordLen;
    USHORT UnicodePasswordLen;
    ULONG  Reserved;
    ULONG  Capabilities;
  }
}
SMB_Data
{
  USHORT ByteCount;
  Bytes
  {
    UCHAR      OEMPassword[];
    UCHAR      UnicodePassword[];
    UCHAR      Pad[];
    SMB_STRING AccountName[];
    SMB_STRING PrimaryDomain[];
    SMB_STRING NativeOS[];
    SMB_STRING NativeLanMan[];
  }
}

```

SMB_Header:

TID (2 bytes): This field is ignored in this request.

UID (2 bytes): This field is ignored in this request.

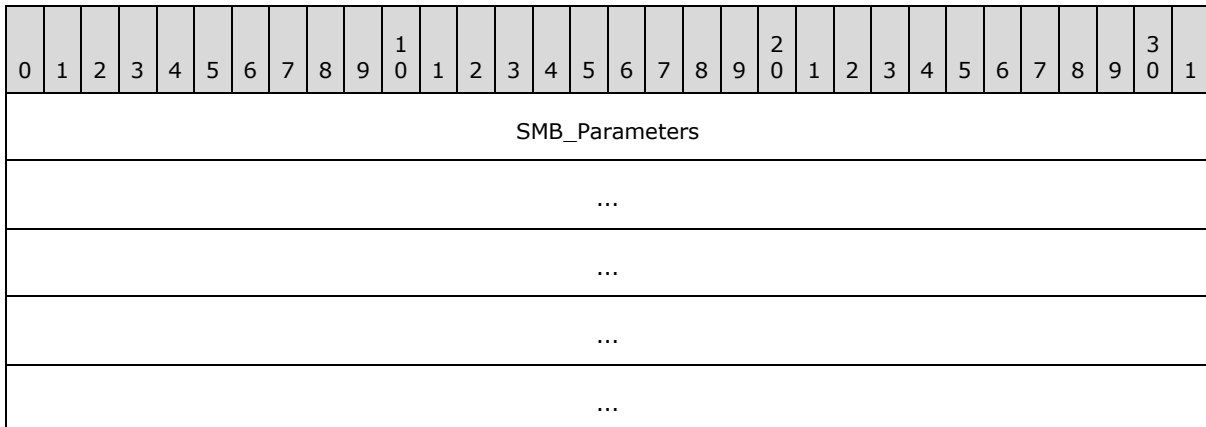

...
... SMB_Data (variable)
...

SMB_Parameters (27 bytes):

0	1	2	3	4	5	6	7	8	9	10	11	12	13	14	15	16	17	18	19	20	21	22	23	24	25	26	27	28	29	30	31
WordCount										Words																					
...																															
...																															
...																															
...																															
...																															
...																															

WordCount (1 byte): The value of this field MUST be 0x0D.

Words (26 bytes):

0	1	2	3	4	5	6	7	8	9	10	11	12	13	14	15	16	17	18	19	20	21	22	23	24	25	26	27	28	29	30	31
AndXCommand										AndXReserved										AndXOffset											
MaxBufferSize													MaxMpxCount																		
VcNumber													SessionKey																		
...													OEMPasswordLen																		
UnicodePasswordLen													Reserved																		
...													Capabilities																		
...																															

AndXCommand (1 byte): This field MUST be either the command code for the next SMB command in the packet or 0xFF.

AndXReserved (1 byte): A reserved field. This MUST be set to 0x00 when this request is sent, and the server MUST ignore this value.

AndXOffset (2 bytes): This field MUST be set to the offset in bytes from the start of the [SMB Header \(section 2.2.3.1\)](#) to the start of the **WordCount** field in the next SMB command in this packet. This field is valid only if the **AndXCommand** field is not set to 0xFF. If **AndXCommand** is 0xFF, this field MUST be ignored by the server.

MaxBufferSize (2 bytes): The maximum size, in bytes, of the largest SMB message that the client can receive. This is the size of the largest SMB message that the server can send to the client. SMB message size includes the size of the SMB header, parameter, and data blocks. [<91>](#) This size MUST NOT include any transport-layer framing or other transport-layer data.

There are two exceptions to the limit imposed by the client's **MaxBufferSize** value.

- If the CAP_RAW_MODE capability is negotiated, then the maximum size of an SMB_COM_READ_RAW command response from the server MUST be limited by the **MaxRawSize** value previously returned by the server in the [SMB_COM_NEGOTIATE Response \(section 2.2.4.52.2\)](#) message.
- If the CAP_LARGE_READX capability is negotiated, the [SMB_COM_READ_ANDX \(section 2.2.4.42\)](#) command response MAY bypass the client's **MaxBufferSize** limit. There is no field in any CIFS message that indicates the maximum size of an SMB_COM_READ_ANDX if CAP_LARGE_READX is negotiated. [<92>](#)

MaxMpxCount (2 bytes): The maximum number of pending requests supported by the client. This value MUST be less than or equal to the **MaxMpxCount** field value provided by the server in the SMB_COM_NEGOTIATE Response.

VcNumber (2 bytes): The number of this VC (virtual circuit) between the client and the server. This field SHOULD be set to a value of 0x0000 for the first virtual circuit between the client and the server and it SHOULD be set to a unique nonzero value for each additional virtual circuit. [<93>](#)

SessionKey (4 bytes): The client MUST set this field to be equal to the **SessionKey** field in the SMB_COM_NEGOTIATE Response for this SMB connection. [<94>](#)

OEMPasswordLen (2 bytes): The length, in bytes, of the contents of the **SMB_Data.OEMPassword** field.

UnicodePasswordLen (2 bytes): The length, in bytes, of the contents of the **SMB_Data.UnicodePassword** field.

Reserved (4 bytes): Reserved. This field MUST be 0x00000000. The server MUST ignore the contents of this field.

Capabilities (4 bytes): A 32-bit field providing a set of client capability indicators. The client uses this field to report its own set of capabilities to the server. The client capabilities are a subset of the server capabilities. [<95>](#)

Name and bitmask	Meaning
CAP_RAW_MODE 0x00000001	The client supports SMB_COM_READ_RAW and SMB_COM_WRITE_RAW requests. Raw mode is not supported over connectionless transports.

Name and bitmask	Meaning
CAP_MPX_MODE 0x00000002	The client supports SMB_COM_READ_MPX and SMB_COM_WRITE_MPX requests. MPX mode is supported only over connectionless transports.
CAP_UNICODE 0x00000004	The client supports UTF-16LE Unicode strings.
CAP_LARGE_FILES 0x00000008	The client supports 64-bit file offsets. <96>
CAP_NT_SMBS 0x00000010	The client supports SMB commands particular to the NT LAN Manager dialect. <97>
CAP_RPC_REMOTE_APIS 0x00000020	The client supports the use of Microsoft remote procedure call (MS-RPC) for remote API calls.
CAP_STATUS32 0x00000040	The client supports 32-bit status codes, received in the Status field of the SMB Header. CAP_STATUS32 is also sometimes referred to as CAP_NT_STATUS.
CAP_LEVEL_II_OPLOCKS 0x00000080	The client supports level II opportunistic locks (OpLocks).
CAP_LOCK_AND_READ 0x00000100	The client supports the SMB_COM_LOCK_AND_READ command.
CAP_NT_FIND 0x00000200	The client supports the TRANS2_FIND_FIRST2, TRANS2_FIND_NEXT2, and FIND_CLOSE2 command requests. <98>
CAP_DFS 0x00001000	The client supports the DFS Referral Protocol, as specified in [MS-DFSC] .
CAP_LARGE_READX 0x00004000	The client supports large read operations. This capability affects the maximum size, in bytes, of the client buffer for receiving an SMB_COM_READ_ANDX response from the server. When this capability is set by the client, the maximum client buffer size for receiving an SMB_COM_READ_ANDX can be up to 65,535 bytes, rather than the MaxBufferSize field.

SMB_Data (variable):

0	1	2	3	4	5	6	7	8	9	10	11	12	13	14	15	16	17	18	19	20	21	22	23	24	25	26	27	28	29	30	31		
ByteCount											Bytes (variable)																						
...																																	

ByteCount (2 bytes): The number of bytes in the **SMB_Data.Bytes** array, which follows.

Bytes (variable):

0	1	2	3	4	5	6	7	8	9	0	1	2	3	4	5	6	7	8	9	0	1	2	3	4	5	6	7	8	9	0	1		
OEMPassword (variable)																																	
...																																	
UnicodePassword (variable)																																	
...																																	
Pad (variable)																																	
...																																	
AccountName (variable)																																	
...																																	
PrimaryDomain (variable)																																	
...																																	
NativeOS (variable)																																	
...																																	
NativeLanMan (variable)																																	
...																																	

OEMPassword (variable): The contents of this field depends upon the authentication methods in use:

- If Unicode has not been negotiated and the client sends a plaintext password, this field **MUST** contain the password represented in the OEM character set.
- If the client uses challenge/response authentication, this field can contain a cryptographic response.
- This field **MAY** be empty.

The **OEMPassword** value is an array of bytes, not a null-terminated string.

UnicodePassword (variable): The contents of this field depends upon the authentication methods in use:

- If Unicode has been negotiated and the client sends a plaintext password, this field MUST contain the password represented in UTF-16LE Unicode. [<99>](#)
- If the client uses challenge/response authentication, this field can contain a cryptographic response.
- This field MAY be empty.

See section [3.2.4.2.4](#) for a description of authentication mechanisms used with CIFS.

If the client sends a plaintext password, then the password MUST be encoded in either OEM or Unicode characters, but not both. The value of the SMB_FLAGS2_UNICODE bit of the **SMB_Header.Flags2** indicates the character encoding of the password. If a plaintext password is sent, then:

- If SMB_FLAGS2_UNICODE is clear (0), the value of **UnicodePasswordLen** MUST be 0x0000, and the password MUST be encoded using the 8-bit OEM character set (extended ASCII).
- If SMB_FLAGS2_UNICODE is set (1), the value of **OEMPasswordLen** MUST be 0x0000 and the password MUST be encoded using UTF-16LE Unicode. Padding MUST NOT be added to align this plaintext Unicode string to a word boundary.

Pad (variable): Padding bytes. If Unicode support has been enabled and SMB_FLAGS2_UNICODE is set in **SMB_Header.Flags2**, this field MUST contain zero (0x00) or one null padding byte as needed to ensure that the **AccountName** string is aligned on a 16-bit boundary. This also forces alignment of subsequent strings without additional padding.

AccountName (variable): The name of the account (username) with which the user authenticates.

PrimaryDomain (variable): A string representing the desired authentication domain. This MAY be the empty string. If SMB_FLAGS2_UNICODE is set in the **Flags2** field of the SMB header of the request, this string MUST be a null-terminated array of 16-bit Unicode characters. Otherwise, this string MUST be a null-terminated array of OEM characters. If this string consists of Unicode characters, this field MUST be aligned to start on a 2-byte boundary from the start of the SMB header.

NativeOS (variable): A string representing the native operating system of the CIFS client. If SMB_FLAGS2_UNICODE is set in the **Flags2** field of the SMB header of the request, this string MUST be a null-terminated array of 16-bit Unicode characters. Otherwise, this string MUST be a null-terminated array of OEM characters. If this string consists of Unicode characters, this field MUST be aligned to start on a 2-byte boundary from the start of the SMB header. [<100>](#)

NativeLanMan (variable): A string that represents the native LAN manager type of the client. If SMB_FLAGS2_UNICODE is set in the **Flags2** field of the SMB header of the request, this string MUST be a null-terminated array of 16-bit Unicode characters. Otherwise, this string MUST be a null-terminated array of OEM characters. If this string consists of Unicode characters, this field MUST be aligned to start on a 2-byte boundary from the start of the SMB header. [<101>](#)

2.2.4.53.2 Response

```
SMB_Parameters
{
    UCHAR    WordCount;
    Words
    {
```

```

    UCHAR  AndXCommand;
    UCHAR  AndXReserved;
    USHORT AndXOffset;
    USHORT Action;
    }
}
SMB_Data
{
    USHORT ByteCount;
    Bytes
    {
        UCHAR      Pad[];
        SMB_STRING NativeOS[];
        SMB_STRING NativeLanMan[];
        SMB_STRING PrimaryDomain[];
    }
}

```

SMB_Header:

UID (2 bytes): The UID returned in the response to a successful SMB_COM_SESSION_SETUP_ANDX request represents an authenticated session.

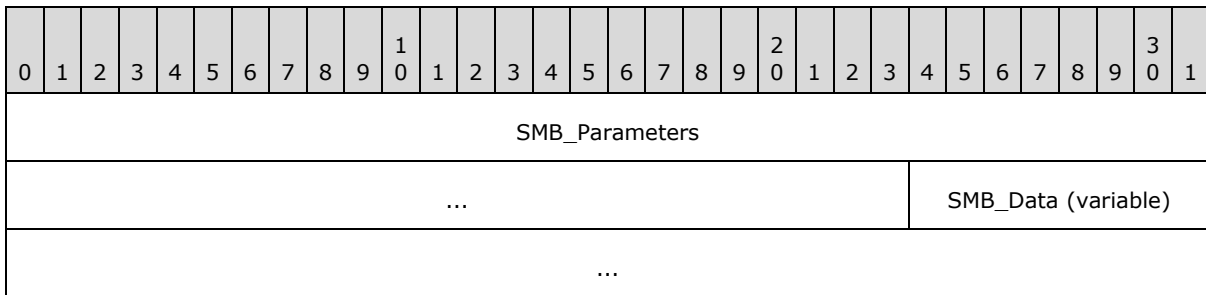

SMB_Parameters (7 bytes):

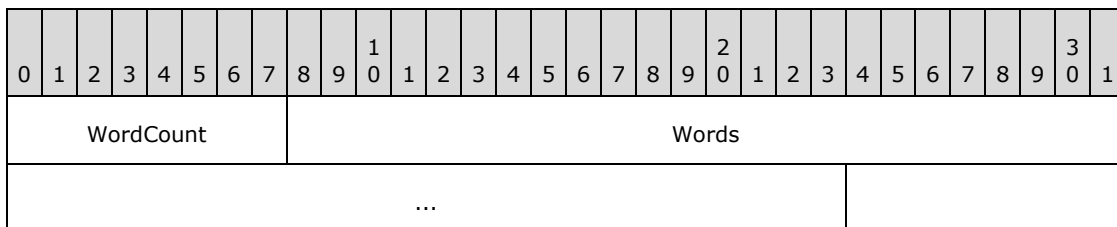

WordCount (1 byte): The value of this field MUST be 0x03.

Words (6 bytes):

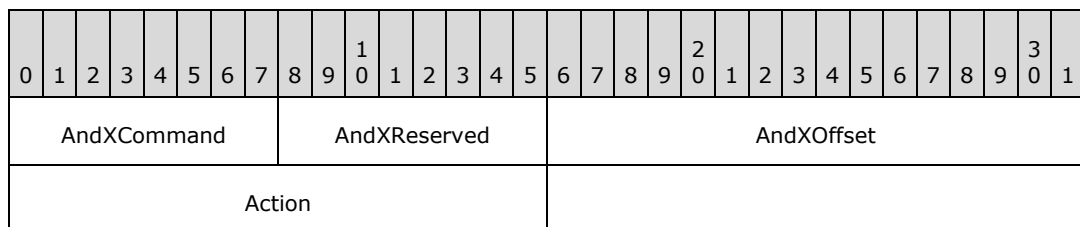

AndXCommand (1 byte): The command code for the next SMB command in the packet. This value MUST be set to 0xFF if there are no additional SMB command responses in the server response packet.

AndXReserved (1 byte): A reserved field. This MUST be set to 0x00 when this response is sent, and the client MUST ignore this field.

AndXOffset (2 bytes): This field MUST be set to the offset in bytes from the start of the [SMB Header \(section 2.2.3.1\)](#) to the start of the **WordCount** field in the next SMB command response in this packet. This field is valid only if the **AndXCommand** field is not set to 0xFF. If **AndXCommand** is 0xFF, this field MUST be ignored by the client.

Action (2 bytes): A 16-bit field. The two lowest-order bits have been defined:

Name and Bitmask	Meaning
SMB_SETUP_GUEST 0x0001	If clear (0), the user successfully authenticated and is logged in. if set (1), authentication failed but the server has granted guest access. The user is logged in as Guest.
SMB_SETUP_USE_LANMAN_KEY 0x0002	If clear, the NTLM user session key will be used for message signing (if enabled). If set, the LM session key will be used for message signing.

SMB_Data (variable):

0	1	2	3	4	5	6	7	8	9	10	11	12	13	14	15	16	17	18	19	20	21	22	23	24	25	26	27	28	29	30	31
ByteCount																Bytes (variable)															
...																															

ByteCount (2 bytes): The sum of the lengths, in bytes, of the **Pad**, **NativeOS**, **NativeLanMan**, and **PrimaryDomain** fields.

Bytes (variable):

0	1	2	3	4	5	6	7	8	9	10	11	12	13	14	15	16	17	18	19	20	21	22	23	24	25	26	27	28	29	30	31
Pad (variable)																															
...																															
NativeOS (variable)																															
...																															

NativeLanMan (variable)
...
PrimaryDomain (variable)
...

Pad (variable): Padding bytes. If Unicode support has been enabled, this field MUST contain zero or one null padding byte as needed to ensure that the **NativeOS** field, which follows, is aligned on a 16-bit boundary.

NativeOS (variable): A string that represents the native operating system of the server. If SMB_FLAGS2_UNICODE is set in the **Flags2** field of the SMB header of the response, the string MUST be a null-terminated array of 16-bit Unicode characters. Otherwise, the string MUST be a null-terminated array of OEM characters. If the string consists of Unicode characters, this field MUST be aligned to start on a 2-byte boundary from the start of the SMB header. <102>

NativeLanMan (variable): A string that represents the native LAN Manager type of the server. If SMB_FLAGS2_UNICODE is set in the **Flags2** field of the SMB header of the response, the string MUST be a null-terminated array of 16-bit Unicode characters. Otherwise, the string MUST be a null-terminated array of OEM characters. If the string consists of Unicode characters, this field MUST be aligned to start on a 2-byte boundary from the start of the SMB header. <103>

PrimaryDomain (variable): A string representing the primary domain or workgroup name of the server. If SMB_FLAGS2_UNICODE is set in the **Flags2** field of the SMB header of the response, the string MUST be a null-terminated array of 16-bit Unicode characters. Otherwise, the string MUST be a null-terminated array of OEM characters. If the string consists of Unicode characters, this field MUST be aligned to start on a 2-byte boundary from the start of the SMB header. <104>

Error Codes

SMB error class	SMB error code	NT status code	POSIX equivalent	Description
ERRDOS (0x01)	ERRnoaccess (0x0005)	STATUS_LOGON_FAILURE (0xC000006D)	EPERM	Authentication failure.
ERRSRV (0x02)	ERRerror (0x0001)	STATUS_INVALID_SMB (0x00010002)		A corrupt or invalid SMB request was received.
ERRSRV (0x02)	ERRnomem (0x0008)	STATUS_INSUFF_SERVER_RESOURCES (0xC0000205)	ENOMEM	The server is out of resources.
ERRSRV (0x02)	ERRtoomanyuids (0x005A)	STATUS_TOO_MANY_SESSIONS (0xC00000CE)		The maximum number of active UIDs per SMB connection has been reached.

2.2.4.54 SMB_COM_LOGOFF_ANDX (0x74)

The user connection represented by **UID** in the [SMB Header \(section 2.2.3.1\)](#) is logged off. The server releases all locks and closes all files currently open by this user, disconnects all tree connects, cancels any outstanding requests for this **UID**, and invalidates the **UID**.

The following are the commands that can follow an SMB_COM_LOGOFF_ANDX in an AndX chain:

- SMB_COM_SESSION_SETUP_ANDX.

2.2.4.54.1 Request

```
SMB_Parameters
{
  UCHAR WordCount;
  Words
  {
    UCHAR AndXCommand;
    UCHAR AndXReserved;
    USHORT AndXOffset;
  }
}
SMB_Data
{
  USHORT ByteCount;
}
```

SMB_Header:

UID (2 bytes): The User ID to be logged off. The value of this field **MUST** have been previously generated by an SMB_COM_SESSION_SETUP_ANDX command.

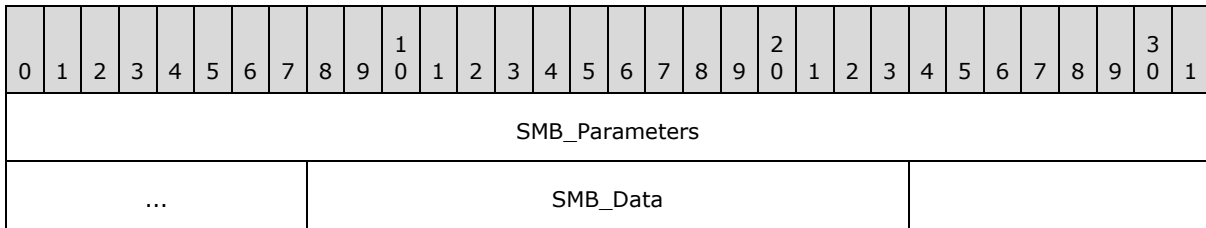

SMB_Parameters (5 bytes):

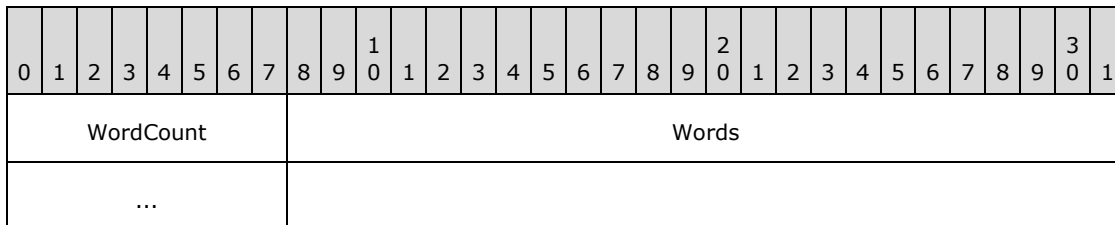

WordCount (1 byte): The value of this field **MUST** be 0x02.

Words (4 bytes):

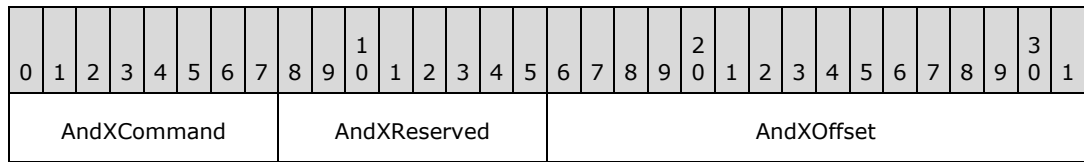

AndXCommand (1 byte): The secondary SMB command request in the packet. This value MUST be set to 0xFF if there are no additional SMB command requests in the client request packet.

AndXReserved (1 byte): A reserved field. This MUST be set to 0x00 when this request is sent, and the server MUST ignore this value when the message is received.

AndXOffset (2 bytes): This field MUST be set to the offset in bytes from the start of the [SMB Header \(section 2.2.3.1\)](#) to the start of the **WordCount** field in the next SMB command in this packet. This field is valid only if the AndXCommand field is not set to 0xFF.

SMB_Data (2 bytes):

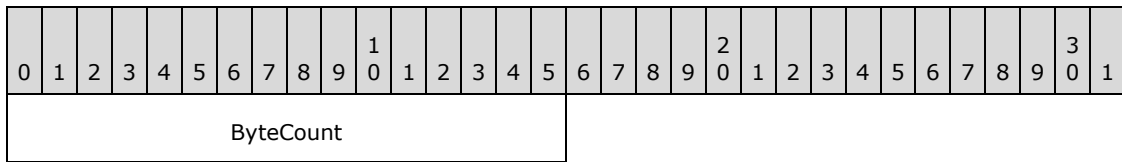

ByteCount (2 bytes): This field MUST be 0x0000. No data is sent by this message.

2.2.4.54.2 Response

```

SMB_Parameters
{
    UCHAR WordCount;
    Words
    {
        UCHAR AndXCommand;
        UCHAR AndXReserved;
        USHORT AndXOffset;
    }
}
SMB_Data
{
    USHORT ByteCount;
}

```

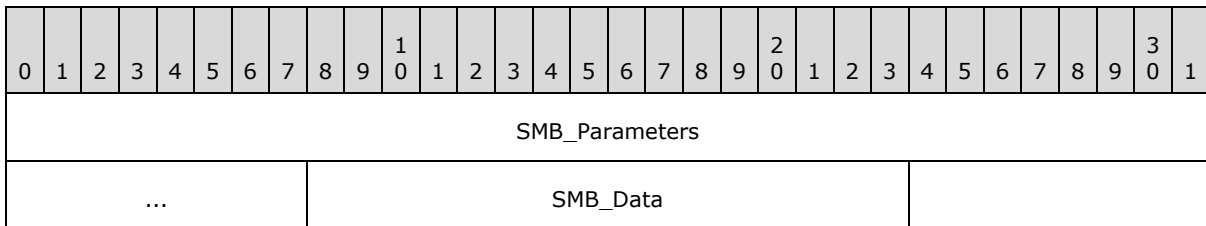

SMB_Parameters (5 bytes):

0	1	2	3	4	5	6	7	8	9	10	11	12	13	14	15	16	17	18	19	20	21	22	23	24	25	26	27	28	29	30	31					
WordCount										Words																										
...																																				

WordCount (1 byte): The value of this field MUST be 0x02.

Words (4 bytes):

0	1	2	3	4	5	6	7	8	9	10	11	12	13	14	15	16	17	18	19	20	21	22	23	24	25	26	27	28	29	30	31		
AndXCommand										AndXReserved										AndXOffset													

AndXCommand (1 byte): The secondary SMB command response in the packet. This value MUST be set to 0xFF if there are no additional SMB command responses in the server response packet.

AndXReserved (1 byte): A reserved field. This MUST be set to 0x00 when this response is sent, and the client MUST ignore this value when the message is received.

AndXOffset (2 bytes): This field MUST be set to the offset in bytes from the start of the [SMB Header \(section 2.2.3.1\)](#) to the start of the **WordCount** field in the next SMB command in this packet. This field is valid only if the AndXCommand field is not set to 0xFF.

SMB_Data (2 bytes):

0	1	2	3	4	5	6	7	8	9	10	11	12	13	14	15	16	17	18	19	20	21	22	23	24	25	26	27	28	29	30	31		
ByteCount																																	

ByteCount (2 bytes): This field MUST be 0x0000. No data is sent by this message.

Error Codes

SMB error class	SMB error code	NT status code	POSIX equivalent	Description
ERRSRV (0x02)	ERRerror (0x0001)	STATUS_INVALID_SMB (0x00010002)		Invalid SMB or ANDX command is not valid with this command.
ERRSRV (0x02)	ERRbaduid (0x005B)	STATUS_SMB_BAD_UID (0x005B0002)		The UID specified in the request is not defined as a valid UID for this session.

2.2.4.55 SMB_COM_TREE_CONNECT_ANDX (0x75)

This command was introduced in the **LAN Manager 1.0** dialect.

This command is used to establish a client connection to a server share. The share is identified by name, and the connection, once established, is identified by a **TID** that is returned to the client.

The following are the commands that can follow an SMB_COM_TREE_CONNECT_ANDX in an AndX chain:

- [SMB_COM_OPEN \(section 2.2.4.3\)](#)
- [SMB_COM_OPEN_ANDX \(section 2.2.4.41\)](#)
- [SMB_COM_CREATE \(section 2.2.4.4\)](#)
- [SMB_COM_CREATE_NEW \(section 2.2.4.16\)](#)
- [SMB_COM_CREATE_DIRECTORY \(section 2.2.4.1\)](#)
- [SMB_COM_DELETE \(section 2.2.4.7\)](#)
- [SMB_COM_DELETE_DIRECTORY \(section 2.2.4.2\)](#)
- [SMB_COM_SEARCH \(section 2.2.4.58\)](#)
- [SMB_COM_FIND \(section 2.2.4.59\)](#)
- [SMB_COM_FIND_UNIQUE \(section 2.2.4.60\)](#)
- [SMB_COM_RENAME \(section 2.2.4.8\)](#)
- [SMB_COM_NT_RENAME \(section 2.2.4.66\)](#)
- [SMB_COM_CHECK_DIRECTORY \(section 2.2.4.17\)](#)
- [SMB_COM_QUERY_INFORMATION \(section 2.2.4.9\)](#)
- [SMB_COM_SET_INFORMATION \(section 2.2.4.10\)](#)
- [SMB_COM_OPEN_PRINT_FILE \(section 2.2.4.67\)](#)
- [SMB_COM_TRANSACTION \(section 2.2.4.33\)](#)

2.2.4.55.1 Request

```
SMB_Parameters
{
    UCHAR    WordCount;
    Words
    {
        UCHAR    AndXCommand;
        UCHAR    AndXReserved;
        USHORT   AndXOffset;
        USHORT   Flags;
        USHORT   PasswordLength;
    }
}
SMB_Data
{
    USHORT   ByteCount;
    Bytes
    {
```



```

    UCHAR Password[PasswordLength];
    UCHAR Pad[];
    SMB_STRING Path;
    OEM_STRING Service;
}
}

```

SMB_Header:

TID (2 bytes): This field MAY contain a valid TID. If the **SMB_Header.TID** is valid and the lowest-order bit of the **SMB_Parameters.Words.Flags** field is set, the **SMB_Header.TID** MUST be disconnected.

UID (2 bytes): This field MUST contain a UID returned in a previously successful [SMB_COM_SESSION_SETUP_ANDX Response \(section 2.2.4.53.2\)](#). If the server is operating in share level access control mode, then the UID represents anonymous, or "null session" authentication. If the server is operating in user level access control mode, then the server MUST validate the UID.

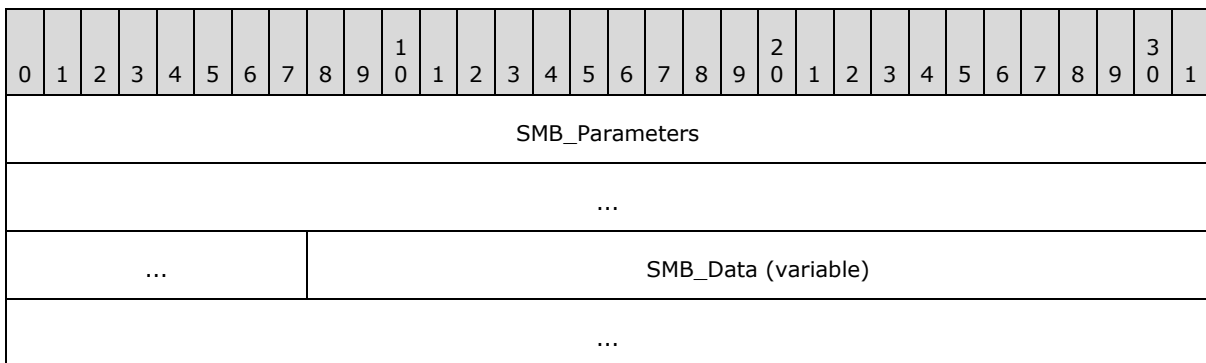

SMB_Parameters (9 bytes):

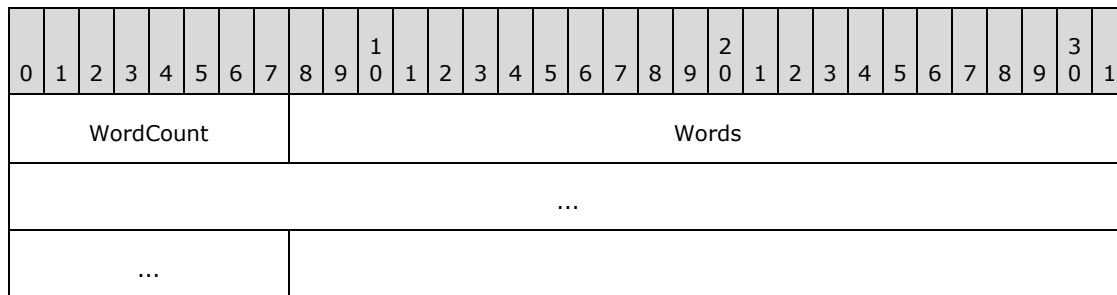

WordCount (1 byte): The value of this field MUST be 0x04.

Words (8 bytes):

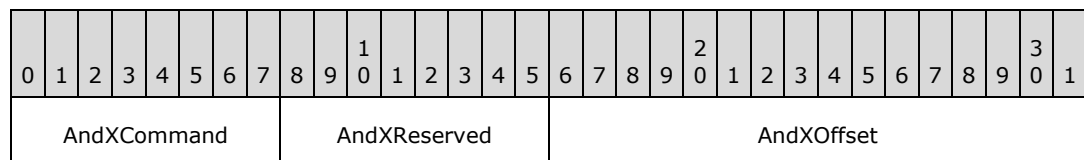

Flags	PasswordLength
-------	----------------

AndXCommand (1 byte): The command code for the next SMB command in the packet. This value MUST be set to 0xFF if there are no additional SMB command requests in the request packet.

AndXReserved (1 byte): A reserved field. This MUST be set to 0x00 when this request is sent, and the server MUST ignore this value.

AndXOffset (2 bytes): This field MUST be set to the offset in bytes from the start of the [SMB Header \(section 2.2.3.1\)](#) to the start of the **WordCount** field of the next SMB command request in this packet. This field is valid only if the **AndXCommand** field is not set to 0xFF. If **AndXCommand** is 0xFF, this field MUST be ignored by the server.

Flags (2 bytes): A 16-bit field used to modify the SMB_COM_TREE_CONNECT_ANDX Request (section 2.2.4.55.1). The client MUST set reserved values to 0, and the server MUST ignore them.

Bitmask	Meaning
TREE_CONNECT_ANDX_DISCONNECT_TID 0x0001	If this bit is set and the SMB_Header.TID field of the request is valid, the tree connect specified by the SMB_Header.TID field of the request SHOULD be disconnected when the server sends the response. If this tree disconnect fails, the error SHOULD be ignored. If this bit is set and the SMB_Header.TID field of the request is invalid, the server MUST ignore this bit.
0x0002	Reserved. SHOULD be zero. <105>
0xFFFC	Reserved. MUST be zero.

PasswordLength (2 bytes): This field MUST be the length, in bytes, of the **SMB_Data.Bytes.Password** field.

SMB_Data (variable):

0	1	2	3	4	5	6	7	8	9	10	11	12	13	14	15	16	17	18	19	20	21	22	23	24	25	26	27	28	29	30	31
ByteCount																Bytes (variable)															
...																															

ByteCount (2 bytes): The value of this field MUST be 0x0003 or greater.

Bytes (variable):

0	1	2	3	4	5	6	7	8	9	10	11	12	13	14	15	16	17	18	19	20	21	22	23	24	25	26	27	28	29	30	31
Password (variable)																															

...
Pad (variable)
...
Path (variable)
...
Service (variable)
...

Password (variable): An array of bytes.

- If the server is operating in share level access control mode and plaintext passwords have been negotiated, then the **Password** MUST be an OEM_STRING representing the user's password in plaintext.
- If the server is operating in share level access control mode and challenge/response authentication has been negotiated, then the **Password** MUST be an authentication response.
- If authentication is not used, then the **Password** SHOULD be a single null padding byte (which takes the place of the Pad[] byte).

The **SMB_Parameters.Bytes.PasswordLength** MUST be the full length of the **Password** field. If the **Password** is the null padding byte, the password length is 1.

Pad (variable): Padding bytes. If Unicode support has been enabled and SMB_FLAGS2_UNICODE is set in **SMB_Header.Flags2**, this field MUST contain zero or one null padding bytes as needed to ensure that the **Path** string is aligned on a 16-bit boundary.

Path (variable): A null-terminated string that represents the server and share name of the resource to which the client attempts to connect. This field MUST be encoded using Universal Naming Convention (UNC) syntax. If SMB_FLAGS2_UNICODE is set in the **Flags2** field of the SMB Header of the request, the string MUST be a null-terminated array of 16-bit Unicode characters. Otherwise, the string MUST be a null-terminated array of OEM characters. If the string consists of Unicode characters, this field MUST be aligned to start on a 2-byte boundary from the start of the SMB Header. A path in UNC syntax would be represented by a string in the following form:

```
\\server\share
```

Service (variable): The type of resource that the client attempts to access. This field MUST be a null-terminated array of OEM characters even if the client and server have negotiated to use Unicode strings. The valid values for this field are as follows:

Service String	Description
"A:"	Disk Share

Service String	Description
"LPT1:"	Printer Share
"IPC"	Named Pipe
"COMM"	Serial Communications device
"?????"	Matches any type of device or resource

2.2.4.55.2 Response

```

SMB_Parameters
{
  UCHAR  WordCount;
  Words
  {
    UCHAR  AndXCommand;
    UCHAR  AndXReserved;
    USHORT AndXOffset;
    USHORT OptionalSupport;
  }
}
SMB_Data
{
  USHORT ByteCount;
  Bytes
  {
    OEM_STRING Service;

    SMB_STRING NativeFileSystem;
  }
}

```

SMB_Header:

TID (2 bytes): If the command is successful, the **TID** field in the response header **MUST** contain the TID identifying the newly created connection.

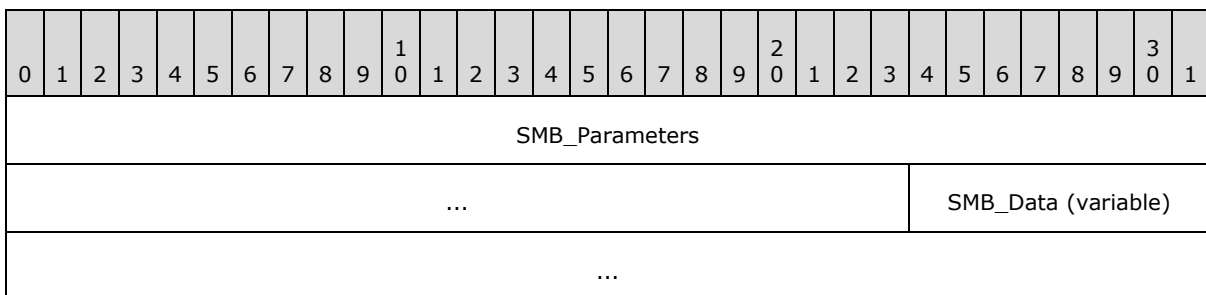

SMB_Parameters (7 bytes):

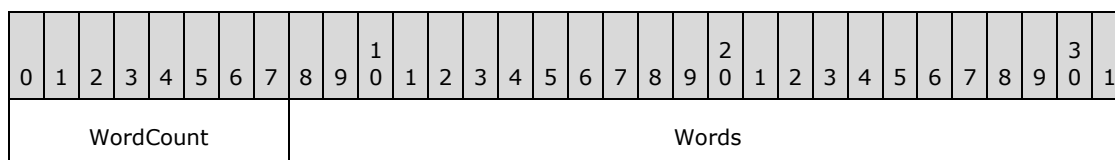

...

WordCount (1 byte): The value of this field MUST be 0x03.

Words (6 bytes):

0	1	2	3	4	5	6	7	8	9	10	11	12	13	14	15	16	17	18	19	20	21	22	23	24	25	26	27	28	29	30	31
AndXCommand										AndXReserved										AndXOffset											
OptionalSupport																															

AndXCommand (1 byte): The command code for the next SMB command in the packet. This value MUST be set to 0xFF if there are no additional SMB command responses in the server response packet.

AndXReserved (1 byte): A reserved field. This MUST be set to 0x00 when this response is sent, and the client MUST ignore this field.

AndXOffset (2 bytes): This field MUST be set to the offset in bytes from the start of the [SMB Header \(section 2.2.3.1\)](#) to the start of the **WordCount** field in the next SMB command response in this packet. This field is valid only if the **AndXCommand** field is not set to 0xFF. If **AndXCommand** is 0xFF, this field MUST be ignored by the client.

OptionalSupport (2 bytes): A 16-bit field. The following **OptionalSupport** field flags are defined. Any combination of the following flags MUST be supported. All undefined values are considered reserved. The server SHOULD set them to 0, and the client MUST ignore them.

Value	Meaning
SMB_SUPPORT_SEARCH_BITS 0x0001	If set, the server supports the use of SMB_FILE_ATTRIBUTES (section 2.2.1.2.4) exclusive search attributes in client requests.
SMB_SHARE_IS_IN_DFS 0x0002	If set, this share is managed by DFS, as specified in [MS-DFSC] .

SMB_Data (variable):

0	1	2	3	4	5	6	7	8	9	10	11	12	13	14	15	16	17	18	19	20	21	22	23	24	25	26	27	28	29	30	31
ByteCount																Bytes (variable)															
...																															

ByteCount (2 bytes): The value of this field MUST be greater than or equal to 0x0002.

Bytes (variable):

0	1	2	3	4	5	6	7	8	9	0	1	2	3	4	5	6	7	8	9	0	1	2	3	4	5	6	7	8	9	0	1
Service (variable)																															
...																															
NativeFileSystem (variable)																															
...																															

Service (variable): The type of the shared resource to which the **TID** is connected. The Service field **MUST** be encoded as a null-terminated array of OEM characters, even if the client and server have negotiated to use Unicode strings. The valid values for this field are as follows.

Service string	Description
"A:"	Disk Share
"LPT1:"	Printer Share
"IPC"	Named Pipe
"COMM"	Serial Communications device

NativeFileSystem (variable): The name of the file system on the local resource to which the returned **TID** is connected. If **SMB_FLAGS2_UNICODE** is set in the **Flags2** field of the SMB Header of the response, this value **MUST** be a null-terminated string of Unicode characters. Otherwise, this field **MUST** be a null-terminated string of OEM characters. For resources that are not backed by a file system, such as the **IPC\$** share used for named pipes, this field **MUST** be set to the empty string. [<106>](#)

Error Codes

SMB error class	SMB error code	NT status code	POSIX equivalent	Description
ERRDOS (0x01)	ERRbadpath (0x0003)	STATUS_OBJECT_PATH_NOT_FOUND (0xC000003A)	ENOENT	The share path does not reference a valid resource.
ERRDOS (0x01)	ERRnoaccess (0x0005)	STATUS_LOGON_FAILURE (0xC000006D)	EPERM	The server rejected the client logon attempt.
ERRDOS (0x01)	ERRnomem (0x0008)	STATUS_INSUFF_SERVER_RESOURCES (0xC0000205)	ENOMEM	The server is out of resources. Out of memory or TIDs.
ERRDOS	ERRpaused	STATUS_SHARING_PAUSED		The server is

SMB error class	SMB error code	NT status code	POSIX equivalent	Description
(0x01)	(0x0046)	(0xC00000CF)		temporarily paused.
ERRDOS (0x01)	ERRreqnotaccep (0x0047)	STATUS_REQUEST_NOT_ACCEPTED (0xC00000D0)		The server has no more connections available.
ERRSRV (0x02)	ERRerror (0x0001)	STATUS_INVALID_SMB (0x00010002)		Invalid SMB. Not enough parameter bytes were sent.
ERRSRV (0x02)	ERRbadpw (0x0002)	STATUS_LOGON_FAILURE (0xC000006D)		Incorrect password during logon attempt.
ERRSRV (0x02)	ERRaccess (0x0004)	STATUS_ACCESS_DENIED (0xC0000022)		The user is not authorized to access the resource.
ERRSRV (0x02)	ERRinvnetname (0x0006)	STATUS_BAD_NETWORK_NAME (0xC00000CC)		The share path is not valid.
ERRSRV (0x02)	ERRinvdevice (0x0007)	STATUS_BAD_DEVICE_TYPE (0xC00000CB)		Resource type invalid. Value of Service field in the request was invalid.
ERRSRV (0x02)	ERRbaduid (0x005B)	STATUS_SMB_BAD_UID (0x005B0002)		The UID supplied is not defined to the session.

2.2.4.56 SMB_COM_SECURITY_PACKAGE_ANDX (0x7E)

This command was introduced in the **LAN Manager 1.0** dialect. It is now obsolete.

This command was used to negotiate security packages and related information, but is no longer used. Documentation describing the implementation of this command can be found in [XOPEN-SMB] section 11.2. Clients SHOULD NOT send requests using this command code. Servers receiving requests with this command code SHOULD return STATUS_NOT_IMPLEMENTED (ERRDOS/ERRbadfunc).<107>

2.2.4.57 SMB_COM_QUERY_INFORMATION_DISK (0x80)

This is an original **Core Protocol** command. **This command is deprecated.** New client implementations SHOULD use the SMB_COM_TRANSACTION2 command along with a subcommand of TRANS2_QUERY_FS_INFORMATION.

This command MAY be sent by a client to obtain the capacity and remaining free space on the volume hosting the subtree indicated by the **TID** in the [SMB Header \(section 2.2.3.1\)](#). The client

MUST provide a valid **TID** in the SMB Header. The **TID** SHOULD have been acquired through a previously successful use of one of the SMB commands for connecting to a subtree.

The block or allocation units used in the response MAY be independent of the actual physical or logical allocation algorithm(s) used internally by the server. However, they MUST accurately reflect the amount of space on the server.

The response returns only 16 bits of information for each field. It is possible that some system require more than this amount of information. **TotalUnits** is commonly much larger than 65,535. However, the typical client relies on total disk size in bytes, and the free space in bytes. Hence the server SHOULD adjust the relative values of **BlocksPerUnit** and **BlockSize** to achieve the most accurate representation possible, given the 16-bit restriction. If after all adjustment, the values still exceed a 16-bit representation, the largest possible values for **TotalUnits** or **FreeUnits** (0xFFFF) SHOULD be returned.

2.2.4.57.1 Request

```
SMB_Parameters
{
  UCHAR WordCount;
}
SMB_Data
{
  USHORT ByteCount;
}
```

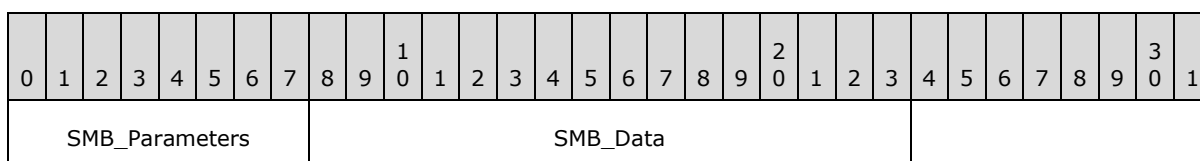

SMB_Parameters (1 byte):

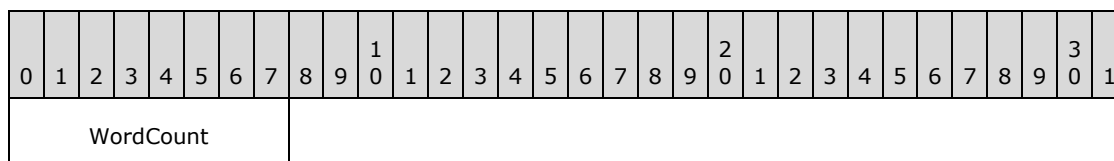

WordCount (1 byte): This field MUST be 0x00. No parameters are sent by this command.

SMB_Data (2 bytes):

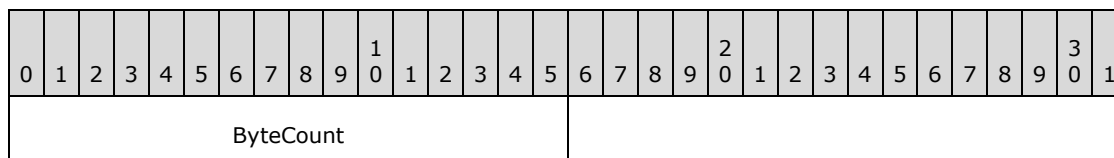

ByteCount (2 bytes): This field MUST be 0x0000. No data is sent by this command.

2.2.4.57.2 Response

```

SMB_Parameters
{
  UCHAR WordCount;
  Words
  {
    USHORT TotalUnits;
    USHORT BlocksPerUnit;
    USHORT BlockSize;
    USHORT FreeUnits;
    USHORT Reserved;
  }
}
SMB_Data
{
  USHORT ByteCount;
}

```

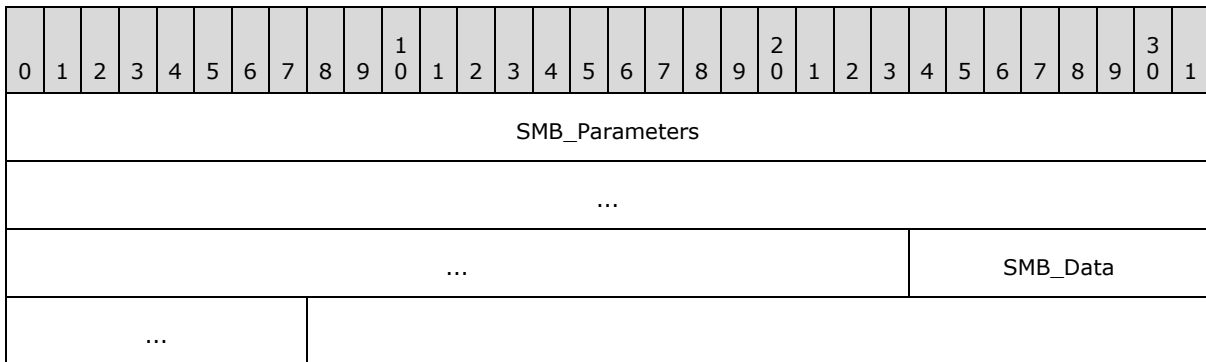

SMB_Parameters (11 bytes):

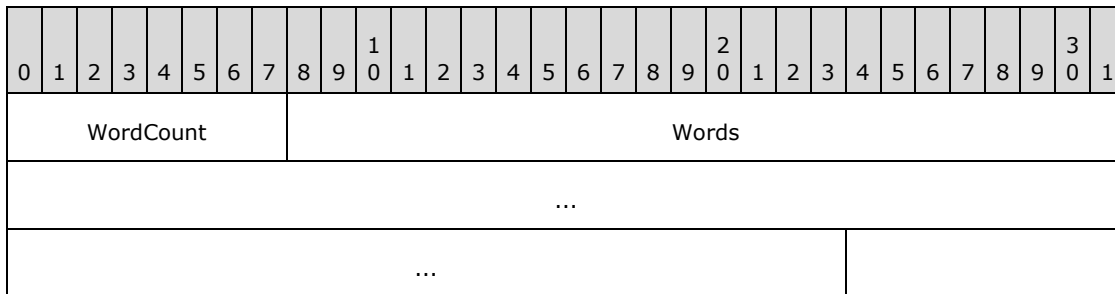

WordCount (1 byte): This field MUST be 0x05.

Words (10 bytes):

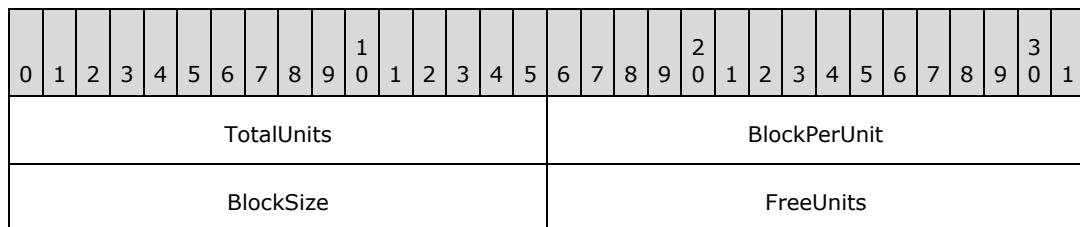

Reserved

TotalUnits (2 bytes): This field is a 16-bit unsigned value that represents the total count of logical allocation units available on the volume.

BlockPerUnit (2 bytes): This field is a 16-bit unsigned value that represents the number of blocks per allocation unit for the volume.

BlockSize (2 bytes): This field is a 16-bit unsigned value that represents the size in bytes of each allocation unit for the volume.

FreeUnits (2 bytes): This field is a 16-bit unsigned value that represents the total number of free allocation units available on the volume.

Reserved (2 bytes): This field is a 16-bit unsigned field and is reserved. The client SHOULD ignore this field.

SMB_Data (2 bytes):

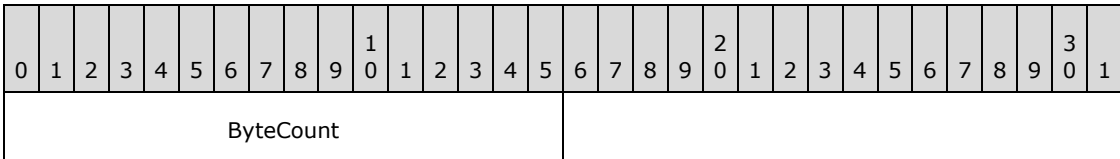

ByteCount (2 bytes): This field MUST be 0x0000. No data is sent by this message.

Error Codes

SMB error class	SMB error code	NT status code	POSIX equivalent	Description
ERRDOS (0x01)	ERRnomem (0x0008)	STATUS_INSUFF_SERVER_RESOURCES (0xC0000205)	ENOMEM	The server is out of resources.
ERRDOS (0x01)	ERRnoaccess (0x0005)	STATUS_ACCESS_DENIED (0xC0000022)		Permissions denied request on the file system.
ERRSRV (0x02)	ERRerror (0x0001)	STATUS_INVALID_SMB (0x00010002)		Unspecified internal server error.
ERRSRV (0x02)	ERRaccess (0x0004)	STATUS_NETWORK_ACCESS_DENIED (0xC00000CA)	EACCES	Client does not have the required read permissions on the share.
ERRSRV (0x02)	ERRinvtid (0x0005)	STATUS_SMB_BAD_TID (0x00050002)	ENOTDIR	The TID specified in the command was invalid OR The directory referenced by the TID has been removed from the system.

SMB error class	SMB error code	NT status code	POSIX equivalent	Description
ERRSRV (0x02)	ERRbaduid (0x005B)	STATUS_SMB_BAD_UID (0x005B0002)		The UID specified is not defined as a valid ID on this server session, or the user identified by the UID does not have sufficient privileges.
ERRHRD (0x03)	ERRnotready (0x0015)	STATUS_NO_MEDIA_IN_DEVICE (0xC0000013)	ENOENT	The file system has been removed from the system.
ERRHRD (0x03)	ERRdata (0x0017)		EIO	Physical I/O error while reading disk resource.

2.2.4.58 SMB_COM_SEARCH (0x81)

This is an original **Core Protocol** command. **This command is deprecated.** New client implementations SHOULD use the TRANS2_FIND_FIRST2 subcommand (section [2.2.6.2](#)) instead.

The SMB_COM_SEARCH command searches a directory for files or other objects that have names matching a given wildcard template. The response message contains as many of the found names as can fit, given the maximum buffer size. The response message also contains a continuation key that MAY be used in subsequent SMB_COM_SEARCH command messages to return the next set of matching names.

This command returns only 8.3 name format file names, and the base set of file attributes. Unicode is not supported; names are returned in the extended **ASCII (OEM) character set** only. There is no close operation associated with SMB_COM_SEARCH. The server MUST maintain search state until the end of the search is reached, the **PID** or **TID** associated with the search is closed, the **UID** associated with the search is invalidated (logged off), or the session is closed.

2.2.4.58.1 Request

```

SMB_Parameters
{
    UCHAR    WordCount;
    Words
    {
        USHORT MaxCount;
        SMB_FILE_ATTRIBUTES SearchAttributes;
    }
}
SMB_Data
{
    USHORT ByteCount;
    Bytes
    {
        UCHAR          BufferFormat1;
        SMB_STRING     FileName;
        UCHAR          BufferFormat2;
    }
}

```

```

USHORT      ResumeKeyLength;
SMB_Resume_Key ResumeKey[ResumeKeyLength];
}
}

```

SMB_Header

TID (2 bytes): A valid TID MUST be provided. The TID MUST refer to a file system subtree.

UID (2 bytes): A valid UID MUST be provided and MUST have, at a minimum, read permission on all directories in the **FileName** path.

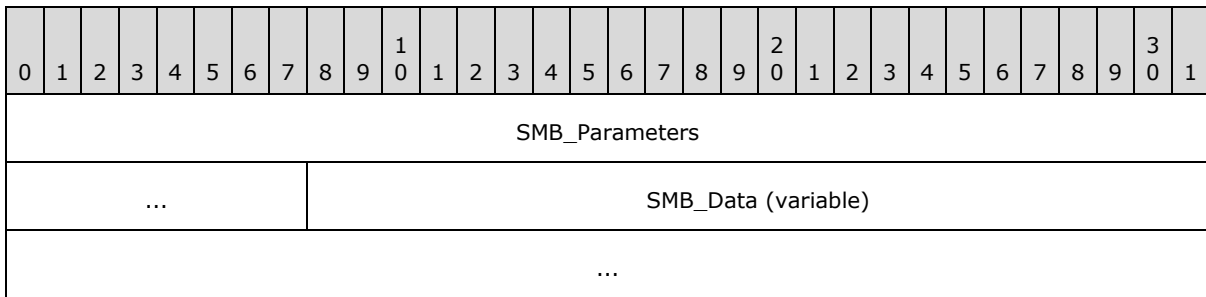

SMB_Parameters (5 bytes):

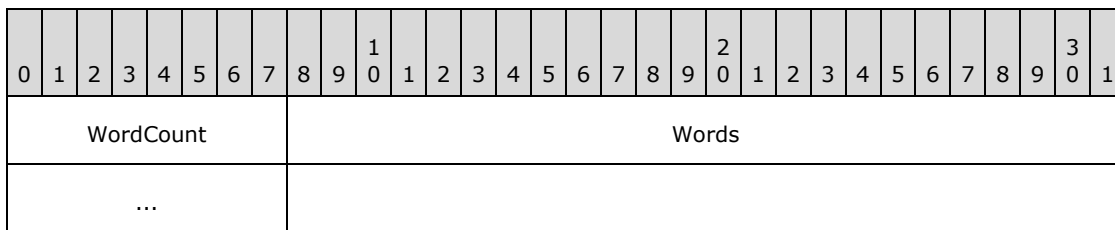

WordCount (1 byte): This field MUST be 0x02.

Words (4 bytes):

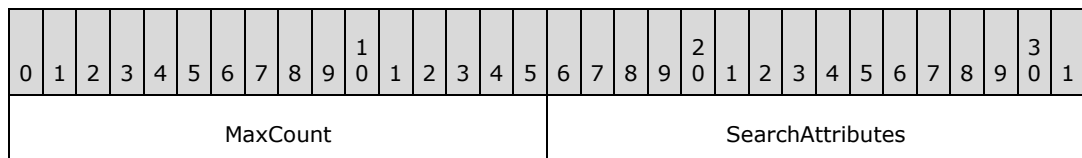

MaxCount (2 bytes): The maximum number of directory entries to return. This value represents the maximum number of entries across the entirety of the search, not just the initial response.

SearchAttributes (2 bytes): An attribute mask used to specify the standard attributes a file MUST have in order to match the search. If the value of this field is 0x0000, then only normal files are returned. If the Volume Label attribute is set, the server MUST return only the volume label (the Volume Label attribute is exclusive). If the Directory, System, or Hidden attributes are specified, then those entries are returned in addition to the normal files. Exclusive search attributes (see section [2.2.1.2.4](#)) can also be set.

SMB_Data (variable):

0	1	2	3	4	5	6	7	8	9	10	11	12	13	14	15	16	17	18	19	20	21	22	23	24	25	26	27	28	29	30	31
ByteCount																Bytes (variable)															
...																															

ByteCount (2 bytes): This field MUST be 0x0005 or greater.

Bytes (variable):

0	1	2	3	4	5	6	7	8	9	10	11	12	13	14	15	16	17	18	19	20	21	22	23	24	25	26	27	28	29	30	31
BufferFormat1										FileName (variable)																					
...																															
BufferFormat2										ResumeKeyLength												ResumeKey (variable)									
...																															

BufferFormat1 (1 byte): This field MUST be 0x04, which indicates that a null-terminated SMB_STRING is to follow.

FileName (variable): A null-terminated SMB_STRING. This is the full directory path (relative to the TID) of the file(s) being sought. Only the final component of the path MAY contain wildcards. This string MAY be the empty string.

BufferFormat2 (1 byte): This field MUST be 0x05, which indicates a variable block is to follow.

ResumeKeyLength (2 bytes): This field MUST be either 0x0000 or 21 (0x0015). If the value of this field is 0x0000, this is an initial search request. The server MUST allocate resources to maintain search state so that subsequent requests MAY be processed. If the value of this field is 21 (0x0015), this request MUST be the continuation of a previous search, and the next field MUST contain a **ResumeKey** previously returned by the server.

ResumeKey (variable): **SMB_Resume_Key** If the value of **ResumeKeyLength** is 21 (0x0015), this field MUST contain a **ResumeKey** returned by the server in response to a previous SMB_COM_SEARCH request. The **ResumeKey** contains data used by both the client and the server to maintain the state of the search. The structure of the **ResumeKey** follows:

```
SMB_Resume_Key
{
    UCHAR Reserved;
    UCHAR ServerState[16];
    UCHAR ClientState[4];
}
```

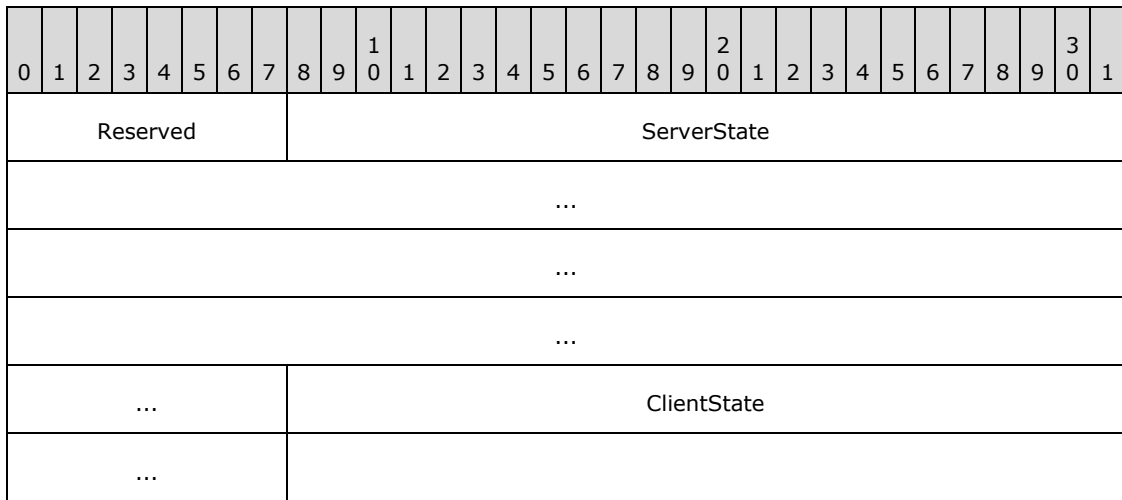

Reserved (1 byte): This field is reserved and MUST NOT be modified by the client. Older documentation is contradictory as to whether this field is reserved for client side or server side use. New server implementations SHOULD avoid using or modifying the content of this field. [<108>](#)

ServerState (16 bytes): This field is maintained by the server and MUST NOT be modified by the client. The contents of this field are server-specific. [<109>](#)

ClientState (4 bytes): This field MAY be used by the client to maintain state across a series of SMB_COM_SEARCH calls. The value provided by the client MUST be returned in each **ResumeKey** provided in the response. The contents of this field are client-specific.

2.2.4.58.2 Response

```

SMB_Parameters
{
    UCHAR    WordCount;
    Words
    {
        USHORT Count;
    }
}
SMB_Data
{
    USHORT ByteCount;
    Bytes
    {
        UCHAR                BufferFormat;
        USHORT                DataLength;
        SMB_Directory_Information DirectoryInformationData[DataLength];
    }
}

```

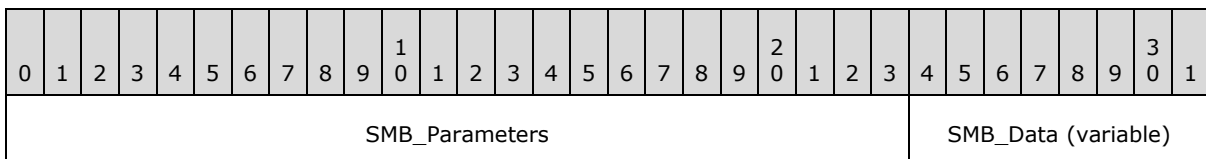

...

SMB_Parameters (3 bytes):

0	1	2	3	4	5	6	7	8	9	10	11	12	13	14	15	16	17	18	19	20	21	22	23	24	25	26	27	28	29	30	31
WordCount										Words																					

WordCount (1 byte): This field MUST be 0x01.

Words (2 bytes):

0	1	2	3	4	5	6	7	8	9	10	11	12	13	14	15	16	17	18	19	20	21	22	23	24	25	26	27	28	29	30	31
Count																															

Count (2 bytes): The number of directory entries returned in this response message. This value MUST be less than or equal to the value of **MaxCount** in the initial request.

SMB_Data (variable):

0	1	2	3	4	5	6	7	8	9	10	11	12	13	14	15	16	17	18	19	20	21	22	23	24	25	26	27	28	29	30	31		
ByteCount																	Bytes (variable)																
...																																	

ByteCount (2 bytes): This field MUST be greater than or equal to 0x0003.

Bytes (variable):

0	1	2	3	4	5	6	7	8	9	10	11	12	13	14	15	16	17	18	19	20	21	22	23	24	25	26	27	28	29	30	31		
BufferFormat										DataLength													DirectoryInformationData (variable)										
...																																	

BufferFormat (1 byte): This field MUST be 0x05, which indicates that a variable-size block is to follow.

DataLength (2 bytes): The size, in bytes, of the **DirectoryInformationData** array, which follows. This field MUST be equal to 43 times the value of **SMB_Parameters.Count**.

DirectoryInformationData (variable): Array of SMB_Directory_Information An array of zero or more SMB_Directory_Information records. The structure and contents of these records is specified below. Note that the SMB_Directory_Information record structure is a fixed 43 bytes in length.

```
SMB_Directory_Information
{
  SMB_Resume_Key      ResumeKey;
  UCHAR               FileAttributes;
  SMB_TIME             LastWriteTime;
  SMB_DATE             LastWriteDate;
  ULONG               FileSize;
  OEM_STRING          FileName;
}
```

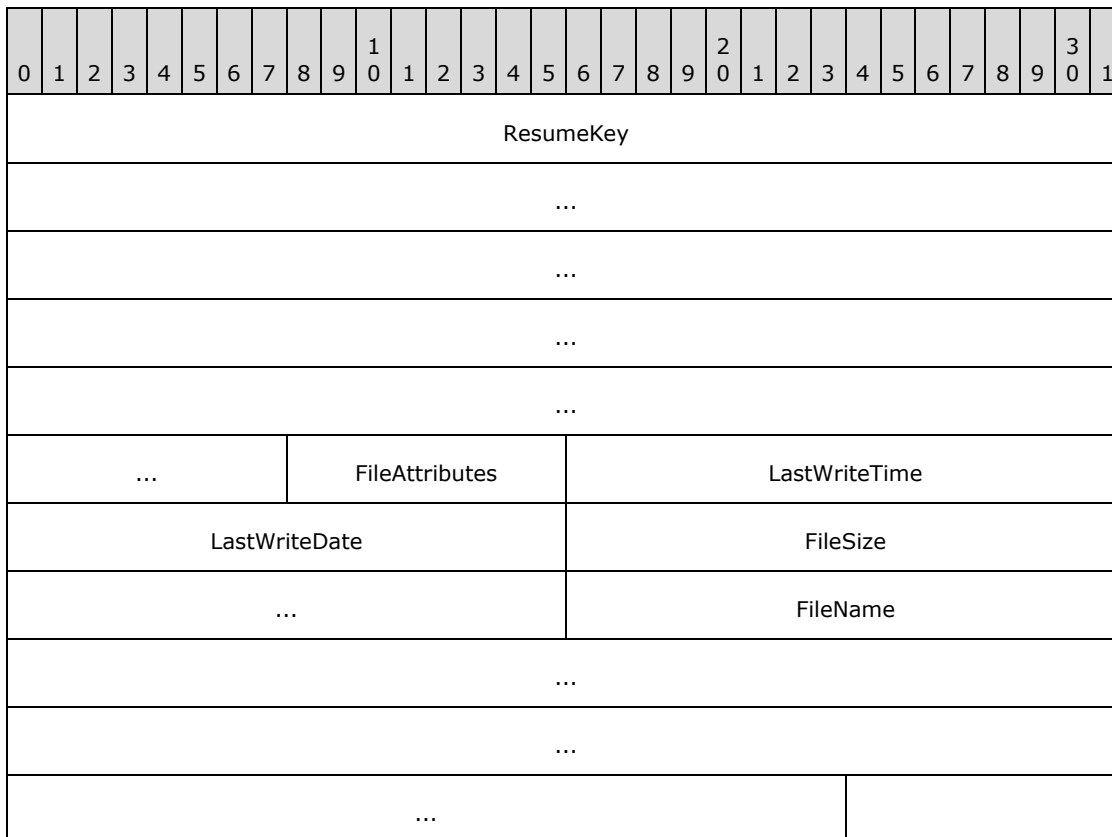

ResumeKey (21 bytes): SMB_Resume_Key While each **DirectoryInformationData** entry has a **ResumeKey** field, the client MUST use only the **ResumeKey** value from the last **DirectoryInformationData** entry when continuing the search with a subsequent SMB_COM_SEARCH command.

FileAttributes (1 byte): These are the file system attributes of the file.

LastWriteTime (2 bytes): The time when the file was last modified. The SMB_TIME structure contains a set of bit fields indicating hours, minutes, and seconds (with a 2 second resolution).

LastWriteDate (2 bytes): The date when the file was last modified. The SMB_DATE structure contains a set of bit fields indicating the year, month, and date.

FileSize (4 bytes): The size of the file, in bytes. If the file is larger than (2 ** 32 - 1) bytes in size, the server SHOULD return the least significant 32 bits of the file size.

FileName (13 bytes): The null-terminated 8.3 name format file name. The file name and extension, including the '.' delimiter MUST be left-justified in the field. The character string MUST be padded with " " (space) characters, as necessary, to reach 12 bytes in length. The final byte of the field MUST contain the terminating null character.

Error Codes

SMB error class	SMB error code	NT status code	POSIX equivalent	Description
ERRDOS (0x01)	ERRbadpath (0x0003)	STATUS_OBJECT_PATH_NOT_FOUND (0xC000003A) STATUS_OBJECT_PATH_SYNTAX_BAD (0xC000003B)	ENOTDIR	A non-terminal component of the specified path was not a directory OR the path syntax is invalid.
ERRDOS (0x01)	ERRnoaccess (0x0005)	STATUS_ACCESS_DENIED (0xC0000022)	EACCES	No file system permission on the specified pathname.
ERRDOS (0x01)	ERRbadfid (0x0006)	STATUS_INVALID_HANDLE (0xC0000008) STATUS_SMB_BAD_FID (0x00060001)	ENFILE	Attempt to resume a search that was not active on the server.
ERRDOS (0x01)	ERRnomem (0x0008)	STATUS_INSUFF_SERVER_RESOURCES (0xC0000205)		The server is out of resources.
ERRDOS (0x01)	ERRnofiles (0x0012)	STATUS_NO_MORE_FILES (0x80000006)	EOF	No more matching files found on the server.
ERRSRV (0x02)	ERRerror (0x0001)	STATUS_INVALID_SMB (0x00010002)		Invalid SMB request.

SMB error class	SMB error code	NT status code	POSIX equivalent	Description
ERRSRV (0x02)	ERRinvtid (0x0005)	STATUS_SMB_BAD_TID (0x00050002)		The TID is no longer valid.
ERRDOS (0x01)	ERROR_NO_MORE_SEARCH_HANDLES (0x0071)	STATUS_OS2_NO_MORE_SIDS (0x00710001)	EMFILE ENFILE	Maximum number of searches has been exhausted.
ERRSRV (0x02)	ERRbaduid (0x005B)	STATUS_SMB_BAD_UID (0x005B0002)		The UID in the header is not valid for this session.
ERRHRD (0x03)	ERRdata (0x0017)	STATUS_CRC_ERROR (0xC000003F)	EIO	Data I/O error (incorrect CRC on device).

In [XOPEN-SMB] it is noted that POSIX-style servers MAY also generate ENOENT while searching for files. ENOENT errors MUST be handled on the server side and MUST NOT be returned to the client.

2.2.4.59 SMB_COM_FIND (0x82)

This command was introduced in the **LAN Manager 1.0** dialect. **This command is deprecated.** New client implementations SHOULD use the SMB_COM_TRANSACTION2 subcommand TRANS2_FIND_FIRST2 (section [2.2.6.2](#)) instead.

This command is identical in structure and purpose to SMB_COM_SEARCH. The only difference is that SMB_COM_FIND is paired with the SMB_COM_FIND_CLOSE command, which allows the client to explicitly close a search operation.

2.2.4.59.1 Request

```

SMB_Parameters
{
    UCHAR    WordCount;
    Words
    {
        USHORT           MaxCount;
        SMB_FILE_ATTRIBUTES SearchAttributes;
    }
}
SMB_Data
{
    USHORT ByteCount;
    Bytes
    {

```

```

    UCHAR          BufferFormat1;
    SMB_STRING     FileName;
    UCHAR          BufferFormat2;
    USHORT         ResumeKeyLength;
    SMB_Resume_Key ResumeKey[ResumeKeyLength];
}
}

```

SMB_Header:

TID (2 bytes): A valid **TID** MUST be provided. The **TID** MUST refer to a file system subtree.

UID (2 bytes): A valid **UID** MUST be provided and MUST have, at a minimum, read permission on all directories in the **FileName** path.

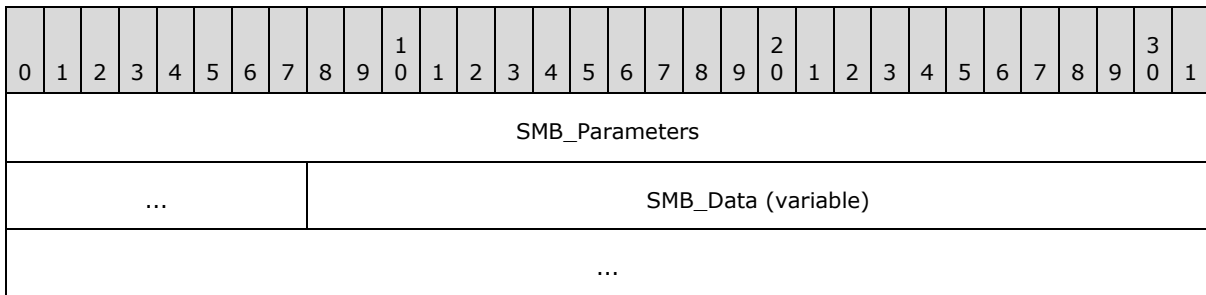

SMB_Parameters (5 bytes):

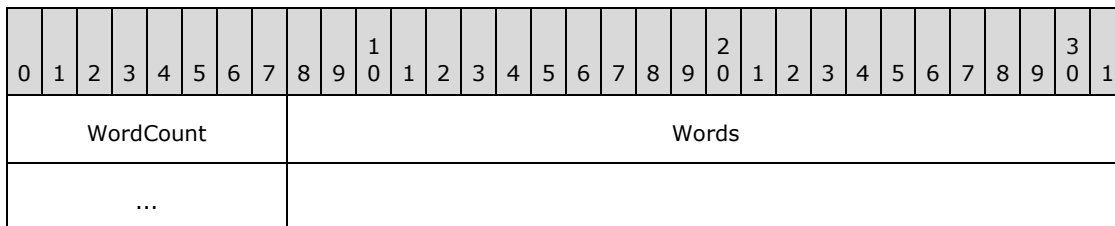

WordCount (1 byte): This field MUST be 0x02.

Words (4 bytes):

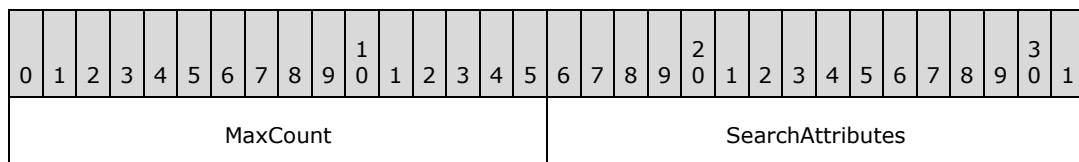

MaxCount (2 bytes): The maximum number of directory entries to return. This value represents the maximum number of entries across the entirety of the search, not just the initial response.

SearchAttributes (2 bytes): An attribute mask used to specify the standard attributes that a file MUST have to match the search. If the value of this field is 0x0000, then only normal files MUST be returned. If the Volume Label attribute is set, the server MUST return only the volume label (the Volume Label attribute is exclusive). If the Directory, System, or Hidden attributes are specified,

then those entries MUST be returned in addition to the normal files. Exclusive search attributes (see section [2.2.1.2.4](#)) can also be set.

SMB_Data (variable):

0	1	2	3	4	5	6	7	8	9	10	11	12	13	14	15	16	17	18	19	20	21	22	23	24	25	26	27	28	29	30	31
ByteCount																Bytes (variable)															
...																															

ByteCount (2 bytes): This field MUST be 0x0005 or greater.

Bytes (variable):

0	1	2	3	4	5	6	7	8	9	10	11	12	13	14	15	16	17	18	19	20	21	22	23	24	25	26	27	28	29	30	31
BufferFormat1										FileName (variable)																					
...																															
BufferFormat2										ResumeKeyLength												ResumeKey (variable)									
...																															

BufferFormat1 (1 byte): This field MUST be 0x04, which indicates that a null-terminated ASCII string is to follow.

FileName (variable): A null-terminated character string. This is the full directory path (relative to the **TID**) of the file(s) being sought. Only the final component of the path MAY contain wildcards. This string MAY be the empty string.

BufferFormat2 (1 byte): This field MUST be 0x05, which indicates that a variable block is to follow.

ResumeKeyLength (2 bytes): This field MUST be either 0x0000 or 21 (0x0015). If the value of this field is 0x0000, then this is an initial search request. The server MUST allocate resources to maintain search state so that subsequent requests can be processed. If the value of this field is 21 (0x0015) then this request MUST be the continuation of a previous search, and the next field MUST contain a **ResumeKey** previously returned by the server.

ResumeKey (variable): If the value of the **ResumeKeyLength** field is 21 (0x0015), this field MUST contain a **ResumeKey** returned by the server in response to a previous SMB_COM_SEARCH request. The **ResumeKey** contains data used by both the client and the server to maintain the state of the search. The structure of the **ResumeKey** follows.

```
SMB_Resume_Key
{
    UCHAR Reserved;
    UCHAR ServerState[16];
}
```

```

    UCHAR ClientState[4];
}

```

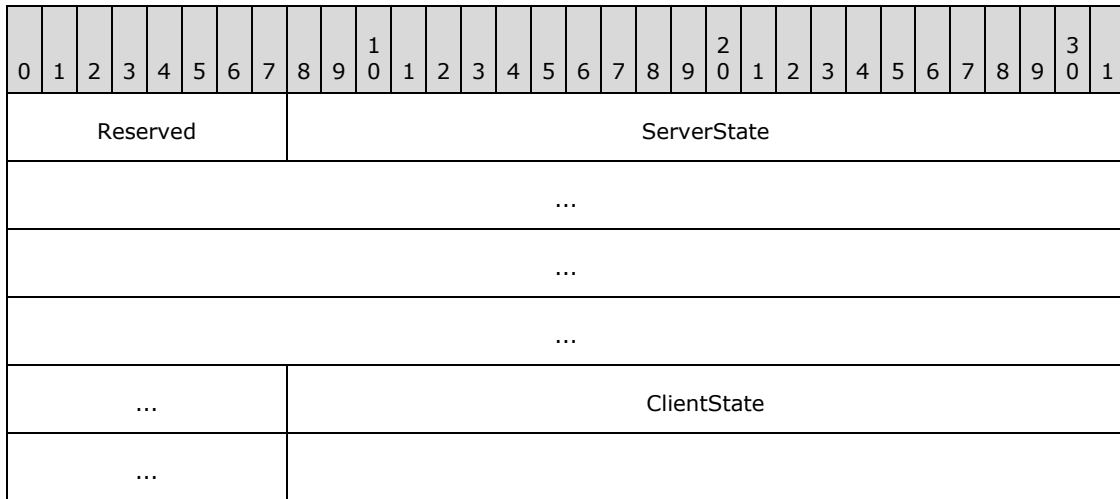

Reserved (1 byte): This field is reserved and MUST NOT be modified by the client. Older documentation is contradictory as to whether this field is reserved for client-side or server-side use. New server implementations SHOULD avoid using or modifying the content of this field.

ServerState (16 bytes): This field is maintained by the server and MUST NOT be modified by the client. The contents of this field are server-specific.

ClientState (4 bytes): Array of UCHAR This field MAY be used by the client to maintain state across a series of SMB_COM_SEARCH calls. The value provided by the client MUST be returned in each **ResumeKey** provided in the response. The contents of this field are client-specific.

2.2.4.59.2 Response

```

SMB_Parameters
{
    UCHAR    WordCount;
    Words
    {
        USHORT    Count;
    }
}
SMB_Data
{
    USHORT    ByteCount;
    Bytes
    {
        UCHAR                BufferFormat;
        USHORT                DataLength;
        SMB_Directory_Information    DirectoryInformationData[DataLength];
    }
}

```

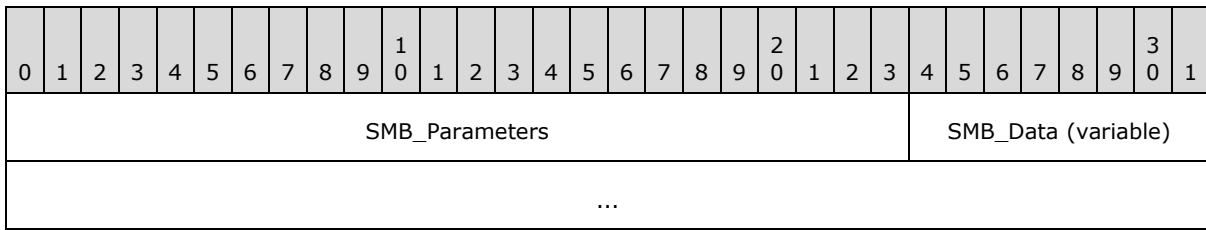

SMB_Parameters (3 bytes):



WordCount (1 byte): This field MUST be 0x01.

Words (2 bytes):

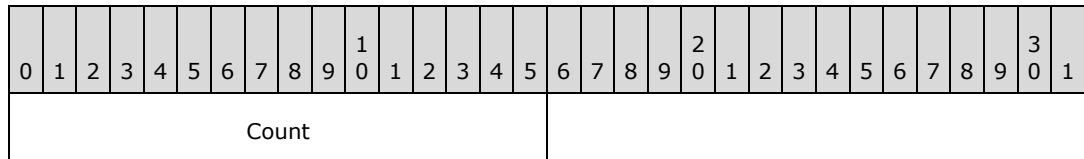

Count (2 bytes): The number of directory entries returned in this response message. This value MUST be less than or equal to the value of **MaxCount** in the initial request.

SMB_Data (variable):

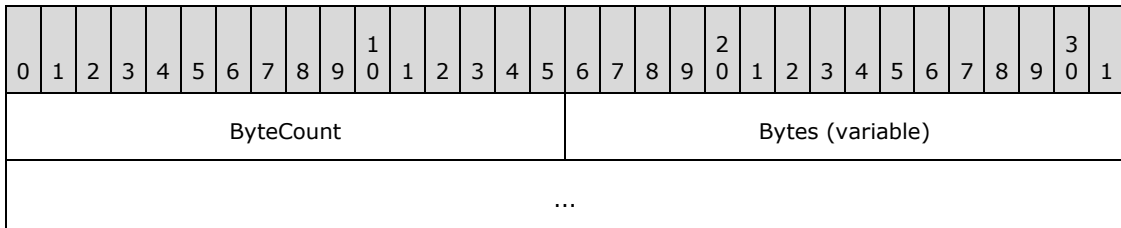

ByteCount (2 bytes): This field MUST be greater than or equal to 0x0003.

Bytes (variable):

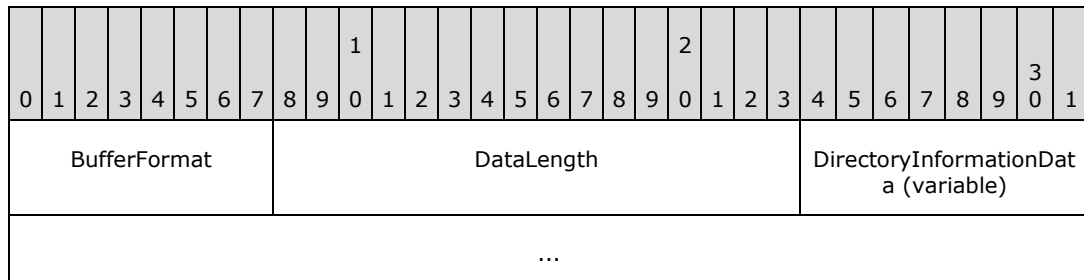

BufferFormat (1 byte): This field MUST be 0x05, which indicates that a variable-size block is to follow.

DataLength (2 bytes): The size, in bytes, of the **DirectoryInformationData** array, which follows. This field MUST be equal to 43 times the value of **SMB_Parameters.Words.Count**.

DirectoryInformationData (variable): An array of zero or more SMB_Directory_Information records. The structure and contents of these records is specified below. Note that the SMB_Directory_Information record structure is a fixed 43 bytes in length.

```
SMB_Directory_Information
{
    SMB_Resume_Key      ResumeKey;
    UCHAR               FileAttributes;
    SMB_TIME            LastWriteTime;
    SMB_DATE            LastWriteDate;
    ULONG               FileSize;
    OEM_STRING          FileName[13];
}
```

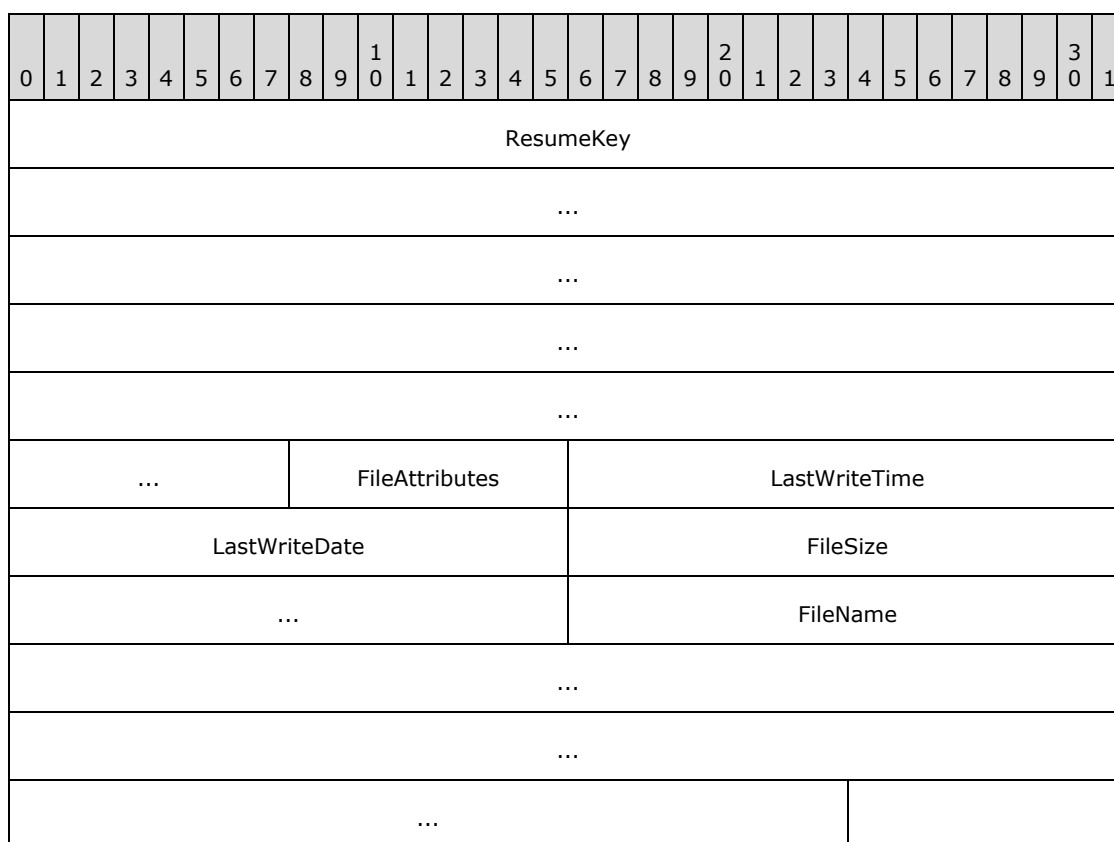

ResumeKey (21 bytes): SMB_Resume_Key While each **DirectoryInformationData** entry has a **ResumeKey** field, the client MUST use only the **ResumeKey** value from the last **DirectoryInformationData** entry when continuing the search with a subsequent SMB_COM_SEARCH command.

FileAttributes (1 byte): These are the file system attributes of the file.

LastWriteTime (2 bytes): The time at which the file was last modified.

LastWriteDate (2 bytes): The date when the file was last modified.

FileSize (4 bytes): The size of the file, in bytes. If the file is larger than (2 ** 32 - 1) bytes in size, the server SHOULD return the least-significant 32 bits of the file size.

FileName (13 bytes): The null-terminated **8.3 name** format file name. The file name and extension, including the '.' delimiter MUST be left-justified in the field. The character string MUST be padded with " " (space) characters, as necessary, to reach 12 bytes in length. The final byte of the field MUST contain the terminating null character.

Error Codes

SMB error class	SMB error code	NT status code	POSIX equivalent	Description
ERRDOS (0x01)	ERRbadpath (0x0003)	STATUS_OBJECT_PATH_NOT_FOUND (0xC000003A) STATUS_OBJECT_PATH_SYNTAX_BAD (0xC000003B)	ENOTDIR	A non-terminal component of the specified path was not a directory OR the path syntax is invalid.
ERRDOS (0x01)	ERRnoaccess (0x0005)	STATUS_ACCESS_DENIED (0xC0000022)	EACCESS	No file system permission on the specified pathname.
ERRDOS (0x01)	ERRbadfid (0x0006)	STATUS_INVALID_HANDLE (0xC0000008) STATUS_SMB_BAD_FID (0x00060001)	ENFILE	Attempt to resume a search that was not active on the server.
ERRDOS (0x01)	ERRnomem (0x0008)	STATUS_INSUFF_SERVER_RESOURCES (0xC0000205)		The server is out of resources.
ERRDOS (0x01)	ERRnofiles (0x0012)	STATUS_NO_MORE_FILES (0x80000006)	EOF	No more matching files found on the server.
ERRSRV	ERRerror (0x0001)	STATUS_INVALID_SMB (0x00010002)		Invalid SMB

SMB error class	SMB error code	NT status code	POSIX equivalent	Description
(0x02)				request.
ERRSRV (0x02)	ERRinvtid (0x0005)	STATUS_SMB_BAD_TID (0x00050002)		The TID is no longer valid.
ERRDOS (0x01)	ERROR_NO_MORE_SEARCH_HANDLES (0x0071)	STATUS_OS2_NO_MORE_SIDS (0x00710001)	EMFILE ENFILE	Maximum number of searches has been exhausted.
ERRSRV (0x02)	ERRbaduid (0x005B)	STATUS_SMB_BAD_UID (0x005B0002)		The UID in the header is not valid for this session.
ERRHRD (0x03)	ERRdata (0x0017)	STATUS_CRC_ERROR (0xC000003F)	EIO	Data I/O error (incorrect CRC on device).

In [XOPEN-SMB] it is noted that POSIX-style servers MAY also generate ENOENT while searching for files. ENOENT errors MUST be handled on the server side and MUST NOT be returned to the client.

2.2.4.60 SMB_COM_FIND_UNIQUE (0x83)

This command was introduced in the **LAN Manager 1.0** dialect. **This command is deprecated.** New client implementations SHOULD use the SMB_COM_TRANSACTION2 subcommand TRANS2_FIND_FIRST2 (section [2.2.6.2](#)) instead.

SMB_COM_FIND_UNIQUE has nearly the same format as SMB_COM_SEARCH and SMB_COM_FIND, with the exception that the Request Field **SMB_Data.ResumeKey** is never present. The use of this command, as opposed to SMB_COM_SEARCH or SMB_COM_FIND, indicates to the server that it need not maintain a search context or any other state. The SMB_COM_FIND_UNIQUE command is single-use. No follow-up commands are permitted.

As with the other search commands in this family, the request MAY include wildcard characters. The server MAY return as many matching file names as can fit in a single response. If there are any matching names, the server MUST return at least one matching name. After the SMB_COM_FIND_UNIQUE response has been returned, the search is closed.

2.2.4.60.1 Request

```
SMB_Parameters
{
    UCHAR WordCount;
    Words
    {
```

```

    USHORT          MaxCount;
    SMB_FILE_ATTRIBUTES SearchAttributes;
}
}
SMB_Data
{
    USHORT ByteCount;
    Bytes
    {
        UCHAR          BufferFormat1;
        SMB_STRING     FileName;
        UCHAR          BufferFormat2;
        USHORT         ResumeKeyLength;
        SMB_Resume_Key ResumeKey[ResumeKeyLength];
    }
}
}

```

SMB_Header:

TID (2 bytes): A valid **TID** MUST be provided. The **TID** MUST refer to a file system subtree.

UID (2 bytes): A valid **UID** MUST be provided and MUST have, at a minimum, read permission on all directories in the **FileName** path.

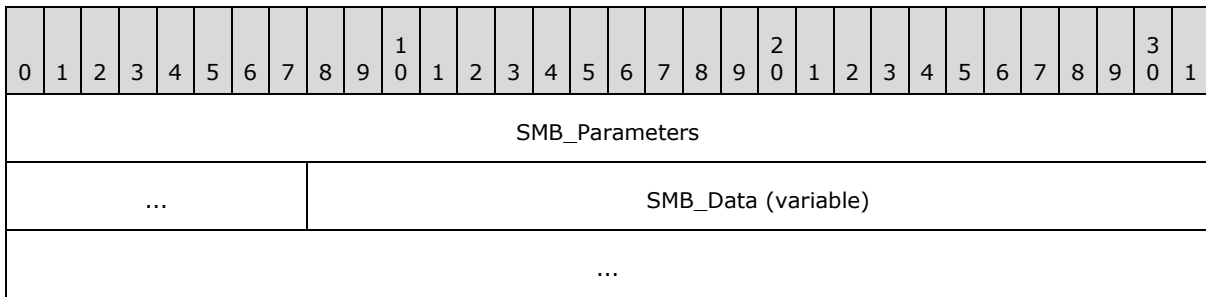

SMB_Parameters (5 bytes):

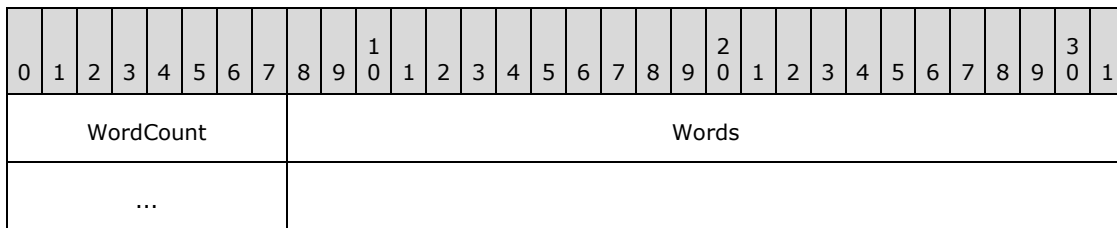

WordCount (1 byte): This field MUST be 0x02.

Words (4 bytes):

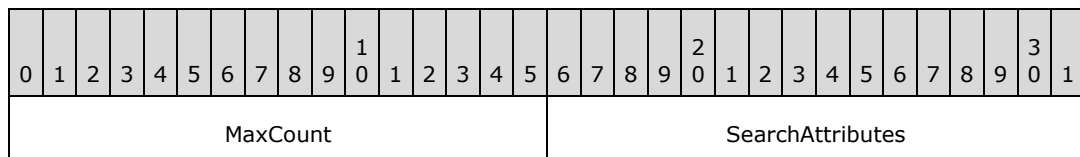

MaxCount (2 bytes): The maximum number of directory entries to return.

SearchAttributes (2 bytes): An attribute mask used to specify the standard attributes that a file MUST have in order to match the search. If the value of this field is 0, then only normal files MUST be returned. If the Volume Label attribute is set, then the server MUST only return the volume label. If the Directory, System, or Hidden attributes are specified, then those entries MUST be returned in addition to the normal files. Exclusive search attributes (see section [2.2.1.2.4](#)) can also be set.

SMB_Data (variable):

0	1	2	3	4	5	6	7	8	9	10	11	12	13	14	15	16	17	18	19	20	21	22	23	24	25	26	27	28	29	30	31
ByteCount																Bytes (variable)															
...																															

ByteCount (2 bytes): This field MUST be 0x0005 or greater.

Bytes (variable):

0	1	2	3	4	5	6	7	8	9	10	11	12	13	14	15	16	17	18	19	20	21	22	23	24	25	26	27	28	29	30	31
BufferFormat1										FileName (variable)																					
...																															
BufferFormat2										ResumeKeyLength																					

BufferFormat1 (1 byte): This field MUST be 0x04, which indicates that a null-terminated ASCII string is to follow.

FileName (variable): A null-terminated SMB_STRING. This is the full directory path (relative to the TID) of the file(s) being sought. Only the final component of the path MAY contain wildcards. This string MAY be the empty string.

BufferFormat2 (1 byte): This field MUST be 0x05, which indicates that a variable block is to follow.

ResumeKeyLength (2 bytes): This field MUST be 0x0000. No Resume Key is permitted in the SMB_COM_FIND_UNIQUE request. If the server receives an SMB_COM_FIND_UNIQUE request with a nonzero **ResumeKeyLength**, it MUST ignore this field.

2.2.4.60.2 Response

```
SMB_Parameters
{
    UCHAR   WordCount;
    Words
    {
        USHORT Count;
    }
}
```

```

}
SMB_Data
{
  USHORT ByteCount;
  Bytes
  {
    UCHAR          BufferFormat;
    USHORT         DataLength;
    SMB_Directory_Information DirectoryInformationData[DataLength];
  }
}

```

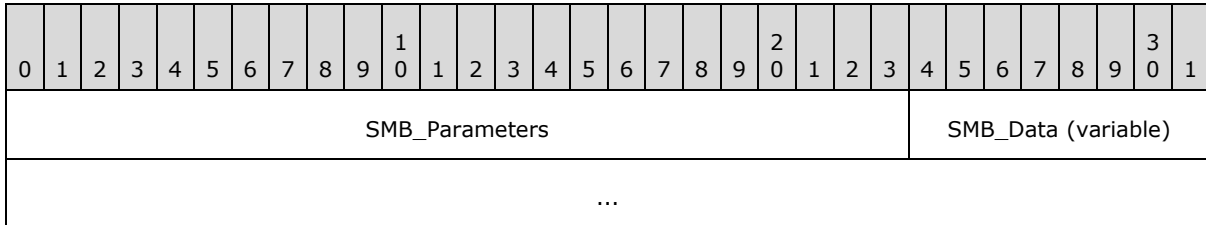

SMB_Parameters (3 bytes):

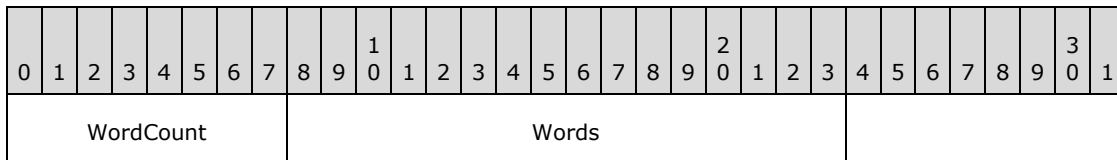

WordCount (1 byte): This field MUST be 0x01.

Words (2 bytes):

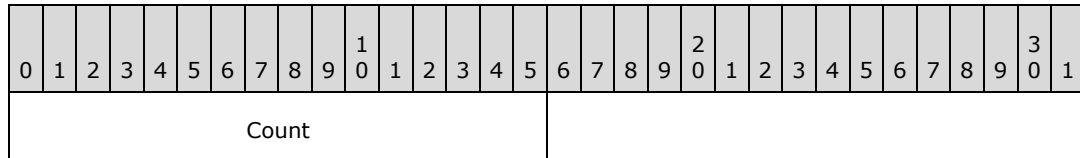

Count (2 bytes): The number of directory entries returned in this response message. This value MUST be less than or equal to the value of **MaxCount** in the initial request.

SMB_Data (variable):

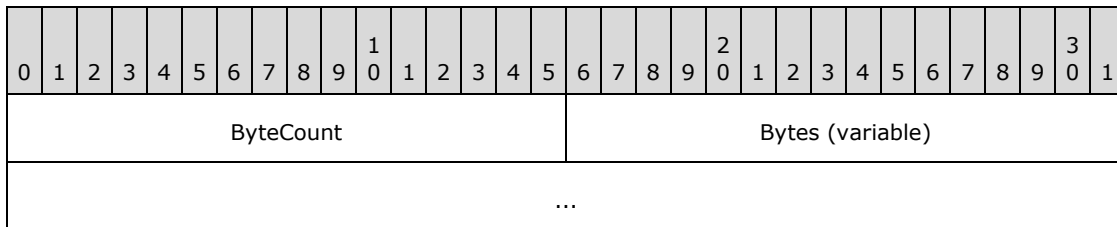

ByteCount (2 bytes): This field MUST be greater than or equal to 0x0003.

Bytes (variable):

0	1	2	3	4	5	6	7	8	9	0	1	2	3	4	5	6	7	8	9	0	1	2	3	4	5	6	7	8	9	0	1
BufferFormat										DataLength													DirectoryInformationData (variable)								
...																															

BufferFormat (1 byte): This field MUST be 0x05, which indicates that a variable-size block is to follow.

DataLength (2 bytes): The size in bytes of the **DirectoryInformationData** array that follows. This field MUST be equal to 43 times the value of **SMB_Parameters.Words.Count**.

DirectoryInformationData (variable): Array of SMB_Directory_Information An array of zero or more SMB_Directory_Information records. The structure and contents of these records is specified following. Note that the SMB_Directory_Information record structure is a fixed 43 bytes in length.

```
SMB_Directory_Information
{
  SMB_Resume_Key      ResumeKey;
  UCHAR               FileAttributes;
  SMB_TIME             LastWriteTime;
  SMB_DATE             LastWriteDate;
  ULONG               FileSize;
  OEM_STRING          FileName[13];
}
```

0	1	2	3	4	5	6	7	8	9	0	1	2	3	4	5	6	7	8	9	0	1	2	3	4	5	6	7	8	9	0	1
ResumeKey																															
...																															
...																															
...																															
...																															
...										FileAttributes											LastWriteTime										
LastWriteDate																FileSize															
...																FileName															
...																															

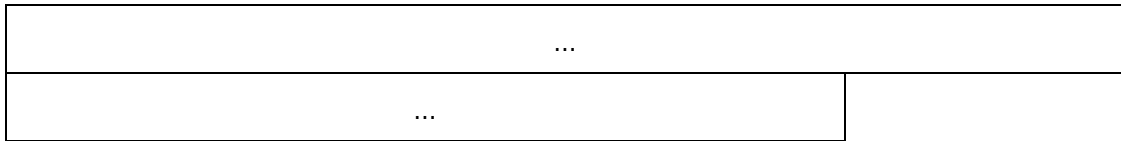

ResumeKey (21 bytes): This field is structured as described in SMB_COM_FIND. The client MUST ignore the contents of this field in an SMB_COM_FIND_UNIQUE response.

FileAttributes (1 byte): These are the file system attributes of the file.

LastWriteTime (2 bytes): The time when the file was last modified. The SMB_TIME structure contains a set of bit fields indicating hours, minutes, and seconds (with a 2 second resolution).

LastWriteDate (2 bytes): The date when the file was last modified. The SMB_DATE structure contains a set of bit fields indicating the year, month, and date.

FileSize (4 bytes): The size of the file, in bytes. If the file is larger than (2 ** 32 - 1) bytes in size, the server SHOULD return the least significant 32 bits of the file size.

FileName (13 bytes): The null-terminated 8.3 name format file name. The file name and extension, including the '.' delimiter MUST be left-justified in the field. The character string MUST be padded with " " (space) characters, as necessary, to reach 12 bytes in length. The final byte of the field MUST contain the terminating null character.

Error Codes

SMB error class	SMB error code	NT status code	POSIX equivalent	Description
ERRDOS (0x01)	ERRbadpath (0x0003)	STATUS_OBJECT_PATH_NOT_FOUND (0xC000003A) STATUS_OBJECT_PATH_SYNTAX_BAD (0xC000003B)	ENOTDIR	A non-terminal component of the specified path was not a directory OR the path syntax is invalid.
ERRDOS (0x01)	ERRnoaccess (0x0005)	STATUS_ACCESS_DENIED (0xC0000022)	EACCES	No file system permission on the specified pathname.
ERRDOS (0x01)	ERRbadfid (0x0006)	STATUS_INVALID_HANDLE (0xC0000008) STATUS_SMB_BAD_FID (0x00060001)	ENFILE	Attempt to resume a search that was not active on the server.
ERRDOS (0x01)	ERRnomem (0x0008)	STATUS_INSUFF_SERVER_RESOURCES (0xC0000205)		The server is out of resources.
ERRDOS (0x01)	ERRnofiles (0x0012)	STATUS_NO_MORE_FILES (0x80000006)	EOF	No more matching files found on the server.
ERRSRV (0x02)	ERRerror (0x0001)	STATUS_INVALID_SMB (0x00010002)		Invalid SMB request.

SMB error class	SMB error code	NT status code	POSIX equivalent	Description
ERRSRV (0x02)	ERRinvtid (0x0005)	STATUS_SMB_BAD_TID (0x00050002)		The TID is no longer valid.
ERRSRV (0x02)	ERRbaduid (0x005B)	STATUS_SMD_BAD_UID (0x005B0002)		The UID in the header is not valid for this session.
ERRHRD (0x03)	ERRdata (0x0017)	STATUS_CRC_ERROR (0xC000003F)	EIO	Data I/O error (incorrect CRC on device).

In [XOPEN-SMB] it is noted that POSIX-style servers MAY also generate ENOENT while searching for files. ENOENT errors MUST be handled on the server side and MUST NOT be returned to the client.

2.2.4.61 SMB_COM_FIND_CLOSE (0x84)

This command was introduced in the **LAN Manager 1.0** dialect. **This command is deprecated.** New client implementations SHOULD use the SMB_COM_TRANSACTION2 subcommand TRANS2_FIND_FIRST2 (section [2.2.6.2](#)) instead.

This command is used to close a directory search opened by SMB_COM_FIND. The initial SMB_COM_FIND request logically opens and initiates the search. Subsequent SMB_COM_FIND requests that present a valid **ResumeKey** continue the search. The SMB_COM_FIND_CLOSE closes the search, allowing the server to free any resources used to maintain the search context.

If the initial SMB_COM_FIND fails (returns an error), the search is not open, and this command SHOULD NOT be called to close it. This command SHOULD NOT be used to close a directory search opened by SMB_COM_SEARCH.

The format of this command is nearly identical to that of SMB_COM_SEARCH and SMB_COM_FIND, with the exception that the Reply field **SMB_Data.DirectoryInformationData** is never present.

2.2.4.61.1 Request

```

SMB_Parameters
{
    UCHAR    WordCount;
    Words
    {
        USHORT MaxCount;
        USHORT SearchAttributes;
    }
}
SMB_Data
{
    USHORT ByteCount;
    Bytes
    {
        UCHAR          BufferFormat1;
        SMB_STRING     FileName;
        UCHAR          BufferFormat2;
        USHORT         ResumeKeyLength;
        SMB_Resume_Key ResumeKey;
    }
}

```

```
}
}
```

SMB_Header:

TID (2 bytes): A valid **TID** MUST be provided. The **TID** MUST refer to a connected server share and MUST match the **TID** in the corresponding SMB_COM_FIND commands.

UID (2 bytes): A valid **UID** MUST be provided and MUST match the **UID** specified in the corresponding SMB_COM_FIND commands.

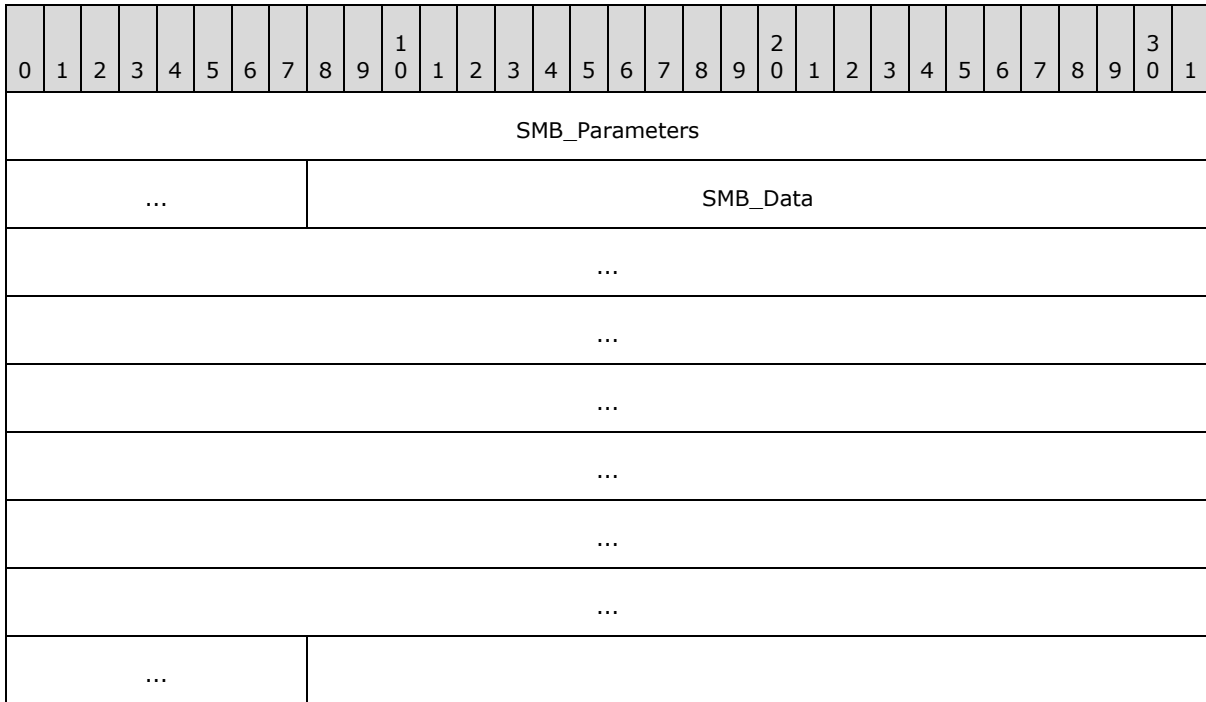

SMB_Parameters (5 bytes):

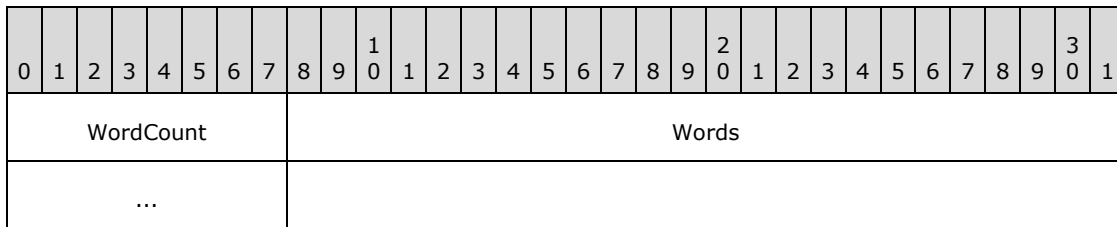

WordCount (1 byte): This field MUST be 0x02.

Words (4 bytes):

0	1	2	3	4	5	6	7	8	9	10	11	12	13	14	15	16	17	18	19	20	21	22	23	24	25	26	27	28	29	30	31
MaxCount																SearchAttributes															

MaxCount (2 bytes): This field has no meaning in this context. It SHOULD <110> be set to 0x0000 by the client and MUST be ignored by the server.

SearchAttributes (2 bytes): This field has no meaning in this context. It SHOULD be set to 0x0000 by the client and MUST be ignored by the server.

SMB_Data (28 bytes):

0	1	2	3	4	5	6	7	8	9	10	11	12	13	14	15	16	17	18	19	20	21	22	23	24	25	26	27	28	29	30	31
ByteCount														Bytes																	
...																															
...																															
...																															
...																															
...																															
...																															

ByteCount (2 bytes): This field MUST be 26 (0x001A).

Bytes (26 bytes):

0	1	2	3	4	5	6	7	8	9	10	11	12	13	14	15	16	17	18	19	20	21	22	23	24	25	26	27	28	29	30	31
BufferFormat1								FileName								BufferFormat2						ResumeKeyLength									
...								ResumeKey																							
...																															
...																															
...																															
...																															

...

BufferFormat1 (1 byte): This field MUST be 0x04, which indicates that a null-terminated ASCII string follows.

FileName (1 byte): SMB_STRING A null-terminated SMB_STRING. This MUST be the empty string.

BufferFormat2 (1 byte): This field MUST be 0x05, which indicates that a variable block follows.

ResumeKeyLength (2 bytes): This field MUST be 21 (0x0015).

ResumeKey (21 bytes): SMB_Resume_Key This MUST be the last **ResumeKey** returned by the server in the search being closed. See SMB_COM_FIND for a description of the SMB_Resume_Key data structure.

2.2.4.61.2 Response

```
SMB_Parameters
{
  UCHAR  WordCount;
  Words
  {
    USHORT Count;
  }
}
SMB_Data
{
  USHORT ByteCount;
  Bytes
  {
    UCHAR  BufferFormat;
    USHORT DataLength;
  }
}
```

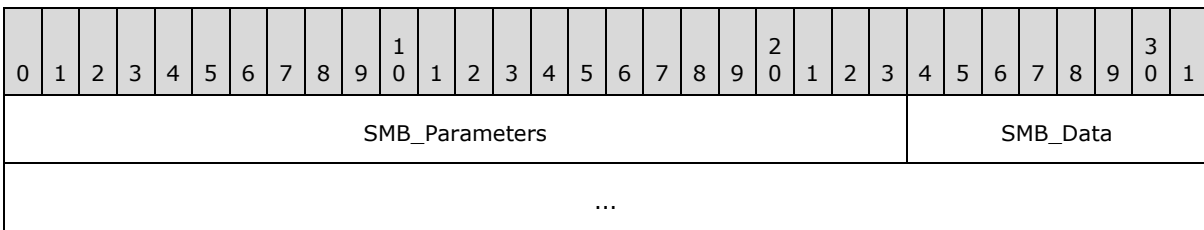

SMB_Parameters (3 bytes):

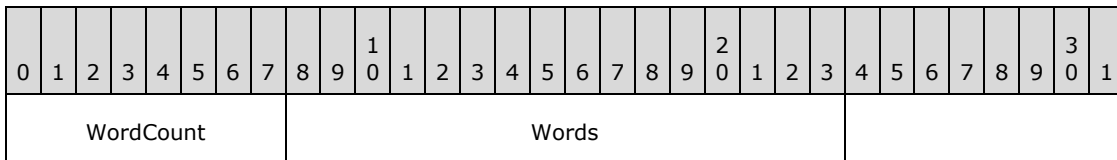

WordCount (1 byte): This field MUST be 0x01.

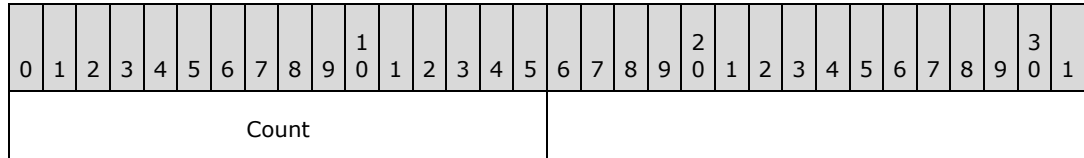
Words (2 bytes):

Count (2 bytes): The server SHOULD set this field to 0x0000, and the client MUST ignore the value of this field. No entries are returned in the response.

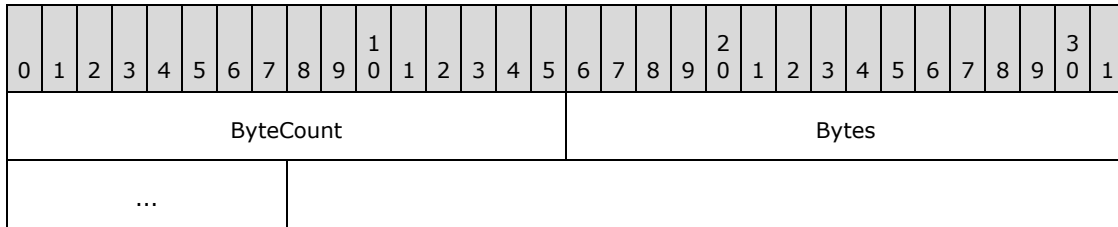
SMB_Data (5 bytes):

ByteCount (2 bytes): This field SHOULD [<111>](#) be 0x0003.

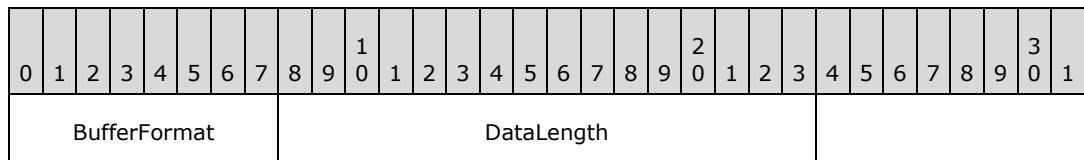
Bytes (3 bytes):

BufferFormat (1 byte): If sent, this field MUST be 0x05, which indicates that a variable-size block follows.

DataLength (2 bytes): If sent, this field MUST be 0x0000. No **DirectoryInformationData** records are returned.

Error Codes

SMB error class	SMB error code	NT status code	POSIX equivalent	Description
ERRDOS (0x01)	ERRbadpath (0x0003)	STATUS_OBJECT_PATH_NOT_FOUND (0xC000003A) STATUS_OBJECT_PATH_SYNTAX_BAD (0xC000003B)	ENOTDIR	A non-terminal component of the specified path was not a directory OR the path syntax is invalid.
ERRDOS (0x01)	ERRnoaccess (0x0005)	STATUS_ACCESS_DENIED (0xC0000022)	EACCES	No file system permission on the specified pathname.
ERRDOS	ERRbadfid	STATUS_INVALID_HANDLE	ENFILE	Attempt to resume

SMB error class	SMB error code	NT status code	POSIX equivalent	Description
(0x01)	(0x0006)	(0xC0000008) STATUS_SMB_BAD_FID (0x00060001)		a search that was not active on the server.
ERRDOS (0x01)	ERRnomem (0x0008)	STATUS_INSUFF_SERVER_RESOURCES (0xC0000205)		The server is out of resources.
ERRDOS (0x01)	ERRnofiles (0x0012)	STATUS_NO_MORE_FILES (0x80000006)	EOF	No more matching files found on the server.
ERRSRV (0x02)	ERRerror (0x0001)	STATUS_INVALID_SMB (0x00010002)		Invalid SMB request.
ERRSRV (0x02)	ERRinvtid (0x0005)	STATUS_SMB_BAD_TID (0x00050002)		The TID is no longer valid.
ERRSRV (0x02)	ERRbaduid (0x005B)	STATUS_SMB_BAD_UID (0x005B0002)		The UID in the header is not valid for this session, or the user identified by the UID does not have sufficient privileges.
ERRHRD (0x03)	ERRdata (0x0017)	STATUS_CRC_ERROR (0xC000003F)	EIO	Data I/O error (incorrect CRC on device).

2.2.4.62 SMB_COM_NT_TRANSACT (0xA0)

This command was introduced in the NT LAN Manager dialect.

SMB_COM_NT_TRANSACT subcommands extend the file system feature access offered by [SMB_COM_TRANSACTION2 \(section 2.2.4.46\)](#), and also allow for the transfer of very large parameter and data blocks.

SMB_COM_NT_TRANSACT messages MAY exceed the maximum size of a single SMB message (as determined by the value of the **MaxBufferSize** session parameter). In this case, the client will use one or more SMB_COM_NT_TRANSACT_SECONDARY messages to transfer transaction **Data** and **Parameter** bytes that did not fit in the initial message.

The client indicates that it has not sent all of the **Data** bytes by setting **DataCount** to a value less than **TotalDataCount**. Similarly, if **ParameterCount** is less than **TotalParameterCount**, then the client has more **Parameter** bytes to send. **Parameter** bytes SHOULD be sent before **Data** bytes, and clients SHOULD attempt to send as many bytes as possible in each message. Servers SHOULD be prepared, however, to accept **Parameters** and **Data** in any order, in large or small amounts.

For both the request and the response, the positions and lengths of the **SMB_Data.NT_Trans_Parameters** and **SMB_Data.NT_Trans_Data** fields are determined by the values of the **SMB_Parameters.ParameterOffset**, **SMB_Parameters.ParameterCount**, **SMB_Parameters.DataOffset**, and **SMB_Parameters.DataCount** fields. In addition, the

SMB_Parameters.ParameterDisplacement and **SMB_Parameters.DataDisplacement** fields MAY be used to change the order in which subranges of bytes are transferred. Servers SHOULD transfer bytes in order and give precedence to **SMB_Data.NT_Trans_Parameters** bytes. Clients SHOULD be prepared to reconstruct transaction **SMB_Data.NT_Trans_Parameters** and **SMB_Data.NT_Trans_Data**, regardless of the order or locations in which they are delivered.

2.2.4.62.1 Request

The SMB_COM_NT_TRANSACT request differs in structure from the other two transaction request types. Although there are several common fields, the SMB_COM_NT_TRANSACT message rearranges fields to provide better byte alignment. The other transaction types use 16-bit fields to provide the size and offset of parameters and data; SMB_COM_NT_TRANSACT uses 32-bit fields, allowing for much larger data transfers. Finally, SMB_COM_NT_TRANSACT includes a **Function** field, which carries the subcommand code.

```
SMB_Parameters
{
    UCHAR    WordCount;
    Words
    {
        UCHAR    MaxSetupCount;
        USHORT   Reserved1;
        ULONG    TotalParameterCount;
        ULONG    TotalDataCount;
        ULONG    MaxParameterCount;
        ULONG    MaxDataCount;
        ULONG    ParameterCount;
        ULONG    ParameterOffset;
        ULONG    DataCount;
        ULONG    DataOffset;
        UCHAR    SetupCount;
        USHORT   Function;
        USHORT   Setup[SetupCount];
    }
}

SMB_Data
{
    USHORT   ByteCount;
    Bytes
    {
        UCHAR    Pad1[];
        UCHAR    NT_Trans_Parameters[ParameterCount];
        UCHAR    Pad2[];
        UCHAR    NT_Trans_Data[DataCount];
    }
}
```

SMB_Header:

The **Command** for the initial request and for all responses MUST be SMB_COM_NT_TRANSACT (0xA0). The **Command** for secondary request messages that are part of the same transaction MUST be SMB_COM_NT_TRANSACT_SECONDARY (0xA1). The **PID, MID, TID,** and **UID** MUST be the same for all requests and responses that are part of the same transaction.

0	1	2	3	4	5	6	7	8	9	10	11	12	13	14	15	16	17	18	19	20	21	22	23	24	25	26	27	28	29	30	31
SMB_Parameters (variable)																															
...																															
SMB_Data (variable)																															
...																															

SMB_Parameters (variable):

The SMB_Parameters section of the SMB_COM_NT_TRANSACT request contains the information used to manage the transaction itself. It also contains flags and setup information that provide context for the execution of the operation on the server side.

0	1	2	3	4	5	6	7	8	9	10	11	12	13	14	15	16	17	18	19	20	21	22	23	24	25	26	27	28	29	30	31
WordCount										Words (variable)																					
...																															

WordCount (1 byte): This field MUST be greater than or equal to 0x13.

Words (variable):

0	1	2	3	4	5	6	7	8	9	10	11	12	13	14	15	16	17	18	19	20	21	22	23	24	25	26	27	28	29	30	31
MaxSetupCount										Reserved1												TotalParameterCount									
...										...												TotalDataCount									
...										...												MaxParameterCount									
...										...												MaxDataCount									
...										...												ParameterCount									
...										...												ParameterOffset									
...										...												DataCount									
...										...												DataOffset									
...										...												SetupCount									

Function	Setup (variable)
...	

MaxSetupCount (1 byte): Maximum number of setup bytes that the client will accept in the transaction reply. This field MUST be set as specified in the subsections of [Transaction Subcommands \(section 2.2.5\)](#). The server MUST NOT return more than this number of setup bytes.

Reserved1 (2 bytes): Two padding bytes. This field MUST be 0x0000. This field is used to align the next field to a 32-bit boundary.

TotalParameterCount (4 bytes): The total number of SMB_COM_NT_TRANSACT parameter bytes to be sent in this transaction request. This value MAY be reduced in any or all subsequent SMB_COM_NT_TRANSACT_SECONDARY requests that are part of the same transaction. This value represents transaction parameter bytes, not SMB parameter words. Transaction parameter bytes are carried in the SMB_Data block of the SMB_COM_NT_TRANSACT request or in subsequent SMB_COM_NT_TRANSACT_SECONDARY requests.

TotalDataCount (4 bytes): The total number of SMB_COM_NT_TRANSACT data bytes to be sent in this transaction request. This value MAY be reduced in any or all subsequent SMB_COM_NT_TRANSACT_SECONDARY requests that are part of the same transaction. This value represents transaction data bytes, not SMB data bytes.

MaxParameterCount (4 bytes): The maximum number of parameter bytes that the client will accept in the transaction reply. This field MUST be set as specified in the subsections of Transaction Subcommands. The server MUST NOT return more than this number of parameter bytes.

MaxDataCount (4 bytes): The maximum number of data bytes that the client will accept in the transaction reply. This field MUST be set as specified in the subsections of Transaction Subcommands. The server MUST NOT return more than this number of data bytes.

ParameterCount (4 bytes): The number of transaction parameter bytes being sent in this SMB message. If the transaction fits within a single SMB_COM_NT_TRANSACT request, this value MUST be equal to **TotalParameterCount**. Otherwise, the sum of the **ParameterCount** values in the primary and secondary transaction request messages MUST be equal to the smallest **TotalParameterCount** value reported to the server. If the value of this field is less than the value of **TotalParameterCount**, then at least one SMB_COM_NT_TRANSACT_SECONDARY message MUST be used to transfer the remaining parameter bytes.

ParameterOffset (4 bytes): The offset, in bytes, from the start of the SMB_Header to the transaction parameter bytes. This MUST be the number of bytes from the start of the SMB message to the start of the **SMB_Data.Bytes.Parameters** field. Server implementations MUST use this value to locate the transaction parameter block within the SMB message. If **ParameterCount** is zero, the client/server MAY set this field to zero. [<112>](#)

DataCount (4 bytes): The number of transaction data bytes being sent in this SMB message. If the transaction fits within a single SMB_COM_NT_TRANSACT request, then this value MUST be equal to **TotalDataCount**. Otherwise, the sum of the **DataCount** values in the primary and secondary transaction request messages MUST be equal to the smallest **TotalDataCount** value reported to the server. If the value of this field is less than the value of **TotalDataCount**, then at least one SMB_COM_NT_TRANSACT_SECONDARY message MUST be used to transfer the remaining data bytes.

DataOffset (4 bytes): The offset, in bytes, from the start of the [SMB Header \(section 2.2.3.1\)](#) to the transaction data bytes. This MUST be the number of bytes from the start of the SMB message to

the start of the **SMB_Data.Bytes.Data** field. Server implementations MUST use this value to locate the transaction data block within the SMB message. If **DataCount** is zero, the client/server MAY set this field to zero. <113>

SetupCount (1 byte): The number of setup words that are included in the transaction request.

Function (2 bytes): The transaction subcommand code, which is used to identify the operation to be performed by the server.

Setup (variable): An array of two-byte words that provides transaction context to the server. The size and content of the array are specific to the individual subcommands.

SMB_Data (variable):

The SMB_Data section of the SMB_COM_NT_TRANSACT request contains the parameters and data that are the input to the transaction operation on the server.

0	1	2	3	4	5	6	7	8	9	10	11	12	13	14	15	16	17	18	19	20	21	22	23	24	25	26	27	28	29	30	31
ByteCount																Bytes (variable)															
...																															

ByteCount (2 bytes): The number of bytes in the **SMB_Data.Bytes** array, which follows.

Bytes (variable):

0	1	2	3	4	5	6	7	8	9	10	11	12	13	14	15	16	17	18	19	20	21	22	23	24	25	26	27	28	29	30	31
Pad1 (variable)																															
...																															
NT_Trans_Parameters (variable)																															
...																															
Pad2 (variable)																															
...																															
NT_Trans_Data (variable)																															
...																															

Pad1 (variable): This field SHOULD be used as an array of padding bytes to align the following field to a 4-byte boundary relative to the start of the SMB Header. This constraint can cause this

field to be a zero-length field. This field SHOULD be set to zero by the client/server and MUST be ignored by the server/client.

NT_Trans_Parameters (variable): Transaction parameter bytes. See the individual SMB_COM_NT_TRANSACT subcommand descriptions for information on parameters sent for each subcommand.

Pad2 (variable): This field SHOULD be used as an array of padding bytes to align the following field to a 4-byte boundary relative to the start of the SMB Header. This constraint can cause this field to be a zero-length field. This field SHOULD be set to zero by the client/server, and MUST be ignored by the server/client.

NT_Trans_Data (variable): Transaction data bytes. See the individual SMB_COM_NT_TRANSACT subcommand descriptions for information on data sent for each subcommand.

2.2.4.62.2 Response

The SMB_COM_NT_TRANSACT response has two possible formats. The standard format is used to return the results of the completed transaction. A shortened interim response message is sent following the initial SMB_COM_NT_TRANSACT request if secondary request messages (SMB_COM_NT_TRANSACT_SECONDARY) are pending.

Whenever a transaction request is split across multiple SMB requests, the server evaluates the initial SMB_COM_NT_TRANSACT request to determine whether or not it has the resources necessary to process the transaction. It also checks for any other errors that it can detect based upon the initial request and then sends back an interim response. The interim response indicates to the client as to whether it can send the rest of the transaction to the server.

The format of the SMB_COM_NT_TRANSACT Interim Server Response message is simply an [SMB Header \(section 2.2.3.1\)](#) with an empty **Parameter** and **Data** section (**WordCount** and **ByteCount** are zero).

```
SMB_Parameters
{
    UCHAR   WordCount;
}
SMB_Data
{
    USHORT  ByteCount;
}
```

If no error (that is, SUCCESS) is returned in the SMB_COM_NT_TRANSACT Interim Server Response, the transaction MAY proceed. The client sends as many SMB_COM_NT_TRANSACT_SECONDARY messages as needed to transfer the remainder of the transaction subcommand. The server processes the transaction and replies with one or more SMB_COM_NT_TRANSACT response messages.

```
SMB_Parameters
{
    UCHAR   WordCount;
    Words
    {
        UCHAR   Reserved1[3];
        ULONG   TotalParameterCount;
        ULONG   TotalDataCount;
    }
}
```

```

    ULONG   ParameterCount;
    ULONG   ParameterOffset;
    ULONG   ParameterDisplacement;
    ULONG   DataCount;
    ULONG   DataOffset;
    ULONG   DataDisplacement;
    UCHAR   SetupCount;
    USHORT  Setup[SetupCount];
}
}
SMB_Data
{
    USHORT  ByteCount;
    Bytes
    {
        UCHAR  Pad1[];
        UCHAR  Parameters[ParameterCount];
        UCHAR  Pad2[];
        UCHAR  Data[DataCount];
    }
}

```

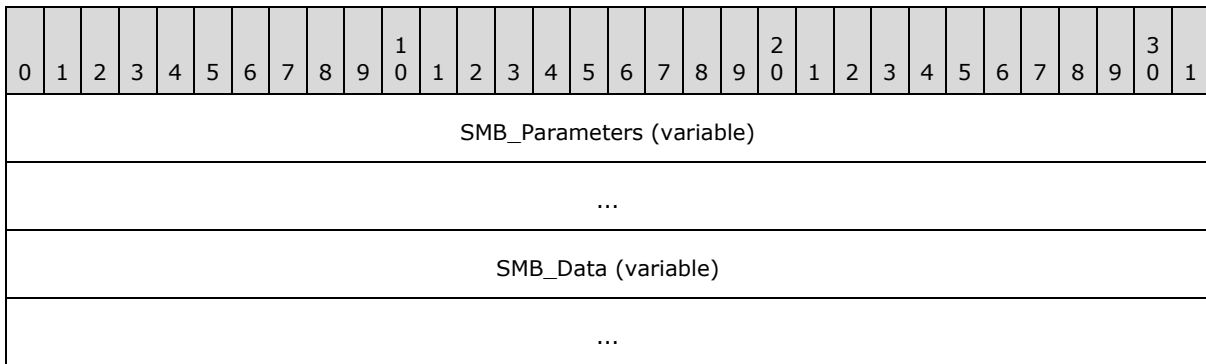

SMB_Parameters (variable):

The SMB_Parameters section of the SMB_COM_NT_TRANSACT response contains information used to manage the transfer of the complete transaction response. It also contains setup information that can include subcommand return codes or state information returned by the server.

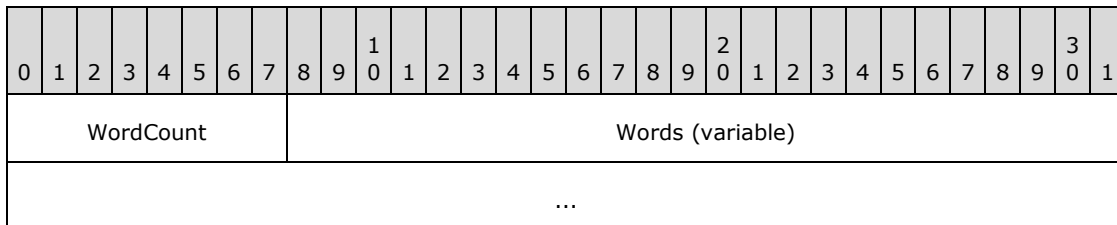

WordCount (1 byte): The value of **Words.SetupCount** plus 18 (0x12). This value represents the total number of SMB parameter words and MUST be greater than or equal to 18 (0x12).

Words (variable):

0	1	2	3	4	5	6	7	8	9	0	1	2	3	4	5	6	7	8	9	0	1	2	3	4	5	6	7	8	9	0	1		
Reserved1																TotalParameterCount																	
...																TotalDataCount																	
...																ParameterCount																	
...																ParameterOffset																	
...																ParameterDisplacement																	
...																DataCount																	
...																DataOffset																	
...																DataDisplacement																	
...																SetupCount																	
Setup (variable)																																	
...																																	

Reserved1 (3 bytes): Reserved. This field MUST be 0x000000 in the server response. The client MUST ignore the contents of this field.

TotalParameterCount (4 bytes): The total number of SMB_COM_NT_TRANSACT parameter bytes to be sent in this transaction response. This value MAY be reduced in any or all subsequent SMB_COM_NT_TRANSACT responses that are part of the same transaction. This value represents transaction parameter bytes, not SMB parameter words. Transaction parameter bytes are carried within in the SMB_data block.

TotalDataCount (4 bytes): The total number of SMB_COM_NT_TRANSACT data bytes to be sent in this transaction response. This value MAY be reduced in any or all subsequent SMB_COM_NT_TRANSACT responses that are part of the same transaction. This value represents transaction data bytes, not SMB data bytes.

ParameterCount (4 bytes): The number of transaction parameter bytes being sent in this SMB message. If the transaction fits within a single SMB_COM_NT_TRANSACT response, then this value MUST be equal to **TotalParameterCount**. Otherwise, the sum of the **ParameterCount** values in the transaction response messages MUST be equal to the smallest **TotalParameterCount** value reported by the server.

ParameterOffset (4 bytes): The offset, in bytes, from the start of the SMB_Header to the transaction parameter bytes. This MUST be the number of bytes from the start of the SMB message to the start of the **SMB_Data.Bytes.Parameters** field. Server implementations MUST use this

value to locate the transaction parameter block within the SMB message. If **ParameterCount** is zero, the client/server MAY set this field to zero. <114>

ParameterDisplacement (4 bytes): The offset, relative to all of the transaction parameter bytes in this transaction response, at which this block of parameter bytes MUST be placed. This value can be used by the client to correctly reassemble the transaction parameters even if the SMB response messages are received out of order.

DataCount (4 bytes): The number of transaction data bytes being sent in this SMB message. If the transaction fits within a single SMB_COM_NT_TRANSACT response, then this value MUST be equal to **TotalDataCount**. Otherwise, the sum of the **DataCount** values in the transaction response messages MUST be equal to the smallest **TotalDataCount** value reported by the server.

DataOffset (4 bytes): The offset, in bytes, from the start of the SMB_Header to the transaction data bytes. This MUST be the number of bytes from the start of the SMB message to the start of the **SMB_Data.Bytes.Data** field. Server implementations MUST use this value to locate the transaction data block within the SMB message. If **DataCount** is zero, the client/server MAY set this field to zero. <115>

DataDisplacement (4 bytes): The offset, relative to all of the transaction data bytes in this transaction response, at which this block of data bytes MUST be placed. This value can be used by the client to correctly reassemble the transaction data even if the SMB response messages are received out of order.

SetupCount (1 byte): The number of **Setup** words that are included in the transaction response.

Setup (variable): An array of two-byte words that provides transaction results from the server. The size and content of the array are specific to individual subcommand.

SMB_Data (variable):

The SMB_Data section of the SMB_COM_NT_TRANSACT response contains the parameters and data generated by the transaction subcommand.

0	1	2	3	4	5	6	7	8	9	10	11	12	13	14	15	16	17	18	19	20	21	22	23	24	25	26	27	28	29	30	31
ByteCount																Bytes (variable)															
...																															

ByteCount (2 bytes): This field MUST be greater than or equal to 0x0000.

Bytes (variable):

0	1	2	3	4	5	6	7	8	9	10	11	12	13	14	15	16	17	18	19	20	21	22	23	24	25	26	27	28	29	30	31
Pad1 (variable)																															
...																															
Parameters (variable)																															

...
Pad2 (variable)
...
Data (variable)
...

Pad1 (variable): This field SHOULD be used as an array of padding bytes to align the following field to a 4-byte boundary relative to the start of the SMB Header (section 2.2.3.1). This constraint can cause this field to be a zero-length field. This field SHOULD be set to zero by the client/server and MUST be ignored by the server/client.

Parameters (variable): Transaction parameter bytes. See the individual SMB_COM_NT_TRANSACT subcommand descriptions for information on parameters returned by the server for each subcommand.

Pad2 (variable): This field SHOULD be used as an array of padding bytes to align the following field to a 4-byte boundary relative to the start of the SMB Header. This constraint can cause this field to be a zero-length field. This field SHOULD be set to zero by the client/server and MUST be ignored by the server/client.

Data (variable): Transaction data bytes. See the individual SMB_COM_NT_TRANSACT subcommand descriptions for information on data returned by the server for each subcommand.

As with the request message, the positions and lengths of the **Parameters** and **Data** fields are determined by the values of the **ParameterOffset**, **ParameterCount**, **DataOffset**, and **DataCount** fields. In addition, the **ParameterDisplacement** and **DataDisplacement** fields MAY be used to change the order in which subranges of bytes are transferred. Servers SHOULD transfer byte blocks in order and SHOULD give precedence to **Parameter** bytes. Clients SHOULD be prepared to reconstruct transaction **Parameters** and **Data** regardless of the orders or locations in which they are delivered.

Error Codes

The errors returned from calls to SMB_COM_NT_TRANSACT are specific to the subcommand being executed. See the documentation for the individual subcommands for more detailed error information.

2.2.4.63 SMB_COM_NT_TRANSACT_SECONDARY (0xA1)

The SMB_COM_NT_TRANSACT_SECONDARY command is used to complete a data transfer initiated by an SMB_COM_NT_TRANSACT request.

2.2.4.63.1 Request

The SMB_COM_NT_TRANSACT_SECONDARY request message has the same purpose as the other secondary transaction messages used in SMB. The fields are in a different order to provide better alignment, and the **Count**, **Offset**, and **Displacement** fields are 32 bits wide instead of 16.

SMB_Parameters

```

{
  UCHAR WordCount;
  Words
  {
    UCHAR Reserved1[3];
    ULONG TotalParameterCount;
    ULONG TotalDataCount;
    ULONG ParameterCount;
    ULONG ParameterOffset;
    ULONG ParameterDisplacement;
    ULONG DataCount;
    ULONG DataOffset;
    ULONG DataDisplacement;
    UCHAR Reserved2;
  }
}
SMB_Data
{
  USHORT ByteCount;
  Bytes
  {
    UCHAR Pad1[];
    UCHAR Parameters[ParameterCount];
    UCHAR Pad2[];
    UCHAR Data[DataCount];
  }
}

```

SMB_Header:

This command MUST be sent following a successful SMB_COM_NT_TRANSACT Intermediate Response from the server. The PID, **MID**, **TID**, and **UID** MUST be the same for all requests and responses that are part of the same transaction.

0	1	2	3	4	5	6	7	8	9	10	11	12	13	14	15	16	17	18	19	20	21	22	23	24	25	26	27	28	29	30	31
SMB_Parameters																															
...																															
...																															
...																															
...																															
...																															
...																															

...	ParameterOffset
...	ParameterDisplacement
...	DataCount
...	DataOffset
...	DataDisplacement
...	Reserved2

Reserved1 (3 bytes): Reserved. Used to align the following fields to a 32-bit boundary. This field MUST contain null padding bytes in the server response. The client MUST ignore the contents of this field.

TotalParameterCount (4 bytes): The total number of transaction parameter bytes to be sent to the server over the course of this transaction. This value MAY be less than or equal to the **TotalParameterCount** in preceding request messages that are part of the same transaction. This value represents transaction parameter bytes, not SMB parameter words.

TotalDataCount (4 bytes): The total number of transaction data bytes to be sent to the server over the course of this transaction. This value MAY be less than or equal to the **TotalDataCount** in preceding request messages that are part of the same transaction. This value represents transaction data bytes, not SMB data bytes.

ParameterCount (4 bytes): The number of transaction parameter bytes being sent in the SMB message. This value MUST be less than **TotalParameterCount**. The sum of the **ParameterCount** values across all of the request messages in a transaction MUST be equal to the **TotalParameterCount** reported in the last request message of the transaction.

ParameterOffset (4 bytes): The offset, in bytes, from the start of the SMB_Header to the transaction parameter bytes contained in this SMB message. This MUST be the number of bytes from the start of the SMB message to the start of the **SMB_Data.Bytes.Parameters** field. Server implementations MUST use this value to locate the transaction parameter block within the SMB message. If **ParameterCount** is zero, the client/server MAY set this field to zero. <116>

ParameterDisplacement (4 bytes): The offset, relative to all of the transaction parameter bytes sent to the server in this transaction, at which this block of parameter bytes MUST be placed. This value can be used by the server to correctly reassemble the transaction parameters even if the SMB request messages are received out of order.

DataCount (4 bytes): The number of transaction data bytes being sent in this SMB message. This value MUST be less than the value of **TotalDataCount**. The sum of the **DataCount** values across all of the request messages in a transaction MUST be equal to the smallest **TotalDataCount** value reported to the server.

DataOffset (4 bytes): The offset, in bytes, from the start of the SMB_Header to the transaction data bytes contained in this SMB message. This MUST be the number of bytes from the start of the SMB message to the start of the **SMB_Data.Bytes.Data** field. Server implementations MUST use this value to locate the transaction data block within the SMB message. If **DataCount** is zero, the client/server MAY set this field to zero. <117>

DataDisplacement (4 bytes): The offset, relative to all of the transaction data bytes sent to the server in this transaction, at which this block of parameter bytes MUST be placed. This value can be used by the server to correctly reassemble the transaction data block even if the SMB request messages are received out of order.

Reserved2 (1 byte): Reserved. MUST be 0x00. The server MUST ignore the contents of this field.

SMB_Data (variable):

The SMB_Data section of the SMB_COM_NT_TRANSACT_SECONDARY request contains parameters and data bytes being sent to the server.

0	1	2	3	4	5	6	7	8	9	10	11	12	13	14	15	16	17	18	19	20	21	22	23	24	25	26	27	28	29	30	31
ByteCount																Bytes (variable)															
...																															

ByteCount (2 bytes): The number of bytes in the **SMB_Data.Bytes** array, which follows.

Bytes (variable):

0	1	2	3	4	5	6	7	8	9	10	11	12	13	14	15	16	17	18	19	20	21	22	23	24	25	26	27	28	29	30	31
Pad1 (variable)																															
...																															
Parameters (variable)																															
...																															
Pad2 (variable)																															
...																															
Data (variable)																															
...																															

Pad1 (variable): This field SHOULD be used as an array of padding bytes to align the following field to a 4-byte boundary relative to the start of the [SMB Header \(section 2.2.3.1\)](#). This constraint can cause this field to be a zero-length field. This field SHOULD be set to zero by the client/server and MUST be ignored by the server/client.

Parameters (variable): Transaction parameter bytes.

Pad2 (variable): This field SHOULD be used as an array of padding bytes to align the following field to a 4-byte boundary relative to the start of the SMB Header. This constraint can cause this field to be a zero-length field. This field SHOULD be set to zero by the client/server and MUST be ignored by the server/client.

Data (variable): Transaction data bytes.

2.2.4.63.2 Response

There is no response message defined for the SMB_COM_NT_TRANSACT_SECONDARY command.

Error Codes

Because there is no response to an SMB_COM_NT_TRANSACT_SECONDARY request, no error codes are defined.

2.2.4.64 SMB_COM_NT_CREATE_ANDX (0xA2)

This command was introduced in the **NT LAN Manager** dialect.

This command is used to create and open a new file, or to open an existing file, or to open and truncate an existing file to zero length, or to create a directory, or to create a connection to a named pipe. The **FID** returned MAY be used in subsequent requests.

The message includes the pathname of the file, directory, or named pipe, and **RootDirectoryFID** (see following) that the client attempts to create or open. If the message is successful, the server response MUST include a **FID** value identifying the opened resource. The client MUST supply the **FID** in subsequent operations on the resource. The client MUST have write permission on the resource parent directory to create a new file or directory, or write permissions on the file itself to truncate the file.

The following are the commands that MAY follow an SMB_COM_NT_CREATE_ANDX in an AndX chain:

- [SMB_COM_READ \(section 2.2.4.11\)](#)
- [SMB_COM_READ_ANDX \(section 2.2.4.42\)](#)
- [SMB_COM_IOCTL \(section 2.2.4.35\)](#)

2.2.4.64.1 Request

```
SMB_Parameters
{
    UCHAR WordCount;
    Words
    {
        UCHAR    AndXCommand;
        UCHAR    AndXReserved;
        USHORT   AndXOffset;
        UCHAR    Reserved;
        USHORT   NameLength;
        ULONG    Flags;
        ULONG    RootDirectoryFID;
        ULONG    DesiredAccess;
        LARGE_INTEGER AllocationSize;
        SMB_EXT_FILE_ATTR ExtFileAttributes;
    }
}
```

```

    ULONG    ShareAccess;
    ULONG    CreateDisposition;
    ULONG    CreateOptions;
    ULONG    ImpersonationLevel;
    UCHAR    SecurityFlags;
}
}
SMB_Data
{
    USHORT ByteCount;
    Bytes
    {
        SMB_STRING FileName;
    }
}

```

0	1	2	3	4	5	6	7	8	9	10	11	12	13	14	15	16	17	18	19	20	21	22	23	24	25	26	27	28	29	30	31
SMB_Parameters																															
...																															
...																															
...																															
...																															
...																															
...																															
...																															
(SMB_Parameters cont'd for 4 rows)																															
...																															

SMB_Parameters (49 bytes):

0	1	2	3	4	5	6	7	8	9	10	11	12	13	14	15	16	17	18	19	20	21	22	23	24	25	26	27	28	29	30	31
WordCount										Words																					
...																															
...																															

...
...
...
...
...
...
(Words cont'd for 4 rows)
...
SMB_Data (variable)
...

WordCount (1 byte): This field MUST be 0x18.

Words (48 bytes):

0	1	2	3	4	5	6	7	8	9	10	11	12	13	14	15	16	17	18	19	20	21	22	23	24	25	26	27	28	29	30	31						
AndXCommand										AndXReserved										AndXOffset																	
Reserved										NameLength																		Flags									
...																		RootDirectoryFID																			
...																		DesiredAccess																			
...																		AllocationSize																			
...																																					
...																		ExtFileAttributes																			
...																		ShareAccess																			
...																		CreateDisposition																			
...																		CreateOptions																			
...																		ImpersonationLevel																			
...																		SecurityFlags																			

AndXCommand (1 byte): The command code for the next SMB command in the packet. This value MUST be set to 0xFF if there are no additional SMB commands in the client request packet.

AndXReserved (1 byte): A reserved field. This MUST be set to 0x00 when this request is sent, and the server MUST ignore this value when the message is received.

AndXOffset (2 bytes): This field MUST be set to the offset in bytes from the start of the [SMB Header \(section 2.2.3.1\)](#) to the start of the WordCount field in the next SMB command in this packet. This field is valid only if the AndXCommand field is not set to 0xFF. If AndXCommand is 0xFF, this field MUST be ignored by the server.

Reserved (1 byte): An unused value that SHOULD be set to 0x00 when sent and MUST be ignored on receipt.

NameLength (2 bytes): This field MUST be the length of the FileName field (see following) in bytes.

Flags (4 bytes): A 32-bit field containing a set of flags that modify the client request. Unused bit fields SHOULD be set to 0 when sent and MUST be ignored on receipt.

Name and bitmask	Meaning
NT_CREATE_REQUEST_OPLOCK 0x00000002	If set, the client requests an exclusive OpLock.
NT_CREATE_REQUEST_OPBATCH 0x00000004	If set, the client requests an exclusive batch OpLock.
NT_CREATE_OPEN_TARGET_DIR 0x00000008	If set, the client indicates that the parent directory of the target is to be opened.

RootDirectoryFID (4 bytes): If nonzero, this value is the File ID of an opened root directory, and the FileName field MUST be handled as relative to the directory specified by this RootDirectoryFID. If this value is 0x00000000, the FileName field MUST be handled as relative to the root of the share (the TID). The RootDirectoryFID MUST have been acquired in a previous message exchange.

DesiredAccess (4 bytes): A 32-bit field of flags that indicate standard, specific, and generic access rights. These rights are used in access-control entries (ACEs) and are the primary means of specifying the requested or granted access to an object. If this value is 0x00000000, it represents a request to query the attributes without accessing the file.

Name and bitmask	Meaning
FILE_READ_DATA 0x00000001	Indicates the right to read data from the file.
FILE_WRITE_DATA 0x00000002	Indicates the right to write data into the file beyond the end of the file.
FILE_APPEND_DATA 0x00000004	Indicates the right to append data to the file beyond the end of the file only.
FILE_READ_EA 0x00000008	Indicates the right to read the extended attributes (EAs) of the file.
FILE_WRITE_EA 0x00000010	Indicates the right to write or change the extended attributes (EAs) of the file.

Name and bitmask	Meaning
FILE_EXECUTE 0x00000020	Indicates the right to execute the file.
FILE_READ_ATTRIBUTES 0x00000080	Indicates the right to read the attributes of the file.
FILE_WRITE_ATTRIBUTES 0x00000100	Indicates the right to change the attributes of the file.
DELETE 0x00010000	Indicates the right to delete or to rename the file.
READ_CONTROL 0x00020000	Indicates the right to read the security descriptor of the file.
WRITE_DAC 0x00040000	Indicates the right to change the discretionary access control list (DACL) in the security descriptor of the file.
WRITE_OWNER 0x00080000	Indicates the right to change the owner in the security descriptor of the file.
SYNCHRONIZE 0x00100000	SHOULD NOT be used by the sender and MUST be ignored by the receiver.
ACCESS_SYSTEM_SECURITY 0x01000000	Indicates the right to read or change the system access control list (SACL) in the security descriptor for the file. If the SE_SECURITY_NAME privilege is not set in the access token, the server MUST fail the open request and return STATUS_PRIVILEGE_NOT_HELD.
MAXIMUM_ALLOWED 0x02000000	Indicates that the client requests an open to the file with the highest level of access that the client has on this file. If no access is granted for the client on this file, the server MUST fail the open and return a STATUS_ACCESS_DENIED.
GENERIC_ALL 0x10000000	Indicates a request for all of the access flags that are previously listed except MAXIMUM_ALLOWED and ACCESS_SYSTEM_SECURITY.
GENERIC_EXECUTE 0x20000000	Indicates a request for the following combination of access flags listed previously in this table: FILE_READ_ATTRIBUTES, FILE_EXECUTE, SYNCHRONIZE, and READ_CONTROL.
GENERIC_WRITE 0x40000000	Indicates a request for the following combination of access flags listed previously in this table: FILE_WRITE_DATA, FILE_APPEND_DATA, SYNCHRONIZE, FILE_WRITE_ATTRIBUTES, and FILE_WRITE_EA.
GENERIC_READ 0x80000000	Indicates a request for the following combination of access flags listed previously in this table: FILE_READ_DATA, FILE_READ_ATTRIBUTES, FILE_READ_EA, and SYNCHRONIZE.

AllocationSize (8 bytes): The client MUST set this value to the initial allocation size of the file in bytes. The server MUST ignore this field if this request is to open an existing file. This field MUST be used only if the file is created or overwritten. The value MUST be set to 0x0000000000000000 in all other cases. This does not apply to directory-related requests. This is the number of bytes to be allocated, represented as a 64-bit integer value.

ExtFileAttributes (4 bytes): This field contains the extended file attributes of the file being requested, encoded as an [SMB_EXT_FILE_ATTR \(section 2.2.1.2.3\)](#) data type.

ShareAccess (4 bytes): A 32-bit field that specifies how the file SHOULD be shared with other processes. The names in the table below are provided for reference use only. If **ShareAccess** values of FILE_SHARE_READ, FILE_SHARE_WRITE, or FILE_SHARE_DELETE are set for a printer file or a named pipe, the server SHOULD ignore these values. The value MUST be FILE_SHARE_NONE or some combination of the other values:

Name and bitmask	Meaning
FILE_SHARE_NONE 0x00000000	(No bits set.)Prevents the file from being shared.
FILE_SHARE_READ 0x00000001	Other open operations can be performed on the file for read access.
FILE_SHARE_WRITE 0x00000002	Other open operations can be performed on the file for write access.
FILE_SHARE_DELETE 0x00000004	Other open operations can be performed on the file for delete access.

CreateDisposition (4 bytes): A 32-bit value that represents the action to take if the file already exists or if the file is a new file and does not already exist. [<118>](#)

Name and value	Meaning
FILE_SUPERSEDE 0x00000000	(No bits set.)If the file already exists, it SHOULD be superseded (overwritten). If it does not already exist, then it SHOULD be created.
FILE_OPEN 0x00000001	If the file already exists, it SHOULD be opened rather than created. If the file does not already exist, the operation MUST fail.
FILE_CREATE 0x00000002	If the file already exists, the operation MUST fail. If the file does not already exist, it SHOULD be created.
FILE_OPEN_IF 0x00000003	If the file already exists, it SHOULD be opened. If the file does not already exist, then it SHOULD be created. This value is equivalent to (FILE_OPEN FILE_CREATE).
FILE_OVERWRITE 0x00000004	If the file already exists, it SHOULD be opened and truncated. If the file does not already exist, the operation MUST fail. The client MUST open the file with at least GENERIC_WRITE access for the command to succeed.
FILE_OVERWRITE_IF 0x00000005	If the file already exists, it SHOULD be opened and truncated. If the file does not already exist, it SHOULD be created. The client MUST open the file with at least GENERIC_WRITE access.

CreateOptions (4 bytes): A 32-bit field containing flag options to use if creating the file or directory. This field MUST be set to 0x00000000 or a combination of the following possible values. Unused bit fields SHOULD be set to 0 when sent and MUST be ignored on receipt. The following is a list of the valid values and their associated behaviors. Server implementations SHOULD reserve all bits not specified in the following definitions.

Name and bitmask	Meaning
FILE_DIRECTORY_FILE 0x00000001	The file being created or opened is a directory file. With this option, the CreateDisposition field MUST be set to FILE_CREATE, FILE_OPEN, or FILE_OPEN_IF. When this bit field is set, other compatible CreateOptions include only the following: FILE_WRITE_THROUGH, FILE_OPEN_FOR_BACKUP_INTENT, and FILE_OPEN_BY_FILE_ID.
FILE_WRITE_THROUGH 0x00000002	Applications that write data to the file MUST actually transfer the data into the file before any write request is considered complete. If FILE_NO_INTERMEDIATE_BUFFERING is set, the server MUST perform as if FILE_WRITE_THROUGH is set in the create request.
FILE_SEQUENTIAL_ONLY 0x00000004	This option indicates that access to the file can be sequential. The server can use this information to influence its caching and read-ahead strategy for this file. The file MAY in fact be accessed randomly, but the server can optimize its caching and read-ahead policy for sequential access.
FILE_NO_INTERMEDIATE_BUFFERING 0x00000008	The file SHOULD NOT be cached or buffered in an internal buffer by the server. This option is incompatible when the FILE_APPEND_DATA bit field is set in the DesiredAccess field.
FILE_SYNCHRONOUS_IO_ALERT 0x00000010	This flag MUST be ignored by the server, and clients SHOULD set this to 0.
FILE_SYNCHRONOUS_IO_NONALERT 0x00000020	This flag MUST be ignored by the server, and clients SHOULD set this to 0.
FILE_NON_DIRECTORY_FILE 0x00000040	If the file being opened is a directory, the server MUST fail the request with STATUS_FILE_IS_A_DIRECTORY in the Status field of the SMB Header in the server response.
FILE_CREATE_TREE_CONNECTION 0x00000080	This option SHOULD NOT be sent by the clients, and this option MUST be ignored by the server.
FILE_COMPLETE_IF_OPLOCKED 0x00000100	This option SHOULD NOT be sent by the clients, and this option MUST be ignored by

Name and bitmask	Meaning
	the server.
FILE_NO_EA_KNOWLEDGE 0x00000200	The application that initiated the client's request does not support extended attributes (EAs). If the EAs on an existing file being opened indicate that the caller SHOULD support EAs to correctly interpret the file, the server SHOULD fail this request with STATUS_ACCESS_DENIED (ERRDOS/ERRnoaccess) in the Status field of the SMB Header in the server response.
FILE_OPEN_FOR_RECOVERY 0x00000400	This option SHOULD NOT be sent by the clients, and this option MUST be ignored if received by the server.
FILE_RANDOM_ACCESS 0x00000800	Indicates that access to the file can be random. The server MAY use this information to influence its caching and read-ahead strategy for this file. This is a hint to the server that sequential read-ahead operations might not be appropriate on the file.
FILE_DELETE_ON_CLOSE 0x00001000	The file SHOULD be automatically deleted when the last open request on this file is closed. When this option is set, the DesiredAccess field MUST include the DELETE flag. This option is often used for temporary files.
FILE_OPEN_BY_FILE_ID 0x00002000	Opens a file based on the FileId. If this option is set, the server MUST fail the request with STATUS_NOT_SUPPORTED in the Status field of the SMB Header in the server response.
FILE_OPEN_FOR_BACKUP_INTENT 0x00004000	The file is being opened or created for the purposes of either a backup or a restore operation. Thus, the server can make appropriate checks to ensure that the caller is capable of overriding whatever security checks have been placed on the file to allow a backup or restore operation to occur. The server can check for certain access rights to the file before checking the DesiredAccess field.
FILE_NO_COMPRESSION 0x00008000	When a new file is created, the file MUST NOT be compressed, even if it is on a compressed volume. The flag MUST be ignored when opening an existing file.
FILE_RESERVE_OPFILTER 0x00100000	This option SHOULD NOT be sent by the clients, and this option MUST be ignored if received by the server.
FILE_OPEN_NO_RECALL 0x00400000	In a hierarchical storage management environment, this option requests that the file

Name and bitmask	Meaning
	SHOULD NOT be recalled from tertiary storage such as tape. A file recall can take up to several minutes in a hierarchical storage management environment. The clients can specify this option to avoid such delays.
FILE_OPEN_FOR_FREE_SPACE_QUERY 0x00800000	This option SHOULD NOT be sent by the clients, and this option MUST be ignored if received by the server.

ImpersonationLevel (4 bytes): This field specifies the impersonation level requested by the application that is issuing the create request, and MUST contain one of the following values. The server MUST validate this field, but otherwise ignore it.

Impersonation is described in [\[MS-WPO\]](#) section 8.5.1; for more information about impersonation, see [\[MSDN-IMPERS\]](#).

Name and value	Meaning
SEC_ANONYMOUS 0x00000000	The application-requested impersonation level is Anonymous.
SEC_IDENTIFY 0x00000001	The application-requested impersonation level is Identification.
SEC_IMPERSONATE 0x00000002	The application-requested impersonation level is Impersonation.

SecurityFlags (1 byte): An 8-bit field containing a set of options that specify the security tracking mode. These options specify whether the server is to be given a snapshot of the client's security context (called static tracking) or is to be continually updated to track changes to the client's security context (called dynamic tracking). When bit 0 of the **SecurityFlags** field is clear, static tracking is requested. When bit 0 of the **SecurityFlags** field is set, dynamic tracking is requested. Unused bit fields SHOULD be set to 0 when sent and MUST be ignored on receipt. This field MUST be set to 0x00 or a combination of the following possible values. Value names are provided for convenience only. Supported values are:

Name and value	Meaning
SMB_SECURITY_CONTEXT_TRACKING 0x01	When set, dynamic tracking is requested. When this bit field is not set, static tracking is requested.
SMB_SECURITY_EFFECTIVE_ONLY 0x02	Specifies that only the enabled aspects of the client's security context are available to the server. If this flag is not specified, all aspects of the client's security context are available. This flag allows the client to limit the groups and privileges that a server can use while impersonating the client.

SMB_Data (variable):

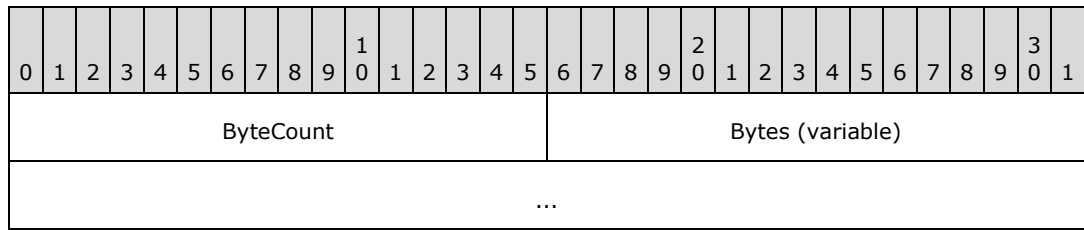

ByteCount (2 bytes): The length in bytes of the remaining SMB_Data. If SMB_FLAGS2_UNICODE is set in the Flags2 field of the SMB Header of the request, this field has a minimum value of 0x0003. If SMB_FLAGS2_UNICODE is not set, this field has a minimum value of 0x0002. This field MUST be the total length of the Name field, plus any padding added for alignment.

Bytes (variable):

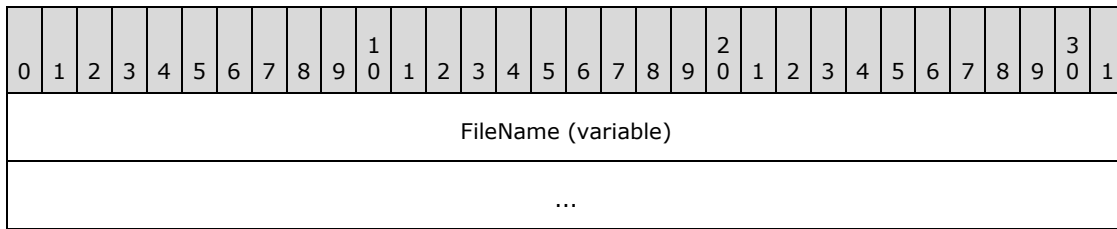

FileName (variable): A string that represents the fully qualified name of the file relative to the supplied TID to create or truncate on the server. If SMB_FLAGS2_UNICODE is set in the Flags2 field of the SMB Header of the request, the FileName string MUST be a null-terminated array of 16-bit Unicode characters. Otherwise, the FileName string MUST be a null-terminated array of extended ASCII (OEM) characters. If the FileName string consists of Unicode characters, this field MUST be aligned to start on a 2-byte boundary from the start of the SMB Header. When opening a named pipe, the FileName field MUST contain only the relative name of the pipe, that is, the "\\PIPE\" prefix MUST NOT be present. This is in contrast with other commands, such as SMB_COM_OPEN_ANDX and TRANS2_OPEN2, which require that the "\\PIPE" prefix be present in the pathname.

2.2.4.64.2 Response

```
SMB_Parameters
{
  UCHAR WordCount;
  Words
  {
    UCHAR      AndXCommand;
    UCHAR      AndXReserved;
    USHORT     AndXOffset;
    UCHAR      OpLockLevel;
    USHORT     FID;
    ULONG      CreateDisposition;
    FILETIME   CreateTime;
    FILETIME   LastAccessTime;
    FILETIME   LastWriteTime;
    FILETIME   LastChangeTime;
    SMB_EXT_FILE_ATTR ExtFileAttributes;
    LARGE_INTEGER AllocationSize;
    LARGE_INTEGER EndOfFile;
    USHORT     ResourceType;
    SMB_NMPIPE_STATUS NMPipeStatus;
  }
}
```

```

    UCHAR    Directory;
}
}
SMB_Data
{
    USHORT ByteCount;
}

```

0	1	2	3	4	5	6	7	8	9	10	11	12	13	14	15	16	17	18	19	20	21	22	23	24	25	26	27	28	29	30	31
SMB_Parameters																															
...																															
...																															
...																															
...																															
...																															
...																															
...																															
(SMB_Parameters cont'd for 9 rows)																															
...										SMB_Data																					

SMB_Parameters (69 bytes):

0	1	2	3	4	5	6	7	8	9	10	11	12	13	14	15	16	17	18	19	20	21	22	23	24	25	26	27	28	29	30	31
WordCount										Words																					
...																															
...																															
...																															
...																															
...																															

...
...
(Words cont'd for 9 rows)
...

WordCount (1 byte): This field MUST be 0x22.

Words (68 bytes):

0	1	2	3	4	5	6	7	8	9	10	11	12	13	14	15	16	17	18	19	20	21	22	23	24	25	26	27	28	29	30	31						
AndXCommand										AndXReserved										AndXOffset																	
OpLockLevel										FID																CreateDisposition											
...																										CreateTime											
...																																					
...																								LastAccessTime													
...																																					
...																								LastWriteTime													
...																																					
...																								LastChangeTime													
...																																					
...																								ExtFileAttributes													
...																								AllocationSize													
...																																					
...																								EndOfFile													
...																																					
...																								ResourceType													

...	NMPipeStatus	Directory
-----	--------------	-----------

AndXCommand (1 byte): The command code for the next SMB command in the packet. This value MUST be set to 0xFF if there are no additional SMB command responses in the server response packet.

AndXReserved (1 byte): A reserved field. The server MUST set this field to 0x00 when this response is sent, and the client MUST ignore this field.

AndXOffset (2 bytes): This field MUST be set to the offset in bytes from the start of the [SMB Header \(section 2.2.3.1\)](#) to the start of the WordCount field in the next SMB command response in this packet. This field is valid only if the AndXCommand field is not set to 0xFF. If AndXCommand is 0xFF, this field MUST be ignored by the client.

OpLockLevel (1 byte): The OpLock level granted to the client process.

Value	Meaning
0x00	No OpLock granted.
0x01	Exclusive OpLock granted.
0x02	Batch OpLock granted.
0x03	Level II OpLock granted.

FID (2 bytes): A FID representing the file or directory that was created or opened.

CreateDisposition (4 bytes): A 32-bit value that represents the action to take if the file already exists or if the file is a new file and does not already exist.

Name and bitmask	Meaning
FILE_SUPERSEDE 0x00000000	The file has been superseded.
FILE_OPEN 0x00000001	The file or directory has been opened.
FILE_CREATE 0x00000002	The file or directory has been created.
FILE_OPEN_IF 0x00000003	The file has been overwritten.
FILE_OVERWRITE 0x00000004	The file already exists.
FILE_OVERWRITE_IF 0x00000005	The file does not exist.

CreateTime (8 bytes): A 64-bit integer value representing the time that the file was created. The time value is a signed 64-bit integer representing either an absolute time or a time interval. Times are specified in units of 100ns. A positive value expresses an absolute time, where the base time (the 64-bit integer with value 0x0000000000000000) is the beginning of the year 1601 AD in the

Gregorian calendar. A negative value expresses a time interval relative to some base time, usually the current time.

LastAccessTime (8 bytes): The time that the file was last accessed encoded in the same format as **CreateTime**.

LastWriteTime (8 bytes): The time that the file was last written, encoded in the same format as **CreateTime**.

LastChangeTime (8 bytes): The time that the file was last changed, encoded in the same format as **CreateTime**.

ExtFileAttributes (4 bytes): This field contains the extended file attributes that the server assigned to the file or directory as a result of the command, encoded as an [SMB_EXT_FILE_ATTR \(section 2.2.1.2.3\)](#) data type.

AllocationSize (8 bytes): The number of bytes allocated to the file by the server.

EndOfFile (8 bytes): The end of file offset value.

ResourceType (2 bytes): The file type. This field MUST be interpreted as follows.

Name and value	Meaning
FileTypeDisk 0x0000	File or directory
FileTypeByteModePipe 0x0001	Byte mode named pipe
FileTypeMessageModePipe 0x0002	Message mode named pipe
FileTypePrinter 0x0003	Printer device
FileTypeCommDevice 0x0004	Character mode device. When an extended protocol has been negotiated, this value allows a device to be opened for driver-level I/O. This provides direct access to devices such as modems, scanners, and so forth.

NMPipeStatus (2 bytes): A 16-bit field that shows the status of the named pipe if the resource type opened is a named pipe. This field is formatted as an [SMB_NMPIPE_STATUS \(section 2.2.1.3\)](#).

Directory (1 byte): If the returned **FID** represents a directory, the server MUST set this value to a nonzero value (0x01 is commonly used). If the **FID** is not a directory, the server MUST set this value to 0x00 (FALSE).

SMB_Data (2 bytes):

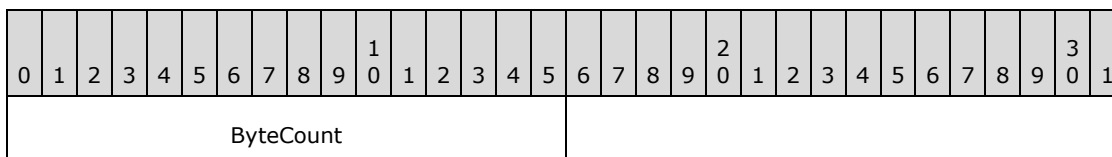

ByteCount (2 bytes): This field MUST be 0x0000. No data is sent by this message.

Error Codes

SMB error class	SMB error code	NT status code	POSIX equivalent	Description
ERRDOS (0x01)	ERRbadpath (0x0003)	STATUS_OBJECT_PATH_SYNTAX_BAD (0xC000003B)	ENOENT	The file path syntax is invalid.
ERRDOS (0x01)	ERRnofids (0x0004)	STATUS_OS2_TOO_MANY_OPEN_FILES (0x00040001) STATUS_TOO_MANY_OPENED_FILES (0xC000011F)	EMFILE	Too many open files; no more FIDs available.
ERRDOS (0x01)	ERRnoaccess (0x0005)	STATUS_ACCESS_DENIED (0xC0000022)	EPERM	Access denied.
ERRDOS (0x01)	ERRnoaccess (0x0005)	STATUS_FILE_IS_A_DIRECTORY (0xC00000BA)	EISDIR	Named file is an existing directory and CreateOptions in the request contains FILE_NON_DIRECTORY_FILE.
ERRDOS (0x01)	ERRbadfid (0x0006)	STATUS_INVALID_HANDLE (0xC0000008) STATUS_SMB_BAD_FID (0x00060001)	ENFILE	Invalid FID ; RootDirectoryFID is not valid.
ERRDOS (0x01)	ERRnomem (0x0008)	STATUS_INSUFF_SERVER_RESOURCES (0xC0000205)	ENOMEM	The server is out of resources.
ERRDOS (0x01)	ERRbadaccess (0x000C)	STATUS_ACCESS_DENIED (0xC0000022)		Invalid open mode.
ERRDOS (0x01)	ERRbadshare (0x0020)	STATUS_SHARING_VIOLATION (0xC0000043)	ETXTBSY	Sharing violation.
ERRDOS (0x01)	ERRrunsup (0x0032)	STATUS_NOT_SUPPORTED (0xC00000BB)		This command is not supported by the server.
ERRDOS (0x01)	ERRfileexists (0x0050)	STATUS_OBJECT_NAME_COLLISION (0xC0000035)	EEXIST	The file already exists.
ERRDOS	ERRinvalidpara	STATUS_INVALID_PARAMETER		One of the request values

SMB error class	SMB error code	NT status code	POSIX equivalent	Description
S (0x01)	m (0x0057)	(0xC000000D)		is out of range.
ERRSR V (0x02)	ERRerror (0x0001)	STATUS_INVALID_SMB (0x00010002)		Invalid SMB. Not enough parameter bytes were sent or the path extends beyond the end of the message.
ERRSR V (0x02)	ERRinvtid (0x0005)	STATUS_SMB_BAD_TID (0x00050002)		The TID is no longer valid.
ERRSR V (0x02)	ERRinvdevice (0x0007)	STATUS_INVALID_DEVICE_TYPE (0xC00000CB)		Device type and request are inconsistent.
ERRSR V (0x02)	ERRbaduid (0x005B)	STATUS_SMB_BAD_UID (0x005B0002)		The UID supplied is not defined to the session.
ERRHR D (0x03)	ERRdata (0x0017)	STATUS_DATA_ERROR (0xC000003E)	EIO	A problem has occurred in the physical I/O.

2.2.4.65 SMB_COM_NT_CANCEL (0xA4)

This command was introduced in the NT LAN Manager dialect.

This command allows a client to request that a currently pending request be canceled. The server uses the identifiers supplied in **SMB_Header** to identify the client request that the client requests to cancel. The server can attempt to cancel the request or to process it immediately. The server **MUST NOT** send a corresponding response for this request. The client **SHOULD** rely on the server's response to the request that the client requests to cancel to determine the result of the request. If the server cannot identify the client's request that is to be canceled, the server **SHOULD NOT** send a response. [<119>](#)

This command is used primarily to cancel outstanding notify change operations initiated with the SMB_COM_NT_TRANSACT command and NT_TRANSACT_NOTIFY_CHANGE subcommand. Clients typically use NT_TRANSACT_NOTIFY_CHANGE to avoid polling for changes to directories. Other uses include canceling commands that are waiting indefinitely on a busy resource to become available or commands that retry several times for a busy resource to become available.

2.2.4.65.1 Request

```
SMB_Parameters
{
    UCHAR WordCount;
}
SMB_Data
{
    USHORT ByteCount;
```

}

SMB_Header:

CID (2 bytes): If the transport is connectionless, this field MUST contain the CID of the connection.

TID (2 bytes): This field MUST contain the TID of the pending request(s) to be canceled.

UID (2 bytes): This field MUST contain the UID of the pending request(s) to be canceled.

MID (2 bytes): This field MUST contain the MID of the pending request(s) to be canceled.

PID (4 bytes): This field MUST contain the PID of the pending request(s) to be canceled. The PID is calculated by combining the PIDHigh and PIDLow values as described in section [2.2.3.1](#).

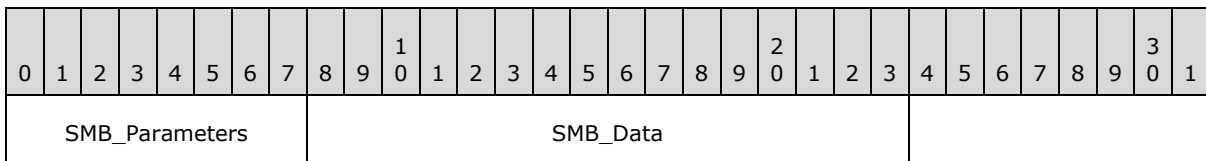

SMB_Parameters (1 byte):

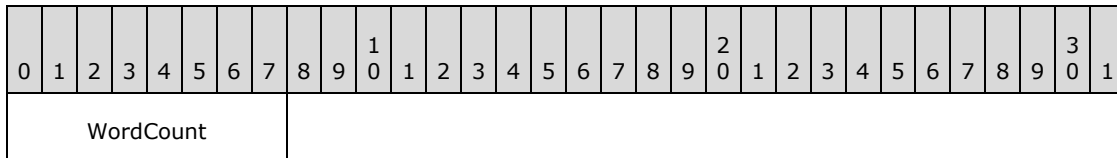

WordCount (1 byte): This field MUST be 0x00. No parameters are sent by this request.

SMB_Data (2 bytes):

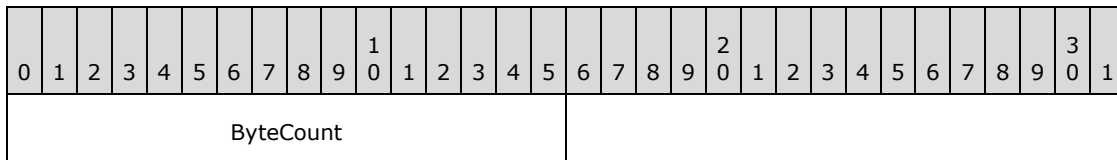

ByteCount (2 bytes): This field MUST be 0x0000. No data is sent by this request.

Error Codes

SMB error class	SMB error code	NT status code	POSIX equivalent	Description
ERRSRV (0x02)	ERRerror (0x0001)	STATUS_INVALID_SMB (0x00010002)		Invalid SMB. Not enough parameter bytes were sent.
ERRSRV (0x02)	ERRinvtid (0x0005)	STATUS_SMB_BAD_TID (0x00050002)		The TID is no longer valid.

SMB error class	SMB error code	NT status code	POSIX equivalent	Description
ERRSRV (0x02)	ERRbaduid (0x005B)	STATUS_SMB_BAD_UID (0x005B0002)		The UID supplied is not known to the session.

2.2.4.66 SMB_COM_NT_RENAME (0xA5)

This command was introduced in the NT LAN Manager dialect and is obsolescent. [<120>](#)

This command allows a client to create hard links on the remote server, to perform an in-place file rename, and to move a file within its existing path hierarchy. [<121>](#) See the **InformationLevel** field in the request for details. This command does not support wild card characters in the path or the file names. The command manipulates a single file per request. Existing files **MUST NOT** be overwritten. However, an in-place rename is supported. If the **NewFileName** field in the request has a zero length, the destination path for the new file **MUST** be the root directory of the share represented by the **TID** in the [SMB Header \(section 2.2.3.1\)](#). For in-place renames, the paths to the file **MUST** be identical or the request **MUST** fail with an appropriate error code.

2.2.4.66.1 Request

```

SMB_Parameters
{
  UCHAR WordCount;
  Words
  {
    SMB_FILE_ATTRIBUTES SearchAttributes;
    USHORT               InformationLevel;
    ULONG                Reserved;
  }
}
SMB_Data
{
  USHORT ByteCount;
  Bytes
  {
    UCHAR      BufferFormat1;
    SMB_STRING OldFileName;
    UCHAR      BufferFormat2;
    SMB_STRING NewFileName;
  }
}

```

SMB_Header:

TID (2 bytes): [USHORT](#) This field **MUST** contain a valid TID.

UID (2 bytes): [USHORT](#) This field **MUST** contain a valid UID.

0	1	2	3	4	5	6	7	8	9	10	11	12	13	14	15	16	17	18	19	20	21	22	23	24	25	26	27	28	29	30	31
WordCount										SearchAttributes												InformationLevel									

...	Reserved	
...	ByteCount	BufferFormat1
OldFileName (variable)		
...		
BufferFormat2	NewFileName (variable)	
...		

WordCount (1 byte): This field MUST be 0x04.

SearchAttributes (2 bytes): This field indicates the attributes that the target file(s) MUST have. If the attribute is 0x0000, then only normal files are renamed or linked. If the system file or hidden attributes are specified, then the rename is inclusive of both special types.

InformationLevel (2 bytes): This field MUST be one of the three values shown in the following table.

Value	Meaning
SMB_NT_RENAME_SET_LINK_INFO 0x0103	Create a hard link to the original file.
SMB_NT_RENAME_RENAME_FILE 0x0104	An in-place rename of the file. <122>
SMB_NT_RENAME_MOVE_FILE 0x0105	Move the file within the path hierarchy. This information level is obsolete. Clients MUST NOT use this value in a request. <123>

Reserved (4 bytes): This field SHOULD be set to 0x00000000 by the client and MUST be ignored by the server. [<124>](#)

ByteCount (2 bytes): This field MUST be greater than or equal to 0x0004.

BufferFormat1 (1 byte): This field MUST be 0x04.

OldFileName (variable): A null-terminated string containing the full path name of the file to be manipulated. Wildcards are not supported.

BufferFormat2 (1 byte): This field MUST be 0x04.

NewFileName (variable): A null-terminated string containing the new full path name to be assigned to the file provided in **OldFileName** or the full path into which the file is to be moved.

2.2.4.66.2 Response

```
SMB_Parameters
{
```

```

    UCHAR WordCount;
}
SMB_Data
{
    USHORT ByteCount;
}

```

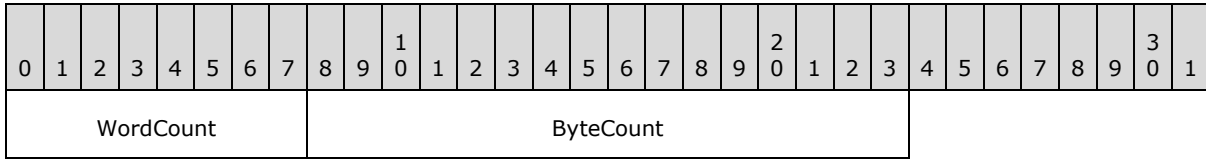

WordCount (1 byte): This field MUST be set to 0x00. No parameters are sent by this message.

ByteCount (2 bytes): This field MUST be set to 0x0000. No data is sent by this message.

Error Codes

SMB error class	SMB error code	NT status code	POSIX equivalent	Description
ERRDOS (0x01)	ERRbadfile (0x0002)	STATUS_NO_SUCH_FILE (0xC000000F)	ENOENT	The specified file does not exist.
ERRDOS (0x01)	ERRbadpath (0x0003)	STATUS_OBJECT_PATH_SYNTAX_BAD (0xC000003B)	ENOENT	A component in the path prefix is not a directory or the pathname contained wildcard characters.
ERRDOS (0x01)	ERRnoaccess (0x0005)	STATUS_ACCESS_DENIED (0xC0000022)	EPERM	The new file already exists.
ERRDOS (0x01)	ERRnoaccess (0x0005)	-	-	There are too many links to the old file.
ERRDOS (0x01)	ERRnoaccess (0x0005)	-	-	The directory is full.
ERRDOS (0x01)	ERRnoaccess (0x0005)	-	-	The old path is the last link to an executing program.
ERRDOS (0x01)	ERRdiffdevice (0x0011)	STATUS_NOT_SAME_DEVICE (0xC00000D4)	EXDEV	The new path is on a different file system.
ERRSRV (0x02)	ERRerror (0x0001)	STATUS_INVALID_SMB (0x00010002)	-	Invalid SMB. Request contains a packaging or value error.

SMB error class	SMB error code	NT status code	POSIX equivalent	Description
ERRSRV (0x02)	ERRaccess (0x0004)	STATUS_NETWORK_ACCESS_DENIED (0xC00000CA)	EACCES	Access denied. The given UID does not have permission to execute the requested command within the current context (TID).
ERRSRV (0x02)	ERRinvtid (0x0005)	STATUS_SMB_BAD_TID (0x00050002)	-	The TID specified in the command was invalid.
ERRSRV (0x02)	ERRnomem (0x0008)	STATUS_INSUFF_SERVER_RESOURCES (0xC0000205)	ENOMEM	The server is out of resources.
ERRSRV (0x02)	ERRbaduid (0x005B)	STATUS_SMB_BAD_UID (0x005B0002)	-	The UID given is not known as a valid ID on this server session.
ERRHRD (0x03)	ERRnowrite (0x0013)	STATUS_MEDIA_WRITE_PROTECTED (0x0C00000A2)	EROFS	Attempt to modify a read-only file system.

2.2.4.67 SMB_COM_OPEN_PRINT_FILE (0xC0)

This is an original **Core Protocol** command.

This command is used to create a print queue spool file. The file will be queued to the printer when closed. The server SHOULD delete the file once it has been printed.

2.2.4.67.1 Request

```

SMB_Parameters
{
    UCHAR    WordCount;
    Words
    {
        USHORT SetupLength;
        USHORT Mode;
    }
}
SMB_Data
{
    USHORT ByteCount;
    Bytes
    {
        UCHAR    BufferFormat;
        SMB_STRING Identifier[];
    }
}

```

SMB_Header:

TID (1 byte): This field MUST represent a printer share (print queue).

UID (1 byte): This field MUST be valid within the SMB session, and the **UID** MUST have the appropriate permissions to create new print jobs.

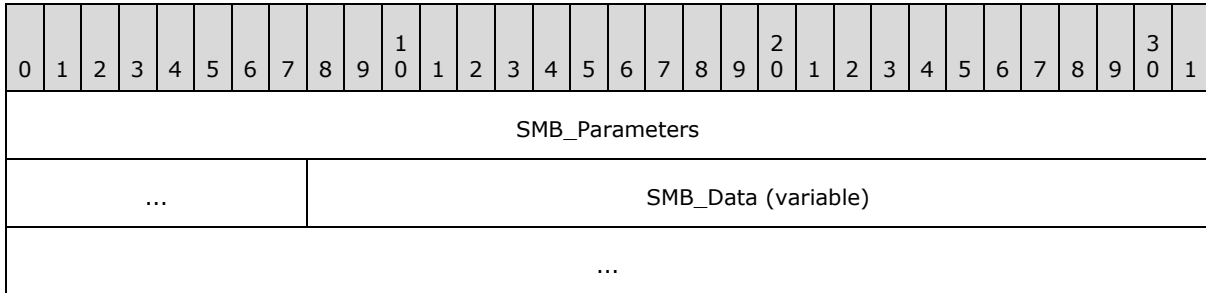

SMB_Parameters (5 bytes):

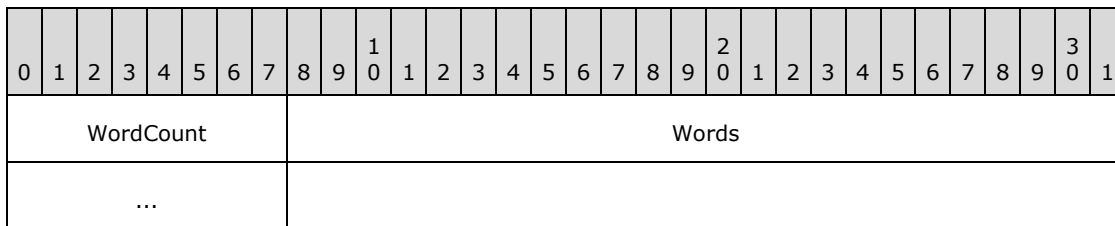

WordCount (1 byte): This field MUST be 0x02.

Words (4 bytes):

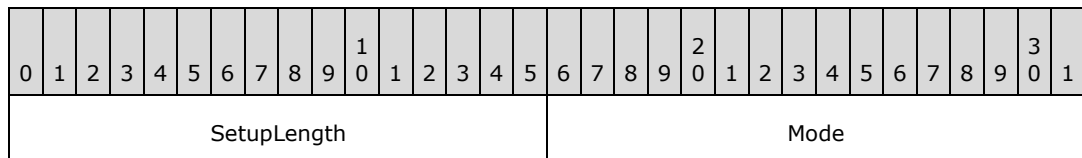

SetupLength (2 bytes): Length, in bytes, of the printer-specific control data that is to be included as the first part of the spool file. The server MUST pass this initial portion of the spool file to the printer unmodified.

Mode (2 bytes): A 16-bit field that contains a flag that specifies the print file mode.

Value	Meaning
0	Text mode. Starting SetupLength bytes into the spool file, the server MAY modify character sequences to normalize them for printer output. For example, the printer can convert tab characters in the spool file to sequences of spaces, or normalize end-of-line sequences.
1	Binary mode. The server MUST NOT modify the contents of the spool file

Value	Meaning
	before sending it to the printer.

SMB_Data (variable):

0	1	2	3	4	5	6	7	8	9	10	11	12	13	14	15	16	17	18	19	20	21	22	23	24	25	26	27	28	29	30	31
ByteCount											Bytes (variable)																				
...																															

ByteCount (2 bytes): This field MUST be greater than or equal to 0x0002.

Bytes (variable):

0	1	2	3	4	5	6	7	8	9	10	11	12	13	14	15	16	17	18	19	20	21	22	23	24	25	26	27	28	29	30	31
BufferFormat											Identifier (variable)																				
...																															

BufferFormat (1 byte): This field MUST be 0x04, representing an ASCII string.

Identifier (variable): A null-terminated string containing a suggested name for the spool file. The server can ignore, modify, or use this information to identify the print job. <125>

2.2.4.67.2 Response

```

SMB_Parameters
{
    UCHAR WordCount;
    Words
    {
        USHORT FID;
    }
}
SMB_Data
{
    USHORT ByteCount;
}

```

0	1	2	3	4	5	6	7	8	9	10	11	12	13	14	15	16	17	18	19	20	21	22	23	24	25	26	27	28	29	30	31
SMB_Parameters																					SMB_Data										
...																															

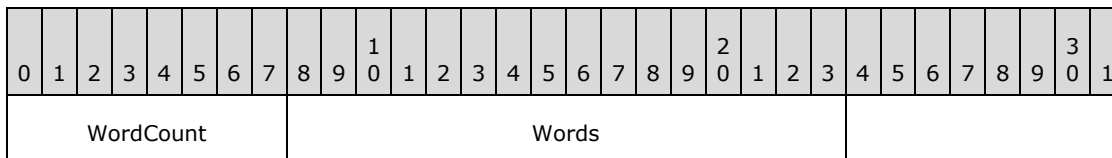
SMB_Parameters (3 bytes):

WordCount (1 byte): This field MUST be 0x01.

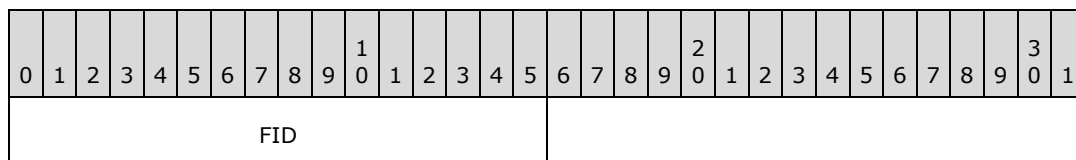
Words (2 bytes):

FID (2 bytes): The returned file handle that MUST be used by subsequent write and close operations on the spool file. When the spool file is closed, the file is queued and printed.

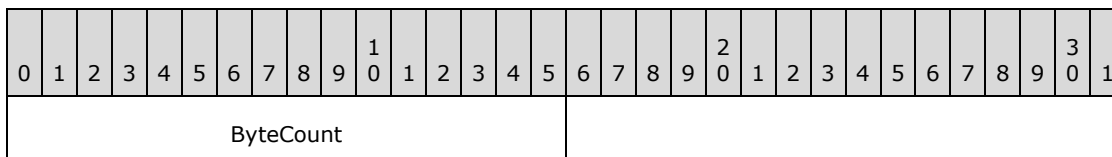
SMB_Data (2 bytes):

ByteCount (2 bytes): This field MUST be 0x0000. No data is sent by this message.

Error Codes

SMB error class	SMB error code	NT status code	POSIX equivalent	Description
ERRDOS (0x01)	(0x0001)	STATUS_INVALID_DEVICE_REQUEST (0xC0000010)	EACCES	The device rejected the request.
ERRDOS (0x01)	ERRnofids (0x0004)		EMFILE	This connection has reached the maximum number open file descriptors.
ERRDOS (0x01)	ERRnofids (0x0004)		ENFILE	The server's system file table is full.
ERRDOS (0x01)	ERRnoaccess (0x0005)	STATUS_ACCESS_DENIED (0xC0000022)	EACCES	The client does not have permission to create the spool file.
ERRDOS	ERRnomem	STATUS_INSUFF_SERVER_RESOURCES	ENOMEM	The server is out

SMB error class	SMB error code	NT status code	POSIX equivalent	Description
(0x01)	(0x0008)	(0xC0000205)		of resources.
ERRSRV (0x02)	ERRerror (0x0001)		EINTR	A signal was caught during a system call.
ERRSRV (0x02)	ERRerror (0x0001)		EROFS	The spool file or spool queue resides on a read-only file system.
ERRerror ERRSRV (0x02)	ERRerror (0x0001)	STATUS_INVALID_SMB (0x00010002)		Malformed or invalid SMB request.
ERRSRV (0x02)	ERRerror (0x0001)			The server cannot find the spool queue for this file.
ERRSRV (0x02)	ERRinvtid 0x0005	STATUS_SMB_BAD_TID (0x00050002)		The TID specified in the command was invalid.
ERRSRV (0x02)	ERRinvdevice (0x0007)	STATUS_BAD_DEVICE_TYPE (0xC00000CB)		The TID does not refer to a printer resource.
ERRSRV (0x02)	ERRqfull (0x0031)	STATUS_PRINT_QUEUE_FULL (0xC00000C6)		Insufficient resources to create the print job; the queue is full.
ERRSRV (0x02)	ERRqtoobig (0x0032)	STATUS_NO_SPOOL_SPACE (0xC00000C7)		The queue is full; no entry is available to create the job.
ERRSRV (0x02)	ERRbaduid (0x005B)	STATUS_SMB_BAD_UID (0x005B0002)		The UID is not defined as a valid ID for this SMB session, or the user identified by the UID does not have sufficient privileges.

2.2.4.68 SMB_COM_WRITE_PRINT_FILE (0xC1)

This is an original **Core Protocol** command. This **command is deprecated**. Use the SMB_COM_WRITE_ANDX command to write to an open spool file.

This command is used to write data to an open print queue spool file.

The first data written to the print file **MUST** be printer-specific control data, the length of the control data block is specified in the **SMB_Parameters.Words.SetupLength** field in the

SMB_COM_OPEN_PRINT_FILE request that is used to create the print file. A single SMB_COM_WRITE_PRINT_FILE command can contain both printer-specific control data and print file data, as long as the control data is completely written first.

2.2.4.68.1 Request

```
SMB_Parameters
{
  UCHAR WordCount;
  Words
  {
    USHORT FID;
  }
}
SMB_Data
{
  USHORT ByteCount;
  Bytes
  {
    UCHAR BufferFormat;
    USHORT DataLength;
    UCHAR Data[DataLength];
  }
}
```

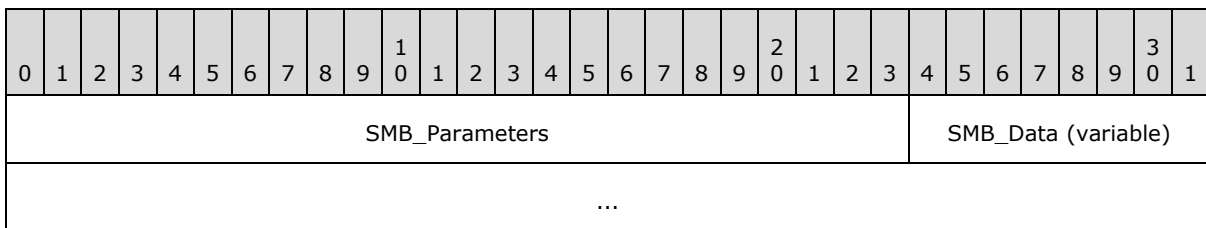

SMB_Parameters (3 bytes):

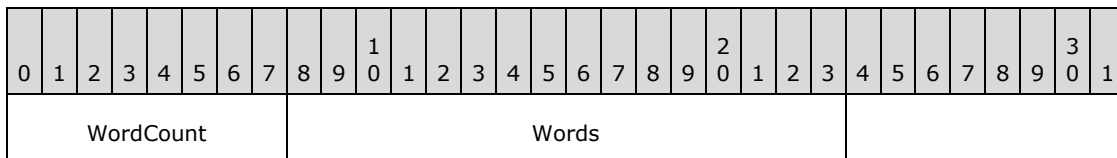

WordCount (1 byte): This field MUST be 0x01.

Words (2 bytes):

FID: This field MUST be a valid **FID** that is created using the SMB_COM_OPEN_PRINT_FILE command.

SMB_Data (variable):

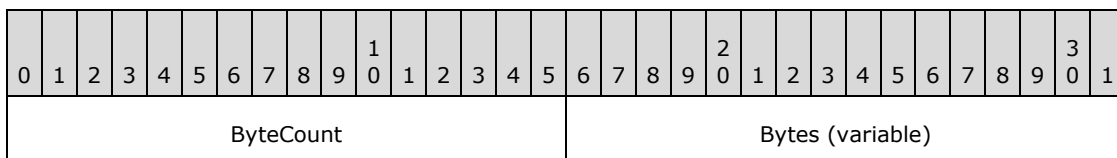

...

ByteCount (2 bytes): This field MUST be greater than or equal to 0x0003.

Bytes (variable): Array of UCHAR

0	1	2	3	4	5	6	7	8	9	10	11	12	13	14	15	16	17	18	19	20	21	22	23	24	25	26	27	28	29	30	31
BufferFormat										DataLength										Data (variable)											
...																															

BufferFormat (1 byte): This field MUST be 0x01.

DataLength (2 bytes): Length, in bytes, of the following data block.

Data (variable): STRING Bytes to be written to the spool file indicated by **FID**.

2.2.4.68.2 Response

```
SMB_Parameters
{
  UCHAR WordCount;
}
SMB_Data
{
  USHORT ByteCount;
}
```

0	1	2	3	4	5	6	7	8	9	10	11	12	13	14	15	16	17	18	19	20	21	22	23	24	25	26	27	28	29	30	31
SMB_Parameters										SMB_Data																					

SMB_Parameters (1 byte):

0	1	2	3	4	5	6	7	8	9	10	11	12	13	14	15	16	17	18	19	20	21	22	23	24	25	26	27	28	29	30	31
WordCount																															

WordCount (1 byte): This field MUST be 0x00. No parameters are sent by this message.

SMB_Data (2 bytes):

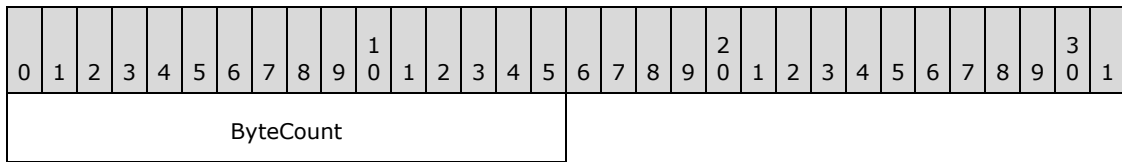

ByteCount (2 bytes): This field MUST be 0x0000. No data is sent by this message.

Error Codes

SMB error class	SMB error code	NT status code	POSIX equivalent	Description
ERRDOS (0x01)	ERRnoaccess (0x0005)		EAGAIN	A temporary resource limitation prevented this data from being written.
ERRDOS (0x01)	ERRnoaccess (0x0005)	STATUS_ACCESS_DENIED (0xC00000CA)		Client does not have write permission for the file.
ERRDOS (0x01)	ERRbadfid (0x0006)	STATUS_INVALID_HANDLE (0xC0000008) STATUS_SMB_BAD_FID (0x00060001)	ENFILE	FID is invalid to the system.
ERRDOS (0x01)	ERRnomem (0x0008)	STATUS_INSUFF_SERVER_RESOURCES (0xC0000205)	ENOMEM	The server is out of resources.
ERRSRV (0x02)	ERRerror (0x0001)	STATUS_INVALID_SMB (0x00010002)		Malformed or invalid SMB request.
ERRSRV (0x02)	ERRinvtid 0x0005	STATUS_SMB_BAD_TID (0x00050002)		The TID specified in the command was invalid.
ERRSRV (0x02)	ERRinvdevice (0x0007)	STATUS_BAD_DEVICE_TYPE (0xC00000CB)		The TID does not refer to a printer resource.
ERRSRV (0x02)	ERRqfull (0x0031)	STATUS_PRINT_QUEUE_FULL (0xC00000C6)		Insufficient resources to create the print job; the queue is full.
ERRSRV (0x02)	ERRqtoobig (0x0032)	STATUS_NO_SPOOL_SPACE (0xC00000C7)		The queue is full; no entry is available to create the job.
ERRSRV (0x02)	ERRbaduid (0x005B)	STATUS_SMB_BAD_UID (0x005B0002)		The UID is not defined as a valid ID for this SMB session, or the user

SMB error class	SMB error code	NT status code	POSIX equivalent	Description
				identified by the UID does not have sufficient privileges.
ERRHRD (0x03)	ERRwrite (0x001D)		EIO	A physical I/O error has occurred.

2.2.4.69 SMB_COM_CLOSE_PRINT_FILE (0xC2)

This is an original **Core Protocol** command. **This command is deprecated.** Client implementations SHOULD make use of SMB_COM_CLOSE to close a spool file opened by SMB_COM_OPEN_PRINT_FILE.

This command closes the specified print queue spool file, causing the server to queue the file for printing.

2.2.4.69.1 Request

```

SMB_Parameters
{
    UCHAR WordCount;
    Words
    {
        USHORT FID;
    }
}
SMB_Data
{
    USHORT ByteCount;
}

```

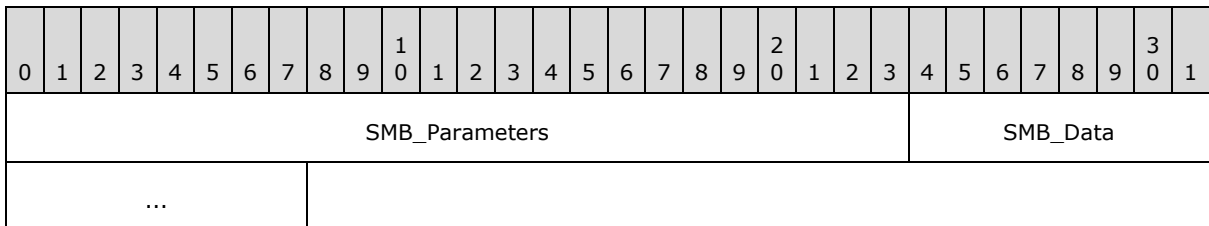

SMB_Parameters (3 bytes):

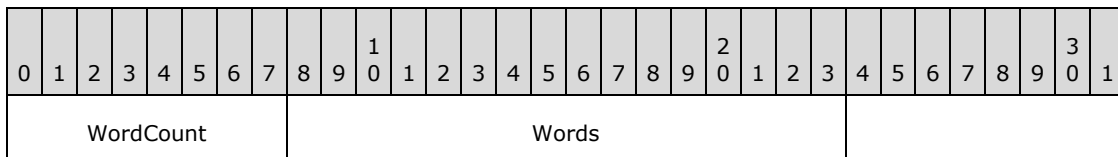

WordCount (1 byte): This field MUST be 0x01.

Words (2 bytes):

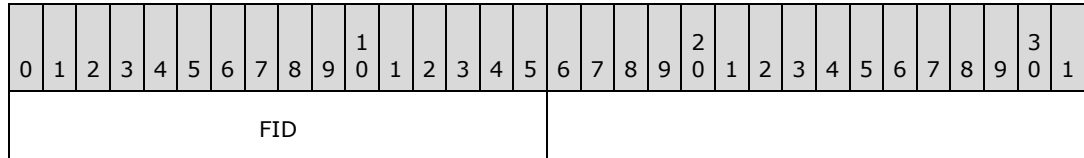

FID (2 bytes): This field MUST be a valid FID created using the SMB_COM_OPEN_PRINT_FILE command. Following successful execution of this command, this FID MUST be invalidated.

SMB_Data (2 bytes):

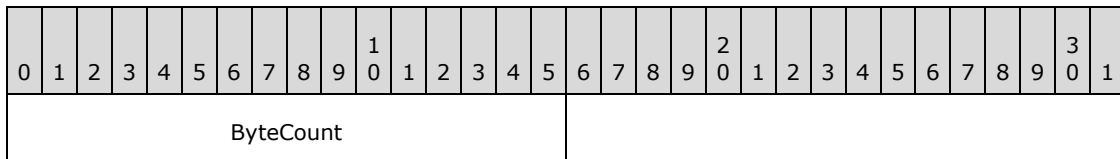

ByteCount (2 bytes): This field MUST be 0x0000. No data is sent by this message.

2.2.4.69.2 Response

```
SMB_Parameters
{
    UCHAR WordCount;
}
SMB_Data
{
    USHORT ByteCount;
}
```

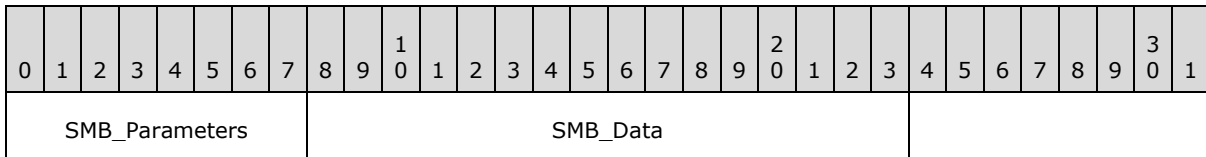

SMB_Parameters (1 byte):

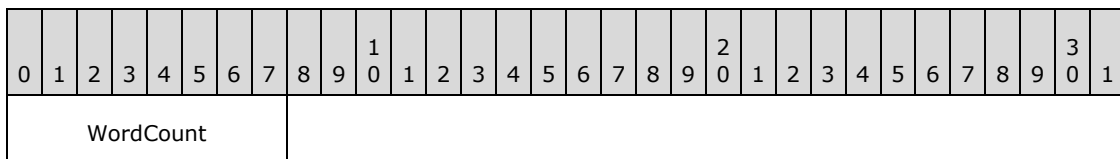

WordCount (1 byte): This field MUST be 0x00. No parameters are sent by this message

SMB_Data (2 bytes):

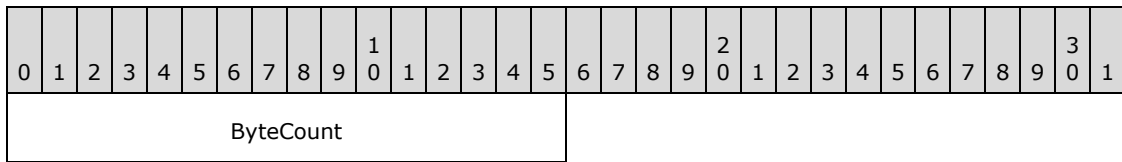

ByteCount (2 bytes): This field MUST be 0x0000. No data is sent by this message.

Error Codes

SMB error class	SMB error code	NT status code	POSIX equivalent	Description
ERRDOS (0x01)	ERRbadfid (0x0006)	STATUS_INVALID_HANDLE (0xC0000008) STATUS_SMB_BAD_FID (0x00060001)	ENFILE	The FID is invalid.
ERRSRV (0x02)	ERRerror (0x0001)	STATUS_INVALID_SMB (0x00010002)		The TID specified in the command is invalid.
ERRSRV (0x02)	ERRinvtid (0x0005)	STATUS_SMB_BAD_TID (0x00050002)		The TID specified in the command is invalid.
ERRSRV (0x02)	ERRbaduid (0x005B)	STATUS_SMB_BAD_UID (0x005B0002)		The UID specified is not defined as a valid ID on this server session, or the user identified by the UID does not have sufficient privileges.

2.2.4.70 SMB_COM_GET_PRINT_QUEUE (0xC3)

This is an original **Core Protocol** command (see [\[SMB-CORE\]](#) section 5.26). It was rendered obsolete in the **NT LAN Manager** dialect. This command was designated optional in [\[CIFS\].<126>](#)

This command was used to generate a list of items currently in a print queue associated with the specified **TID**. Clients SHOULD NOT send requests using this command code. Servers receiving requests with this command code MUST return STATUS_NOT_IMPLEMENTED (ERRDOS/ERRbadfunc).

2.2.4.71 SMB_COM_READ_BULK (0xD8)

This command was **reserved but not implemented**. It is listed in earlier documentation from Microsoft and third parties; however, no formal definition of the command was ever provided, and the command itself was never implemented. Two related commands--SMB_COM_WRITE_BULK and SMB_COM_WRITE_BULK_DATA--were also never implemented.

Clients SHOULD NOT send requests using this command code. Servers receiving requests with this command code SHOULD [<127>](#) return STATUS_NOT_IMPLEMENTED (ERRDOS/ERRbadfunc).

2.2.4.72 SMB_COM_WRITE_BULK (0xD9)

This command was **reserved but not implemented**. It is listed in earlier documentation from Microsoft and third parties; however, no formal definition of the command was ever provided, and

the command itself was never implemented. Two related commands--SMB_COM_READ_BULK and SMB_COM_WRITE_BULK_DATA--were also never implemented.

Clients SHOULD NOT send requests using this command code. Servers receiving requests with this command code SHOULD [<128>](#) return STATUS_NOT_IMPLEMENTED (ERRDOX/ERRbadfunc).

2.2.4.73 SMB_COM_WRITE_BULK_DATA (0xDA)

This command was **reserved but not implemented**. It is listed in earlier documentation from Microsoft and third parties; however, no formal definition of the command was ever provided, and the command itself was never implemented. Two related commands--SMB_COM_READ_BULK and SMB_COM_WRITE_BULK--were also never implemented.

Clients SHOULD NOT send requests using this command code. Servers receiving requests with this command code SHOULD [<129>](#) return STATUS_NOT_IMPLEMENTED (ERRDOS/ERRbadfunc).

2.2.4.74 SMB_COM_INVALID (0xFE)

This command was introduced in the **LAN Manager 1.0** dialect. It is a reserved value that specifically indicates an invalid command.

Clients SHOULD NOT send requests using this command code. Servers receiving requests with this command code MUST return STATUS_SMB_BAD_COMMAND (ERRSRV/ERRbadcmd).

2.2.4.75 SMB_COM_NO_ANDX_COMMAND (0xFF)

This command was introduced in the **LAN Manager 1.0** dialect. This command code was designated as the AndX Chain terminator.

Clients SHOULD NOT use this command code in a primary command. Servers receiving this command code in a primary command MUST return STATUS_SMB_BAD_COMMAND (ERRSRV/ERRbadcmd).

In the earliest SMB Protocol specifications (see [IBM-SMB]), this command code was reserved for proprietary protocol extensions. That usage is obsolete. Core Protocol documentation from Microsoft, including [\[SMB-CORE\]](#) and [\[MSFT-XEXTNP\]](#), does not include any reference to the use of this command code for protocol extensions or any other purpose.

2.2.5 Transaction Subcommands

Transaction subcommands are used to communicate with **mailslots** and named pipes. Mailslots are used for one-way inter-process communication. Named pipes are bidirectional.

2.2.5.1 TRANS_SET_NMPIPE_STATE (0x0001)

This Transaction subcommand was introduced in the **LAN Manager 1.0** dialect. [<130>](#)

The TRANS_SET_NMPIPE_STATE subcommand of the [SMB_COM_TRANSACTION](#) allows a client to set the read mode and the non-blocking mode of a specified named pipe.

This section covers the specific details of the TRANS_SET_NMPIPE_STATE subcommand ONLY. Request and response fields with values specific to this transaction are covered in this section. For general information see SMB_COM_TRANSACTION.

2.2.5.1.1 Request

```
Trans_Parameters
{
    USHORT PipeState;
}
```

SMB_Parameters:

WordCount (1 byte): This field value is the total number of SMB parameter words and MUST be 0x10.

Words (32 bytes):

TotalParameterCount (2 bytes): This field MUST be set to 0x0002 for this request.

TotalDataCount (2 bytes): This field MUST be set to 0x0000 for this request.

MaxParameterCount (2 bytes): This field MUST be set to 0x0000 for this request.

MaxDataCount (2 bytes): This field MUST be set to 0x0000 for this request.

MaxSetupCount (1 byte): This field MUST be set to 0x00 for this request.

Flags (2 bytes): This field SHOULD be set to 0x0000 for this request.

Timeout (4 bytes): This field SHOULD be set to 0x00000000 for this request.

ParameterCount (2 bytes): This field SHOULD be set to 0x0002 for this request.

DataCount (2 bytes): This field MUST be set to 0x0000 for this request.

SetupCount (1 byte): This field MUST be set to 0x02 for this request.

Setup (4 bytes):

Subcommand (2 bytes): This field MUST be set to the transaction subcommand value of TRANS_SET_NMPIPE_STATE (0x0001) for this request.

FID (2 bytes): This field MUST be set to the **FID** for the named pipe to read. This field MUST be set to a valid **FID** from a server response for a previous SMB command to open or create a named pipe. These commands include SMB_COM_OPEN, SMB_COM_CREATE, SMB_COM_CREATE_TEMPORARY, SMB_COM_CREATE_NEW, SMB_COM_OPEN_ANDX, SMB_COM_NT_CREATE_ANDX, and SMB_COM_NT_TRANSACT with subcommand NT_TRANSACT_CREATE.

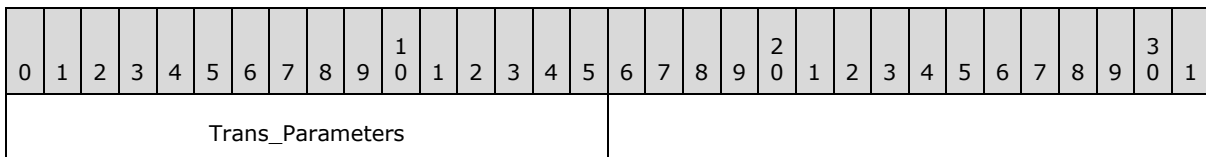

Trans_Parameters (2 bytes):

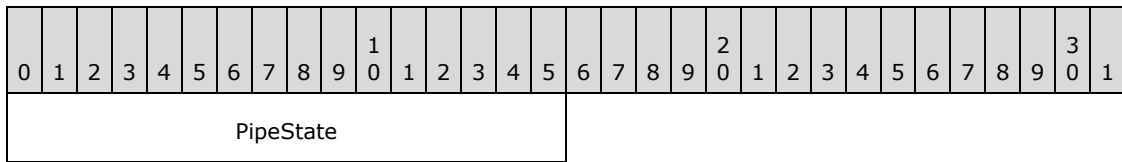

PipeState (2 bytes): This field contains the value that defines the state being set on the pipe. Any combination of the following flags MUST be valid for the set operation. All other flags are considered unused and SHOULD be set to 0 when this message is sent. The server MUST ignore the unused bits when the message is received.

Name and bitmask	Meaning
Nonblocking 0x8000	<p>If set, a read or a raw read request returns all data available to be read from the named pipe, up to the maximum read size set in the request. A write request returns after writing data to the named pipe without waiting for the data to be consumed. Named pipe non-blocking raw writes are not allowed. Raw writes MUST be performed in blocking mode.</p> <p>If not set, a read or a raw read request will wait (block) until sufficient data to satisfy the read request becomes available, or until the request is canceled. A write request blocks until its data is consumed, if the write request length is greater than zero.</p>
ReadMode 0x0100	<p>If set, the named pipe is operating in message mode. If not set, the named pipe is operating in byte mode. In message mode, the system treats the bytes read or written in each I/O operation to the pipe as a message unit. The system MUST perform write operations on message-type pipes as if write-through mode were enabled.</p>

2.2.5.1.2 Response

This message MUST be sent by a server to respond to a client sending the TRANS_SET_NMPIPE_STATE subcommand request when the request is successful. The server MUST set an error code in the **Status** field of the [SMB Header \(section 2.2.3.1\)](#) of the response to indicate whether the request to set the read mode and non-blocking mode succeeded or failed.

SMB_Parameters:

The SMB_Parameters section contains the relevant fields for the TRANS_QUERY_NMPIPE_STATE subcommand of the SMB_COM_TRANSACTION response.

WordCount (1 byte): This field value is the total number of SMB parameter words and MUST be 0x0A.

Words (20 bytes):

TotalParameterCount (2 bytes): This field MUST be set to 0x0000 for this request.

TotalDataCount (2 bytes): This field MUST be set to 0x0000 for this request.

ParameterCount (2 bytes): This field MUST be set to 0x0000 for this request.

DataCount (2 bytes): This field MUST be set to 0x0000 for this request.

DataDisplacement (2 bytes): This field MUST be set to 0x0000 for this request.

SetupCount (1 byte): This field MUST be set to 0x00 for this request.

Reserved2 (1 byte): An unused value that SHOULD be set to 0x00 when sending this response. The client MUST ignore this field when receiving this message.

Error Codes

SMB error class	SMB error code	NT status code	POSIX equivalent	Description
ERRDOS (0x01)	ERRbadfid (0x0006)	STATUS_INVALID_HANDLE (0xC0000008L) STATUS_SMB_BAD_FID (0x00060001)	EBADF	Invalid FID .
ERRDOS (0x01)	ERRnomem (0x0008)	STATUS_INSUFF_SERVER_RESOURCES (0xC0000205)	ENOMEM	The server is out of resources required to process the request.
ERRSRV (0x02)	ERRerror (0x0001)	STATUS_INVALID_SMB (0x00010002)		Invalid SMB. Not enough parameter bytes were sent.
ERRSRV (0x02)	ERRinvtid (0x0005)	STATUS_INVALID_HANDLE (0xC0000008L) STATUS_SMB_BAD_TID (0x00050002)		The TID is no longer valid.
ERRSRV (0x02)	ERRbaduid (0x005B)	STATUS_INVALID_HANDLE (0xC0000008L) STATUS_SMB_BAD_UID (0x005B0002)		The UID supplied is not defined to the session.

2.2.5.2 TRANS_RAW_READ_NMPIPE (0x0011)

This Transaction subcommand was introduced in the **LAN Manager 1.0** dialect. This subcommand is deprecated in favor of TRANS_READ_NMPIPE.

The TRANS_RAW_READ_NMPIPE subcommand of the [SMB_COM_TRANSACTION](#) allows for a raw read of data from a name pipe. This method of reading data from a named pipe ignores message boundaries even if the pipe was set up as a message mode pipe. When the named pipe is not set to non-blocking mode, and there is no data in the named pipe, the read operation on the server MUST wait indefinitely for data to become available. This section covers the specific details of using the TRANS_RAW_READ_NMPIPE subcommand. For general information see [SMB_COM_TRANSACTION.<131>](#)

2.2.5.2.1 Request

SMB_Parameters:

The SMB_Parameters section contains the relevant field values for the TRANS_RAW_READ_NMPIPE subcommand of the SMB_COM_TRANSACTION request.

WordCount (1 byte): The value of (0x0E) plus **Words.SetupCount**. This value represents the total number of SMB parameter words and MUST be 0x10.

Words (32 bytes):

TotalParameterCount (2 bytes): This field MUST be set to 0x0000 for this request.

TotalDataCount (2 bytes): This field MUST be set to 0x0000 for this request.

MaxParameterCount (2 bytes): This field MUST be set to 0x0000 for this request.

MaxDataCount (2 bytes): The value MUST be the number of bytes that the client is requesting to read from the named pipe.

MaxSetupCount (1 byte): This field MUST be set to 0x00 for this request.

Flags (2 bytes): This field SHOULD be set to 0x0000 for this request.

Timeout (4 bytes): This field SHOULD be set to 0x00000000 for this request.

ParameterCount (2 bytes): This field MUST be set to 0x0000 for this request.

DataCount (2 bytes): This field MUST be set to 0x0000 for this request.

SetupCount (1 byte): This field MUST be set to 0x02 for this request.

Setup (4 bytes):

Subcommand (2 bytes): This field MUST be set to the transaction subcommand value of TRANS_RAW_READ_NMPIPE (0x0011).

FID (2 bytes): This field is the FID for the named pipe to read. This field MUST be set to a valid FID from a server response for a previous SMB command to open or create a named pipe. These commands include SMB_COM_OPEN, SMB_COM_CREATE, SMB_COM_CREATE_TEMPORARY, SMB_COM_CREATE_NEW, SMB_COM_OPEN_ANDX, SMB_COM_NT_CREATE_ANDX, and SMB_COM_NT_TRANSACT with subcommand NT_TRANSACT_CREATE.

2.2.5.2.2 Response

This message MUST be sent by a server to respond to a client [TRANS_RAW_READ_NMPIPE Request \(section 2.2.5.2.1\)](#). The server MUST set an error code in the **Status** field of the [SMB Header \(section 2.2.3.1\)](#) of the response to indicate whether the read from the named pipe was successful or failed.

```
Trans_Data
{
    UCHAR BytesRead[TotalDataCount] (variable);
}
```

SMB_Parameters: The SMB_Parameters section contains the relevant fields for the [TRANS_RAW_READ_NMPIPE \(section 2.2.5.2\)](#) subcommand of the [SMB_COM_TRANSACTION Response \(section 2.2.4.33.2\)](#).

WordCount (1 byte): The count of 16-bit words in the response structure. For this response, this MUST be 0x0A, which is 0x0A plus the **SetupCount** of 0x00.

Words (20 bytes):

TotalParameterCount (2 bytes): This field MUST be set to 0x0000 for this request.

TotalDataCount (2 bytes): This value MUST be the number of bytes read from the named pipe in raw format.

ParameterCount (2 bytes): This field MUST be set to 0x0000 for this request.

ParameterDisplacement (2 bytes): This field MUST be set to 0x0000 for this request.

DataCount (2 bytes): The number of bytes in the **Trans_Data** buffer contained in this packet. For this response, it MUST be set to less than or equal to the value of the **TotalDataCount** field.

DataDisplacement (2 bytes): An offset in bytes into the final **Trans_Data** buffer assembled from all responses. For a single buffer transaction (whose **Trans_Data** buffer fits in a single response), this value MUST be set to 0x0000.

SetupCount (1 byte): This field MUST be set to 0x00 for this request.

0	1	2	3	4	5	6	7	8	9	10	11	12	13	14	15	16	17	18	19	20	21	22	23	24	25	26	27	28	29	30	31
Trans_Data (variable)																															
...																															

Trans_Data (variable):

The SMB_Data section of the SMB_COM_TRANSACTION Response contains the parameters and data generated by the transaction subcommand.

0	1	2	3	4	5	6	7	8	9	10	11	12	13	14	15	16	17	18	19	20	21	22	23	24	25	26	27	28	29	30	31
BytesRead (variable)																															
...																															

BytesRead (variable): The data buffer that MUST contain the bytes read from the named pipe in raw mode. The size of the buffer MUST be equal to the value in **TotalDataCount**.

Error Codes

SMB error class	SMB error code	NT status code	POSIX equivalent	Description
ERRDOS (0x01)	ERRbadfid (0x0006)	STATUS_INVALID_HANDLE (0xC0000008L) STATUS_SMB_BAD_FID	EBADF	Invalid FID .

SMB error class	SMB error code	NT status code	POSIX equivalent	Description
		(0x00060001)		
ERRDOS (0x01)	ERRnomem (0x0008)	STATUS_INSUFF_SERVER_RESOURCES (0xC0000205)	ENOMEM	The server is out of resources required to process the request.
ERRSRV (0x02)	ERRerror (0x0001)	STATUS_INVALID_SMB (0x00010002)		Invalid SMB. Not enough parameter bytes were sent.
ERRSRV (0x02)	ERRinvtid (0x0005)	STATUS_INVALID_HANDLE (0xC000008L) STATUS_SMB_BAD_TID (0x00050002)		The TID is no longer valid.
ERRSRV (0x02)	ERRbaduid (0x005B)	STATUS_INVALID_HANDLE (0xC000008L) STATUS_SMB_BAD_UID (0x005B0002)		The UID supplied is not defined to the session.

2.2.5.3 TRANS_QUERY_NMPIPE_STATE (0x0021)

This Transaction subcommand was introduced in the **LAN Manager 1.0** dialect. [<132>](#)

The TRANS_QUERY_NMPIPE_STATE subcommand of the [SMB_COM_TRANSACTION](#) allows a client to retrieve information about a specified named pipe. This section covers the specific details of using the TRANS_QUERY_NMPIPE_STATE subcommand. For general information see SMB_COM_TRANSACTION.

2.2.5.3.1 Request

SMB_Parameters: The SMB_Parameters section contains the relevant fields for the TRANS_QUERY_NMPIPE_STATE subcommand of the SMB_COM_TRANSACTION request.

WordCount (1 byte): This field value is the total number of SMB parameter words and MUST be 0x10.

Words (32 bytes):

TotalParameterCount (2 bytes): This field MUST be set to 0x0000.

TotalDataCount (2 bytes): This field MUST be set to 0x0000.

MaxParameterCount (2 bytes): This field SHOULD be set to 0x0002.

MaxDataCount (2 bytes): This field SHOULD be set to 0x0000 for this transaction.

MaxSetupCount (1 byte): This field SHOULD be set to 0x00.

Flags (2 bytes): This field SHOULD be set to 0x0000 for this request.

Timeout (4 bytes): This field SHOULD be set to 0x00000000 for this request.

ParameterCount (2 bytes): This field MUST be set to 0x0000.

DataCount (2 bytes): This field MUST be set to 0x0000.

SetupCount (1 byte): This field MUST be set to 0x02.

Setup (4 bytes):

Subcommand (2 bytes): This field MUST be set to the transaction subcommand value TRANS_QUERY_NMPIPE_STATE (0x0021).

FID (2 bytes): This field MUST be set to a valid FID of a named pipe received in a server response for a previous SMB command to open or create a named pipe. These commands include SMB_COM_OPEN, SMB_COM_CREATE, SMB_COM_CREATE_TEMPORARY, SMB_COM_CREATE_NEW, SMB_COM_OPEN_ANDX, SMB_COM_NT_CREATE_ANDX, and SMB_COM_NT_TRANSACT with subcommand NT_TRANSACT_CREATE.

2.2.5.3.2 Response

This message MUST be sent by a server to respond to a client sending the TRANS_QUERY_NMPIPE_STATE subcommand request when the request is successful. The server MUST set an error code in the **Status** field of the [SMB Header \(section 2.2.3.1\)](#) of the response to indicate whether the read from the named pipe succeeded or failed.

```
Trans_Parameters
{
    SMB_NMPIPE_STATUS NMPipeStatus;
}
```

SMB_Parameters: The SMB_Parameters section contains the relevant fields for the TRANS_QUERY_NMPIPE_STATE subcommand of the SMB_COM_TRANSACTION response.

WordCount (1 byte): This field MUST be set to 0x0A.

Words (20 bytes):

TotalParameterCount (2 bytes): This field MUST be set to 0x0002.

TotalDataCount (2 bytes): This field MUST be set to 0x0000.

ParameterCount (2 bytes): This field SHOULD be set to 0x0002.

ParameterDisplacement (2 bytes): This field SHOULD be set to 0x0000.

DataCount (2 bytes): This field MUST be set to 0x0000.

SetupCount (1 byte): This field MUST be set to 0x00.

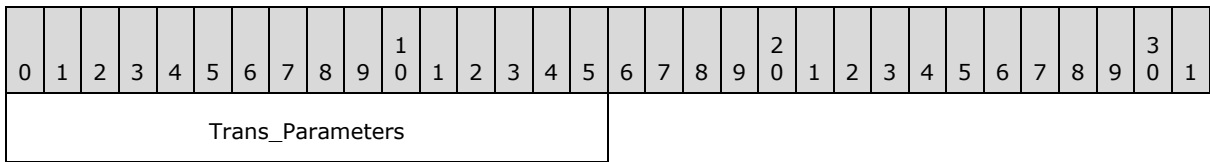

Trans_Parameters (2 bytes):

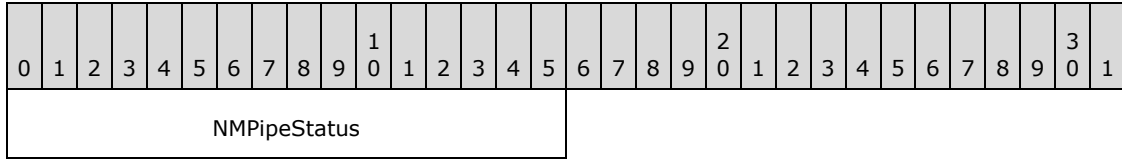

NMPipeStatus (2 bytes): A 16-bit field that shows the status of the named pipe. This field is formatted as an [SMB_NMPIPE_STATUS \(section 2.2.1.3\)](#).

Error Codes

SMB error class	SMB error code	NT status code	POSIX equivalent	Description
ERRDOS (0x01)	ERRbadfid (0x0006)	STATUS_INVALID_HANDLE (0xC0000008L) STATUS_SMB_BAD_FID (0x00060001)	EBADF	Invalid FID .
ERRDOS (0x01)	ERRnomem (0x0008)	STATUS_INSUFF_SERVER_RESOURCES (0xC0000205)	ENOMEM	The server is out of resources required to process the request.
ERRSRV (0x02)	ERRerror (0x0001)	STATUS_INVALID_SMB (0x00010002)		Invalid SMB. Not enough parameter bytes were sent.
ERRSRV (0x02)	ERRinvtid (0x0005)	STATUS_INVALID_HANDLE (0xC0000008L) STATUS_SMB_BAD_TID (0x00050002)		The TID is no longer valid.
ERRSRV (0x02)	ERRbaduid (0x005B)	STATUS_INVALID_HANDLE (0xC0000008L) STATUS_SMB_BAD_UID (0x005B0002)		The UID supplied is not defined to the session.

2.2.5.4 TRANS_QUERY_NMPIPE_INFO (0x0022)

This Transaction subcommand was introduced in the **LAN Manager 1.0** dialect. [<133>](#)

The TRANS_QUERY_NMPIPE_INFO subcommand of the [SMB_COM_TRANSACTION](#) allows for a client to retrieve information about a specified named pipe.

2.2.5.4.1 Request

```
Trans_Parameters
{
    USHORT Level;
}
```

SMB_Parameters: The SMB_Parameters section contains the relevant fields for the TRANS_QUERY_NMPIPE_INFO subcommand of the SMB_COM_TRANSACTION request.

WordCount (1 byte): This field value is the total number of SMB parameter words and MUST be 0x10.

Words (32 bytes):

TotalParameterCount (2 bytes): This field MUST be set to 0x0002.

TotalDataCount (2 bytes): This field MUST be set to 0x0000.

MaxParameterCount (2 bytes): This field SHOULD be set to 0x0000.

MaxDataCount (2 bytes): This field SHOULD be greater than or equal to 0x00040.

MaxSetupCount (1 byte): This field SHOULD be set to 0x0000.

Flags (2 bytes): This field SHOULD be set to 0x0000 for this request.

Timeout (4 bytes): This field SHOULD be set to 0x00000000 for this request.

ParameterCount (2 bytes) USHORT: This field SHOULD be set to 0x0002.

DataCount (2 bytes): This field MUST be set to 0x0000.

SetupCount (1 byte): This field MUST be set to 0x02.

Setup (4 bytes):

Subcommand (2 bytes): This field MUST be set to the transaction subcommand value of TRANS_QUERY_NMPIPE_INFO (0x0022).

FID (2 bytes): This field is the FID for the named pipe to read. This field MUST be set to a valid FID from a server response for a previous SMB command to open or create a named pipe. These commands include SMB_COM_OPEN, SMB_COM_CREATE, SMB_COM_CREATE_TEMPORARY, SMB_COM_CREATE_NEW, SMB_COM_OPEN_ANDX, SMB_COM_NT_CREATE_ANDX, and SMB_COM_NT_TRANSACT with subcommand NT_TRANSACT_CREATE.

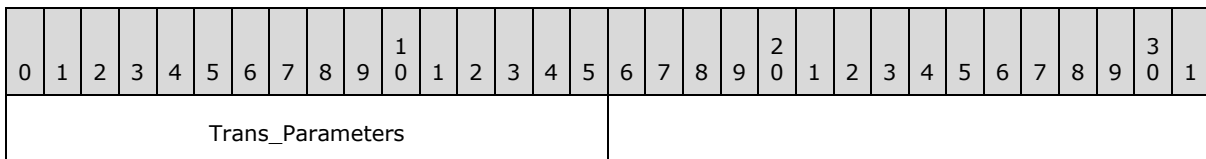

Trans_Parameters (2 bytes):

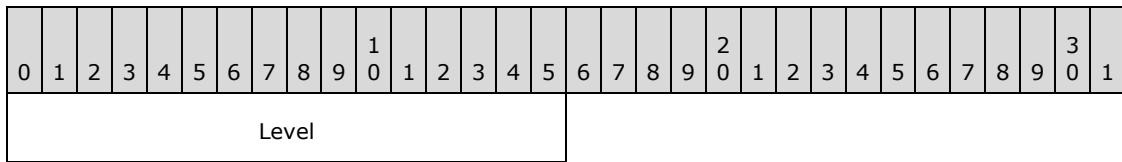

Level (2 bytes): This field MUST be set to 0x0001. This value (as specified in [\[MS-DTYP\]](#) section 2.2.59) describes the information level being queried for the pipe. If the server receives any other value, it MUST fail the request with a status of STATUS_INVALID_PARAMETER (ERRDOS/ERRinvalidparam).

2.2.5.4.2 Response

SMB_Parameters

```

Trans_Data
{
    USHORT    OutputBufferSize;
    USHORT    InputBufferSize;
    UCHAR     MaximumInstances;
    UCHAR     CurrentInstances;
    UCHAR     PipeNameLength;
    SMB_STRING PipeName;
}

```

The SMB_Parameters section contains the relevant fields for the TRANS_QUERY_NMPIPE_INFO subcommand of the SMB_COM_TRANSACTION response.

WordCount (1 byte): This field value is the total number of SMB parameter words and MUST be 0x0A.

Words (20 bytes):

TotalParameterCount (2 bytes): This field MUST be set to 0x0000 for this request.

TotalDataCount (2 bytes): This field MUST be greater than or equal to 0x0007.

ParameterCount (2 bytes): This field MUST be set to 0x0000.

DataCount (2 bytes): This field MUST be set to less than or equal to the value of the **TotalDataCount** field.

SetupCount (1 byte): This field MUST be set to 0x00.

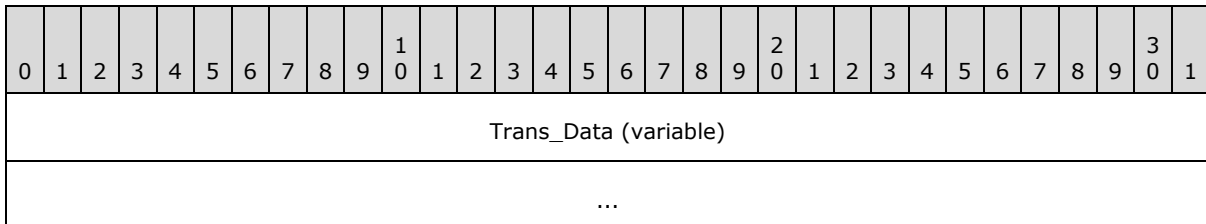

Trans_Data (variable):

The Trans_Data section of the SMB_COM_TRANSACTION response contains the parameters and data generated by the transaction TRANS_QUERY_NMPIPE_INFO subcommand.

0	1	2	3	4	5	6	7	8	9	10	11	12	13	14	15	16	17	18	19	20	21	22	23	24	25	26	27	28	29	30	31
OutputBufferSize																InputBufferSize															
MaximumInstances								CurrentInstances								PipeNameLength								PipeName (variable)							
...																															

OutputBufferSize (2 bytes): This field MUST be the actual size of the buffer for outgoing (server) I/O.

InputBufferSize (2 bytes): This field MUST be the actual size of the buffer for incoming (client) I/O.

MaximumInstances (1 byte): This field MUST be the maximum number of allowed instances of the named pipe.

CurrentInstances (1 byte): This field MUST be the current number of named pipe instances. The count increments when the server creates a named pipe and decrements when the server closes the named pipe for an unconnected pipe, or when both the server and the client close the named pipe for a connected pipe.

PipeNameLength (1 byte): This field MUST be the length in bytes of the pipe name, including the terminating null character.

PipeName (variable): This field MUST be a null-terminated string containing the name of the named pipe, not including the initial \\NodeName string (that is, of the form \PIPE\pipename). If SMB_FLAGS2_UNICODE is set in the **Flags2** field of the [SMB Header \(section 2.2.3.1\)](#) of the response, the name string MUST be in a null-terminated array of 16-bit Unicode characters. Otherwise, the name string MUST be a null-terminated array of OEM characters. If the **PipeName** field consists of Unicode characters, this field MUST be aligned to start on a 2-byte boundary from the start of the SMB Header.

Error Codes

SMB error class	SMB error code	NT status code	POSIX equivalent	Description
ERRDOS (0x01)	ERRbadfid (0x0006)	STATUS_INVALID_HANDLE (0xC000008L) STATUS_SMB_BAD_FID (0x00060001)	EBADF	Invalid FID.
ERRDOS (0x01)	ERRnomem (0x0008)	STATUS_INSUFF_SERVER_RESOURCES (0xC0000205)	ENOMEM	The server is out of resources required to process the request.

SMB error class	SMB error code	NT status code	POSIX equivalent	Description
ERRDOS (0x01)	ERRinvalidparam (0x0057)	STATUS_INVALID_PARAMETER (0xC000000D)		Invalid value in Level field.
ERRDOS (0x01)	ERRbufftosmall (0x007A)	STATUS_BUFFER_TOO_SMALL (0xC0000023)		The MaxDataCount is too small to accept the request information.
ERRDOS (0x01)	ERRmoredata (0x00EA)	STATUS_BUFFER_OVERFLOW (0x8000005L)		There is more data available than can fit based on the MaxDataCount sent by the client. The pipe name has been requested and cannot fit in within the MaxDataCount buffer.
ERRSRV (0x02)	ERRerror (0x0001)	STATUS_INVALID_SMB (0x00010002)		Invalid or corrupt SMB.
ERRSRV (0x02)	ERRinvtid (0x0005)	STATUS_INVALID_HANDLE (0xC000008L) STATUS_SMB_BAD_TID (0x00050002)		The TID is no longer valid.
ERRSRV (0x02)	ERRbaduid (0x005B)	STATUS_INVALID_HANDLE (0xC000008L) STATUS_SMB_BAD_UID (0x005B0002)		The UID supplied is not defined to the session.

2.2.5.5 TRANS_PEEK_NMPIPE (0x0023)

This Transaction subcommand was introduced in the **LAN Manager 1.0** dialect. <134>

The TRANS_PEEK_NMPIPE subcommand of the [SMB_COM_TRANSACTION](#) is used to copy data out of a named pipe without removing it and to retrieve information about data in a named pipe. This section covers the specific details of using the TRANS_PEEK_NMPIPE subcommand. For general information see [SMB_COM_TRANSACTION](#). <135>

2.2.5.5.1 Request

SMB_Parameters: The SMB_Parameters section contains the relevant fields for the TRANS_RAW_READ_NMPIPE subcommand of the SMB_COM_TRANSACTION request.

WordCount (1 byte): This field MUST be set to 0x10.

Words (32 bytes):

TotalParameterCount (2 bytes): This field MUST be set to 0x0000.

TotalDataCount (2 bytes): This field MUST be set to 0x0000.

MaxParameterCount (2 bytes): This field SHOULD be set to 0x0006.

MaxDataCount (2 bytes): This field SHOULD be set to the number of bytes that the client attempts to peek from the named pipe.

MaxSetupCount (1 byte): This field SHOULD be 0x00.

Flags (2 bytes): This field SHOULD be set to 0x0000 for this request.

Timeout (4 bytes): This field SHOULD be set to 0x00000000 for this request.

ParameterCount (2 bytes): This field MUST be set to 0x0000.

DataCount (2 bytes): This field MUST be set to 0x0000.

SetupCount (1 byte): This field MUST be set to 0x02.

Setup (4 bytes):

Subcommand (2 bytes): This field MUST be set to the transaction subcommand of TRANS_PEEK_NMPIPE (0x0023).

FID (2 bytes): This field is the FID for the named pipe to read. This field MUST be set to a valid FID from a server response for a previous SMB command to open or create a named pipe. These commands include SMB_COM_OPEN, SMB_COM_CREATE, SMB_COM_CREATE_TEMPORARY, SMB_COM_CREATE_NEW, SMB_COM_OPEN_ANDX, SMB_COM_NT_CREATE_ANDX, and SMB_COM_NT_TRANSACT with subcommand NT_TRANSACT_CREATE.

2.2.5.5.2 Response

```
Trans_Parameters
{
    USHORT ReadDataAvailable;
    USHORT MessageBytesLength;
    USHORT NamedPipeState;
}
Trans_Data
{
    UCHAR ReadData[TotalDataCount] (variable);
}
```

The server MUST set an error code in the **Status** field of the [SMB Header \(section 2.2.3.1\)](#) of the response to indicate whether the operation on the named pipe succeeded or failed.

SMB_Parameters: The SMB_Parameters section contains the relevant fields for the TRANS_PEEK_NMPIPE subcommand of the SMB_COM_TRANSACTION response.

WordCount (1 byte): This field MUST be set to 0x0A.

Words (20 bytes):

TotalParameterCount (2 bytes): This field MUST be set to 0x0006.

TotalDataCount (2 bytes): This field MUST be set to the number of bytes read from the named pipe in a peek fashion and in raw format.

ParameterCount (2 bytes): This field MUST be set to 0x0006.

DataCount (2 bytes): This field MUST be set to less than or equal to the value of the **TotalDataCount** field.

SetupCount (1 byte): The number of setup words. For this response, it MUST be set to 0x00.

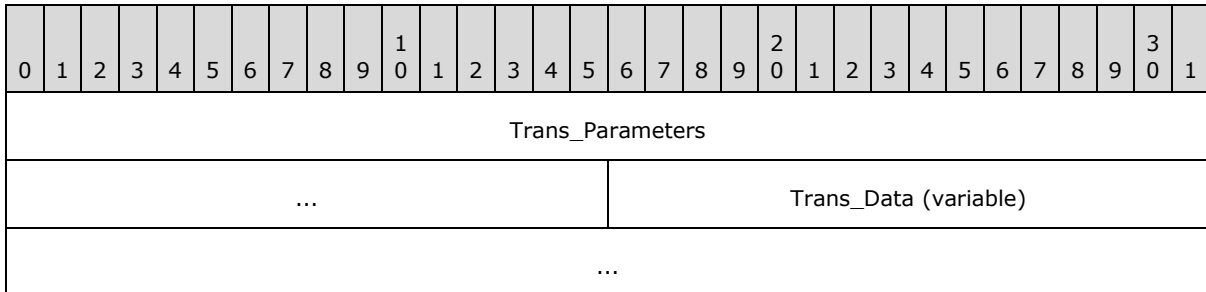

Trans_Parameters (6 bytes):

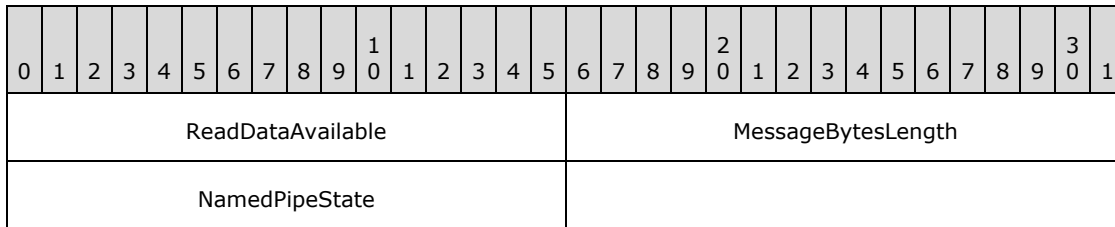

ReadDataAvailable (2 bytes): This field contains the total number of bytes available to be read from the pipe.

MessageBytesLength (2 bytes): If the named pipe is a message mode pipe, this MUST be set to the number of bytes remaining in the message that was peeked (the number of bytes in the message minus the number of bytes read). If the entire message was read, this value is 0x0000. If the named pipe is a byte mode pipe, this value MUST be set to 0x0000.

NamedPipeState (2 bytes): The status of the named pipe.

Value	Meaning
0x0001	Named pipe was disconnected by server.
0x0002	Named pipe is listening.
0x0003	Named pipe connection to the server is okay.
0x0004	Server end of named pipe is closed.

Trans_Data (variable):

0	1	2	3	4	5	6	7	8	9	0	1	2	3	4	5	6	7	8	9	0	1	2	3	4	5	6	7	8	9	0	1
ReadData (variable)																															
...																															

ReadData (variable): This field contains the data read from the named pipe.

Error Codes

SMB error class	SMB error code	NT status code	POSIX equivalent	Description
ERRDOS (0x01)	ERRbadfid (0x0006)	STATUS_INVALID_HANDLE (0xC000008L) STATUS_SMB_BAD_FID (0x00060001)	EBADF	Invalid FID.
ERRDOS (0x01)	ERRnomem (0x0008)	STATUS_INSUFF_SERVER_RESOURCES (0xC0000205)	ENOMEM	The server is out of resources required to process the request.
ERRDOS (0x01)	ERRmoredata (0x00EA)	STATUS_BUFFER_OVERFLOW (0x8000005L)		There is more data available than can fit in the response buffer based on the MaxDataCount field value in the client request. None of the data was returned in the response.
ERRSRV (0x02)	ERRerror (0x0001)	STATUS_INVALID_SMB (0x00010002)		Invalid SMB. Not enough parameter bytes were sent.
ERRSRV (0x02)	ERRinvtid (0x0005)	STATUS_INVALID_HANDLE (0xC000008L) STATUS_SMB_BAD_TID (0x00050002)		The TID is no longer valid.
ERRSRV (0x02)	ERRbaduid (0x005B)	STATUS_INVALID_HANDLE (0xC000008L) STATUS_SMB_BAD_UID (0x005B0002)		The UID supplied is not defined to the session.

2.2.5.6 TRANS_TRANSACT_NMPIPE (0x0026)

This Transaction subcommand was introduced in the **LAN Manager 1.0** dialect. <136>

The TRANS_TRANSACT_NMPIPE subcommand of the [SMB_COM_TRANSACTION](#) is used to execute a transacted exchange against a named pipe. This transaction MUST only be used for named pipes of the duplex message type. This section covers the specific details of using the TRANS_TRANSACT_NMPIPE subcommand. For general information see SMB_COM_TRANSACTION.

2.2.5.6.1 Request

```
Trans_Data
{
    UCHAR WriteData[TotalDataCount];
}
```

SMB_Parameters: The SMB_Parameters section contains the relevant fields for the TRANS_TRANSACT_NMPIPE subcommand of the SMB_COM_TRANSACTION request.

WordCount (1 byte): This field MUST be set to 0x10.

Words (32 bytes):

TotalParameterCount (2 bytes): This field MUST be set to 0x0000.

TotalDataCount (2 bytes): This field MUST be set to the number of bytes that the client requests to write to the named pipe as part of the transaction.

MaxParameterCount (2 bytes): This field MUST be set to 0x0000.

MaxDataCount (2 bytes): This field MUST be the number of bytes that the client requests to read from the named pipe as part of the transacted operation.

MaxSetupCount (1 byte): This field MUST be set to 0x00.

Flags (2 bytes): This field SHOULD be set to 0x0000 for this request.

Timeout (4 bytes): This field SHOULD be set to 0x00000000 for this request.

ParameterCount (2 bytes): This field MUST be set to 0x0000.

DataCount (2 bytes): This field MUST be set to the number of data bytes in this request to be written to the named pipe during the transaction. For a single-request transaction, this MUST be equal to the **TotalDataCount**.

SetupCount (1 byte): This field MUST be set to 0x02.

Setup (4 bytes):

Subcommand (2 bytes): This field MUST be set to the transaction subcommand of TRANS_TRANSACT_NMPIPE (0x0026).

FID (2 bytes): This field is the FID for the named pipe that is being transacted. This field MUST be set to a valid FID from a server response for a previous SMB command to open or create a named pipe. These commands include SMB_COM_OPEN, SMB_COM_CREATE, SMB_COM_CREATE_TEMPORARY,

SMB_COM_CREATE_NEW, SMB_COM_OPEN_ANDX, SMB_COM_NT_CREATE_ANDX, and SMB_COM_NT_TRANSACT with subcommand NT_TRANSACT_CREATE.

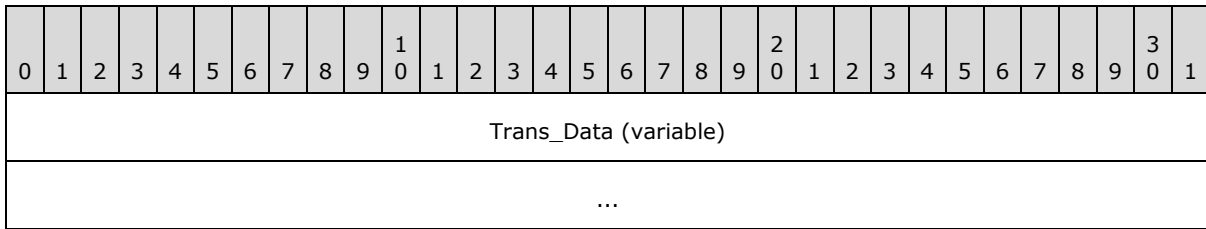

Trans_Data (variable):

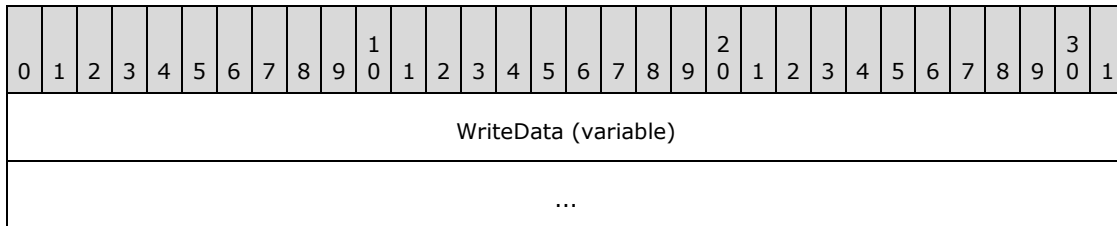

WriteData (variable): This field MUST contain the bytes to be written to the named pipe as part of the transacted operation.

2.2.5.6.2 Response

The server MUST set an error code in the **Status** field of the [SMB Header \(section 2.2.3.1\)](#) of the response to indicate whether the transaction against the named pipe succeeded or failed. [<137>](#)

```
Trans_Data
{
    UCHAR ReadData[TotalDataCount];
}
```

SMB_Parameters: The SMB_Parameters section contains the relevant fields for the [TRANS_TRANSACTION_NMPIPE \(section 2.2.5.6\)](#) subcommand of the [SMB_COM_TRANSACTION \(section 2.2.4.33\)](#) response.

WordCount (1 byte): This field MUST be set to 0x0A.

Words (20 bytes):

TotalParameterCount (2 bytes): This field MUST be set to 0x0000.

TotalDataCount (2 bytes): This field MUST be the total number of bytes read from the named pipe in raw format.

ParameterCount (2 bytes): This field MUST be set to 0x0000.

DataCount (2 bytes): This field MUST be set to the number of bytes read from the named pipe that are returned in this response. This field MUST be less than or equal to the value of the **TotalDataCount** field.

SetupCount (1 byte): This field MUST be set to 0x00.

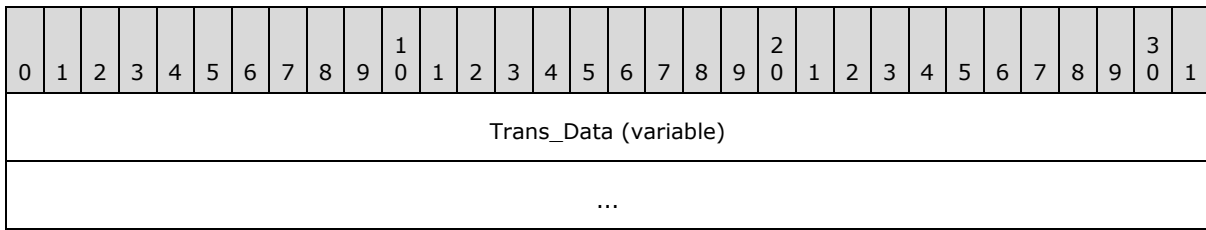

Trans_Data (variable):

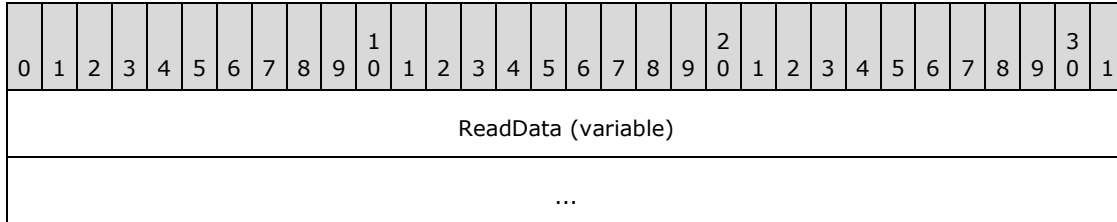

ReadData (variable): This field MUST contain data read from the named pipe.

Error Codes

SMB error class	SMB error code	NT status code	POSIX equivalent	Description
ERRDOS (0x01)	ERRbadfid (0x0006)	STATUS_INVALID_HANDLE (0xC0000008) STATUS_SMB_BAD_FID (0x00060001)	EBADF	Invalid FID .
ERRDOS (0x01)	ERRnomem (0x0008)	STATUS_INSUFF_SERVER_RESOURCES (0xC0000205)	ENOMEM	The server is out of resources required to process the request.
ERRDOS (0x01)	ERRinvalidparam (0x0057)	STATUS_INVALID_PARAMETER (0xC000000D)		The named pipe indicated by the FID is not in message mode.
ERRDOS (0x01)	ERRmoredata (0x00EA)	STATUS_BUFFER_OVERFLOW (0x80000005)		There is more data available than can fit in the response buffer based on the MaxDataCount field value in the client request.
ERRSRV (0x02)	ERRerror (0x0001)	STATUS_INVALID_SMB (0x00010002)		Invalid SMB. Not enough parameter bytes were sent.

SMB error class	SMB error code	NT status code	POSIX equivalent	Description
ERRSRV (0x02)	ERRinvtid (0x0005)	STATUS_INVALID_HANDLE (0xC0000008) STATUS_SMB_BAD_TID (0x00050002)		The TID is no longer valid.
ERRSRV (0x02)	ERRbaduid (0x005B)	STATUS_INVALID_HANDLE (0xC0000008) STATUS_SMB_BAD_UID (0x005B0002)		The UID supplied is not defined to the session.

2.2.5.7 TRANS_RAW_WRITE_NMPIPE (0x0031)

This Transaction subcommand was introduced in the **LAN Manager 1.0** dialect. This subcommand is deprecated. Clients can use either TRANS_WRITE_NMPIPE or TRANS_TRANSACT_NMPIPE.

The TRANS_RAW_WRITE_NMPIPE subcommand of the [SMB_COM_TRANSACTION](#) allows for a raw write of data to a named pipe. Raw writes to named pipes put bytes directly into a pipe in byte mode, regardless of whether it is a message mode pipe or byte mode pipe.

This method of writing data into a named pipe assumes that the data itself contains the message boundaries if the pipe is a message mode pipe. The operation can allow a single write to insert multiple messages.

This section covers the specific details of using the TRANS_RAW_WRITE_NMPIPE subcommand. For general information, see SMB_COM_TRANSACTION. [<138>](#)

2.2.5.7.1 Request

```
Trans_Data
{
    UCHAR WriteData[TotalDataCount];
}
```

SMB_Parameters:

WordCount (1 byte): This field MUST be set to 0x10.

Words (32 bytes):

TotalParameterCount (2 bytes): This field MUST be set to 0x0000.

TotalDataCount (2 bytes): This field MUST be set to the total number of bytes that the client attempts to write to the named pipe in raw format.

MaxParameterCount (2 bytes): This field MUST be set to 0x0002.

MaxDataCount (2 bytes): This field MUST be set to 0x0000.

MaxSetupCount (1 byte): This field MUST be set to 0x00.

ParameterCount (2 bytes): This field MUST be set to 0x0000.

DataCount (2 bytes): This field MUST be set to the number of bytes being written to the named pipe in raw format contained in this request. If this is the only request of this transaction, the **TotalDataCount** field MUST equal the **DataCount** field.

SetupCount (1 byte): This field MUST be set to 0x02.

Setup (4 bytes):

Subcommand (2 bytes): This field MUST be set to the transaction subcommand of TRANS_RAW_WRITE_NMPIPE (0x0031).

FID (2 bytes): This field is the FID for the named pipe to read. This field MUST be set to a valid FID from a server response for a previous SMB command to open or create a named pipe. These commands include SMB_COM_OPEN, SMB_COM_CREATE, SMB_COM_CREATE_TEMPORARY, SMB_COM_CREATE_NEW, SMB_COM_OPEN_ANDX, SMB_COM_NT_CREATE_ANDX, and SMB_COM_NT_TRANSACT with subcommand NT_TRANSACT_CREATE.

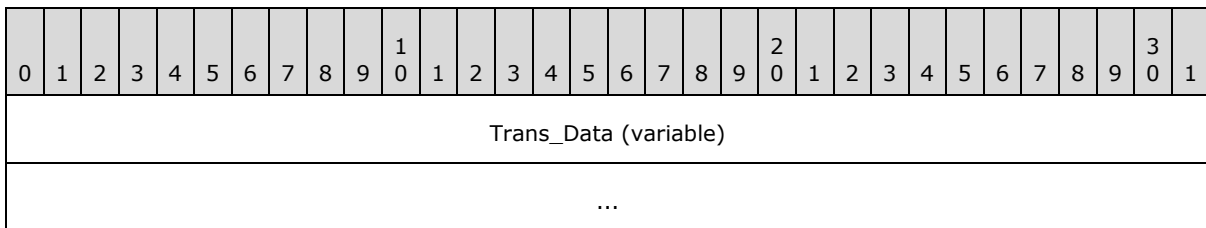

Trans_Data (variable):

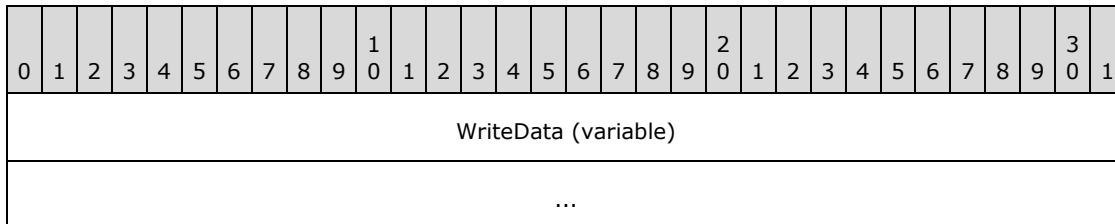

WriteData (variable): This field MUST contain the bytes to write to the named pipe in raw format. The size of the buffer MUST be equal to the value in **TotalDataCount**.

2.2.5.7.2 Response

The server MUST set an error code in the SMB_Header.Status field of the response to indicate whether the read from the named pipe succeeded or failed.

```
Trans_Parameters
{
    USHORT BytesWritten;
}
```

SMB_Parameters: The SMB_Parameters section contains the relevant fields for the TRANS_RAW_WRITE_NMPIPE subcommand of the SMB_COM_TRANSACTION response.

WordCount (1 byte): This field MUST be set to 0x0A.

Words (20 bytes):

TotalParameterCount (2 bytes): This field MUST be set to 0x0002.

TotalDataCount (2 bytes): This field MUST be set to 0x0000.

ParameterCount (2 bytes): This field MUST be set to 0x0002.

DataCount (2 bytes): This field MUST be set to 0x0000.

SetupCount (1 byte): This field MUST be set to 0x00.

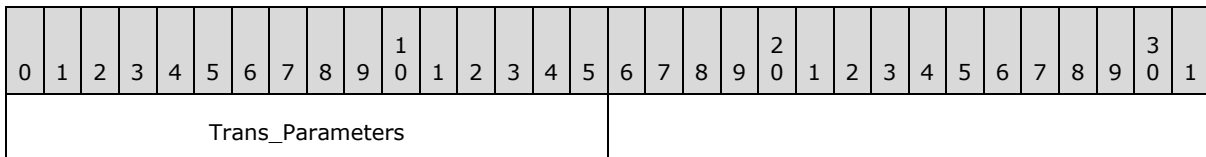

Trans_Parameters (2 bytes):

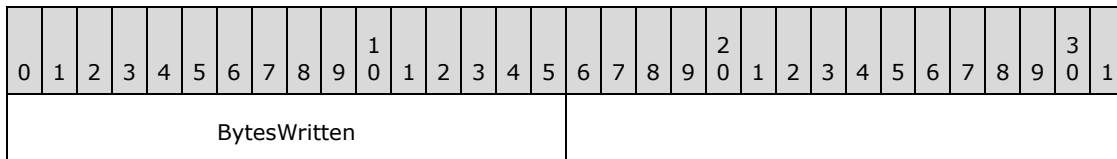

BytesWritten (2 bytes): This field MUST be set to the number of bytes written to the pipe.

Error Codes

SMB error class	SMB error code	NT status code	POSIX equivalent	Description
ERRDOS (0x01)	ERRbadfid (0x0006)	STATUS_INVALID_HANDLE (0xC0000008L) STATUS_SMB_BAD_FID (0x00060001)	EBADF	Invalid FID.
ERRDOS (0x01)	ERRnomem (0x0008)	STATUS_INSUFF_SERVER_RESOURCES (0xC0000205)	ENOMEM	The server is out of resources required to process the request.
ERRDOS (0x01)	ERRinvalidparam (0x0057)	STATUS_INVALID_PARAMETER (0xC000000D)		The named pipe indicated by the FID is not in message mode or this is not a 2-byte write request that contains two null padding

SMB error class	SMB error code	NT status code	POSIX equivalent	Description
				bytes.
ERRSRV (0x02)	ERRerror (0x0001)	STATUS_INVALID_SMB (0x00010002)		Invalid SMB. Not enough parameter bytes were sent.
ERRSRV (0x02)	ERRinvtid (0x0005)	STATUS_INVALID_HANDLE (0xC0000008L) STATUS_SMB_BAD_TID (0x00050002)		The TID is no longer valid.
ERRSRV (0x02)	ERRbaduid (0x005B)	STATUS_INVALID_HANDLE (0xC0000008L) STATUS_SMB_BAD_UID (0x005B0002)		The UID supplied is not defined to the session.

2.2.5.8 TRANS_READ_NMPIPE (0x0036)

This Transaction subcommand was introduced in the NT LAN Manager dialect.

The TRANS_READ_NMPIPE subcommand of the [SMB_COM_TRANSACTION](#) allows a client to read data from a named pipe. This section covers the specific details of using the TRANS_READ_NMPIPE subcommand. For general information, see SMB_COM_TRANSACTION.

2.2.5.8.1 Request

SMB_Parameters: The SMB_Parameters section contains the relevant fields for the TRANS_READ_NMPIPE subcommand of the SMB_COM_TRANSACTION request.

WordCount (1 byte): This field MUST be set to 0x10.

Words (32 bytes):

TotalParameterCount (2 bytes): This field MUST be set to 0x0000.

TotalDataCount (2 bytes): This field MUST be set to 0x0000.

MaxParameterCount (2 bytes): This field MUST be set to 0x0000.

MaxDataCount (2 bytes): This field MUST be set to the maximum number of bytes that the client attempts to read from the named pipe.

MaxSetupCount (1 byte): This field MUST be 0x00.

ParameterCount (2 bytes): This field MUST be set to 0x0000.

DataCount (2 bytes): This field MUST be set to 0x0000.

SetupCount (1 byte): This field MUST be set to 0x02.

Setup (4 bytes):

Subcommand (2 bytes): This field MUST be set to the transaction subcommand of TRANS_READ_NMPIPE (0x0036).

FID (2 bytes): This field is the FID for the named pipe to read. This field MUST be set to a valid FID from a server response for a previous SMB command to open or create a named pipe. These commands include SMB_COM_OPEN, SMB_COM_CREATE, SMB_COM_CREATE_TEMPORARY, SMB_COM_CREATE_NEW, SMB_COM_OPEN_ANDX, SMB_COM_NT_CREATE_ANDX, and SMB_COM_NT_TRANSACT with subcommand NT_TRANSACT_CREATE.

2.2.5.8.2 Response

The server MUST set an error code in the **Status** field of the [SMB Header \(section 2.2.3.1\)](#) of the response to indicate whether the read from the named pipe succeeded or failed.

If the named pipe specified in the **Request.SMB_Parameters.Setup.FID** field is not set to non-blocking mode, and there is no data in the named pipe, the read operation will wait indefinitely.

```
Trans_Data
{
    UCHAR ReadData[TotalDataCount];
}
```

SMB_Parameters: The SMB_Parameters section contains the relevant fields for the TRANS_READ_NMPIPE subcommand of the SMB_COM_TRANSACTION response.

WordCount (1 byte): This field MUST be set to 0x0A.

Words (20 bytes):

TotalParameterCount (2 bytes): This field MUST be set to 0x0000.

TotalDataCount (2 bytes): This field MUST be set to the total number of bytes read from the named pipe.

ParameterCount (2 bytes): This field MUST be set to 0x0000.

DataCount (2 bytes): This field MUST be set to the number of bytes that the **ReadData** field contained in the **Trans_Data** of this response. For this response, it MUST be set to less than or equal to the value of the **TotalDataCount** field.

SetupCount (1 byte): This field MUST be set to 0x00.

0	1	2	3	4	5	6	7	8	9	10	1	2	3	4	5	6	7	8	9	20	1	2	3	4	5	6	7	8	9	30	1		
Trans_Data (variable)																																	
...																																	

Trans_Data (variable):

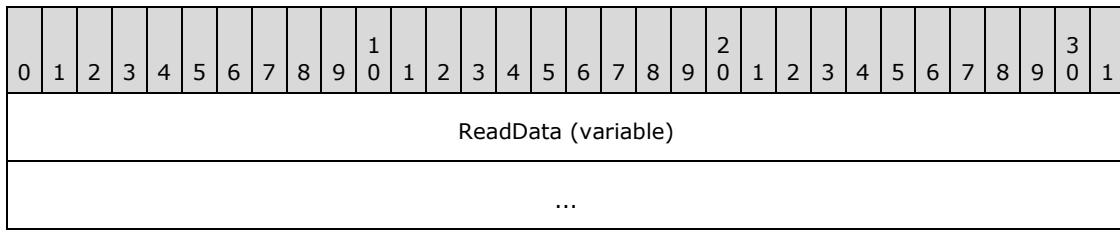

ReadData (variable): This field MUST contain the bytes read from the named pipe. The size of the buffer MUST be equal to the value in **TotalDataCount**. If the named pipe is a message mode pipe, and the entire message was not read, the **Status** field in the SMB Header MUST be set to STATUS_BUFFER_OVERFLOW.

Error Codes

SMB error class	SMB error code	NT status code	POSIX equivalent	Description
ERRDOS (0x01)	ERRbadfid (0x0006)	STATUS_INVALID_HANDLE (0xC000008L) STATUS_SMB_BAD_FID (0x00060001)	EBADF	Invalid FID.
ERRDOS (0x01)	ERRnomem (0x0008)	STATUS_INSUFF_SERVER_RESOURCES (0xC0000205)	ENOMEM	The server is out of resources required to process the request.
ERRDOS (0x01)	ERRmoredata (0x00EA)	STATUS_BUFFER_OVERFLOW (0x8000005L)		There is more data available than can fit in the response buffer based on the MaxDataCount field value in the client request. MaxDataCount bytes of data were returned in the response.
ERRSRV (0x02)	ERRerror (0x0001)	STATUS_INVALID_SMB (0x00010002)		Invalid SMB. Not enough parameter bytes were sent.
ERRSRV (0x02)	ERRinvtid (0x0005)	STATUS_INVALID_HANDLE (0xC000008L) STATUS_SMB_BAD_TID (0x00050002)		The TID is no longer valid.
ERRSRV (0x02)	ERRbaduid (0x005B)	STATUS_INVALID_HANDLE (0xC000008L) STATUS_SMB_BAD_UID (0x005B0002)		The UID supplied is not known to the session.

2.2.5.9 TRANS_WRITE_NMPIPE (0x0037)

This Transaction subcommand was introduced in the NT LAN Manager dialect.

The TRANS_WRITE_NMPIPE subcommand of SMB_COM_TRANSACTION allows a client to write data to a named pipe. This section covers the specific details of using the TRANS_WRITE_NMPIPE subcommand. For general information see SMB_COM_TRANSACTION.

2.2.5.9.1 Request

```
Trans_Data
{
    UCHAR WriteData[TotalDataCount];
}
```

SMB_Parameters: The SMB_Parameters section contains the relevant fields for the TRANS_WRITE_NMPIPE subcommand of the SMB_COM_TRANSACTION request.

WordCount (1 byte): This field MUST be set to 0x10.

Words (32 bytes):

TotalParameterCount (2 bytes): This field MUST be set to 0x0000.

TotalDataCount (2 bytes): This field MUST be the total number of bytes that the client requests to write to the named pipe.

MaxParameterCount (2 bytes): This field MUST be set to 0x0002.

MaxDataCount (2 bytes): This field MUST be 0x0000.

MaxSetupCount (1 byte): This field MUST be 0x00.

Flags (2 bytes): This field SHOULD be set to 0x0000 for this request.

Timeout (4 bytes): This field SHOULD be set to 0x00000000 for this request.

ParameterCount (2 bytes): This field MUST be set to 0x0000.

DataCount (2 bytes): This field MUST be set to the number of bytes being written to the named pipe in this request.

SetupCount (1 byte): This field MUST be set to 0x0002.

Setup (4 bytes):

Subcommand (2 bytes): This field MUST be set to the transaction subcommand value of TRANS_WRITE_NMPIPE (0x0037).

FID (2 bytes): This field is the FID for the named pipe to write. This field MUST be set to a valid FID from a server response for a previous SMB command to open or create a named pipe. These commands include SMB_COM_OPEN, SMB_COM_CREATE, SMB_COM_CREATE_TEMPORARY, SMB_COM_CREATE_NEW, SMB_COM_OPEN_ANDX, SMB_COM_NT_CREATE_ANDX, and SMB_COM_NT_TRANSACT with subcommand NT_TRANSACT_CREATE.

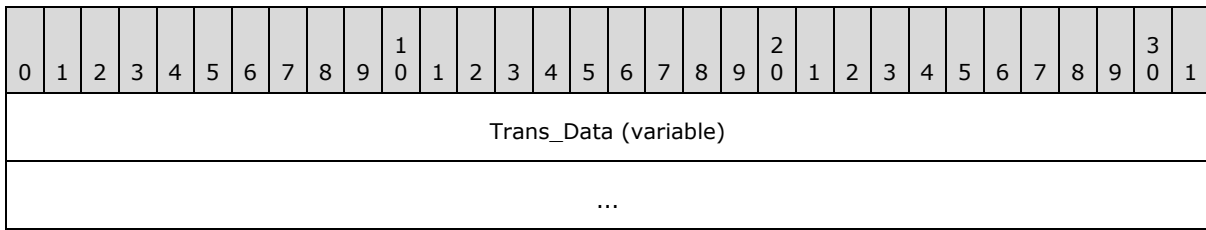

Trans_Data (variable):

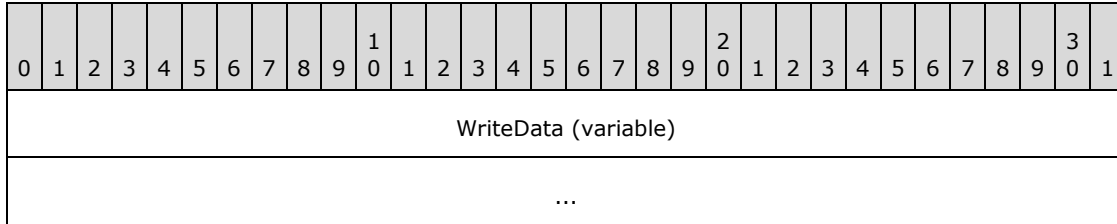

WriteData (variable): This field MUST contain the bytes to write to the named pipe. The size of the buffer MUST be equal to the value in **TotalDataCount**.

2.2.5.9.2 Response

```
Trans_Parameters
{
  USHORT BytesWritten;
}
```

The server MUST set an error code in the **Status** field of the [SMB Header \(section 2.2.3.1\)](#) of the response to indicate whether the read from the named pipe succeeded or failed.

SMB_Parameters: The SMB_Parameters section contains the relevant fields for the TRANS_WRITE_NMPIPE subcommand of the SMB_COM_TRANSACTION response.

WordCount (1 byte): This field MUST be set to 0x0A.

Words (20 bytes):

TotalParameterCount (2 bytes): This field MUST be set to 0x0002.

TotalDataCount (2 bytes): This field MUST be set to 0x0000.

ParameterCount (2 bytes): This field SHOULD be set to 0x0002.

DataCount (2 bytes): This field MUST be set to 0x0000.

SetupCount (1 byte): This field MUST be set to 0x00.

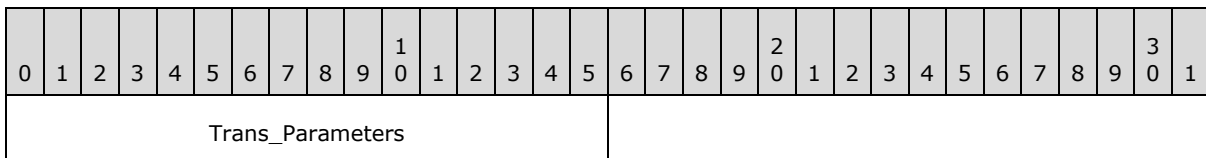

Trans_Parameters (2 bytes):

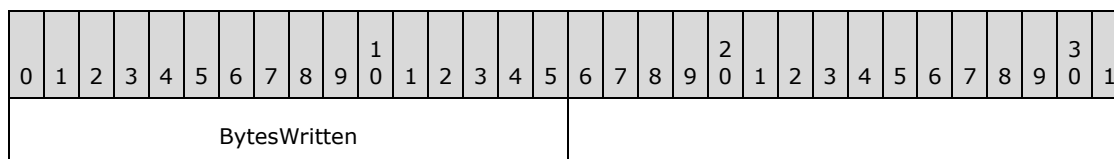

BytesWritten (2 bytes): This field MUST be set to the number of bytes written to the pipe.

Error Codes

SMB error class	SMB error code	NT status code	POSIX equivalent	Description
ERRDOS (0x01)	ERRbadfid (0x0006)	STATUS_INVALID_HANDLE (0xC0000008L) STATUS_SMB_BAD_FID (0x00060001)	EBADF	Invalid FID.
ERRDOS (0x01)	ERRnomem (0x0008)	STATUS_INSUFF_SERVER_RESOURCES (0xC0000205)	ENOMEM	The server is out of resources required to process the request.
ERRSRV (0x02)	ERRerror (0x0001)	STATUS_INVALID_SMB (0x00010002)		Invalid SMB. Not enough parameter bytes were sent.
ERRSRV (0x02)	ERRinvtid (0x0005)	STATUS_INVALID_HANDLE (0xC0000008L) STATUS_SMB_BAD_TID (0x00050002)		The TID is no longer valid.
ERRSRV (0x02)	ERRbaduid (0x005B)	STATUS_INVALID_HANDLE (0xC0000008L) STATUS_SMB_BAD_UID (0x005B0002)		The UID supplied is not defined to the session.

2.2.5.10 TRANS_WAIT_NMPIPE (0x0053)

This Transaction subcommand was introduced in the **LAN Manager 1.0** dialect. <139>

The TRANS_WAIT_NMPIPE subcommand of the [SMB_COM_TRANSACTION](#) allows a client to be notified when the specified named pipe is available to be connected to. This section covers the specific details of using the TRANS_WAIT_NMPIPE subcommand. For general information, see SMB_COM_TRANSACTION.

2.2.5.10.1 Request

SMB_Parameters: The SMB_Parameters section contains the relevant fields for the TRANS_WAIT_NMPIPE subcommand of the SMB_COM_TRANSACTION request.

WordCount (1 byte): This field MUST be set to 0x10.

Words (32 bytes):

TotalParameterCount (2 bytes): This field MUST be set to 0x0000.

TotalDataCount (2 bytes): This field MUST be set to 0x0000.

MaxParameterCount (2 bytes): This field MUST be set to 0x0000.

MaxDataCount (2 bytes): This field MUST be set to 0x0000.

MaxSetupCount (1 byte): This field MUST be set to 0x00.

Flags (2 bytes): This field SHOULD be set to 0x0000 for this request.

Timeout (4 bytes): This field MUST be set to the maximum number of milliseconds that the server SHOULD wait for the named pipe to become available. [<140>](#)

ParameterCount (2 bytes): This field MUST be set to 0x0000.

DataCount (2 bytes): This field MUST be set to 0x0000.

SetupCount (1 byte): This field MUST be set to 0x02.

Setup (4 bytes):

Subcommand (2 bytes): This field MUST be set to the transaction subcommand TRANS_WAIT_NMPIPE (0x0053).

Priority (2 bytes): This field SHOULD be in the range of 0x0000 to 0x03FF, where 0x0000 indicates that the server SHOULD use a default value. Larger values indicate higher priority. [<141>](#)

SMB_Data: The SMB_Data section contains the relevant fields for the TRANS_WAIT_NMPIPE subcommand of the SMB_COM_TRANSACTION request.

ByteCount (2 bytes): This field MUST be greater than or equal to 0x0001.

Name (variable): The name field MUST be set to the name of the pipe being waited for, in the format \PIPE\<pipename> where <pipename> is the name of the pipe to wait to connect to. To wait on the pipe PipeA, the name field is set to \PIPE\PipeA. If SMB_FLAGS2_UNICODE is set in the **Flags2** field of the [SMB Header \(section 2.2.3.1\)](#) of the request, the name string MUST be a null-terminated array of 16-bit Unicode characters. Otherwise, the name string MUST be a null-terminated array of OEM characters. If the name string consists of Unicode characters, this field MUST be aligned to start on a 2-byte boundary from the start of the SMB header.

2.2.5.10.2 Response

The server MUST set an error code in the **Status** field of the [SMB Header \(section 2.2.3.1\)](#) of the response to indicate whether the transact operation on the named pipe succeeded or failed. The server returns a response when either the named pipe is available to be connected to or the **Timeout** field specified in the client request has been exceeded. If the **Timeout** value is exceeded, the server MUST return STATUS_IO_TIMEOUT in the **Status** field of the SMB Header. If the named pipe is available to be connected to, and the **Timeout** is not exceeded, the server MUST return STATUS_SUCCESS in the **Status** field of the SMB Header.

Error Codes

SMB error class	SMB error code	NT status code	POSIX equivalent	Description
ERRDOS (0x01)	ERRbadfid (0x0006)	STATUS_INVALID_HANDLE (0xC0000008L) STATUS_SMB_BAD_FID (0x00060001)	EBADF	Invalid FID .
ERRDOS (0x01)	ERRnomem (0x0008)	STATUS_INSUFF_SERVER_RESOURCES (0xC0000205)	ENOMEM	The server is out of resources required to process the request.
ERRDOS (0x01)	ERRtimeout (0x0058)	STATUS_IO_TIMEOUT		The request timed out.
ERRSRV (0x02)	ERRerror (0x0001)	STATUS_INVALID_SMB (0x00010002)		Invalid SMB. Pipe name might not be valid or request is not internally consistent.
ERRSRV (0x02)	ERRinvtid (0x0005)	STATUS_INVALID_HANDLE (0xC0000008L) STATUS_SMB_BAD_TID (0x00050002)		The TID is no longer valid.
ERRSRV (0x02)	ERRbaduid (0x005B)	STATUS_INVALID_HANDLE (0xC0000008L) STATUS_SMB_BAD_UID (0x005B0002)		The UID supplied is not defined to the session.

2.2.5.11 TRANS_CALL_NMPIPE (0x0054)

This Transaction subcommand was introduced in the **LAN Manager 1.0** dialect. [<142>](#)

The TRANS_CALL_NMPIPE subcommand allows a client to open a named pipe, issue a write to the named pipe, issue a read from the named pipe, and close the named pipe. The named pipe is opened in message mode. This section covers the specific details of using the TRANS_CALL_NMPIPE subcommand. For general information, see [SMB_COM_TRANSACTION \(section 2.2.4.34\)](#).

2.2.5.11.1 Request

```
Trans_Data
{
    UCHAR WriteData[TotalDataCount];
}
```

SMB_Parameters: The SMB_Parameters section contains the relevant fields for the TRANS_CALL_NMPIPE subcommand of the [SMB_COM_TRANSACTION Request \(section 2.2.4.33.1\)](#).

WordCount (1 byte): This field MUST be set to 0x10.

Words (32 bytes):

TotalParameterCount (2 bytes): This field MUST be set to 0x0000.

TotalDataCount (2 bytes): This field MUST be set to the total number of bytes that the client attempts to write to the named pipe.

MaxParameterCount (2 bytes): This field MUST be set to 0x0000.

MaxDataCount (2 bytes): This field MUST be set to the number of bytes that the client attempts to read from the named pipe.

MaxSetupCount (1 byte): This field MUST be 0x00.

Flags (2 bytes): This field SHOULD be set to 0x0000 for this request.

Timeout (4 bytes): This field SHOULD be set to 0x00000000 for this request.

ParameterCount (2 bytes): This field MUST be set to 0x0000.

DataCount (2 bytes): This field MUST be set to the count of bytes in the **Trans_Data.WriteData** buffer field. If this field is less than the value of **TotalDataCount** then the client MUST send at least one more request to send the remaining (TotalDataCount - DataCount) bytes to write to the named pipe.

SetupCount (1 byte): This field MUST be set to 0x02.

Setup (4 bytes):

Subcommand (2 bytes): This field MUST be set to the transaction subcommand TRANS_CALL_NMPIPE 0x0054.

Priority (2 bytes): This field MUST be in the range of 0x0000 to 0x0009. The larger value is the higher priority.

SMB_Data: The SMB_Data section contains the relevant fields for the TRANS_READ_NMPIPE subcommand of the SMB_COM_TRANSACTION request.

ByteCount (2 bytes): The value of this field MUST be the count of bytes that follows the **ByteCount** field.

Name (variable): The name field MUST be set to the name of the pipe, in the format \PIPE\<pipename> where <pipename> is the name of the pipe to open. To open the pipe PipeA, the name field is set to \PIPE\PipeA. If SMB_FLAGS2_UNICODE is set in the **Flags2** field of the [SMB Header \(section 2.2.3.1\)](#) of the request, the name string MUST be a null-terminated array of 16-bit Unicode characters. Otherwise, the name string MUST be a null-terminated array of OEM characters. If the name string consists of Unicode characters, this field MUST be aligned to start on a 2-byte boundary from the start of the SMB Header.

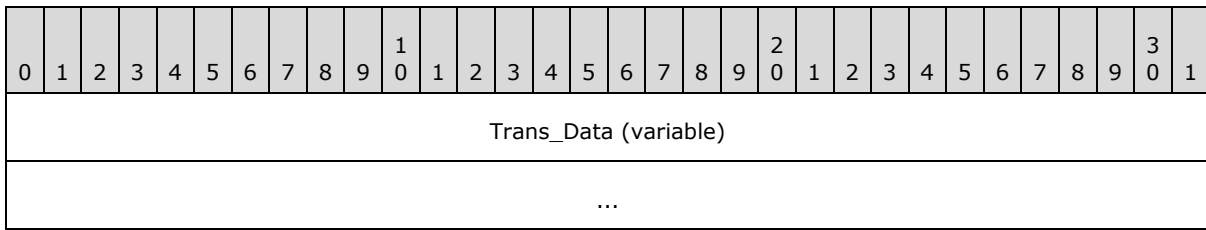

Trans_Data (variable):

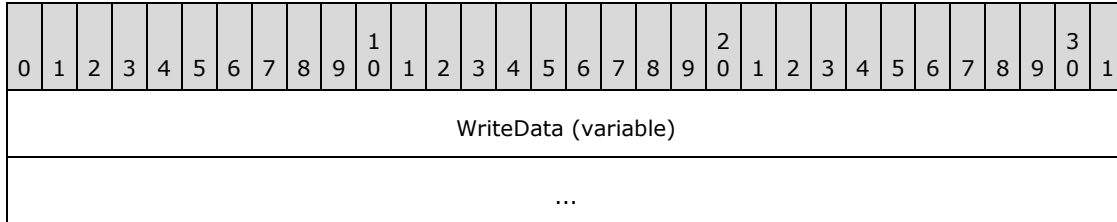

WriteData (variable): This field MUST contain the bytes to write to the named pipe. The size of the buffer MUST be equal to the value in **TotalDataCount**.

2.2.5.11.2 Response

The server MUST set an error code in the **Status** field of the [SMB Header \(section 2.2.3.1\)](#) of the response to indicate whether the transaction succeeded or failed.

```
Trans_Data
{
  UCHAR ReadData[TotalDataCount];
}
```

SMB_Parameters:

The SMB_Parameters section contains the relevant fields for the [TRANS_READ_NMPIPE \(section 2.2.5.8\)](#) subcommand of the [SMB_COM_TRANSACTION Response \(section 2.2.4.33.2\)](#).

WordCount (1 byte): This field MUST be set to 0x0A.

Words (20 bytes):

TotalParameterCount (2 bytes): This field MUST be set to 0x0000.

TotalDataCount (2 bytes): This field MUST be set to the total number of bytes read from the named pipe.

ParameterCount (2 bytes): This field MUST be set to 0x0000.

DataCount (2 bytes): This field MUST be set to the number of bytes contained in the **Trans_Data.ReadData** field. The value MUST be less than or equal to **TotalDataCount**. If the value is less than **TotalDataCount**, the server MUST send the remaining bytes in one or more additional response messages. [<143>](#)

SetupCount (1 byte): This field SHOULD [<144>](#) be set to 0x00.

0	1	2	3	4	5	6	7	8	9	0	1	2	3	4	5	6	7	8	9	0	1	2	3	4	5	6	7	8	9	0	1
Trans_Data (variable)																															
...																															

Trans_Data (variable):

0	1	2	3	4	5	6	7	8	9	0	1	2	3	4	5	6	7	8	9	0	1	2	3	4	5	6	7	8	9	0	1
ReadData (variable)																															
...																															

ReadData (variable): This field MUST contain the bytes read from the named pipe. The size of the buffer MUST be equal to the value in the **TotalDataCount** field of the response. If the named pipe is a message mode pipe, and the entire message was not read, the **Status** field in the SMB Header MUST be set to STATUS_BUFFER_OVERFLOW.

Error Codes

SMB error class	SMB error code	NT status code	POSIX equivalent	Description
ERRDOS (0x01)	ERRnomem (0x0008)	STATUS_INSUFF_SERVER_RESOURCES (0xC0000205)	ENOMEM	The server is out of resources required to process the request.
ERRDOS (0x01)	ERRbadaccess (0x000C)	STATUS_ACCESS_DENIED (0xC0000022)		Write permission required.
ERRDOS (0x01)	ERRmoredata (0x00EA)	STATUS_BUFFER_OVERFLOW (0x8000005L)		There is more data available than can fit in the response buffer based on the MaxDataCount field value in the client request.
ERRSRV (0x02)	ERRerror (0x0001)	STATUS_INVALID_SMB (0x00010002)		Invalid SMB. Not enough parameter bytes were sent.
ERRSRV (0x02)	ERRinvtid (0x0005)	STATUS_INVALID_HANDLE (0xC0000008L) STATUS_SMB_BAD_TID (0x00050002)		The TID is no longer valid.

SMB error class	SMB error code	NT status code	POSIX equivalent	Description
ERRSRV (0x02)	ERRbaduid (0x005B)	STATUS_INVALID_HANDLE (0xC0000008L) STATUS_SMB_BAD_UID (0x005B0002)		The UID supplied is not defined to the session.

2.2.5.12 TRANS_MAILSLOT_WRITE (0x0001)

The TRANS_MAILSLOT_WRITE transaction subcommand was introduced in the **LAN Manager 1.0 dialect**. It is used to write a message to a mailslot.

The subcommand code for a TRANS_MAILSLOT_WRITE is 0x0001, which is identical to the subcommand code for TRANS_SET_NMPIPE_STATE. This is permitted because transaction subcommand codes are not global; they are interpreted relative to the resource being accessed.

There are no mailslot operations that are defined as part of the CIFS protocol. Mailslots are not accessed over SMB sessions (although the Mailslot sub-protocol defines a mechanism for doing so). As a result, mailslot operations are documented separately. For more information on the Remote Mailslot Protocol, see [\[MS-MAIL\]](#) and [\[MSLOT\]](#).

Windows clients do not send TRANS_MAILSLOT_WRITE commands via CIFS sessions. Related protocols, such as [\[MS-BRWS\]](#), send Class 2 mailslot messages as NetBIOS datagrams. TRANS_MAILSLOT_WRITE commands carrying Class 2 messages do not require responses. See [\[MS-MAIL\]](#).

2.2.6 Transaction2 Subcommands

2.2.6.1 TRANS2_OPEN2 (0x0000)

This Transaction2 subcommand was introduced in the NT LAN Manager dialect.

This transaction is used to open or create a file and set extended attributes on the file.

2.2.6.1.1 Request

The TRANS2_OPEN2 request and response formats are a special case of [SMB_COM_TRANSACTION2 \(section 2.2.4.46\)](#) SMB. Only the TRANS2_OPEN2 request specifics are described here.

SMB_Parameters

WordCount (1 byte): This field MUST be 0x0F.

Words (30 bytes):

TotalDataCount (2 bytes): This field MUST be zero (0x0000) if no **Trans2_Data** is being supplied. This field MUST be the total size of the **Trans2_Data** if extended attributes are being provided.

SetupCount (1 byte): This field MUST be 0x01.

Setup (2 bytes): This field MUST be TRANS2_OPEN2 (0x0000).

Trans2_Parameters

```

Trans2_Parameters
{
    USHORT          Flags;
    USHORT          AccessMode;
    USHORT          Reserved1;
    SMB_FILE_ATTRIBUTES FileAttributes;
    UTIME           CreationTime;
    USHORT          OpenMode;
    ULONG           AllocationSize;
    USHORT          Reserved[5];
    SMB_STRING      FileName;
}

```

0	1	2	3	4	5	6	7	8	9	10	11	12	13	14	15	16	17	18	19	20	21	22	23	24	25	26	27	28	29	30	31
Flags																AccessMode															
Reserved1																FileAttributes															
CreationTime																															
OpenMode																AllocationSize															
...																Reserved															
...																															
...																															
FileName (variable)																															
...																															

Flags (2 bytes): This 16-bit field of flags is used to request that the server take certain actions.

Bitmask	Meaning
REQ_ATTRIB 0x0001	Return additional information in the response; populate the CreationTime , FileDataSize , AccessMode , ResourceType , and NMPipeStatus fields in the response.
REQ_OPLOCK 0x0002	Exclusive OpLock requested.
REQ_OPBATCH 0x0004	Batch OpLock requested.
REQ_EASIZE 0x0008	Return total length of Extended Attributes (EAs); populate the ExtendedAttributeLength field in the response.

AccessMode (2 bytes): A 16-bit field for encoding the requested access mode. See section [3.2.4.5.1](#) for a discussion on sharing modes.

Name and bitmask	Values	Meaning
AccessMode 0x0007	0	Open for reading.
	1	Open for writing.
	2	Open for reading and writing.
	3	Open for execution.
0x0008	Reserved	
SharingMode 0x0070	0	Compatibility mode
	1	Deny read/write/execute to others (exclusive use requested).
	2	Deny write to others.
	3	Deny read/execute to others.
	4	Deny nothing to others.
0x0080	Reserved	
ReferenceLocality 0x0700	0	Unknown locality of reference
	1	Mainly sequential access
	2	Mainly random access
	3	Random access with some locality
	4 - 7	Undefined
0x0800	Reserved	
CacheMode 0x1000	0	Perform caching on file.
	1	Do not cache the file.
0x2000	Reserved	
WritethroughMode 0x4000	0	Write-through mode. If this flag is set, then no read ahead or write behind is allowed on this file or device. When the response is returned, data is expected to be on the disk or device.
	1	
0x8000	Reserved	

Reserved1 (2 bytes): This field MUST be set to zero (0x0000) and MUST be ignored by the server.

FileAttributes (2 bytes): Attributes to apply to the file if it needs to be created.

CreationTime (4 bytes): A 32-bit integer time value to be assigned to the file as the time of creation if the file is to be created.

OpenMode (2 bytes): A 16-bit field that controls the way that a file SHOULD be treated when it is opened for use by certain extended SMB requests.

Name and bitmask	Values	Meaning
FileExistsOpts 0x0003	0	The request SHOULD fail and an error SHOULD be returned indicating the prior existence of the file.
	1	The file is to be appended.
	2	The file is to be truncated to zero (0) length.
	3	Reserved
CreateFile 0x0010	0	If the file does not exist, return error.
	1	If the file does not exist, create it.

All other bits are reserved; they SHOULD NOT be used by the client and MUST be ignored by the server.

AllocationSize (4 bytes): The number of bytes to reserve for the file if the file is being created or truncated.

Reserved (10 bytes): All entries in this field MUST be set to zero (0x0000).

FileName (variable): A buffer containing the name of the file to be opened, created, or truncated. The string MUST be null terminated.

Trans2_Data

```
Trans2_Data
{
    SMB_FEA_LIST ExtendedAttributeList;
}
```

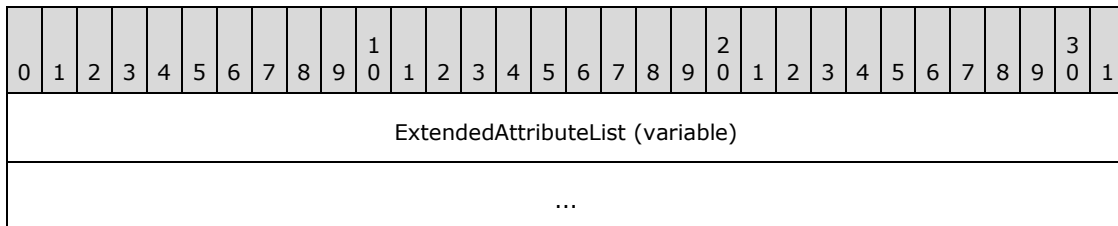

ExtendedAttributeList (variable): A list of extended attribute (EA) name/value pairs that are to be assigned to the file.

2.2.6.1.2 Response

Trans2_Parameters

```

Trans2_Parameters
{
    USHORT          FID;
    SMB_FILE_ATTRIBUTES FileAttributes;

    UTIME           CreationTime;
    ULONG           FileDataSize;
    USHORT          AccessMode;
    USHORT          ResourceType;
    SMB_NMPIPE_STATUS NMPipeStatus;
    USHORT          ActionTaken;
    ULONG           Reserved;
    USHORT          ExtendedAttributeErrorOffset;
    ULONG           ExtendedAttributeLength;
}

```

0	1	2	3	4	5	6	7	8	9	10	11	12	13	14	15	16	17	18	19	20	21	22	23	24	25	26	27	28	29	30	31
FID										FileAttributes																					
CreationTime																															
FileDataSize																															
AccessMode																ResourceType															
NMPipeStatus																ActionTaken															
Reserved																															
ExtendedAttributeErrorOffset																ExtendedAttributeLength															
...																															

FID (2 bytes): This field contains the [FID](#) of the opened file.

FileAttributes (2 bytes): The file attributes assigned to the file after the open or create has occurred.

CreationTime (4 bytes): A 32-bit integer time value to be assigned to the file as the time of creation if the file is to be created.

FileDataSize (4 bytes): The current size of the file in bytes.

AccessMode (2 bytes): A 16-bit field for encoding the granted access mode. This field is formatted in the same way as the equivalent field in the request.

ResourceType (2 bytes): The file type. This field MUST be interpreted as follows:

Name and value	Meaning
FileTypeDisk 0x0000	File or directory
FileTypeByteModePipe 0x0001	Byte mode named pipe
FileTypeMessageModePipe 0x0002	Message mode named pipe
FileTypePrinter 0x0003	Printer device
FileTypeUnknown 0xFFFF	Unknown file type

NMPipeStatus (2 bytes): A 16-bit field that contains the status of the named pipe if the resource type opened is a named pipe instance. This field is formatted as an [SMB NMPIPE STATUS \(section 2.2.1.3\)](#).

ActionTaken (2 bytes): A 16-bit field that shows the results of the open operation.

Name and bitmask	Values	Meaning
OpenResult 0x0003	0	Reserved.
	1	The file existed and was opened.
	2	The file did not exist and was therefore created.
	3	The file existed and was truncated.
LockStatus 0x8000	0	No OpLock was requested, the OpLock could not be granted, or the server does not support OpLocks.
	1	An OpLock was requested by the client and was granted by the server.

All other bits are reserved, SHOULD NOT be used by the client and MUST be ignored by the server.

Reserved (4 bytes): This field SHOULD be set to zero (0x00000000) and MUST be ignored by the server.

ExtendedAttributeErrorOffset (2 bytes): If an error was detected while applying the entries in the **ExtendedAttributeList**, this field contains the offset in bytes to the specific **ExtendedAttributeList.FEAList** entry in the request that caused the error.

ExtendedAttributeLength (4 bytes): The total size of the extended attributes for the opened file.

Trans2_Data

No data is sent by this message.

Error Codes

SMB error class	SMB error code	NT status code	POSIX equivalent	Description
ERRDOS (0x01)	ERRbadpath (0x0003)	STATUS_NO_SUCH_FILE (0xC000000F)	ENOENT	The file path syntax is invalid.
ERRDOS (0x01)	ERRnoaccess (0x0005)	STATUS_ACCESS_DENIED (0xC0000022)	EPERM	Access denied.
ERRDOS (0x01)	ERRbadaccess (0x000C)	STATUS_ACCESS_DENIED (0xC0000022)		Invalid open mode.
ERRDOS (0x01)	ERRbadshare (0x0020)	STATUS_SHARING_VIOLATION (0xC0000043)	ETXTBSY	Sharing violation.
ERRDOS (0x01)	ERRgeneral (0x001F)	STATUS_UNSUCCESSFUL (0xC0000001)		The size of the extended attribute list is not correct. Check the EaErrorOffset field for the address of the EA at which the error was detected.
ERRDOS (0x01)	ERRfileexists (0x0050)	STATUS_OBJECT_NAME_COLLISION (0xC0000035)	EEXIST	The file already exists.
ERRDOS (0x01)	ERRinvalidparam (0x0057)	STATUS_INVALID_PARAMETER (0xC000000D)		One of the extended attributes had an invalid Flag bit value.
ERRDOS (0x01)	ERRunknownlevel (0x007C)	STATUS_OS2_INVALID_LEVEL (0x007C0001)		The InformationLevel supplied is invalid.
ERRDOS (0x01)	ERRbadealist (0x00FF)	STATUS_OS2_EA_LIST_INCONSISTENT (0x00FF0001) STATUS_EA_LIST_INCONSISTENT (0x80000014)		Inconsistent extended attribute list.
ERRSRV (0x02)	ERRerror (0x0001)	STATUS_INVALID_SMB (0x00010002)		Invalid SMB. Not enough parameter bytes were sent.
ERRSRV (0x02)	ERRinvtid (0x0005)	STATUS_SMB_BAD_TID (0x00050002)		The TID is no longer valid.
ERRSRV (0x02)	ERRnomem (0x0008)	STATUS_INSUFF_SERVER_RESOURCES (0xC0000205)	ENOMEM	The server is out of resources.

SMB error class	SMB error code	NT status code	POSIX equivalent	Description
ERRSRV (0x02)	ERRbaduid (0x005B)	STATUS_SMB_BAD_UID (0x005B0002)		The UID supplied is not defined to the session.

2.2.6.2 TRANS2_FIND_FIRST2 (0x0001)

TRANS2_FIND_FIRST2 (0x0001)

This Transaction2 subcommand was introduced in the NT LAN Manager dialect, replacing the obsolete TRANS2_FIND_FIRST subcommand introduced in the **LAN Manager 1.2** dialect.

This transaction is used to begin a search for file(s) within a directory or for a directory. The search can be continued if necessary with the TRANS2_FIND_NEXT2 command. There are several levels of information that can be queried for the returned files or directories. The information level is specified in the **InformationLevel** field of the Trans2_Parameters (see following), and each information level has a unique response format.

2.2.6.2.1 Request

The TRANS2_FIND_FIRST2 request and response formats are special cases of the [SMB_COM_TRANSACTION2 \(section 2.2.4.46\)](#) SMB. Only the TRANS2_FIND_FIRST2 specifics are described here.

SMB_Parameters

WordCount (1 byte): This field MUST be 0x0F.

Words (30 bytes):

TotalDataCount (2 bytes): If no **Trans2_Data** is supplied, this field MUST be 0x0000. If **Trans2_Parameters.InformationLevel** is SMB_INFO_QUERY_EAS_FROM_LIST (see following), this field MUST be the total size of the extended attribute list.

SetupCount (1 byte): This field MUST be 0x01.

Setup (2 bytes): This field MUST be TRANS2_FIND_FIRST2 (0x0001).

Trans2_Parameters

```
Trans2_Parameters
{
    SMB_FILE_ATTRIBUTES SearchAttributes;
    USHORT              SearchCount;
    USHORT              Flags;
    USHORT              InformationLevel;
    ULONG               SearchStorageType;
    SMB_STRING          FileName;
}
```

0	1	2	3	4	5	6	7	8	9	10	11	12	13	14	15	16	17	18	19	20	21	22	23	24	25	26	27	28	29	30	31
SearchAttributes																SearchCount															
Flags																InformationLevel															
SearchStorageType																															
FileName (variable)																															
...																															

SearchAttributes (2 bytes): File attributes to apply as a constraint to the file search. Exclusive search attributes (see section [2.2.1.2.4](#)) can also be set.

SearchCount (2 bytes): The server MUST NOT return more entries than indicated by the value of this field.

Flags (2 bytes): This bit field contains flags used to request that the server manage the state of the transaction based on how the client attempts to traverse the results.

Name and bitmask	Description
SMB_FIND_CLOSE_AFTER_REQUEST 0x0001	Close the search after this request.
SMB_FIND_CLOSE_AT_EOS 0x0002	Close search when end of search is reached.
SMB_FIND_RETURN_RESUME_KEYS 0x0004	Return resume keys for each entry found.
SMB_FIND_CONTINUE_FROM_LAST 0x0008	Continue search from previous ending place.
SMB_FIND_WITH_BACKUP_INTENT 0x0010	Find with backup intent.

InformationLevel (2 bytes): This field contains an information level code, which determines the information contained in the response. The list of valid information level codes is specified in section [2.2.2.3.1](#). A client that has not negotiated long names support MUST request only SMB_INFO_STANDARD. If a client that has not negotiated long names support requests an **InformationLevel** other than SMB_INFO_STANDARD, the server MUST return a status of STATUS_INVALID_PARAMETER (ERRDOS/ERRinvalidparam).

SearchStorageType (4 bytes): The client MUST set this field to zero and the server MUST ignore it on receipt.

FileName (variable): The file pattern to search for. This field MAY contain wildcard characters.

Trans2_Data

The following **Trans2_Data** structure MUST be included if the **Trans2_Parameters.InformationLevel** field is set to **SMB_INFO_QUERY_EAS_FROM_LIST**; otherwise, it MUST NOT be included.

```
Trans2_Data
{
    SMB_GEA_LIST GetExtendedAttributeList;
}
```

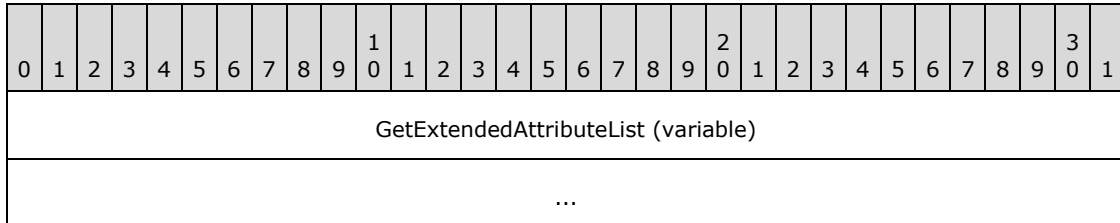

GetExtendedAttributeList (variable): A list of extended attribute (EA) names. The value of the **AttributeName** fields MUST be used by the server to query the set of extended attributes that match the set of **AttributeName** values provided in this list.

2.2.6.2.2 Response

Trans2_Parameters

```
Trans2_Parameters
{
    USHORT SID;
    USHORT SearchCount;
    USHORT EndOfSearch;
    USHORT EaErrorOffset;
    USHORT LastNameOffset;
}
```

SID (2 bytes): The server-generated search identifier for this transaction. It MUST be provided in **TRANS2_FIND_NEXT2** transactions.

SearchCount (2 bytes): The number of entries returned by the search.

EndOfSearch (2 bytes): This field MUST be zero (0x0000) if the search can be continued using the **TRANS2_FIND_NEXT2** transaction. This field MUST be nonzero if this response is the last and the find has reached the end of the search results.

EaErrorOffset (2 bytes): If **Request.Trans2_Parameters.InformationLevel** is not **SMB_INFO_QUERY_EAS_FROM_LIST**, this field MUST be zero (0x0000). If **InformationLevel** is **SMB_INFO_QUERY_EAS_FROM_LIST**, this field marks the offset to an extended attribute name, the retrieval of which caused an error. This field MUST contain the offset in bytes to the **SMB_GEA** entry in the **Trans2_Data.GetExtendedAttributesList** that identifies the extended attribute that caused the error, or zero (0x0000) if no error was encountered.

LastNameOffset (2 bytes): If the server cannot resume the search, this field MUST be zero (0x0000). If the server can resume the search, this field contains the offset in bytes into the **Trans2_Data** structure at which the file name of the last entry returned by the server is located. This value can be used in the **Trans2_Parameters** structure of the request to continue a search. See [TRANS2_FIND_NEXT2 \(section 2.2.6.3\)](#) for more information.

Trans2_Data

The **Trans2_Data** block carries the structure of the **information level** specified by the request's **Trans2_Parameters.InformationLevel** field. Each **information level's** corresponding structure is specified in section [2.2.8.1](#).

Error Codes

SMB error class	SMB error code	NT status code	POSIX equivalent	Description
ERRDOS (0x01)	ERRbadfile (0x0002)	STATUS_NO_SUCH_FILE (0xC000000F)	ENOENT	The named file was not found.
ERRDOS (0x01)	ERRbadpath (0x0003)	STATUS_OBJECT_PATH_SYNTAX_BAD (0xC000003B)	ENOTDIR	The file path syntax is invalid.
ERRDOS (0x01)	ERRnoaccess (0x0005)	STATUS_ACCESS_DENIED (0xC0000022)	EPERM	Access denied.
ERRDOS (0x01)	ERRbadaccess (0x000C)	STATUS_ACCESS_DENIED (0xC0000022)		Invalid open mode.
ERRDOS (0x01)	ERRbadshare (0x0020)	STATUS_SHARING_VIOLATION (0xC0000043)	ETXTBSY	Sharing violation.
ERRDOS (0x01)	ERRgeneral (0x001F)	STATUS_UNSUCCESSFUL (0xC0000001)		The size of the extended attribute list is not correct. Check the EaErrorOffset field for address of the SMB_GEA structure at which the error was detected.
ERRDOS (0x01)	ERRinvalidparam (0x0057)	STATUS_INVALID_PARAMETER (0xC000000D)		One of the extended attributes had an invalid Flag bit value.
ERRDOS (0x01)	ERRunknownlevel (0x007C)	STATUS_OS2_INVALID_LEVEL (0x007C0001)		The InformationLevel supplied is invalid.
ERRDOS	ERRbadealist	STATUS_OS2_EA_LIST_INCONSISTENT		Inconsistent extended

SMB error class	SMB error code	NT status code	POSIX equivalent	Description
(0x01)	(0x00FF)	(0x00FF0001) STATUS_EA_LIST_INCONSISTENT (0x80000014)		attribute list.
ERRSRV (0x02)	ERRerror (0x0001)	STATUS_INVALID_SMB (0x00010002)		Invalid SMB. Not enough parameter bytes were sent.
ERRSRV (0x02)	ERRinvtid (0x0005)	STATUS_SMB_BAD_TID (0x00050002)		The TID is no longer valid.
ERRSRV (0x02)	ERRnomem (0x0008)	STATUS_INSUFF_SERVER_RESOURCES (0xC0000205)	ENOMEM	The server is out of resources.
ERRSRV (0x02)	ERRbaduid (0x005B)	STATUS_SMB_BAD_UID (0x005B0002)		The UID supplied is not defined to the session.
ERRSRV (0x02)	ERRmoredata (0x00EA)	STATUS_BUFFER_OVERFLOW (0x80000005)		The number of bytes read from the named pipe exceeds the MaxDataCount field in the client request.

2.2.6.3 TRANS2_FIND_NEXT2 (0x0002)

This Transaction2 subcommand was introduced in the NT LAN Manager dialect, replacing the obsolete TRANS2_FIND_NEXT subcommand introduced in the **LAN Manager 1.2** dialect.

This transaction is used to continue a search for file(s) within a directory or for a directory. The search MUST have been initiated using TRANS2_FIND_FIRST2. There are several **information levels** that can be queried for the returned files or directories. The **information level** is specified in the **Trans2_Parameters.InformationLevel** field, and each **information level** has a unique response format. See TRANS2_FIND_FIRST2 for the specification of each **information level's** response data. If the client attempts to terminate a search prior to reaching the end of the search results, as indicated by the server's response, the client MUST use the SMB_COM_FIND_CLOSE2 command and MUST provide the **SID** from the search.

2.2.6.3.1 Request

The TRANS2_FIND_NEXT2 request and response formats are special cases of [SMB_COM_TRANSACTION2 \(section 2.2.4.46\)](#) SMB. Only the TRANS2_FIND_NEXT2 specifics are described here.

SMB_Parameters

WordCount (1 byte): This field MUST be 0x0F.

Words (30 bytes):

TotalDataCount (2 bytes): If no **Trans2_Data** is supplied, this field MUST be 0x0000. If **Trans2_Parameters.InformationLevel** is SMB_INFO_QUERY_EAS_FROM_LIST (see TRANS2_FIND_FIRST2), this field MUST be the total size of the extended attribute list.

SetupCount (1 byte): This field MUST be 0x01.

Setup (2 bytes): This field MUST be TRANS2_FIND_NEXT2 (0x0002).

0	1	2	3	4	5	6	7	8	9	10	11	12	13	14	15	16	17	18	19	20	21	22	23	24	25	26	27	28	29	30	31
Trans2_Parameters (variable)																															
...																															
Trans2_Data (variable)																															
...																															

Trans2_Parameters (variable):

```

Trans2_Parameters
{
    USHORT    SID;
    USHORT    SearchCount;
    USHORT    InformationLevel;
    ULONG     ResumeKey;
    USHORT    Flags;
    SMB_STRING FileName;
}

```

0	1	2	3	4	5	6	7	8	9	10	11	12	13	14	15	16	17	18	19	20	21	22	23	24	25	26	27	28	29	30	31
SID											SearchCount																				
InformationLevel											ResumeKey																				
...											Flags																				
FileName (variable)																															
...																															

SID (2 bytes): This field MUST be the search identifier (SID) returned in TRANS2_FIND_FIRST2 response.

SearchCount (2 bytes): This field MUST be the maximum number of entries to return in the response.

InformationLevel (2 bytes): This field contains an information level code, which determines the information contained in the response. The list of valid information level codes is specified in section [2.2.2.3.1](#). A client that has not negotiated long names support MUST request only SMB_INFO_STANDARD. If a client that has not negotiated long names support requests an InformationLevel other than SMB_INFO_STANDARD, the server MUST return a status of STATUS_INVALID_PARAMETER (ERRDOS/ERRinvalidparam).

ResumeKey (4 bytes): This field MUST be the value of a **ResumeKey** field returned in the response from a TRANS2_FIND_FIRST2 or TRANS2_FIND_NEXT2 that is part of the same search (same **SID**).

Flags (2 bytes): This bit mask field is used to request that the server manage the state of the transaction based on how the client attempts to traverse the results.

Name and bitmask	Description
SMB_FIND_CLOSE_AFTER_REQUEST 0x0001	Close the search after this request.
SMB_FIND_CLOSE_AT_EOS 0x0002	Close search when end of search is reached.
SMB_FIND_RETURN_RESUME_KEYS 0x0004	Return resume keys for each entry found.
SMB_FIND_CONTINUE_FROM_LAST 0x0008	Continue search from previous ending place.
SMB_FIND_WITH_BACKUP_INTENT 0x0010	Find with backup intent.

FileName (variable): A filename pattern. The server re-runs the search based on the search criteria defined by the **FileName** field in the [TRANS2_FIND_FIRST2 Request](#) (section [2.2.6.2.1](#)), and the file names are returned starting after the first file that matches the filename pattern. This field can contain wildcard characters. <145>

Trans2_Data (variable): The **Trans2_Data** MUST be included if the **Trans2_Parameters.InformationLevel** field is set to SMB_INFO_QUERY_EAS_FROM_LIST; else, it MUST NOT be included.

```
Trans2_Data
{
    SMB_GEA_LIST GetExtendedAttributeList;
}
```

0	1	2	3	4	5	6	7	8	9	10	11	12	13	14	15	16	17	18	19	20	21	22	23	24	25	26	27	28	29	30	31
GetExtendedAttributeList (variable)																															
...																															

GetExtendedAttributeList (variable): A list of extended attribute (EA) names. The value of the **AttributeName** field MUST be used by the server to further constrain the find query to files having the set of extended attributes that match the set of **AttributeName** values provided in this list.

2.2.6.3.2 Response

Trans2_Parameters

```
Trans2_Parameters
{
    USHORT SearchCount;
    USHORT EndOfSearch;
    USHORT EaErrorOffset;
    USHORT LastNameOffset;
}
```

Trans2_Parameters:

0	1	2	3	4	5	6	7	8	9	10	11	12	13	14	15	16	17	18	19	20	21	22	23	24	25	26	27	28	29	30	31
SearchCount																EndOfSearch															
EaErrorOffset																LastNameOffset															

SearchCount (2 bytes): The number of entries returned by the search.

EndOfSearch (2 bytes): This field MUST be zero (0x0000) if the search can be continued using the [TRANS2_FIND_NEXT2 \(section 2.2.6.3\)](#) transaction. This field MUST be nonzero if this response is the last and the find has reached the end of the search results.

EaErrorOffset (2 bytes): If the **Request.Trans2_Parameters.InformationLevel** field is not **SMB_INFO_QUERY_EAS_FROM_LIST**, this field MUST be zero (0x0000). If the **InformationLevel** field is **SMB_INFO_QUERY_EAS_FROM_LIST**, this field marks the offset to an extended attribute name, the retrieval of which caused an error. This field MUST contain the offset in bytes to the [SMB_GEA \(section 2.2.1.2.1\)](#) entry in the **Trans2_Data.GetExtendedAttributesList** field that identifies the extended attribute that caused the error, or zero (0x0000) if no error was encountered.

LastNameOffset (2 bytes): If the server cannot resume the search, this field MUST be zero (0x0000). If the server can resume the search, this field contains the offset in bytes into the **Trans2_Data** structure at which the file name of the last entry returned by the server is located. This value can be used in the **Trans2_Parameters** structure of the request to continue a search.

The **Trans2_Data** block carries the structure of the Information Level specified by the request's **Trans2_Parameters.InformationLevel** field. Each Information Level's corresponding structure is specified in section [2.2.8.1](#).

Error Codes

SMB error class	SMB error code	NT status code	POSIX equivalent	Description
ERRDOS (0x01)	ERRbadpath (0x0003)	STATUS_OBJECT_PATH_SYNTAX_BAD (0xC000003B)	ENOTDIR	The file path syntax is invalid.
ERRDOS (0x01)	ERRnoaccess (0x0005)	STATUS_ACCESS_DENIED (0xC0000022)	EPERM	Access denied.
ERRDOS (0x01)	ERRbadfid (0x0006)	STATUS_INVALID_HANDLE (0xC0000008)	EPERM	Represents that an invalid SID was supplied.
ERRDOS (0x01)	ERRbadaccess (0x000C)	STATUS_ACCESS_DENIED (0xC0000022)		Invalid open mode.
ERRDOS (0x01)	ERRbadshare (0x0020)	STATUS_SHARING_VIOLATION (0xC0000043)	ETXTBSY	Sharing violation.
ERRDOS (0x01)	ERRgeneral (0x001F)	STATUS_UNSUCCESSFUL (0xC0000001)		The size of the extended attribute list is not correct. Check the EaErrorOffset field for the address of the SMB_GEA structure at which the error was detected.
ERRDOS (0x01)	ERRinvalidparam (0x0057)	STATUS_INVALID_PARAMETER (0xC000000D)		One of the extended attributes had an invalid Flags bit value.
ERRDOS (0x01)	ERRunknownlevel (0x007C)	STATUS_OS2_INVALID_LEVEL (0x007C0001)		The InformationLevel supplied is invalid.
ERRDOS (0x01)	ERRbadealist (0x00FF)	STATUS_OS2_EA_LIST_INCONSISTENT (0x00FF0001) STATUS_EA_LIST_INCONSISTENT (0x80000014)		Inconsistent extended attribute list.
ERRSRV (0x02)	ERRerror (0x0001)	STATUS_INVALID_SMB (0x00010002)		Invalid SMB. Not enough parameter bytes were sent.
ERRSRV (0x02)	ERRinvtid (0x0005)	STATUS_SMB_BAD_TID (0x00050002)		The TID is no longer valid.
ERRSRV (0x02)	ERRnomem (0x0008)	STATUS_INSUFF_SERVER_RESOURCES (0xC0000205)	ENOMEM	The server is out of resources.

SMB error class	SMB error code	NT status code	POSIX equivalent	Description
ERRSRV (0x02)	ERRbaduid (0x0058)	STATUS_SMB_BAD_UID (0x005B0002)		The UID supplied is not known to the session.

2.2.6.4 TRANS2_QUERY_FS_INFORMATION (0x0003)

This Transaction2 subcommand was introduced in the **LAN Manager 2.0** dialect.

This transaction is used to request information about the object store underlying a share on the server. The share being queried is identified by the **TID** supplied in the [SMB Header \(section 2.2.3.1\)](#) of the request. There are several levels of information that can be queried for the returned files or directories. The information level is specified in the **InformationLevel** field of the **Trans2_Parameters** data block, and each information level has a unique response format.

2.2.6.4.1 Request

The TRANS2_QUERY_FS_INFORMATION request and response formats are special cases of [SMB_COM_TRANSACTION2 \(section 2.2.4.46\)](#) SMB. Only the TRANS2_QUERY_FS_INFORMATION specifics are described here.

SMB_Parameters:

WordCount (1 byte): This field MUST be 0x0F.

Words (30 bytes):

TotalDataCount (2 bytes): This field MUST be zero (0x0000).

SetupCount (1 byte): This field MUST be 0x01.

Setup(2 bytes): This field MUST be TRANS2_QUERY_FS_INFORMATION (0x0003).

Trans2_Parameters:

```
Trans2_Parameters
{
    USHORT InformationLevel;
}
```

InformationLevel (2 bytes): This field contains an information level code, which determines the information contained in the response. The list of valid information level codes is specified in section [2.2.2.3.2](#)

Trans2_Data: No data is sent by this message.

2.2.6.4.2 Response

Trans2_Parameters

No parameters are sent by this message

Trans2_Data

The **Trans2_Data** block carries the structure of the **information level** specified by the request's **Trans2_Parameters.InformationLevel** field. Each information level's corresponding structure is specified in section [2.2.8.2](#).

Error Codes

SMB error class	SMB error code	NT status code	POSIX equivalent	Description
ERRDOS (0x01)	ERRnomem (0x0008)	STATUS_INSUFF_SERVER_RESOURCES (0xC0000205)	ENOMEM	The server is out of resources.
ERRSRV (0x02)	ERRunknownlevel (0x007C)	STATUS_OS2_INVALID_LEVEL (0x007C0001)		The InformationLevel supplied is invalid.
ERRSRV (0x02)	ERRerror (0x0001)	STATUS_INVALID_SMB (0x00010002)		Invalid SMB. Not enough parameter bytes were sent.
ERRSRV (0x02)	ERRinvtid (0x0005)	STATUS_SMB_BAD_TID (0x00050002)		The TID is no longer valid.
ERRSRV (0x02)	ERRbaduid (0x005B)	STATUS_SMB_BAD_UID (0x005B0002)		The UID supplied is not defined to the session.
ERRSRV (0x02)	ERRmoredata (0x00EA)	STATUS_BUFFER_OVERFLOW (0x80000005)		The number of bytes read from the named pipe exceeds the MaxDataCount field in the client request.
ERRHRD (0x03)	ERRnotready (0x0015)	STATUS_NO_MEDIA_IN_DEVICE (0x0xC0000013)		Share represents a removable device and there is no media present in the device.
ERRHRD (0x03)	ERRdata (0x0017)	STATUS_DATA_ERROR (0xC000003E)	EIO	Disk I/O error.

2.2.6.5 TRANS2_SET_FS_INFORMATION (0x0004)

This Transaction2 subcommand was introduced in the **LAN Manager 2.0** dialect. This subcommand is **reserved but not implemented**.

Clients SHOULD NOT send requests using this command code. Servers receiving requests with this command code MUST return STATUS_SMB_NO_SUPPORT (ERRSRV/ERRnosupport).

2.2.6.6 TRANS2_QUERY_PATH_INFORMATION (0x0005)

This Transaction2 subcommand was introduced in the **LAN Manager 2.0** dialect.

This transaction is used to get information about a specific file or directory. There are several **information levels** that can be queried. The **information level** is specified in the **Request.Trans2_Parameters.InformationLevel** field (see following) and each **information level** has a unique response format. See the individual response formats for the specification of the data returned by each **information level**.

2.2.6.6.1 Request

The TRANS2_QUERY_PATH_INFORMATION request and response formats are special cases of [SMB_COM_TRANSACTION2 \(section 2.2.4.46\)](#) SMB. Only the TRANS2_QUERY_PATH_INFORMATION specifics are described here.

SMB_Parameters:

WordCount (1 byte): This field MUST be 0x0F.

Words (30 bytes):

TotalDataCount (2 bytes): If no **Trans2_Data** is supplied, this field MUST be 0x0000. If **Trans2_Parameters.InformationLevel** is SMB_INFO_QUERY_EAS_FROM_LIST (see following), this field MUST be the total size of the extended attribute list.

SetupCount (1 byte): This field MUST be 0x01.

Setup[0] (2 bytes): This field MUST be TRANS2_QUERY_PATH_INFORMATION (0x0005).

Trans2_Parameters:

```
Trans2_Parameters
{
    USHORT      InformationLevel;
    ULONG       Reserved;
    SMB_STRING  FileName;
}
```

InformationLevel (2 bytes): This field contains an information level code, which determines the information contained in the response. The list of valid information level codes is specified in section [2.2.2.3.3](#). A client that has not negotiated long names support MUST request only SMB_INFO_STANDARD. If a client that has not negotiated long names support requests an **InformationLevel** other than SMB_INFO_STANDARD, the server MUST return a status of STATUS_INVALID_PARAMETER of (ERRDOS/ERRinvalidparam).

Reserved (4 bytes): This field is reserved and MUST be zero (0x0000).

FileName (variable): The file name or directory name for which to retrieve the information.

Trans2_Data: The **Trans2_Data** field MUST be included if the **Trans2_Parameters.InformationLevel** field is set to SMB_INFO_QUERY_EAS_FROM_LIST; else, it MUST NOT be included.

```

Trans2_Data
{
    SMB_GEA_LIST GetExtendedAttributeList;
}

```

GetExtendedAttributeList (variable): A list of extended attribute (EA) names. The server MUST return only those extended attributes that have an **AttributeName** matching one of the **AttributeName** values in the list.

2.2.6.6.2 Response

For the information levels greater than 0x100, the transaction response has 1 parameter word that SHOULD be ignored by the client.

Trans2_Parameters:

```

Trans2_Parameters
{
    USHORT EaErrorOffset;
}

```

EaErrorOffset (2 bytes): If **Request.Trans2_Parameters.InformationLevel** is not **SMB_INFO_QUERY_EAS_FROM_LIST**, this field MUST be zero (0x0000). If **InformationLevel** is **SMB_INFO_QUERY_EAS_FROM_LIST**, this field marks the offset to an extended attribute, the retrieval of which caused an error. This field MUST contain the offset in bytes to the **SMB_GEA** entry in **Trans2_Data.GetExtendedAttributesList** that caused the error or zero (0x0000) if no error was encountered.

Trans2_Data:

The **Trans2_Data** block carries the structure of the information level specified by the request's **Trans2_Parameters.InformationLevel** field. Each **information level's** corresponding structure is specified in section [2.2.8.3](#).

Error Codes:

SMB error class	SMB error code	NT status code	POSIX equivalent	Description
ERRDOS (0x01)	ERRbadfile (0x0002)	STATUS_NO_SUCH_FILE (0xC000000F)	ENOENT	The named file was not found.
ERRDOS (0x01)	ERRbadpath (0x0003)	STATUS_OBJECT_PATH_SYNTAX_BAD (0xC000003B)	ENOTDIR	The file path syntax is invalid.
ERRDOS (0x01)	ERRnoaccess (0x0005)	STATUS_ACCESS_DENIED (0xC0000022)	EPERM	Access denied.
ERRDOS	ERRnomem	STATUS_INSUFF_SERVER_RESOURCES	ENOMEM	The server is out

SMB error class	SMB error code	NT status code	POSIX equivalent	Description
S (0x01)	(0x0008)	ES (0xC0000205)		of resources.
ERRDOS (0x01)	ERRbadlength (0x0018)	STATUS_INFO_LENGTH_MISMATCH (0xC0000004)		The client's MaxDataCount is too small to accommodate the results.
ERRDOS (0x01)	ERRgeneral (0x001F)	STATUS_UNSUCCESSFUL (0xC0000001)		The size of the extended attribute list is not correct. Check the EaErrorOffset field for the address of SMB_GEA structure at which the error was detected.
ERRDOS (0x01)	ERRunknownlevel (0x007C)	STATUS_OS2_INVALID_LEVEL (0x007C0001)		The InformationLevel supplied is invalid.
ERRDOS (0x01)	ERRbadealist (0x00FF)	STATUS_OS2_EA_LIST_INCONSISTENT (0x00FF0001) STATUS_EA_LIST_INCONSISTENT (0x80000014)		Inconsistent extended attribute list.
ERRSRV (0x02)	ERRerror (0x0001)	STATUS_INVALID_SMB (0x00010002)		Invalid SMB. Not enough parameter bytes were sent.
ERRSRV (0x02)	ERRinvtid (0x0005)	STATUS_SMB_BAD_TID (0x00050002)		The TID is no longer valid.
ERRSRV (0x02)	ERRbaduid (0x005B)	STATUS_SMB_BAD_UID (0x005B0002)		The UID supplied is not defined to the session.
ERRHRD (0x03)	ERRnotready (0x0015)	STATUS_NO_MEDIA_IN_DEVICE (0x0xC0000013)		Share represents a removable device and there is no media present in the device.
ERRHR	ERRdata	STATUS_DATA_ERROR	EIO	Disk I/O error.

SMB error class	SMB error code	NT status code	POSIX equivalent	Description
D (0x03)	(0x0017)	(0xC000003E)		

2.2.6.7 TRANS2_SET_PATH_INFORMATION (0x0006)

This Transaction2 subcommand was introduced in the **LAN Manager 2.0** dialect.

This transaction is used to set the standard and extended attribute information of a specific file or directory on the server. The file or directory is specified by a path relative to the **TID** supplied in the [SMB Header \(section 2.2.3.1\)](#). The file or directory does not need to be opened by the client before sending the transaction request. The set of standard and extended attribute information included in the request is determined by the **InformationLevel** field (see following). The setting of attribute information for the root directory of the share, as identified by the **TID**, MUST NOT be supported.

2.2.6.7.1 Request

The TRANS2_SET_PATH_INFORMATION request and response formats are special cases of [SMB_COM_TRANSACTION2 \(section 2.2.4.46\)](#) SMB. Only the TRANS2_SET_PATH_INFORMATION specifics are described here.

SMB_Parameters:

WordCount (1 byte): This field MUST be 0x0F.

Words (30 bytes):

TotalDataCount (2 bytes): This field MUST be zero (0x0000).

SetupCount (1 byte): This field MUST be 0x01.

Setup (2 bytes): This field MUST be TRANS2_SET_PATH_INFORMATION (0x0006).

Trans2_Parameters:

```
Trans2_Parameters
{
    USHORT      InformationLevel;
    ULONG       Reserved;
    SMB_STRING  FileName;
}
```

InformationLevel (2 bytes): This field contains an information level code, which determines the information contained in the **Trans2_Data** block. The list of valid information level codes is specified in section [2.2.2.3.4](#). A client that has not negotiated long names support MUST use only SMB_INFO_STANDARD. If a client that has not negotiated long names support uses an **InformationLevel** other than SMB_INFO_STANDARD, the server MUST return a status of STATUS_INVALID_PARAMETER (ERRDOS/ERRinvalidparam).

Reserved (4 bytes): This field is reserved and MUST be zero (0x00000000).

FileName (variable): The file name or directory name for which to retrieve the information.

Trans2_Data: The **Trans2_Data** block carries the structure of the **information level** specified by the **Trans2_Parameters.InformationLevel** field. Each information level's corresponding structure is specified in section [2.2.8.4](#).

2.2.6.7.2 Response

The response information indicates if there was a problem with the list of extended attributes supplied when the **InformationLevel** field is **SMB_INFO_SET_EAS**. The outcome of the request is included in the [SMB Header \(section 2.2.3.1\)](#).

Trans2_Parameters

```
Trans2_Parameters
{
    USHORT EaErrorOffset;
}
```

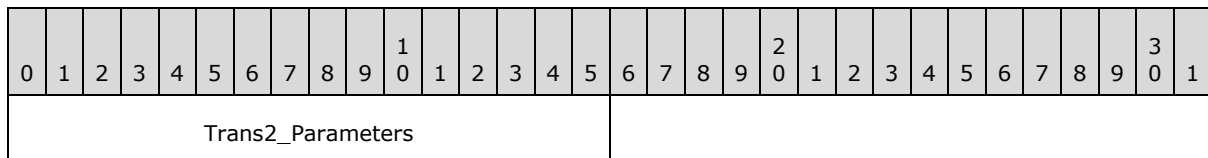

Trans2_Parameters (2 bytes):

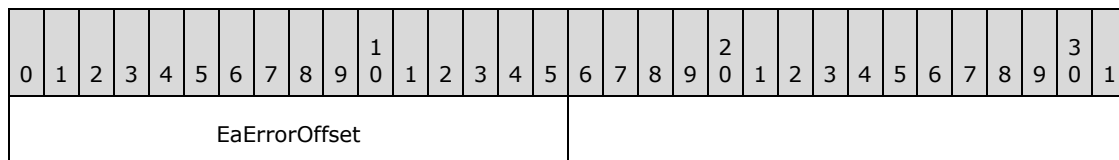

EaErrorOffset (2 bytes): This field contains the offset in bytes into the **ExtendedAttributeList** that identifies the attribute that caused an error. This field is meaningful only when the request's **Trans2_Parameters.InformationLevel** is set to **SMB_INFO_SET_EAS**.

Trans2_Data:

No data is sent by this message.

Error Codes

SMB error class	SMB error code	NT status code	POSIX equivalent	Description
ERRDOS (0x01)	ERRnoaccess (0x0005)	STATUS_ACCESS_DENIED (0xC0000022)	EPERM	Access denied.
ERRDOS (0x01)	ERRnomem (0x0008)	STATUS_INSUFF_SERVER_RESOURCES (0xC0000205)	ENOMEM	The server is out of resources.

SMB error class	SMB error code	NT status code	POSIX equivalent	Description
ERRDOS (0x01)	ERRbadlength (0x0018)	STATUS_INFO_LENGTH_MISMATCH (0xC0000004)		The client's MaxDataCount is too small to accommodate the results.
ERRDOS (0x01)	ERRgeneral (0x001F)	STATUS_UNSUCCESSFUL (0xC0000001)		The size of the extended attribute list is not correct. Check the EaErrorOffset field for the address of the SMB_FEA structure at which the error was detected.
ERRDOS (0x01)	ERRunknownlevel (0x007C)	STATUS_OS2_INVALID_LEVEL (0x007C0001)		The InformationLevel supplied is invalid.
ERRDOS (0x01)	ERRbadealist (0x00FF)	STATUS_OS2_EA_LIST_INCONSISTENT (0x00FF0001) STATUS_EA_LIST_INCONSISTENT (0x80000014)		Inconsistent extended attribute list.
ERRSRV (0x02)	ERRerror (0x0001)	STATUS_INVALID_SMB (0x00010002)		Invalid SMB. Not enough parameter bytes were sent.
ERRSRV (0x02)	ERRinvtid (0x0005)	STATUS_INVALID_HANDLE (0xC0000008) STATUS_SMB_BAD_TID (0x00050002)		The TID is no longer valid.
ERRSRV (0x02)	ERRbaduid (0x005B)	STATUS_INVALID_HANDLE (0xC0000008) STATUS_SMB_BAD_UID (0x005B0002)		The UID supplied is not defined to the session.
ERRHRD (0x03)	ERRdata (0x0017)	STATUS_DATA_ERROR (0xC000003E)	EIO	Disk I/O error.

2.2.6.8 TRANS2_QUERY_FILE_INFORMATION (0x0007)

This Transaction2 subcommand was introduced in the **LAN Manager 2.0** dialect.

This transaction is an alternative to **TRANS2_QUERY_PATH_INFORMATION**. The **Trans2_Parameters** of this request contain a **FID** while the **Trans2_Parameters** of the **TRANS2_QUERY_PATH_INFORMATION** request contain a path string.

2.2.6.8.1 Request

The TRANS2_QUERY_FILE_INFORMATION request and response formats are special cases of [SMB_COM_TRANSACTION2 \(section 2.2.4.46\)](#) SMB. Only the TRANS2_QUERY_FILE_INFORMATION Request specifics are described here.

SMB_Parameters:

WordCount (1 byte): This field MUST be 0x0F.

Words (30 bytes):

TotalDataCount (2 bytes): This field MUST be zero (0x0000) if no Trans2_Data is supplied. This field MUST be the total size of the extended attribute list if

InformationLevel is SMB_INFO_QUERY_EAS_FROM_LIST (see TRANS2_QUERY_PATH_INFORMATION).

SetupCount (1 byte): This field MUST be 0x01.

Setup (2 bytes): This field MUST be TRANS2_QUERY_FILE_INFORMATION (0x0007).

Trans2_Parameters:

```
Trans2_Parameters
{
    USHORT FID;
    USHORT InformationLevel;
}
```

0	1	2	3	4	5	6	7	8	9	10	11	12	13	14	15	16	17	18	19	20	21	22	23	24	25	26	27	28	29	30	31
FID																InformationLevel															

FID (2 bytes): This field MUST contain a valid FID returned from a previously successful SMB open command.

InformationLevel (2 bytes): This field contains an information level code, which determines the information contained in the response. The list of valid information level codes is specified in section [2.2.2.3.3](#). A client that has not negotiated long names support MUST request only SMB_INFO_STANDARD. If a client that has not negotiated long names support requests an **InformationLevel** other than SMB_INFO_STANDARD, the server MUST return a status of STATUS_INVALID_PARAMETER (ERRDOS/ERRinvalidparam).

Trans2_Data: The **Trans2_Data** field MUST be included if the **Trans2_Parameters.InformationLevel** field is set to SMB_INFO_QUERY_EAS_FROM_LIST; else, it MUST NOT be included.

```
Trans2_Data
{
    SMB_GEA_LIST GetExtendedAttributeList;
}
```

GetExtendedAttributeList (variable): A list of extended attribute (EA) names. The server MUST return only those extended attributes that have an **AttributeName** matching one of the **AttributeName** values in the list.

2.2.6.8.2 Response

For information levels greater than 0x100, the transaction response has one parameter word that SHOULD be ignored by the client.

Trans2_Parameters::

```
Trans2_Parameters
{
    USHORT EaErrorOffset;
}
```

EaErrorOffset (2 bytes): If **Request.Trans2_Parameters.InformationLevel** is not **SMB_INFO_QUERY_EAS_FROM_LIST**, this field MUST be zero (0x0000). If **InformationLevel** is **SMB_INFO_QUERY_EAS_FROM_LIST**, this field marks the offset to an extended attribute, the retrieval of which caused an error. This field MUST contain the offset, in bytes, to the [SMB_GEA \(section 2.2.1.2.1\)](#) entry in **Trans2_Data.ExtendedAttributesList** that caused the error, or zero (0x0000) if no error was encountered.

Trans2_Data:

The **Trans2_Data** block carries the structure of the information level specified by the request's **Trans2_Parameters.InformationLevel** field. Each information level's corresponding structure is specified in section [2.2.8.3.<146>](#)

Error Codes:

SMB error class	SMB error code	NT status code	POSIX equivalent	Description
ERRDOS (0x01)	ERRnoaccess (0x0005)	STATUS_ACCESS_DENIED (0xC0000022)	EPERM	Access denied.
ERRDOS (0x01)	ERRbadfid (0x0006)	STATUS_INVALID_HANDLE (0xC0000008)	ENOENT	The FID supplied is invalid.
ERRDOS (0x01)	ERRnomem (0x0008)	STATUS_INSUFF_SERVER_RESOURCES (0xC0000205)	ENOMEM	The server is out of resources.
ERRDOS (0x01)	ERRgeneral (0x001F)	STATUS_UNSUCCESSFUL (0xC0000001)		The size of the extended attribute list is not correct. Check the EaErrorOffset field for the address of the

SMB error class	SMB error code	NT status code	POSIX equivalent	Description
				SMB_GEA structure at which the error was detected.
ERRDOS (0x01)	ERRinvalidparam (0x0057)	STATUS_INVALID_PARAMETER (0xC000000D)		One of the extended attributes had an invalid Flag bit value.
ERRDOS (0x01)	ERRunknownlevel (0x007C)	STATUS_OS2_INVALID_LEVEL (0x007C0001)		The InformationLevel supplied is invalid, or the DataCount failed validation for the requested InformationLevel because not enough information was supplied by the client.
ERRDOS (0x01)	ERRbadealist (0x00FF)	STATUS_OS2_EA_LIST_INCONSISTENT (0x00FF0001) STATUS_EA_LIST_INCONSISTENT (0x80000014)		Inconsistent extended attribute list.
ERRSRV (0x02)	ERRerror (0x0001)	STATUS_INVALID_SMB (0x00010002)		Invalid SMB. Not enough parameter bytes were sent.
ERRSRV (0x02)	ERRinvtid (0x0005)	STATUS_INVALID_HANDLE (0xC0000008) STATUS_SMB_BAD_TID (0x00050002)		The TID is no longer valid.
ERRSRV (0x02)	ERRbaduid (0x005B)	STATUS_INVALID_HANDLE (0xC0000008) STATUS_SMB_BAD_UID (0x005B0002)		The UID supplied is not defined to the session.
ERRHRD (0x03)	ERRdata (0x0017)	STATUS_DATA_ERROR (0xC000003E)	EIO	Disk I/O error.

2.2.6.9 TRANS2_SET_FILE_INFORMATION (0x0008)

This Transaction2 subcommand was introduced in the **LAN Manager 2.0** dialect.

This transaction is an alternative to **TRANS2_SET_PATH_INFORMATION**. The **Trans2_Parameters** block of this request contains a **FID**, while the **Trans2_Parameters** block of the **TRANS2_SET_PATH_INFORMATION** request contains a path string.

2.2.6.9.1 Request

The [TRANS2_SET_FILE_INFORMATION \(section 2.2.6.9\)](#) request and response formats are special cases of [SMB_COM_TRANSACTION2 \(section 2.2.4.46\)](#) SMB. Only the **TRANS2_SET_FILE_INFORMATION** specifics are described here.

SMB_Parameters:

WordCount (1 byte): This field MUST be 0x0F.

Words (30 bytes):

TotalDataCount (2 bytes): This field MUST be 0x0000.

SetupCount (1 byte): This field MUST be 0x01.

Setup (2 bytes): This field MUST be **TRANS2_SET_FILE_INFORMATION (0x0008)**.

Trans2_Parameters:

```
Trans2_Parameters
{
    USHORT FID;
    USHORT InformationLevel;
    USHORT Reserved;
}
```

0	1	2	3	4	5	6	7	8	9	0	1	2	3	4	5	6	7	8	9	0	1	2	3	4	5	6	7	8	9	0	1		
FID											InformationLevel																						
Reserved											Trans2_Data (variable)																						
...																																	

FID (2 bytes): This field MUST contain a valid FID returned from a previously successful SMB open command.

InformationLevel (2 bytes): This field determines the information contained in the response. See [TRANS2_SET_PATH_INFORMATION \(section 2.2.6.7\)](#) for complete details.

Reserved (2 bytes): MUST be set to zero when sent and MUST be ignored on receipt.

Trans2_Data (variable): The **Trans2_Data** block carries the structure of the information level specified by the **Trans2_Parameters.InformationLevel** field. Each information level's corresponding structure is specified in section [2.2.8.4](#).

2.2.6.9.2 Response

The response information indicates if there was a problem with the list of extended attributes supplied when the **InformationLevel** field is **SMB_INFO_SET_EAS**. The outcome of the request is included in the [SMB Header \(section 2.2.3.1\)](#).

Trans2_Parameters:

```
Trans2_Parameters
{
    USHORT EaErrorOffset;
}
```

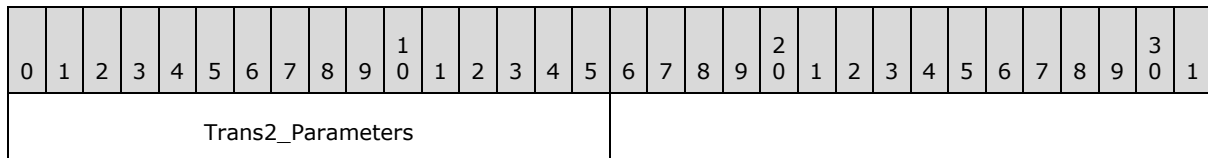

Trans2_Parameters (2 bytes):

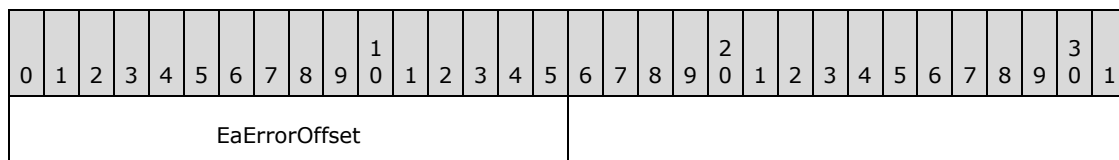

EaErrorOffset (2 bytes): This field contains the offset, in bytes, into the **ExtendedAttributeList** that identifies the attribute that caused an error. This field is meaningful only when the request's **Trans2_Parameters.InformationLevel** is set to **SMB_INFO_SET_EAS**.

Trans2_Data:

No data is sent by this message.

Error Codes

SMB error class	SMB error code	NT status code	POSIX equivalent	Description
ERRDOS (0x01)	ERRnoaccess (0x0005)	STATUS_ACCESS_DENIED (0xC0000022)	EPERM	Access denied.
ERRDOS (0x01)	ERRbadfid (0x0006)	STATUS_INVALID_HANDLE (0xC0000008)	ENOENT	The FID supplied is invalid.
ERRDOS (0x01)	ERRnomem (0x0008)	STATUS_INSUFF_SERVER_RESOURCES (0xC0000205)	ENOMEM	The server is out of resources.

SMB error class	SMB error code	NT status code	POSIX equivalent	Description
ERRDOS (0x01)	ERRgeneral (0x001F)	STATUS_UNSUCCESSFUL (0xC0000001)		The size of the extended attribute list is not correct. Check the EaErrorOffset field for the address of the SMB_FEA structure at which the error was detected.
ERRDOS (0x01)	ERRinvalidparam (0x0057)	STATUS_INVALID_PARAMETER (0xC000000D)		One of the extended attributes had an invalid Flag bit value.
ERRDOS (0x01)	ERRunknownlevel (0x007C)	STATUS_OS2_INVALID_LEVEL (0x007C0001)		The InformationLevel supplied is invalid or the DataCount failed validation for the requested InformationLevel because not enough information was supplied by the client.
ERRDOS (0x01)	ERRbadealist (0x00FF)	STATUS_OS2_EA_LIST_INCONSISTENT (0x00FF0001) STATUS_EA_LIST_INCONSISTENT (0x80000014)		Inconsistent extended attribute list.
ERRSRV (0x02)	ERRerror (0x0001)	STATUS_INVALID_SMB (0x00010002)		Invalid SMB. Not enough parameter bytes were sent.
ERRSRV (0x02)	ERRinvtid (0x0005)	STATUS_INVALID_HANDLE (0xC0000008) STATUS_SMB_BAD_TID (0x00050002)		The TID is no longer valid.
ERRSRV (0x02)	ERRbaduid (0x005B)	STATUS_INVALID_HANDLE (0xC0000008) STATUS_SMB_BAD_UID (0x005B0002)		The UID supplied is not defined to the session.
ERRHRD (0x03)	ERRnowrite (0x0013)	STATUS_MEDIA_WRITE_PROTECTED (0xC00000A2)		The FID supplied is on write-protected media.

SMB error class	SMB error code	NT status code	POSIX equivalent	Description
ERRHRD (0x03)	ERRdata (0x0017)	STATUS_DATA_ERROR (0xC000003E)	EIO	Disk I/O error.

2.2.6.10 TRANS2_FSCTL (0x0009)

This Transaction2 subcommand was introduced in the **LAN Manager 2.0** dialect. This subcommand is reserved but not implemented.

Clients SHOULD NOT send requests using this command code. Servers receiving requests with this command code MUST return STATUS_NOT_IMPLEMENTED (ERRDOS/ERRbadfunc).

2.2.6.11 TRANS2_IOCTL2 (0x000A)

This Transaction2 subcommand was introduced in the NT LAN Manager dialect. This subcommand is reserved but not implemented.

Clients SHOULD NOT send requests using this command code. Servers receiving requests with this command code MUST return STATUS_NOT_IMPLEMENTED (ERRDOS/ERRbadfunc).

2.2.6.12 TRANS2_FIND_NOTIFY_FIRST (0x000B)

This Transaction2 subcommand was introduced in the **LAN Manager 2.0** dialect. It was rendered obsolete in the NT LAN Manager dialect.

Clients SHOULD NOT send requests using this command code. Servers receiving requests with this command code MUST return STATUS_NOT_IMPLEMENTED (ERRDOS/ERRbadfunc).

2.2.6.13 TRANS2_FIND_NOTIFY_NEXT (0x000C)

This Transaction2 subcommand was introduced in the **LAN Manager 2.0** dialect. It was rendered obsolete in the NT LAN Manager dialect.

Clients SHOULD NOT send requests using this command code. Servers receiving requests with this command code MUST return STATUS_NOT_IMPLEMENTED (ERRDOS/ERRbadfunc).

2.2.6.14 TRANS2_CREATE_DIRECTORY (0x000D)

This Transaction2 subcommand was introduced in the **LAN Manager 2.0** dialect.

This transaction is used to create a new directory and can be used to set extended attribute information. The directory is specified by a path relative to the **TID** supplied in the [SMB Header \(section 2.2.3.1\)](#). The directory MUST NOT exist. If the directory does exist, the request MUST fail and the server MUST return STATUS_OBJECT_NAME_COLLISION (ERRDOS/ERRfilexists).

2.2.6.14.1 Request

The TRANS2_CREATE_DIRECTORY request and response formats are special cases of [SMB_COM_TRANSACTION2 \(section 2.2.4.46\)](#) SMB. Only the TRANS2_CREATE_DIRECTORY specifics are described here.

SMB_Parameters

WordCount (1 byte): This field MUST be 0x0F.

Words (30 bytes):

TotalDataCount (2 bytes): This field MUST be zero (0x0000).

SetupCount (1 byte): This field MUST be 0x01.

Setup (2 bytes): This field MUST be TRANS2_CREATE_DIRECTORY (0x000D).

Trans2_Parameters

```
Trans2_Parameters
{
    ULONG      Reserved;
    SMB_STRING DirectoryName;
}
```

Reserved (4 bytes): This field is reserved and MUST be zero (0x00000000).

DirectoryName (variable): The directory name to assign to the new directory.

Trans2_Data

This Trans2_Data is used to set extended attribute information for the new directory. The data element is as follows.

```
Trans2_Data
{
    SMB_FEA_LIST ExtendedAttributeList;
}
```

ExtendedAttributeList (variable): A list of extended attribute name/value pairs.

2.2.6.14.2 Response

The response information indicates if there was a problem with the list of extended attributes, if they were supplied. The outcome of the request is included in the [SMB Header \(section 2.2.3.1\)](#).

```
Trans2_Parameters
{
    USHORT EaErrorOffset;
}
```

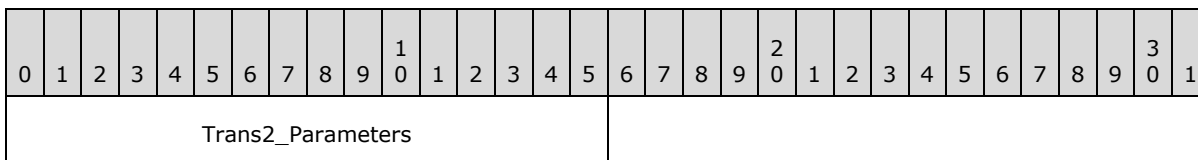

Trans2_Parameters (2 bytes):

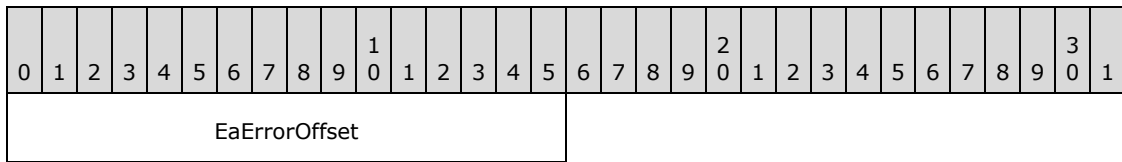

EaErrorOffset (2 bytes): This field contains the offset in bytes into the **ExtendedAttributeList.FEAList** that identifies the attribute that caused an error. This field is meaningful only when the request included **Trans2_Data**.

Trans2_Data

No data is sent by this message.

Error Codes

SMB error class	SMB error code	NT status code	POSIX equivalent	Description
ERRDOS (0x01)	ERRbadpath (0x0003)	STATUS_OBJECT_PATH_SYNTAX_BAD (0xC000003B)	ENOENT	The path syntax is invalid.
ERRDOS (0x01)	ERRbadpath (0x0003)	STATUS_OBJECT_PATH_INVALID (0xC0000039)	ENOTDIR	A component of the path-prefix was not a directory.
ERRDOS (0x01)	ERRbadpath (0x0003)	STATUS_OBJECT_PATH_NOT_FOUND (0xC000003A)	ENOENT	The path does not exist.
ERRDOS (0x01)	ERRnoaccess (0x0005)	STATUS_ACCESS_DENIED (0xC0000022)	EACCESS	A component of the path-prefix denied search permission.
ERRDOS (0x01)	ERRnoaccess (0x0005)		ENOSPC	The parent directory is full.
ERRDOS (0x01)	ERRnoaccess (0x0005)		EMLINK	Too many links to the parent directory.
ERRDOS (0x01)	ERRgeneral (0x001F)	STATUS_UNSUCCESSFUL (0xC0000001)		The size of the extended attribute list is not correct. Check the EaErrorOffset field for the address of the SMB_FEA structure at which the error was detected.
ERRDOS (0x01)	ERRfileexists (0x0050)	STATUS_OBJECT_NAME_COLLISION (0xC0000035)	EEXIST	The specified path already exists.

SMB error class	SMB error code	NT status code	POSIX equivalent	Description
ERRDOS (0x01)	ERRinvalidparam (0x0057)	STATUS_INVALID_PARAMETER (0xC000000D) STATUS_INVALID_EA_FLAG (0x80000015)		One of the extended attributes had an invalid Flag bit value.
ERRDOS (0x01)	ERRunknownlevel (0x007C)	STATUS_OS2_INVALID_LEVEL (0x007C0001)		The InformationLevel supplied is invalid.
ERRDOS (0x01)	ERRinvalidparam (0x0057)	STATUS_INVALID_EA_NAME (0x80000013)		Invalid value for extended attribute name. Check the EaErrorOffset field for the location.
ERRDOS (0x01)	ERRbadealist (0x00FF)	STATUS_EA_LIST_INCONSISTENT (0x80000014) STATUS_OS2_EA_LIST_INCONSISTENT (0x00FF0001)		Inconsistent extended attribute list detected during system validation. EaErrorOffset indicates the incorrect entry.
ERRSRV (0x02)	ERRerror (0x0001)	STATUS_INVALID_SMB (0x00010002)		Invalid SMB. Not enough parameter bytes were sent.
ERRSRV (0x02)	ERRinvtid (0x0005)	STATUS_SMB_BAD_TID (0x00050002)		The TID is no longer valid.
ERRSRV (0x02)	ERRnomem (0x0008)	STATUS_INSUFF_SERVER_RESOURCES (0xC0000205)	ENOMEM	The server is out of resources.
ERRSRV (0x02)	ERRbaduid (0x005B)	STATUS_SMB_BAD_UID (0x005B0002)		The UID supplied is not defined to the session.
ERRHRD (0x03)	ERRnowrite (0x0013)	STATUS_MEDIA_WRITE_PROTECTED (0xC00000A2)	EROFS	Attempt to write to a read-only file system.
ERRHRD (0x03)	ERRdata (0x0017)	STATUS_DATA_ERROR (0xC000003E)	EIO	Disk I/O error.

2.2.6.15 TRANS2_SESSION_SETUP (0x000E)

This Transaction2 subcommand was introduced in the NT LAN Manager dialect. This subcommand is reserved but not implemented.

Clients SHOULD NOT send requests using this command code. Servers receiving requests with this command code SHOULD return STATUS_NOT_IMPLEMENTED (ERRDOS/ERRbadfunc).

2.2.6.16 TRANS2_GET_DFS_REFERRAL (0x0010)

This Transaction2 subcommand was introduced in the NT LAN Manager dialect.

This transaction subcommand is used to request a referral for a disk object in DFS.

2.2.6.16.1 Request

The TRANS2_GET_DFS_REFERRAL request and response formats are special cases of [SMB_COM_TRANSACTION2 \(section 2.2.4.46\)](#) SMB. Only the TRANS2_GET_DFS_REFERRAL specifics are described here.

SMB_Parameters:

WordCount (1 byte): This field MUST be 0x0F.

Words (30 bytes):

TotalDataCount (2 bytes): This field MUST be zero (0x0000).

Flags (2 bytes): This field SHOULD be zero (0x0000).

Timeout (4 bytes): This field SHOULD be zero (0x00000000).

MaxSetupCount (1 byte): This field MUST be zero (0x00).

MaxParameterCount (4 bytes): This field MUST be zero (0x00000000).

SetupCount (1 byte): This field MUST be 0x01.

Setup (2 bytes): This field MUST be TRANS2_GET_DFS_REFERRAL (0x0010).

Trans2_Parameters:

```
Trans2_Parameters
{
    REQ_GET_DFS_REFERRAL ReferralRequest;
}
```

ReferralRequest (variable): REQ_GET_DFS_REFERRAL This field MUST be a properly formatted DFS referral request, as specified in [\[MS-DFSC\]](#) section 2.2.2.

Trans2_Data: No data is sent by this message.

2.2.6.16.2 Response

The TRANS2_GET_DFS_REFERRAL request and response formats are special cases of [SMB_COM_TRANSACTION2 \(section 2.2.4.46\)](#) SMB. Only the TRANS2_GET_DFS_REFERRAL specifics are described here.

SMB_Parameters:

WordCount (1 byte): This field MUST be 0x0F.

Words (30 bytes):

TotalParameterCount (2 bytes): This field MUST be zero (0x0000).

SetupCount (1 byte): This field MUST be 0x01.

Setup (2 bytes): This field MUST be TRANS2_GET_DFS_REFERRAL (0x0010).

Trans2_Parameters: No parameters are sent by this message.

Trans2_Data:

```
Trans2_Data
{
    RESP_GET_DFS_REFERRAL ReferralResponse;
}
```

ReferralResponse: RESP_GET_DFS_REFERRAL This field MUST be a properly formatted DFS referral response, as specified in [\[MS-DFSC\]](#) section 2.2.4.

2.2.6.17 TRANS2_REPORT_DFS_INCONSISTENCY (0x0011)

This Transaction2 subcommand was introduced in the NT LAN Manager dialect. This subcommand is reserved but not implemented.

Clients SHOULD NOT send requests using this command code. Servers receiving requests with this command code SHOULD return STATUS_NOT_IMPLEMENTED (ERRDOS/ERRbadfunc).

2.2.7 NT Transact Subcommands

2.2.7.1 NT_TRANSACT_CREATE (0x0001)

This NT Transaction subcommand was introduced in the NT LAN Manager dialect.

This transaction subcommand is used to create or open a file or directory when extended attributes (EAs) or a security descriptor (SD) need to be applied.

Parameters and Data for the subcommand are encoded as shown following. The information required in order to perform the create or open operation is passed in the Parameters section of the transaction request. Extended attributes and/or the security descriptors are provided in the Data portion of the transaction request.

2.2.7.1.1 Request

The NT_TRANSACT_CREATE request FILE_SEQUENTIAL_ONLY format is a special case of [SMB_COM_NT_TRANSACT \(section 2.2.4.62\)](#) SMB. The NT_TRANSACT_CREATE request specifics are described here.

```
NT_Trans_Parameters
{
    ULONG          Flags;
    ULONG          RootDirectoryFID;
    ULONG          DesiredAccess;
    LARGE_INTEGER  AllocationSize;
    SMB_EXT_FILE_ATTR ExtFileAttributes;
    ULONG          ShareAccess;
```

```

ULONG      CreateDisposition;
ULONG      CreateOptions;
ULONG      SecurityDescriptorLength;
ULONG      EALength;
ULONG      NameLength;
ULONG      ImpersonationLevel;
UCHAR      SecurityFlags;
UCHAR      Name[NameLength];
}
NT_Trans_Data
{
SECURITY_DESCRIPTOR SecurityDescriptor;
FILE_FULL_EA_INFORMATION ExtendedAttributes[];
}

```

SMB_Parameters:

WordCount (1 byte): This field MUST be 0x13.

Words (38 bytes): Array of USHORT

Function (2 bytes): USHORT This field MUST be NT_TRANSACT_CREATE (0x0001).

SetupCount (1 byte): This field MUST be 0x00.

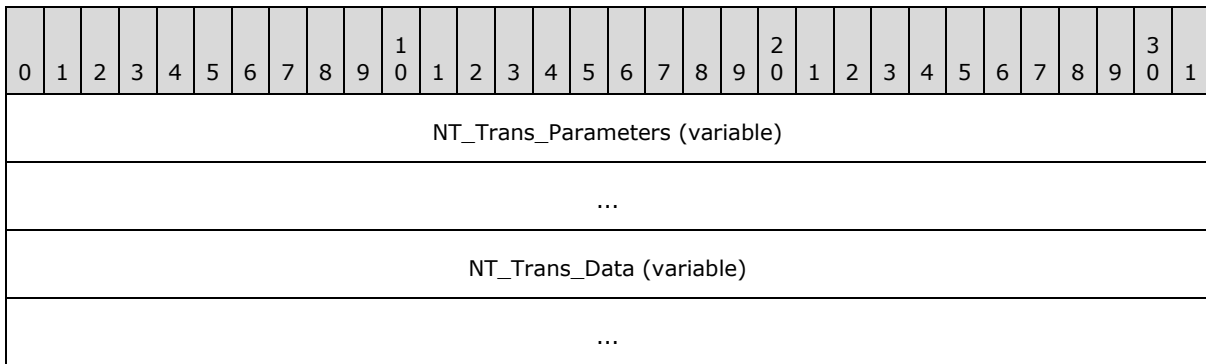

NT_Trans_Parameters (variable): The format of the parameters is very similar to the SMB_COM_NT_CREATE_ANDX command.



...	
ExtFileAttributes	
ShareAccess	
CreateDisposition	
CreateOptions	
SecurityDescriptorLength	
EALength	
NameLength	
ImpersonationLevel	
SecurityFlags	Name (variable)
...	

Flags (4 bytes): ULONG A 32-bit field containing a set of flags that modify the client request. Unused bits SHOULD be set to 0 by the client when sending a message and MUST be ignored when received by the server.

Name and bitmask	Meaning
NT_CREATE_REQUEST_OPLOCK 0x00000002	Level I (exclusive) OpLock requested.
NT_CREATE_REQUEST_OPBATCH 0x00000004	Batch OpLock requested.
NT_CREATE_OPEN_TARGET_DIR 0x00000008	The parent directory of the target is to be opened.

RootDirectoryFID (4 bytes): ULONG If nonzero, this value is the **FID** of an opened root directory, and the **Name** field MUST be handled as relative to the directory specified by this **FID**. If this value is zero (0x00000000), the **Name** field MUST be handled as relative to the root of the share (the **TID**). The **FID** MUST have been acquired in a previous message exchange.

DesiredAccess (4 bytes): ULONG A 32-bit field containing standard, specific, and generic access rights. These rights are used in access-control entries (ACEs) and are the primary means of specifying the requested or granted access to an object. If this value is 0x00000000, it represents a request to query the attributes without accessing the file. If the value is not 0x00000000, the bits represent requests for the following types of access:

Name and bitmask	Meaning
FILE_READ_DATA 0x00000001	Indicates the right to read data from the file.
FILE_WRITE_DATA 0x00000002	Indicates the right to write data into the file beyond the end of the file.
FILE_APPEND_DATA 0x00000004	Indicates the right to append data to the file beyond the end of the file only.
FILE_READ_EA 0x00000008	Indicates the right to read the extended attributes of the file.
FILE_WRITE_EA 0x00000010	Indicates the right to write or change the extended attributes of the file.
FILE_EXECUTE 0x00000020	Indicates the right to execute the file.
FILE_READ_ATTRIBUTES 0x00000080	Indicates the right to read the attributes of the file.
FILE_WRITE_ATTRIBUTES 0x00000100	Indicates the right to change the attributes of the file.
DELETE 0x00010000	Indicates the right to delete or to rename the file.
READ_CONTROL 0x00020000	Indicates the right to read the security descriptor of the file.
WRITE_DAC 0x00040000	Indicates the right to change the discretionary access control list (DACL) in the security descriptor of the file.
WRITE_OWNER 0x00080000	Indicates the right to change the owner in the security descriptor of the file.
SYNCHRONIZE 0x00100000	SHOULD NOT be used by the sender and MUST be ignored by the receiver.
ACCESS_SYSTEM_SECURITY 0x01000000	Indicates the right to read or change the system access control list (SACL) in the security descriptor for the file. If the SE_SECURITY_NAME privilege ([MS-LSAD] section 3.1.1.2.1) is not set in the access token, the server MUST fail the open request and return STATUS_PRIVILEGE_NOT_HELD.
MAXIMUM_ALLOWED 0x02000000	Indicates that the client requests an open to the file with the highest level of access that the client has on this file. If no access is granted for the client on this file, the server MUST fail the open and return a STATUS_ACCESS_DENIED.
GENERIC_ALL 0x10000000	Indicates a request for all of the access flags that are previously listed, except MAXIMUM_ALLOWED and ACCESS_SYSTEM_SECURITY.
GENERIC_EXECUTE 0x20000000	Indicates a request for the following combination of access flags listed previously in this table: FILE_READ_ATTRIBUTES, FILE_EXECUTE, SYNCHRONIZE,

Name and bitmask	Meaning
	and READ_CONTROL.
GENERIC_WRITE 0x40000000	Indicates a request for the following combination of access flags listed previously in this table: FILE_WRITE_DATA, FILE_APPEND_DATA, SYNCHRONIZE, FILE_WRITE_ATTRIBUTES, FILE_WRITE_EA, and READ_CONTROL.
GENERIC_READ 0x80000000	Indicates a request for the following combination of access flags listed previously in this table: FILE_WRITE_DATA, FILE_APPEND_DATA, SYNCHRONIZE, FILE_WRITE_ATTRIBUTES, FILE_WRITE_EA, and READ_CONTROL.

AllocationSize (8 bytes): LARGE_INTEGER The client MUST set this value to the initial allocation size of the file in bytes. The server MUST ignore this field if this request is to open an existing file. This field MUST be used only if the file is created or overwritten. The value MUST be set to 0x0000000000000000 in all other cases. This does not apply to directory-related requests. This is the number of bytes to be allocated, represented as a 64-bit integer value.

ExtFileAttributes (4 bytes): This field contains the extended file attributes of the file being requested, encoded as an [SMB_EXT_FILE_ATTR \(section 2.2.1.2.3\)](#) data type.

ShareAccess (4 bytes): ULONG A 32-bit field that specifies how the file SHOULD be shared with other processes. The names in the table below are provided for reference use only. The value MUST be FILE_SHARE_NONE or some combination of the other values:

Name and bitmask	Meaning
FILE_SHARE_NONE 0x00000000	(No bits set.) Prevents the file from being shared.
FILE_SHARE_READ 0x00000001	Other open operations can be performed on the file for read access.
FILE_SHARE_WRITE 0x00000002	Other open operations can be performed on the file for write access.
FILE_SHARE_DELETE 0x00000004	Other open operations can be performed on the file for delete access.

CreateDisposition (4 bytes): ULONG A 32-bit value that represents the action to take if the file already exists or if the file is a new file and does not already exist.

Name and Value	Meaning
FILE_SUPERSEDE 0x00000000	(No bits set.) If the file already exists, it SHOULD be superseded (overwritten). If it does not already exist, it SHOULD be created.
FILE_OPEN	If the file already exists, it SHOULD be opened rather than creating a

Name and Value	Meaning
0x00000001	new file. If the file does not already exist, the operation MUST fail.
FILE_CREATE 0x00000002	If the file already exists, the operation MUST fail. If the file does not already exist, it SHOULD be created.
FILE_OPEN_IF 0x00000003	If the file already exists, it SHOULD be opened. If the file does not already exist, it SHOULD be created.
FILE_OVERWRITE 0x00000004	If the file already exists, it SHOULD be opened and truncated. If the file does not already exist, the operation MUST fail. The client MUST open the file with at least GENERIC_WRITE access for the command to succeed.
FILE_OVERWRITE_IF 0x00000005	If the file already exists, it SHOULD be opened and truncated. If the file does not already exist, it SHOULD be created. The client MUST open the file with at least GENERIC_WRITE access.

CreateOptions (4 bytes): ULONG A 32-bit field containing flag options to use if creating the file or directory. This field MUST be set to 0x00000000 or a combination of the following possible values. Unused bit fields SHOULD be set to 0 by the client when sending a request and SHOULD be ignored when received by the server. Below is a list of the valid values and their associated behaviors.

Name and bitmask	Meaning
FILE_DIRECTORY_FILE 0x00000001	The file being created or opened is a directory file. With this option, the CreateDisposition field MUST be set to FILE_CREATE, FILE_OPEN, or FILE_OPEN_IF. When this bit field is set, other compatible CreateOptions include only the following: FILE_WRITE_THROUGH, FILE_OPEN_FOR_BACKUP_INTENT, and FILE_OPEN_BY_FILE_ID.
FILE_WRITE_THROUGH 0x00000002	Applications that write data to the file MUST actually transfer the data into the file before any write request qualifies as semantically complete. If FILE_NO_INTERMEDIATE_BUFFERING is set, the server MUST process the request as if FILE_WRITE_THROUGH is set in the create request, even if not set by the client.
FILE_SEQUENTIAL_ONLY 0x00000004	This option indicates that access to the file MAY be sequential. The server can use this information to influence its caching and read-ahead strategy for this file. The file MAY in fact be accessed randomly, but the server can optimize its caching and read-ahead policy for sequential access.
FILE_NO_INTERMEDIATE_BUFFERING 0x00000008	The file SHOULD NOT be cached or buffered in an internal buffer by the server. This option is incompatible when the FILE_APPEND_DATA bit field is set in the DesiredAccess field.
FILE_SYNCHRONOUS_IO_ALERT 0x00000010	This flag MUST be ignored by the server, and clients SHOULD set it to 0.

Name and bitmask	Meaning
FILE_SYNCHRONOUS_IO_NONALERT 0x00000020	This flag MUST be ignored by the server, and clients SHOULD set it to 0.
FILE_NON_DIRECTORY_FILE 0x00000040	If the file being opened is a directory, the server MUST fail the request with STATUS_FILE_IS_A_DIRECTORY in the Status field of the SMB Header (section 2.2.3.1) in the server response.
FILE_CREATE_TREE_CONNECTION 0x00000080	This option SHOULD NOT be sent by the clients, and this option MUST be ignored by the server.
FILE_COMPLETE_IF_OPLOCKED 0x00000100	This option SHOULD NOT be sent by the clients, and this option MUST be ignored by the server.
FILE_NO_EA_KNOWLEDGE 0x00000200	The application that initiated the client's request does not support extended attributes (EAs). If the EAs on an existing file being opened indicate that the caller SHOULD support EAs to correctly interpret the file, the server SHOULD fail this request with STATUS_ACCESS_DENIED (ERRDOS/ERRnoaccess) in the Status field of the SMB Header in the server response.
FILE_OPEN_FOR_RECOVERY 0x00000400	This option SHOULD NOT be sent by the clients, and this option MUST be ignored if received by the server.
FILE_RANDOM_ACCESS 0x00000800	Indicates that access to the file MAY be random. The server MAY use this information to influence its caching and read-ahead strategy for this file. This is a hint to the server that sequential read-ahead operations might not be appropriate on the file.
FILE_DELETE_ON_CLOSE 0x00001000	The file SHOULD be automatically deleted when the last open request on this file is closed. When this option is set, the DesiredAccess field MUST include the DELETE flag. This option is often used for temporary files.
FILE_OPEN_BY_FILE_ID 0x00002000	Opens a file based on the FileId. If this option is set, the server MUST fail the request with STATUS_NOT_SUPPORTED in the Status field of the SMB Header in the server response.
FILE_OPEN_FOR_BACKUP_INTENT 0x00004000	The file is opened or created for the purposes of either a backup or a restore operation. Thus, the server can check to ensure that the caller is capable of overriding whatever security checks have been placed on the file to allow a backup or restore operation to occur. The server can check for access rights to the file before checking the DesiredAccess field.
FILE_NO_COMPRESSION 0x00008000	When a new file is created, the file MUST NOT be compressed, even if it is on a compressed volume. The flag MUST be ignored when opening an existing

Name and bitmask	Meaning
	file.
FILE_RESERVE_OPFILTER 0x00100000	This option SHOULD NOT be sent by the clients, and this option MUST be ignored if received by the server.
FILE_OPEN_NO_RECALL 0x00400000	In a hierarchical storage management environment, this option requests that the file SHOULD NOT be recalled from tertiary storage such as tape. A file recall can take up to several minutes in a hierarchical storage management environment. The clients can specify this option to avoid such delays.
FILE_OPEN_FOR_FREE_SPACE_QUERY 0x00800000	This option SHOULD NOT be sent by the clients, and this option MUST be ignored if received by the server.

SecurityDescriptorLength (4 bytes): ULONG Length of the **NT_Trans_Data.SecurityDescriptor** field, in bytes.

EALength (4 bytes): ULONG Length of the **NT_Trans_Data.ExtendedAttributes** field, in bytes.

NameLength (4 bytes): ULONG Length of the **Name** field in characters.

ImpersonationLevel (4 bytes): ULONG This field specifies the impersonation level requested by the application that is issuing the create request, and MUST contain one of the following values. The server MUST validate this field, but otherwise ignore it.

Impersonation is described in [\[MS-WPO\]](#) section 8.5.1; for more information about impersonation, see [\[MSDN-IMPERS\]](#).

Name and value	Meaning
SEC_ANONYMOUS 0x00000000	The application-requested impersonation level is Anonymous.
SEC_IDENTIFY 0x00000001	The application-requested impersonation level is Identification.
SEC_IMPERSONATE 0x00000002	The application-requested impersonation level is Impersonation.

SecurityFlags (1 byte): UCHAR An 8-bit field containing a set of options that specify the security tracking mode. These options specify whether the server is to be given a snapshot of the client's security context (called static tracking) or is to be continually updated to track changes to the client's security context (called dynamic tracking). When bit 0 of the **SecurityFlags** field is set to 0, static tracking is requested. When bit 0 the **SecurityFlags** field is set to 1, dynamic tracking is requested. Unused bit fields SHOULD be set to 0 by the client when sending a request and MUST be ignored when received by the server. This field MUST be set to 0x00 or a combination of the following possible values. Value names are provided for convenience only. Supported values are:

Name and value	Meaning
SMB_SECURITY_CONTEXT_TRACKING 0x01	When set, dynamic tracking is requested. When this bit field is not set, static tracking is requested.
SMB_SECURITY_EFFECTIVE_ONLY 0x02	Specifies that only the enabled aspects of the client's security context are available to the server. If this flag is not specified, all aspects of the client's security context are available. This flag allows the client to limit the groups and privileges that a server can use while impersonating the client.

Name (variable): The name of the file; not null-terminated. If SMB_FLAGS2_UNICODE is set in the **Flags2** field of the SMB Header of the request, this field **MUST** be an array of 16-bit Unicode characters. Otherwise, it **MUST** be an array of extended ASCII (OEM) characters. If the **Name** consists of Unicode characters, this field **MUST** be aligned to start on a 2-byte boundary from the start of the **NT_Trans_Parameters**.

NT_Trans_Data (variable): The NT_Trans_Data provides the Security Descriptor and Extended Attributes data, if any.

0	1	2	3	4	5	6	7	8	9	10	11	12	13	14	15	16	17	18	19	20	21	22	23	24	25	26	27	28	29	30	31
SecurityDescriptor (variable)																															
...																															
ExtendedAttributes (variable)																															
...																															

SecurityDescriptor (variable): SECURITY_DESCRIPTOR The security descriptor to use when requesting access to the file. The self-relative form of a SECURITY_DESCRIPTOR **MUST** be used. See SECURITY_DESCRIPTOR ([\[MS-DTYP\]](#) section 2.4.6) for details. This field **MUST** be **NT_Trans_Parameters.SecurityDescriptorLength** in bytes.

ExtendedAttributes (variable): The extended attributes that **SHOULD** be applied to the new file **MUST** be in the format that is specified for **FILE_FULL_EA_INFORMATION** in ([\[MS-FSCC\]](#) section 2.4.15).<147>

2.2.7.1.2 Response

The NT_TRANSACT_CREATE response format is a special case of [SMB_COM_NT_TRANSACT](#) (section 2.2.4.62) SMB. The NT_TRANSACT_CREATE response specifics are described here. The outcome of the request is returned in the **Status** field of the [SMB Header](#) (section 2.2.3.1).

```

NT_Trans_Parameters
{
    UCHAR          OpLockLevel;
    UCHAR          Reserved;
    USHORT         FID;
}

```

```

ULONG      CreateAction;
ULONG      EAErrorOffset;
FILETIME   CreationTime;
FILETIME   LastAccessTime;
FILETIME   LastWriteTime;
FILETIME   LastChangeTime;
SMB_EXT_FILE_ATTR ExtFileAttributes;
LARGE_INTEGER AllocationSize;
LARGE_INTEGER EndOfFile;
USHORT     ResourceType;
SMB_NMPIPE_STATUS NMPipeStatus;
UCHAR      Directory;
}

```

0	1	2	3	4	5	6	7	8	9	10	11	12	13	14	15	16	17	18	19	20	21	22	23	24	25	26	27	28	29	30	31
NT_Trans_Parameters																															
...																															
...																															
...																															
...																															
...																															
...																															
...																															
(NT_Trans_Parameters cont'd for 9 rows)																															
...																															

NT_Trans_Parameters (69 bytes):

0	1	2	3	4	5	6	7	8	9	10	11	12	13	14	15	16	17	18	19	20	21	22	23	24	25	26	27	28	29	30	31
OpLockLevel									Reserved									FID													
CreateAction																															
EAErrorOffset																															

CreationTime	
...	
LastAccessTime	
...	
LastWriteTime	
...	
LastChangeTime	
...	
ExtFileAttributes	
AllocationSize	
...	
EndOfFile	
...	
ResourceType	NMPipeStatus
Directory	

OpLockLevel (1 byte): UCHAR The OpLock level granted to the client process.

Value	Meaning
0x00	No OpLock granted.
0x01	Exclusive OpLock granted.
0x02	Batch OpLock granted.
0x03	Level II OpLock granted.

Reserved (1 byte): UCHAR Reserved and MUST be zero (0x00).

FID (2 bytes): USHORT The file ID value representing the file or directory that was created or opened.

CreateAction (4 bytes): ULONG The action taken in establishing the open. This field MUST contain one of the following values:

Value	Meaning
FILE_SUPERSEDED 0x00000000	An existing file was deleted and a new file was created in its place.
FILE_OPENED 0x00000001	An existing file was opened.
FILE_CREATED 0x00000002	A new file was created.
FILE_OVERWRITTEN 0x00000003	An existing file was overwritten.

EAErrorOffset (4 bytes): ULONG Offset of the extended attribute that caused an error if an error occurred with an extended attribute.

CreationTime (8 bytes): FILETIME A 64-bit integer value representing the time that the file was created. The time value is a signed 64-bit integer representing either an absolute time or a time interval. Times are specified in units of 100ns. A positive value expresses an absolute time, where the base time (the 64-bit integer with value 0) is the beginning of the year 1601 AD in the Gregorian calendar. A negative value expresses a time interval relative to some base time, usually the current time.

LastAccessTime (8 bytes): FILETIME The time that the file was last accessed, encoded in the same format as **CreationTime**.

LastWriteTime (8 bytes): FILETIME The time that the file was last written, encoded in the same format as **CreationTime**.

LastChangeTime (8 bytes): FILETIME The time that the file was last changed, encoded in the same format as **CreationTime**.

ExtFileAttributes (4 bytes): This field contains the extended file attributes the file, encoded as an [SMB_EXT_FILE_ATTR \(section 2.2.1.2.3\)](#) data type.

AllocationSize (8 bytes): LARGE_INTEGER The number of bytes allocated to the file by the server.

EndOfFile (8 bytes): LARGE_INTEGER The end of file offset value.

ResourceType (2 bytes): The file type. This field MUST be interpreted as follows.

Name and value	Meaning
FileTypeDisk 0x0000	File or directory
FileTypeByteModePipe 0x0001	Byte mode named pipe
FileTypeMessageModePipe 0x0002	Message mode named pipe
FileTypePrinter	Printer device

Name and value	Meaning
0x0003	
FileTypeUnknown 0xFFFF	Unknown file type

NMPipeStatus (2 bytes): A 16-bit field that shows the status of the named pipe if the resource type created is a named pipe. This field is formatted as an [SMB NMPIPE STATUS \(section 2.2.1.3\)](#).

Directory (1 byte): UCHAR If the returned **FID** represents a directory, the server MUST set this value to a nonzero (0x00) value. If the **FID** is not a directory, the server MUST set this value to 0x00 (FALSE).

NT_Trans_Data

The server does not return any NT_Trans data.

Error Codes

SMB error class	SMB error code	NT status code	POSIX equivalent	Description
ERRDOS (0x01)	ERRbadpath (0x0003)	STATUS_OBJECT_PATH_SYNTAX_BAD (0xC000003B)	ENOENT	The file path syntax is invalid.
ERRDOS (0x01)	ERRnofids (0x0004)	STATUS_OS2_TOO_MANY_OPEN_FILES (0x00040001) STATUS_TOO_MANY_OPENED_FILES (0xC000011F)	EMFILE	Too many open files; no more FIDs available.
ERRDOS (0x01)	ERRnoaccess (0x0005)	STATUS_ACCESS_DENIED (0xC0000022)	EPERM	Access denied.
ERRDOS (0x01)	ERRnoaccess (0x0005)	STATUS_FILE_IS_A_DIRECTORY (0xC00000BA)	EISDIR	Named file is an existing directory and CreateOptions in the request contains FILE_NON_DIRECTORY_FILE.
ERRDOS (0x01)	ERRbadfid (0x0006)	STATUS_INVALID_HANDLE (0xC0000008)	EBADF	Invalid FID ; RootDirectoryFID is not valid.
ERRDOS (0x01)	ERRnomem (0x0008)	STATUS_INSUFF_SERVER_RESOURCES (0xC0000205)	ENOMEM	The server is out of resources.
ERRDOS	ERRbadaccess	STATUS_ACCESS_DENIED		Invalid open mode.

SMB error class	SMB error code	NT status code	POSIX equivalent	Description
S (0x01)	(0x000C)	(0xC0000022)		
ERRDOS (0x01)	ERRbadshare (0x0020)	STATUS_SHARING_VIOLATION (0xC0000043)	ETXTBSY	Sharing violation.
ERRDOS (0x01)	ERRgeneral (0x001F)	STATUS_UNSUCCESSFUL (0xC0000001) STATUS_INVALID_EA_NAME (0x80000013)		The size of the extended attribute list is not correct. Check the EAErrorOffset field for the address of the EA at which the error was detected. EA name was invalid.
ERRDOS (0x01)	ERRfileexists (0x0050)	STATUS_OBJECT_NAME_COLLISION (0xC0000035)	EEXIST	The file already exists.
ERRDOS (0x01)	ERRinvalidparam (0x0057)	STATUS_INVALID_PARAMETER (0xC000000D)		One of the extended attributes had an invalid Flags bit value.
ERRDOS (0x01)	ERRbadealist (0x00FF)	STATUS_OS2_EA_LIST_INCONSISTENT (0x00FF0001) STATUS_EA_LIST_INCONSISTENT (0x80000014)		Inconsistent extended attribute list.
ERRSRV (0x02)	ERRerror (0x0001)	STATUS_INVALID_SMB (0x00010002)		Invalid SMB. Not enough parameter bytes were sent, or the path extends beyond the end of the message.
ERRSRV (0x02)	ERRinvtid (0x0005)	STATUS_SMB_BAD_TID (0x00050002)		The TID is no longer valid.
ERRSRV (0x02)	ERRnomem (0x0008)	STATUS_INSUFF_SERVER_RESOURCES (0xC0000205)	ENOMEM	The server is out of resources.
ERRSRV (0x02)	ERRbaduid (0x005B)	STATUS_SMB_BAD_UID (0x005B0002)		The UID supplied is not defined to the session.
ERRSRV (0x02)	ERRgeneral (0x001F)	STATUS_INVALID_SECURITY_DESCRIPTOR (0xC0000079)		Invalid security descriptor.
ERRHR	ERRgeneral	STATUS_INVALID_SECURITY_DESCRIPTOR		Invalid security descriptor.

SMB error class	SMB error code	NT status code	POSIX equivalent	Description
D (0x03)	(0x001F)	R (0xC0000079)		

2.2.7.2 NT_TRANSACT_IOCTL (0x0002)

This NT Transaction subcommand was introduced in the NT LAN Manager dialect.

This transaction subcommand allows IOCTL and FSCTL functions to be transferred transparently from client to server. This command is useful for sending platform-specific or implementation-specific information to the server. [<148>](#)

2.2.7.2.1 Request

The NT_TRANSACT_IOCTL request format is a special case of [SMB_COM_NT_TRANSACT \(section 2.2.4.62\)](#) SMB. Only the NT_TRANSACT_IOCTL request specifics are described here.

```

NT_Trans_Parameters
{
}

NT_Trans_Data
{
    UCHAR Data[TotalDataCount];
}

```

SMB_Parameters:

WordCount (1 byte): [UCHAR](#) This field MUST be 0x17.

Words (46 bytes): Array of [USHORT](#).

TotalParameterCount (2 bytes): [USHORT](#) This field MUST be set to 0x0000.

MaxParameterCount (2 bytes): [USHORT](#) This field MUST be set to 0x0000.

ParameterCount (2 bytes): [USHORT](#) This field MUST be set to 0x0000.

SetupCount (1 byte): [UCHAR](#) This field MUST be 0x04.

Function (2 bytes): [USHORT](#) This field MUST be NT_TRANSACT_IOCTL (0x0002).

0	1	2	3	4	5	6	7	8	9	10	11	12	13	14	15	16	17	18	19	20	21	22	23	24	25	26	27	28	29	30	31
Setup																															
...																															

NT_Trans_Parameters (variable)
...
NT_Trans_Data (variable)
...

Setup (8 bytes):

0	1	2	3	4	5	6	7	8	9	10	11	12	13	14	15	16	17	18	19	20	21	22	23	24	25	26	27	28	29	30	31
FunctionCode																															
FID																IsFctl								IsFlags							

FunctionCode (4 bytes): ULONG The control code of the **file system control** or device control (FSCTL/IOCTL) method. The values are defined in [\[MS-FSCC\]](#) section 2.3.

FID (2 bytes): USHORT MUST contain a valid **FID** obtained from a previously successful SMB open command. The **FID** MUST be for either an I/O device or for a file system control device. The type of **FID** being supplied is specified by **IsFctl**.

IsFctl (1 byte): BOOLEAN This field is TRUE if the command is a file system control command and the **FID** is a file system control device. Otherwise, the command is a device control command and **FID** is an I/O device.

IsFlags (1 byte): BOOLEAN If bit 0 is set, the command is to be applied to a share root handle. The share MUST be a Distributed File System (DFS) type.

NT_Trans_Parameters (variable): (0 bytes): No NT_Trans parameters are sent in this request.

NT_Trans_Data (variable):

0	1	2	3	4	5	6	7	8	9	10	11	12	13	14	15	16	17	18	19	20	21	22	23	24	25	26	27	28	29	30	31
Data (variable)																															
...																															

Data (variable): The raw bytes that are passed to the **fsctl** or **ioctl** function as the input buffer.

2.2.7.2.2 Response

The NT_TRANSACT_IOCTL response formats are special cases of [SMB_COM_NT_TRANSACT \(section 2.2.4.62\)](#) SMB. Only the NT_TRANSACT_IOCTL response specifics are described here. The outcome of the request is encoded in the [SMB Header \(section 2.2.3.1\)](#).

```

NT_Trans_Data
{
    UCHAR Data[TotalDataCount];
}

```

SMB_Parameters:

WordCount (1 byte): UCHAR This field MUST be 0x13.

Words (38 bytes): Array of USHORT

SetupWordCount (1 byte): UCHAR Count of setup words. The value is 0x01.

SetupWords (2 bytes): USHORT The size of the transaction data, in bytes, returned by the server for the file system control command. The client MUST ignore this field value.

DataCount (2 bytes): USHORT Count of data bytes returned by either an I/O device or a file system control command.

NT_Trans_Parameters: The server does not return any NT_Trans parameters.

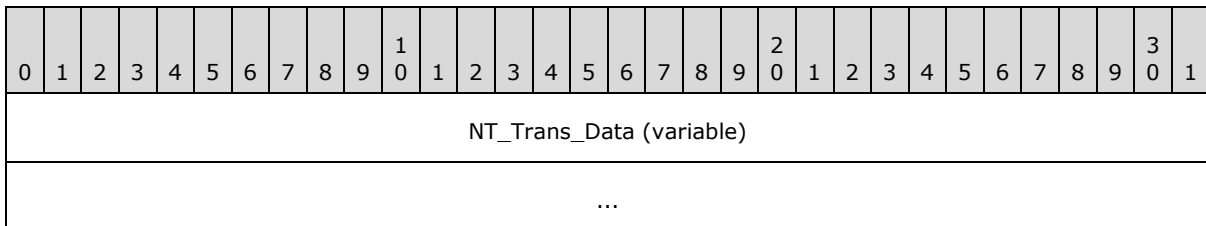

NT_Trans_Data (variable):

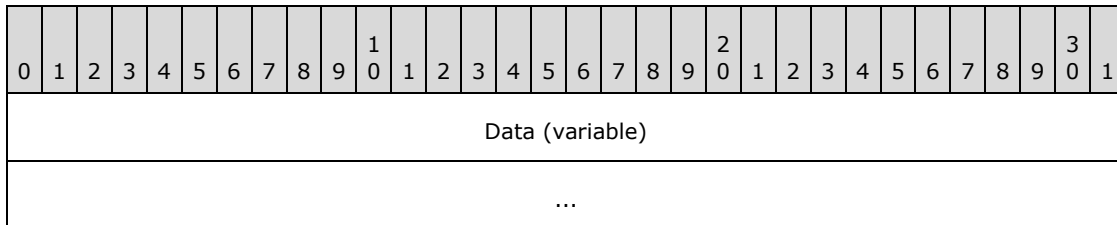

Data (variable): Results returned by either an I/O device or a file system control command. The results are the raw bytes returned from the command if the command was successful.

Error Codes

SMB error class	SMB error code	NT status code	POSIX equivalent	Description
ERRDOS (0x01)	ERRbadfid (0x0006)	STATUS_INVALID_HANDLE (0xC0000008)	EBADF	The FID is invalid.
ERRDOS	ERRnoaccess	STATUS_ACCESS_DENIED	EPERM	Access denied.

SMB error class	SMB error code	NT status code	POSIX equivalent	Description
(0x01)	(0x0005)	(0xC0000022)		
ERRDOS (0x01)	ERRinvalidparam (0x0057)	STATUS_INVALID_PARAMETER (0xC000000D)		A parameter is invalid.
ERRSRV (0x02)	ERRerror (0x0001)	STATUS_INVALID_SMB (0x00010002)		Invalid SMB. Not enough parameter bytes were sent.
ERRSRV (0x02)	ERRinvtid (0x0005)	STATUS_SMB_BAD_TID (0x00050002)		The TID is no longer valid.
ERRSRV (0x02)	ERRnomem (0x0008)	STATUS_INSUFF_SERVER_RESOURCES (0xC0000205)	ENOMEM	The server is out of resources.
ERRSRV (0x02)	ERRbaduid (0x005B)	STATUS_SMB_BAD_UID (0x005B0002)		The UID supplied is not defined to the session.
ERRHRD (0x03)	ERRdata (0x0017)	STATUS_DATA_ERROR (0xC000003E)	EIO	Disk I/O error.

2.2.7.3 NT_TRANSACTION_SET_SECURITY_DESC (0x0003)

This NT Transaction subcommand was introduced in the NT LAN Manager dialect.

This transaction subcommand allows a client to set the security descriptors for a file. <149> The client MUST provide the FID of the file for which the security descriptors are to be set. The server MUST set the security descriptor for the file referred to in FID. The security descriptor is provided in the **Data** portion of the transaction request.

2.2.7.3.1 Request

The NT_TRANSACTION_SET_SECURITY_DESC request format is a special case of [SMB_COM_NT_TRANSACTION \(section 2.2.4.62\)](#) SMB. Only the NT_TRANSACTION_SET_SECURITY_DESC request specifics are described here.

```

NT_Trans_Parameters
{
    USHORT FID;
    USHORT Reserved;
    ULONG SecurityInformation;
}
NT_Trans_Data
{
    SECURITY_DESCRIPTOR SecurityDescriptor (variable);
}

```

SMB_Parameters:

WordCount (1 byte): UCHAR This field MUST be 0x13.

Words (38 bytes): Array of USHORT

Function (2 bytes): USHORT This field MUST be NT_TRANSACT_SET_SECURITY_DESC (0x0003).

MaxSetupCount (1 byte): This field MUST be 0x00.

MaxDataCount (4 bytes): This field MUST be 0x00000000.

MaxParameterCount (4 bytes): This field MUST be 0x00000000.

SetupCount (1 byte): UCHAR This field MUST be 0x00.

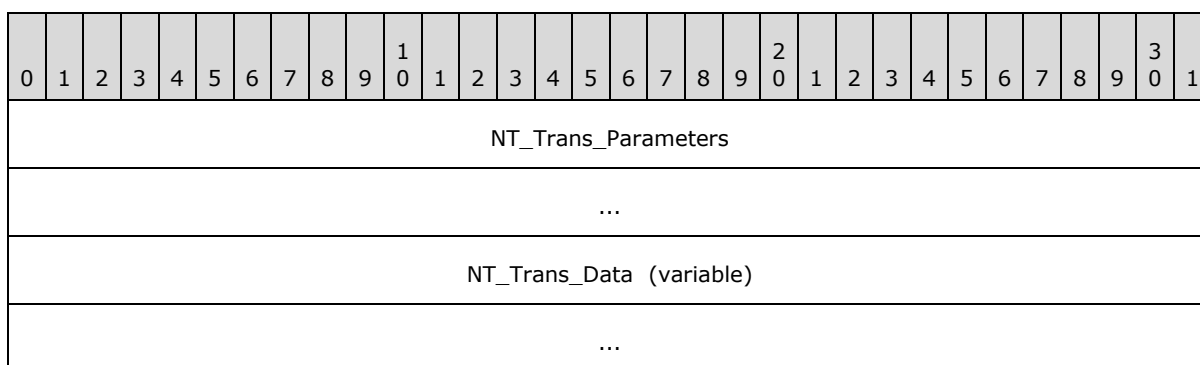

NT_Trans_Parameters (8 bytes):

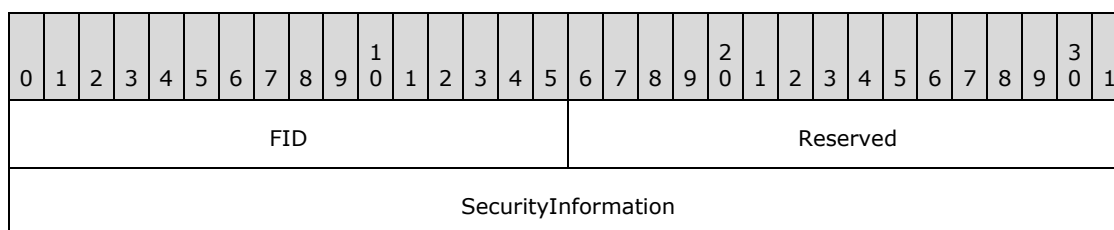

FID (2 bytes): USHORT File identifier or handle of the target file.

Reserved (2 bytes): USHORT Reserved. This value MUST be 0x0000.

SecurityInformation (4 bytes): ULONG Fields of security descriptor to be set. This is a bit field. These values can be logically OR-ed together to set several descriptors in one request. The server MUST set only the descriptors requested by **SecurityInformation**.

Name and bitmask	Meaning
OWNER_SECURITY_INFORMATION 0x00000001	Owner of the object or resource.
GROUP_SECURITY_INFORMATION 0x00000002	Group associated with the object or resource.

Name and bitmask	Meaning
DACL_SECURITY_INFORMATION 0x00000004	Discretionary access control list (DACL) associated with the object or resource.
SACL_SECURITY_INFORMATION 0x00000008	System access control list (SACL) associated with the object or resource.

NT_Trans_Data (variable):

0	1	2	3	4	5	6	7	8	9	0	1	2	3	4	5	6	7	8	9	0	1	2	3	4	5	6	7	8	9	0	1		
SecurityDescriptor (variable)																																	
...																																	

SecurityDescriptor (variable): SECURITY_DESCRIPTOR The requested security descriptor structure. The self-relative form of a SECURITY_DESCRIPTOR is required. For details, see [\[MS-DTYP\] SECURITY_DESCRIPTOR](#) (section 2.4.6).

2.2.7.3.2 Response

The NT_TRANSACT_SET_SECURITY_DESC response format is a special case of [SMB_COM_NT_TRANSACT](#) (section 2.2.4.62) SMB. Only the NT_TRANSACT_SET_SECURITY_DESC response specifics are described here. The outcome of the request is encoded in the [SMB Header](#) (section 2.2.3.1).

NT_Trans_Parameters: The server does not return any NT_Trans parameters.

NT_Trans_Data: The server does not return any NT_Trans data.

Error Codes

SMB error class	SMB error code	NT status code	POSIX equivalent	Description
ERRDOS (0x01)	ERRbadfid (0x0006)	STATUS_INVALID_HANDLE (0xC0000008) STATUS_SMB_BAD_FID (0x00060001)	EBADF	The FID is invalid.
ERRDOS (0x01)	ERRnoaccess (0x0005)	STATUS_ACCESS_DENIED (0xC0000022)	EPERM	Access denied.
ERRDOS (0x01)	ERRinvalidparam (0x0057)	STATUS_INVALID_PARAMETER (0xC000000D)		A parameter is invalid.
ERRSRV (0x02)	ERRerror (0x0001)	STATUS_INVALID_SMB (0x00010002)		Invalid SMB. Not enough parameter bytes were

SMB error class	SMB error code	NT status code	POSIX equivalent	Description
				sent.
ERRSRV (0x02)	ERRinvtid (0x0005)	STATUS_SMB_BAD_TID (0x00050002)		The TID is no longer valid.
ERRSRV (0x02)	ERRnomem (0x0008)	STATUS_INSUFF_SERVER_RESOURCES (0xC0000205)	ENOMEM	The server is out of resources.
ERRSRV (0x02)	ERRbaduid (0x005B)	STATUS_SMB_BAD_UID (0x005B0002)		The UID supplied is not defined to the session.
ERRHRD (0x03)	ERRdata (0x0017)	STATUS_DATA_ERROR (0xC000003E)	EIO	Disk I/O error.
ERRHRD (0x03)	ERRgeneral (0x001F)	STATUS_INVALID_SECURITY_DESCR (0xC0000079)		Invalid security descriptor.

2.2.7.4 NT_TRANSACT_NOTIFY_CHANGE (0x0004)

This NT Transaction subcommand was introduced in the NT LAN Manager dialect.

This command notifies the client when the directory, specified by FID, is modified. It also returns the names of all file system objects that changed, and the ways in which they were modified. The command completes once the directory has been modified based on the supplied **CompletionFilter**. The command is a "single shot" and therefore needs to be reissued to watch for more directory changes.

The **TotalParameterCount** field of the server response indicates the number of bytes that are being returned. If too many files (that is, more entries than will fit in the response buffer) have changed since the last time that the command was issued, then zero bytes are returned and STATUS_NOTIFY_ENUM_DIR (ERRDOS/ERROR_NOTIFY_ENUM_DIR) is returned in the **Status** field of the server response header.

A directory file **MUST** be opened before this command can be used. After the directory is open, this command is used to watch files and subdirectories in the specified directory for changes. When the command is issued, the server creates a buffer that is used to collect directory changes between NT_TRANSACT_NOTIFY_CHANGE calls. The **SMB_Parameters.Words.MaxParameterCount** field in the [SMB_COM_NT_TRANSACT Request \(section 2.2.4.62.1\)](#) determines the size of the buffer that the server uses to store directory change information.

2.2.7.4.1 Request

The NT_TRANSACT_NOTIFY_CHANGE request and response formats are special cases of [SMB_COM_NT_TRANSACT \(section 2.2.4.62\)](#) SMB. Only the NT_TRANSACT_NOTIFY_CHANGE request specifics are described here.

```
Setup
{
    ULONG    CompletionFilter;
```

```

USHORT  FID;
BOOLEAN WatchTree;
UCHAR   Reserved;
}

```

SMB_Parameters:

WordCount (1 byte): This field MUST be 0x17.

Words (46 bytes): Array of **USHORT**.

MaxSetupCount (1 byte): This field MUST be 0x00.

MaxDataCount (4 bytes): This field MUST be 0x00000000.

Function (2 bytes): This field MUST be NT_TRANSACT_NOTIFY_CHANGE (0x0004).

SetupCount (1 byte): This field MUST be 04, indicating that 4 words (8 bytes) are used for Setup information.

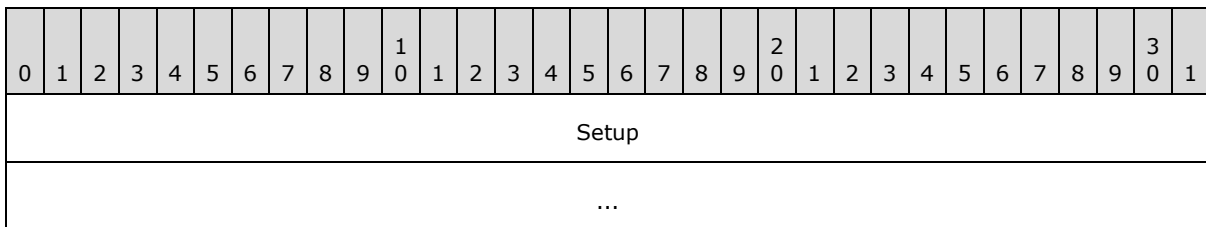

Setup (8 bytes):

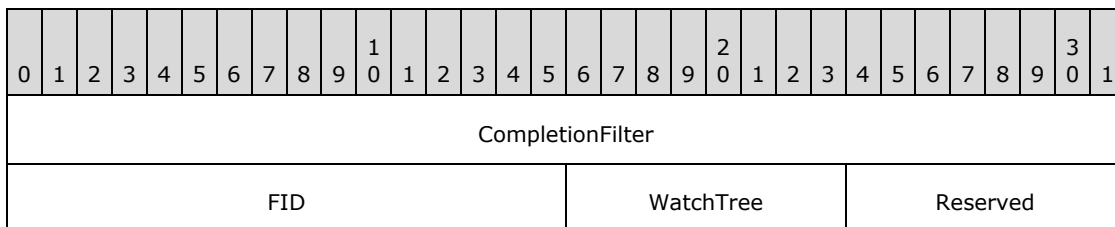

CompletionFilter (4 bytes): A 32-bit field of flags that specify the types of operations to monitor.

Name	Value
FILE_NOTIFY_CHANGE_FILE_NAME	0x00000001
FILE_NOTIFY_CHANGE_DIR_NAME	0x00000002
FILE_NOTIFY_CHANGE_NAME	0x00000003
FILE_NOTIFY_CHANGE_ATTRIBUTES	0x00000004
FILE_NOTIFY_CHANGE_SIZE	0x00000008
FILE_NOTIFY_CHANGE_LAST_WRITE	0x00000010

Name	Value
FILE_NOTIFY_CHANGE_LAST_ACCESS	0x00000020
FILE_NOTIFY_CHANGE_CREATION	0x00000040
FILE_NOTIFY_CHANGE_EA	0x00000080
FILE_NOTIFY_CHANGE_SECURITY	0x00000100
FILE_NOTIFY_CHANGE_STREAM_NAME	0x00000200
FILE_NOTIFY_CHANGE_STREAM_SIZE	0x00000400
FILE_NOTIFY_CHANGE_STREAM_WRITE	0x00000800

FID (2 bytes): The **FID** of the directory to monitor.

WatchTree (1 byte): If all subdirectories are to be watched, then this field **MUST** be set to TRUE; otherwise, it **MUST** be set to FALSE.

Reserved (1 byte): Reserved. This value **MUST** be 0x00.

NT_Trans_Parameters

The client does not provide any NT_Trans_Parameters in the request.

NT_Trans_Data

The client does not provide any NT_Trans_Data in the request.

2.2.7.4.2 Response

```

NT_Trans_Parameters
{
    FILE_NOTIFY_INFORMATION FileNotifyInformation[];
}

```

0	1	2	3	4	5	6	7	8	9	10	11	12	13	14	15	16	17	18	19	20	21	22	23	24	25	26	27	28	29	30	31
NT_Trans_Parameters (variable)																															
...																															

NT_Trans_Parameters (variable):

FileNotifyInformation: An array of FILE_NOTIFY_INFORMATION structures, as specified in [\[MS-FSCC\]](#) section 2.4.42. <150>

NT_Trans_Data

The server does not return any data.

Error Codes

SMB error class	SMB error code	NT status code	POSIX equivalent	Description
ERRDOS (0x01)	ERRbadfid (0x0006)	STATUS_INVALID_HANDLE (0xC0000008)	EBADF	The FID is invalid.
ERRDOS (0x01)	ERRnoaccess (0x0005)	STATUS_ACCESS_DENIED (0xC0000022)	EPERM	Access denied.
ERRDOS (0x01)	ERRinvalidparam (0x0057)	STATUS_INVALID_PARAMETER (0xC000000D)		A parameter is invalid.
ERRSRV (0x02)	ERR_NOTIFY_ENUM_DIR (0x03FE)	STATUS_NOTIFY_ENUM_DIR (0x0000010C)		The number of bytes of changed data exceeds the MaxParameterCount field in the client request.
ERRSRV (0x02)	ERRerror (0x0001)	STATUS_INVALID_SMB (0x00010002)		Invalid SMB. Byte count and sizes are inconsistent.
ERRSRV (0x02)	ERRinvtid (0x0005)	STATUS_SMB_BAD_TID (0x00050002)		The TID is no longer valid.
ERRSRV (0x02)	ERRnomem (0x0008)	STATUS_INSUFF_SERVER_RESOURCES (0xC0000205)	ENOMEM	The server is out of resources.
ERRSRV (0x02)	ERRbaduid (0x005B)	STATUS_SMB_BAD_UID (0x005B0002)		The UID supplied is not defined to the session.
ERRHRD (0x03)	ERRdata (0x0017)	STATUS_DATA_ERROR (0xC000003E)	EIO	Disk I/O error.

2.2.7.5 NT_TRANSACTION_RENAME (0x0005)

This NT Transaction subcommand was introduced in the NT LAN Manager dialect. This subcommand was **reserved but not implemented**.

Clients SHOULD NOT send requests using this subcommand code. Servers receiving requests with this subcommand code MUST return STATUS_SMB_BAD_COMMAND (ERRSRV/ERRbadcmd).

2.2.7.6 NT_TRANSACTION_QUERY_SECURITY_DESC (0x0006)

This NT Transaction subcommand was introduced in the NT LAN Manager dialect.

This transaction subcommand allows a client to retrieve the security descriptor for a file. <151> The client MUST provide the FID of the file that is the target of the query. The server MUST query the security descriptor from the file system for the file referred to in FID. The security descriptor is returned in the NT_Trans_Data portion of the transaction response.

2.2.7.6.1 Request

The NT_TRANSACT_QUERY_SECURITY_DESC request format is a special case of [SMB_COM_NT_TRANSACT \(section 2.2.4.62\)](#) SMB. Only the NT_TRANSACT_QUERY_SECURITY_DESC request specifics are described here.

```

NT_Trans_Parameters
{
  USHORT FID;
  USHORT Reserved;
  ULONG SecurityInfoFields;
}

```

SMB_Parameters:

WordCount (1 byte): UCHAR This field MUST be 0x13.

Words (38 bytes): Array of USHORT.

MaxSetupCount (1 byte): This field MUST be 0x00.

MaxParameterCount (4 bytes): This field MUST be 0x00000004.

Function (2 bytes): USHORT This field MUST be NT_TRANSACT_QUERY_SECURITY_DESC (0x0006).

SetupCount (1 byte): UCHAR This field MUST be 0x00.

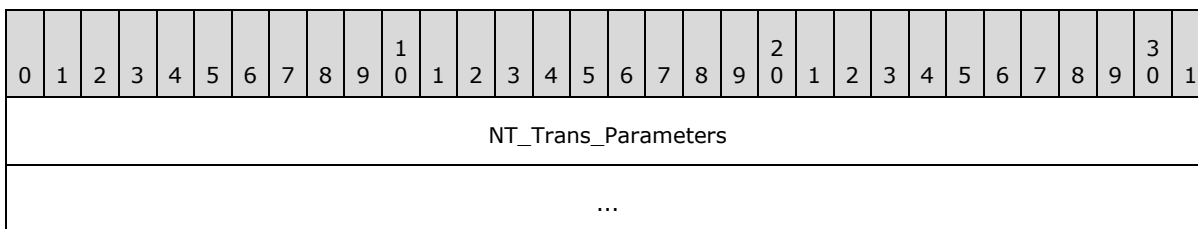

NT_Trans_Parameters (8 bytes):

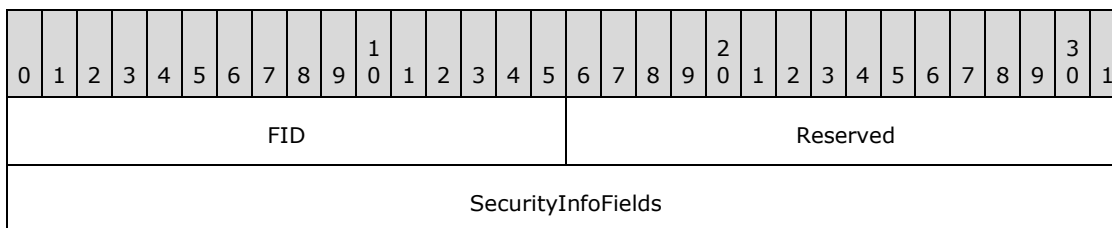

FID (2 bytes): USHORT FID of the target file. The FID MUST have been obtained through a previously successful SMB open request.

Reserved (2 bytes): USHORT Reserved. This value MUST be 0x0000.

SecurityInfoFields (4 bytes): ULONG A 32-bit field representing the requested fields of the security descriptor to be retrieved. These values can be logically OR-ed together to request several descriptors in one request. The descriptor response format contains storage for all of the descriptors. The client MUST ignore the values returned for descriptors corresponding to bits that were not included in this field as part of the request.

Name and bitmask	Meaning
OWNER_SECURITY_INFORMATION 0x00000001	Owner of the object or resource.
GROUP_SECURITY_INFORMATION 0x00000002	Group associated with the object or resource.
DACL_SECURITY_INFORMATION 0x00000004	Discretionary access control list (DACL) associated with the object or resource.
SACL_SECURITY_INFORMATION 0x00000008	System access control list (SACL) associated with the object or resource.

NT_Trans_Data

The client does not provide any data in the request.

2.2.7.6.2 Response

The [NT_TRANSMACT_QUERY_SECURITY_DESC \(section 2.2.7.6\)](#) response format is a special case of [SMB_COM_NT_TRANSMACT \(section 2.2.4.62\)](#) SMB. Only the NT_TRANSMACT_QUERY_SECURITY_DESC response format specifics are described here.

```

NT_Trans_Parameters
{
    ULONG LengthNeeded;
}

NT_Trans_Data
{
    SECURITY_DESCRIPTOR SecurityDescriptor (variable);
}

```

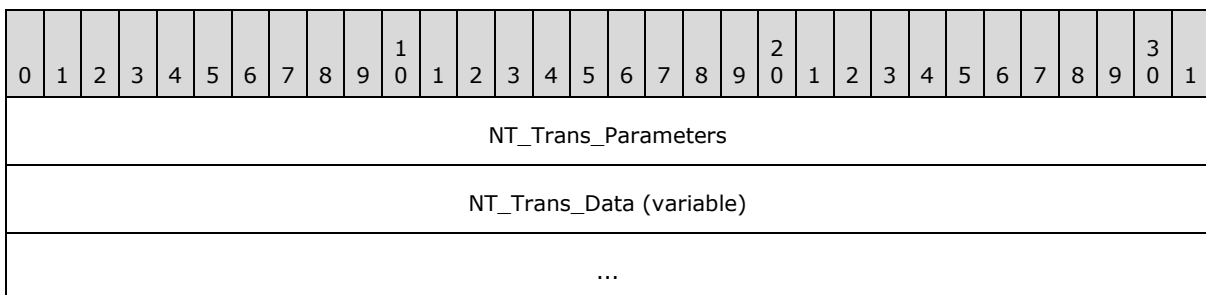

NT_Trans_Parameters (4 bytes):

0	1	2	3	4	5	6	7	8	9	10	11	12	13	14	15	16	17	18	19	20	21	22	23	24	25	26	27	28	29	30	31
LengthNeeded																															

LengthNeeded (4 bytes): The length of the returned **SecurityDescriptor** field.

NT_Trans_Data (variable):

0	1	2	3	4	5	6	7	8	9	10	11	12	13	14	15	16	17	18	19	20	21	22	23	24	25	26	27	28	29	30	31
SecurityDescriptor (variable)																															
...																															

SecurityDescriptor (variable): The requested security descriptor structure. The self-relative form of a **SECURITY_DESCRIPTOR** structure is returned. For details, see **SECURITY_DESCRIPTOR** ([\[MS-DTYP\]](#) section 2.4.6).

Error Codes

SMB error class	SMB error code	NT status code	POSIX equivalent	Description
ERRDOS (0x01)	ERRbadfid (0x0006)	STATUS_INVALID_HANDLE (0xC0000008)	EBADF	The FID is invalid.
ERRDOS (0x01)	ERRnoaccess (0x0005)	STATUS_ACCESS_DENIED (0xC0000022)	EPERM	Access denied.
ERRDOS (0x01)	ERRinvalidparam (0x0057)	STATUS_INVALID_PARAMETER (0xC000000D)		A parameter is invalid.
ERRSRV (0x02)	ERRerror (0x0001)	STATUS_INVALID_SMB (0x00010002)		Invalid SMB. Byte count and sizes are inconsistent.
ERRSRV (0x02)	ERRinvtid (0x0005)	STATUS_SMB_BAD_TID (0x00050002)		The TID is no longer valid.
ERRSRV (0x02)	ERRnomem (0x0008)	STATUS_INSUFF_SERVER_RESOURCES (0xC0000205)	ENOMEM	The server is out of resources.
ERRSRV (0x02)	ERRbaduid (0x005B)	STATUS_SMB_BAD_UID (0x005B0002)		The UID supplied is not defined to the

SMB error class	SMB error code	NT status code	POSIX equivalent	Description
				session.
ERRSRV (0x02)	ERRmoredata (0x00EA)	STATUS_BUFFER_OVERFLOW (0x80000005)		The number of bytes of changed data exceeds the MaxParameterCount field in the client request.
ERRHRD (0x03)	ERRdata (0x0017)	STATUS_DATA_ERROR (0xC000003E)	EIO	Disk I/O error.

2.2.8 Information Levels

The client MUST map the application-provided [\[MS-FSCC\]](#) information levels to SMB information levels as specified in the following tables. For all other [\[MS-FSCC\]](#) information levels, the client MUST fail the request with STATUS_NOT_SUPPORTED.

FIND Information Levels

FSCC Level	SMB Level
FileDirectoryInformation ([MS-FSCC] section 2.4.10)	SMB_FIND_FILE_DIRECTORY_INFO (section 2.2.8.1.4)
FileFullDirectoryInformation ([MS-FSCC] section 2.4.14)	SMB_FIND_FILE_FULL_DIRECTORY_INFO (section 2.2.8.1.5)
FileNamesInformation ([MS-FSCC] section 2.4.26)	SMB_FIND_FILE_NAMES_INFO (section 2.2.8.1.6)
FileBothDirectoryInformation ([MS-FSCC] section 2.4.8)	SMB_FIND_FILE_BOTH_DIRECTORY_INFO (section 2.2.8.1.7)

QUERY_FS Information Levels

FSCC Level	SMB Level
FileFsVolumeInformation ([MS-FSCC] section 2.5.9)	SMB_QUERY_FS_VOLUME_INFO (section 2.2.8.2.3)
FileFsSizeInformation ([MS-FSCC] section 2.5.8)	SMB_QUERY_FS_SIZE_INFO (section 2.2.8.2.4)
FileFsDeviceInformation ([MS-FSCC] section 2.5.10)	SMB_QUERY_FS_DEVICE_INFO (section 2.2.8.2.5)
FileFsAttributeInformation ([MS-FSCC] section 2.5.1)	SMB_QUERY_FS_ATTRIBUTE_INFO (section 2.2.8.2.6)

QUERY Information Levels

FSCC Level	SMB Level
FileBasicInformation ([MS-FSCC] section 2.4.7)	SMB_QUERY_FILE_BASIC_INFO (section 2.2.8.3.6)
FileStandardInformation ([MS-FSCC] section 2.4.38)	SMB_QUERY_FILE_STANDARD_INFO (section 2.2.8.3.7)
FileEaInformation ([MS-FSCC] section 2.4.12)	SMB_QUERY_FILE_EA_INFO (section 2.2.8.3.8)
FileNameInformation ([MS-FSCC] section 2.4.25)	SMB_QUERY_FILE_NAME_INFO (section 2.2.8.3.9)
FileAllInformation ([MS-FSCC] section 2.4.2)	SMB_QUERY_FILE_ALL_INFO (section 2.2.8.3.10)
FileAlternateNameInformation ([MS-FSCC] section 2.4.5)	SMB_QUERY_FILE_ALT_NAME_INFO (section 2.2.8.3.11)
FileStreamInformation ([MS-FSCC] section 2.4.40)	SMB_QUERY_FILE_STREAM_INFO (section 2.2.8.3.12)
FileCompressionInformation ([MS-FSCC] section 2.4.9)	SMB_QUERY_FILE_COMPRESSION_INFO (section 2.2.8.3.13)

SET Information Levels

FSCC Level	SMB Level
FileBasicInformation ([MS-FSCC] section 2.4.7)	SMB_SET_FILE_BASIC_INFO (section 2.2.8.4.3)
FileDispositionInformation ([MS-FSCC] section 2.4.11)	SMB_SET_FILE_DISPOSITION_INFO (section 2.2.8.4.4)
FileAllocationInformation ([MS-FSCC] section 2.4.4)	SMB_SET_FILE_ALLOCATION_INFO (section 2.2.8.4.5)
FileEndOfFileInformation ([MS-FSCC] section 2.4.13)	SMB_SET_FILE_END_OF_FILE_INFO (section 2.2.8.4.6)

2.2.8.1 FIND Information Levels

2.2.8.1.1 SMB_INFO_STANDARD

This information level structure is used in [TRANS2_FIND_FIRST2](#) (section 2.2.6.2) and [TRANS2_FIND_NEXT2](#) (section 2.2.6.3) responses to return the following information for all files that match the request's search criteria:

- Creation, access, and last write timestamps
- File size
- File attributes
- File name

```
SMB_INFO_STANDARD[SearchCount]
{
    ULONG                ResumeKey (optional);
```

```

SMB_DATE      CreationDate;
SMB_TIME      CreationTime;
SMB_DATE      LastAccessDate;
SMB_TIME      LastAccessTime;
SMB_DATE      LastWriteDate;
SMB_TIME      LastWriteTime;
ULONG         FileDataSize;
ULONG         AllocationSize;
SMB_FILE_ATTRIBUTES Attributes;
UCHAR         FileNameLength;
SMB_STRING    FileName;
}

```

ResumeKey: (4 bytes): This field is optional. If the SMB_FIND_RETURN_RESUME_KEYS bit is set in the **Flags** field of the [TRANS2_FIND_FIRST2 Request \(section 2.2.6.2.1\)](#) parameters, this field MUST contain the server-generated resume key. The resume key MUST be supplied in subsequent [TRANS2_FIND_NEXT2 Requests](#) to continue the search. If the SMB_FIND_RETURN_RESUME_KEYS bit is not set, then the server MUST NOT include this field.

CreationDate: (2 bytes): This field contains the date when the file was created.

CreationTime: (2 bytes): This field contains the time when the file was created.

LastAccessDate: (2 bytes): This field contains the date when the file was last accessed.

LastAccessTime: (2 bytes): This field contains the time when the file was last accessed.

LastWriteDate: (2 bytes): This field contains the date when data was last written to the file.

LastWriteTime: (2 bytes): This field contains the time when data was last written to the file.

FileDataSize: (4 bytes): This field contains the file size, in filesystem allocation units.

AllocationSize: (4 bytes): This field contains the size of the filesystem allocation unit, in bytes.

Attributes: (2 bytes): This field contains the file attributes.

FileNameLength: (1 byte): This field contains the length of the **FileName** field, in bytes.

FileName: (variable): This field contains the name of the file. [<152>](#)

2.2.8.1.2 SMB_INFO_QUERY_EA_SIZE

This information level structure is used in [TRANS2_FIND_FIRST2 \(section 2.2.6.2\)](#) and [TRANS2_FIND_NEXT2 \(section 2.2.6.3\)](#) responses to return the SMB_INFO_STANDARD data along with the size of a file's extended attributes (EAs) list for all files that match the request's search criteria.

```

SMB_INFO_QUERY_EA_SIZE[SearchCount]
{
    ULONG         ResumeKey (optional);
    SMB_DATE      CreationDate;
    SMB_TIME      CreationTime;
    SMB_DATE      LastAccessDate;
    SMB_TIME      LastAccessTime;
}

```

```

SMB_DATE          LastWriteDate;
SMB_TIME          LastWriteTime;
ULONG             FileDataSize;
ULONG             AllocationSize;
SMB_FILE_ATTRIBUTES Attributes;
ULONG             EaSize;
UCHAR             FileNameLength;
SMB_STRING        FileName;
}

```

ResumeKey: (4 bytes): This field is optional. If the SMB_FIND_RETURN_RESUME_KEYS bit is set in the **Flags** field of the [TRANS2_FIND_FIRST2 Request \(section 2.2.6.2.1\)](#) parameters, then this field MUST contain the server-generated resume key. The resume key MUST be supplied in subsequent [TRANS2_FIND_NEXT2 Requests \(section 2.2.6.3.1\)](#) to continue the search. If the SMB_FIND_RETURN_RESUME_KEYS bit is not set, then the server MUST NOT include this field.

CreationDate: (2 bytes): This field contains the date when the file was created.

CreationTime: (2 bytes): This field contains the time when the file was created.

LastAccessDate: (2 bytes): This field contains the date when the file was last accessed.

LastAccessTime: (2 bytes): This field contains the time when the file was last accessed.

LastWriteDate: (2 bytes): This field contains the date when data was last written to the file.

LastWriteTime: (2 bytes): This field contains the time when data was last written to the file.

FileDataSize: (4 bytes): This field contains the file size, in filesystem allocation units.

AllocationSize: (4 bytes): This field contains the size of the filesystem allocation unit, in bytes.

Attributes: (2 bytes): This field contains the file attributes.

EaSize: (4 bytes): This field contains the size of the file's extended attribute (EA) information, in bytes.

FileNameLength: (1 byte): This field contains the length of the **FileName** field, in bytes.

FileName: (variable): This field contains the name of the file. [<153>](#)

2.2.8.1.3 SMB_INFO_QUERY_EAS_FROM_LIST

This information level structure is used in [TRANS2_FIND_FIRST2 \(section 2.2.6.2\)](#) and [TRANS2_FIND_NEXT2 \(section 2.2.6.3\)](#) responses to return the SMB_INFO_QUERY_EA_SIZE data along with a specific list of EAs for all files that match the request's search criteria. The requested EAs are provided in the **Trans2_Data** block of the request.

```

SMB_INFO_QUERY_EAS_FROM_LIST[SearchCount]
{
    ULONG             ResumeKey (optional);
    SMB_DATE          CreationDate;
    SMB_TIME          CreationTime;
    SMB_DATE          LastAccessDate;
}

```

```

SMB_TIME          LastAccessTime;
SMB_DATE          LastWriteDate;
SMB_TIME          LastWriteTime;
ULONG             FileDataSize;
ULONG             AllocationSize;
SMB_FILE_ATTRIBUTES Attributes;
SMB_FEA_LIST      ExtendedAttributeList;
UCHAR             FileNameLength;
SMB_STRING        FileName;
}

```

ResumeKey: (4 bytes): This field is optional. If the SMB_FIND_RETURN_RESUME_KEYS bit is set in the **Flags** field of the [TRANS2_FIND_FIRST2 Request \(section 2.2.6.2.1\)](#) parameters, this field MUST contain the server-generated resume key. The resume key MUST be supplied in subsequent [TRANS2_FIND_NEXT2 Requests \(section 2.2.6.3.1\)](#) to continue the search. If the SMB_FIND_RETURN_RESUME_KEYS bit is not set, the server MUST NOT include this field.

CreationDate: (2 bytes): This field contains the date when the file was created.

CreationTime: (2 bytes): This field contains the time when the file was created.

LastAccessDate: (2 bytes): This field contains the date when the file was last accessed.

LastAccessTime: (2 bytes): This field contains the time when the file was last accessed.

LastWriteDate: (2 bytes): This field contains the date when data was last written to the file.

LastWriteTime: (2 bytes): This field contains the time when data was last written to the file.

FileDataSize: (4 bytes): This field contains the file size, in filesystem allocation units.

AllocationSize: (4 bytes): This field contains the size of the filesystem allocation unit, in bytes.

Attributes: (2 bytes): This field contains the file attributes.

ExtendedAttributeList: (variable): A list of all of the extended attribute (EA) name/value pairs assigned to the file.

FileNameLength: (1 byte): This field contains the length of the **FileName** field, in bytes. [<154>](#)

FileName: (variable): This field contains the name of the file. [<155>](#)

2.2.8.1.4 SMB_FIND_FILE_DIRECTORY_INFO

This information level structure is used in [TRANS2_FIND_FIRST2 \(section 2.2.6.2\)](#) and [TRANS2_FIND_NEXT2 \(section 2.2.6.3\)](#) responses to return the following information for all files that match the request's search criteria:

- 64-bit versions of creation, access, and last write timestamps
- 64-bit version of file size
- Extended file attributes

- File name

```
SMB_FIND_FILE_DIRECTORY_INFO[SearchCount]
{
    ULONG             NextEntryOffset;
    ULONG             FileIndex;
    FILETIME          CreationTime;
    FILETIME          LastAccessTime;
    FILETIME          LastWriteTime;
    FILETIME          LastAttrChangeTime;
    LARGE_INTEGER     EndOfFile;
    LARGE_INTEGER     AllocationSize;
    SMB_EXT_FILE_ATTR ExtFileAttributes;
    ULONG             FileNameLength;
    SMB_STRING        FileName;
}
```

NextEntryOffset: (4 bytes): This field contains the offset, in bytes, from this entry in the list to the next entry in the list. If there are no additional entries the value MUST be zero (0x00000000).

FileIndex: (4 bytes): This field SHOULD<156> be set to zero when sent in a response and SHOULD be ignored when received by the client.

CreateTime: (8 bytes): This field contains the date and time when the file was created.

LastAccessTime: (8 bytes): This field contains the date and time when the file was last accessed.

LastWriteTime: (8 bytes): This field contains the date and time when data was last written to the file.

LastAttrChangeTime: (8 bytes): This field contains the date and time when the file attributes where last changed.

EndOfFile: (8 bytes): This field contains the offset, in bytes, to the start of the file to the first byte after the end of the file.

AllocationSize: (8 bytes): This field contains the file allocation size, in bytes. Usually, this value is a multiple of the sector or cluster size of the underlying physical device.

ExtFileAttributes: (4 bytes): This field contains the extended file attributes of the file, encoded as an [SMB_EXT_FILE_ATTR \(section 2.2.1.2.3\)](#) data type.

FileNameLength: (4 bytes): This field contains the length of the **FileName** field, in bytes.<157>

FileName: (variable): This field contains the name of the file.<158>

2.2.8.1.5 SMB_FIND_FILE_FULL_DIRECTORY_INFO

This information level structure is used in [TRANS2_FIND_FIRST2 \(section 2.2.6.2\)](#) and [TRANS2_FIND_NEXT2 \(section 2.2.6.3\)](#) responses to return the [SMB_FIND_FILE_DIRECTORY_INFO \(section 2.2.8.1.4\)](#) data along with the size of a file's extended attributes (EAs) list for all files that match the request's search criteria.

```

SMB_FIND_FILE_FULL_DIRECTORY_INFO[SearchCount]
{
    ULONG             NextEntryOffset;
    ULONG             FileIndex;
    FILETIME          CreationTime;
    FILETIME          LastAccessTime;
    FILETIME          LastWriteTime;
    FILETIME          LastAttrChangeTime;
    LARGE_INTEGER     EndOfFile;
    LARGE_INTEGER     AllocationSize;
    SMB_EXT_FILE_ATTR ExtFileAttributes;
    ULONG             FileNameLength;
    ULONG             EaSize;
    SMB_STRING        FileName;
}

```

NextEntryOffset: (4 bytes): This field contains the offset, in bytes, from this entry in the list to the next entry in the list. If there are no additional entries, the value **MUST** be zero (0x00000000).

FileIndex: (4 bytes): This field **SHOULD** <159> be set to zero when sent in a response and **SHOULD** be ignored when received by the client.

CreationTime: (8 bytes): This field contains the date and time when the file was created.

LastAccessTime: (8 bytes): This field contains the date and time when the file was last accessed.

LastWriteTime: (8 bytes): This field contains the date and time when data was last written to the file.

LastAttrChangeTime: (8 bytes): This field contains the date and time when the file attributes were last changed.

EndOfFile: (8 bytes): This field contains the offset, in bytes, from the start of the file to the first byte after the end of the file.

AllocationSize: (8 bytes): This field contains the file allocation size, in bytes. Usually, this value is a multiple of the sector or cluster size of the underlying physical device.

ExtFileAttributes: (4 bytes): This field contains the extended file attributes of the file, encoded as an [SMB_EXT_FILE_ATTR \(section 2.2.1.2.3\)](#) data type.

FileNameLength: (4 bytes): This field contains the length of the **FileName** field, in bytes. <160>

EaSize: (4 bytes): This field contains the size of the file's extended attribute (EA) information, in bytes.

FileName: (variable): This field contains the name of the file. <161>

2.2.8.1.6 SMB_FIND_FILE_NAMES_INFO

This information level structure is used in [TRANS2_FIND_FIRST2 \(section 2.2.6.2\)](#) and [TRANS2_FIND_NEXT2 \(section 2.2.6.3\)](#) responses to return the file name for all files that match the request's search criteria.

```
SMB_FIND_FILE_NAMES_INFO[SearchCount]
{
    ULONG      NextEntryOffset;
    ULONG      FileIndex;
    ULONG      FileNameLength;
    SMB_STRING FileName;
}
```

NextEntryOffset: (4 bytes): This field contains the offset, in bytes, from this entry in the list to the next entry in the list. If there are no additional entries, the value MUST be zero (0x00000000).

FileIndex: (4 bytes): This field SHOULD [<162>](#) be set to zero when sent in a response and SHOULD be ignored when received by the client.

FileNameLength: (4 bytes): This field MUST contain the length of the **FileName** field, in bytes. [<163>](#)

FileName: (variable): This field contains the name of the file. [<164>](#)

2.2.8.1.7 SMB_FIND_FILE_BOTH_DIRECTORY_INFO

This information level structure is used in [TRANS2_FIND_FIRST2 \(section 2.2.6.2\)](#) and [TRANS2_FIND_NEXT2 \(section 2.2.6.3\)](#) responses to return a combination of the SMB_FILE_FULL_DIRECTORY_INFO and [SMB_FIND_FILE_NAMES_INFO \(section 2.2.8.1.6\)](#) data for all files that match the request's search criteria.

```
SMB_FIND_FILE_BOTH_DIRECTORY_INFO[SearchCount]
{
    ULONG      NextEntryOffset;
    ULONG      FileIndex;
    FILETIME   CreationTime;
    FILETIME   LastAccessTime;
    FILETIME   LastWriteTime;
    FILETIME   LastChangeTime;
    LARGE_INTEGER EndOfFile;
    LARGE_INTEGER AllocationSize;
    SMB_EXT_FILE_ATTR ExtFileAttributes;
    ULONG      FileNameLength;
    ULONG      EaSize;
    UCHAR      ShortNameLength;
    UCHAR      Reserved;
    WCHAR      ShortName[12];
    SMB_STRING  FileName;
}
```

NextEntryOffset: (4 bytes): This field contains the offset, in bytes, from this entry in the list to the next entry in the list. If there are no additional entries the value MUST be zero (0x00000000).

FileIndex: (4 bytes): This field SHOULD [<165>](#) be set to zero when sent in a response and SHOULD be ignored when received by the client.

CreationTime: (8 bytes): This field contains the date and time when the file was created.

LastAccessTime: (8 bytes): This field contains the date and time when the file was last accessed.

LastWriteTime: (8 bytes): This field contains the date and time when data was last written to the file.

LastChangeTime: (8 bytes): This field contains the date and time when the file was last changed.

EndOfFile: (8 bytes): The absolute new end-of-file position as a byte offset from the start of the file. **EndOfFile** specifies the byte offset to the end of the file. Because this value is zero-based, it actually refers to the first free byte in the file. In other words, **EndOfFile** is the offset to the byte immediately following the last valid byte in the file.

AllocationSize: (8 bytes): This field contains the file allocation size, in bytes. Usually, this value is a multiple of the sector or cluster size of the underlying physical device.

ExtFileAttributes: (4 bytes): This field contains the extended file attributes of the file, encoded as an [SMB_EXT_FILE_ATTR \(section 2.2.1.2.3\)](#) data type.

FileNameLength: (4 bytes): This field MUST contain the length of the **FileName** field, in bytes. [<166>](#)

EaSize: (4 bytes): This field MUST contain the length of the **FEAList**, in bytes.

ShortNameLength: (1 byte): This field MUST contain the length of the **ShortName**, in bytes.

Reserved: (1 byte): This field is reserved and MUST be zero (0x00).

ShortName: (24 bytes): This field MUST contain the 8.3 name of the file in Unicode format.

FileName: (variable): This field contains the long name of the file. [<167>](#)

2.2.8.2 QUERY_FS Information Levels

2.2.8.2.1 SMB_INFO_ALLOCATION

This information level structure is used in [TRANS2_QUERY_FS_INFORMATION Responses \(section 2.2.6.4.2\)](#) to return allocation and size information of the object store underlying the share specified in the request.

```
SMB_INFO_ALLOCATION
{
    ULONG   idFileSystem;
    ULONG   cSectorUnit;
    ULONG   cUnit;
    ULONG   cUnitAvailable;
    USHORT  cbSector;
}
```

idFileSystem: (4 bytes): This field contains a file system identifier. [<168>](#)

cSectorUnit: (4 bytes): This field contains the number of sectors per allocation unit.

cUnit: (4 bytes): This field contains the total number of allocation units.

cUnitAvailable: (4 bytes): This field contains the total number of available allocation units.

cbSector: (2 bytes): This field contains the number of bytes per sector.

2.2.8.2.2 SMB_INFO_VOLUME

This information level structure is used in [TRANS2_QUERY_FS_INFORMATION Responses \(section 2.2.6.4.2\)](#) to return volume information of the object store underlying the share specified in the request.

```
SMB_INFO_VOLUME
{
    ULONG        ulVolSerialNbr;
    UCHAR        cCharCount;
    SMB_STRING   VolumeLabel;
}
```

ulVolSerialNbr: (4 bytes): This field contains the serial number of the volume.

cCharCount: (1 byte): This field contains the number of characters in the **VolumeLabel** field.

VolumeLabel: (variable): This field contains the volume label. [<169>](#)

2.2.8.2.3 SMB_QUERY_FS_VOLUME_INFO

This information level structure is used in [TRANS2_QUERY_FS_INFORMATION Responses \(section 2.2.6.4.2\)](#) to return extended volume information of the object store underlying the share specified in the request. [<170>](#)

```
SMB_QUERY_FS_VOLUME_INFO
{
    FILETIME   VolumeCreationTime;
    ULONG      SerialNumber;
    ULONG      VolumeLabelSize;
    USHORT     Reserved;
    WCHAR      VolumeLabel[VolumeLabelSize/2];
}
```

VolumeCreationTime: (8 bytes): This field contains the date and time when the volume was created.

SerialNumber: (4 bytes): This field contains the serial number of the volume.

VolumeLabelSize: (4 bytes): This field contains the size of the **VolumeLabel** field, in bytes.

VolumeLabel: (variable): This field contains the Unicode-encoded volume label.

2.2.8.2.4 SMB_QUERY_FS_SIZE_INFO

This information level structure is used in [TRANS2_QUERY_FS_INFORMATION Responses \(section 2.2.6.4.2\)](#) to return extended allocation and size information of the object store underlying the share specified in the request. [<171>](#)

```
SMB_QUERY_FS_SIZE_INFO
{
    LARGE_INTEGER TotalAllocationUnits;
    LARGE_INTEGER TotalFreeAllocationUnits;
    ULONG         SectorsPerAllocationUnit;
    ULONG         BytesPerSector;
}
```

TotalAllocationUnits: (8 bytes): This field contains the total number of allocation units assigned to the volume.

TotalFreeAllocationUnits: (8 bytes): This field contains the total number of unallocated or free allocation units for the volume.

SectorsPerAllocationUnit: (4 bytes): This field contains the number of sectors per allocation unit.

BytesPerSector: (4 bytes): This field contains the bytes per sector.

2.2.8.2.5 SMB_QUERY_FS_DEVICE_INFO

This information level structure is used in [TRANS2_QUERY_FS_INFORMATION Responses \(section 2.2.6.4.2\)](#) to return device information of the object store underlying the share specified in the request. <172>

```
SMB_QUERY_FS_DEVICE_INFO
{
    ULONG DeviceType;
    ULONG DeviceCharacteristics;
}
```

DeviceType: (4 bytes): This field contains the device type on which the volume resides.

Name	Value
FILE_DEVICE_BEEP	0x0001
FILE_DEVICE_CD_ROM	0x0002
FILE_DEVICE_CD_ROM_FILE_SYSTEM	0x0003
FILE_DEVICE_CONTROLLER	0x0004
FILE_DEVICE_DATA_LINK	0x0005
FILE_DEVICE_DFS	0x0006
FILE_DEVICE_DISK	0x0007
FILE_DEVICE_DISK_FILE_SYSTEM	0x0008
FILE_DEVICE_FILE_SYSTEM	0x0009
FILE_DEVICE_INPORT_PORT	0x000a

Name	Value
FILE_DEVICE_KEYBOARD	0x000b
FILE_DEVICE_MAILSLOT	0x000c
FILE_DEVICE_MIDI_IN	0x000d
FILE_DEVICE_MIDI_OUT	0x000e
FILE_DEVICE_MOUSE	0x000f
FILE_DEVICE_MULTI_UNC_PROVIDER	0x0010
FILE_DEVICE_NAMED_PIPE	0x0011
FILE_DEVICE_NETWORK	0x0012
FILE_DEVICE_NETWORK_BROWSER	0x0013
FILE_DEVICE_NETWORK_FILE_SYSTEM	0x0014
FILE_DEVICE_NULL	0x0015
FILE_DEVICE_PARALLEL_PORT	0x0016
FILE_DEVICE_PHYSICAL_NETCARD	0x0017
FILE_DEVICE_PRINTER	0x0018
FILE_DEVICE_SCANNER	0x0019
FILE_DEVICE_SERIAL_MOUSE_PORT	0x001a
FILE_DEVICE_SERIAL_PORT	0x001b
FILE_DEVICE_SCREEN	0x001c
FILE_DEVICE_SOUND	0x001d
FILE_DEVICE_STREAMS	0x001e
FILE_DEVICE_TAPE	0x001f
FILE_DEVICE_TAPE_FILE_SYSTEM	0x0020
FILE_DEVICE_TRANSPORT	0x0021
FILE_DEVICE_UNKNOWN	0x0022
FILE_DEVICE_VIDEO	0x0023
FILE_DEVICE_VIRTUAL_DISK	0x0024
FILE_DEVICE_WAVE_IN	0x0025
FILE_DEVICE_WAVE_OUT	0x0026
FILE_DEVICE_8042_PORT	0x0027
FILE_DEVICE_NETWORK_REDIRECTOR	0x0028

Name	Value
FILE_DEVICE_BATTERY	0x0029
FILE_DEVICE_BUS_EXTENDER	0x002a
FILE_DEVICE_MODEM	0x002b
FILE_DEVICE_VDM	0x002c

DeviceCharacteristics: (4 bytes): This 32-bit field of flags contains the device characteristics. The individual flags are as follows.

Name	Bitmask
FILE_REMOVABLE_MEDIA	0x0001
FILE_READ_ONLY_DEVICE	0x0002
FILE_FLOPPY_DISKETTE	0x0004
FILE_WRITE_ONCE_MEDIA	0x0008
FILE_REMOTE_DEVICE	0x0010
FILE_DEVICE_IS_MOUNTED	0x0020
FILE_VIRTUAL_VOLUME	0x0040

2.2.8.2.6 SMB_QUERY_FS_ATTRIBUTE_INFO

This information level is used to query file system attributes. <173>

FileSystemAttributes: (4 bytes): This 32-bit field of flags contains the file system's attributes. The individual flags are as follows.

Name	Bitmask
FILE_CASE_SENSITIVE_SEARCH	0x00000001
FILE_CASE_PRESERVED_NAMES	0x00000002
FILE_UNICODE_ON_DISK	0x00000004
FILE_PERSISTENT_ACLS	0x00000008
FILE_FILE_COMPRESSION	0x00000010
FILE_VOLUME_IS_COMPRESSED	0x00008000

MaxFileNameLengthInBytes: (4 bytes): This field contains the maximum size, in bytes, of a file name on the file system.

LengthOfFileSystemName: (4 bytes): This field contains the size, in bytes, of the **FileSystemName** field.

FileSystemName: (variable): This field contains the Unicode-encoded name of the file system.

2.2.8.3 QUERY Information Levels

2.2.8.3.1 SMB_INFO_STANDARD

This information level structure is used in [TRANS2_QUERY_PATH_INFORMATION \(section 2.2.6.6\)](#) and [TRANS2_QUERY_FILE_INFORMATION \(section 2.2.6.8\)](#) responses to return the following information for the file specified in the request:

- Creation, access, and last write timestamps
- File size
- File attributes

```
SMB_INFO_STANDARD
{
    SMB_DATE      CreationDate;
    SMB_TIME      CreationTime;
    SMB_DATE      LastAccessDate;
    SMB_TIME      LastAccessTime;
    SMB_DATE      LastWriteDate;
    SMB_TIME      LastWriteTime;
    ULONG         FileDataSize;
    ULONG         AllocationSize;
    SMB_FILE_ATTRIBUTES Attributes;
}
```

CreationDate: (2 bytes): This field contains the date when the file was created.

CreationTime: (2 bytes): This field contains the time when the file was created.

LastAccessDate: (2 bytes): This field contains the date when the file was last accessed.

LastAccessTime: (2 bytes): This field contains the time when the file was last accessed.

LastWriteDate: (2 bytes): This field contains the date when data was last written to the file.

LastWriteTime: (2 bytes): This field contains the time when data was last written to the file.

FileDataSize: (4 bytes): This field contains the file size, in filesystem allocation units.

AllocationSize: (4 bytes): This field contains the size of the filesystem allocation unit, in bytes.

Attributes: (2 bytes): This field contains the file attributes.

2.2.8.3.2 SMB_INFO_QUERY_EA_SIZE

This information level structure is used in [TRANS2_QUERY_PATH_INFORMATION \(section 2.2.6.6\)](#) and [TRANS2_QUERY_FILE_INFORMATION \(section 2.2.6.8\)](#) responses to return the [SMB_INFO_STANDARD \(section 2.2.8.3.1\)](#) data along with the size of a file's extended attributes (EAs) list for the file specified in the request.

```
SMB_INFO_QUERY_EA_SIZE
{
```

```

SMB_DATE      CreationDate;
SMB_TIME      CreationTime;
SMB_DATE      LastAccessDate;
SMB_TIME      LastAccessTime;
SMB_DATE      LastWriteDate;
SMB_TIME      LastWriteTime;
ULONG         FileDataSize;
ULONG         AllocationSize;
SMB_FILE_ATTRIBUTES Attributes;
ULONG         EaSize;
}

```

CreationDate: (2 bytes): This field contains the date when the file was created.

CreationTime: (2 bytes): This field contains the time when the file was created.

LastAccessDate: (2 bytes): This field contains the date when the file was last accessed.

LastAccessTime: (2 bytes): This field contains the time when the file was last accessed.

LastWriteDate : (2 bytes): This field contains the date when data was last written to the file.

LastWriteTime: (2 bytes): This field contains the time when data was last written to the file.

FileDataSize: (4 bytes): This field contains the file size, in filesystem allocation units.

AllocationSize: (4 bytes): This field contains the size of the filesystem allocation unit, in bytes.

Attributes: (2 bytes): This field contains the file attributes.

EaSize: (4 bytes): This field contains the size of the file's extended attribute (EA) information in bytes.

2.2.8.3.3 SMB_INFO_QUERY_EAS_FROM_LIST

This information level structure is used in [TRANS2_QUERY_PATH_INFORMATION \(section 2.2.6.6\)](#) and [TRANS2_QUERY_FILE_INFORMATION \(section 2.2.6.8\)](#) responses to return a list of specific extended attributes (EAs) on the file specified in the request. The requested EAs are provided in the **Trans2_Data** block of the request.

```

SMB_INFO_QUERY_EAS_FROM_LIST
{
    SMB_FEA_LIST ExtendedAttributeList;
}

```

ExtendedAttributeList: (variable): A list of extended attribute (EA) name/value pairs where the **AttributeName** field values match those that were provided in the request.

2.2.8.3.4 SMB_INFO_QUERY_ALL_EAS

This information level structure is used in [TRANS2_QUERY_PATH_INFORMATION \(section 2.2.6.6\)](#) and [TRANS2_QUERY_FILE_INFORMATION \(section 2.2.6.8\)](#) responses to return a list of specific extended attributes (EAs) on the file specified in the request.

```
SMB_INFO_QUERY_ALL_EAS
{
    SMB_FEA_LIST ExtendedAttributeList;
}
```

ExtendedAttributeList: (variable): A list of all of the extended attribute (EA) name/value pairs assigned to the file.

2.2.8.3.5 SMB_INFO_IS_NAME_VALID

This **information level** enables a server test as to whether the name of the file contained in the **Request.Trans2_Parameters.FileName** field has valid path syntax. This information level is valid only for the TRANS2_QUERY_PATH_INFORMATION subcommand. No parameters or data are returned on this **InformationLevel** request. An error is returned if the syntax of the name is incorrect. Success indicates that the server accepts the path syntax, but it does not ensure that the file or directory actually exists.

2.2.8.3.6 SMB_QUERY_FILE_BASIC_INFO

This information level structure is used in [TRANS2_QUERY_PATH_INFORMATION \(section 2.2.6.6\)](#) and [TRANS2_QUERY_FILE_INFORMATION \(section 2.2.6.8\)](#) responses to return the following information for the file specified in the request: [<174>](#)

- 64-bit versions of creation, access, and last write timestamps
- Extended file attributes

```
SMB_QUERY_FILE_BASIC_INFO
{
    FILETIME      CreationTime;
    FILETIME      LastAccessTime;
    FILETIME      LastWriteTime;
    FILETIME      LastChangeTime;
    SMB_EXT_FILE_ATTR ExtFileAttributes;
    ULONG         Reserved;
}
```

CreationTime: (8 bytes): This field contains the date and time when the file was created.

LastAccessTime: (8 bytes): This field contains the date and time when the file was last accessed.

LastWriteTime: (8 bytes): This field contains the date and time when data was last written to the file.

LastChangeTime: (8 bytes): This field contains the date and time when the file was last changed.

ExtFileAttributes: (4 bytes): This field contains the extended file attributes of the file, encoded as an [SMB_EXT_FILE_ATTR \(section 2.2.1.2.3\)](#) data type.

Reserved: (4 bytes): MUST be set to zero when sent and MUST be ignored on receipt.

2.2.8.3.7 SMB_QUERY_FILE_STANDARD_INFO

This information level structure is used in [TRANS2_QUERY_PATH_INFORMATION \(section 2.2.6.6\)](#) and [TRANS2_QUERY_FILE_INFORMATION \(section 2.2.6.8\)](#) responses to return the following information for the file specified in the request. <175>

- 64-bit version of file size
- Number of hard links on the file
- Deletion status
- Whether the **FID** field in the request points to a directory

```
SMB_QUERY_FILE_STANDARD_INFO
{
    LARGE_INTEGER AllocationSize;
    LARGE_INTEGER EndOfFile;
    ULONG         NumberOfLinks;
    UCHAR         DeletePending;
    UCHAR         Directory;
}
```

Allocation Size: (8 bytes): This field contains the number of bytes that are allocated to the file.

EndOfFile: (8 bytes): This field contains the offset, in bytes, from the start of the file to the first byte after the end of the file.

NumberOfLinks: (4 bytes): This field contains the number of hard links to the file.

DeletePending: (1 byte): This field indicates whether there is a delete action pending for the file.

Directory: (1 byte): This field indicates whether the file is a directory.

2.2.8.3.8 SMB_QUERY_FILE_EA_INFO

This information level structure is used in [TRANS2_QUERY_PATH_INFORMATION \(section 2.2.6.6\)](#) and [TRANS2_QUERY_FILE_INFORMATION \(section 2.2.6.8\)](#) responses to return the size of a file's extended attributes (EAs) list for the file specified in the request. <176>

```
SMB_QUERY_FILE_EA_INFO
{
    ULONG EaSize;
}
```

EaSize: (4 bytes): This field MUST contain the length of a file's list of extended attributes in bytes.

2.2.8.3.9 SMB_QUERY_FILE_NAME_INFO

This information level structure is used in [TRANS2_QUERY_PATH_INFORMATION \(section 2.2.6.6\)](#) and [TRANS2_QUERY_FILE_INFORMATION \(section 2.2.6.8\)](#) responses to return the Unicode-formatted long file name of the file specified in the request. <177>

```
SMB_QUERY_FILE_NAME_INFO
{
    ULONG FileNameLength;
    WCHAR FileName[FileNameLength/2];
}
```

FileNameLength: (4 bytes): This field MUST contain the length of the **FileName** field in bytes.

FileName: (variable): This field contains the name of the file.

2.2.8.3.10 SMB_QUERY_FILE_ALL_INFO

This information level structure is used in [TRANS2_QUERY_PATH_INFORMATION \(section 2.2.6.6\)](#) and [TRANS2_QUERY_FILE_INFORMATION \(section 2.2.6.8\)](#) responses to return the [SMB_QUERY_FILE_BASIC_INFO](#), [SMB_FILE_QUERY_STANDARD_INFO](#), [SMB_FILE_EA_INFO](#), and [SMB_QUERY_FILE_NAME_INFO](#) data as well as access flags, access mode, and alignment information in a single request for the file specified in the request.

```
SMB_QUERY_FILE_ALL_INFO
{
    FILETIME      CreationTime;
    FILETIME      LastAccessTime;
    FILETIME      LastWriteTime;
    FILETIME      LastChangeTime;
    SMB_EXT_FILE_ATTR ExtFileAttributes;
    ULONG         Reserved1;
    LARGE_INTEGER AllocationSize;
    LARGE_INTEGER EndOfFile;
    ULONG         NumberOfLinks;
    UCHAR         DeletePending;
    UCHAR         Directory;
    USHORT        Reserved2;
    ULONG         EaSize;
    ULONG         FileNameLength;
    WCHAR         FileName[FileNameLength/2];
}
```

CreationTime: (8 bytes): This field contains the date and time when the file was created.

LastAccessTime: (8 bytes): This field contains the date and time when the file was last accessed.

LastWriteTime: (8 bytes): This field contains the date and time when data was last written to the file.

LastChangeTime: (8 bytes): This field contains the date and time when the file was last changed.

ExtFileAttributes: (4 bytes): This field contains the extended file attributes of the file, encoded as an [SMB_EXT_FILE_ATTR \(section 2.2.1.2.3\)](#) data type.

Reserved1: (4 bytes): Reserved. This field SHOULD be set to 0x00000000 by the server and MUST be ignored by the client.

AllocationSize: (8 bytes): This field contains the number of bytes that are allocated to the file.

EndOfFile: (8 bytes): This field contains the offset, in bytes, from the start of the file to the first byte after the end of the file.

NumberOfLinks: (4 bytes): This field contains the number of hard links to the file.

DeletePending: (1 byte): This field indicates whether there is a delete action pending for the file.

Directory: (1 byte): This field indicates whether the file is a directory.

Reserved2: (2 bytes): Reserved. This field SHOULD be set to 0x0000 by the server and MUST be ignored by the client.

EaSize: (4 bytes): This field MUST contain the length of a file's list of extended attributes in bytes.

FileNameLength: (4 bytes): This field MUST contain the length, in bytes, of the **FileName** field.

FileName: (variable): This field contains the name of the file.

2.2.8.3.11 SMB_QUERY_FILE_ALT_NAME_INFO

This information level structure is used in [TRANS2_QUERY_PATH_INFORMATION \(section 2.2.6.6\)](#) and [TRANS2_QUERY_FILE_INFORMATION \(section 2.2.6.8\)](#) responses to return the 8.3 format file name of the file in the request. <178>

```
SMB_QUERY_FILE_ALT_NAME_INFO
{
    ULONG FileNameLength;
    WCHAR FileName[FileNameLength/2];
}
```

FileNameLength: (4 bytes): This field contains the length, in bytes, of the **FileName** field.

FileName: (variable): This field contains the 8.3 name of the file in Unicode. The string is not null-terminated.

2.2.8.3.12 SMB_QUERY_FILE_STREAM_INFO

This information level structure is used in [TRANS2_QUERY_PATH_INFORMATION \(section 2.2.6.6\)](#) and [TRANS2_QUERY_FILE_INFORMATION \(section 2.2.6.8\)](#) responses to return the stream information for the file in the request. <179>

```
SMB_QUERY_FILE_STREAM_INFO
{
    ULONG NextEntryOffset;
    ULONG StreamNameLength;
    LARGE_INTEGER StreamSize;
    LARGE_INTEGER StreamAllocationSize;
    WCHAR StreamName[StreamNameLength/2];
}
```

NextEntryOffset: (4 bytes): A 32-bit unsigned integer that contains the byte offset from the beginning of this entry, at which the next FILE_STREAM_INFORMATION entry is located, if multiple entries are present in a buffer. This member is 0x00000000 if no other entries follow this one. An implementation MUST use this value to determine the location of the next entry (if multiple entries are present in a buffer) and MUST NOT assume that the value of **NextEntryOffset** is the same as the size of the current entry.

StreamNameLength: (4 bytes): A 32-bit unsigned integer that contains the length, in bytes, of the stream name string.

StreamSize: (8 bytes): A 64-bit signed integer that contains the size, in bytes, of the stream. The value of this field MUST be greater than or equal to 0x0000000000000000.

StreamAllocationSize: (8 bytes): A 64-bit signed integer that contains the file stream allocation size in bytes. Usually, this value is a multiple of the sector or cluster size of the underlying physical device. The value of this field MUST be greater than or equal to 0x0000000000000000.

StreamName: (variable): A sequence of Unicode characters containing the name of the stream using the form ":streamname:\$DATA", or "::\$DATA" for the default stream. The :\$DATA string that follows **streamname** is an internal data type tag that is unintentionally exposed. The leading ':' and trailing '::\$DATA' characters are not part of the stream name and MUST be stripped from this field to derive the actual stream name. A resulting empty string for the stream name denotes the default stream. Because this field might not be null-terminated, it MUST be handled as a sequence of **StreamNameLength** bytes.

2.2.8.3.13 SMB_QUERY_FILE_COMPRESSION_INFO

This information level structure is used in [TRANS2_QUERY_PATH_INFORMATION \(section 2.2.6.6\)](#) and [TRANS2_QUERY_FILE_INFORMATION \(section 2.2.6.8\)](#) responses to return the compression information for the file in the request. <180>

```
SMB_QUERY_FILE_COMPRESSION_INFO
{
    LARGE_INTEGER CompressedFileSize;
    USHORT        CompressionFormat;
    UCHAR         CompressionUnitShift;
    UCHAR         ChunkShift;
    UCHAR         ClusterShift;
    UCHAR         Reserved[3];
}
```

CompressedFileSize: (8 bytes): A 64-bit signed integer that contains the size, in bytes, of the compressed file. This value MUST be greater than or equal to 0x0000000000000000.

CompressionFormat: (2 bytes): A 16-bit unsigned integer that contains the compression format. The actual compression operation associated with each of these compression format values is implementation-dependent. An implementation can associate any local compression algorithm with the values described in the following table, because the compressed data does not travel across the wire in the context of this transaction. The following compression formats are valid only for NTFS.

Name and bitmask	Meaning
COMPRESSION_FORMAT_NONE 0x0000	The file or directory is not compressed.
COMPRESSION_FORMAT_DEFAULT 0x0001	The file or directory is compressed by using the default compression algorithm.
COMPRESSION_FORMAT_LZNT1 0x0002	The file or directory is compressed by using the LZNT1 compression algorithm.
All other values	Reserved for future use.

CompressionUnitShift: (1 byte): An 8-bit unsigned integer that contains the compression unit shift that is the number of bits by which to left-shift a 1 bit to arrive at the compression unit size. The compression unit size is the number of bytes in a compression unit, that is, the number of bytes to be compressed. This value is implementation-defined.

ChunkShift: (1 byte): An 8-bit unsigned integer that contains the compression chunk size in bytes in log 2 format. The chunk size is the number of bytes that the operating system's implementation of the Lempel-Ziv compression algorithm tries to compress at one time. This value is implementation-defined.

ClusterShift: (1 byte): An 8-bit unsigned integer that specifies, in log 2 format, the amount of space that MUST be saved by compression to successfully compress a compression unit. If that amount of space is not saved by compression, the data in that compression unit MUST be stored uncompressed. Each successfully compressed compression unit MUST occupy at least one cluster that is less in bytes than an uncompressed compression unit. Therefore, the cluster shift is the number of bits by which to left shift a 1 bit to arrive at the size of a cluster. This value is implementation-defined.

Reserved: (3 bytes): A 24-bit reserved value. This field SHOULD be set to 0x000000 and MUST be ignored.

2.2.8.4 SET Information levels

2.2.8.4.1 SMB_INFO_STANDARD

This information level structure is used in [TRANS2_SET_PATH_INFORMATION \(section 2.2.6.7\)](#) and [TRANS2_SET_FILE_INFORMATION \(section 2.2.6.9\)](#) requests to set timestamp information for the file specified in the request

```
SMB_INFO_STANDARD
{
    SMB_DATE CreationDate;
    SMB_TIME CreationTime;
    SMB_DATE LastAccessDate;
    SMB_TIME LastAccessTime;
    SMB_DATE LastWriteDate;
    SMB_TIME LastWriteTime;
    UCHAR    Reserved[10];
}
```

CreationDate: (2 bytes): This field contains the date when the file was created.

CreationTime: (2 bytes): This field contains the time when the file was created.

LastAccessDate: (2 bytes): This field contains the date when the file was last accessed.

LastAccessTime: (2 bytes): This field contains the time when the file was last accessed.

LastWriteDate: (2 bytes): This field contains the date when data was last written to the file.

LastWriteTime: (2 bytes): This field contains the time when data was last written to the file.

Reserved: (10 bytes): MUST be set to zero when sent and MUST be ignored on receipt.

2.2.8.4.2 SMB_INFO_SET_EAS

This information level structure is used in [TRANS2_SET_PATH_INFORMATION \(section 2.2.6.7\)](#) and [TRANS2_SET_FILE_INFORMATION \(section 2.2.6.9\)](#) requests to set specific extended attribute (EA) information for the file specified in the request.

```
SMB_INFO_SET_EAS
{
    SMB_FEA_LIST ExtendedAttributeList;
}
```

ExtendedAttributeList: (variable): A list of EA name/value pairs.

2.2.8.4.3 SMB_SET_FILE_BASIC_INFO

This information level structure is used in [TRANS2_SET_FILE_INFORMATION \(section 2.2.6.9\)](#) requests to set the following information for the file specified in the request. [<181>](#)

- 64-bit versions of creation, access, and last write timestamps
- Extended file attributes

```
SMB_SET_FILE_BASIC_INFO
{
    FILETIME      CreationTime;
    FILETIME      LastAccessTime;
    FILETIME      LastWriteTime;
    FILETIME      ChangeTime;
    SMB_EXT_FILE_ATTR ExtFileAttributes;
    ULONG         Reserved;
}
```

CreationTime: (8 bytes): A 64-bit unsigned integer that contains the time when the file was created. A valid time for this field is an integer greater than 0x0000000000000000. When setting file attributes, a value of 0x0000000000000000 indicates to the server that it MUST NOT change this attribute. When setting file attributes, a value of -1 (0xFFFFFFFFFFFFFFFF) indicates to the server that it MUST NOT change this attribute for all subsequent operations on the same file handle. This field MUST NOT be set to a value less than -1 (0xFFFFFFFFFFFFFFFF).

LastAccessTime: (8 bytes): A 64-bit unsigned integer that contains the last time that the file was accessed, in the format of a **FILETIME** structure. A valid time for this field is an integer greater than 0x0000000000000000. When setting file attributes, a value of

0x0000000000000000 indicates to the server that it MUST NOT change this attribute. When setting file attributes, a value of -1 (0xFFFFFFFFFFFFFFFF) indicates to the server that it MUST NOT change this attribute for all subsequent operations on the same file handle. This field MUST NOT be set to a value less than -1 (0xFFFFFFFFFFFFFFFF).

LastWriteTime: (8 bytes): A 64-bit unsigned integer that contains the last time that information was written to the file, in the format of a **FILETIME** structure. A valid time for this field is an integer greater than 0x0000000000000000. When setting file attributes, a value of 0x0000000000000000 indicates to the server that it MUST NOT change this attribute. When setting file attributes, a value of -1 (0xFFFFFFFFFFFFFFFF) indicates to the server that it MUST NOT change this attribute for all subsequent operations on the same file handle. This field MUST NOT be set to a value less than -1 (0xFFFFFFFFFFFFFFFF).

ChangeTime: (8 bytes): A 64-bit unsigned integer that contains the last time that the file was changed, in the format of a **FILETIME** structure. A valid time for this field is an integer greater than 0x0000000000000000. When setting file attributes, a value of 0x0000000000000000 indicates to the server that it MUST NOT change this attribute. When setting file attributes, a value of -1 (0xFFFFFFFFFFFFFFFF) indicates to the server that it MUST NOT change this attribute for all subsequent operations on the same file handle. This field MUST NOT be set to a value less than -1 (0xFFFFFFFFFFFFFFFF).

ExtFileAttributes: (4 bytes): This field contains the extended file attributes of the file, encoded as an SMB_EXT_FILE_ATTR data type (section [2.2.1.2.3](#)).

Reserved: (4 bytes): A 32-bit reserved field that can be set to any value and MUST be ignored.

2.2.8.4.4 SMB_SET_FILE_DISPOSITION_INFO

This information level structure is used in [TRANS2_SET_FILE_INFORMATION \(section 2.2.6.9\)](#) requests to mark or unmark the file specified in the request for deletion. [<182>](#)

```
SMB_SET_FILE_DISPOSITION_INFO
{
    UCHAR DeletePending;
}
```

DeletePending: (1 byte): An 8-bit field that is set to 0x01 to indicate that a file SHOULD be deleted when it is closed; otherwise, to 0x00.

2.2.8.4.5 SMB_SET_FILE_ALLOCATION_INFO

This information level structure is used in [TRANS2_SET_FILE_INFORMATION \(section 2.2.6.9\)](#) requests to set allocation size information for the file specified in the request. [<183>](#)

```
SMB_SET_FILE_ALLOCATION_INFO
{
    LARGE_INTEGER AllocationSize;
}
```

AllocationSize: (8 bytes): A 64-bit signed integer containing the file allocation size, in bytes. Usually, this value is a multiple of the sector or cluster size of the underlying physical device. This value MUST be greater than or equal to 0x0000000000000000. All unused allocation (beyond EOF) is freed.

2.2.8.4.6 SMB_SET_FILE_END_OF_FILE_INFO

This information level structure is used in [TRANS2 SET FILE INFORMATION \(section 2.2.6.9\)](#) requests to set end-of-file information for the file specified in the request. [<184>](#)

```
SMB_SET_FILE_END_OF_FILE_INFO
{
    LARGE_INTEGER EndOfFile;
}
```

EndOfFile: (8 bytes): A 64-bit signed integer that contains the absolute new end-of-file position as a byte offset from the start of the file. **EndOfFile** specifies the offset from the beginning of the file to the byte following the last byte in the file. It is the offset from the beginning of the file at which new bytes appended to the file are to be written. The value of this field **MUST** be greater than or equal to 0x0000000000000000.

3 Protocol Details

3.1 Common Details

In the sections that follow, if an ADM element is not prepended with either Client. or Server., it represents each entity's respective ADM element of the same name. Only ADM elements that share a common name and scope between both Client and Server ADMs are presented in this way.

3.1.1 Abstract Data Model

This section specifies a conceptual model of possible data organization that an implementation maintains to participate in this protocol. The described organization is provided to explain how the protocol behaves. This document does not mandate that implementations adhere to this model as long as their external behavior is consistent with what is described in this document.

3.1.1.1 Global

There are no global parameters defined as common to both client and server.

3.1.1.2 Timers

No timers are shared between the client and the server.

3.1.1.3 Initialization

No initialization is shared between the client and the server.

3.1.1.4 Higher-Layer Triggered Events

3.1.1.4.1 Sending Any Message

Unless otherwise stated, all SMB messages sent by the client and the server MUST comply with the following rules:

- SMB messages MUST be composed of three parts:
 - An **SMB_Header**, as specified in section [2.2.3.1](#).
 - An **SMB_Parameters** block, as specified in section [2.2.3.2](#).
 - An **SMB_Data** block, as specified in section [2.2.3.3](#).
- The **SMB_Header** MUST be included in full.
- At minimum, the **WordCount** field of the SMB Parameters block MUST be included. The remainder of the SMB_Parameters block MUST be two times **WordCount** bytes in length. If **WordCount** is 0x00, then zero parameter bytes MUST be included in the **SMB_Parameters** block.
- At minimum, the **ByteCount** field of the SMB_Data block MUST be included. The remainder of the SMB_Data block MUST be **ByteCount** bytes in length. If **ByteCount** is 0x0000, then zero data bytes MUST be included in the **SMB_Data** block.

Thus, the minimum size of an SMB message is 35 bytes. Section [2.2.3.1](#) lists required values for some SMB Header fields. See the individual command descriptions for specific per-message requirements.

If a message is sent and **IsSigningActive** is TRUE, the message MUST be signed.

This logic MUST be applied for messages sent in response to any of the higher-layer actions and in compliance with the message sequencing rules.

- The client or server that sends the message MUST provide the 32-bit sequence number for this message, as specified in sections [3.2.4.1](#) and [3.3.4.1](#).
- The SMB_FLAGS2_SMB_SECURITY_SIGNATURE flag in the header MUST be set.
- To generate the signature, a 32-bit sequence number is copied into the least significant 32 bits of the **SecuritySignature** field and the remaining 4 bytes are set to 0x00.
- The MD5 algorithm, as specified in [\[RFC1321\]](#), MUST be used to generate a hash of the SMB message from the start of the SMB Header, which is defined as follows.

```
CALL MD5Init( md5context )
CALL MD5Update( md5context, Connection.SigningSessionKey )
CALL MD5Update( md5context, Connection.SigningChallengeResponse )
CALL MD5Update( md5context, SMB message )
CALL MD5Final( digest, md5context )
SET signature TO the first 8 bytes of the digest
```

The resulting 8-byte signature MUST be copied into the **SecuritySignature** field of the SMB Header, after which the message can be transmitted.

3.1.4.1.1 Command Sequence Requirements

An SMB connection, a Protocol Negotiation, and an SMB session MUST be established before a message can be sent. That is:

- An SMB connection MUST be established before any messages can be sent.
- Following SMB connection establishment, an [SMB_COM_NEGOTIATE \(section 2.2.4.52\)](#) command MUST be used to establish the SMB dialect to be used before any other SMB command can be sent. Once a dialect has been negotiated, further SMB_COM_NEGOTIATE commands MUST NOT be executed on the connection. Any subsequent [SMB_COM_NEGOTIATE Request \(section 2.2.4.52.1\)](#) sent to the server on the same connection MUST be failed with an error code of STATUS_INVALID_SMB (ERRSRV/ERRerror).
- Unless otherwise noted, following a successful Protocol Negotiation an SMB_COM_SESSION_SETUP or [SMB_COM_SESSION_SETUP_ANDX \(section 2.2.4.53\)](#) command MUST be used to establish an SMB session before any other SMB commands are sent. Multiple SMB sessions can be set up per SMB connection.

3.1.5 Processing Events and Sequencing Rules

3.1.5.1 Receiving Any Message

If a message is received and **IsSigningActive** is TRUE, unless otherwise specified, the signature of the message MUST be verified by the client or the server receiving the message. See section [3.2.5.1](#) and [3.3.5.2](#), respectively.

This logic MUST be applied for any messages received, as defined in the message sequencing rules:

- The client or server that receives the message MUST save a temporary copy of the **SMB_Header.SecuritySignature** field of the received message.
- To test the signature, the expected 32-bit sequence number for the received message is copied into the least significant 32 bits of the **SecuritySignature** field, and the remaining 4 bytes of the **SecuritySignature** field are set to 0x00.
- The MD5 algorithm, as specified in [\[RFC1321\]](#), MUST be used to generate a hash of the SMB message (from the start of the SMB header), which is defined as follows.

```
CALL MD5Init( md5context )
CALL MD5Update( md5context, Connection.SigningSessionKey )
CALL MD5Update( md5context, Connection.SigningChallengeResponse )
CALL MD5Update( md5context, SMB message )
CALL MD5Final( digest, md5context )
SET signature TO first 8 bytes of digest
```

The resulting 8-byte signature is compared with the original value of the **SecuritySignature** field from the [SMB Header \(section 2.2.3.1\)](#). If the signature received with the message does not match the signature calculated, the message MUST be discarded, and no further processing is done on it. The receiver MAY also terminate the connection by disconnecting the underlying transport connection and cleaning up any state associated with the connection.

3.1.5.2 Algorithms for Challenge/Response Authentication

There are several challenge/response algorithms supported by CIFS for use with user authentication. Note that CIFS does not support the full protocol defined in [\[MS-NLMP\]](#); it makes use of the challenge/response algorithms only. CIFS does not support Extended Session Security because there is no mechanism in CIFS to negotiate Extended Session Security.

- **The LAN Manager (LM) Response**
- The LAN Manager (LM) response is computed using the DESL() operation defined in [\[MS-NLMP\]](#) Appendix A. Specifically:

```
LM_Hash = LMOWFv1( password );
LM_Response = DESL( LM_Hash, Challenge );
```

If the client is configured to send the LM response, it MUST be sent in the **OEMPassword** field of the SMB_COM_SESSION_SETUP_ANDX request. The LM response algorithm is described in [\[MS-NLMP\]](#) section 3.3.1.

- **The NT LAN Manager (NTLM) Response**

- The NT LAN Manager (NTLM) response is also computed using the DESL() operation defined in [MS-NLMP] Appendix A. Specifically:

```
NTLM_Hash = NTOWFv1( password );  
NTLM_Response = DESL( NTLM_Hash, Challenge );
```

If the client is configured to send the NTLM response, it MUST be sent in the **UnicodePassword** field of the SMB_COM_SESSION_SETUP_ANDX request. The NTLM response algorithm is described in [MS-NLMP] section 3.3.1.

- **LM v2 Authentication**

- When the client is configured to use LM v2 authentication, the LM responses are replaced with the LMv2 responses: <185>
 - The LMv2 response is specified in the calculation of LmChallengeResponse in [MS-NLMP] section 3.3.2.

- **NTLM v2 Authentication**

- When the client is configured to use NTLM v2 authentication, the NTLM responses are replaced with the NTLMv2 responses:
 - The NTLMv2 response is specified in the calculation of NtChallengeResponse in [MS-NLMP] section 3.3.2.

3.1.6 Timer Events

There are no timers common to both client and server.

3.1.7 Other Local Events

There are no local events common to both client and server.

3.2 Client Details

3.2.1 Abstract Data Model

This section specifies a conceptual model of possible data organization that an implementation maintains to participate in this protocol. The described organization is provided to explain how the protocol behaves. This document does not mandate that implementations adhere to this model as long as their external behavior is consistent with what is described in this document.

All ADM elements maintained by the client are prefixed with "**Client**".

3.2.1.1 Global

The following ADM elements are globally maintained for an individual client:

Client.SupportDialects: A list of client-supported dialect identifiers in order of preference from least to most preferred.

Client.ConnectionTable: A list of SMB connections to servers, as defined in section 3.2.1.2. The list MUST allow lookups based on **Client.Connection.ServerName**.

Client.LMAuthenticationPolicy: A state that determines the LAN Manager challenge/response authentication mechanism to be used. The following options are available:

- **Disabled:** LAN Manager challenge/response authentication (LM) is disabled.
The client MUST NOT return either an LM or LMv2 response.
- **V1-Enabled:** LAN Manager challenge/response authentication (LM) is enabled.
If the server supports challenge/response authentication, the client MUST calculate and send the LM response.
- **V2-Enabled:** LAN Manager v2 challenge/response authentication (LMv2) is enabled.
If the server supports challenge/response authentication, the client MUST calculate and send the LMv2 response.

Client.MaxBufferSize: The size, in bytes, of the largest SMB message that the client can receive.

Client.MessageSigningPolicy: A state that determines whether this node signs messages. This parameter has three possible values:

- **Required:** Message signing is required. Any connection to a server node that does not use signing MUST be disconnected.
- **Enabled:** Message signing is enabled. If the server enables or requires signing, signing MUST be used. [<186>](#)
- **Disabled:** Message signing is disabled. Message signing MUST NOT be used.

Client.NTLMAuthenticationPolicy: A state that determines the NT LAN Manager challenge/response authentication mechanism to be used. The following options are available:

- **Disabled:** NT LAN Manager challenge/response authentication (NTLM) is disabled.
The client MUST NOT return either an NTLM or NTLMv2 response.
- **V1-Enabled:** NT LAN Manager challenge/response authentication (NTLM) is enabled.
If the server supports challenge/response authentication, the client MUST calculate and send the NTLM response.
- **V2-Enabled:** NT LAN Manager v2 challenge/response authentication (NTLMv2) is enabled.
If the server supports challenge/response authentication, the client MUST calculate and send the NTLMv2 response.

If **Client.LMAuthenticationPolicy** and **Client.NTLMAuthenticationPolicy** are both disabled, and **Client.PlaintextAuthenticationPolicy** is enabled, then the client MAY attempt plaintext authentication even if the server supports challenge/response authentication.

There is no protocol mechanism to allow the client and server to negotiate the challenge/response algorithm to be used. If none of the selected authentication mechanisms matches, authentication MUST fail.

Client.PlaintextAuthenticationPolicy: A state that determines whether plaintext authentication is permitted. The following options are available:

- **Enabled:** Plaintext authentication enabled.

If the server does not support challenge/response authentication, the client MUST authenticate using plaintext passwords. The server indicates support for challenge/response authentication using the 0x02 flag bit of the **SecurityMode** field that is returned in the SMB_COM_NEGOTIATE response.

- **Disabled:** Plaintext authentication disabled.

If the server does not support challenge/response authentication, the client MUST disconnect from the server.

Client.SessionTimeoutValue: The maximum amount of time, in seconds, that the client will wait for the server to respond to an SMB message.

Client.Capabilities: The set of capabilities, as described in section [1.7](#) and specified in section [2.2.4.53.1](#), supported by the client.

3.2.1.2 Per SMB Connection

Client.Connection: An established SMB connection between the client and the server. The following ADM elements are maintained for each SMB connection established by a client.

Client.Connection.ClientNextSendSequenceNumber: A sequence number for the next signed request being sent.

Client.Connection.ClientResponseSequenceNumber: A list of the expected sequence numbers for the responses of outstanding signed requests, indexed by process identifier (PID) value and Multiplex ID (**MID** value).

Client.Connection.ConnectionlessSessionID: Only used if the underlying transport is connectionless. This is an SMB Connection identifier: a server-unique identifier for the connection between the client and the server.

Client.Connection.IsSigningActive: A Boolean that indicates whether or not message signing is active for this SMB connection.

Client.Connection.NegotiateSent: A Boolean that indicates whether an SMB_COM_NEGOTIATE request has been sent for this connection.

Client.Connection.NTLMChallenge: A byte array containing the cryptographic challenge received from the server during protocol negotiation. The challenge is returned in the SMB_COM_NEGOTIATE response.

Client.Connection.OpenTable: A list of Opens, as specified in section [3.2.1.5](#). This list MUST allow lookups based upon the **Open.FID**.

Client.Connection.PIDMIDList: A list of currently outstanding SMB commands. Each entry MUST include the PID and Multiplex IDs (**MIDs**) assigned to the request and MUST include a time-out time stamp of when the request was sent. For transaction requests (see section [3.2.4.1.5](#)), each entry MUST include a state variable **TransactionState** to describe the state of the transaction. Each transaction has three states: TransmittedPrimaryRequest, ReceivedInterimResponse, and TransmittedAllRequests.

The maximum number of entries in the **Client.Connection.PIDMIDList** is limited to the **Client.Connection.MaxMpxCount** value. More than **Client.Connection.MaxMpxCount** commands MUST NOT be outstanding at any given time.

Client.Connection.SearchOpenTable: A list of **SearchOpens**, as specified in section [3.2.1.6](#), representing currently open file searches on the server associated with the SMB connection.

Client.Connection.SelectedDialect: A variable that stores the SMB Protocol dialect selected for use on this connection. Details of dialects prior to NT LAN Manager (NTLM) ("NT LM 0.12") are described in other documents. See the table in section [1.7](#) for a list of dialects and implementation references.

Client.Connection.ServerCapabilities: The capabilities of the server, as specified in the description of the SMB_COM_NEGOTIATE response, section [2.2.4.52.2](#). The capabilities indirectly reflect the negotiated dialect for this connection.

Client.Connection.ServerChallengeResponse: A Boolean value that indicates whether or not the server supports challenge/response authentication.

Client.Connection.ServerSessionKey: The **session key** value returned by the server in the negotiate response.

Client.Connection.ServerMaxBufferSize: The negotiated maximum size, in bytes, for SMB messages sent to the server. This limit applies to all SMB messages sent to the server unless otherwise specified for particular message types.

Client.Connection.MaxMpxCount: The negotiated maximum number of commands that are permitted to be outstanding on a given SMB connection. This value is negotiated between the server and client, and limits the maximum number of entries in the **Client.Connection.PIDMIDList**.

Client.Connection.ServerName: The name of the server. For NetBIOS-based transports, this is the NetBIOS name of the server. For other transports, this is a transport-specific identifier that provides a unique name or address for the server.

Client.Connection.ServerSigningState: A value that indicates the signing policy of the server. This value is one of **Disabled**, **Enabled**, or **Required**.

Client.Connection.SessionTable: A list of authenticated sessions that have been established on this SMB connection as defined in section [3.2.1.3](#). It MUST be possible to look up entries by either the UID or the security context of the user that established the session.

Client.Connection.ShareLevelAccessControl: A Boolean that determines whether the target server requires share passwords (share level access control) instead of user accounts (user level access control). Share level and user level access control are mutually exclusive. The server MUST support one or the other, but not both.

Client.Connection.SigningChallengeResponse: A variable-length byte array that contains the challenge response to use for signing, if signing is active. If SMB signing is activated on the connection (**Client.Connection.IsSigningActive** becomes TRUE), the client response to the server challenge from the first non-null, non-guest session is used for signing all traffic on the SMB connection. The **Client.Connection.SigningChallengeResponse** is set to one of several possible values:

- **Empty** -- If **Client.Connection.IsSigningActive** is FALSE, no connection signing challenge response is used.
- **LM or LMv2 response** -- The response passed from client to server in the **OEMPassword** field of the SMB_COM_SESSION_SETUP_ANDX request.
- **NTLM or NTLMv2 response** -- The response passed from client to server in the **UnicodePassword** field of the SMB_COM_SESSION_SETUP_ANDX request.

Client.Connection.SigningSessionKey: A variable-length byte array that contains the session key that is used for signing packets, if signing is active.

If SMB signing is activated on the connection (**Client.Connection.IsSigningActive** becomes TRUE), the session key from the first non-null, non-guest session is used for signing all traffic on the SMB connection. The **Client.Connection.SigningSessionKey** is set to one of three values:

- **Empty** - If **Client.Connection.IsSigningActive** is FALSE, no connection signing session key is used.
- **LM Session Key** - The LM hash, generated from the user's password using the LMOWFv1() function defined in [\[MS-NLMP\]](#) section 3.3.1.
- **NT Session Key** - The NTLM hash, generated from the user's password using the NTOWFv1() function defined in [\[MS-NLMP\]](#) section 3.3.1.

Client.Connection.TreeConnectTable: A list of the tree connects over this SMB connection established to shares on the target server, containing the TID for each of the tree connects. It MUST be possible to look up entries either by TID or by share name.

3.2.1.3 Per SMB Session

Client.Session: An established session between the client and server. The following ADM elements are maintained for each SMB session established by a client:

Client.Session.Connection: The SMB connection associated with this session.

Client.Session.SessionKey: The 16-byte cryptographic session key associated with this session, as obtained from the authentication subsystem after successful authentication.

Client.Session.SessionUID: The 2-byte **UID** for this session, representing the user that established the session. The **UID** is returned by the server in the [SMB Header \(section 2.2.3.1\)](#) of the session setup response. All subsequent SMB requests for this user on this connection MUST use this **UID**.

Client.Session.UserCredentials: An opaque implementation-specific entity that identifies the credentials that were used for establishing the session.

3.2.1.4 Per Tree Connect

Client.TreeConnect: An established tree connect between the client and share on the server. The following ADM elements are maintained for each tree connect established by a client:

Client.TreeConnect.Connection: The SMB connection associated with this tree connect.

Client.TreeConnect.ShareName: The share name corresponding to this tree connect.

Client.TreeConnect.TreeID: The treeID (**TID**) that identifies this tree connect as returned by the server in the header of the [SMB_COM_TREE_CONNECT Response \(section 2.2.4.50.2\)](#) or the [SMB_COM_TREE_CONNECT_ANDX Response \(section 2.2.4.55.2\)](#).

Client.TreeConnect.Session: A reference to the session on which this tree connect was established.

Client.TreeConnect.IsDfsShare: A Boolean that, if set, indicates that the tree connect was established to a DFS share.

3.2.1.5 Per Unique Open

Client.Open: A file or named pipe on the server opened through the established **Client.TreeConnect**. The following ADM elements are maintained for each **open** held by a client:

Client.Open.Connection: The SMB connection associated with this **open**.

Client.Open.FID: The **FID** associated with the **open**, as returned by the server in the response to an open or create request.

Client.Open.NamedPipeMessageMode: A Boolean indicating whether the named pipe is in raw or byte mode (FALSE) or in message mode (TRUE). This ADM element is used only for named pipe **opens**.

Client.Open.OpLock: An element indicating the type of OpLock, if any, that has been granted on this **open**. This value MUST be one of **None**, **Exclusive**, **Batch**, or **Level II**.<187>

Client.Open.Session: The SMB session associated with this **open**.

Client.Open.TreeConnect: The tree connect associated with this **open**.

3.2.1.6 Per Unique Open Search

Client.SearchOpen: A search operation that is being performed through the established **Client.TreeConnect**. The following ADM elements are maintained for each **SearchID** open search held by a client:

Client.SearchOpen.FindSID: The search ID (**SID**) that identifies a search opened using the [TRANS2_FIND_FIRST2 \(section 2.2.6.2\)](#) subcommand.

Client.SearchOpen.TreeConnect: The tree connect associated with this open search.

3.2.2 Timers

3.2.2.1 Request Expiration Timer

This optional timer regulates the amount of time that the client SHOULD <188> wait for the server to respond to an SMB request; see section [3.2.6.1](#).

3.2.3 Initialization

When the CIFS client is started, the following values MUST be initialized:

- Values for **Client.PlaintextAuthenticationPolicy**, **Client.LMAuthenticationPolicy**, and **Client.NTLMAuthenticationPolicy** MUST be set based on system policy and implementation capabilities, and MUST be one of the possible values listed in section [3.2.1.1.<189>](#)
- Values for **Client.MessageSigningPolicy** MUST be set based on system policy and MUST be one of the possible values listed in section [3.2.1.1](#). The value of this element is not constrained by the values of any other policies.<190>
- **Client.ConnectionTable** MUST be empty.
- **Client.SessionTimeoutValue** MUST be set based on system policy.<191>
- **Client.MaxBufferSize** MUST be set based on system resource allocation policy.<192>

- **Client.SupportDialects** MUST be set to the list of dialect identifiers that the client supports, presented in section [1.7.<193>](#)
- **Client.Capabilities** MUST be set based on the capabilities of the local implementation. The specific bits to set in this ADM element are specified in section [2.2.4.53.1](#).

When an SMB connection is established, the following values MUST be initialized:

- **Client.Connection.ClientNextSendSequenceNumber** MUST be set to 2.
- **Client.Connection.ClientResponseSequenceNumber** MUST be an empty list.
- **Client.Connection.ConnectionlessSessionID** MUST be set to zero.
- **Client.Connection.IsSigningActive** is set to FALSE.
- **Client.Connection.NegotiateSent** MUST be set to FALSE.
- **Client.Connection.NTLMChallenge** MUST be set to zero.
- **Client.Connection.OpenTable** MUST be empty.
- **Client.Connection.PIDMIDList** MUST be empty.
- **Client.Connection.SearchOpenTable** MUST be empty.
- **Client.Connection.SelectedDialect** MUST be empty.
- **Client.Connection.ServerCapabilities** MUST be set to zero.
- **Client.Connection.ServerChallengeResponse** MUST be set to FALSE.
- **Client.Connection.ServerMaxBufferSize** MUST be set to zero.
- **Client.Connection.MaxMpxCount** MUST be set based on system policy. [<194>](#)
- **Client.Connection.ServerName** MUST be set to the name of the server to which the connection is being established.
- **Client.Connection.ServerSigningState** MUST be **Disabled**.
- **Client.Connection.SessionTable** MUST be empty.
- **Client.Connection.ShareLevelAccessControl** MUST be set to FALSE.
- **Client.Connection.SigningChallengeResponse** MUST be a zero-length array.
- **Client.Connection.SigningSessionKey** MUST be set to zero.
- **Client.Connection.TreeConnectTable** MUST be empty.

When a new SMB session is established, the following values MUST be initialized:

- **Client.Session.Connection** MUST be the SMB connection associated with this SMB session.
- **Client.Session.SessionKey** MUST be zero.
- **Client.Session.SessionUID** MUST be the server-supplied UID for this SMB session.
- **Client.Session.UserCredentials** MUST be set to empty.

When a new tree connect is established, the following values MUST be initialized:

- **Client.TreeConnect.Connection** MUST be the SMB connection associated with this tree connect.
- **Client.TreeConnect.ShareName** MUST be the name of the share to which the client is connecting.
- **Client.TreeConnect.TreeID** MUST be the server-supplied TID for this tree connect.

3.2.4 Higher-Layer Triggered Events

3.2.4.1 Sending Any Message

Messages sent by the client MUST conform to the rules specified in section [3.1.4.1](#), with the following additional requirements:

- The **SMB_Header.Status** field MUST be set to zero (0x00000000).
- The SMB_FLAGS_REPLY bit in the [SMB Header \(section 2.2.3.1\)](#) MUST be clear.
- The client MUST allocate or assign buffers to receive any parameters and/or data to be returned in the response message.

The caller MUST provide the following:

- A buffer containing the message to be sent.
 - Exactly one of the following:
 - The SMB connection (**Client.Connection**) identifying the transport connection on which to send the request.
- OR
- One or both of the **Client.Session** and **Client.TreeConnect** identifying the authenticated user and share respectively.

If both the **Client.Session** and **Client.TreeConnect**, are supplied by the caller, **Client.Session.Connection** MUST match **Client.TreeConnect.Connection**.

If the Connection was supplied by the caller, the same MUST be used to send the request. Otherwise, the connection identified by **Client.Session.Connection** (or, equivalently, **Client.TreeConnect.Connection**) MUST be used to send the request.

If a **Client.Session** is supplied by the caller, the **SMB_Header.UID** field MUST be set to **Client.Session.SessionUID**. Otherwise, the client MUST set the **SMB_Header.UID** field to 0x0000.

If a **Client.TreeConnect** is supplied by the caller, the **SMB_Header.TID** MUST be set to **Client.TreeConnect.TreeID**. Otherwise, the client MUST set the **SMB_Header.TID** field to 0xFFFF.

The value of **SMB_Header.PID** MUST be assigned as specified in section [2.2.1.6.3](#), and the value of **SMB_Header.MID** MUST be assigned as specified in section [2.2.1.6.2](#).

3.2.4.1.1 Command Processing

SMB Commands are made up of one or more messages exchanged between the client and the server. Several command requests MAY be sent together in a single message (see sections [3.2.4.1.4](#) and [3.2.5.1.3](#)) or, at the other extreme, a single command MAY require several messages to complete (for example, Write MPX or any of the Transaction requests).

When a command is initiated by an application on the client, the **PID** and **MID** values of the command MUST be entered into the **Client.Connection.PIDMIDList** table. A single command MAY consist of several messages exchanged between the client and server. All messages that are part of the same command exchange MUST have the same **PID** and **MID** values. If a [Request Expiration Timer \(section 3.2.2.1\)](#) is supported, the client MUST set the Request Expiration Timer to signal at the configured time-out interval for this command, and each **PIDMIDList** entry MUST include the time-out time stamp of the command. If the command is sent to the server in multiple messages, the time-out time stamp MUST be updated when each part of the message is sent. The client MUST NOT allow another command with the same **PID** and **MID** values to start execution until the pending command has completed.

The SMB_COM_NT_CANCEL command is the only exception. SMB_COM_NT_CANCEL is used to cancel a pending command, and MUST use the same **PID** and **MID** as the command to be canceled. The **UID** and **TID** of the SMB_COM_NT_CANCEL command MUST also match those of the command to be canceled. The **PID** and **MID** values of the SMB_COM_NT_CANCEL command MUST NOT be entered into the **Client.Connection.PIDMIDList** table. No response to SMB_COM_NT_CANCEL is sent by the server (as specified in section [2.2.4.65](#)), and the client MUST NOT perform reply processing or maintenance of session timeouts, or invoke retry or session disconnection for this command.

Once a command has completed processing, its **Client.Connection.PIDMIDList** entry MUST be removed from the list and discarded.

3.2.4.1.2 Processing Options

The client keeps track of which optional processing features (Unicode, DFS, and so on) a server provides in the **Client.Connection.ServerCapabilities** state variable. Many of these features require that the client indicate that it uses them on a per-message basis. This is achieved by setting a flag corresponding to a feature in the **Flags2** field of the [SMB Header \(section 2.2.3.1\)](#).

3.2.4.1.3 Message Signing

If signing is active for the connection on which a message is sent, the message MUST be signed, as specified in section [3.1.4.1](#), by providing the sequence number that is stored in **Client.Connection.ClientNextSendSequenceNumber**. The client MUST maintain the appropriate sequence number for a response. It does so by inserting the number into the **Client.Connection.ClientResponseSequenceNumber** table with the **PID/MID** pair that identifies the request/response pair. (**PID** and **MID** are specified in section [2.2.3.1](#). **PID** is the result of combining the **PIDLow** and **PIDHigh** fields of the SMB Header (section 2.2.3.1).)

After signing the message with **Client.Connection.ClientNextSendSequenceNumber**, the following steps MUST be taken:

```
IF request command EQUALS SMB_COM_NT_CANCEL THEN
    INCREMENT Client.Connection.ClientNextSendSequenceNumber
ELSE IF request has no response THEN
    INCREMENT Client.Connection.ClientNextSendSequenceNumber BY 2
ELSE
```

```
SET Client.Connection.ClientResponseSequenceNumber[PID,MID] TO
  Client.Connection.ClientNextSendSequenceNumber + 1
INCREMENT Client.Connection.ClientNextSendSequenceNumber BY 2
END IF
```

The [SMB_COM_NT_CANCEL](#) command is defined in section [2.2.4.65](#).

To guarantee that the sequence numbers match during server validation, the client MUST ensure that packets are sent to the server in the same order in which they are signed.

3.2.4.1.4 Sending Any Batched ("AndX") Request

When sending a Batched request, the client MUST construct the message as follows:

The first request to be batched MUST be an AndX SMB command request, and MUST be included in full. That is, the **SMB_Header**, **SMB_Parameters**, and **SMB_Data** blocks of the request MUST be constructed, as specified in the corresponding subsection of Higher-Layer Triggered Events (section [3.2.4](#)), with the following additional constraints:

1. The **SMB_Header** of the first command MUST be the only header in the message. Follow-on commands are appended to the message without the header.
2. The **SMB_Parameters.AndXCommand** field MUST contain either the command code of a valid follow-on command request to be batched, or **SMB_COM_NO_ANDX_COMMAND** (0xFF).
 - If **SMB_Parameters.AndXCommand** contains **SMB_COM_NO_ANDX_COMMAND**, the chain is terminated. If **SMB_Parameters.AndXOffset** is set to 0, no further command requests can be added to the AndX Chain.
 - If **SMB_Parameters.AndXCommand** is a valid follow-on command code, the **SMB_Parameters.AndXOffset** field MUST be set to the offset, in bytes, from the start of the **SMB_Header** block, of the follow-on command request's **Parameters** block.
3. If **SMB_Parameters.AndXCommand** is a valid follow-on command code:
 - The **SMB_Parameters** and **SMB_Data** block pair of the follow-on command request MUST be constructed as specified in the corresponding subsection of Higher-Layer Triggered Events (section [3.2.4](#)). The block pair MUST be appended to the end of the message, and the [SMB Header \(section 2.2.3.1\)](#) of the follow-on message MUST NOT be included.
 - If the follow-on command is NOT an AndX command, the chain is terminated and no further command requests can be added to the chain.
4. If the follow-on command is an AndX command, the process repeats starting at step 2. [<195>](#)

The total size of the AndX message MUST NOT exceed the negotiated **Client.Connection.ServerMaxBufferSize**.

If signing is active for the connection on which a message is sent, the AndX message MUST be signed as a single message.

3.2.4.1.5 Sending Any Transaction

The Transaction SMB Commands are generic operations. They provide transport for extended sets of subcommands which, in turn, allow the CIFS client to access advanced features on the server. CIFS supports three different transaction messages, which differ only slightly in their construction:

- [SMB_COM_TRANSACTION \(section 2.2.4.33\)](#)
- [SMB_COM_TRANSACTION2 \(section 2.2.4.46\)](#)
- [SMB_COM_NT_TRANSACT \(section 2.2.4.62\)](#)

Transactions messages MAY exceed the maximum size of a single SMB message (as determined by the value of the **Client.Connection.ServerMaxBufferSize** parameter). Transaction messages that do not fit within a single SMB message MUST be split across multiple transaction SMBs. Each SMB transaction request has an associated secondary request message for this purpose:

- [SMB_COM_TRANSACTION_SECONDARY \(section 2.2.4.34\)](#)
- [SMB_COM_TRANSACTION2_SECONDARY \(section 2.2.4.47\)](#)
- [SMB_COM_NT_TRANSACT_SECONDARY \(section 2.2.4.63\)](#)

There are no secondary response messages. The client MUST send as many secondary requests as are needed to complete the transfer of the transaction request. The server MUST respond to the transaction request as a whole. If the server's transaction response exceeds the maximum size of a single SMB message, then the server MUST send multiple SMB responses to the request.

Like SMB messages, transactions are a rudimentary form of remote procedure call. Transaction subcommands identify operations to be performed, the parameters to pass to the operation, and raw data upon which to operate. The response also includes parameters and data.

Transactions are made up of four SMB message types. The set of all messages sent and received in order to perform a particular operation is referred to as a transaction.

1. A "primary request" MUST be sent by the client to initiate the transaction. This message also includes the total size of the transaction, which might not fit into a single request. If the primary request is sent as part of a batched message, the size of the entire batch message including the primary request MUST NOT exceed the negotiated **Client.Connection.ServerMaxBufferSize**.
2. If all of the parameters and data for the transaction request do not fit within the primary request, a single "interim response" MUST be sent by the server.
3. If an interim response is sent, and no error is returned in the interim response, then a "secondary request" MUST be used to continue a transaction started with a primary request. This message is sent by the client only. The client sends as many secondary requests as are necessary to complete the transaction. The server MUST NOT process the transaction until the entire transaction request has been transferred.
4. A "final response" MUST be sent by the CIFS server when the transaction has been processed. If the results of the transaction (the transaction response) do not fit within a single SMB response message, multiple final response messages MUST be sent.
5. Transaction response messages MUST NOT be sent in response to transaction requests sent as class 2 mailslot messages. See [\[MS-MAIL\]](#) for more information on mailslot protocols.

In its simplest form, a transaction consists of a single primary request to the server followed by a single final response.

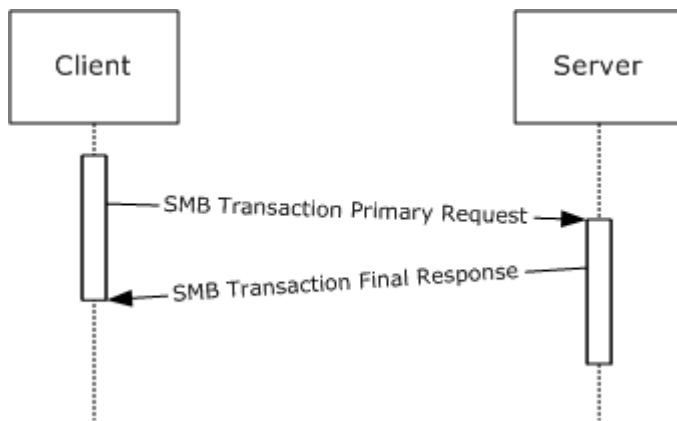

Figure 3: Simple Transaction

The client MUST set the **TransactionState** for the request (in **Client.Connection.PIDMIDList**) to "TransmittedAllRequests".

If a transaction request does not fit within a single SMB message, the following messages are exchanged:

1. The CIFS client MUST send a primary request that indicates that more messages are to follow. The client indicates that the transaction request is incomplete by setting the **ParameterCount** value less than the **TotalParameterCount**, or by setting the **DataCount** value less than the **TotalDataCount**, or both. After sending the primary request, the client MUST set the **TransactionState** for the request (in **Client.Connection.PIDMIDList**) to "TransmittedPrimaryRequest". [.<196>](#)
2. Upon receiving a primary request containing an incomplete transaction, the server MUST check for any initial errors and MUST return a single interim response.
3. The response received from the server MUST be processed as described in section [3.2.5.1.4](#).

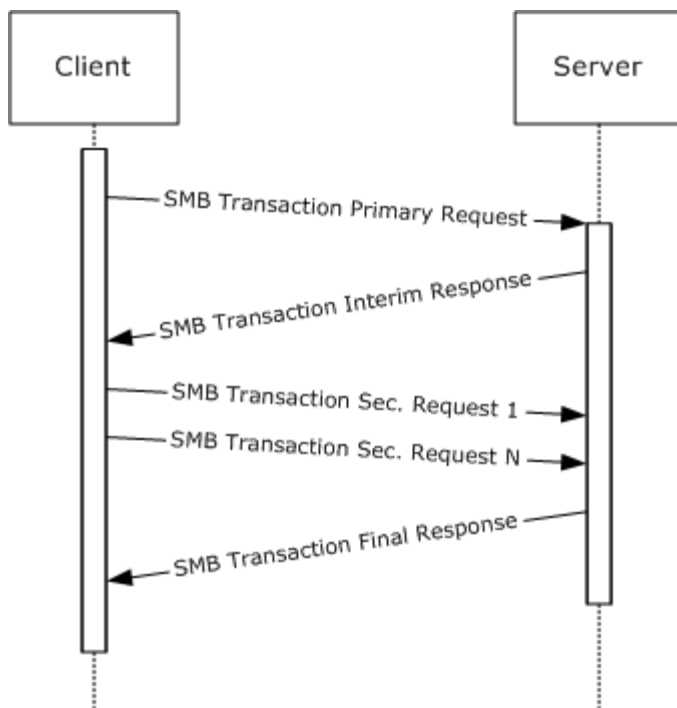

Figure 4: Transaction with secondary messages to complete the message transfer

Once it has received the entire request, the server **MUST** process the transaction and **MUST** finish with a transaction response. If the transaction response does not fit within a single SMB message, the following messages are exchanged:

1. The server **MUST** send a final response that indicates that additional response messages are to follow.
2. The server **MUST** send as many final response messages as are needed to complete the transfer of transaction parameters and data.

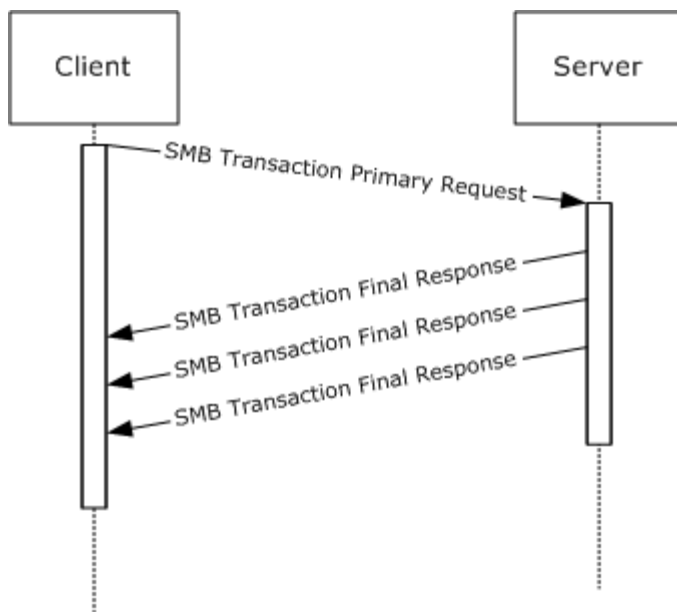

Figure 5: Transaction response with multiple SMB response messages

The number of SMB messages needed to transfer a transaction request is independent of the number of messages that can be returned. A single-part request can generate a single response or a multi-part response. Likewise, a multi-part request MAY generate one or more final response SMBs.

Secondary requests SHOULD NOT be used if the transaction request can fit within a single SMB message. Similarly, multiple final response messages SHOULD NOT be used if the transaction response can fit within a single SMB message.

Transaction parameters SHOULD take precedence over transaction data; all transaction parameters SHOULD be transferred before any transaction data.

All messages that are part of the same transaction MUST have the same **UID**, **TID**, **PID**, and **MID** values. If a connectionless transport is in use, the **CID** MUST also be the same for all transaction messages that are part of the same transaction. The client MUST NOT start a new transaction if it has not completed a previous transaction with the same **PID** and **MID** values. The client MAY start multiple concurrent transactions as long as at least one of the values of **PID** or **MID** differs from all other in-process transactions.

3.2.4.1.6 Accessing a Share in the DFS Namespace

If:

- The server has negotiated the NT LAN Manager dialect or later (SMB_COM_NEGOTIATE section [2.2.4.51](#)),
- The server has negotiated DFS capabilities via the CAP_DFS flag (SMB_COM_NEGOTIATE section [2.2.4.51](#)),
- The server has set the SMB_SHARE_IS_IN_DFS flag in the [SMB_COM_TREE_CONNECT_ANDX response \(section 2.2.4.55.2\)](#) for the share,

Then the share is in the DFS namespace (a "DFS share") and the client MUST set **Client.TreeConnect.IsDfsShare** to TRUE. The client MUST set the SMB_FLAGS2_DFS flag in the header of any message that contains a pathname to an object within the share (a DFS path). The pathname MUST have the full file name, including the server name and share name.

3.2.4.2 Application Requests Connecting to a Share

The application provides the following:

- **ServerName:** The name of the server to which to connect.
- **ShareName:** The name of the share to which to connect.
- **UserCredentials:** An opaque implementation-specific entity that identifies the credentials to be used when authenticating to the remote server.
- **IsDFSShare:** A Boolean indicating whether this is a **DFS** share.
- **TransportIdentifier:** An optional implementation-specific identifier for the transport on which the connection is to be established.

Upon successful completion, the client MUST return an existing or newly constructed [Session \(section 3.2.1.3\)](#), an existing or newly constructed [TreeConnect \(section 3.2.1.4\)](#), and the share type to the caller.

The client MUST follow the steps as described in the following flowchart. The request to connect to a server can be either explicit (for example, the application requests an SMB connection to \\server\share) or implicit (for example, the application requests to open the file \\server\share\file.txt, which implies that an SMB connection to \\server\share is being established). In either case, the following steps are followed. The only difference is that for the implicit case, the error returned in the failure case MUST be returned as the error of the operation that caused the implicit connect attempt.

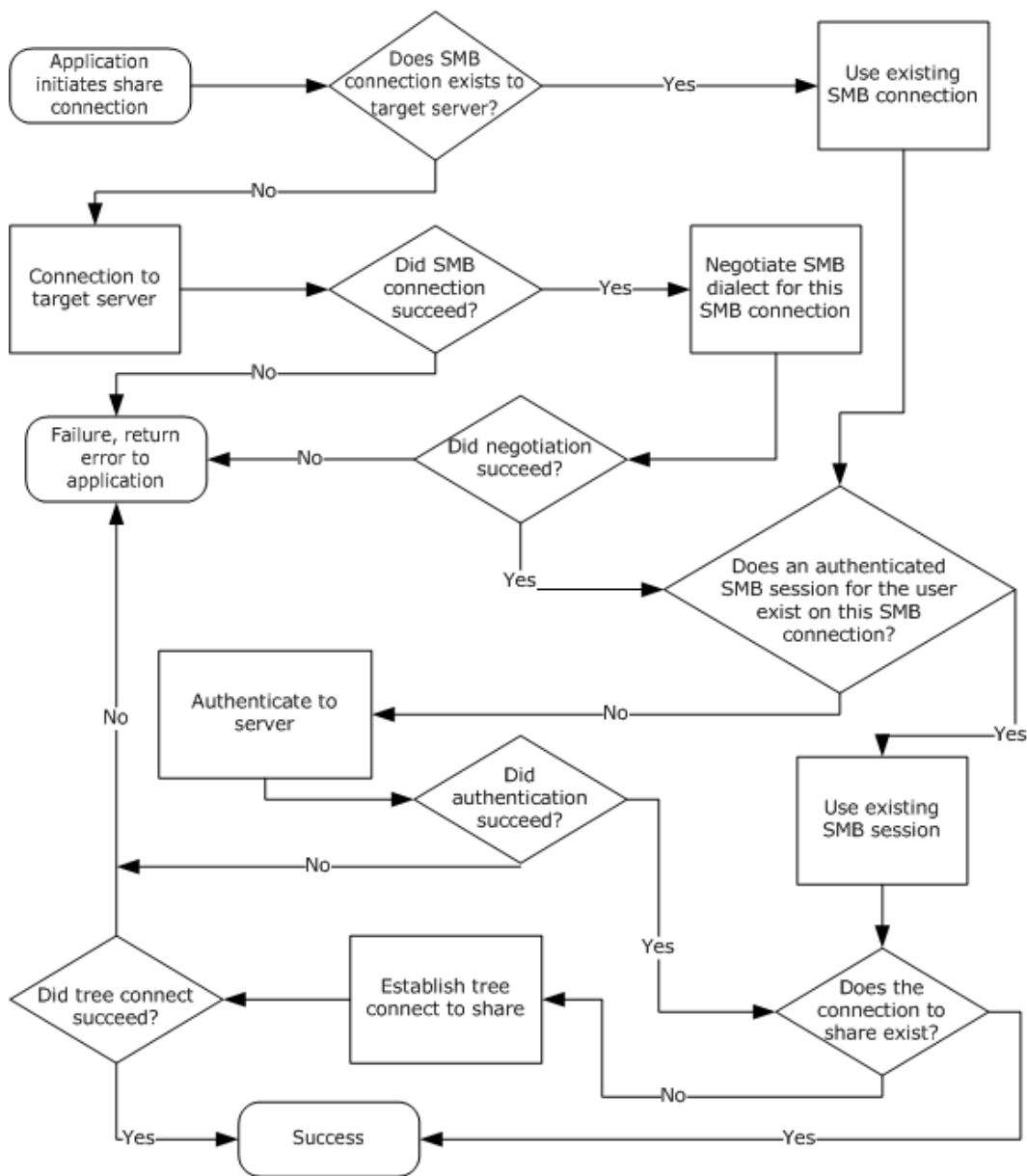

Figure 6: Application that connects to a share on a server

To complete a successful share connect, the client **MUST** have an established SMB connection, an authenticated SMB session for the user initiating the call, and a tree connect to the target share.

3.2.4.2.1 Connection Establishment

The client **SHOULD** search the **Client.ConnectionTable** and attempt to find an SMB connection where **Client.Connection.ServerName** matches the application-supplied **ServerName**. If a connection is found, the client **SHOULD** use the existing connection.

If there is no existing SMB connection, a new SMB connection **MUST** be established.

The **ServerName** and the optional **TransportIdentifier** provided by the caller are used to establish the connection. The client SHOULD resolve the **ServerName** as described in [\[MS-WPOI\]](#) section 6.1.3 and SHOULD attempt connections to one or more of the returned addresses. The client MAY attempt to initiate the SMB connection on all SMB transports that it supports, most commonly NetBIOS over TCP (NBT, as described in section [2.1.1.2](#)) and the other transports described in section [2.1](#). The client MAY choose to prioritize the SMB transport order and try each SMB transport sequentially or try to connect on all SMB transports and select one using any implementation-specific heuristic. The client MAY accept the **TransportIdentifier** parameter from the calling application, which specifies what SMB transport to use, and then attempt to use the transport specified. [<197>](#)

If all connection attempts fail, the connection establishment is failed and an appropriate error is returned, which is passed back to the calling application, as described earlier.

If the connect attempt succeeds, the client MUST create a new SMB connection as described in [3.2.1.2](#) and insert it into the global **Client.ConnectionTable**. **Client.Connection.ServerName** MUST be set to the caller-supplied **ServerName**.

3.2.4.2.2 Dialect Negotiation

If **Client.Connection.NegotiateSent** is FALSE, the client MUST set **SMB_Dialect.DialectString** to **Client.SupportDialects** and negotiate a protocol dialect using the [SMB_COM_NEGOTIATE](#) command, as specified in section [2.2.4.52](#). This step MUST be completed before progressing to any other operations on the connection.

Upon receipt of the server response the client MUST complete the following steps:

- The client MUST set **Client.Connection.NegotiateSent** to TRUE.
- The CIFS client MUST examine the **DialectIndex** field in the SMB_COM_NEGOTIATE Server response to determine the negotiated dialect. If an error was returned, or no dialect was selected, then the Negotiate Protocol operation has failed. Otherwise, the selected dialect is stored in **Client.Connection.SelectedDialect**.
- The CIFS client examines the **SecurityMode** bit field in the SMB_COM_NEGOTIATE Server response and performs the following steps in sequence:
 - If the 0x01 bit is zero, **Client.Connection.ShareLevelAccessControl** MUST be set to TRUE.
 - If the 0x02 bit is set (1), **Client.Connection.ServerChallengeResponse** MUST be set to TRUE.
 - If **Client.Connection.ServerChallengeResponse** is TRUE and the 0x04 bit is set (1), **Client.Connection.ServerSigningState** MUST be set to **Enabled**.
 - If **Client.Connection.ServerSigningState** is **Enabled** and the 0x08 bit is set (1), **Client.Connection.ServerSigningState** MUST be set to **Required**.
- The server capabilities, as returned in the **Capabilities** field of the SMB_COM_NEGOTIATE Server response, MUST be stored in **Client.Connection.ServerCapabilities**.
- The server's maximum buffer size (which is, with specific exceptions, the maximum size of an SMB message that can be sent to the server) MUST be stored in **Client.Connection.ServerMaxBufferSize**.

If the Negotiate Protocol operation fails, then the connection MUST be closed and an appropriate error message MUST be passed back to the calling application.

3.2.4.2.3 Capabilities Negotiation

Following a successful dialect negotiation, the client MUST perform a logical AND of **Client.Connection.ServerCapabilities** and **Client.Capabilities**.

The client MUST communicate these capabilities to the server in the **SMB_Parameters.Capabilities** field of an [SMB_COM_SESSION_SETUP_ANDX Request \(section 2.2.4.53.1\)](#).

The client MUST set the **MaxMpxCount** field in the SMB_COM_SESSION_SETUP_ANDX Request to the value of **Client.Connection.MaxMpxCount**.

The client SHOULD set the **SessionKey** field in the SMB_COM_SESSION_SETUP_ANDX Request (section 2.2.4.53.1) to the value of **Client.Connection.ServerSessionKey**.

3.2.4.2.4 User Authentication

If **Client.Connection.ShareLevelAccessControl** is TRUE: [<198>](#)

- Share level access control is required by the server. If no authentication has been performed on the SMB connection, (**Client.Connection.SessionTable** is empty), the client MUST use anonymous authentication to create a "null session". Application-provided credentials MUST NOT be used. [<199>](#)

The client MUST send only one session setup request. An [SMB_COM_SESSION_SETUP_ANDX Request](#) MUST be constructed as specified in section [2.2.4.53.1](#), with the following additional requirements. In the **SMB_Parameters** block of the SMB_COM_SESSION_SETUP_ANDX Request:

- The **AccountName** field MUST be the empty string.
- The **OEMPassword** and **UnicodePassword** fields MUST be empty (zero length).
- If the establishment of a null session fails, no further processing is possible. The connection MUST be closed and an implementation-specific error message MUST be returned.

The use of share level access control is deprecated. [<200>](#)

If **Client.Connection.ShareLevelAccessControl** is FALSE:

- User level access control is required by the server. The client MUST look up **Session** from **Client.Connection.SessionTable** where **Session.UserCredentials** matches the application-supplied **UserCredentials**. If a session is found, it MUST be reused. Otherwise, the client MUST create an SMB_COM_SESSION_SETUP_ANDX Request (section 2.2.4.53.1) and MUST attempt to establish an authenticated session for the user with the application-supplied **UserCredentials**.

- **Authentication:**

If **Client.Connection.ServerChallengeResponse** is FALSE and **Client.PlaintextAuthenticationPolicy** is Disabled, the client SHOULD fail the request with an implementation-dependent error.

If **Client.Connection.ServerChallengeResponse** is FALSE and **Client.PlaintextAuthenticationPolicy** is Enabled, the client MUST use plaintext authentication.

- If the server supports Unicode (as indicated in **Client.Connection.ServerCapabilities**) the client MAY send the plaintext password in Unicode. The Unicode password is placed into the **UnicodePassword** field of the SMB_COM_SESSION_SETUP_ANDX Request as an array of bytes (not a null-terminated string). No alignment padding is used. The **UnicodePasswordLength** field is set to the length, in bytes, of the Unicode password.
- If neither the client nor the server supports Unicode, or the client sends the password in OEM character set format, the password is placed into the **OEMPassword** field of the SMB_COM_SESSION_SETUP_ANDX Request as an array of bytes (not a null-terminated string). The **OEMPasswordLength** field is set to the length, in bytes, of the password.

If **Client.Connection.ServerChallengeResponse** is TRUE, the server can accept challenge/response authentication. The server MAY also accept plaintext authentication. The client MUST determine the authentication type that it uses based upon local configuration (the **Client.PlaintextAuthenticationPolicy**, **Client.LMAuthenticationPolicy**, and **Client.NTLMAuthenticationPolicy** values) in an implementation-specific manner. <201>

The LAN Manager (LM) response and the LAN Manager version 2 (LMv2) response are mutually exclusive. The implementation MUST select either the LM or the LMv2 response and send it in the **OEMPassword** field of the SMB_COM_SESSION_SETUP_ANDX Request as an array of bytes (not a null-terminated string). The **OEMPasswordLength** field MUST be set to the length in bytes of the LM or LMv2 response.

The NT LAN Manager (NTLM) response and the NT LAN Manager version 2 (NTLMv2) response are mutually exclusive. The implementation MUST select either the NTLM or the NTLMv2 response and send it in the **UnicodePassword** field of the SMB_COM_SESSION_SETUP_ANDX Request as an array of bytes (not a null-terminated string). The **UnicodePasswordLength** field MUST be set to the length, in bytes of the NTLM or NTLMv2 response.

If authentication fails, and the local configuration permits, the client MAY attempt authentication again using alternative response calculations (for example, replacing the LMv2 response with an LM response). <202> If all authentication attempts fail, and no authenticated SMB session exists, the underlying transport connection MUST be closed, and an implementation-specific error MUST be returned to the application.

- **Guest Authentication**

Guest access occurs in one of two ways:

1. The client logs on as a guest using the normal authentication process.
2. The client attempts to log on as some other user, but authentication fails. In this case, the server MAY choose to permit access via the guest user account. The Session Setup succeeds, but the SMB_SETUP_GUEST flag of the **Action** field in the [SMB_COM_SESSION_SETUP_ANDX Response](#) MUST be set to indicate guest access (see Session Setup in sections [2.2.4.53.2](#) and [3.3.5.43](#)).

- **Signing:**

If **Client.Connection.IsSigningActive** is FALSE and:

- A failed authentication resulted in guest access (as described above under Guest Authentication option #2), or
- Authentication was anonymous (resulting in a null session),

Then signing MUST NOT be enabled for this authentication.

If the combination of **Client.MessageSigningPolicy** and **Client.Connection.ServerSigningState** results in "Messages Signed" in the following table, the client MUST set the **Client.Connection.IsSigningActive** variable to TRUE and MUST set **SMB_FLAGS2_SMB_SECURITY_SIGNATURE** to TRUE in the SMB Header of the **SMB_COM_SESSION_SETUP_ANDX** Request message. Setting this value indicates to the server that signing is requested. **Client.Connection.ServerSigningState** was initialized during the processing of a negotiation response, as specified in section [3.2.5.2](#).

Otherwise, if **Client.Connection.IsSigningActive** is FALSE and the result is "Blocked" in the following table, the underlying transport connection MUST be closed and an implementation-specific error MUST be returned to the application.

Client signing state	Server signing state		
	Disabled	Enabled	Required
Disabled	Messages Unsigned	Messages Unsigned	Blocked
Enabled	Messages Unsigned	Messages Signed	Messages Signed
Required	Blocked	Messages Signed	Messages Signed

If **Client.Connection.IsSigningActive** becomes TRUE as a result of the authentication process, **Client.Connection.SigningSessionKey** and **Client.Connection.SigningChallengeResponse** MUST be set as specified in section [3.2.5.3](#).

If authentication succeeds, the newly created **Client.Session** MUST be inserted into the **Client.Connection.SessionTable**. The client MUST query the authentication subsystem for the cryptographic session key of the newly authenticated user, as specified in [\[MS-NLMP\]](#), and store it in **Client.Session.SessionKey**. The client MUST set **Client.Session.UserCredentials** to the application-supplied **UserCredentials**.

3.2.4.2.5 Connecting to the Share (Tree Connect)

In the LAN Manager 1.0 dialect and above, it is a protocol violation to send a tree connect request without completing an [SMB_COM_SESSION_SETUP_ANDX \(section 2.2.4.53\)](#) exchange. When using share level access control, the client MUST perform anonymous authentication (empty username and password) in the Session Setup.

If a tree connect is already established to the target share in **Client.Connection.TreeConnectTable**, it SHOULD be reused. If not, the client creates an [SMB_COM_TREE_CONNECT_ANDX Request \(section 2.2.4.55.1\)](#), as specified in section [2.2.4.55](#). Alternately, the client MAY use the deprecated [SMB_COM_TREE_CONNECT Request \(section 2.2.4.50.1\)](#).

If **Client.Connection.ShareLevelAccessControl** is TRUE and a null session has been established (see section [3.2.4.2.4](#)), the plaintext password or authentication response MUST be passed in the **Password** field of the **SMB_COM_TREE_CONNECT_ANDX.Request** or **SMB_COM_TREE_CONNECT Request**. There is only one **Password** field in the tree connect message, so only one response value can be sent. The client MUST determine the authentication type that it uses based upon **Client.Connection.ServerChallengeResponse** and the local configuration (the

Client.PlaintextAuthenticationPolicy, **Client.LMAuthenticationPolicy**, and **Client.NTLMAuthenticationPolicy** values), as specified in section [3.2.4.2.4](#).

If **Client.Connection.ShareLevelAccessControl** is FALSE, then the **PasswordLength** field in the SMB_COM_TREE_CONNECT_ANDX.Request or SMB_COM_TREE_CONNECT Request MUST be 0x0001, and the **Password** MUST be a single null padding byte.

3.2.4.3 Application Requests Creating a Directory

The application provides:

- A **Client.TreeConnect** indicating the share within which the new directory is to be created.
- The pathname of the directory to be created, relative to **Client.TreeConnect.ShareName**.
- A valid **Client.Session**.
- An optional list of extended attributes for [TRANS2_CREATE_DIRECTORY \(section 2.2.6.14\)](#).
- An optional timeout value for the [SMB_COM_TRANSACTION2 Request](#) command.

The client SHOULD construct a TRANS2_CREATE_DIRECTORY subcommand request message as specified in section [2.2.6.14](#). Alternately, the client MAY construct an SMB_COM_CREATE_DIRECTORY request message as specified in section [2.2.4.1](#) or an SMB_COM_NT_CREATE_ANDX request message as specified in section [2.2.4.64](#). The SMB_COM_CREATE_DIRECTORY (section 2.2.4.1) command is deprecated in favor of TRANS2_CREATE_DIRECTORY (section 2.2.6.14).

The following additional rules MUST be followed for message construction:

- The **SMB_Header.TID** field MUST match the **Client.TreeConnect.TID** supplied by the application.
- The **SMB_Header.UID** field MUST match the **Client.Session.UID** supplied by the application.
- The **DirectoryName** field MUST contain the pathname supplied by the application.

The request MUST be sent to the server as described in section [3.2.4.1](#).

3.2.4.4 Application Requests Deleting a Directory

The application provides:

- The **Client.TreeConnect** representing the share in which the directory to be deleted exists.
- The pathname of the directory to be deleted, relative to **Client.TreeConnect.ShareName**.
- A valid **Client.Session**.

The client MUST construct an [SMB_COM_DELETE_DIRECTORY Request \(section 2.2.4.2\)](#) message, with the following additional requirements:

- The **SMB_Header.TID** field MUST match the **Client.TreeConnect.TID** supplied by the application.
- The **SMB_Header.UID** field MUST match the **Client.Session.UID** supplied by the application.

- The **SMB_Data.Bytes.DirectoryName** field MUST contain the pathname supplied by the application.

The request MUST be sent to the server as described in section [3.2.4.1](#).

3.2.4.5 Application Requests Opening an Existing File

To open a file on a remote share, the application provides the following:

- The **Client.TreeConnect** representing the share in which the file to be opened exists.
- The pathname of the file being opened, relative to **Client.TreeConnect.ShareName**.
- The **Client.Session** representing the security context of the user opening the file.
- The requested access mode (read, write, and so on).
- The share access for the **open**.
- The create disposition for the **open**.
- An optional set of create options for the **open**.
- An optional Boolean indicating whether the attributes and time stamps of the file are to be returned in the response.
- An optional Boolean indicating whether the total length of the file's extended attributes is to be returned in the response.
- A Boolean indicating whether or not the parent directory of the target is to be opened.
- An optional requested impersonation level.
- The security flags.
- An optional allocation size.
- An optional timeout value.
- An optional security descriptor.
- The request for an exclusive or batch OpLock, if any. [<203>](#)

To open the file, the client can issue one of the following command requests:

- [SMB_COM_OPEN \(section 2.2.4.3\)](#) (deprecated)

The client MUST construct an [SMB_COM_OPEN Request \(section 2.2.4.3.1\)](#) message. This command provides basic Open semantics.

- [SMB_COM_OPEN_ANDX \(section 2.2.4.41\)](#) (deprecated)

The client MUST construct an [SMB_COM_OPEN_ANDX Request \(section 2.2.4.41.1\)](#) message. In addition to basic Open semantics, SMB_COM_OPEN_ANDX provides:

- AndX chaining.
- The ability to request detailed information regarding the opened file.

- The ability to select the file to be opened based upon the file attributes, as well as the ability to set the file attributes if the file does not exist and needs to be created.
- The ability to set or reset the creation time of the file.
- The disposition action to take based on the existence of the target file.

- [TRANS2_OPEN2 \(section 2.2.6.1\)](#)

The client MUST construct an [SMB_COM_TRANSACTION2 \(section 2.2.4.46\)](#) transaction request, to transport the TRANS2_OPEN2 transaction request. The client MUST construct a [TRANS2_OPEN2 Request \(section 2.2.6.1.1\)](#). In addition to basic Open semantics, TRANS2_OPEN2 provides:

- The ability to set extended attribute (EA) name/value pairs.
- The ability to set or reset the creation time of the file.
- The ability to specify an initial allocation for newly opened or overwritten files.
- The disposition action to take based on the existence of the target file.

- [NT_TRANSACT_CREATE \(section 2.2.7.1\)](#)

The client MUST construct an [SMB_COM_NT_TRANSACT \(section 2.2.4.62\)](#) transaction request, to transport the NT_TRANSACT_CREATE transaction request. The client MUST construct an [NT_TRANSACT_CREATE Request \(section 2.2.7.1.1\)](#). In addition to basic Open semantics, NT_TRANSACT_CREATE provides:

- The ability to specify a path relative to a subdirectory within the share indicated by the **TID**.
- The ability to specify an initial allocation for newly opened or overwritten files.
- The disposition action to take based on the existence of the target file.

- [SMB_COM_NT_CREATE_ANDX \(section 2.2.4.64\)](#)

The client MUST construct an [SMB_COM_NT_CREATE_ANDX Request \(section 2.2.4.64.1\)](#) message. In addition to basic Open semantics, SMB_COM_NT_CREATE_ANDX provides:

- AndX chaining.
- The ability to open or create a directory.
- The ability to specify a path relative to a subdirectory within the share indicated by the **TID**.
- The ability to specify an initial allocation for newly opened or overwritten files.
- The disposition action to take based on the existence of the target file.

The SMB_COM_NT_CREATE_ANDX is the most comprehensive (and, therefore, the most complex) of the open commands.

Any of the commands or subcommands listed above can be used to open a file. Directories, named pipes, and devices can also be opened. Most of these commands provide the option to create a file if it does not already exist, or to overwrite or append to the file if it does exist. For SMB_COM_OPEN (section 2.2.4.3), SMB_COM_OPEN_ANDX (section 2.2.4.41), and TRANS2_OPEN2 (section 2.2.6.1)

commands, the client MUST construct the **AccessMode** field of the request by translating the input parameters as follows:

Input parameter	Value(s)	AccessMode bit field	Value
Access mode	Only read access	AccessMode .AccessMode	0
Access mode	Only write access	AccessMode .AccessMode	1
Access mode	Read and write access	AccessMode .AccessMode	2
Access mode	execute	AccessMode .AccessMode	3
Share Access	0	AccessMode .SharingMode	1
Share Access	FILE_SHARE_READ	AccessMode .SharingMode	2
Share Access	FILE_SHARE_WRITE	AccessMode .SharingMode	3
Share Access	FILE_SHARE_DELETE	AccessMode .SharingMode	4
Create Options	FILE_SEQUENTIAL_ONLY = 0 and FILE_RANDOM_ACCESS = 0	AccessMode .ReferenceLocality	0
Create Options. FILE_SEQUENTIAL_ONLY	1	AccessMode .ReferenceLocality	1
Create Options. FILE_RANDOM_ACCESS	1	AccessMode .ReferenceLocality	2 or 3
Create Options.FILE_NO_INTERMEDIATE_BUFFERING	0	AccessMode .CacheMode	0
Create Options.FILE_NO_INTERMEDIATE_BUFFERING	1	AccessMode .CacheMode	1
Create Options. FILE_WRITE_THROUGH	0	AccessMode .WritethroughMode	0
Create Options. FILE_WRITE_THROUGH	1	AccessMode .WritethroughMode	1

The request MUST be sent to the server as described in section [3.2.4.1](#).

3.2.4.5.1 Compatibility Mode

Compatibility Mode (also referred to as "MS-DOS Compatibility Mode") provides the client with exclusive access to an opened file.

- A file opened in compatibility mode can be opened (also in compatibility mode) any number of times for any combination of reading and writing (subject to the user's permissions) by any **UID** and **PID** on the same SMB connection.

- If one client has the file open for writing in compatibility mode, the file MUST NOT be opened in any way by any other client.
- As an exception, if the filename has an extension of .EXE, .DLL, .SYM, or .COM (is executable), other clients are permitted to open the file for reading regardless of read/write open modes of other compatibility mode opens. The SMB_FLAGS2_READ_IF_EXECUTE bit (also known as the SMB_FLAGS2_PAGING_IO bit) MUST be set in the open request.
- If the first client has the file open only for reading in compatibility mode, other clients can open the file for reading in compatibility mode.
- Once one or more clients have the file open for reading in compatibility mode, other clients MUST NOT open the file in any mode other than compatibility mode.
- If any client has the file open for reading in compatibility mode, then other clients MUST NOT open the file for writing.

Because Compatibility Mode provides the client with exclusive access, it is incompatible with other open modes that provide shared access to the file. If the file is opened with sharing enabled, a subsequent Compatibility Mode open from the same client or any other client MUST return STATUS_SHARING_VIOLATION (ERRDOS/ERRbadshare).

The other file exclusion modes (Deny read/write, Deny write, Deny read, Deny nothing) provide exclusion at the file level. A file opened in any "Deny" mode MAY only be opened again for the accesses allowed by the Deny mode (subject to the user's permissions).

3.2.4.5.2 FID Permissions

If the open operation that created the **FID** specified a Deny mode, any SMB session making use of the **FID** (other than the SMB session within which the **FID** was created) has only the set of access rights determined by performing a logical "and" on the open mode rights and the Deny mode rights. That is, the Deny mode is checked on all file accesses.

3.2.4.6 Application Requests to Create or Overwrite a File

To create or overwrite a file on a remote share, the application provides the following:

- The **Client.TreeConnect** representing the share within which to create the file.
- The pathname of the file being created, relative to **Client.TreeConnect.ShareName**.
- The **Client.Session** representing the security context of the user opening the file.
- The requested access mode (read, write, and so on).
- An optional Boolean indicating whether the attributes and time stamps of the file are to be returned in the response.
- An optional Boolean indicating whether the total length of the file's extended attributes is to be returned in the response.
- The share access for the created file.
- The create disposition for the **open**.
- An optional set of create options for the **open**.

- An optional list of extended attributes.
- An optional list of search attributes.
- The request for an exclusive or batch OpLock, if any.
- A Boolean indicating whether or not the file attribute data is to be returned in the response.
- A Boolean indicating whether or not the parent directory of the target is to be opened.
- An optional requested level of impersonation.
- The security flags.
- An optional allocation size.
- An optional timeout value.
- An optional security descriptor.
- The print file mode Boolean.

To create the file, the client MUST issue one of the following command requests:

- [SMB_COM_CREATE \(section 2.2.4.4\)](#) (deprecated)

The client MUST construct an [SMB_COM_CREATE Request \(section 2.2.4.4.1\)](#) message as defined in section [2.2.4.4](#). This command provides basic Create semantics.

- [SMB_COM_CREATE_TEMPORARY \(section 2.2.4.15\)](#) (obsolescent)

This command is used to create a temporary file on the server. The client MUST construct an [SMB_COM_CREATE_TEMPORARY Request \(section 2.2.4.15.1\)](#) message.

- [SMB_COM_CREATE_NEW \(section 2.2.4.16\)](#) (deprecated)

This command is used to create a new file and MUST fail if the specified file already exists. The client MUST construct an [SMB_COM_CREATE_NEW Request \(section 2.2.4.16.1\)](#) message as defined in section [2.2.4.16](#).

- [SMB_COM_OPEN_PRINT_FILE \(section 2.2.4.67\)](#)

This command is used to create a new print spool file. The application provides opaque printer-specific control data that is to be included as the first part of the spool file. The client MUST construct an [SMB_COM_OPEN_PRINT_FILE Request \(section 2.2.4.67.1\)](#) message as defined in [2.2.4.67](#).

- [SMB_COM_OPEN_ANDX \(section 2.2.4.41\)](#) (deprecated)

The client MUST construct an [SMB_COM_OPEN_ANDX Request \(section 2.2.4.41.1\)](#) message as defined in section [2.2.4.41](#). If the application-provided Boolean value indicates the file attribute data to be returned in the response, the client MUST set REQ_ATTRIB flag in the **SMB_Parameters.Flags** field. In addition to basic Create semantics, SMB_COM_OPEN_ANDX provides:

- AndX chaining.
- The ability to set the file attributes when the file is created.

- The ability to set the creation time of the file.
- The disposition action to take based on the existence of the target file.

- [TRANS2_OPEN2 \(section 2.2.6.1\)](#)

The client MUST construct an [SMB_COM_TRANSACTION2 \(section 2.2.4.46\)](#) transaction request, as defined in section [2.2.4.46](#), to transport the TRANS2_OPEN2 transaction request. The client MUST construct a [TRANS2_OPEN2 Request \(section 2.2.6.1.1\)](#) as defined in section [2.2.6.1](#). If the application-provided Boolean value indicates the file attribute data to be returned in the response, the client MUST set REQ_ATTRIB flag in the **SMB_Parameters.Flags** field. In addition to basic Create semantics, TRANS2_OPEN2 provides:

- The ability to set extended attribute (EA) name/value pairs.
- The ability to set or reset the creation time of the file.
- The ability to specify an initial allocation for newly created or overwritten files.
- The disposition action to take based on the existence of the target file.

- [NT_TRANSACT_CREATE \(section 2.2.7.1\)](#)

The client MUST construct an [SMB_COM_NT_TRANSACT \(section 2.2.4.62\)](#) transaction request, as defined in section [2.2.4.62](#) to transport the NT_TRANSACT_CREATE transaction request. The client MUST construct an [NT_TRANSACT_CREATE Request \(section 2.2.7.1.1\)](#) as defined in section [2.2.7.1](#). In addition to basic Open semantics, NT_TRANSACT_CREATE provides:

- The ability to specify a path relative to a subdirectory within the share indicated by the **TID**.
- The ability to specify an initial allocation for newly opened or overwritten files.
- The disposition action to take based on the existence of the target file.

- [SMB_COM_NT_CREATE_ANDX \(section 2.2.4.64\)](#)

The client MUST construct an [SMB_COM_NT_CREATE_ANDX Request \(section 2.2.4.64.1\)](#) message as defined in section [2.2.4.64](#). In addition to basic Open semantics, SMB_COM_NT_CREATE_ANDX provides:

- AndX chaining.
- The ability to create a directory.
- The ability to specify a path relative to a subdirectory within the share indicated by the **TID**.
- The ability to specify an initial allocation for newly opened or overwritten files.
- The disposition action to take based on the existence of the target file.

The SMB_COM_NT_CREATE_ANDX is the most comprehensive (and, therefore, the most complex) of the Create commands.

When opening a named pipe, the SMB_COM_NT_CREATE_ANDX command requires that the **FileName** field MUST contain only the relative name of the pipe; that is, the "\PIPE\" prefix MUST NOT be present. This is in contrast with other commands, such as SMB_COM_OPEN_ANDX and TRANS2_OPEN2, which require that the "\PIPE\" prefix be present in the path name.

Any of the commands or subcommands listed in this section can be used to create a file. Directories can also be created. Most of these commands provide the option to open or overwrite a file if it already exists. For `SMB_COM_OPEN_ANDX` (section 2.2.4.41) and `TRANS2_OPEN2` (section 2.2.6.1) commands, the client MUST construct the **AccessMode** field of the request by translating the input parameters as specified in section [3.2.4.5](#).

In early dialects of the SMB Protocol the Open and Create operations were somewhat separate. In CIFS, there is considerable overlap between the set of commands used to open an existing file, the commands used to overwrite an existing file, and those used to create a new file.

The request MUST be sent to the server as described in section [3.2.4.1](#).

3.2.4.7 Application Requests Closing a File

The application provides:

- A **Client.Open**, representing the file that the application requests to close.
- The requested file creation time, expressed as the number of seconds since January 1, 1970, 00:00:00.0.

The client MUST construct an [SMB_COM_CLOSE Request \(section 2.2.4.5.1\)](#) message, with the following additional requirements:

- The **SMB_Parameters.Words.FID** field MUST match what was supplied by the application.

The request MUST be sent to the server as described in section [3.2.4.1](#).

3.2.4.8 Application Requests Flushing File Data

The application provides:

- A **Client.Open**, representing the file that the application requests to have flushed.

The client MUST construct an [SMB_COM_FLUSH Request \(section 2.2.4.6.1\)](#) message, with the following additional requirements:

- The **SMB_Parameters.Words.FID** field MUST contain the **FID** that was supplied by the application.

The request MUST be sent to the server as described in section [3.2.4.1](#).

3.2.4.9 Application Requests Deleting a File or Set of Files

The application provides:

- The **Client.TreeConnect** representing the share in which the file(s) to be deleted exist(s).
- The attribute mask of the file(s) to be deleted.
- The pathname of the file(s) to be deleted.
- A valid **Client.Session**.

The client MUST construct an [SMB_COM_DELETE Request \(section 2.2.4.7.1\)](#) message, with the following additional requirements:

- The **SMB_Parameters.Words.SearchAttributes** field MUST contain the attribute mask that was supplied by the application.
- The **SMB_Data.Bytes.FileName** field MUST contain the pathname that was supplied by the application.

[SMB_COM_DELETE \(section 2.2.4.7\)](#) can be used to delete multiple files if the file name (the final component of the **FileName** field) contains wildcard characters. The **SearchAttributes** are used to modify the set of files that can be included in the delete operation.

The request MUST be sent to the server as described in section [3.2.4.1](#).

3.2.4.10 Application Requests Renaming a File or Set of Files

The application provides:

- The **Client.TreeConnect** representing the share in which the file(s) to be renamed exist(s).
- The attribute mask of the file(s) to be renamed.
- The pathname of the file(s) to be renamed.
- The new desired pathname of the file(s).
- A valid **Client.Session**.

To rename the file, the client MUST issue one of the following command requests:

- [SMB_COM_NT_RENAME \(section 2.2.4.66.1\)](#) (Obsolescent)

The client MUST construct an SMB_COM_NT_RENAME Request (section 2.2.4.66.1) message with the following additional requirements:

- The **SMB_Parameters.Words.SearchAttributes** field MUST contain the attribute mask supplied by the application.
- The **SMB_Data.Bytes.OldFileName** field MUST contain the source pathname supplied by the application.
- The **SMB_Data.Bytes.NewFileName** field MUST contain the destination pathname supplied by the application.
- The **SMB_Parameters.Words.InformationLevel** field MUST contain an information level value of SMB_NT_RENAME_RENAME_FILE.

SMB_COM_NT_RENAME does not support wildcards and does not support renaming multiple files. This command provides support for the creation of hard links (see section [3.2.4.11](#)).

- [SMB_COM_RENAME \(section 2.2.4.8\)](#)

The client MUST construct an [SMB_COM_RENAME Request \(section 2.2.4.8.1\)](#) message with the following additional requirements:

- The **SMB_Parameters.Words.SearchAttributes** field MUST contain the attribute mask supplied by the application.
- The **SMB_Data.Bytes.OldFileName** field MUST contain the source pathname supplied by the application.

- The **SMB_Data.Bytes.NewFileName** field MUST contain the destination pathname supplied by the application.

SMB_COM_RENAME can be used to rename multiple files if the file name (the final component of the **FileName** field) contains wildcard characters. The **SearchAttributes** are used to modify the set of files that MAY be included in the rename operation.

Either of the preceding commands can be used to rename a file.

The request MUST be sent to the server as specified in section [3.2.4.1](#).

3.2.4.11 Application Requests Creating a Hard Link to a File

The application provides:

- The **Client.TreeConnect** representing the share in which the file to be linked exists.
- The attribute mask of the file to be linked.
- The pathname of the file to be linked.
- The requested pathname of the new hard link.
- A valid **Client.Session**.

The client MUST construct an [SMB_COM_NT_RENAME Request \(section 2.2.4.66.1\)](#) message with the following additional requirements:

- The **SMB_Parameters.Words.SearchAttributes** field MUST contain the attribute mask supplied by the application.
- The **SMB_Data.Bytes.OldFileName** field MUST contain the source pathname supplied by the application.
- The **SMB_Data.Bytes.NewFileName** field MUST contain the destination pathname supplied by the application.
- The **SMB_Parameters.Words.InformationLevel** field MUST contain an information level value of SMB_NT_RENAME_SET_LINK_INFO.

[SMB_COM_NT_RENAME \(section 2.2.4.66\)](#) does not support wildcards and does not support creating hard links for multiple files.

The request MUST be sent to the server as specified in section [3.2.4.1](#).

3.2.4.12 Application Requests Querying File Attributes

The application provides:

- A valid **Client.Session**.
- The **Client.TreeConnect** representing the share in which the file to be queried exists.
- If the file is not already open, the full pathname relative to the **TID**. Otherwise, attributes SHOULD be queried using a valid FID representing the opened file.
- The Information Level that defines the format of the data to query, as specified in [\[MS-FSCC\]](#) section 2.4.

- If the Information Level provided is **SMB_INFO_QUERY_EAS_FROM_LIST**, the application provides a list of extended attributes.

The client can use any of the following commands to query **file attributes**. The [SMB_COM_QUERY_INFORMATION](#) and [SMB_COM_QUERY_INFORMATION2](#) commands are deprecated; the client SHOULD use the TRANS2_QUERY_PATH_INFORMATION or the TRANS2_QUERY_FILE_INFORMATION transaction subcommand instead. The transaction subcommands can also be used to query named pipe attributes. The client MUST map the application-provided Information Level to the Query Information Levels, as specified in section [2.2.8](#).

- SMB_COM_QUERY_INFORMATION (deprecated)

The client MUST construct the SMB_COM_QUERY_INFORMATION request as defined in section [2.2.4.9](#). This command retrieves the following file attributes:

- Basic SMB_FILE_ATTRIBUTES, as described in section [2.2.1.2.4](#).
- Last write time of the file.
- The size of the file (limited to a 32-bit value).

The file to be queried MUST be identified by a full pathname, relative to the **TID**.

- SMB_COM_QUERY_INFORMATION2 (deprecated)

The client MUST construct the SMB_COM_QUERY_INFORMATION2 request as defined in section [2.2.4.31](#). This command retrieves the following file attributes:

- Basic SMB_FILE_ATTRIBUTES, as described in section [2.2.1.2.4](#).
- The date and time of file creation, last access, and last write.
- The file size (limited to a 32-bit value).
- The file allocation size (limited to a 32-bit value), which can be larger than the actual number of bytes contained in the file.

The file to be queried MUST be identified by a FID (an open file handle).

- TRANS2_QUERY_PATH_INFORMATION

The client MUST construct a TRANS2_QUERY_PATH_INFORMATION subcommand request as defined in section [2.2.6.6](#). The TRANS2_QUERY_PATH_INFORMATION request MUST be transported to the server using the Transaction2 subprotocol. This transaction subcommand provides access to extended file information, including:

- Basic SMB_FILE_ATTRIBUTES, as described in section [2.2.1.2.4](#).
- The creation time, last access time, and last write time attributes of the file.
- The file size (limited to a 32-bit value).
- The file allocation size (limited to a 32-bit value), which can be larger than the actual number of bytes contained in the file.
- The number of bytes allocated to extended attribute name/value pairs.

- Extended attributes.
- The number of hard links to the file.
- The file name and alternate file name.
- The ability to list alternate file streams.
- Whether or not the file is actually a directory.
- Whether or not the file is marked for delete upon close.
- Whether or not the file is compressed.

The file to be queried MUST be identified by a full pathname, relative to the **TID**.

- **TRANS2_QUERY_FILE_INFORMATION**

The client MUST construct a **TRANS2_QUERY_FILE_INFORMATION** subcommand request as defined in section [2.2.6.8](#). The **TRANS2_QUERY_FILE_INFORMATION** request MUST be sent to the server using the Transaction2 subprotocol as a transport. This transaction is identical to **TRANS2_QUERY_PATH_INFORMATION** except that the file to be queried MUST be identified by FID rather than by pathname.

The request MUST be sent to the server as described in section [3.2.4.1](#).

3.2.4.13 Application Requests Setting File Attributes

The application provides:

- A valid **Client.Session**.
- The **Client.TreeConnect** representing the share in which the file to be accessed exists.
- If the file is not open, the full pathname relative to **Client.TreeConnect.ShareName**. Otherwise, attributes SHOULD be set using a valid **Client.Open** representing the opened file.
- The Information Level that defines the format of the data to set, as specified in [\[MS-FSCC\]](#) section 2.4.
- When the Information Level is **SMB_INFO_STANDARD**, the application provides the creation date and time, last access date and time and last write date and time of the file, all expressed as the number of seconds from January 1, 1970 00:00:00.0.
- When the Information Level is **SMB_INFO_EAS**, the application provides the extended attribute name/value pairs of the file.
- When the Information Level is **SMB_SET_FILE_BASIC_INFO**, the application provides the creation time, last access time, last write time, change time and extended attribute name/pair of the file.
- When the Information Level is **SMB_SET_FILE_DISPOSITION_INFO**, the application provides a Boolean to indicate if the file is marked for deletion.
- When the Information Level is **SMB_SET_FILE_ALLOCATION_INFO**, the application provides the file allocation size in bytes.

- When the Information Level is **SMB_SET_FILE_END_OF_FILE_INFO**, the application provides the offset from the beginning of the file to the byte following the last byte in the file.

The client can use any of the following commands to set file attributes. The [SMB_COM_SET_INFORMATION \(section 2.2.4.10\)](#) and [SMB_COM_SET_INFORMATION2 \(section 2.2.4.30\)](#) commands are deprecated; the client SHOULD use the [TRANS2_SET_PATH_INFORMATION \(section 2.2.6.7\)](#) or the [TRANS2_SET_FILE_INFORMATION \(section 2.2.6.9\)](#) transaction subcommand. The transaction subcommands can also be used to set named pipe attributes. The client MUST map the application-provided **Information Level** to the **Set Information Levels**, as specified in section [2.2.8](#).

- SMB_COM_SET_INFORMATION (deprecated)

The client MUST construct the [SMB_COM_SET_INFORMATION Request \(section 2.2.4.10.1\)](#) as defined in section [2.2.4.10](#). This command can be used to set basic [SMB_FILE_ATTRIBUTES \(section 2.2.1.2.4\)](#), and to set the last write time attribute of the file. The file to be modified MUST be identified by a full pathname, relative to the **TID**.

- SMB_COM_SET_INFORMATION2 (section 2.2.4.30) (deprecated)

The client MUST construct the [SMB_COM_SET_INFORMATION2 Request \(section 2.2.4.30.1\)](#) as defined in section [2.2.4.30](#). This command can be used to set the creation time, last access time, and last write time attributes of the file. This command does not support modification of **SMB_FILE_ATTRIBUTES**. The file to be modified MUST be identified by a FID (an open file handle).

- TRANS2_SET_PATH_INFORMATION

When the **Information Level** is SMB_INFO_STANDARD, the application provides:

- The creation date of the file.
- The creation time of the file.
- The last access date of the file.
- The last access time of the file.
- The last write date of the file.
- The last write time of the file.

When the **Information Level** is SMB_INFO_EAS, the application provides:

- The extended attribute name/value pairs of the file.

When the **Information Level** is SMB_SET_FILE_BASIC_INFO, the application provides:

- The creation date and time of the file.
- The last access date and time of the file.
- The last write date and time of the file.
- The change date and time of the file.
- The extended attribute name/value pairs of the file.

When the **Information Level** is SMB_SET_FILE_DISPOSITION_INFO, the application provides:

- A Boolean flag indicating whether the file is to be deleted when closed.

The client MUST construct the TRANS2_SET_PATH_INFORMATION (section 2.2.6.7) subcommand request as defined in section [2.2.6.7](#). The [TRANS2_SET_PATH_INFORMATION Request \(section 2.2.6.7.1\)](#) MUST be transported to the server using the Transaction2 subprotocol. This subcommand can be used to:

- Set **SMB_FILE_ATTRIBUTES** on the file.
- Set the creation time, last access time, and last write time attributes of the file.
- Set extended attribute (EA) name/value pairs.
- Set the delete-on-close state of a file.
- Change the allocated size of the file.

The file to be modified MUST be identified by a full pathname, relative to the **TID**.

- TRANS2_SET_FILE_INFORMATION

This transaction subcommand is identical in behavior to TRANS2_SET_PATH_INFORMATION, except that the file MUST be identified by FID rather than by pathname.

The request MUST be sent to the server as specified in section [3.2.4.1](#).

3.2.4.14 Application Requests Reading from a File, Named Pipe, or Device

The application provides:

- A valid **Client.Open**, representing the file from which the application attempts to read.
- An offset, in bytes and relative to the start of the file, marking the location within the file at which the application attempts to read.
- The number of bytes to be read.
- A minimum number of bytes to be read.
- An optional time-out value, in milliseconds, indicating how long a server is requested to wait.

The application MAY also provide an estimate of the number of bytes that it attempts to read next. This value MUST represent a sequential read (immediately following the bytes being read in this request), as it is used to allow the server to perform read-ahead caching.

CIFS provides several commands for reading data from a file, named pipe, or device. These are:

- SMB_COM_READ (deprecated)

The client MUST construct an SMB_COM_READ request message as defined in section [2.2.4.11.1](#). This command provides the basic Read operation.

- SMB_COM_LOCK_AND_READ (deprecated)

The client MUST construct an SMB_COM_LOCK_AND_READ request as defined in section [2.2.4.20.1](#). Prior to reading, this command attempts to establish a lock on the specified byte range.

- SMB_COM_READ_RAW (deprecated)

The client MUST construct an SMB_COM_READ_RAW request as defined in section [2.2.4.22.1](#). The behavior of the SMB_COM_READ_RAW request is described in section [3.2.4.14.1](#).

- SMB_COM_READ_MPX (obsolescent)

The client MUST construct SMB_COM_READ_MPX request messages as defined in section [2.2.4.23.1](#). The behavior of the SMB_COM_READ_MPX request is described in section [3.2.4.14.2](#).

- SMB_COM_READ_ANDX

If the application reads from a named pipe or device specifically, it MUST also provide the minimum number of bytes to be read.

The client MUST construct an SMB_COM_READ_ANDX request message as defined in section [2.2.4.42.1](#), with the following additional requirements:

- If CAP_LARGE_FILES was negotiated during session setup, then the client MAY use a 64-bit **Offset** value. If the client is using a 64-bit **Offset** value, **SMB_Parameters.WordCount** MUST be set to 0x0C and the **SMB_Parameters.Words.Offset** and **SMB_Parameters.Words.OffsetHigh** fields MUST be set to the lower 32 bits and higher 32 bits, respectively, of the supplied offset value.
- If the client is using a 32-bit **Offset** value, **SMB_Parameters.WordCount** MUST be set to 0x0A, the **SMB_Parameters.Words.Offset** field MUST be assigned the offset value supplied by the application, and the **SMB_Parameters.Words.OffsetHigh** field MUST NOT be included in the request.
- The **SMB_Parameters.Words.MaxCountOfBytesToReturn** field MUST be assigned the number of bytes to be returned. This value is supplied by the application. If a value was supplied for a minimum number of bytes to be read, the **SMB_Parameters.Words.MinCountOfBytesToReturn** field MUST be assigned the value that was supplied by the application. Otherwise, it MUST be set to 0x0000.
- If a time-out value was supplied, the **SMB_Parameters.Words.Timeout** field MUST be assigned the value that was supplied by the application. Otherwise, it MUST be set to 0x00000000.

In addition, if CAP_LARGE_READX was set by the server in the negotiate protocol response and FID refers to a disk file, then the **MaxCountOfBytesToReturn** field in the client request can exceed the client's **Client.MaxBufferSize**.

- TRANS_RAW_READ_NMPIPE

The client MUST construct the TRANS_RAW_READ_NMPIPE subcommand as defined in section [2.2.5.2](#). The request MUST be transported to the server using the Transaction subprotocol. TRANS_RAW_READ_NMPIPE allows for a raw read of data from a named pipe. This method of reading data from a named pipe ignores message boundaries even if the pipe is set up as a message mode pipe.

- TRANS_READ_NMPIPE

The client MUST construct the TRANS_READ_NMPIPE subcommand as defined in section [2.2.5.8](#). The request MUST be transported to the server using the Transaction subprotocol. TRANS_READ_NMPIPE allows data to be read from a named pipe in the mode set on the named pipe. If the named pipe is in message mode, this subcommand MUST read a message from the pipe.

The request MUST be sent to the server as described in section [3.2.4.1](#).

3.2.4.14.1 Client Requests Read Raw

SMB_COM_READ_RAW is a specialized read command intended to maximize the performance of reading large blocks of data from an open regular file, named pipe, or device. The command permits a server to send a large unformatted data (raw byte stream) message over the SMB transport without requiring the usual SMB response format. It also permits a server to send messages in excess of the maximum buffer size established during protocol negotiation and session setup. To accomplish this, the client and the server enter into a dialog. For the dialog to begin, the client MUST perform the following steps:

- The client MUST compose the SMB_COM_READ_RAW request as described in section [2.2.4.22](#). This request advises the server of the total number of bytes that the client attempts to receive in response to the request. The request MUST be sent to the server as described in section [3.2.4.1](#), with the exception that SMB_COM_READ_RAW and message signing are mutually exclusive. Message signing MUST be disabled in order to perform a raw read.
- After sending the SMB_COM_READ_RAW request, the client MUST NOT send any other request to the server until the Read Raw response has been completely received. In addition, the client MUST NOT have any outstanding requests pending on the server. Because the server sends a raw data message that does not include the typical [SMB Header \(section 2.2.3.1\)](#), the SMB Protocol cannot guarantee that the client can associate the server's raw data message with the correct corresponding SMB_COM_READ_RAW command request. Therefore, the client MUST guarantee that there are no other SMB requests from the client to the server for the duration of the SMB_COM_READ_RAW command's dialog processing. It might not be possible for the client to distinguish between the raw data and another message if the response to another operation is sent by the server while the client is waiting for the raw data.
- The client MUST begin waiting for the unformatted data to arrive.
- The server MUST send the unformatted data message to the client. Because the message contains unformatted raw bytes, the client MUST rely on the SMB transport to determine whether the message was received successfully and to determine the size of the message.
- After the client has successfully received the unformatted data message, it MAY respond with another SMB_COM_READ_RAW SMB to continue reading raw bytes from the file. The server MUST then respond with another unformatted data message. This cycle MAY continue until the client has read all of the bytes that it requires, an end of file is reached, or an error occurs. To indicate that the end of the file has been reached on a regular file, the server MUST return fewer bytes than the client has requested in the **MaxCountOfBytesToReturn** field. A Raw Read from a named pipe or device MAY return fewer bytes than the client requested. This does not indicate an end of file on the pipe or device. If a file read error occurs on the server, the server MUST return a zero-length unformatted data message to the client.

If the server returns fewer bytes than requested by the client in the **MaxCountOfBytesToReturn** field, the client MAY respond with an alternate file I/O SMB (such as another Read operation or an SMB_COM_SEEK to the current position) using the same FID to determine the error.

- If the client experiences a transport layer error, all bytes of the message MUST be received and discarded. There is no mechanism to inform the server of the transport error. The client is responsible for taking appropriate action to recover from the transport layer error.

A sample dialog flow is:

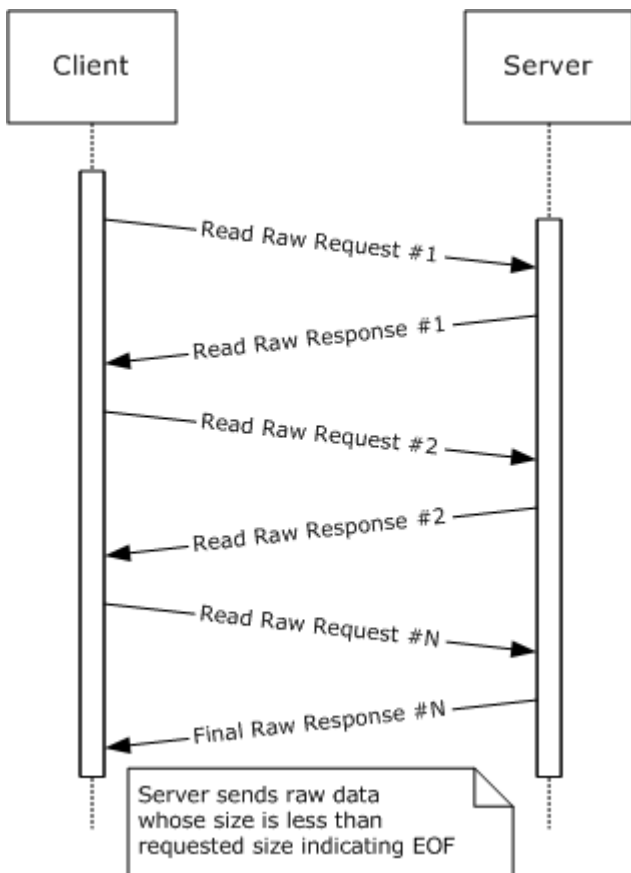

Figure 7: Read Raw request/response message flow

The client MUST accept an unformatted data message of up to **MaxCountOfBytesToReturn** bytes in length. **MaxCountOfBytesToReturn** is often set to 65,535 to maximize the transfer size and improve efficiency.

SMB Protocol SMB_COM_READ_RAW is not supported over connectionless SMB transports. If SMB_COM_READ_RAW is supported by the server, the CAP_RAW_MODE flag MUST be set in the **Capabilities** field in the response to the SMB_COM_NEGOTIATE SMB. If the **Client.Connection.SelectedDialect** is **NT LAN Manager** or later, and the response to the SMB_COM_NEGOTIATE SMB has CAP_LARGE_FILES set in the **Capabilities** field, an additional request format is allowed that accommodates very large files having 64 bit offsets (see the **OffsetHigh** field in the command description in section [2.2.4.22.1](#)).<204>

3.2.4.14.2 Client Requests Multiplexed Read

SMB_COM_READ_MPX is a specialized read command intended to maximize performance when reading large blocks of data from a regular file, while allowing for other operations to take place between the client and the server. This command is valid only when using a multiplexed session

(that is, a single SMB connection multiplexed across multiple transport connections). The server MUST respond to the command request with one or more response messages until the requested amount of data has been returned or an error occurs. Each server response MUST contain the PID and **MID** of the original client request and the **Offset** and **Count** describing the returned data.

If an error occurs, the server MUST send an error response. If any of the one or more responses to the SMB_COM_READ_MPX request contains an error code, the error applies to the command as a whole.

The client has successfully received all of the data bytes when the sum of the **DataLength** fields received in each response equals the total amount of data bytes expected (smallest **Count** received). This allows the protocol to work even if the responses are received out of sequence.

As is true in SMB_COM_READ, the total number of bytes returned can be less than the number requested only if a read specifies bytes beyond the current file size and the FID refers to a disk file. In this case, the server MUST return only the bytes that exist. A read completely beyond the end of file MUST result in a single response with a zero value in **Count**. If the total number of bytes returned is less than the number of bytes requested, this indicates end of file.

Once started, the Read Block Multiplexed operation is expected to continue until completion. The client MUST receive all of the responses generated by the server. Conflicting commands such as file close MUST NOT be sent to the server while a multiplexed operation is in progress. Server support of this command is optional.

3.2.4.15 Application Requests Writing to a File, Named Pipe, or Device

The application provides:

- A valid **Client.Open**, representing the file to which the application attempts to write.
- An offset, in bytes and relative to the start of the file, marking the location within the file where the application attempts to write.
- The data and the number of bytes to be written.
- Whether or not the write is to be done in write-through mode.
- An optional time-out value, in milliseconds, designating how long to wait for the write to complete.

CIFS provides several commands for writing data to a file, named pipe, or device. These are:

- [SMB_COM_WRITE \(section 2.2.4.12\)](#) (deprecated)

The client MUST construct an [SMB_COM_WRITE Request \(section 2.2.4.12.1\)](#) message as defined in section [2.2.4.12.1](#). This command provides the basic Write operation.

- [SMB_COM_WRITE AND UNLOCK \(section 2.2.4.21\)](#) (deprecated)

This command is used to write to a locked byte range in the file and then unlock the range. The application MAY provide an indication of the number of additional bytes immediately following the bytes written and unlocked that it attempts to write. The byte range to be written MUST be locked prior to writing. The client MUST construct the [SMB_COM_WRITE AND UNLOCK Request \(section 2.2.4.21.1\)](#) as defined in section [2.2.4.21.1](#).

- [SMB_COM_WRITE RAW \(section 2.2.4.25\)](#) (deprecated)

The client MUST construct an [SMB_COM_WRITE_RAW Request \(section 2.2.4.25.1\)](#). The behavior of the SMB_COM_WRITE_RAW Request (section 2.2.4.25.1) is described in section [3.2.4.15.1](#).

- [SMB_COM_WRITE_MPX \(section 2.2.4.23\)](#) (obsolescent)

The client MUST construct an [SMB_COM_WRITE_MPX Request \(section 2.2.4.23.1\)](#) as defined in section [2.2.4.26.1](#). The behavior of the SMB_COM_WRITE_MPX Request (section 2.2.4.23.1) is described in section [3.2.4.15.2](#).

- [SMB_COM_WRITE_AND_CLOSE \(section 2.2.4.40\)](#) (deprecated)

The client MUST construct an SMB_COM_WRITE_AND_CLOSE (section 2.2.4.40) command as defined in section [2.2.4.40.1](#). This command has the effect of writing to a range of bytes and then closing the file associated with the supplied FID. This command behaves identically to an SMB_COM_WRITE (section 2.2.4.12) command followed by an [SMB_COM_CLOSE \(section 2.2.4.5\)](#) command.

- [SMB_COM_WRITE_ANDX \(section 2.2.4.43\)](#)

The client MUST construct an [SMB_COM_WRITE_ANDX Request \(section 2.2.4.43.1\)](#) message as defined in section [2.2.4.43.1](#), with the following additional requirements:

- If the client uses a 64-bit offset value, **SMB_Parameters.WordCount** MUST be set to 0x0E and the **SMB_Parameters.Words.Offset** and **SMB_Parameters.Words.OffsetHigh** fields MUST be set to the lower 32 bits and the higher 32 bits, respectively, of the supplied offset value.
- If the client uses a 32-bit offset value, **SMB_Parameters.WordCount** MUST be set to 0x0C, the **SMB_Parameters.Words.Offset** field MUST be assigned the offset value supplied by the application, and the **SMB_Parameters.Words.OffsetHigh** field MUST NOT be included in the request.
- The **SMB_Parameters.Words.WriteMode** field MUST reflect any behavior that the application requests from the server. See the description of the **WriteMode** field in section [2.2.4.25.1](#).
- The **SMB_Parameters.Words.DataLength** field MUST be set to the length, in bytes, of the data to be written.
- The **SMB_Parameters.Words.DataOffset** field MUST be set to the offset, in bytes and relative to the start of the SMB Header block, of the data to be written to the file.
- The **SMB_Data.Bytes.Pad** field MUST contain padding bytes used to align the **SMB_Data.Bytes.Data** field to an appropriate boundary.
- The **SMB_Data.Bytes.Data** field MUST contain the data to be written.
- If the write is to a named pipe, and if the write spans multiple requests, the client SHOULD set the **SMB_Parameters.Words.Remaining** field to the number of bytes remaining to be written and MUST set the RAW_MODE bit in the **SMB_Parameters.Words.WriteMode** field. For the first write request the client MUST set the MSG_START bit in the **SMB_Parameters.Words.WriteMode** field. [<205>](#)

If the application writes to a named pipe or device and if a time-out value is supplied, the **SMB_Parameters.Words.Timeout** field MUST be assigned the value supplied by the application. Otherwise, it MUST be set to 0x00000000.

- SMB_COM_WRITE_PRINT_FILE (deprecated)

This command is used to write data to an open print queue spool file. The first data written to the print file MUST be printer-specific control data. The length of the control data block MUST be specified in the **SMB_Parameters.Words.SetupLength** field. A single SMB_COM_WRITE_PRINT_FILE command can contain both printer-specific control data and print file data, as long as the control data is completely written first.

The client MUST construct an SMB_COM_WRITE_PRINT_FILE request message as defined in section [2.2.4.68.1](#).

- TRANS_RAW_WRITE_NMPIPE

The client MUST construct the TRANS_RAW_WRITE_NMPIPE subcommand as defined in section [2.2.5.7](#). The request MUST be transported to the server using the Transaction subprotocol. TRANS_RAW_WRITE_NMPIPE allows for a raw write of data to a named pipe. This method of writing data to a named pipe ignores message boundaries even if the pipe was set up as a message mode pipe.

- TRANS_WRITE_NMPIPE

The client MUST construct the TRANS_WRITE_NMPIPE subcommand as defined in section [2.2.5.9.1](#). The request MUST be transported to the server using the Transaction subprotocol. TRANS_WRITE_NMPIPE allows data to be written to a named pipe in the mode set on the named pipe. If the named pipe is in message mode, this subcommand MUST write a message from the pipe.

The request MUST be sent to the server as described in section [3.2.4.1](#).

3.2.4.15.1 Client Requests Raw Write

SMB_COM_WRITE_RAW is a specialized write command intended to maximize the performance of writing large blocks of data to an open regular file, a named pipe, device, or spooled output (printer). The command permits a client to send a large unformatted data (raw byte) message over the SMB transport without requiring the usual SMB request format. It also permits a client to send messages in excess of the maximum buffer size (**Client.Connection.ServerMaxBufferSize**) that was established during session setup. To accomplish this, the client and the server enter into a dialog. For the dialog to begin, the client MUST perform the following steps:

- The client MUST compose the SMB_COM_WRITE_RAW request as described in section [2.2.4.25.1](#). This request informs the server of the total number of bytes that the client designates to send over the course of the dialog. For the dialog to begin, the request MUST be sent to the server as described in section [3.2.4.1](#), with the exception that SMB_COM_WRITE_RAW and message signing are mutually exclusive. Message signing MUST be disabled in order to perform a raw write. When the SMB_COM_WRITE_RAW request is received, the server MUST validate the request and attempt to write the initial data contained within the request. If an error is detected, the server returns a Final Server Response (section [2.2.4.25.3](#)), which completes the dialog. Otherwise, the server MUST respond with an Interim Server Response (section [2.2.4.25.2](#)) to indicate that the message was received and that the server is ready for the unformatted raw data. The server MUST then begin waiting for the unformatted data message to arrive.
- The client MUST send the unformatted data message to the server. Because the message contains unformatted raw bytes, the server MUST rely on the SMB transport to determine whether the message was received successfully, and to determine the message size.

- If the **WritethroughMode** bit was set in the **WriteMode** field of the original request, then the server MUST send a Final Server Response following receipt of the raw data from the client.
- If the **WritethroughMode** bit was clear in the **WriteMode** field of the original request, then the server MUST NOT send a Final Server Response following receipt of the raw data from the client.

A sample dialog flow is:

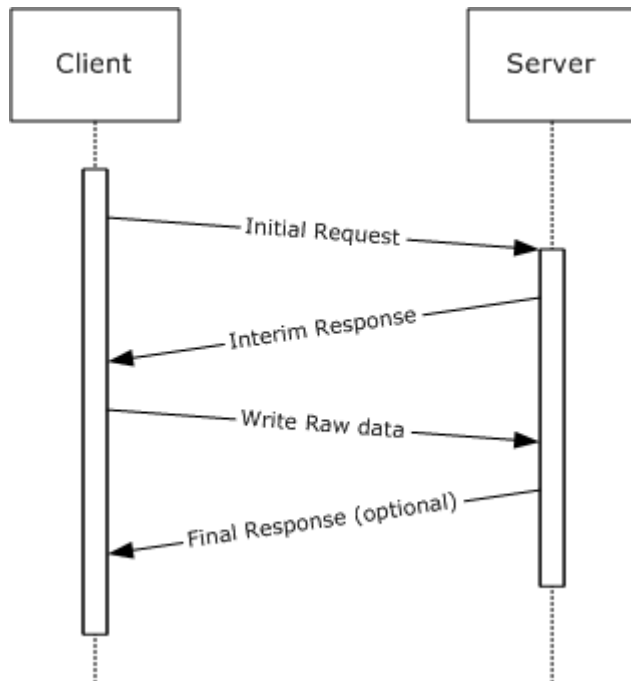

Figure 8: Write Raw request/response message flow

Because the client sends a raw data message that does not include the typical request data, the SMB Protocol cannot guarantee that the server can associate the client's raw data message with the correct corresponding client's SMB_COM_WRITE_RAW command. Therefore, the client MUST guarantee that there are no other SMB requests from the client to the server for the duration of the SMB_COM_WRITE_RAW command's dialog processing.

Server support of SMB_COM_WRITE_RAW is optional. This command is not supported over connectionless SMB transports. If SMB_COM_WRITE_RAW is supported by the server, the CAP_RAW_MODE flag MUST be set in the **Capabilities** field in the response to the SMB_COM_NEGOTIATE SMB. If the **Client.Connection.SelectedDialect** is NT LAN Manager or later, and the response to the SMB_COM_NEGOTIATE SMB has CAP_LARGE_FILES set in the **Capabilities** field, an additional request format is allowed that accommodates very large files having 64-bit offsets (see the **OffsetHigh** field in the command description in section [2.2.4.25.1](#)).<206>

3.2.4.15.2 Client Requests Multiplexed Write

SMB_COM_WRITE_MPX is used to maximize the performance of large block writes of data from the client to the server. This command is valid only when using a multiplexed session (multiple

transport connections bound to a single SMB connection) over a connectionless transport. To perform a multiplexed write, the client MUST send multiple SMB_COM_WRITE_MPX requests (each containing data to be written and the offset, in the **ByteOffsetToBeginWrite** field, at which the packet data is to be written) before the server responds with a single SMB_COM_WRITE_MPX response.

The client identifies the last request in the write sequence by also setting the **SMB Header SecurityFeatures.SequenceNumber** field to a nonzero value. This indicates to the server that the client indicates that it has completed sending all of the requests that need to be processed. After receiving the nonzero **SMB Header SecurityFeatures.SequenceNumber**, the server MUST respond with a single SMB_COM_WRITE_MPX response.

The client request **RequestMask** values are saved by the server and bitwise OR-ed into a value that is returned to the client in the **ResponseMask** field of the server's SMB_COM_WRITE_MPX response. If a problem occurred with the SMB transport and one or more of the client's SMB_COM_WRITE_MPX requests was not successfully received and processed by the server, the bit for that request MUST NOT be set in the server's SMB_COM_WRITE_MPX response **ResponseMask** field. The client MUST use the **ResponseMask** received in the SMB_COM_WRITE_MPX response to determine which client requests, if any, MUST be retransmitted. The client MUST use this behavior to send only the missing parts in the next write sequence when resending the lost requests.

When all of the request messages have been successfully received by the server, and a final SMB_COM_WRITE_MPX response received, the client MAY perform another write operation using the SMB_COM_WRITE_MPX request. The next SMB_COM_WRITE_MPX sequence sent MUST use a new **SMB Header SecurityFeatures.SequenceNumber** value to uniquely identify the set of requests, or the server can incorrectly respond with the mask from the previous SMB_COM_WRITE_MPX command. The server MUST NOT impose any restrictions on the value of **RequestMask**, nor upon the order or contiguity of the requests being sent.

The FID MUST be identical in all requests in a given SMB_COM_WRITE_MPX exchange. The **TID**, **PID**, **UID**, **MID**, and **CID** MUST be identical in all requests and responses in a given SMB_COM_WRITE_MPX exchange.

Other requests MAY be issued on the same session while the SMB_COM_WRITE_MPX exchange is in progress.

An example dialog flow is:

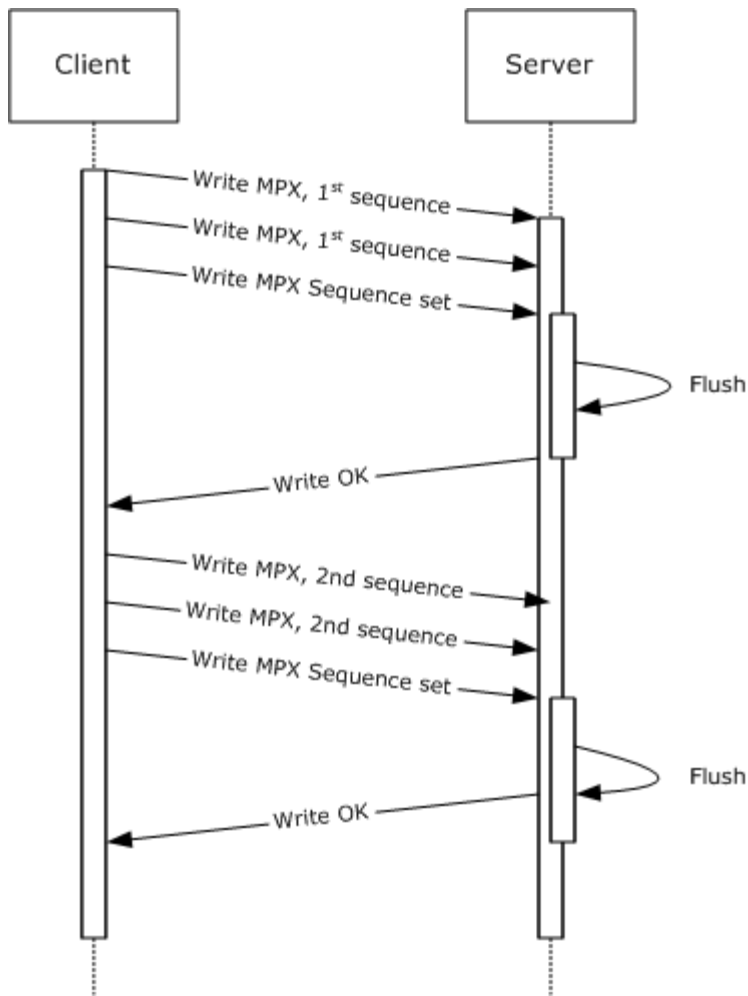

Figure 9: Multiplexed Write request/response message flow

At the time of the request, the client designates the number of data bytes to be sent and passes this information to the server in **TotalByteCount** field of the request. The server MAY use this information to reserve buffer space.

Some systems provide no way for a process to block until the local file cache has actually flushed to the disk, but simply indicate that a flush has been scheduled and MUST complete soon. A server SHOULD nonetheless take steps to maximize the probability that the data is truly on disk before the client is notified.

Server support of this command is optional. If the server supports this command it MUST set the CAP_MPX_MODE (0x00000002) bit in the **Capabilities** field of the response to SMB Protocol negotiation. Support for MPX mode excludes support for SMB signing and RAW read/write SMBs.

This command is supported on connectionless transports only; consequently, bit 0x0080 of **WriteMode** in all request messages in the exchange MUST be set. The FID in the request(s) MUST refer to either a regular file or a spooled printer file. This command does not support named pipes or I/O devices.

3.2.4.16 Application Requests a Byte-Range Lock on a File

The application provides:

- The **Client.Open** representing the file to be locked.
- An array of byte ranges to be locked. For each range, the application provides:
 - A starting offset, in bytes.
 - A length, in bytes.
- The number of byte ranges to be locked.
- The type of lock requested.
- The new oplock level, if this is a request from the server in response to a change.
- The length of time (in milliseconds) that the server is requested to wait for the locks to become available.
- An optional Boolean indicating whether the byte ranges are to be locked or shared.
- An optional Timeout.

Any of the following commands can be used to explicitly lock a contiguous range of bytes in a regular file:

- `SMB_COM_LOCK_BYTE_RANGE` (deprecated)

The client **MUST** construct the `SMB_COM_LOCK_BYTE_RANGE` request as defined in section [2.2.4.13.1](#). This command is limited to 32-bit offsets, and is considered deprecated. The `SMB_COM_LOCKING_ANDX` command **SHOULD** be used instead.

- `SMB_COM_LOCK_AND_READ` (deprecated)

This command combines the byte range lock with a read operation. The bytes locked by the request are also the bytes to be read. The application can provide an indication of the number of additional bytes immediately following the locked bytes that it designates to read. The client **MUST** construct the `SMB_COM_LOCK_AND_READ` (section [2.2.4.20.1](#)) request.

- `SMB_COM_LOCKING_ANDX`

Multiple non-overlapping byte ranges can be locked with this command. The client **MUST** construct the `SMB_COM_LOCKING_ANDX` request as defined in section [2.2.4.32.1](#). This client request is atomic. If the area to be locked is already locked or the lock request otherwise fails, no other ranges specified in the client request are locked. This command is capable of using 64-bit file offsets. If `CAP_LARGE_FILES` is set in **Client.Connection.ServerCapabilities**, 64-bit offsets **SHOULD** be used.

The `SMB_COM_LOCKING_ANDX` command supports requests for shared locks. The preceding deprecated locking commands do not support shared locks. The application can request a shared lock. If the application does not specify the lock type, an exclusive read/write lock is requested by default. The request for a shared lock is specified by setting the **SHARED_LOCK** bit in the **TypeOfLock** field (see section [2.2.4.32.1](#)).

Locks prevent attempts by other **PIDs** to lock, read, or write the locked portion of the file. Overlapping exclusive locks are not permitted. Offsets beyond the current end of file can be locked.

Such locks MUST NOT cause allocation of additional file space. A lock MUST be unlocked only by the **PID** that performed the lock.

The request MUST be sent to the server as described in section [3.2.4.1](#).

3.2.4.17 Application Requests the Release of a Byte-Range Lock on a File

The application provides:

- The **Client.Open** representing the file to be unlocked.
- An array of byte ranges to be unlocked. For each range, the application provides:
 - A starting offset, in bytes.
 - A length, in bytes.
- The number of byte ranges to be unlocked.
- The type of lock requested.
- The new oplock level, if this is a request from the server in response to a change.
- The length of time (in milliseconds) for the server to wait for the locks to become available.

Any of the following commands can be used to explicitly unlock a contiguous range of bytes in a regular file:

- [SMB_COM_UNLOCK_BYTE_RANGE \(section 2.2.4.14\)](#) (deprecated)
- This command is used to explicitly unlock a contiguous range of bytes in an open regular file. The byte range specified MUST be exactly the same as that specified in a previous successful lock request from the same CIFS client and process; the FID, PID, and UID MUST be the same as those used in the lock request. The client MUST construct the [SMB_COM_UNLOCK_BYTE_RANGE Request \(section 2.2.4.14.1\)](#), as defined in section [2.2.4.14.1](#).
- [SMB_COM_WRITE_AND_UNLOCK \(section 2.2.4.21\)](#) (deprecated)
- This command is used to write to a locked byte range in the file, and then unlock the range. The application MAY provide an indication of the number of additional bytes immediately following the bytes written and unlocked that it designates to write. The client MUST construct the [SMB_COM_WRITE_AND_UNLOCK Request \(section 2.2.4.21.1\)](#) as defined in section [2.2.4.21.1](#).
- [SMB_COM_LOCKING_ANDX \(section 2.2.4.32\)](#)
- Multiple non-overlapping byte ranges can be unlocked with this command. The client MUST construct the [SMB_COM_LOCKING_ANDX Request \(section 2.2.4.32.1\)](#). The client request is atomic. Failure to unlock or lock a byte range specified results in all ranges in the request being left in their previous state. This command is capable of using 64-bit file offsets. If `CAP_LARGE_FILES` is set in **Client.Connection.ServerCapabilities**, 64-bit offsets SHOULD be used.

Closing the file releases all locks associated with the FID. The [SMB_COM_PROCESS_EXIT \(section 2.2.4.18\)](#) command closes all file handles (FIDs) that were opened by the specified PID, and therefore releases all locks held on those FIDs.

The request MUST be sent to the server as described in section [3.2.4.1](#).

3.2.4.18 Application Requests an Opportunistic Lock on a File

The application requests an OpLock when opening or creating a file. See sections [3.2.4.5](#) and [3.2.4.6](#) for information on opening and creating files. The following SMB commands can be used to obtain an OpLock:

- [SMB_COM_OPEN \(section 2.2.4.3\)](#)
- [SMB_COM_CREATE \(section 2.2.4.4\)](#)
- [SMB_COM_CREATE_NEW \(section 2.2.4.16\)](#)
- [SMB_COM_OPEN_ANDX \(section 2.2.4.41\)](#)
- [SMB_COM_NT_CREATE_ANDX \(section 2.2.4.64\)](#)
- [TRANS2_OPEN2 \(section 2.2.6.1\)](#)
- [NT_TRANSACT_CREATE \(section 2.2.7.1\)](#)

The application can request either an exclusive OpLock or a batch exclusive OpLock on a file. The server indicates the type of OpLock granted in the response. The server MUST grant the requested OpLock, a read-only (Level II) OpLock, or no OpLock. If an exclusive OpLock is not available, Level II OpLocks are granted only in response to [SMB_COM_NT_CREATE_ANDX \(section 2.2.4.64\)](#) or [NT_TRANSACT_CREATE Requests \(section 2.2.7.1.1\)](#).

- If a Level II OpLock is granted, the server guarantees that no other process is modifying the file and that the client can perform read caching.
- If an exclusive OpLock is granted, read caching, write caching, and byte-range lock caching can be performed on the client side.
- If an exclusive batch OpLock is granted, the client can additionally cache file close operations, delaying sending file close operations to the server indefinitely and thus maintaining the client-side cache.

An OpLock remains in effect until the server revokes it or the file is closed by the client. For a batch OpLock, the client MAY cache file close operations from the application. The batch OpLock is released when the client performs the close operation.

Detailed information regarding OpLock semantics is provided in [\[FSBO\]](#).

3.2.4.19 Application Requests Verifying a Directory Path

The application provides:

- A **Client.TreeConnect** indicating the share within which the directory resides.
- The pathname of the directory, relative to **Client.TreeConnect.ShareName**.
- A valid **Client.Session**.

The client MUST construct an [SMB_COM_CHECK_DIRECTORY Request \(section 2.2.4.17.1\)](#) message. The **SMB_Data.Bytes DirectoryName field** MUST be set to the value that was supplied by the application.

The request MUST be sent to the server as described in section [3.2.4.1](#).

3.2.4.20 Client Notifies the Server of a Process Exit

The SMB_COM_PROCESS_EXIT command MAY be used to indicate to the server that a client process, represented by a PID value, has failed and that all resources allocated to that PID MUST be freed. The semantics of this command are deprecated, however, and it SHOULD NOT be used by new client implementations.

The client MUST construct the SMB_COM_PROCESS_EXIT request message as defined in section [2.2.4.18.1](#). The request MUST be sent to the server as described in section [3.2.4.1](#).

3.2.4.21 Application Requests to Seek to a Location in a File

The file MUST be held open by the application, and the application MUST provide a **Client.Open** as well as the desired offset and seek mode.

If the seek mode is 1 (meaning seek from the current position) and the offset is zero, then the application is requesting that the server report the current position of the file pointer (the current offset). Otherwise, the application is attempting to set the current file pointer. SMB_COM_SEEK handles 32-bit offsets only. Also, all Read and Write operations in the protocol set the file pointer, so it is not necessary to use SMB_COM_SEEK for that purpose. SMB_COM_SEEK is listed as obsolescent.

The client MUST construct the SMB_COM_SEEK request message as defined in section [2.2.4.19.1](#). The request MUST be sent to the server as described in section [3.2.4.1](#).

3.2.4.22 Application Requests Sending an IOCTL to a File or Device

The application MUST supply a **Client.Open** representing the open file or device, as well as the IOCTL category and function. The client MUST use either of the following commands to transfer the IOCTL to the server:

- [SMB_COM_IOCTL \(obsolescent\) \(section 2.2.4.35\)](#)

The client MUST construct the [SMB_COM_IOCTL Request \(section 2.2.4.35.1\)](#) message.

- NT_TRANSACT_IOCTL

The application provides the following:

- An input buffer, `_NT_Trans_Data`, to be passed to the **fsctl** or **ioctl** function.

The client MUST construct the [NT_TRANSACT_IOCTL Request \(section 2.2.7.2.1\)](#) message, with the following additional requirements:

- The **SMB_Parameters.Words.Setup.IsFsctl** flag is set to 0x01.
- The **SMB_Parameters.Words.Setup.IsFlags** flag is set to 0x01 if **Client.TreeConnect.IsDfsShare** is TRUE; otherwise, it is set to 0x00.
- The **SMB_Data.Bytes.NT_Trans_Data** field contains `NT_Trans_Data` supplied by the application.

The request MUST be transported to the server using the NT Transaction subprotocol.

The format of the IOCTL data and parameters are determined by the specific IOCTL function being called. The request MUST be sent to the server as described in section [3.2.4.1](#).

3.2.4.23 Application Requests Testing Transport Layer Connection

The client MUST have an established SMB connection and MUST have performed an SMB Protocol negotiation. No SMB session is necessary.

The application MUST provide:

- The **Client.Connection** that identifies the connection on which to send the request.
- The number of responses that the application designates to receive from the server. This number SHOULD be greater than zero.
- A block of data, which might be random, to be echoed by the server.

The client MUST construct an SMB_COM_ECHO request message as defined in section [2.2.4.39.1](#). The data block provided by the application MUST be sent in the **SMB_Data.Bytes.Data** field; otherwise, the field MUST be empty.

The request MUST be sent to the server as described in section [3.2.4.1](#).

3.2.4.24 Application Requests a Tree Disconnect (Unmount Share)

The application MUST provide the **Client.TreeConnect** of the tree connect to be closed. The client MUST construct an SMB_COM_TREE_DISCONNECT request as defined in section [2.2.4.51.1](#). The request MUST be sent to the server as described in section [3.2.4.1](#). All locks associated with open files within the share represented by the **Client.TreeConnect.TID** are released. All open search and file handles that represent objects within the **TID** are closed.

3.2.4.25 Application Requests an SMB Session Logoff

The application MUST provide the **Client.Session** of the SMB session to be closed.

The client MUST traverse the **Client.Connection.TreeConnectTable**, and for each entry in which **Client.TreeConnect.Session** matches the application-provided **Client.Session**, the **TreeConnect** MUST be closed, as specified in section [3.2.4.24](#).

The client MUST construct an [SMB_COM_LOGOFF_ANDX Request \(section 2.2.4.54.1\)](#). The request MUST be sent to the server as specified in section [3.2.4.1](#). The user represented by the **Client.Session.SessionUID** value, presented in the [SMB Header \(section 2.2.3.1\)](#), is logged off as follows:

- The server cancels any outstanding command requests for this **UID**.
- The server releases all locks and closes all files opened by this **UID**; the associated **FIDs** are invalidated.
- The server closes all searches currently held open by this **UID**; the associated **SIDs** are invalidated.
- The server disconnects all tree connects created by this **UID**; the associated **TIDs** are invalidated.
- The server invalidates the **UID**.

3.2.4.26 Application Requests Querying File System Attributes

The application provides:

- A **Client.TreeConnect.TreeID (TID)** of the share to be queried.
- The information level that describes the format of the information being queried, as specified in [\[MS-FSCC\]](#) section 2.5.

The client requests the retrieval of attributes from a file system using either of the two following commands. The client MUST map the application-provided information level to the **QUERY_FS Information Levels**, as specified in section [2.2.8](#).

- [SMB_COM_QUERY_INFORMATION_DISK \(section 2.2.4.57\)](#) (deprecated)

This command MUST be sent by a client to obtain the capacity and remaining free space on the volume hosting the subtree indicated by the **TID** in the [SMB Header \(section 2.2.3.1\)](#). It MUST be constructed as defined in section [2.2.4.57.1](#).

- [TRANS2_QUERY_FS_INFORMATION \(section 2.2.6.4\)](#)

The client MUST construct the [TRANS2_QUERY_FS_INFORMATION Request \(section 2.2.6.4.1\)](#) message. The request MUST be transported to the server using the Transaction2 subprotocol.

The request MUST be sent to the server as described in section [3.2.4.1](#).

3.2.4.27 Application Requests a Directory Enumeration

The application provides the following:

- A **Client.TreeConnect** indicating the share within which the directory resides.
- The pathname of the directory to query, relative to **Client.TreeConnect.ShareName**.
- A valid **Client.Session**.
- A wildcard qualifier to select the file names to return.
- A set of attribute flags that further qualify the list of file names to return.
- An Information Level that defines the format of the data to return.
- The number of results to return.
- A set of flags used to request that the server manage the transaction state based on how the client attempts to traverse results.
- A MASK specifying whether the search is for directories or for files.
- If the Information Level provided is **SMB_INFO_QUERY_EAS_FROM_LIST**, the application provides a list of extended attributes.

The client can use any of the following commands to enumerate the directory entries matching the application's criteria:

- [SMB_COM_SEARCH \(deprecated\) \(section 2.2.4.58\)](#)

The client MUST construct the **SMB_COM_SEARCH** request message as defined in section [2.2.4.58.1](#). The **FileName** field is the full directory path (relative to the **TID**) of the file(s) being sought. The final component of the path MAY contain wildcards. This string MAY be the empty string. The **SearchAttributes** field is an attribute mask used to specify the standard attributes that a file MUST have to match the search. If the value of this field is 0x0000, only normal files

are returned. If the Volume Label attribute is set, then the volume label MUST be the only name returned (the Volume Label attribute is exclusive). If the Directory, System, or Hidden attributes are specified, those entries are requested in addition to the normal files.

There is no Close operation associated with the SMB_COM_SEARCH. The client provides the server with no direct indication that the search is complete unless the client continues the search until the last matching entry has been returned.

An SMB_COM_PROCESS_EXIT request from the client closes an incomplete search. Disconnecting the **Client.TreeConnect** within which the search is active also closes the search.

- SMB_COM_FIND (deprecated)

The client MUST construct the SMB_COM_FIND request message as defined in section [2.2.4.59.1](#). The format and operation of SMB_COM_FIND is identical to that of SMB_COM_SEARCH, except that the search MAY be closed using the SMB_COM_FIND_CLOSE command, which provides a specific indication to the server that the search has been completed.

- SMB_COM_FIND_UNIQUE (deprecated)

The client MUST construct the SMB_COM_FIND_UNIQUE request message as defined in section [2.2.4.60.1](#). The format and operation of SMB_COM_FIND_UNIQUE is identical to that of SMB_COM_FIND. The former performs an implicit close on the search operation so that no SMB_COM_FIND_CLOSE is needed. The SMB_COM_FIND_UNIQUE returns only the results that can fit within a single response.

- TRANS2_FIND_FIRST2

The client MUST construct the TRANS2_FIND_FIRST2 request message as defined in section [2.2.6.2.1](#). If the search is incomplete following the first response from the server, the client MAY continue the search using a TRANS2_FIND_NEXT2 request as defined in section [2.2.6.3.1](#). These requests MUST be transported to the server using the Transaction2 subprotocol. If the search finds no names that match the client request, or if the continuation of the search finds no more names that match the client request:

- The server returns STATUS_NO_MORE_FILES as a 32-bit error code if the client set SMB_FLAGS2_NT_STATUS in the **Flags2** field of the client request.
- The server returns ERRDOS/ERRnofiles as an SMBSTATUS if SMB_FLAGS2_NT_STATUS is NOT set in the **Flags2** field of the client request.

Note that these return codes are not considered errors in this case.

The request MUST be sent to the server as described in section [3.2.4.1](#).

3.2.4.28 Application Requests Canceling Pending Operations

The application MUST provide the **UID**, **TID**, **PID**, and **MID** of the operation or operations to be canceled. If a connectionless transport is in use, then the application MUST also provide the **CID** (Connection ID) of the SMB connection.

The client MUST issue the cancel by sending an SMB_COM_NT_CANCEL request message. This message MUST be constructed as defined in section [2.2.4.65.1](#). The server MUST attempt to complete pending operations that match the **UID**, **TID**, **PID**, and **MID** (and CID, if required) in the request. Any matching pending operation that cannot be completed successfully MUST fail with an implementation-specific error status.

In particular, the SMB_COM_NT_CANCEL operation completes any Directory Change Notify operations (NT_TRANSACT_NOTIFY_CHANGE) on the server, causing the server to send an NT_TRANSACT_NOTIFY_CHANGE response message.

The request MUST be sent to the server as described in section [3.2.4.1](#), particularly the special handling required for SMB_COM_NT_CANCEL.

3.2.4.29 Application Requests to Print a File

The application MUST provide the **Client.Session** and MUST provide the **Client.TreeConnect** representing a connection to the printer share to which the data will be printed.

The client MUST create a print spool file using the SMB_COM_OPEN_PRINT_FILE command. The command request MUST be constructed as defined in section [2.2.4.67.1](#). The application MUST provide any printer-specific control data and the length, in bytes, of that data, which is copied into the **SMB_Parameters.Words.SetupLength** field. The application MUST indicate whether the data to be printed is to be handled in Text or Binary mode. See the description of the **SMB_Parameters.Words.Mode** field in section [2.2.4.67.1](#).

The application optionally provides printer-specific control data. If provided, it MUST be written to the spool file first, followed by the print file data itself.

The request MUST be sent to the server as described in section [3.2.4.1](#). If successful, the command MUST return a valid FID representing the opened spool file.

Any command capable of writing to an open FID, including SMB_COM_WRITE_PRINT_FILE, can be used to write the data to the print spool file. The file is queued for printing when the FID is closed. The FID can be closed using SMB_COM_CLOSE_PRINT_FILE (deprecated) or SMB_COM_CLOSE. The client can also use SMB_COM_WRITE_AND_CLOSE (deprecated) to write spool file data and close the file.

3.2.4.30 Application Requests Setting Named Pipe State

A client requests setting the state of a named pipe by issuing an SMB_COM_TRANSACTION Request with the subcommand TRANS_SET_NMPIPE_STATE. The application MUST provide a **Client.Open** of the named pipe to which the state change is to be applied. The application provides the pipe state as specified in section [2.2.5.1.1](#).

The client MUST construct the TRANS_SET_NMPIPE_STATE request message. The request MUST be sent to the server as specified in section [3.2.4.1](#).

If the **ReadMode** bits (see section [2.2.1.3](#)) of the **PipeState** field in the TRANS_SET_NMPIPE_STATE Request (section [2.2.5.1.1](#)) are zero, the client MUST set **Client.Open.NamedPipeMessageMode** to FALSE; otherwise, the client MUST set **Client.Open.NamedPipeMessageMode** to TRUE.

3.2.4.31 Application Requests Querying Named Pipe Handle State

A client queries named pipe state by issuing an SMB_COM_TRANSACTION request (section [2.2.4.33.1](#)) with the subcommand TRANS_QUERY_NMPIPE_STATE. The application MUST provide a FID indicating the open named pipe for which the state is being queried.

The client MUST construct the TRANS_QUERY_NMPIPE_STATE request message. The request MUST be sent to the server as specified in section [3.2.4.1](#).

A client queries named pipe state by issuing an SMB_COM_TRANSACTION Request (section 2.2.4.33.1) with the subcommand [TRANS_QUERY_NMPIPE_STATE \(section 2.2.5.3\)](#). The application MUST provide a **Client.Open** identifying the open to the named pipe.

The client MUST construct the [TRANS_QUERY_NMPIPE_STATE Request](#) message, using the **Client.Open.FID** from the supplied open. The request MUST be sent to the server as specified in section [3.2.4.1](#). The [TRANS_QUERY_NMPIPE_STATE Response \(section 2.2.5.3.2\)](#) MUST be processed as specified in section [3.2.5.38.3](#). If the **ReadMode** bits (see section [2.2.1.3](#)) of the **NMPipeStatus** field in the TRANS_QUERY_NMPIPE_STATE Response are zero, the client MUST set **Client.Open.NamedPipeMessageMode** to FALSE; otherwise, the client MUST set **Client.Open.NamedPipeMessageMode** to TRUE.

3.2.4.32 Application Requests Querying Named Pipe Information

A client requests querying named pipe information by issuing an SMB_COM_TRANSACTION request (section [2.2.4.33.1](#)) with the subcommand TRANS_QUERY_NMPIPE_INFO. The application MUST provide a **Client.Open** indicating the open named pipe from which the information is to be queried. Available information includes:

- Input and Output buffer sizes.
- Maximum and current number of instances of the named pipe.
- The name and the length of the name of the named pipe.

The client MUST construct the TRANS_QUERY_NMPIPE_INFO request message as specified in section [2.2.5.4.1](#). The request MUST be sent to the server as described in section [3.2.4.1](#).

3.2.4.33 Application Requests Peeking at Named Pipe Data

A client requests peeking into pipe data on a named pipe by issuing an SMB_COM_TRANSACTION request (section [2.2.4.33.1](#)) with the subcommand TRANS_PEEK_NMPIPE. The application MUST provide a **Client.Open** indicating the open named pipe from which data is to be read and the number of bytes to attempt to read.

The client MUST construct the TRANS_PEEK_NMPIPE request message as specified in section [2.2.5.5.1](#). The request MUST be sent to the server as described in section [3.2.4.1](#).

3.2.4.34 Application Requests Executing a Transaction on a Named Pipe

A client executes a transaction on a named pipe by issuing an [SMB_COM_TRANSACTION Request \(section 2.2.4.33.1\)](#) with the subcommand [TRANS_TRANSACT_NMPIPE \(section 2.2.5.6\)](#). The application MUST provide a **Client.Open** indicating the open named pipe on which to perform the transaction, a buffer of data to write into the pipe, and the maximum number of bytes to read out of the pipe.

The client MUST construct the [TRANS_TRANSACT_NMPIPE Request \(section 2.2.5.6.1\)](#) message and MUST send it to the server as specified in section [3.2.4.1](#).

3.2.4.35 Application Requests Waiting for Named Pipe Availability

A client requests to wait for named pipe availability by issuing an SMB_COM_TRANSACTION (section [2.2.4.33.1](#)) request with the subcommand TRANS_WAIT_NMPIPE. The application MUST provide the following:

- A **Client.TreeConnect** indicating the share within which the named pipe resides.

- The pathname of the named pipe, relative to **Client.TreeConnect.ShareName**.
- A valid **Client.Session**.
- A time-out value indicating how long to wait for named pipe availability.

The client MUST construct the TRANS_WAIT_NMPIPE request message as specified in section [2.2.5.10.1](#). The request MUST be sent to the server as described in section [3.2.4.1](#).

3.2.4.36 Application Requests Named Pipe Exchange (Call)

A client executes a call on a named pipe by issuing an SMB_COM_TRANSACTION (section [2.2.4.33.1](#)) request with the subcommand TRANS_CALL_NMPIPE. The Call operation is similar to the operation performed by TRANS_TRANSACT_NMPIPE, except that the pipe is opened and closed by the Call operation.

The application MUST provide:

- A **Client.TreeConnect** indicating the share within which the named pipe resides.
- The pathname of the named pipe, relative to **Client.TreeConnect.ShareName**.
- A valid **Client.Session**.
- A buffer containing the data to be written into the pipe.
- The number of bytes to be written.
- The maximum number of bytes to read from the pipe.
- A priority value in the range 0..9; higher values indicate higher priority.

The client MUST construct the TRANS_CALL_NMPIPE request message as specified in section [2.2.5.11.1](#). The request MUST be sent to the server as described in section [3.2.4.1](#).

3.2.4.37 Application Requests to Read from a Named Pipe

A client can request to read from a named pipe by issuing an SMB_COM_TRANSACTION Request with the subcommand TRANS_READ_NMPIPE. The application MUST provide a **Client.Open** indicating the open named pipe from which data is to be read. The application provides the maximum number of bytes that the client attempts to read from the named pipe.

Named pipes can be in raw mode or message mode (see [TRANS_SET_NMPIPE_STATE](#)). If the named pipe is in raw mode, as indicated by a **Client.Open.NamedPipeMessageMode** value of FALSE, it can be read by any of several Read operations (see section [3.2.4.14](#)). If the pipe is in message mode, as indicated by a **Client.Open.NamedPipeMessageMode** value of TRUE, [TRANS_READ_NMPIPE](#) MUST be used to read discrete messages.

The client MUST construct the TRANS_READ_NMPIPE Request message and MUST send it to the server as specified in section [3.2.4.1](#).

3.2.4.38 Application Requests Writing to a Named Pipe

A client can write to a named pipe by issuing an SMB_COM_TRANSACTION request with the subcommand TRANS_WRITE_NMPIPE. The application MUST provide a **Client.Open** indicating the open named pipe to which data is to be written.

Named pipes can be in raw mode or message mode (see [TRANS_SET_NMPIPE_STATE](#)). If the named pipe is in raw mode, as indicated by a **Client.Open.NamedPipeMessageMode** value of FALSE, it can be written to using any of several Write operations (see section [3.2.4.15](#)). If the pipe is in message mode, as indicated by a **Client.Open.NamedPipeMessageMode** value of TRUE, TRANS_WRITE_NMPIPE MUST be used to write discrete messages.

The client MUST construct the TRANS_WRITE_NMPIPE request message and MUST send it to the server as specified in section [3.2.4.1](#).

3.2.4.39 Application Requests Notification of Change in Directory Contents

A client requests waiting for directory change notification by issuing an SMB_COM_NT_TRANSACT (section [2.2.4.62.1](#)) request with the subcommand NT_TRANSACT_NOTIFY_CHANGE. The application provides the following:

- A **Client.Open** indicating a directory within a connected share.
- A Completion Filter indicating the changes needed in order to complete the command.
- A Boolean indicating whether or not subtrees of the specified directory are also to be monitored for changes.
- The size of the buffer that the server MUST use to collect file change information.

The command MUST NOT be completed until one of the following events occurs:

- A change matching one of the change events in the Completion Filter occurs.
- An SMB_COM_NT_CANCEL with matching **UID, TID, PID, MID**, and (depending upon the transport type) **CID** is received. See section [3.2.4.28](#).

The **SMB_Parameters.Words.MaxParameterCount** field in the SMB_COM_NT_TRANSACT request determines the size of the buffer that is used by the server to buffer directory change information. The **SMB_Parameters.Words.MaxParameterCount** field in the SMB_COM_NT_TRANSACT request is set to the size supplied by the application.

The client MUST construct the NT_TRANSACT_NOTIFY_CHANGE request message as specified in section [2.2.7.4.1](#). The request MUST be sent to the server as described in section [3.2.4.1](#).

3.2.4.40 Application Requests Querying Security Descriptors

A client requests to query security descriptors by issuing an SMB_COM_NT_TRANSACT (section [2.2.4.62.1](#)) request with the subcommand NT_TRANSACT_QUERY_SECURITY_DESC. The application MUST provide the **Client.Open** of the file that is the target of the query, the maximum number of data bytes the client accepts in the response, and a list of the security information fields being requested.

The client MUST construct the NT_TRANSACT_QUERY_SECURITY_DESC request message as specified in section [2.2.7.6.1](#). The request MUST be sent to the server as described in section [3.2.4.1](#).

3.2.4.41 Application Requests Setting Security Descriptors

A client requests to set security descriptors by issuing an SMB_COM_NT_TRANSACT (section [2.2.4.62.1](#)) request with the subcommand NT_TRANSACT_SET_SECURITY_DESC. The application

MUST provide the **Client.Open** of the target file. The application MUST also provide a list of the security descriptor fields to be set and the security descriptors to be updated.

The client MUST construct the NT_TRANSACT_SET_SECURITY_DESC request message as specified in section [2.2.7.3.1](#). The request MUST be sent to the server as described in section [3.2.4.1](#).

3.2.4.42 Application Requests a Named RAP Transaction

An application can perform Remote Administration Protocol (RAP) operations from CIFS. The application MUST provide **Client.Session** and **Client.TreeConnect**. **Client.TreeConnect.ShareName** MUST indicate the IPC\$ interprocess communications share.

The SMB Transaction subprotocol (SMB_COM_TRANSACTION and SMB_COM_TRANSACTION_SECONDARY) is used to transfer RAP operations. RAP uses the \PIPE\LANMAN named pipe in the IPC\$ share. RAP has its own set of function codes and does not use the Transaction subcommands listed in section [2.2.5](#). For a full decryption, see [\[MS-RAP\]](#).

3.2.4.43 DFS Subsystem Notifies That It Is Active

If the DFS subsystem is available to the CIFS client, it MUST notify the client. After this event, the client is able to set the CAP_DFS flag in the **Capabilities** field of an SMB_COM_SESSION_SETUP_ANDX request. [<207>](#)

3.2.4.44 Application Requests Querying DFS Referrals

The application provides the following:

- **ServerName**: The name of the server from which to query referrals.
- **UserCredentials**: An opaque implementation-specific entity that identifies the credentials to be used when authenticating to the remote server.
- The maximum response size, in bytes.
- An input buffer containing the application-provided **REQ_GET_DFS_REFERRAL** structure.

The client MUST search for an existing **Session** and **TreeConnect** to any share on the server identified by **ServerName** for the user identified by **UserCredentials**. If no **Session** and **TreeConnect** are found, the client MUST establish a new **Session** and **TreeConnect** to IPC\$ on the target server, as specified in section [3.2.4.2](#) using the supplied **ServerName** and **UserCredentials**.

The client MUST construct a [TRANS2_GET_DFS_REFERRAL Request](#) and MUST set ReferralRequest to the application-provided input buffer.

The client MUST construct a TRANS2_GET_DFS_REFERRAL Request (section 2.2.6.16.1) and MUST set ReferralRequest to the application-provided input buffer. The **MaxDataCount** field of the [SMB_COM_TRANSACTION2 Request \(section 2.2.4.46.1\)](#) MUST be set to the maximum response size supplied by the caller. The client MUST issue the TRANS2_GET_DFS_REFERRAL Request using the **Client.TreeConnect.TreeID** of the IPC\$ share.

3.2.4.45 Application Requests Querying Cryptographic Session Key

The application MUST provide:

- **Open**: A valid **Open** identifying an open instance of a file or pipe.

The client MUST find the application-supplied **Open** in **Client.Connection.OpenTable**. It MUST then return **Client.Open.Session.SessionKey** to the calling application.

3.2.4.46 Application Requests Number of Opens on a Tree Connect

The application provides:

- **Client.TreeConnect**: A valid tree connect to be queried.

The client MUST query the total number of opens on **Client.TreeConnect** by looking up the **Client.Connection.OpenTable** where **Client.Open.TreeConnect** matches the application-supplied **Client.TreeConnect**, and return the matching count to the calling application.

3.2.5 Processing Events and Sequencing Rules

3.2.5.1 Receiving Any Message

Upon receiving any SMB message, the client MUST associate the message received with the correct client process and thread, as identified by the PID and **MID** values in the **Client.Connection.PIDMIDList**. If the **MID** value is the reserved value 0xFFFF ((USHORT)(-1)), the message can be an OpLock break sent by the server. Otherwise, if the PID and **MID** values of the received message are not found in the **Client.Connection.PIDMIDList**, the message MUST be discarded.

If an SMB_COM_RAW_READ is in progress and the message is a raw data transfer, the message MUST be handled as described in section [3.2.5.16](#).

Unless otherwise noted, the client MUST return the status received in the **SMB_Header.Status** field of a response message to the application that issued the corresponding request.

For the response messages of the following commands, there are no other processing rules required on the client:

- [SMB_COM_CREATE_DIRECTORY \(section 2.2.4.1\)](#)
- [SMB_COM_DELETE_DIRECTORY \(section 2.2.4.2\)](#)
- [SMB_COM_FLUSH \(section 2.2.4.6\)](#)
- [SMB_COM_DELETE \(section 2.2.4.7\)](#)
- [SMB_COM_RENAME \(section 2.2.4.8\)](#)
- [SMB_COM_SET_INFORMATION \(section 2.2.4.10\)](#)
- [SMB_COM_LOCK_BYTE_RANGE \(section 2.2.4.13\)](#)
- [SMB_COM_UNLOCK_BYTE_RANGE \(section 2.2.4.14\)](#)
- [SMB_COM_CHECK_DIRECTORY \(section 2.2.4.17\)](#)
- [SMB_COM_PROCESS_EXIT \(section 2.2.4.18\)](#)
- [SMB_COM_SET_INFORMATION2 \(section 2.2.4.30\)](#)
- [SMB_COM_LOCKING_ANDX \(section 2.2.4.32\)](#)
- [SMB_COM_TREE_DISCONNECT \(section 2.2.4.51\)](#)

- [SMB_COM_FIND_CLOSE \(section 2.2.4.61\)](#)
- [SMB_COM_NT_RENAME \(section 2.2.4.66\)](#)
- [SMB_COM_WRITE_PRINT_FILE \(section 2.2.4.68\)](#)
- [SMB_COM_CLOSE_PRINT_FILE \(section 2.2.4.69\)](#)
- [Transaction Subcommands \(section 2.2.5\)](#)
 - [TRANS_SET_NMPIPE_STATE \(section 2.2.5.1\)](#)
 - [TRANS_WAIT_NMPIPE \(section 2.2.5.10\)](#)
- [Transaction2 Subcommands \(section 2.2.6\)](#)
 - [TRANS2_SET_PATH_INFORMATION \(section 2.2.6.7\)](#)
 - [TRANS2_SET_FILE_INFORMATION \(section 2.2.6.9\)](#)
- [NT Transact Subcommands \(section 2.2.7\)](#)
 - [NT_TRANSACT_SET_SECURITY_DESC \(section 2.2.7.3\)](#)

A client that has outstanding OpLocks can receive an OpLock Break Notification at any time from the server. This is the only unsolicited message that the server is permitted to send.

3.2.5.1.1 Command Processing

Upon receiving a message, the client MUST determine whether the message is the final step in the processing of a command. If so, the **Client.Connection.PIDMIDList** entry for the command MUST be removed and discarded. Unless otherwise stated, the processing of an SMB command is complete when the results are returned to the application.

3.2.5.1.2 Message Signing

If a message is received and **Client.Connection.IsSigningActive** is TRUE for the connection, the signature MUST be verified, as specified in section [3.1.5.1](#), unless the message is an OpLock Break Notification. OpLock Break Notification messages are exempt from signing.

The client is responsible for providing the expected sequence number for signature verification. The sequence number for the incoming response is determined by what was stored in the **Client.Connection.ClientResponseSequenceNumber** table. The client MUST look up the expected sequence number in that table based on the PID and MID of the response. The client uses **Client.Connection.ClientResponseSequenceNumber** [PID, MID] as the sequence number in signature verification, as specified in section [3.1.5.1](#). If signature verification fails, the message MUST be discarded and not processed. The client SHOULD choose to disconnect the underlying connection and tear down all state associated with this connection. [<208>](#)

3.2.5.1.3 Receiving any Batched ("AndX") Response

When a client receives an AndX Response, the client MUST process the batched responses sequentially. Each individual response is processed as specified in its respective Message Processing subsection.

The client MUST use the information in the AndX Response header as the header information for each response, with the exception of the **SMB_Header.Status** field. The status field indicates only

the error status of the last response in the chain. All other responses in the chain MUST be interpreted as having completed successfully. If processing a response in the AndX Chain causes a change in state that would affect the information in the header, the updated header information MUST be used when the client processes the subsequent response in the chain.

3.2.5.1.4 Receiving Any Transaction Response

When a client receives an SMB transaction response, it MUST first determine whether it is an interim response or a final response by looking up the **TransactionState** for this request in **Client.Connection.PIDMIDList**. If the **TransactionState** is "TransmittedPrimaryRequest", and if the **SMB_Parameters.WordCount** and **SMB_Data.ByteCount** values are 0 in the transaction response, the client MUST consider the received response an interim response.

- If the interim response indicates an error, then the transaction is canceled. The client MUST NOT send any secondary transaction request messages.
- If the interim response indicates success, then the client MUST set the **TransactionState** for this request (in **Client.Connection.PIDMIDList**) to "ReceivedInterimResponse" and send as many secondary requests as are needed to complete the transfer of transaction parameters and data. After transmitting all the secondary requests, the client MUST set the **TransactionState** for this request to "TransmittedAllRequests".

If the **TransactionState** is not "TransmittedPrimaryRequest", or if the **SMB_Parameters.WordCount** and **SMB_Data.ByteCount** values are not both 0 in the transaction response, the client MUST consider the received response as a final transaction response. The server can send multiple final SMB transaction response messages in order to transfer the entire transaction response. If multiple final SMB transaction response messages are needed, the client MUST reconstruct the transaction response parameters and transaction response data from the contents of the SMB response messages before processing the completed transaction response.

3.2.5.2 Receiving an SMB_COM_NEGOTIATE Response

If the **Status** field of the response does not contain STATUS_SUCCESS, or if the server refused the SMB dialects offered by the client, the client MUST propagate the error to the application that initiated the SMB connection. In either case, protocol negotiation has failed and the SMB connection SHOULD be closed.

Otherwise, protocol negotiation has succeeded and the SMB connection has been established. Processing of the [SMB_COM_NEGOTIATE Response \(section 2.2.4.52.2\)](#) proceeds as follows:

Storing the selected dialect

The selected dialect MUST be retrieved and stored as described in section [3.2.4.2.2](#).

Storing authentication settings

The server's access control level is indicated by the NEGOTIATE_USER_SECURITY (0x01) bit of the **SecurityMode** field in the SMB_COM_NEGOTIATE Response. If this bit is clear (0), **Client.Connection.ShareLevelAccessControl** (which was initialized to FALSE in section [3.2.3](#)) MUST be set to TRUE.

Support for challenge/response authentication is indicated by the NEGOTIATE_ENCRYPT_PASSWORDS (0x02) bit of the **SecurityMode** field in the SMB_COM_NEGOTIATE Response. If this bit is set (1),

Client.Connection.ServerChallengeResponse (which was initialized to FALSE in section [3.2.3](#)) MUST be set to TRUE.

Determining the server signing mode

The server response indicates whether the server has message signing enabled and, if so, whether or not message signing is expected:

- If the server supports only Share Level Access Control or plaintext passwords, signing is not available and **Client.Connection.ServerSigningState** MUST be **Disabled**.
- If NEGOTIATE_SECURITY_SIGNATURES_ENABLED bit in the **SecurityMode** field of the SMB_COM_NEGOTIATE response is not set, **Client.Connection.ServerSigningState** MUST be **Disabled**.
- If the NEGOTIATE_SECURITY_SIGNATURES_ENABLED bit in the **SecurityMode** field of the SMB_COM_NEGOTIATE Response is set, but NEGOTIATE_SECURITY_SIGNATURES_REQUIRED is not set, the client MUST set **Client.Connection.ServerSigningState** to **Enabled**.
- If both the NEGOTIATE_SECURITY_SIGNATURES_ENABLED and NEGOTIATE_SECURITY_SIGNATURES_REQUIRED bits in the **SecurityMode** field of the SMB_COM_NEGOTIATE response are set, the client MUST set **Client.Connection.ServerSigningState** to **Required**.

Once **Client.Connection.ServerSigningState** is set, the client MUST consult the table under "Signing" in [User Authentication \(section 3.2.4.2.4\)](#) to determine whether or not signing is blocked. If signing is blocked, the connection SHOULD be terminated by disconnecting the underlying transport and tearing down any state associated with the connection.

Storing server parameters

The client MUST store the **Capabilities** returned in the SMB_COM_NEGOTIATE Response in **Client.Connection.ServerCapabilities**.

The client MUST set **Client.Connection.ServerSessionKey** to the value received in the **SessionKey** field of the SMB_COM_NEGOTIATE Response.

The client MUST set the **Client.Connection.NTLMChallenge** to the value returned in the **Challenge** field of the SMB_COM_NEGOTIATE server response. This value is used for all future challenge/response authentication operations performed on the connection.

The client MUST set **Client.Connection.ServerMaxBufferSize** to the value received in the **MaxBufferSize** field of the negotiate response.

The client MUST assign the minimum of **Client.Connection.MaxMpxCount** and the **MaxMpxCount** field to **Client.Connection.MaxMpxCount**.

If the SMB_COM_NEGOTIATE Response is being processed as part of a connect attempt, the client continues to user authentication, as specified in section [3.2.4.2.4](#). The only other options are [SMB_COM_ECHO \(section 2.2.4.39\)](#) or termination of the connection.

3.2.5.3 Receiving an SMB_COM_SESSION_SETUP_ANDX Response

If the **Status** field of the response does not contain STATUS_SUCCESS, the client MUST propagate the error to the application that initiated the authentication. The connection MUST remain open for the client to attempt another authentication.

If the **Status** field of the response contains STATUS_SUCCESS, then authentication was successful, and a new **Client.Session** MUST be initialized and stored in **Client.Connection.SessionTable**.

The client MUST retain the **UID** returned in the SMB Header (section [2.2.3.1](#)) of the response in **Client.Session.SessionUID**. The client MUST also set the value of the **Client.Session.SessionKey** based upon the SMB_SETUP_USE_LANMAN_KEY (0x02) bit of the Action field in the SMB_COM_SESSION_SETUP_ANDX response. If the bit is set, and if LM challenge/response was used instead of LMv2 challenge/response, the server indicates that LM challenge/response succeeded and the LM Session Key MUST be used to set **Client.Session.SessionKey**. If the bit is clear or if the LMv2 response was sent, the NT Session Key MUST be used to set **Client.Session.SessionKey**. If the LM Session Key or NT Session Key is equal to or greater than 16 bytes, only the least significant 16 bytes MUST be stored in **Client.Session.SessionKey**. Otherwise, the session key MUST be stored in **Client.Session.SessionKey** and MUST be padded with zeros up to 16 bytes.

Activating Signing

If authentication has just completed successfully, **Client.Connection.IsSigningActive** is FALSE, and the targeted behavior for this connection is **Signed** based on the description in section [3.2.4.2.4](#), then the client MUST determine whether signing needs to be activated. This is done by determining the user's security context that completed authentication:

- If the user authenticated as a guest (the SMB_SETUP_GUEST flag is set in the **Action** field of the SMB_COM_SESSION_SETUP_ANDX response) or is anonymous (did not provide credentials), signing MUST NOT be activated.
- If the user authenticated as a regular user, the client MUST activate signing. If **Client.Connection.SigningSessionKey** is **Empty**:
 - The client MUST copy the entire cryptographic session key obtained from authentication subsystem, as specified in [\[MS-NLMP\]](#), and store it as **Client.Connection.SigningSessionKey**. If the length of **Client.Connection.SigningSessionKey** is less than 16, the client SHOULD pad it with zeros up to 16 bytes.
 - The value of **Client.Connection.SigningChallengeResponse** MUST be set based upon the SMB_SETUP_USE_LANMAN_KEY (0x02) bit of the **Action** field in the SMB_COM_SESSION_SETUP_ANDX response sent from the server to the client. If the bit is set, the server indicates that the LM or LMv2 challenge/response succeeded and the challenge response sent in the **OEMPassword** field MUST be used. Otherwise, the challenge response sent in the **UnicodePassword** field MUST be used.

Once these steps are done, the client MUST verify the signature of this response. The client follows the steps specified in section [3.1.5.1](#), passing in a sequence number of 1 because this is the first signed packet.

3.2.5.4 Receiving an SMB_COM_TREE_CONNECT or SMB_COM_TREE_CONNECT_ANDX Response

The response MUST be received as specified in section [3.2.5.1](#).

If the tree connect was successful, a new **Client.TreeConnect** entry is initialized and stored in **Client.Connection.TreeConnectTable**. The **TID** returned in the [SMB Header \(section 2.2.3.1\)](#) of the response can now be used for other operations. The client MUST set **Client.TreeConnect.Session** to **Client.Session**, where **Client.Session.SessionUID** matches the **UID** field in the response. The client MUST return the new **Client.TreeConnect** and the

Client.Session to the application that invoked the [Application Requests Connecting to a Share \(section 3.2.4.2\)](#) event to connect to the share. The client sets the share type based on the **Service** string in the response.

Share type	Service string
Disk Share	"A:"
Printer Share	"LPT1:"
Named Pipe	"IPC"
Serial Communications Device	"COMM"
unknown	None of the above

3.2.5.5 Receiving an SMB_COM_OPEN Response

The [SMB_COM_OPEN Response \(section 2.2.4.3.2\)](#) MUST be processed as specified in section [3.2.5.1](#).

If the [SMB_COM_OPEN \(section 2.2.4.3\)](#) command was successful, a new **Client.Open** MUST be entered into the **Client.Connection.OpenTable**. **Client.Open.FID** is set to the returned **FID**, and **Client.Open.OpLock** is set based on the **SMB_Header.Flags SMB_FLAGS_OPLOCK** and **SMB_FLAGS_OPBATCH** flags. **Client.Open.TreeConnect** MUST be set to a **Client.TreeConnect** where **Client.TreeConnect.TreeID** matches the **TID** sent by the server in the [SMB Header](#) of the SMB_COM_OPEN Response. **Client.Open.Session** MUST be set to a **Client.Session** where **Client.Session.SessionUID** matches the **UID** sent by the server in the SMB Header of the SMB_COM_OPEN Response. **Client.Open.Connection** MUST be set to **Client.Open.Session.Connection**.

The **FID** returned in the SMB_COM_OPEN response MUST be returned to the application along with the access mode granted by the server. The **Client.Open** that matches the **FID** in the response MUST be returned to the application. The additional metadata returned in the command MUST be returned to the application, if requested.

3.2.5.6 Receiving an SMB_COM_CREATE Response

The [SMB_COM_CREATE Response \(section 2.2.4.4.2\)](#) MUST be processed as specified in section [3.2.5.1](#).

If the [SMB_COM_CREATE](#) was successful, a new **Client.Open** MUST be entered into the **Client.Connection.OpenTable**. **Client.Open.FID** is set to the returned **FID**, and **Client.Open.OpLock** is set based on the **SMB_Header.Flags SMB_FLAGS_OPLOCK** and **SMB_FLAGS_OPBATCH** flags. **Client.Open.TreeConnect** MUST be set to a **Client.TreeConnect** where **Client.TreeConnect.TreeID** matches the **TID** sent by the server in the [SMB Header](#) of the SMB_COM_CREATE Response. **Client.Open.Session** MUST be set to a **Client.Session** where **Client.Session.SessionUID** matches the **UID** sent by the server in the SMB Header of the SMB_COM_CREATE Response. **Client.Open.Connection** MUST be set to **Client.Open.Session.Connection**.

The **Client.Open** matching the **FID** provided in the response MUST be returned to the application.

3.2.5.7 Receiving an SMB_COM_CLOSE Response

The SMB_COM_CLOSE response MUST be processed as specified in section [3.2.5.1](#).

If the request was successful, then the FID sent in the request is no longer valid and the client MUST discard the FID. The matching **Client.Open** entry in the **Client.Connection.OpenTable** MUST be removed and discarded.

3.2.5.8 Receiving an SMB_COM_QUERY_INFORMATION Response

The SMB_COM_QUERY_INFORMATION response MUST be processed as specified in section [3.2.5.1](#).

If the request was successful, the requested metadata MUST be returned to the application. The metadata returned by this command is also returned in the SMB_COM_OPEN response.

3.2.5.9 Receiving an SMB_COM_READ Response

The SMB_COM_READ response MUST be processed as specified in section [3.2.5.1](#).

If the request is successful, the number of bytes returned is specified in the **CountOfBytesReturned** field. The data read from the file are returned in a Data Buffer (see section [2.2.2.5](#)), which also specifies the number of bytes returned. Both the count of bytes returned and the read bytes themselves MUST be passed to the application. An end-of-file condition is indicated if the number of bytes returned is less than the number of bytes requested.

In the event of a STATUS_BUFFER_OVERFLOW (ERRDOS/ERRmoredata) error, the server MUST return a complete SMB_COM_READ response (not an error response). The **CountOfBytesReturned** field indicates the number of bytes successfully read.

3.2.5.10 Receiving an SMB_COM_WRITE Response

The SMB_COM_WRITE response MUST be processed as specified in section [3.2.5.1](#).

If the request is successful, the number of bytes written to the file is returned. This number MUST be reported to the application.

3.2.5.11 Receiving an SMB_COM_CREATE_TEMPORARY Response

The [SMB_COM_CREATE_TEMPORARY Response \(section 2.2.4.15.2\)](#) MUST be processed as specified in section [3.2.5.1](#).

If the [SMB_COM_CREATE_TEMPORARY](#) was successful, a new **Client.Open** must be entered into the **Client.Connection.OpenTable**. **Client.Open.FID** is set to the returned **FID**, and **Client.Open.OpLock** is set based on the **SMB_Header.Flags** SMB_FLAGS_OPLOCK and SMB_FLAGS_OPBATCH flags. **Client.Open.TreeConnect** MUST be set to a **Client.TreeConnect** where **Client.TreeConnect.TreeID** matches the **TID** sent by the server in the [SMB Header](#) of the SMB_COM_CREATE_TEMPORARY Response. **Client.Open.Session** MUST be set to a **Client.Session** where **Client.Session.SessionUID** matches the **UID** sent by the server in the SMB Header of the SMB_COM_CREATE_TEMPORARY Response. **Client.Open.Connection** MUST be set to **Client.Open.Session.Connection**.

The **Client.Open** matching the **FID** provided in the response MUST be returned to the application. In addition, the name of the temporary file created by the server can be returned to the application, if requested.

3.2.5.12 Receiving an SMB_COM_CREATE_NEW Response

The SMB_COM_CREATE_NEW response MUST be processed as specified in section [3.2.5.1](#).

If the SMB_COM_CREATE_NEW was successful, a new **Client.Open** must be entered into the **Client.Connection.OpenTable**. **Client.Open.FID** is set to the returned **FID**, and **Client.Open.OpLock** is set based on the **SMB_Header.Flags** SMB_FLAGS_OPLOCK and SMB_FLAGS_OPBATCH flags.

The **Client.Open** matching the **FID** provided in the response MUST be returned to the application.

3.2.5.13 Receiving an SMB_COM_SEEK Response

The SMB_COM_SEEK response MUST be processed as specified in section [3.2.5.1](#).

If the request was successful, the current offset within the specified file is returned. The offset value MUST be passed to the application. If an error status is returned (see section [2.2.4.19.2](#) for a list of possible errors and their causes), the error status MUST be passed to the application.

If the CAP_LARGE_FILES capability has been negotiated, then the client and server support 64-bit file offsets. The SMB_COM_SEEK command, however, supports only 32-bit offset values. The server MUST return only the lower order 32 bits of the actual 64-bit offset. If the file is larger than $2^{32} - 1$ bytes in size, the offset returned by the server MAY be an invalid value. [<209>](#)

3.2.5.14 Receiving an SMB_COM_LOCK_AND_READ Response

The SMB_COM_LOCK_AND_READ response MUST be processed as specified in section [3.2.5.1](#).

If the request is successful, the number of bytes returned is specified in the **CountOfBytesReturned** field. The data read from the file are returned in a Data Buffer (see section [2.2.2.5](#)), which also specifies the number of bytes returned. Both the count of bytes returned and the read bytes themselves MUST be passed to the application. An end-of-file condition is indicated if the number of bytes returned is less than the number of bytes requested.

The range of bytes indicated in the corresponding request message is also locked by the application.

3.2.5.15 Receiving an SMB_COM_WRITE_AND_UNLOCK Response

The SMB_COM_WRITE_AND_UNLOCK response MUST be processed as specified in section [3.2.5.1](#).

If the request is successful, the number of bytes written to the file is returned and the byte range is unlocked. The number of bytes written MUST be reported to the application.

3.2.5.16 Receiving an SMB_COM_READ_RAW Response

The SMB_COM_READ_RAW response is a transfer of raw bytes from the server to the client. There is no SMB header, parameter block, or data block. Therefore, the SMB_COM_READ_RAW response MUST NOT be processed as specified in section [3.2.5.1](#). Instead, the client MUST query the SMB transport to determine the number of bytes received:

- If the request was made to read from a regular file and the number of bytes received is less than the number requested, then the end of file has been reached.
- If the number of bytes returned is zero, then the read began at or beyond the end of file (for a regular file) or an error occurred.

It is possible that an OpLock break event on the server can cause the server to send an OpLock Break Notification request to the client at approximately the same time that the client sends an SMB_COM_READ_RAW request. If this happens, the OpLock Break Notification request can arrive

before the Raw Read response from the server. In order to avoid confusing the OpLock break with the Raw Read response, the client MUST perform the following tests:

- If the client currently holds an OpLock on an open file on the server, and
- If the message received is the size of an OpLock Break Notification request (51 bytes), and
- If the first four bytes of the data received are equal to '\x0', 'S', 'M', 'B', and
- If the fifth byte in the data received is equal to the value of SMB_COM_LOCKING_ANDX (0x24), and
- If the value at the correct offsets for MID is 0xFFFF ((USHORT)(-1)), then

The likelihood that the message received is an OpLock Break Notification request is very high. The client MAY apply these further tests to minimize the chance of a false positive:

- The SMB_FLAGS_REPLY bit in an OpLock break MUST be clear in the appropriate location for the **SMB_Header.Flags** field.
- The **NumberOfRequestedUnlocks** and **NumberOfRequestedLocks** fields MUST both be zero in an OpLock break.

If these conditions are met, the client MUST perform as if it has received an OpLock Break Notification and MUST process the message accordingly. The server, having received the Raw Read request while an OpLock break is still outstanding, responds to the Raw Read request by sending a zero-length response.

After responding to the OpLock break, the client SHOULD use a different READ command to retry the failed Raw Read request.

3.2.5.17 Receiving an SMB_COM_READ_MPX Response

A single SMB_COM_READ_MPX request can generate multiple response messages. If there is one SMB_COM_READ_MPX response, it either contains all of the data read from the FID, or it indicates an error return.

The SMB_COM_READ_MPX response MUST be processed as specified in section [3.2.5.1](#), with the exception that the SMB_COM_READ_MPX command is supported only over connectionless transports, and signing is supported only over connection-oriented transports. Therefore, SMB_COM_READ_MPX messages are not signed.

The client MUST verify that all of the replies have the same **MID**, **PID**, and **FID** values, indicating that they are all responses to the same request. The response messages MAY be received in any order, so the client MUST use the **Offset** and **DataLength** fields to reorder the read data correctly. The client MUST check the **Count** field in every response. The lowest **Count** value received indicates the total number of bytes that the server returns to the client. When the sum of all **DataLength** fields is equal to the lowest **Count** value received, all replies have been received.

3.2.5.18 Receiving an SMB_COM_WRITE_RAW Response

After sending an SMB_COM_WRITE_RAW request, the client expects one of two possible responses: an Initial Server Response or a Final Server Response.

- If the client receives a [Final Server Response \(section 2.2.4.25.3\)](#), the command has completed, possibly with an error. The client MUST extract the **Status** and **Count** fields. The client MUST

return the status information and the number of bytes successfully written by the command to the application. Response processing is then complete.

- If the client receives an [Interim Server Response \(section 2.2.4.25.2\)](#), the command is has been processed successfully and the server is waiting for the remainder of the data to be sent in raw mode. The client MUST transfer the remaining data in raw mode (no SMB header, parameters, or data block) via the SMB transport.
- If **WritethroughMode** was set in the **WriteMode** field of the original request, the client MUST expect a Final Server Response following the Initial Server Response and the transfer of raw data. The Final Server Response can indicate an error. The client MUST return the status information and the number of bytes successfully written by the command to the application. Response processing is then complete.
- If **WritethroughMode** was not set in the **WriteMode** field of the original request, then the client MUST NOT expect a Final Server Response. The client MUST return a status value of Success to the application, and indicate that all bytes sent were successfully written.
- If an error occurred on the server while writing the raw data, the error MUST be returned on the next client command request that makes use of the same FID. The client MAY retrieve a pending error code by sending, for example, a Seek request that seeks to the current file position (effectively, a null operation).

3.2.5.19 Receiving an SMB_COM_WRITE_MPX Response

Upon receipt of an SMB_COM_WRITE_MPX response, the client MUST compare the **ResponseMask** against the **RequestMask** of each SMB_COM_WRITE_MPX request that was sent as part of the same exchange. Any request that is not indicated as having been received in the **ResponseMask** MUST be resent. The last request to be resent MUST include the same nonzero **SequenceNumber** that was previously used in this exchange.

The server MUST send another SMB_COM_WRITE_MPX response upon receipt of the resent request with the nonzero **SequenceNumber**. The client MUST compare the **ResponseMask** against the **RequestMask** of each resent SMB_COM_WRITE_MPX request. Again, any request that is not indicated as having been received in the **ResponseMask** MUST be resent, and the last resent request MUST include the nonzero **SequenceNumber** that was previously used in this exchange. This cycle continues until an error return is received, or until all of the requests are successfully acknowledged.

If **WritethroughMode** was not set in the **WriteMode** field of the request(s), then an error in processing the command MAY occur after the final SMB_COM_WRITE_MPX response has been sent by the server. The server MUST return the error on the next client command request that makes use of the same FID.

If an error response is received in an SMB_COM_WRITE_MPX response, the Write MPX exchange is concluded and the client MUST inform the application of the error received.

The SMB_COM_WRITE_MPX response(s) MUST be processed as specified in section [3.2.5.1](#) with the exception that the SMB_COM_WRITE_MPX command is supported only over connectionless transports, and signing is supported only over connection-oriented transports. Therefore, SMB_COM_WRITE_MPX messages are not signed.

3.2.5.20 Receiving an SMB_COM_QUERY_INFORMATION2 Response

The SMB_COM_QUERY_INFORMATION2 response MUST be processed as specified in section [3.2.5.1](#).

If the request is successful, the file attribute information MUST be reported to the application.

3.2.5.21 Receiving an SMB_COM_TRANSACTION Response

The SMB_COM_TRANSACTION Response is processed as described in section [3.2.5.1.4](#).

3.2.5.22 Receiving an SMB_COM_IOCTL Response

The SMB_COM_IOCTL response MUST be processed as described in section [3.2.5.1](#).

If the **Status** field indicates an error, the error MUST be passed to the application. Otherwise, the SMB_COM_IOCTL MUST be unpacked as described in section [2.2.4.35.2](#), and the results MUST be returned to the application. The format of the results of the IOCTL are specific to the platform, device type, and function called.

3.2.5.23 Receiving an SMB_COM_ECHO Response

The SMB_COM_ECHO response MUST be processed as described in section [3.2.5.1](#). If no SMB session has yet been established (no SMB_COM_SESSION_SETUP_ANDX command has been executed) then **Client.Connection.IsSigningActive** MUST be FALSE, and the SMB_COM_ECHO response is not signed.

Any error received as a result of this command MUST be returned to the application (Note, however, that an error response is a response from the server, which verifies that the connection is still active.)

Multiple responses may be received, each of which MUST be made available to the application. The application can discard the responses, or count them, or verify that the data returned matches the data originally transmitted.

3.2.5.24 Receiving an SMB_COM_WRITE_AND_CLOSE Response

The [SMB_COM_WRITE_AND_CLOSE Response \(section 2.2.4.40.2\)](#) MUST be processed as specified in section [3.2.5.1](#).

If the request succeeds, the FID sent in the request is no longer valid, and the client MUST discard the FID. The matching **Client.Open** entry in the **Client.Connection.OpenTable** MUST be removed and discarded.

3.2.5.25 Receiving an SMB_COM_OPEN_ANDX Response

The [SMB_COM_OPEN_ANDX Response \(section 2.2.4.41.2\)](#) MUST be processed as specified in section [3.2.5.1](#).

If the command fails, the error status MUST be passed to the application.

If the request succeeds, the **FID** field returned in the SMB_COM_OPEN_ANDX Response MUST be returned to the application, along with the access mode granted by the server. If an OpLock was requested, the OpLock status MUST be returned to the application. If the REQ_ATTRIB flag was set in the **SMB_Parameters.Flags** field of the request, the following values MUST be returned to the application:

- FileAttrs
- LastWriteTime

- FileDataSize
- AccessRights
- ResourceType
- NMPipeStatus
- OpenResult

Other attributes returned in the command can be passed to the application, if requested.

In addition, the **FID** MUST be used to create new **Open** entry in the **Client.Connection.OpenTable**. If an OpLock was requested, the value of **Client.Open.OpLock** MUST be set to indicate the type of OpLock that was granted, if any. The newly-created **Client.Open** MUST be returned to the application. **Client.Open.TreeConnect** MUST be set to **Client.Connection.TreeConnectTable[TID]**, where the **TID** matches the **TID** field sent by the server in the [SMB Header \(section 2.2.3.1\)](#) of the SMB_COM_OPEN_ANDX Response. **Client.Open.Session** MUST be set to a **Client.Session** where **Client.Session.SessionUID** matches the **UID** sent by the server in the SMB Header of the SMB_COM_OPEN_ANDX Response. **Client.Open.Connection** MUST be set to **Client.Open.Session.Connection**.

3.2.5.26 Receiving an SMB_COM_READ_ANDX Response

The SMB_COM_READ_ANDX response MUST be processed as specified in section [3.2.5.1](#).

If the **Status** of the response indicates either success or that a time-out occurred, the client MUST forward any available data returned in the **Data** field to the application, along with the number of bytes returned, as indicated in the **DataLength** field.

If the application requested it, the client MUST forward the information in the **Available** field to the calling application.

In the event of a STATUS_BUFFER_OVERFLOW (ERRDOS/ERRmoredata) error, the server MUST return a complete SMB_COM_READ_ANDX response (not an error response). The **DataLength** field indicates the number of bytes successfully read.

3.2.5.27 Receiving an SMB_COM_WRITE_ANDX Response

The SMB_COM_WRITE_ANDX response MUST be processed as specified in section [3.2.5.1](#).

If the **Status** of the response indicates either success or that a time-out occurred, the client MUST return the **Status** and the number of bytes written to the application.

If the application requested it, the client MUST also forward the information in the **Available** field to the calling application.

3.2.5.28 Receiving an SMB_COM_TRANSACTION2 Response

The SMB_COM_TRANSACTION Response MUST be processed as specified in section [3.2.5.1.4](#).

3.2.5.29 Receiving an SMB_COM_FIND_CLOSE2 Response

The SMB_COM_FIND_CLOSE2 response MUST be processed as specified in section [3.2.5.1](#).

If the SMB_COM_FIND_CLOSE2 request succeeds, the **SID** that was indicated in the **SearchHandle** field of the initial request is closed and MUST be discarded. The

Client.Connection.SearchOpenTable entry with a **SearchOpen.FindSID** matching the closed SID MUST be removed from **Connection.SearchOpenTable** and discarded.

3.2.5.30 Receiving an SMB_COM_TREE_DISCONNECT Response

The SMB_COM_TREE_DISCONNECT response MUST be processed as specified in section [3.2.5.1](#).

If the SMB_COM_TREE_DISCONNECT succeeds, the **TID** that was indicated in the [SMB Header \(section 2.2.3.1\)](#) of the initial request is no longer valid and MUST be discarded.

The **Client** MUST traverse the **Client.Connection.OpenTable** and remove all **Opens** for which the **Client.Open.TreeConnect** matches the **TID** in the request. The client MUST also traverse the **Client.Connection.SearchOpenTable** and release all **SearchOpens** for which the **Client.SearchOpen.TreeConnect** matches the **TID** in the request. The client MUST also traverse the **Client.Connection.TreeConnectTable** and remove the **TreeConnect** for which the **Client.TreeConnect** matches the TID in the request.

3.2.5.31 Receiving an SMB_COM_LOGOFF_ANDX Response

The [SMB_COM_LOGOFF_ANDX Response \(section 2.2.4.54.2\)](#) MUST be processed as specified in section [3.2.5.1](#).

If the [SMB_COM_LOGOFF_ANDX \(section 2.2.4.54\)](#) succeeds, the **UID** that was indicated in the [SMB Header \(section 2.2.3.1\)](#) of the initial request is no longer valid and MUST be discarded. The **Client.Session** entry for the **UID** in the **Client.Connection.SessionTable** MUST be removed.

3.2.5.32 Receiving an SMB_COM_QUERY_INFORMATION_DISK Response

The SMB_COM_QUERY_INFORMATION_DISK response MUST be processed as specified in section [3.2.5.1](#).

If the command succeeds, the file system attributes in the response MUST be returned to the application.

3.2.5.33 Receiving an SMB_COM_SEARCH or SMB_COM_FIND Response

The SMB_COM_SEARCH and SMB_COM_FIND response messages MUST be processed as specified in section [3.2.5.1](#).

Upon receiving an SMB_COM_SEARCH or SMB_COM_FIND response from the server, the client MUST determine whether the response indicates success or an error. If an error **Status** is returned, it MUST be passed to the application. Otherwise, the client MUST return the number of entries retrieved, as well as the array of entries.

The application MUST determine whether to issue another request for the next set of entries, if any. If so, the client MUST create a new **Client.SearchOpen** and store it in **Client.Connection.SearchOpenTable**. If the command is SMB_COM_FIND, the application MUST determine when to send the SMB_COM_FIND_CLOSE to free the search context.

3.2.5.34 Receiving an SMB_COM_FIND_UNIQUE Response

The handling of this response is identical to the handling of an SMB_COM_FIND, except that the search is completed after a single response. It is not possible to continue to search, because no search context is stored on the server. No SMB_COM_FIND_CLOSE is needed, because it is implied in the request.

3.2.5.35 Receiving an SMB_COM_NT_TRANSACT Response

The SMB_COM_NT_TRANSACT response MUST be processed as specified in section [3.2.5.1.4](#).

3.2.5.36 Receiving an SMB_COM_NT_CREATE_ANDX Response

The [SMB_COM_NT_CREATE_ANDX Response \(section 2.2.4.64.2\)](#) MUST be processed as specified in section [3.2.5.1](#).

If the command fails, the error status MUST be passed to the application.

If the request succeeds, the **FID** returned in the SMB_COM_NT_CREATE_ANDX Response MUST be returned to the application, along with the access mode granted by the server. If an OpLock was requested, the OpLock status, including the OpLock level granted, MUST be returned to the application.

Other attributes returned in the command can be passed to the application, if requested.

In addition, the **FID** MUST be used to create new **Open** entry in the **Client.Connection.OpenTable**. If an OpLock was requested, the value of **Client.Open.OpLock** MUST be set to indicate the type of OpLock that was granted, if any. The newly-created **Client.Open** MUST be returned to the application. **Client.Open.TreeConnect** MUST be set to **Client.Connection.TreeConnectTable[TID]**, where the **TID** matches the **TID** field sent by the server in the [SMB Header \(section 2.2.3.1\)](#) of the SMB_COM_NT_CREATE_ANDX Response. **Client.Open.Session** MUST be set to a **Client.Session** where **Client.Session.SessionUID** matches the **UID** sent by the server in the SMB Header of the SMB_COM_NT_CREATE_ANDX Response. **Client.Open.Connection** MUST be set to **Client.Open.Session.Connection**.

If the open is to a named pipe, **Client.Open.NamedPipeMessageMode** MUST be initialized to TRUE, indicating a message mode named pipe.

3.2.5.37 Receiving an SMB_COM_OPEN_PRINT_FILE Response

The [SMB_COM_OPEN_PRINT_FILE Response \(section 2.2.4.62.2\)](#) MUST be processed as specified in section [3.2.5.1](#).

If the [SMB_COM_OPEN_PRINT_FILE \(section 2.2.4.67\)](#) command fails, the error status MUST be passed to the application.

If the request succeeds, the **FID** returned in the SMB_COM_OPEN_PRINT_FILE Response MUST be returned to the application. The **FID** MUST also be used to create a new entry in **Client.Connection.OpenTable**. If an OpLock was requested, the value of **Client.Open.OpLock** MUST be set to indicate the type of OpLock that was granted, if any. **Client.Open.TreeConnect** MUST be set to **Client.Connection.TreeConnectTable[TID]**, where the **TID** matches the **TID** field sent by the server in the [SMB Header \(section 2.2.3.1\)](#) of the SMB_COM_OPEN_PRINT_FILE Response. **Client.Open.Session** MUST be set to a **Client.Session** where **Client.Session.SessionUID** matches the **UID** sent by the server in the SMB Header of the SMB_COM_OPEN_PRINT_FILE Response. **Client.Open.Connection** MUST be set to **Client.Open.Session.Connection**.

The **Client.Open** matching the **FID** provided in the response MUST be returned to the application.

3.2.5.38 Receiving any SMB_COM_TRANSACTION Subcommand Response

SMB_COM_TRANSACTION and SMB_COM_TRANSACTION_SECONDARY provide a transport mechanism for extended sets of commands, known as subcommands. Transaction subcommand

responses MUST be extracted from the SMB_COM_TRANSACTION final response message or from messages returned by the server. The use of transactions to transport subcommands is described in sections [3.2.4.1.4](#) and [3.2.5.1.4](#).

The client MUST propagate the success or failure code in the SMB_COM_TRANSACTION response to the application that initiated the call. If additional information is returned by the subcommand, the handling of that information is described below.

3.2.5.38.1 Receiving a RAP Transaction Response

If the RAP request succeeds, the parameters and data returned in the RAP response MUST be passed to the application. See [\[MS-RAP\]](#) for RAP request and response information.

3.2.5.38.2 Receiving a TRANS_RAW_READ_NMPIPE Response

Upon receipt of a TRANS_RAW_READ_NMPIPE subcommand response, the client MUST forward the **BytesRead** buffer and the number of bytes read from the named pipe to the application. The number of bytes read (the size of **BytesRead**) is returned in the **TotalDataCount** field.

3.2.5.38.3 Receiving a TRANS_QUERY_NMPIPE_STATE Response

If the response indicates that the operation is successful, the client MUST return the information received in the **NMPipeStatus** field in the **Trans_Parameters** block of the response to the application that initiated the call.

3.2.5.38.4 Receiving a TRANS_QUERY_NMPIPE_INFO Response

If the response indicates that the operation is successful, the client MUST return the information received in the **Trans_Data** block of the response to the application that initiated the call.

3.2.5.38.5 Receiving a TRANS_PEEK_NMPIPE Response

Upon receipt of a TRANS_PEEK_NMPIPE subcommand response, the client MUST forward the **ReadData** buffer from within the **Trans_Data** block, along with the number of bytes read from the named pipe, to the application. The number of bytes read (the size of **ReadData**) is returned in the **TotalDataCount** field.

If the response indicates that the operation is successful, the client MUST return the information received in the **Trans_Parameters** block of the response to the application that initiated the call.

3.2.5.38.6 Receiving a TRANS_TRANSACT_NMPIPE Response

Upon receipt of a TRANS_TRANSACT_NMPIPE subcommand response, the client MUST forward the **ReadData** buffer from within the **Trans_Data** block, along with the number of bytes read from the named pipe, to the application. The number of bytes read (the size of **ReadData**) is returned in the **TotalDataCount** field.

In the event of a STATUS_BUFFER_OVERFLOW (ERRDOS/ERRmoredata) error, the server MUST return a complete SMB_COM_TRANSACTION response (not an error response). The **TotalDataCount** in the TRANS_TRANSACT_NMPIPE contained in the SMB_COM_TRANSACTION response indicates the number of bytes successfully read.

3.2.5.38.7 Receiving a TRANS_RAW_WRITE_NMPIPE Response

Upon receipt of a TRANS_RAW_WRITE_NMPIPE subcommand response, the client MUST return the number of bytes successfully written to the calling application. The number of bytes written is returned in the **BytesWritten** field in the **Trans_Parameters** block of the response.

3.2.5.38.8 Receiving a TRANS_READ_NMPIPE Response

Upon receipt of a TRANS_READ_NMPIPE subcommand response, the client MUST forward the **ReadData** buffer and the number of bytes read from the named pipe to the application. The number of bytes read (the size of **ReadData**) is returned in the **TotalDataCount** field.

In the event of a STATUS_BUFFER_OVERFLOW (ERRDOS/ERRmoredata) error, the server MUST return a complete SMB_COM_TRANSACTION response (not an error response) indicating that a message was incompletely read. The **TotalDataCount** in the TRANS_READ_NMPIPE contained in the SMB_COM_TRANSACTION response indicates the number of bytes successfully read.

3.2.5.38.9 Receiving a TRANS_WRITE_NMPIPE Response

Upon receipt of a TRANS_WRITE_NMPIPE subcommand response, the client MUST return the number of bytes successfully written to the calling application. The number bytes written is returned in the **BytesWritten** field in the **Trans_Parameters** block of the response.

3.2.5.38.10 Receiving a TRANS_CALL_NMPIPE Response

Upon receipt of a TRANS_CALL_NMPIPE subcommand response, the client MUST forward the **ReadData** buffer from within the **Trans_Data** block, along with the number of bytes read from the named pipe, to the application. The number of bytes read (the size of **ReadData**) is returned in the **TotalDataCount** field.

In the event of a STATUS_BUFFER_OVERFLOW (ERRDOS/ERRmoredata) error, the server MUST return a complete SMB_COM_TRANSACTION response (not an error response). The **TotalDataCount** in the TRANS_CALL_NMPIPE contained in the SMB_COM_TRANSACTION response indicates the number of bytes successfully read.

3.2.5.39 Receiving any SMB_COM_TRANSACTION2 Subcommand Response

3.2.5.39.1 Receiving a TRANS2_OPEN2 Response

If the TRANS2_OPEN2 subcommand response indicates an error, the **Status** MUST be passed to the application. If the error was caused by an attempt to set extended attribute name/value pairs, the client MUST also return the **ExtendedAttributeErrorOffset** returned in the TRANS2_OPEN2 response.

If the Open portion of the request succeeds, the **FID** returned in the TRANS2_OPEN2 subcommand response MUST be passed to the application, along with the access modes granted by the server. If an OpLock was requested, the OpLock level granted MUST be returned to the application.

Other attributes returned in the command can be passed to the application, if requested.

In addition, the **FID** MUST be used to create new **Open** entry in the **Client.Connection.OpenTable**. If an OpLock was requested, the value of **Client.Open.OpLock** MUST be set to indicate the type of OpLock that was granted, if any. The newly-created **Client.Open** MUST be returned to the application. **Client.Open.TreeConnect** MUST be set to **Client.Connection.TreeConnectTable[TID]**, where the **TID** matches the **TID** field sent by the

server in the [SMB Header \(section 2.2.3.1\)](#) of the [SMB_COM_TRANSACTION2 Response \(section 2.2.4.46.2\)](#). **Client.Open.Session** MUST be set to a **Client.Session** where **Client.Session.SessionUID** matches the **UID** sent by the server in the SMB Header of the SMB_COM_TRANSACTION2 Response. **Client.Open.Connection** MUST be set to **Client.Open.Session.Connection**.

3.2.5.39.2 Receiving a TRANS2_FIND_FIRST2 or TRANS2_FIND_NEXT2 Response

Upon receipt of a TRANS2_FIND_FIRST2 or TRANS2_FIND_NEXT2 subcommand response, the client MUST forward any errors to the application. If the search succeeds, or if the **Status** indicates an error in the processing of the **GetExtendedAttributeList** in the request, the client MUST determine whether the search has been closed by the server or is still active.

If the search is still active, the client MUST forward the **SID**, **EndOfSearch**, and **LastNameOffset** values to the application. Otherwise, the client MUST notify the application that the search has been closed.

If the search is still active, and the message is a TRANS2_FIND_FIRST2 subcommand response, the client MUST create a new **SearchOpen** entry in the **Server.Connection.SearchOpenTable** to store the returned **SID** and the associated **TreeConnect**.

Whether the search is closed or not, the client MUST also pass the **SearchCount** value to the application, along with the list of search entries returned in the **Trans2_Data** block of the response. If the value of **EaErrorOffset** is nonzero and the **Status** field indicates an error in the processing of the **GetExtendedAttributeList** in the request, the client MUST pass the value of **EaErrorOffset** to the application.

3.2.5.39.3 Receiving a TRANS2_QUERY_FS_INFORMATION Response

If the response indicates that an error occurred, the client MUST propagate the error to the application that initiated the call.

If the response indicates that the operation was successful, the client MUST return the information received in the **Trans2_Data** block of the response to the application that initiated the call.

3.2.5.39.4 Receiving a TRANS2_QUERY_PATH_INFORMATION or TRANS2_QUERY_FILE_INFORMATION Response

If the response indicates that an error occurred, the client MUST propagate the error to the application that initiated the call.

If the response indicates that the operation was successful, the client MUST return the information received in the **Trans2_Data** block of the response to the application that initiated the call.

3.2.5.39.5 Receiving a TRANS2_CREATE_DIRECTORY Response

The client MUST propagate the success or failure of the operation to the application that initiated the call.

If the **Status** field indicates that an error was generated when setting Extended Attributes on the directory, and the response message is not an error response, then the creation of the directory was successful, and MUST be reported as such to the application. In addition, the application MUST be informed of the failure to set EAs, and the **EaErrorOffset** MUST be passed back to the application.

3.2.5.39.6 Receiving a TRANS2_GET_DFS_REFERRAL Response

If the **Status** field indicates success, the contents of the Trans2_Data data block MUST be forwarded to the DFS subsystem for processing.

3.2.5.40 Receiving any SMB_COM_NT_TRANSACT Subcommand Response

3.2.5.40.1 Receiving an NT_TRANSACT_CREATE Response

If the [NT_TRANSACT_CREATE \(section 2.2.7.1\)](#) subcommand response indicates an error, the **Status** MUST be passed to the application. If the error was caused by an attempt to set extended attribute name/value pairs, the client MUST also return the **EAErrorOffset** returned in the [NT_TRANSACT_CREATE Response](#).

If the request succeeds, the **FID** returned in the **NT_TRANSACT_CREATE** subcommand response MUST be passed to the application, along with the access modes granted by the server. If an OpLock was requested, the OpLock level granted MUST be returned to the application.

Other attributes returned in the command can be passed to the application, if requested.

In addition, the **FID** MUST be used to create new **Open** entry in the **Client.Connection.OpenTable**. If an OpLock was requested, the value of **Client.Open.OpLock** MUST be set to indicate the type of OpLock that was granted, if any. The newly-created **Client.Open** MUST be returned to the application. **Client.Open.TreeConnect** MUST be set to **Client.Connection.TreeConnectTable[TID]**, where the **TID** matches the **TID** field sent by the server in the [SMB Header \(section 2.2.3.1\)](#) of the [SMB_COM_NT_TRANSACT Response \(section 2.2.4.62.2\)](#). **Client.Open.Session** MUST be set to a **Client.Session** where **Client.Session.SessionUID** matches the **UID** sent by the server in the SMB Header of the SMB_COM_NT_TRANSACT Response. **Client.Open.Connection** MUST be set to **Client.Open.Session.Connection**.

3.2.5.40.2 Receiving an NT_TRANSACT_IOCTL Response

If the response indicates that an error occurred, the client MUST propagate the error to the application that initiated the call. The response MAY be a complete NT_TRANSACT_IOCTL response, including the results of the IOCTL call that generated the error.

In any case, the client MUST return the information received in the **NT_Trans_Data.Data** block of the response to the application that initiated the call. The application MUST interpret the results of the IOCTL call. CIFS does not specify IOCTL functions; IOCTLs are platform-, device-, and implementation-specific.

3.2.5.40.3 Receiving an NT_TRANSACT_NOTIFY_CHANGE Response

If the response to an NT_TRANSACT_NOTIFY_CHANGE request is either a status of STATUS_NOTIFY_ENUM_DIR (ERRDOS/ERR_NOTIFY_ENUM_DIR) or success with no changed files listed, the server indicates that it is unable to report changes that MAY have occurred within the directory. If the client requires knowledge of the state of the directory, it MUST enumerate the directory entries to re-establish that knowledge.

Any other error response MUST be passed to the application that initiated the call. If the subcommand is successful, the list of changed directory entries MUST be returned to the application.

3.2.5.40.4 Receiving an NT_TRANSACT_QUERY_SECURITY_DESC Response

If the response indicates success, the security descriptors returned MUST be passed to the application that initiated the call. If the response indicates that an error occurred, the client MUST propagate the error to the application.

3.2.5.41 Receiving any OpLock Grant

If an open or create command response is received that indicates that an OpLock has been granted, the client MUST update the **Client.Open.OpLock** state variable to indicate the type of OpLock granted. The client can then cache file operations on the FID, as described in [\[FSBO\]](#).

3.2.5.42 Receiving an OpLock Break Notification

If an SMB_COM_LOCKING_ANDX request is received from the server, this indicates that the server has sent an OpLock Break Notification. This is the only event in which a client receives a request from the server. This message MUST be processed as specified in section [3.2.5.1](#), except that OpLock Break Notification messages are never signed.

If no entry in the **Client.Connection.OpenTable** state variable matches the FID supplied in the request, the request is ignored by the client. Otherwise:

- The client MUST use the **SMB_Parameters.NewOpLockLevel** field to determine the type of OpLock now in effect:
 - If **NewOpLockLevel** is 0x00, the client no longer possesses an OpLock on the file and the value of **Client.Open.OpLock** MUST be set to None.
 - If **NewOpLockLevel** is 0x01, a Level II OpLock is now in effect and the value of **Client.Open.OpLock** MUST be set to Level II.
- If the client previously held an exclusive or batch OpLock on the file, the client MUST flush any dirty buffers by sending write requests to the server to write changed data to the file.
- If the client no longer requires access to the file, the client MAY close the file. (This is common if a batch OpLock is held on the file, the application has closed the file, and the client has cached the application's file close request.) Closing the file is sufficient to acknowledge the OpLock break.
- If the client requires continued access to the file, it MUST obtain any cached byte-range locks. This is done by sending a lock request to the server.
- The client MUST acknowledge the OpLock Break by sending an OpLock Break Request message to the server. This is done by constructing an SMB_COM_LOCKING_ANDX request with the OPLOCK_RELEASE flag set in the **TypeOfLock** field. The **NumberOfRequestedUnlocks** field MUST be set to 0x0000. The client MAY use the OpLock Break Request message to request byte-range locks, thus combining this step with the previous step. The OpLock Break Request message is a special case of an SMB_COM_LOCKING_ANDX request used to acknowledge the OpLock Break Notification sent by the server.

In summary, upon receipt of an OpLock Break Notification from the server, the client MUST either:

- Close the file, or
- Write any unwritten data to the file, obtain any required byte-range locks, and acknowledge the OpLock Break by sending an OpLock Break Request message, which is an SMB_COM_LOCKING_ANDX request with the OPLOCK_RELEASE flag set.

All messages sent to the server in response to the OpLock Break Notification MUST be sent as described in the appropriate section. For example, the OpLock Break Request message must be sent as described in section [3.2.4.16](#).

3.2.5.43 Receiving a STATUS_PATH_NOT_COVERED (ERRSRV/ERRbadpath) Error for an Object in DFS

In response to any command request that uses a pathname, the receipt of this error indicates that the server's DFS subsystem does not cover the part of the DFS namespace needed to resolve a DFS path in the request.

If a DFS subsystem is present, on receiving this error the client MUST report the error to the DFS subsystem.

If no DFS subsystem is present, the client MUST report the error to the calling application that initiated the request.

3.2.6 Timer Events

3.2.6.1 Request Expiration Timer Event

When the [Request Expiration Timer \(section 3.2.2.1\)](#) expires, the client MUST walk the outstanding commands in **Client.Connection.PIDMIDList** for any pending commands that have exceeded **Client.SessionTimeoutValue**. If a command has exceeded **Client.SessionTimeoutValue**, [<210>](#) the client SHOULD [<211>](#) close the connection to the server, and all resources associated with the connection MUST be freed, as specified in section [3.2.7.1](#).

The [NT_TRANSACT_NOTIFY_CHANGE \(section 2.2.7.4\)](#) subcommand MUST be exempt.

The following commands are exempt from the Request Expiration Timer:

- The NT_TRANSACT_NOTIFY_CHANGE (section 2.2.7.4) subcommand
- Read and write commands issued on an **Open** to a named pipe via the following commands:
 - [SMB_COM_READ \(section 2.2.4.11\)](#)
 - [SMB_COM_WRITE \(section 2.2.4.12\)](#)
 - [SMB_COM_READ_ANDX \(section 2.2.4.42\)](#)
 - [SMB_COM_WRITE_ANDX \(section 2.2.4.43\)](#)
 - [SMB_COM_WRITE_AND_CLOSE \(section 2.2.4.40\)](#)
 - [TRANS_READ_NMPIPE \(section 2.2.5.8\)](#) subcommand
 - [TRANS_WRITE_NMPIPE \(section 2.2.5.9\)](#) subcommand
 - [TRANS_RAW_READ_NMPIPE \(section 2.2.5.2\)](#) subcommand
 - [TRANS_TRANSACT_NMPIPE \(section 2.2.5.6\)](#) subcommand
 - [TRANS_RAW_WRITE_NMPIPE \(section 2.2.5.7\)](#) subcommand
 - [TRANS_CALL_NMPIPE \(section 2.2.5.11\)](#) subcommand

- [TRANS_WAIT_NMPIPE \(section 2.2.5.10\)](#) subcommand
- [SMB_COM_LOCKING_ANDX Request \(section 2.2.4.32.1\)](#) with the **Timeout** field set to a nonzero value

3.2.7 Other Local Events

3.2.7.1 Handling a Transport Disconnect

When the transport indicates a disconnection, the client MUST walk through the **PIDMIDList** and return an error for each outstanding command to the calling application. All resources associated with the connection in **Client.ConnectionTable** MUST be freed. Finally, the connection MUST be freed.

3.3 Server Details

3.3.1 Abstract Data Model

This section specifies a conceptual model of possible data organization that an implementation maintains to participate in this protocol. The described organization is provided to explain how the protocol behaves. This document does not mandate that implementations adhere to this model as long as their external behavior is consistent with what is described in this document. This data model requires elements to be synchronized with the Server Service Remote Protocol [\[MS-SRVS\]](#). An implementation that uses this data model should observe atomicity requirements in order that the protocols always maintain an identical view of the common data.

All ADM elements maintained by the server are prefixed with "**Server**".

3.3.1.1 Global

The following ADM elements are globally maintained for an individual server:

Server.Enabled: A Boolean that indicates whether the CIFS server is accepting incoming connections or requests.

Server.Paused: A Boolean that indicates whether the CIFS server is in a paused state.

Server.Statistics: Server statistical information. This contains all the members of the **STAT_SERVER_0** ([\[MS-SRVS\]](#) section 2.2.4.39) structure.

Server.AutodisconnectTimeout: The idle session disconnect time-out in minutes.

Server.SupportDialects: A list of server-supported dialect identifiers in order of preference from least to most preferred.

Server.Capabilities: The set of Capabilities (as described in section [1.7](#) and defined in section [2.2.4.52.2](#)) supported by the server.

Server.ConnectionTable: A list of SMB connections, as defined in section [3.3.1.3](#). The list MUST allow lookups based upon **Server.Connection.ClientName**.

Server.EnableOplock: A Boolean value that indicates whether a server supports **OpLocks**.

Server.GuestOkay: A Boolean value that indicates whether or not a guest authentication is allowed if user-level authentication fails. If **Server.ShareLevelAuthentication** is TRUE, **Server.GuestOkay** MUST be FALSE.

Server.LMAuthenticationPolicy: A state that determines the LAN Manager challenge/response authentication mechanism to be used. The following options are available:

- **Disabled:** LAN Manager and LAN Manager v2 challenge/response authentication (LM & LMv2) are disabled.

The server MUST NOT test the LM or LMv2 response, if any, sent by the client.

- **V1-Enabled:** LAN Manager challenge/response authentication (LM) is enabled.

The server MUST use the LM response algorithm to test the response sent in the **OEMPassword** field of the SMB_COM_SESSION_SETUP_ANDX request received from the client.

- **V2-Enabled:** LAN Manager v2 challenge/response authentication (LMv2) is enabled.

The server MUST use the LMv2 algorithm to test the response sent in the **OEMPassword** field of the SMB_COM_SESSION_SETUP_ANDX request received from the client.

- **Enabled:** LAN Manager v1 and v2 challenge/response authentication is enabled.

The server MUST use the LMv2 algorithm to test the response sent in the **OEMPassword** field of the [SMB_COM_SESSION_SETUP_ANDX Request \(section 2.2.4.53.1\)](#) received from the client. If the LMv2 response does not match the client response, the server MUST use the LM response algorithm to test the response sent in the **OEMPassword** field of the SMB_COM_SESSION_SETUP_ANDX Request received from the client.

Server.MaxBufferSize: The size, in bytes, of the largest SMB message that the server can receive.

Server.MaxMpxCount: The maximum number of outstanding commands that each client is allowed to have at any given time.

Server.MaxVcNumber: The maximum number of virtual circuits that can be established between the client and the server as part of the same session.

Server.MaxRawSize: The maximum raw buffer size, in bytes, available on the server.

Server.MessageSigningPolicy: A state that determines whether this node signs messages. This parameter has four possible values:

- **Required:** Message signing is required. Any connection to a node that does not use signing MUST be disconnected.
- **Enabled:** Message signing is enabled. If the other node enables or requires signing, it MUST be used. [<212>](#)
- **Optional:** Message signing is disabled unless the other party requires it. If the other party requires message signing, it MUST be used. Otherwise, message signing MUST NOT be used.
- **Disabled:** Message signing is disabled. Message signing MUST NOT be used.

Server.NTLMAuthenticationPolicy: A state that determines the NT LAN Manager challenge/response authentication mechanism to be used. The following options are available:

- **Disabled:** NT LAN Manager and NT LAN Manager v2 challenge/response authentication (NTLM and NTLMv2) are disabled.

The server MUST NOT test the NTLM or NTLMv2 response, if any, sent by the client.

- **V1-Enabled:** NT LAN Manager challenge/response authentication (NTLM) is enabled.

The server MUST use the NTLM response algorithm to test the response sent in the **UnicodePassword** field of the SMB_COM_SESSION_SETUP_ANDX request received from the client.

- **V2-Enabled:** NT LAN Manager v2 challenge/response authentication (NTLMv2) is enabled.

The server MUST use the NTLMv2 algorithm to test the response sent in the **UnicodePassword** field of the SMB_COM_SESSION_SETUP_ANDX Request received from the client.

- **Enabled:** NT LAN Manager v1 and v2 challenge/response authentication is enabled.

The server MUST use the NTLMv2 algorithm to test the response sent in the **UnicodePassword** field of the SMB_COM_SESSION_SETUP_ANDX request received from the client. If the NTLMv2 response does not match the client response, the server MUST use the NTLM response algorithm to test the response sent in the **OEMPassword** field of the SMB_COM_SESSION_SETUP_ANDX request received from the client.

Server.OplockTimeout: The maximum **OpLock break** time-out in seconds.

If **Server.PlaintextAuthenticationPolicy** is set to **Required**, **Server.LMAuthenticationPolicy** and **Server.NTLMAuthenticationPolicy** MUST be **Disabled**.

If **Server.LMAuthenticationPolicy**, **Server.NTLMAuthenticationPolicy**, and **Server.PlaintextAuthenticationPolicy** are all Disabled, then no authentication is possible.

Server.PlaintextAuthenticationPolicy: A state that determines whether plaintext authentication is permitted or required. The following options are available:

- **Disabled:** Plaintext authentication disabled.

The server does support challenge/response authentication. Plaintext authentication from the client is denied.

- **Enabled:** Plaintext authentication enabled.

The server does support challenge/response authentication. Plaintext authentication from the client is permitted.

- **Required:** Plaintext authentication required.

The server does not support challenge/response authentication. The server MUST indicate support for challenge/response authentication using the 0x02 flag bit of the **SecurityMode** field sent in the SMB_COM_NEGOTIATE Response (section 2.2.4.52.2).

Server.ShareLevelAuthentication: A Boolean that indicates whether Share-level or User-level authentication is supported. If this is TRUE, Share-level authentication MUST be used.

Server.ShareTable: A list of available shares that are present on this server indexed by the share name, as specified in section [3.3.1.2](#).

Server.SrvMaxSessionTableSize: The maximum size of the session table that maintains the list of all SMB sessions per connection.

Server.SrvSearchMaxTimeout: The unused open search time-out in seconds.

Server.MaxSearches: The maximum number of outstanding open searches allowed on a connection.

3.3.1.2 Per Share

Server.Share: A share that is available on the server. The following ADM elements are maintained for each share offered by a server:

Server.Share.LocalPath: A path that describes the local resource that is being shared. This MUST be a store that either provides named pipe functionality, or a device or a volume that offers storage and/or retrieval of files. In the case of the latter, it can be a device that accepts a file and then processes it in some format, such as a printer. <213>

Server.Share.OptionalSupport: The optional support bits for the share. See the description of the **OptionalSupport** field in the [SMB_COM_TREE_CONNECT_ANDX Response \(section 2.2.4.55.2\)](#) for information on the defined bit flags.

Server.Share.ServerName: A local server name to which a shared resource attaches.

Server.Share.Type: The type of share. The **Service** field in the SMB_COM_TREE_CONNECT_ANDX Response (section 2.2.4.55.2) is matched against this element. The list of possible values is as follows:

- **Disk** -- Share is a disk share.
- **Named Pipe** -- Share is a named pipe.
- **Printer** -- Share is a printer share.
- **Comm** -- Share is a serial communications device.

Server.Share.Name: A name for the shared resource on this server.

Share.FileSecurity: An authorization policy of type **SECURITY_DESCRIPTOR** ([\[MS-DTYP\]](#) section 2.4.6), such as an access control list that describes what actions users that connect to this share are allowed to perform on the shared resource. <214> If the value of this ADM element is NULL, no access limits are enforced.

Server.Share.Remark: A pointer to a null-terminated Unicode UTF-16 string that specifies an optional comment about the shared resource.

Server.Share.MaxUses: The value indicates the maximum number of concurrent connections that the shared resource can accommodate.

Server.Share.CurrentUses: The value indicates the number of current tree connects to the shared resource.

3.3.1.3 Per SMB Connection

Server.Connection: An established SMB connection between the client and the server. The following ADM elements are maintained for each SMB connection established to a server:

Server.Connection.ClientCapabilities: The **Capabilities** flags of the client, as specified in the description of the [SMB_COM_SESSION_SETUP_ANDX Request \(section 2.2.4.53.1\)](#).

Server.Connection.ClientMaxBufferSize: The negotiated maximum size, in bytes, for SMB messages sent to the client. This limit applies to all SMB messages sent to the client unless otherwise specified for a particular message type.

Server.Connection.MaxMpxCount: The negotiated maximum number of outstanding commands that a given connection can have. This value **MUST** be less than or equal to **Server.MaxMpxCount**.

Server.Connection.ClientName: A client identifier. For NetBIOS-based transports, this is the NetBIOS name of the client. For other transports, this is a transport-specific identifier that provides a unique name or address for the client.

Server.Connection.ConnectionlessSessionID: Used only if the underlying transport is connectionless. This is a 16-bit unsigned SMB Connection identifier: a server-unique identifier for the connection between the client and the server.

Server.Connection.FileOpenTable: A list of open files, as specified in section [3.3.1.7](#). This list **MUST** allow lookup by file handle (FID), and each FID **MUST** be unique within the connection.

- Each entry **MUST** include the process identifier (PID) of the process that opened or created the FID so that all files opened by a specified PID can be listed.
- Each entry **MUST** include the Tree Connect ID (**TID**) used to open the file, so that all files opened within a specified **TID** can be listed.
- Each entry **MUST** include the user ID (**UID**) used to open the file, so that all files opened by a specified UID can be listed.
- If an OpLock has been granted on a particular FID, the entry **MUST** include the type of OpLock granted.

Server.Connection.IdleTime: The time that the connection received its most recent request.

Server.Connection.IsSigningActive: A Boolean that indicates whether or not message signing is active for this SMB connection.

Server.Connection.NativeLanMan: A string that represents the native LAN manager type of the client, as reported by the client.

Server.Connection.NativeOS: A string that represents the native operating system of the CIFS client, as reported by the client.

Server.Connection.NTLMChallenge: A byte array containing the cryptographic challenge sent to the client during protocol negotiation. The challenge is sent in the [SMB_COM_NEGOTIATE Response \(section 2.2.4.52.2\)](#).

Server.Connection.OpLockSupport: A Boolean value that indicates whether or not the server supports granting OpLocks on this connection.

Server.Connection.PendingRequestTable: A list of command requests, as specified in section [3.3.1.4](#), that are currently being processed by the server. This list is indexed on a combination of the **UID**, **TID**, **PID**, and **MID**. If the transport is connectionless, the entry **SHOULD** include the **Connection.ConnectionlessSessionID** (CID). For each command request that is sent to the object store, the server **MUST** store **Server.SMBRequest.CancelRequestID** into **Server.Connection.PendingRequestTable**.

Server.Connection.SearchOpenTable: A list of open searches. It **MUST** be possible to list all searches by:

- A specified Search ID (SID),
- The **PID** that opened the search,
- The **UID** that opened the search,
- The **TID** within which the search is taking place,
- or by a combination of **UID, TID, PID, MID,** and **ResumeKey**.

Server.Connection.SelectedDialect: A variable that stores the SMB Protocol dialect selected for use on this connection. Details of dialects prior to NT LAN Manager ("NT LM 0.12") are described in other documents. See the table in section [1.7](#) for a list of dialects and implementation references.

Server.Connection.ServerNextReceiveSequenceNumber: A sequence number for the next signed request being received.

Server.Connection.ServerSendSequenceNumber: A list of the expected sequence numbers for the responses of outstanding signed requests, indexed by **PID/MID** pair.

Server.Connection.SessionKey: A token generated by the server for each SMB connection.

Server.Connection.SessionSetupReceived: A Boolean value that indicates whether the server has received an SMB_COM_SESSION_SETUP_ANDX Request on this SMB connection.

Server.Connection.SessionTable: A table that maintains the list of all SMB sessions. The table MUST allow lookup by either the **UID** of the session or the security context of the user that established the session.

Server.Connection.SigningChallengeResponse: A variable-length byte array containing the challenge response to use for signing, if signing is active. If SMB signing is activated on the connection (**Server.Connection.IsSigningActive** becomes TRUE), the client response to the server challenge from the first non-null, non-guest session is used for signing all traffic on the SMB connection. The **Server.Connection.SigningChallengeResponse** is set to one of several possible values:

- **Empty** -- If **Server.Connection.IsSigningActive** is FALSE, no connection signing challenge response is used.
- **LM or LMv2 response** -- The response passed from client to server in the **OEMPassword** field of the SMB_COM_SESSION_SETUP_ANDX Request.
- NTLM or NTLMv2 response -- The response passed from client to server in the **UnicodePassword** field of the SMB_COM_SESSION_SETUP_ANDX Request.

Server.Connection.SigningSessionKey: A variable-length byte array containing the session key that is used for signing packets, if signing is active.

If SMB signing is activated on the connection (**Server.Connection.IsSigningActive** becomes TRUE), the session key from the first non-null, non-guest session is used for signing all traffic on the SMB connection. The **Server.Connection.SigningSessionKey** is set to one of three values:

- **Empty** -- If **Server.Connection.IsSigningActive** is FALSE, no connection signing session key is used.
- **LM Session Key** -- The LM hash, generated from the user's password using the LMOWFv1() function defined in [\[MS-NLMP\]](#) section 3.3.1.

- NT Session Key -- The NTLM hash, generated from the user's password using the NTOWFv1() function defined in [\[MS-NLMP\]](#) section 3.3.1.

Server.Connection.TreeConnectTable: A list of the tree connects over this SMB connection established to shares on the server, containing the **TID** for the tree connect and the **UID** of the user that established the Tree Connect, as well as the share service type returned in the [SMB_COM_TREE_CONNECT Response \(section 2.2.4.50.2\)](#) or the [SMB_COM_TREE_CONNECT_ANDX Response \(section 2.2.4.55.2\)](#). See the description of the **Service** field in the [SMB_COM_TREE_CONNECT_ANDX Response](#) for information on the permitted values. It MUST be possible to look up entries by either the **TID** or the **UID**.

Server.Connection.TransportName: An implementation-specific name of the transport used by this connection.

Server.Connection.CreationTime: The time at which the connection was established.

3.3.1.4 Per Pending SMB Command

Server.SMBRequest: A pending SMB command request on the server. The following ADM elements are maintained for each pending SMB command request on a server:

Server.SMBRequest.ConnectionlessSessionID: If a connectionless transport is in use, this is the value of the **CID** field in the **SecurityFeatures** field from the [SMB Header \(section 2.2.3.1\)](#) of the client request.

Server.SMBRequest.MID: The value of the **MID** from the **SMB Header** of the client request.

Server.SMBRequest.PID: The value of the **PID** from the **SMB Header** of the client request.

Server.SMBRequest.TID: The value of the **TID** from the **SMB Header** of the client request.

Server.SMBRequest.UID: The value of the **UID** from the **SMB Header** of the client request.

Server.SMBRequest.CancelRequestID: An implementation-dependent identifier of type [HANDLE](#) generated by the server to support cancellation of pending requests that are sent to the object store. The identifier MUST uniquely identify this **Server.SMBRequest** ADM element among all requests currently being processed by the server.

3.3.1.5 Per SMB Session

Server.Session: An established session between the client and server. The following ADM elements are maintained for each SMB session established to a server:

Server.Session.Connection: The SMB connection associated with this session.

Server.Session.IsAnonymous: A Boolean that, if set, indicates that the session is for an anonymous user.

Server.Session.SessionKey: The 16-byte session key associated with this session, as obtained from the authentication packages after successful authentication.

Session.UID: The 2-byte **UID** for this session, representing the user that established the session. The **UID** is returned by the server in the [SMB Header \(section 2.2.3.1\)](#) of the session setup response. All subsequent SMB requests from the client for this user on this connection MUST use this **UID**.

There can be multiple **UIDs** generated per SMB connection, each representing a unique user.

Server.Session.UserSecurityContext: The security context of the user that established the session, as obtained from the authentication subsystem after successful authentication.

Server.Session.SessionGlobalId: A numeric 32-bit value obtained by registration with the Server Service Remote Protocol.

Server.Session.CreationTime: The time that the session was established.

Server.Session.IdleTime: The time that the session processed its most recent request.

Server.Session.UserName: The name of the user who established the session.

3.3.1.6 Per Tree Connect

Server.TreeConnect: An established tree connect between the client and the share on the server. The following ADM elements are maintained for each tree connect established to a share on a server:

Server.TreeConnect.Share: A reference to the **Share** (section [3.3.1.2](#)) to which this **TreeConnect** connects.

Server.TreeConnect.TID: A numeric value that uniquely identifies a tree connect represented as a 16-bit **TID** in the [SMB Header \(section 2.2.3.1\)](#).

Server.TreeConnect.Session: A pointer to the authenticated session that established this tree connect.

Server.TreeConnect.OpenCount: A numeric value that indicates the number of files that are currently opened on **TreeConnect**.

Server.TreeConnect.TreeGlobalId: A numeric value obtained by registration with the Server Service Remote Protocol.

Server.TreeConnect.CreationTime: The time that the tree connect was established.

3.3.1.7 Per Unique Open

Server.Open: A file or named pipe on the server opened through the established **Server.TreeConnect**. The following ADM elements are maintained for each **open** on a server held by a client:

Server.Open.Connection: The SMB connection associated with this **open**.

Server.Open.Locks: A list of byte-range locks on this **open**. Each entry **MUST** include the **PID** that created the lock. Each entry **MUST** indicate whether it is a shared (read-only) or an exclusive (read-write) lock. Each entry **MUST** also indicate if it is using 32- or 64-bit file offsets and **MUST** be accordingly formatted as either **LOCKING_ANDX_RANGE32** or **LOCKING_ANDX_RANGE64**.

Server.Open.OpLock: An element indicating the type of OpLock, if any, that has been granted on this **open**. This value **MUST** be one of **None**, **Exclusive**, **Batch**, or **Level II**.

Server.Open.OplockState: The current Oplock state of the **Open**. This value **MUST** be **Held**, **Breaking**, or **None**.

Server.Open.OplockTimeout: The time value that indicates when an Oplock that is breaking and has not received an acknowledgment from the client will be acknowledged by the server.

Server.Open.PathName: A variable-length string that contains the Unicode path name on which the **open** is performed.

Server.Open.Session: The SMB session associated with this **open**. SMB sessions are identified by **UID**, as described in section [2.2.1.6.8](#).

Server.Open.FID: The unique (per-connection) 16-bit **FID** identifying this **open**, as described in section [2.2.1.6.1](#). The **FID** MUST be unique on this connection.

Server.Open.PID: The unique (per connection) 32-bit **PID** provided in the client request that created this **open**. The **PID** is described in section [2.2.1.6.3](#).

Server.Open.TreeConnect: The tree connect associated with this **open**. Tree connects are identified by **TID**, as described in section [2.2.1.6.7](#).

Server.Open.FileGlobalId: A numeric value obtained by registration with the Server Service Remote Protocol.

Server.Open.GrantedAccess: The access granted on this **open**.

Server.Open.MpxMask: The accumulated mask value from all successfully received [SMB_COM_WRITE_MPX Requests \(section 2.2.4.26.1\)](#) on this **open**.

3.3.1.8 Per Unique Open Search

Server.SearchOpen: A search operation that is being performed through the established **Server.TreeConnect**. The following ADM elements are maintained for each search request to a server held open by a client:

Server.SearchOpen.FindSID: The Search ID (SID) associated with the **SearchOpen**.

Server.SearchOpen.PathName: A variable-length string that contains the full directory path (relative to the share path) being searched.

Server.SearchOpen.MID: The Multiplex ID (**MID**) of the client process that opened the search.

Server.SearchOpen.PID: The Process ID (**PID**) of the client process that opened the search.

Server.SearchOpen.TID: The TreeConnect ID (**TID**) of the tree connect within which the search takes place.

Server.SearchOpen.UID: The Session identified by the User ID (**UID**) that initiated the search.

3.3.2 Timers

3.3.2.1 OpLock Break Acknowledgment Timer

This timer controls the amount of time that the server waits for an OpLock break acknowledgment from the client after sending an OpLock break request to the client. The server MUST wait for an interval of time greater than or equal to the OpLock break acknowledgment timer. [<216>](#)

3.3.2.2 Idle Connection Timer

This timer controls the amount of time that a session can be idle before the server disconnects the session. An idle session is one on which no open handles exist (no open files, directories, search contexts, etc.), and no operations have been issued within an implementation-specific period of time. [<217>](#)

3.3.2.3 Unused Open Search Timer

This optional timer controls the amount of time that an open search can stay unused before the server closes the open search context.

3.3.2.4 Unused Connection Timer

This timer controls the amount of time that a connection can stay unused; that is, without a session ever established, before the server closes it. The server MUST schedule this timer periodically with an implementation-specific interval.

3.3.3 Initialization

When the CIFS server is started, the following values MUST be initialized:

- **Server.Enabled** MUST be set to FALSE.
- **Server.Paused** MUST be set to FALSE.
- All of the members in the **Server.Statistics** ADM element MUST be set to zero.
- **Server.ShareLevelAuthentication** MUST be set based on system policy and implementation capabilities. <218>
- **Server.SupportDialects** MUST be set to the list of dialects identifiers that the server supports, presented in section 1.7. <219>
- Values for **Server.PlaintextAuthenticationPolicy**, **Server.LMAuthenticationPolicy**, and **Server.NTLMAuthenticationPolicy** MUST be set based on system policy and implementation capabilities, and MUST be one of the possible values listed in Server Global (section 3.3.1.1). <220>
- **Server.ConnectionTable** MUST be initialized to an empty list.
- **Server.ShareTable** SHOULD be initialized to an empty list.
- **Server.MaxBufferSize** MUST be initialized based on local policy or implementation configuration. **Server.MaxBufferSize** MUST have a minimum value of 1024 (0x00000400) bytes (1Kbyte). <221>
- **Server.MaxMpxCount** MUST be initialized based on local policy or implementation configuration. <222>
- **Server.MessageSigningPolicy** MUST be initialized based on local policy or implementation capabilities and configuration. <223>
- **Server.AutodisconnectTimeout** MUST be set to zero.
- **Server.MaxVcNumber** MUST be set to zero.
- **Server.MaxRawSize** MUST be initialized based on local policy or implementation configuration. <224>
- **Server.OplockTimeout** MUST be set to zero.
- **Server.EnableOplock** MUST be set to FALSE.
- **Server.SrvSearchMaxTimeout** MUST be set to zero.

- **Server.SrvMaxSessionTableSize** MUST be set to zero.
- **Server.MaxSearches** MUST be initialized based on local policy or implementation configuration. <225>

The CIFS server MUST notify the server service that initialization is complete by invoking the Server Notifies Completion of Initialization ([\[MS-SRVS\]](#) section 3.1.6.14) event, providing the string "CIFS" as the input parameter.

3.3.4 Higher-Layer Triggered Events

3.3.4.1 Sending Any Message

This event is invoked within the SMB server itself for processing each request. It is not exposed externally.

The caller provides the following:

- **Connection:** The SMB connection on which the response is to be sent.
- **Payload:** The payload to be sent, including the [SMB Header \(section 2.2.3.1\)](#).

Unless otherwise noted, the server MUST NOT send any message that exceeds the limit set by **Server.Connection.ClientMaxBufferSize**.

If the message is an error reply or any other message that indicates the completion of a command, the server MUST remove the corresponding entry, if any, from the **Server.Connection.PendingRequestTable**.

Unless otherwise specified, the server MUST return both the client-supplied PID and **MID** to the client in any response to a client request.

The SMB_FLAGS_REPLY bit in the SMB Header MUST be set, unless the message is an OpLock Break Notification request initiated by the server.

If the server sends a message to the client, and signing is active for the SMB connection, the message MUST be signed, as specified in section [3.1.4.1](#), by providing the sequence number in **Server.Connection.ServerSendSequenceNumber[PID,MID]**. The sequence number is calculated and populated into the table **Server.Connection.ServerSendSequenceNumber**, as specified in section [3.3.5.2](#). OpLock Break Notification messages are exempt from signing.

If signing is not active, the **SecuritySignature** field of the SMB Header for all messages sent, except the [SMB_COM_SESSION_SETUP_ANDX Response \(section 2.2.4.53.2\)](#), MUST be set to 0x0000000000000000. For the SMB_COM_SESSION_SETUP_ANDX Response, the **SecuritySignature** field of the SMB Header SHOULD <226> be set to the **SecuritySignature** received in the [SMB_COM_SESSION_SETUP_ANDX Request \(section 2.2.4.53.1\)](#).

For every outgoing message, the server MUST calculate the total number of bytes in the message and MUST update the values of **Server.Statistics.sts0_bytessent_low** and **Server.Statistics.sts0_bytessent_high**.

3.3.4.1.1 Processing Options

The server MUST set the **SMB_Header.Flags2** field of the response equal to the **SMB_Header.Flags2** value received in the request. These flags are described in section [2.2.3.1](#).

The server SHOULD set the **SMB_Header.Reserved** field to 0x0000. <227>

3.3.4.1.2 Sending Any Error Response Message

In response to an error in the processing of any SMB request, the **CIFS server** MUST return the correct response message for the request as specified in the command definition in section [2.2.4](#). The error code MUST be placed into the **SMB_Header.Status** field. If the use of NT Status codes has been negotiated, the error code MUST be a 32-bit NTSTATUS code. Otherwise, the error code MUST be an SMBSTATUS code. [<228>](#)

Unless otherwise specified, all response messages that indicate an error MUST include:

- The command code of the request that generated the error.
- The **UID**, **TID**, **PID**, **MID**, and (if a connectionless transport is in use) **CID** of the request.
- No parameters and no data; that is, **SMB_Parameters.WordCount** = 0x00 and **SMB_Data.ByteCount** = 0x0000.

This format is referred to as an "error response" message.

The error response message format MUST be used unless otherwise specified.

If the client request is part of an AndX chain, processing of the AndX request chain terminates with the request that generated the error. The error response MUST be the last response in the returned AndX chain.

3.3.4.2 Object Store Indicates an OpLock Break

The underlying object store indicates an OpLock break to the SMB server by providing the following (see [\[MS-FSA\]](#) and [\[FSBO\]](#)):

- **Server.Open**: The open on which the OpLock is being broken.
- **NewOpLockLevel**: The level to which the OpLock was broken.
- **AcknowledgementRequired**: A Boolean indicating whether the underlying object store needs an acknowledgement to complete the OpLock break.
- **ReturnStatus**: The status code indicating the reason for the break.

If **ReturnStatus** is **STATUS_SUCCESS**, the server MUST notify the client identified by **Server.Open.Connection** by sending an asynchronous OpLock Break Notification message to the client as described later in this section. Otherwise, the OpLock break MUST be ignored.

The server MUST construct an [SMB_COM_LOCKING_ANDX Request \(section 2.2.4.32.1\)](#) and initialize the fields as follows:

- The server MUST set the **OPLOCK_RELEASE** flag in the **TypeOfLock** field to indicate to the client that the OpLock is being broken.
- The server MUST set the **NewOpLockLevel** field to the value returned by the underlying object store [<229>](#) to indicate the type of OpLock now in effect for the **Server.Open**. A value of 0 indicates that no OpLock is now held; 1 indicates that a Level II OpLock is now held.
- The server SHOULD [<230>](#) set the **Timeout**, **NumberOfUnlocks**, **NumberOfLocks**, and **ByteCount** fields to zero.

The server MUST send an **SMB_COM_LOCKING_ANDX Request** to the client.

If **AcknowledgementRequired** is TRUE, the server MUST start an [OpLock Break Acknowledgment Timer \(section 3.3.2.1\)](#) to fire in **Server.OplockTimeout** seconds if the timer is not already active, MUST set **Server.Open.OplockState** to Breaking, and MUST set **Server.Open.OplockTimeout** to the current time plus **Server.OplockTimeout**.

If **AcknowledgementRequired** is FALSE, the server MUST set **Server.Open.OplockState** to None.

Refer to section [3.2.5.42](#) for details on how the client processes an OpLock break notification.

Refer to section [3.3.5.30](#) for details on how a server responds to an OpLock break acknowledgment from the client.

3.3.4.3 DFS Subsystem Notifies That It Is Active

If the DFS subsystem is available to the CIFS server, it MUST notify the server. The server SHOULD then set the CAP_DFS flag in **Server.Capabilities**. After this event, the server is able to set the CAP_DFS flag in the **Capabilities** field of an [SMB_COM_NEGOTIATE Response \(section 2.2.4.52.2\).<231>](#)

3.3.4.4 DFS Subsystem Notifies That a Share Is a DFS Share

If the DFS subsystem claims a share as part of the DFS namespace, it MUST notify the CIFS server via this event. In response to this event, the CIFS server MUST set the SMB_SHARE_IS_IN_DFS bit in the **Server.Share OptionalSupport** attribute of the share.

3.3.4.5 DFS Subsystem Notifies That a Share Is Not a DFS Share

If the DFS subsystem removes its claim for a share as part of the DFS namespace, it MUST notify the CIFS server via this event. In response to this event, the CIFS server MUST clear the SMB_SHARE_IS_IN_DFS bit in the **Server.Share.OptionalSupport** attribute of the share.

3.3.4.6 Application Requests the Session Key Associated with a Client Session

The application provides the following:

- Open -- A **Server.Open** that identifies an open instance of a file or pipe.

The server MUST provide a 16-byte session key described by **Server.Open.Session.SessionKey** to the caller. An implementation-specific error MUST be returned to the caller if the session key is not available.

3.3.4.7 Application Requests the Security Context Associated with a Client Session

The application provides the following:

- Open - A **Server.Open** that identifies an open instance of a file or pipe.

The server MUST provide the implementation-specific user security context described by **Server.Open.Session.UserSecurityContext** to the caller. An implementation-specific error MUST be returned to the caller if the security context is not available.

3.3.4.8 Server Application Requests Closing a Session

The calling application MUST provide the **GlobalSessionId** of the session to be closed. The server MUST enumerate all **Connections** in **Server.ConnectionTable** and MUST look up **Session** from the **Connection.SessionTable** where **Session.SessionGlobalId** is equal to **GlobalSessionId**. The server MUST remove **Session** from the **Connection.SessionTable**, MUST decrease **Server.Statistics.sts0_sopens** by 1, and MUST release every lock in **Server.Open.Locks**. If there is no matching session, the call MUST return.

The server MUST deregister the session by invoking the event Server Deregisters a Session ([\[MS-SRVS\]](#) section 3.1.6.3), providing **GlobalSessionId** as the input parameter.

The server MUST close every **Open** in the **Session.Connection.FileOpenTable** as specified in section [3.3.4.13](#) where **Open.Session** matches **Session**.

For each **TreeConnect** in **Session.Connection.TreeConnectTable** where **TreeConnect.Session** matches **Session**, the server MUST perform the following:

- Deregister the Treeconnect ([\[MS-SRVS\]](#) section 3.1.6.7), providing the tuple **<TreeConnect.Share.ServerName, TreeConnect.Share.Name>** and **TreeConnect.TreeGlobalId** as the input parameters.
- Decrement **TreeConnect.Share.CurrentUses** by 1.
- Disconnect and remove the **TreeConnect** from **Session.Connection.TreeConnectTable**.

The session MUST be torn down and freed.

3.3.4.9 Server Application Registers a Share

The calling application provides a share in a **SHARE_INFO_503_I** structure ([\[MS-SRVS\]](#) section 2.2.4.27) to register a share. The server MUST validate the **SHARE_INFO_503_I** structure as specified in [\[MS-SRVS\]](#) section 3.1.4.7. If any member in the structure is invalid, the server MUST return STATUS_INVALID_PARAMETER to the calling application. The server MUST look up the **Share** in the **Server.ShareTable**, where **shi503_servername** matches **Share.ServerName** and **shi503_netname** matches **Share.Name**. If a matching **Share** is found, the server MUST fail the call with an implementation-dependent error. Otherwise, the server MUST create a new **Share** with the following values set, insert it into **Server.ShareTable**, and return STATUS_SUCCESS.

- **Share.Name** MUST be set to **shi503_netname**.
- **Share.Type** MUST be set to **shi503_type**.
- **Share.Remark** MUST be set to **shi503_remark**.
- **Share.LocalPath** MUST be set to **shi503_path**.
- **Share.ServerName** MUST be set to **shi503_servername**.
- **Share.FileSecurity** MUST be set to **shi503_security_descriptor**.
- **Share.MaxUses** MUST be set to **shi503_max_uses**.
- **Share.CurrentUses** MUST be set to zero.

3.3.4.10 Server Application Updates a Share

To update an existing **Share**, the calling application provides a share in the **SHARE_INFO_503_I** ([MS-SRVS] section 2.2.4.27) and **SHARE_INFO_1005** ([MS-SRVS] section 2.2.4.29) structures as input parameters. The server MUST validate the **SHARE_INFO_503_I** and **SHARE_INFO_1005** structures as specified in [MS-SRVS] section 3.1.4.11. If any member in the structures is invalid, the server MUST return STATUS_INVALID_PARAMETER to the calling application. The server MUST look up the **Share** in **Server.ShareTable** through the tuple <**shi503_servername**, **shi503_netname**>. If the matching **Share** is found, the server MUST update the **Share** by setting the following values and MUST return STATUS_SUCCESS to the calling application; otherwise, the server MUST return an implementation-specific error.

- **Share.Remark** MUST be set to **shi503_remark**.
- **Share.MaxUses** MUST be set to **shi503_max_uses**.
- **Share.FileSecurity** MUST be set to **shi503_security_descriptor**.

3.3.4.11 Server Application Deregisters a Share

The calling application MUST provide the tuple <**ServerName**, **ShareName**> of the share that is being deregistered. The server MUST look up the share in **Server.ShareTable**, MUST remove it from the list if the share is found, and MUST return STATUS_SUCCESS to the calling application; otherwise, the server MUST return an implementation-specific error.

For each **Connection** in **Server.ConnectionTable**, the server MUST perform the following:

- For each **Open** in **Connection.FileOpenTable** where **Open.TreeConnect.Share** matches the current share:
 - Close the **Open** as specified in section 3.3.4.13.
- For each **TreeConnect** in **Connection.TreeConnectTable** where **TreeConnect.Share** matches the current share:
 - Deregister the **TreeConnect** by invoking the event specified in [MS-SRVS] section 3.1.6.7 with the tuple <**TreeConnect.Share.ServerName**, **TreeConnect.Share.Name**> and **TreeConnect.TreeGlobalId** as input parameters.
 - Remove the **TreeConnect** entry from **Connection.TreeConnectTable**.

3.3.4.12 Server Application Requests Querying a Share

The calling application MUST provide the tuple <**ServerName**, **ShareName**> of the share that is being queried. The server MUST look up the **Share** in **Server.ShareTable**. If the matching **Share** is found, the server MUST return a share in the **SHARE_INFO_503_I** ([MS-SRVS] section 2.2.4.27) and **SHARE_INFO_1005** ([MS-SRVS] section 2.2.4.29) structures with the following values set and MUST return STATUS_SUCCESS to the calling application; otherwise, the server MUST return an implementation-dependent error.

Output parameters	[MS-CIFS] share properties
SHARE_INFO_503_I.shi503_netname	Server.Share.Name
SHARE_INFO_503_I.shi503_type	Server.Share.Type

Output parameters	[MS-CIFS] share properties
SHARE_INFO_503_I.shi503_remark	Server.Share.Remark
SHARE_INFO_503_I.shi503_permissions	0x00000000
SHARE_INFO_503_I.shi503_max_uses	Server.Share.MaxUses
SHARE_INFO_503_I.shi503_current_uses	Server.Share.CurrentUses
SHARE_INFO_503_I.shi503_path	Server.Share.LocalPath
SHARE_INFO_503_I.shi503_passwd	Empty string
SHARE_INFO_503_I.shi503_servername	Server.Share.ServerName
SHARE_INFO_503_I.shi503_security_descriptor	NULL
SHARE_INFO_1005.shi1005_flags	0x00000000

3.3.4.13 Server Application Requests Closing an Open

The calling application MUST provide **GlobalFileId** as an identifier for the **Open**. The server MUST enumerate all connections in **Server.ConnectionTable** and MUST look up **Open** in **Server.Connection.FileOpenTable** where **Server.Open.FileGlobalId** is equal to **GlobalFileId**. If the **Open** is found, the server MUST remove it from **Server.Connection.FileOpenTable**, MUST decrease **Open.TreeConnect.OpenCount** and **Server.Statistics.sts0_fopens** by 1, MUST release every lock in **Server.Open.Locks**, and MUST return STATUS_SUCCESS to the calling application; otherwise, the call MUST return an implementation-dependent error.

The server MUST provide **GlobalFileId** to deregister the **Open** by invoking the event Server Deregisters an Open ([\[MS-SRVS\]](#) section 3.1.6.5).

The **Open** object MUST be closed.

3.3.4.14 Server Application Queries a Session

The calling application MUST provide **GlobalSessionId** as an identifier for the **Session**. The server MUST enumerate all connections in **Server.ConnectionTable** and MUST look up a **Session** in **Server.Connection.SessionTable** where **GlobalSessionId** is equal to **Server.Session.SessionGlobalId**. If a **Session** is found, the server MUST return the **Session** in a **SESSION_INFO_502** structure ([\[MS-SRVS\]](#) section 2.2.4.15) with the following values set and MUST return STATUS_SUCCESS to the calling application.

SESSION_INFO_502 parameters	[MS-CIFS] Session properties
sesi502_cname	Session.Connection.ClientName
sesi502_username	Server.Session.UserName
sesi502_num_opens	The count of entries in Session.Connection.FileOpenTable where Open.Session matches the current session.
sesi502_time	Current time minus Session.CreationTime .
sesi502_idle_time	Current time minus Session.IdleTime .

SESSION_INFO_502 parameters	[MS-CIFS] Session properties
sesi502_user_flags	MUST be set to SESS_GUEST if Session.UserName represents a Guest account; otherwise, MUST be set to 0x00000000.
sesi502_cltype_name	An empty string.
sesi502_transport	Session.Connection.TransportName

If no **Session** is found, the server MUST return an implementation-dependent error.

3.3.4.15 Server Application Queries a TreeConnect

The calling application MUST provide *GlobalTreeConnectId* as an identifier for the **TreeConnect**. The server MUST enumerate all connection entries in **Server.ConnectionTable** and MUST look up all **TreeConnect** entries in **Server.Connection.TreeConnectTable** where *GlobalTreeConnectId* is equal to **TreeConnect.TreeGlobalId**. If a **TreeConnect** is found, the server MUST return **ServerName** and a **CONNECTION_INFO_1** structure ([\[MS-SRVS\]](#) section 2.2.4.2) with the following values set and MUST return STATUS_SUCCESS to the calling application.

Output parameters	[MS-CIFS] TreeConnect properties
coni1_id	TreeConnect.TreeGlobalId
coni1_type	TreeConnect.Share.ShareType
coni1_num_opens	TreeConnect.OpenCount
coni1_num_users	0x00000001
coni1_time	Current time minus TreeConnect.CreationTime .
coni1_username	TreeConnect.Session.UserName
coni1_netname	TreeConnect.Share.Name
ServerName	TreeConnect.Share.ServerName

If no **TreeConnect** is found, the server MUST return an implementation-dependent error.

3.3.4.16 Server Application Queries an Open

The calling application MUST provide *GlobalFileId* as an identifier for the **Open**. The server MUST enumerate all connections in **Server.ConnectionTable** and MUST look up the **Open** in **Server.Connection.FileOpenTable** where **Server.Open.FileGlobalId** is equal to *GlobalFileId*. If the **Open** is found, the server MUST return it in a **FILE_INFO_3** structure ([\[MS-SRVS\]](#) section 2.2.4.7), with the following values set and MUST return STATUS_SUCCESS to the calling application.

FILE_INFO_3 parameters	[MS-CIFS] Open properties
fi3_id	Open.FileGlobalId
fi3_permissions	Open.GrantedAccess
fi3_num_locks	Count of entries in Open.Locks

FILE_INFO_3 parameters	[MS-CIFS] Open properties
fi3_path_name	Open.PathName
fi3_username	Open.Session.UserName

If no **Open** is found, the server MUST return an implementation-dependent error.

3.3.4.17 Server Application Requests Transport Binding Change

The application provides:

- **TransportName**: A string containing an implementation-dependent name of the transport.
- **ServerName**: An optional string containing the name of the server to be used for binding the transport.
- **EnableFlag**: A Boolean flag indicating whether to enable or disable the transport.

The server MUST use implementation-specific [<232>](#) means to determine whether **TransportName** is an eligible transport entry as specified in section [2.1](#), and if not, the server MUST return ERROR_NOT_SUPPORTED to the caller.

If **EnableFlag** is TRUE, the server SHOULD [<233>](#) obtain **ServerName**, SHOULD obtain binding information for the transport from the appropriate standards assignments as specified in section [2.1](#), and MUST attempt to start listening on the requested transport endpoint. [<234>](#)

If **EnableFlag** is FALSE, the server MUST attempt to stop listening on the transport indicated by **TransportName**.

If the attempt to start or stop listening on the transport succeeds, the server MUST return STATUS_SUCCESS to the caller; otherwise, it MUST return an implementation-dependent error.

3.3.4.18 Server Service Enables the CIFS Server

The server MUST verify in an implementation-specific manner that the caller of this interface is the server service [\[MS-SRVS\]](#), and only if so, MUST set the **Server.Enabled** ADM element to TRUE.

3.3.4.19 Server Services Disables the CIFS Server

The server MUST verify in an implementation-specific manner that the caller of this interface is the server service [\[MS-SRVS\]](#), and only if so, MUST take the following actions:

- The server MUST set **Server.Enabled** to FALSE to prevent accepting new connections.
- The server MUST disconnect each **Connection** in **Server.ConnectionTable** as specified in section [3.3.7.2](#).
- The server MUST remove and free all the shares in **Server.ShareTable**.

3.3.4.20 Server Service Pauses the CIFS Server

The server MUST verify in an implementation-specific manner that the caller of this interface is the server service [\[MS-SRVS\]](#), and, only if so, MUST set the **Server.Paused** ADM element to TRUE.

3.3.4.21 Server Services Resumes (Continues) the CIFS Server

The server MUST verify in an implementation-specific manner that the caller of this interface is the server service [\[MS-SRV5\]](#), and, only if so, MUST set the **Server.Paused** ADM element to FALSE.

3.3.4.22 Server Application Requests Updating the Server Configuration

The calling application provides **SERVER_INFO_103** ([\[MS-SRV5\]](#) section 2.2.4.43) and **SERVER_INFO_599** ([\[MS-SRV5\]](#) section 2.2.4.46) structures as input parameters to update the server configuration. The following values MUST be set by the server:

- **Server.AutodisconnectTimeout** MUST be set to **sv103_disc**.
- **Server.MaxVcNumber** MUST be set to **sv599_sessvcs**.
- **Server.OplockTimeout** MUST be set to **sv599_oplockbreakresponsewait**.
- **Server.EnableOplock** MUST be set to **sv599_enableoplocks**.
- **Server.MaxMpxCount** MUST be set to **sv599_maxmpxct**.
- **Server.SrvSearchMaxTimeout** MUST be set to **sv599_maxkeepsearch**.
- **Server.SrvMaxSessionTableSize** MUST be set to **sv599_sessusers**.

3.3.4.23 Server Application Requests Server Statistics

The server MUST return the **Server.Statistics** ADM element in a **STAT_SERVER_0** ([\[MS-SRV5\]](#) section 2.2.4.39) structure to the server application with the following values:

STAT_SERVER_0 member	CIFS Server.Statistics Property
sts0_start	zero
sts0_fopens	Server.Statistics.sts0_fopens
sts0_devopens	zero
sts0_jobsqueued	Server.Statistics.sts0_jobsqueued
sts0_sopens	Server.Statistics.sts0_sopens
sts0_stimedout	Server.Statistics.sts0_stimedout
sts0_serrorout	zero
sts0_pwerrors	Server.Statistics.sts0_pwerrors
sts0_permerrors	Server.Statistics.sts0_permerrors
sts0_syserrors	zero
sts0_bytessent_low	Server.Statistics.sts0_bytessent_low
sts0_bytessent_high	Server.Statistics.sts0_bytessent_high
sts0_bytesrcvd_low	Server.Statistics.sts0_bytesrcvd_low

STAT_SERVER_0 member	CIFS Server.Statistics Property
sts0_bytesrcvd_high	Server.Statistics.sts0_bytesrcvd_high
sts0_avresponse	zero
sts0_reqbufneed	zero
sts0_bigbufneed	zero

3.3.5 Processing Events and Sequencing Rules

3.3.5.1 Accepting an Incoming Connection

When the server accepts an incoming remote client connection as specified in section [3.3.7.3](#), the server MUST allocate a **Server.Connection** ADM element and initialize it as follows:

- **Server.Connection.ClientCapabilities** is set to zero (0x00000000).
- **Server.Connection.TransportName** is set to the implementation-specific name of the transport provided with the connection. [<235>](#)
- **Server.Connection.IsSigningActive** is set to FALSE.
- **Server.Connection.SessionSetupReceived** is FALSE.
- **Server.Connection.SessionTable** is an empty list.
- **Server.Connection.ClientMaxBufferSize** is set to zero (0x00000000).
- **Server.Connection.PendingRequestTable** is empty.
- **Server.Connection.TreeConnectTable** is an empty list.
- **Server.Connection.OpLockSupport** is set to the value of **Server.EnableOplock**.
- **Server.Connection.FileOpenTable** is an empty list.
- **Server.Connection.SearchOpenTable** is an empty list.
- **Server.Connection.ConnectionlessSessionID** is set to zero (0x0000) unless the transport is connectionless, in which case a valid value is assigned.
- **Server.Connection.ServerNextReceiveSequenceNumber** is set to 2.
- **Server.Connection.ServerSendSequenceNumber** is set to an empty list.
- **Server.Connection.SigningChallengeResponse** is a zero-length array.
- **Server.Connection.SigningSessionKey** is zeroed.
- **Server.Connection.SessionKey** SHOULD [<236>](#) be set to a token generated by the server for this connection, as specified in [SessionKey Generation \(section 2.2.1.6.6\)](#).
- **Server.Connection.IdleTime** is set to the current time plus **Server.AutoDisconnectTimeout**.
- **Server.Connection.SelectedDialect** is set to empty.

- **Server.Connection.CreationTime** is set to the current time.

The server MUST invoke the event specified in [\[MS-SRVS\]](#) section 3.1.6.16, providing the input tuple <**Server.Connection.TransportName**,TRUE>, to update the connection count.

The server MUST start [Idle Connection Timer \(section 3.3.2.2\)](#) if it has not been started.

The server MUST start [Unused Connection Timer \(section 3.3.2.4\)](#) if it has not been started.

3.3.5.2 Receiving Any Message

For every message received, the server MUST calculate the total number of bytes in the message and MUST update the values of **Server.Statistics.sts0_bytesrcvd_low** and **Server.Statistics.sts0_bytesrcvd_high**. The server MUST update **Server.Connection.IdleTime** as the current time plus **Server.AutoDisconnectTimeout**.

Upon receiving any client request, the server SHOULD perform basic message validation. The following tests SHOULD be performed on all received messages, with exceptions as noted:

- Validate the length of the message.

If the message is a standard SMB message, as opposed to a raw data transfer, the total byte length of the message as reported by the SMB transport MUST be a minimum of 35 bytes:

```
35 = 32 + 1 + 2 = sizeof( SMB_Header ) + sizeof( WordCount ) + sizeof( ByteCount );
```

The total byte length of any SMB message MUST be at least:

```
sizeof( SMB_Header ) + sizeof( WordCount ) + ( 2 x WordCount ) + sizeof( ByteCount ) +  
ByteCount;
```

If the total number of bytes transferred by the SMB transport is less than specified by the preceding formula, then the message was either incorrectly formatted by the client, or it was truncated in transit. The client SHOULD send an error response with the Status code set to STATUS_INVALID_SMB (ERRSRV/ERRerror). It is not a protocol error for the client to transfer excess data; however, the excess data MUST be ignored.

Raw data transfers from client to server are generated by the SMB_COM_WRITE_RAW command.

- Validate the [SMB Header \(section 2.2.3.1\)](#) **Protocol** identifier and the command code.

The four-byte Protocol identifier at the start of the SMB Header MUST contain the octet values '\xFF', 'S', 'M', 'B'. Otherwise, the server MUST return an error response with the **Status** code set to STATUS_INVALID_SMB (ERRSRV/ERRerror).

The command code MUST be one of the valid command codes listed in section [2.2.2.1](#).

- If the command code in the **SMB_Header.Status** field is listed as "Unused" or "Reserved" in the first column of the table in section [2.2.2.1](#), or if the command code is either [SMB_COM_INVALID \(section 2.2.4.74\)](#) or [SMB_COM_NO_ANDX_COMMAND \(section 2.2.4.75\)](#), the server MUST return an error response with the **Status** code set to STATUS_SMB_BAD_COMMAND (ERRSRV/ERRbadcmd).

- If the command is listed in the table in section [2.2.2.1](#) as Obsolete (as shown by an X in the Status column) or Not Implemented (as shown by an N in the Status column), the server SHOULD return an error response with a **Status** code of STATUS_NOT_IMPLEMENTED (ERRDOS/ERRbadfunc). See the descriptions of the individual commands in section [2.2.4](#) for more information. [<237>](#)
- If the command code represents a valid command, but the command has not been implemented by the server, the server MUST return STATUS_NOT_IMPLEMENTED (ERRDOS/ERRbadfunc).

- Validate the **UID** and **TID**.

With three exceptions, all SMB requests sent by the client MUST have valid **UIDs**. The exceptions are:

- SMB_COM_NEGOTIATE
- SMB_COM_ECHO
- SMB_COM_SESSION_SETUP_ANDX

To be valid, a **Server.Connection.SessionTable** entry for the **UID** MUST exist, such that the **Server.Session.UID** matches the **SMB_Header.UID** received in the request. If the **UID** is not valid, the server MUST return STATUS_SMB_BAD_UID (ERRSRV/ERRbaduid).

If the **UID** is valid, the server MUST enumerate all connections in the **Server.ConnectionTable** and MUST look up **Session** in the **Server.Connection.SessionTable** where **UID** is equal to **Server.Session.UID**. If a session is found, **Server.Session.IdleTime** MUST be set to the current time. If no session is found, no action regarding idle time is taken.

With five exceptions, all SMB requests sent by the client MUST have valid **TIDs**. The exceptions are:

- SMB_COM_NEGOTIATE
- SMB_COM_SESSION_SETUP_ANDX
- SMB_COM_TREE_CONNECT
- SMB_COM_TREE_CONNECT_ANDX
- SMB_COM_LOGOFF_ANDX

To be valid, a **Server.Connection.TreeConnectTable** entry for the **TID** MUST exist, such that the **Server.TreeConnect.TID** matches the **SMB_Header.TID** received in the request. If the **TID** is not valid, the server MUST return STATUS_SMB_BAD_TID (ERRSRV/ERRinvtid).

The SMB_COM_ECHO command requires either a valid **TID** or the value 0xFFFF. The latter MAY be used if no tree connect has been established. [<238>](#)

- This list of validation tests is not exhaustive.

3.3.5.2.1 Command Processing

If the message received is a command request that initiates processing of a command, the **UID**, **TID**, **PID**, and **MID** of the command MUST be used to create an entry in the **Server.Connection.PendingRequestTable**. If the SMB transport is connectionless, the **CID** (Connectionless Connection ID) SHOULD also be used to create the entry. All of these fields are

located in the request header. The server MUST assign a **CancelRequestID** for the request and MUST store it in the **Server.Connection.PendingRequestTable**. For a batched request, the entire batched request MUST be registered as a single entry in the **Server.Connection.PendingRequestTable**.

If the message received represents a further step in processing an existing command (for example, a secondary transaction message), the entry in the **Server.Connection.PendingRequestTable** SHOULD be updated by the request. The key values (**UID**, **TID**, **PID**, **MID**, and **SID**) MUST NOT be altered by the update.

3.3.5.2.2 Processing Options

If the message received is a command request that initiates processing of a command, the server SHOULD use the **SMB_Header.Flags2** field of the message to determine the capabilities from the **Server.Connection.ClientCapabilities** list that the client has requested to use for processing the command.

3.3.5.2.3 Message Signing

If a message is received and **Connection.IsSigningActive** is TRUE for the SMB connection, the signature MUST be verified as specified in section [3.1.5.1](#).

The server is responsible for providing the expected sequence number for signature validation. The sequence number for the next incoming request is stored in **Server.Connection.ServerNextReceiveSequenceNumber**. The server MUST remember the appropriate sequence number for the response to this request and does so by inserting it into the **Server.Connection.ServerSendSequenceNumber** table with the PID and **MID** that identify the request/response pair.

If the signature on the received packet is incorrect, the server MUST return STATUS_ACCESS_DENIED (ERRDOS/ERRnoaccess) and MUST increase **Server.Statistics.sts0_permerrors** by 1. After verifying that the signature on the current message is correct, the server MUST take the following steps.

```
IF request command EQUALS SMB_COM_NT_CANCEL THEN
  INCREMENT ServerNextReceiveSequenceNumber
ELSE IF request has no response THEN
  INCREMENT ServerNextReceiveSequenceNumber BY 2
ELSE
  SET ServerSendSequenceNumber[PID,MID] TO ServerNextReceiveSequenceNumber + 1
  INCREMENT ServerNextReceiveSequenceNumber BY 2
END IF
```

3.3.5.2.4 Receiving any Batched ("AndX") Request

When a server receives an AndX Request message, the server MUST process the batched requests sequentially. Each request is processed as specified in its respective Message Processing subsection, with the exception that if a response is generated, it MUST NOT be sent immediately. Instead, the server MUST batch the response into an AndX Response chain.

The server MUST use the information in the request header as the header information for each batched request. If processing a batched request causes a change in state that would affect the information in the header, the updated header information MUST be used when the server processes the subsequent request in the chain. If any of the requests in the AndX Request chain generate an

error, the error MUST be stored in the **SMB_Header.Status** field of the response, the AndX Response chain MUST be terminated at that response, and any further requests in the AndX Request chain (if any) MUST NOT be processed.

Once the AndX Response chain is terminated, an AndX Response message MUST be constructed as follows:

- The server MUST construct the [SMB Header \(section 2.2.3.1\)](#) using the header information as it was at the termination of the AndX Request chain.
- The AndX Response chain of Parameter and Data block pairs MUST be sequentially appended to the response message.
- If **Connection.IsSigningActive** is TRUE, the entire batched message is signed as specified in section [3.1.4.1](#).

The server MUST send the completed batch response to the client.

3.3.5.2.5 Receiving Any Transaction Request

Upon receipt of an [SMB_COM_TRANSACTION Request \(section 2.2.4.33.1\)](#), [SMB_COM_TRANSACTION2 Request \(section 2.2.4.46.1\)](#), or [SMB_COM_NT_TRANSACT Request \(section 2.2.4.62.1\)](#), the server MUST verify that it can process the transaction. In particular, the server MUST allocate sufficient space to accept the transaction subcommand parameters and data. The server MUST also be able to allocate **MaxParameterCount** plus **MaxDataCount** bytes for the results of the transaction. If the server is unable to allocate these resources, it SHOULD [<239>](#) return STATUS_INSUFF_SERVER_RESOURCES (ERRDOS/ERRnomem).

The server SHOULD perform initial validation of the transaction itself and return an error response if an error is detected. An error response terminates the transaction.

If no initial errors are detected, the server MUST determine whether the entire transaction is contained within the initial request message. If the value of the **ParameterCount** field is less than that of the **TotalParameterCount** and/or the value of the **DataCount** field is less than that of the **TotalDataCount**, then the server MUST send an Interim Response message, setting the **SMB_Parameters.WordCount** and **SMB_Data.ByteCount** fields to 0, and prepare to receive one or more secondary requests from the client in order to complete the transfer of the transaction.

The transaction is completely transferred to the server when:

- The total number of transaction parameter bytes received equals the smallest value of **TotalParameterCount** reported by the client across all of the transaction request messages sent, and
- The total number of transaction data bytes received equals the smallest value of **TotalDataCount** reported by the client across all of the transaction request messages sent.

When these conditions are met, the transaction can be processed.

If the processing of the transaction results in an error, the server MUST return an error response, which cancels the transaction.

If the transaction response, which includes the response parameters and data, is greater than permitted by **Server.Connection.ClientMaxBufferSize**, the server MUST send multiple final response messages in order to transfer the entire transaction response.

3.3.5.2.6 Supporting Shares in the DFS Namespace

If the DFS subsystem has indicated that it is active (section [3.3.4.3](#)) and that a particular share is a DFS share (section [3.3.4.3](#)), message processing MUST include the following:

If a request:

- Has the `SMB_FLAGS2_DFS` flag set;
- Contains a pathname field.

All pathname fields in the message MUST be DFS paths. The server MUST forward the DFS paths to the DFS subsystem for name resolution as specified in [\[MS-DFSC\]](#) section 3.1.4.1.

If the DFS subsystem can resolve the DFS path to local storage, the local storage MUST be accessed and message processing continues. If the DFS subsystem returns an error, the error MUST be sent to the client in an error response.

3.3.5.2.7 Granting OpLocks

If the message received is an open or create and includes a request for an OpLock, the following additional steps MUST be taken:

- If the **Server.Connection.OpLockSupport** state variable is FALSE, then an OpLock MUST NOT be granted.
- If the open or create is on a directory file, then an Oplock MUST NOT be granted.
- If the file is not open by any other process and **Server.Connection.OpLockSupport** is TRUE, then the requested OpLock type MUST be granted.
- If the file is open for read-only access by one or more other processes, and:
 - The open or create command specifies read-only access to the file;
 - The open or create command supports Level II OpLocks;
 - **Server.Connection.OpLockSupport** is true;

Then a Level II OpLock MUST be granted.

- Otherwise, an OpLock MUST NOT be granted.

See [\[FSBO\]](#) section 2.2, Granting OpLocks. For more information, see [\[MS-FSA\]](#), Server Requests an OpLock.

The server MUST also request that the underlying file system notify the server when the granted OpLock is broken. See [\[FSBO\]](#) section 2.3, Breaking OpLocks. For more information, see [\[MS-FSA\]](#), Server Acknowledges an OpLock Break.

3.3.5.3 Receiving an SMB_COM_CREATE_DIRECTORY Request

Upon receipt of an [SMB_COM_CREATE_DIRECTORY Request \(section 2.2.4.1.1\)](#) from the client, the server MUST verify the following:

- The **TID** in the **SMB_Header.TID** field MUST be a valid **TID** for this SMB connection, as defined in section [3.3.5.2](#).

- If the last element of the pathname in the **SMB_Data.Bytes.DirectoryName** field is removed, the remaining pathname MUST represent a valid directory within the share indicated by the **TID**.
- The full pathname from the **SMB_Data.Bytes.DirectoryName** field MUST NOT resolve to an existing file or directory or other file system object.
- The **UID** in the **SMB_Header.UID** field MUST be valid, as defined in section [3.3.5.2](#), and MUST represent the security context of a user with permission to create the directory. If the user does not have permission to create the directory, the server MUST return an error response with **STATUS_ACCESS_DENIED** (ERRDOS/ERRnoaccess) and MUST increase **Server.Statistics.sts0_permerrors** by 1.
- If the designated directory already exists, the server MUST return an error response with **STATUS_OBJECT_NAME_COLLISION** (ERRDOS/ ERRfileexists).

If these conditions are met, the server MUST attempt to create the directory. <240> If directory creation fails, the server MUST provide an error response to the client (see section [2.2.4.1.2](#) for the list of expected error codes). Otherwise, the server the server MUST increase **Server.Statistics.sts0_fopens** by 1 and MUST return **Success** in the **Status** field. A new **Open** object MUST be allocated and inserted into **Server.Connection.FileOpenTable** with the following default values:

- A new **FID** MUST be created to uniquely identify this **Open** request in **Server.Connection.FileOpenTable**.
- **Server.Open.TreeConnect** MUST be set to the **TreeConnect** on which the open request was performed, and **Server.Open.TreeConnect.OpenCount** MUST be incremented by 1.

The server MUST register the **Open** request by invoking the Server Registers a New Open event ([\[MS-SVRS\]](#) section 3.1.6.4) and MUST assign the return value to **Server.OpenFileGlobalId**.

The response MUST be sent to the client as specified in section [3.3.4.1](#).

3.3.5.4 Receiving an SMB_COM_DELETE_DIRECTORY Request

Upon receipt of an [SMB_COM_DELETE_DIRECTORY Request \(section 2.2.4.2.1\)](#) from the client, the server MUST verify the following:

- The **TID** in the **SMB_Header.TID** field MUST be a valid **TID** for this SMB connection, as defined in section [3.3.5.2](#).
- The pathname in the **SMB_Data.Bytes.DirectoryName** field MUST represent a valid directory within the share indicated by the **TID**.
- The UID in the **SMB_Header.TID** field MUST be valid, as defined in section [3.3.5.2](#) and MUST represent the security context of a user with permission to delete the directory. If the user does not have permission to delete the directory, the server MUST return an error response with **STATUS_ACCESS_DENIED** (ERRDOS/ERRnoaccess) and MUST increase **Server.Statistics.sts0_permerrors** by 1.
- The specified directory MUST NOT be the root directory of the share (which cannot be deleted by the client).
- The specified directory MUST be empty.

If any of the preceding conditions is not met, the server MUST return an error message with the appropriate status code, as listed in section [2.2.4.2.2](#). Otherwise, the server MUST attempt to delete

the directory. If the deletion fails, the server MUST return an error message with a status code indicating the cause of the failure. <241> If the directory is not empty, deletion MUST fail with STATUS_DIRECTORY_NOT_EMPTY (ERRDOS/ERRnoaccess).

If the deletion succeeds, the server MUST perform a lookup in **Server.Connection.SearchOpenTable** for **Server.SearchOpens** with **Server.SearchOpen.TIDs** that match **SMB_Header.TID** and SHOULD <242> close any such **Server.SearchOpen** that represents a search on the deleted directory, as determined by a comparison of **Server.SearchOpen.PathName** and **SMB_Data.Bytes.DirectoryName**. The server MUST construct an SMB_COM_DELETE_DIRECTORY Response (section 2.2.4.2.2) message and MUST set **SMB_Header.Status** to indicate success.

The response MUST be sent to the client as specified in section 3.3.4.1.

3.3.5.5 Receiving an SMB_COM_OPEN Request

Upon receipt of an [SMB_COM_OPEN Request](#), the server MUST validate the **TID** field and the **UID** field, as specified in section 3.3.5.2.

If the **ShareType** property of the **Server.Share** specified by the **SMB_Header.TID** is equal to **Named Pipe** and if **Server.Session.IsAnonymous** is TRUE, the server MUST invoke the event specified in [\[MS-SRV5\]](#) section 3.1.6.17 by providing the **SMB_Data.Bytes.FileName** field with the "\PIPE\" prefix removed as input parameter. If the event returns FALSE, indicating that no matching named pipe is found that allows an anonymous user, the server MUST fail the request with STATUS_ACCESS_DENIED and MUST increase **Server.Statistics.sts0_permerrors** by 1. Otherwise, the server MUST continue the open processing.

The server MUST search for a file with a name matching the name given in the request's **SMB_Data.Bytes.FileName** field and SHOULD search based on **SearchAttributes**. <243> If no matching file is found, or if the file is found but cannot be opened, the server MUST return an error response with a **Status** indicating the error as listed in the error code table in section 2.2.4.3.2. <244> If the underlying object store returns STATUS_ACCESS_DENIED, the server MUST increase **Server.Statistics.sts0_permerrors** by 1. Otherwise, the server MUST allocate a new **FID**, format an SMB_COM_OPEN response message as specified in section 2.2.4.3, and set **SMB_Header.Status** to indicate success. If the command is successful, the server MUST increase **Server.Statistics.sts0_fopens** by 1 and MUST allocate an **Open** object and insert it into **Server.Connection.FileOpenTable** with the following default values:

- A new **FID** MUST be created to uniquely identify this **Open** in **Server.Connection.FileOpenTable**.
- If **Server.EnableOplock** is TRUE and a requested OpLock was granted, the type of OpLock MUST be set in **Server.Open.OpLock** and **Server.Open.OplockState** MUST be set to **Held**; otherwise, **Server.Open.OpLock** MUST be set to **None** and **Server.Open.OplockState** MUST be set to **None**.
- **Server.Open.TreeConnect** MUST be set to the **TreeConnect** on which the open request was performed, and **Server.Open.TreeConnect.OpenCount** MUST be increased by 1.
- **Server.Open.Session** MUST be set to **Server.Open.TreeConnect.Session**.
- **Server.Open.Connection** MUST be set to the **Server.Open.Session.Connection**.
- **Server.Open.Locks** MUST be set to an empty list.
- **Server.Open.PID** MUST be set to the **PID** provided in the request.

- **Server.Open.PathName** MUST be set to the **FileName** field of the request.
- **Server.Open.GrantedAccess** MUST be set to the **AccessMode** field of the request.

The server MUST register the **Open** by invoking the event Server Registers a New Open ([\[MS-SRVS\]](#) section 3.1.6.4) and MUST assign the return value to **Server.Open.FileGlobalId**.

The response MUST be sent to the client as specified in section [3.3.4.1](#).

3.3.5.6 Receiving an SMB_COM_CREATE Request

Upon receipt of an [SMB_COM_CREATE Request \(section 2.2.4.4.1\)](#), the server MUST attempt to create or overwrite the file named in the **FileName** field of the request. If the file does not already exist (is being created), the server MUST also attempt to set the attributes of the file to those provided in the **FileAttributes** field. The server MAY [<245>](#) set the creation time of the file from the **CreationTime** field.

- The user indicated by the **UID** MUST have write permission on the file's parent directory in order to create a new file; otherwise, the server MUST increase **Server.Statistics.sts0_permerrors** by 1, fail the request, and return an error response with STATUS_ACCESS_DENIED (ERRDOS/ERRnoaccess).
- The user indicated by the **UID** MUST have write permission on the file itself in order to truncate it; otherwise, the server MUST increase **Server.Statistics.sts0_permerrors** by 1, fail the request, and return an error response with STATUS_ACCESS_DENIED (ERRDOS/ERRnoaccess).
- The server MUST grant read/write permission for the creator if the file is created. Access permissions for truncated files are not modified. The newly created or truncated file is opened for read/write in Compatibility Mode (see section [3.2.4.5.1](#)).

If the Create operation fails, the server MUST return an error response with a **Status** code from the list provided in section [2.2.4.4.2](#). Otherwise, the server MUST allocate a new FID, format an SMB_COM_CREATE response message as defined in section [2.2.4.4.2](#), and set **SMB_Header.Status** to indicate success. **Server.Statistics.sts0_fopens** MUST be increased by 1, and an **Open** containing the new FID MUST be created, initialized, and entered into the **Server.Connection.FileOpenTable**. [<246>](#) If **Server.EnableOplock** is TRUE and a requested OpLock was granted, the type of OpLock MUST be set in **Server.Open.OpLock** and **Server.Open.OplockState** MUST be set to **Held**; otherwise, **Server.Open.OpLock** MUST be set to **None** and **Server.Open.OplockState** MUST be set to **None**. **Server.Open.TreeConnect** MUST be set to the **TreeConnect** on which the request was performed, and **Server.Open.TreeConnect.OpenCount** MUST be increased by 1. **Server.Open.Session** MUST be set to the **Server.Open.TreeConnect.Session**. **Server.Open.Connection** MUST be set to the **Server.Open.Session.Connection**. **Server.Open.Locks** MUST be set to an empty list. **Server.Open.PID** MUST be set to the **PID** provided in the request. **Server.Open.PathName** MUST be set to the **FileName** field of the request. **Server.Open.GrantedAccess** MUST be set to (GENERIC_READ | GENERIC_WRITE). [<247>](#)

The server MUST register the **Open** by invoking the Server Registers a New Open event ([\[MS-SRVS\]](#) section 3.1.6.4), and it MUST assign the return value to **Server.Open.FileGlobalId**.

The response MUST be sent to the client as specified in section [3.3.4.1](#).

3.3.5.7 Receiving an SMB_COM_CLOSE Request

Upon receipt of an [SMB_COM_CLOSE Request \(section 2.2.4.5.1\)](#), the server MUST confirm that the supplied **FID** is valid and that it represents a file system object held open by the client. This is done by looking up the **FID** in **Server.Connection.FileOpenTable** to find the corresponding **Open**.

If the **Open** is not found, the **FID** is not valid, and the server MUST return an error response to the client with a **Status** of STATUS_INVALID_HANDLE (ERRDOS/ERRbadfid). The server SHOULD [<248>](#) update the last modification time for the file if the value of the **SMB_Parameters.Word.LastTimeModified** field is neither 0x00000000 nor 0xFFFFFFFF, and the client has write/append access to the file. Then the server MUST decrease **Open.TreeConnect.OpenCount** and **Server.Statistics.sts0_fopens** by 1, release the OpLocks by closing the **Open** indicated by the **FID**, [<249>](#) release every lock in **Server.Open.Locks**, [<250>](#) and invalidate the **FID** by removing the **Open** entry from **Server.Connection.FileOpenTable**. The server MUST provide **Open.FileGlobalId** as an input parameter and MUST deregister the **Open** by invoking the Server Deregisters an Open event ([\[MS-SRVS\]](#) section 3.1.6.5).

Once the **FID** has been invalidated, it is available to be reused by future open or create operations.

The response MUST be sent to the client as specified in section [3.3.4.1](#).

3.3.5.8 Receiving an SMB_COM_FLUSH Request

Upon receipt of an [SMB_COM_FLUSH Request \(section 2.2.4.6.1\)](#), the server MUST confirm that the supplied **FID** is either the value 0xFFFF ((USHORT)(-1)) or a valid **FID** representing a file system object held open by the client. The **FID** is validated by performing a look-up in the **Server.Connection.FileOpenTable** to find the corresponding **Open**. If the **FID** is 0xFFFF, the **Server.Connection.FileOpenTable** MUST be scanned for all files that were opened by the **PID** listed in the request header. The server MUST attempt to flush each **Server.Open** so listed. If the **FID** is invalid, the server MUST return STATUS_INVALID_HANDLE (ERRDOS/ERRbadfid) to the client.

If the **FID** is valid, the server MUST ensure that all written data and additional file allocations are committed to each referenced file by the underlying object store. The server MUST NOT respond to the flush request prior to committing all written data and ensuring that additional file allocations have been committed. At minimum, the server MUST ensure that all other clients or local processes that are reading from the file can read the same information as the process performing the flush operation.

The server MUST then attempt to flush each referenced file by invoking the underlying object store using implementation-dependent [<251>](#) functionality. If an error Status is generated by any flush operation, the Status is returned in an error response message, and no further processing occurs (no more files are flushed).

The response MUST be sent to the client as specified in section [3.3.4.1](#).

3.3.5.9 Receiving an SMB_COM_DELETE Request

Upon receipt of an [SMB_COM_DELETE Request \(section 2.2.4.7.1\)](#), the server MUST attempt to delete all files that match both the **FileName** and **SearchAttributes** fields from the request. The final component of the **FileName** field can contain wildcard characters, allowing multiple files to be deleted.

The precise effect of the SMB_COM_DELETE command is server implementation-dependent. The following criteria SHOULD be observed:

- If **Server.Connection.OpLockSupport** is TRUE, and another client has been granted a batch OpLock on the file, then the server MUST send an OpLock break notification request via [SMB_COM_LOCKING_ANDX Request \(section 2.2.4.32.1\)](#) to the client that owns the batch OpLock, as specified in section 3.3.4.2. The server MUST have the OPLOCK_RELEASE flag set on the TypeOfLock. The server MUST set the **NewOpLockLevel** field to 0x00. The SMB_COM_DELETE command request being processed MUST block until the OpLock is either acknowledged by the client or the OpLock Break Acknowledgement Timer has expired. [<252>](#)
- The user initiating the request MUST have write permission in the target file's parent directory for the operation to succeed.

If a wildcard pathname matches more than one file, the server SHOULD search for and delete all files matching the search criteria. The server SHOULD delete matching files sequentially and, if an error occurs, immediately return an error response with the **Status** field set to indicate the error. In this case, some files that match the search criteria and can be deleted will not be deleted. [<253>](#)

The **SearchAttributes** field specifies the types of files that are to be deleted:

- If **SearchAttributes** is 0x0000 (SMB_FILE_ATTRIBUTE_NORMAL), the server MUST match only normal files.
- If the SMB_FILE_ATTRIBUTE_HIDDEN or SMB_FILE_ATTRIBUTE_SYSTEM are specified, the delete operation MUST include the type or types specified in addition to normal files.
- Read-only files MUST NOT be deleted.
- All other search attributes are ignored by the server.
 - This command cannot delete directories or volumes.
 - The archive bit is not considered when selecting files.

The following conditions MUST generate an error response (see the error code list in section [2.2.4.7.2](#) for additional error conditions):

- Within the share indicated by the **TID**, no files are found that match both the **SearchAttributes** and the pathname specified by **FileName** (STATUS_NO_SUCH_FILE (ERRDOS/ERRbadfile)).
- The **TID** is invalid (STATUS_SMB_BAD_TID (ERRSRV/ERRinvtid)).
- The user represented by the **UID** does not have permission to delete any of the selected files (STATUS_ACCESS_DENIED (ERRDOS/ERRnoaccess)) and the server MUST increase **Server.Statistics.sts0_permerrors** by 1.
- The pathname specified by **FileName** is an invalid path (STATUS_OBJECT_PATH_SYNTAX_BAD (ERRDOS/ERRbadpath)).

Another process has the file open in a sharing mode that does not permit the file to be deleted. [<254>](#)

If any of the above conditions is true, or any other error is generated that prevents completion of the operation, the server MUST return an error response message to the client. Otherwise, the server MUST format an SMB_COM_DELETE response message as defined in section [2.2.4.7](#) and MUST set **SMB_Header.Status** to indicate success. [<255>](#)

The response MUST be sent to the client as described in section [3.3.4.1](#).

3.3.5.10 Receiving an SMB_COM_RENAME Request

Upon receipt of an [SMB_COM_RENAME Request \(section 2.2.4.8.1\)](#), the server MUST enumerate the set of files that matches both the **OldFileName** pathname and the **SearchAttributes** field in the request. Each matching file name MUST be renamed according to the format of the **NewFileName** pathname. If the target name already exists, the Rename operation MUST fail with a **Status** of STATUS_OBJECT_NAME_COLLISION (ERRDOS/ERRfilexists). [.<256>](#)

Other considerations:

- Only a single **TID** is supplied, so the **OldFileName** and **NewFileName** pathnames MUST be within the same share on the server.
- If **SearchAttributes** is 0x0000 (SMB_FILE_ATTRIBUTE_NORMAL), the server MUST match only normal files.
- If the SMB_FILE_ATTRIBUTE_HIDDEN or SMB_FILE_ATTRIBUTE_SYSTEM attributes are specified, the rename operation MUST include the type or types specified in addition to normal files.
 - This command cannot rename read-only files.
 - This command cannot rename directories.
 - This command MUST NOT rename volume labels.
 - This command cannot rename hidden and/or system files if the appropriate bits are set in **SearchAttributes**.

A file to be renamed might currently be open. If it is opened by the requesting process, it MUST be open in compatibility mode (see section [3.2.4.5.1](#)). If it is not open in compatibility mode, the rename MUST fail with STATUS_ACCESS_DENIED (ERRDOS/ERRnoaccess) and **Server.Statistics.sts0_permerrors** MUST be increased by 1. [.<257>](#)

- If another process has the file open, and that process has an OpLock on the file, and the process has asked for extended notification (Batch OpLock), the rename request MUST block until the server has sent an OpLock break request to the owner of the OpLock, as specified in section 3.3.4.2, and either received a response or the OpLock break time-out has expired. [.<258>](#) The server MUST have the OPLOCK_RELEASE flag set in the **TypeofLock** field of the request. The server MUST set the **NewOplockLevel** field of the request to 0x00. If the process holding the OpLock closes the file (thus freeing the OpLock) the rename takes place. If not, the rename MUST fail with STATUS_SHARING_VIOLATION.
- If there is an existing file with the new name, the rename MUST fail with STATUS_OBJECT_NAME_COLLISION. If wildcards are used in a rename operation, and only some of the renames fail for any reason, the request MUST fail silently; that is, an error MUST NOT be returned if at least one of the rename operations was successful.

A server may be processing multiple requests on the same resource concurrently. As a result, there may be interactions between the execution of the Rename operation and other operations such as ongoing searches (SMB_COM_SEARCH, SMB_COM_FIND, TRANS2_FIND_FIRST2, and so on). Although renaming a directory or files within a directory that is actively being searched is not prohibited, the interaction can disrupt the search, causing it to complete before all directory entries have been returned.

Renaming files using wildcards is supported. Only the final path element of each of the provided pathnames is permitted to contain wildcard characters. Wildcard characters MUST NOT be used in

the rest of the path. When wildcard characters are in use, the translation from the old name to the new name proceeds as described in [\[FSBO\]](#).

If a directory is renamed, it MUST NOT have a destination located within itself or any subdirectory within the source directory. The source and destination MUST be at or below the current **TID** within the file system namespace. If these conditions are not met, the server MUST return STATUS_OBJECT_PATH_SYNTAX_BAD (ERRDOS/ERRbadpath).

If the operation is successful, the server MUST construct an [SMB_COM_RENAME Response \(section 2.2.4.8.2\)](#) message. The response MUST be sent to the client as specified in section [3.3.4.1](#).

3.3.5.11 Receiving an SMB_COM_QUERY_INFORMATION Request

When the server receives an [SMB_COM_QUERY_INFORMATION Request \(section 2.2.4.9.1\)](#), it MUST query the file system metadata of the file identified in the **FileName** field of the request. The **FileName** field MUST be the full path, relative to the supplied **TID**, of the file being queried. The server MUST query the file information through the FILE_NETWORK_OPEN_INFORMATION **OutputBuffer** from the underlying object store with information level [FileNetworkOpenInformation \(\[MS-FSCC\] section 2.4.27\).<259>](#)

If the file exists and the operation is successful, the server MUST construct an SMB_COM_QUERY_INFORMATION response message as specified in section [2.2.4.9.2](#). The server MUST return the following information:

- **FileAttributes** in **SMB_FILE_ATTRIBUTES** format, as specified in section [2.2.1.2.4](#).
- The **LastWriteTime** of the file, presented in UTIME format.
- **FileSize**, which is the size of the file in bytes. **FileSize** is a 32-bit value. If the file is larger than $2^{32} - 1$ bytes in size, only the lower 32 bits of the file size are returned. No error message is sent to indicate this condition.
- If the query fails, the **Status** is set to the error code received from the object store and is returned in an Error Response, and processing is complete. Otherwise, the response message fields are populated as follows:
 - **SMB_Parameters.Words.FileAttributes** is set to **OutputBuffer.FileAttributes**.
 - **SMB_Parameters.Words.LastWriteTime** is set to **OutputBuffer.LastWriteTime**.
 - **SMB_Parameters.Words.FileSize** is set to **OutputBuffer.EndOfFile**.

The response MUST be sent to the client as specified in section [3.3.4.1](#).

3.3.5.12 Receiving an SMB_COM_SET_INFORMATION Request

When the server receives an [SMB_COM_SET_INFORMATION Request \(section 2.2.4.10.1\)](#), it MUST verify that the file indicated by the **FileName** field in the request exists. If the file does not exist, the server MUST fail the request with STATUS_OBJECT_NAME_NOT_FOUND (ERRDOS/ERRbadfile). If the file exists and the user indicated by the **UID** field in the request header does not have permission to modify file metadata, the server MUST fail the request with STATUS_ACCESS_DENIED (ERRDOS/ERRnoaccess) and MUST increase **Server.Statistics.sts0_permerrors** by 1.

Otherwise, the server MUST attempt to set the file attributes provided in the request:

- **FileAttributes**, in [SMB_FILE_ATTRIBUTES \(section 2.2.1.2.4\)](#) format.

- **LastWriteTime**: the time of the last write to the file, in [UTIME \(section 2.2.1.4.3\)](#) format. If this field contains 0x00000000, the last write time of the file MUST NOT be changed. <260>

The response MUST be sent to the client as specified in section [3.3.4.1](#).

3.3.5.13 Receiving an SMB_COM_READ Request

When the server receives an SMB_COM_READ request, it MUST perform the following actions:

- Verify the FID, which represents an **Open** of a file. If the **Open** is not found in **Server.Connection.FileOpenTable**, the server MUST return an error response with a **Status** of STATUS_INVALID_HANDLE (ERRDOS/ERRbadfid).
- Verify the **UID** as described in section [3.3.5.2](#), and ensure that the user has permission to read from the file. If the user does not have permission to read the file, the server MUST send an error response with a **Status** of STATUS_ACCESS_DENIED (ERRDOS/ERRnoaccess) and MUST increase **Server.Statistics.sts0_permerrors** by 1.
- If the UID presented is different from the UID that opened the file, the server MUST send the error response with a **Status** of STATUS_INVALID_HANDLE (ERRDOS/ERRbaduid).
- The server MUST attempt to read data from the underlying object store for the file identified by the FID in the request. It MUST provide the **ReadOffsetInBytes** and **CountOfBytesToRead** fields from the request. <261>
- If the **EstimateOfRemainingBytesToBeRead** field is nonzero, the server MAY use the **EstimateOfRemainingBytesToBeRead** field as a hint for read ahead.

If the request is to read from a named pipe in message mode, the message is larger than **CountOfBytesToRead** bytes, and the underlying object store returned STATUS_BUFFER_OVERFLOW (ERRDOS/ERRmoredata), the server MUST respond with a complete SMB_COM_READ response not an error response. Any other error MUST generate an error response message 2.

Otherwise, the server MUST construct an [SMB_COM_READ Response \(section 2.2.4.22.2\)](#) message.

The response MUST be sent to the client as specified in section [3.3.4.1](#).

3.3.5.14 Receiving an SMB_COM_WRITE Request

Upon receipt of an [SMB_COM_WRITE Request \(section 2.2.4.12.1\)](#), the server MUST perform the following actions:

- Verify the FID, which represents an open regular file. If the **Open** is not found in **Server.Connection.FileOpenTable**, the server MUST return an error response with a **Status** of STATUS_INVALID_HANDLE (ERRDOS/ERRbadfid).
- Verify the **UID** as described in section [3.3.5.2](#), and ensure that the user has permission to write to the file. If the user does not have permission to write to the file, the server MUST send an error response with a status of STATUS_ACCESS_DENIED (ERRDOS/ERRnoaccess) and MUST increase **Server.Statistics.sts0_permerrors** by 1.
- If the **UID** presented is different from the **UID** that opened the file, the server MUST send the error response with a **Status** of STATUS_INVALID_HANDLE (ERRDOS/ERRbaduid).
- In the file identified by the FID, the server MUST perform a seek to the offset specified in the **WriteOffsetInBytes** field in the request.

- The server MUST write **CountOfBytesToWrite** bytes sequentially from the **Data** field in the request to the file. Any failure that causes less than **CountOfBytesToWrite** bytes to be written SHOULD result in an error response to the client. <262>
- If the **EstimateOfRemainingBytesToBeWritten** field is nonzero in the request, the server MAY use the value provided to perform implementation-specific optimizations, such as preallocating disk space or preparing additional buffers to receive the remaining data.

If FID represents a disk file, and the request specifies a byte range beyond the current end of file, the file MUST be extended. If **Offset** is beyond the end of file, the "gap" between the current end of file and **Offset** is filled with null padding bytes. If **CountOfBytesToWrite** is zero, the file is truncated or extended to the length specified by **Offset**.

In the event of an error, the server MUST send an error response message. Otherwise, the server MUST construct an [SMB_COM_WRITE Response \(section 2.2.4.12.2\)](#) message. The **CountOfBytesWritten** field MUST contain the number of bytes written to the file. This value SHOULD be equal to **CountOfBytesToWrite**. If the number of bytes actually written (**CountOfBytesWritten**) differs from the number of bytes requested to be written (**CountOfBytesToWrite**), and no error is indicated, the server has no resources available with which to satisfy the complete write.

The response MUST be sent to the client as specified in section [3.3.4.1](#).

3.3.5.15 Receiving an SMB_COM_LOCK_BYTE_RANGE Request

Upon receipt of an [SMB_COM_LOCK_BYTE_RANGE Request \(section 2.2.4.20.1\)](#), the server MUST verify the **FID** and the **UID** and MUST verify that the user has, at minimum, read permission on the file.

- The **FID** is verified by performing a looking up in the **Server.Connection.FileOpenTable** to find the corresponding **Open**. If the **Open** is not found, the **FID** is not valid and the server MUST return an error response to the client with a **Status** of STATUS_INVALID_HANDLE (ERRDOS/ERRbadfid).
- The **UID** is validated as described in section [3.3.5.2](#).
- If the user does not have permission to perform a byte range lock, the server MUST return an error response to the client with a **Status** of STATUS_ACCESS_DENIED (ERRDOS/ERRnoaccess) and MUST increase **Server.Statistics.sts0_permerrors** by 1.
- If the UID that is presented is different from the UID that opened the file, the server MUST send the error response with a **Status** of STATUS_INVALID_HANDLE (ERRDOS/ERRbaduid).

The server MUST then attempt to obtain a byte-range exclusive lock from the underlying object store on a contiguous range of bytes in the file specified by the **FID** in the request starting at **LockOffsetInBytes** and extending for **CountOfBytesToLock** bytes. <263>

This command is used to explicitly lock a contiguous range of bytes in an open regular file. Locks prevent attempts to lock, read, or write the locked portion of the file by other clients or PIDs from the same client.

- Adjacent locks cannot be combined.
- Locks MUST NOT overlap.
- Offsets beyond the current end of file can be locked. Such locks MUST NOT cause allocation of additional file space.

- Locks can be unlocked only by the PID that obtained the lock.

See [\[FSBO\]](#) section 3 for details of byte range lock semantics.

In the event of an error, including failure to grant the lock on the byte range, the server MUST send an error response message. If the server cannot immediately grant the lock, the server SHOULD<264> reattempt the lock request for a brief interval, returning an error response with a **Status** of STATUS_FILE_LOCK_CONFLICT (ERRDOS/ERRlock) to the client if the lock cannot be granted.

If the lock is successful, the server MUST construct an [SMB_COM_LOCK_BYTE_RANGE Response \(section 2.2.4.13.2\)](#) message. The response MUST be sent to the client as specified in section [3.3.4.1](#). An entry for the newly-granted byte-range lock MUST be added to **Server.Open.Locks**. The type of the lock MUST be exclusive, and the entry MUST be formatted with a 32-bit offset (LOCKING_ANDX_RANGE32).

3.3.5.16 Receiving an SMB_COM_UNLOCK_BYTE_RANGE Request

Upon receipt of an [SMB_COM_UNLOCK_BYTE_RANGE Request \(section 2.2.4.14.1\)](#), the server MUST verify the FID in the request by looking it up in the **Server.Connection.OpenTable** (see section [3.3.5.2](#)). The **FID** and the byte range being unlocked MUST exactly match a range that was previously locked by the same **PID**, and stored as an entry in **Server.Open.Locks**; otherwise, the server MUST send an error response message with status set to STATUS_RANGE_NOT_LOCKED (ERRDOS/ERROR_NOT_LOCKED). See [\[FSBO\]](#) section 3 for details of byte range lock semantics.<265>

If the unlock is successful, the server MUST construct an SMB_COM_UNLOCK_BYTE_RANGE response message as defined in section [2.2.4.14](#). The response MUST be sent to the client as specified in section [3.3.4.1](#). The server MUST remove the matching entry from the **Server.Open.Locks** list.

3.3.5.17 Receiving an SMB_COM_CREATE_TEMPORARY Request

When the server receives an [SMB_COM_CREATE_TEMPORARY Request \(section 2.2.4.15.1\)](#), it MUST verify that the **DirectoryName** passed in the request identifies a directory within the supplied **TID**, verify the **UID** and ensure that the user has the necessary permissions to create a file in the directory. If the underlying object store returns STATUS_ACCESS_DENIED, the server MUST increase **Server.Statistics.sts0_permerrors** by 1.

The server MUST then create the file:

- The name of the newly created file MUST NOT be the same as the name of any other file in the directory; otherwise, the server MUST return an error response with **Status** set to STATUS_OBJECT_NAME_COLLISION (ERRDOS/ERRfilexists).
- The creation time of the file MAY be set to the value of the **CreationTime** field in the request.
- The file is opened for read/write in Compatibility Mode (see section [3.2.4.5.1](#)).

If the command is successful, the server MUST increase **Server.Statistics.sts0_fopens** by 1 and MUST allocate an **Open** object and insert it into **Server.Connection.FileOpenTable** with the following default values:

- A new **FID** MUST be created to uniquely identify this **Open** in **Server.Connection.FileOpenTable**.

- If **Server.EnableOplock** is TRUE and a requested OpLock was granted, the type of OpLock MUST be set in **Server.Open.OpLock** and **Server.Open.OplockState** MUST be set to **Held**; otherwise, **Server.Open.OpLock** MUST be set to **None** and **Server.Open.OplockState** MUST be set to **None**.<266>
- **Server.Open.TreeConnect** MUST be set to the **TreeConnect** on which the open request was performed, and **Server.Open.TreeConnect.OpenCount** MUST be increased by 1.
- The server MUST construct an [SMB_COM_CREATE_TEMPORARY Response \(section 2.2.4.15.2\)](#) message.
- **Server.Open.Session** MUST be set to **Server.Open.TreeConnect.Session**.
- **Server.Open.Connection** MUST be set to the **Server.Open.Session.Connection**.
- **Server.Open.Locks** MUST be set to an empty list.
- **Server.Open.PID** MUST be set to the **PID** provided in the request.
- **Server.Open.PathName** MUST be set to the name of the newly created file.
- **Server.Open.GrantedAccess** MUST be set to (GENERIC_READ | GENERIC_WRITE).

The server MUST register the **Open** by invoking the event Server Registers a New Open ([\[MS-SRV5\] section 3.1.6.4](#)) and MUST assign the return value to **Server.Open.FileGlobalId**.

If an error occurred, the server MUST send an error response message.

The response MUST be sent to the client as specified in section [3.3.4.1](#).

3.3.5.18 Receiving an SMB_COM_CREATE_NEW Request

This command is used to create a new file. It MUST NOT truncate or overwrite an existing file. If a file with the requested pathname already exists within the share represented by the **TID**, the command MUST fail with STATUS_OBJECT_NAME_COLLISION (ERRDOS/ERRfileexists). This command MUST be used only to create regular files.

When the server receives an [SMB_COM_CREATE_NEW Request](#), it MUST verify the **TID** and the directory path portion of the **FileName** field. The server MUST verify the **UID** and ensure that the user has write permission on the file's parent directory in order to create a new file. If the underlying object store returns STATUS_ACCESS_DENIED, the server MUST increase **Server.Statistics.sts0_permerrors** by 1. If the file is created successfully, it is opened for read/write access in Compatibility Mode (see section [3.2.4.5.1](#)).

If the command is successful, the server MUST increase **Server.Statistics.sts0_fopens** by 1 and MUST allocate an **Open** object and insert it into **Server.Connection.FileOpenTable** with the following default values:

- A new FID MUST be created to uniquely identify this **Open** in **Server.Connection.FileOpenTable**.
- If **Server.EnableOplock** is TRUE and a requested OpLock was granted, the type of OpLock MUST be set in **Server.Open.OpLock** and **Server.Open.OplockState** MUST be set to **Held**; otherwise, **Server.Open.OpLock** MUST be set to **None** and **Server.Open.OplockState** MUST be set to **None**.

- **Server.Open.TreeConnect** MUST be set to the **TreeConnect** on which the open request was performed, and **Server.Open.TreeConnect.OpenCount** MUST be increased by 1.
- **Server.Open.Session** MUST be set to **Server.Open.TreeConnect.Session**.
- **Server.Open.Connection** MUST be set to the **Server.Open.Session.Connection**.
- **Server.Open.Locks** MUST be set to an empty list.
- **Server.Open.PID** MUST be set to the **PID** provided in the request.
- **Server.Open.PathName** MUST be set to the **FileName** field of the request.
- **Server.Open.GrantedAccess** MUST be set to (GENERIC_READ | GENERIC_WRITE).

The server MUST register the **Open** by invoking the event Server Registers a New Open ([\[MS-SRVS\]](#) section 3.1.6.4) and MUST assign the return value to **Server.Open.FileGlobalId**.

The server MUST construct an [SMB_COM_CREATE_NEW Response \(section 2.2.4.16.2\)](#) message and return the newly-created **FID**.[<267>](#)

If an error occurred, the server MUST send an error response message.

The response MUST be sent to the client as specified in section [3.3.4.1](#).

3.3.5.19 Receiving an SMB_COM_CHECK_DIRECTORY Request

When a server receives an [SMB_COM_CHECK_DIRECTORY Request \(section 2.2.4.17.1\)](#), it MUST verify that **DirectoryName** points to a valid directory. The user indicated by the **UID** MUST have read access to the directory path. If the user does not have read access to the directory path, the server MUST return an error response with status of STATUS_ACCESS_DENIED (ERRDOS/ERRnoaccess) and MUST increase **Server.Statistics.sts0_permerrors** by 1.

If **DirectoryName** points to a valid directory, the server MUST construct an [SMB_COM_CHECK_DIRECTORY Response \(section 2.2.4.17.2\)](#) message with a **Status** indicating success. Otherwise, the server MUST send an error response with a **Status** of STATUS_OBJECT_PATH_NOT_FOUND (ERRDOS/ERRbadpath). See the error code list in section [2.2.4.17.2](#) for additional error conditions.[<268>](#)

The response MUST be sent to the client as specified in section [3.3.4.1](#).

3.3.5.20 Receiving an SMB_COM_PROCESS_EXIT Request

When the server receives an [SMB_COM_PROCESS_EXIT Request \(section 2.2.4.18.1\)](#), it MUST:

- Enumerate all of the FIDs in **Server.Connection.FileOpenTable** that were opened by the **PID** indicated in the request header. For each FID:
 - The server MUST release all locks held on the FID.
 - The server MUST release OpLocks by closing the **Open** represented by each FID[<269>](#) and MUST decrease **Open.TreeConnect.OpenCount** and **Server.Statistics.sts0_fopens** by 1 for each FID.
 - The server MUST invalidate the FID by removing the **Open** entry from **Server.Connection.FileOpenTable**.

- The server MUST provide the corresponding **Open.FileGlobalId** as an input parameter and MUST deregister the **Open** by invoking the event Server Deregisters an Open ([\[MS-SRVS\]](#) section 3.1.6.5).
- Enumerate all of the Search IDs (SID)s in the **Server.Connection.SearchOpenTable** that were opened by the **PID** indicated in the request header. For each **SID**:
 - The server MUST close the search indicated by the **SID**.
 - The server MUST invalidate the **SID** by removing the **SearchOpen** entry from **Server.Connection.SearchOpenTable**.

The server MUST search the **Server.Connection.PendingRequestTable** for any pending commands that have the same **UID**, **TID**, **PID**, and **MID** as presented in the request. If the SMB transport is connectionless, the header **CID** field value SHOULD<270> also be used. For each matching entry, the server MUST abort the pending operation. The client process that made the aborted command request no longer exists to receive the response.

If the Process Exit operation completes successfully, the server MUST construct an SMB_COM_PROCESS_EXIT response message as specified in section [2.2.4.18.2](#). The **Status** returned MUST indicate success. Otherwise, the server MUST send an error response.

The response MUST be sent to the client as specified in section [3.3.4.1](#).

3.3.5.21 Receiving an SMB_COM_SEEK Request

Upon receipt of an [SMB_COM_SEEK command Request \(section 2.2.4.19.1\)](#), the server MUST first validate the **FID** in the request. If the **FID** is valid, the server MUST update the file pointer associated with the **FID** according to the instructions in the [SMB_COM_SEEK Request \(section 2.2.4.19.2\)](#). The new offset is returned in the response. The SMB_COM_SEEK Response message MUST be constructed. If an error was generated by the request, the server MUST send an error response.

The **Offset** field in the [SMB_COM_SEEK \(section 2.2.4.19\)](#) request and response is a 32-bit value. If the CAP_LARGE_FILES capability has been negotiated, then 64-bit offsets are supported. The server MUST return only the lower order 32 bits of the actual 64-bit offset.<271>

The response MUST be sent to the client as specified in section [3.3.4.1](#).

3.3.5.22 Receiving an SMB_COM_LOCK_AND_READ Request

When the server receives an [SMB_COM_LOCK_AND_READ Request \(section 2.2.4.20.1\)](#), if the request is on a named pipe, the server MUST fail the request with an NT status code of STATUS_INVALID_DEVICE_REQUEST (0xC0000010); otherwise, the server MUST treat the request as if it is an [SMB_COM_LOCK_BYTE_RANGE Request \(section 2.2.4.13.1\)](#) followed by an [SMB_COM_READ Request \(section 2.2.4.11.1\)](#). Processing MUST proceed as specified in sections [3.3.5.15](#) and [3.3.5.13](#), with the following exceptions:

- Their triggering requests will be the SMB_COM_LOCK_AND_READ Request of this event.
- If processing results in an error during the process specified in section [3.3.5.15](#), the server MUST construct an SMB_COM_LOCK_AND_READ (section 2.2.4.20.1) error response and MUST NOT continue to the process indicated in section [3.3.5.13](#).
- If processing results in an error during the process specified in section [3.3.5.13](#), the server MUST construct an SMB_COM_LOCK_AND_READ Request error response.

- The server MUST construct an [SMB_COM_LOCK_AND_READ Response \(section 2.2.4.20.2\)](#) instead of the messages indicated in [3.3.5.15](#) and [3.3.5.13](#).
- The response fields MUST be populated with the data that would go in the corresponding fields of both SMB_COM_LOCK_BYTE_RANGE Request (section 2.2.4.13.1) and [SMB_COM_READ Response \(section 2.2.4.11.2\)](#) messages.

An entry for the newly-granted byte-range lock MUST be added to **Server.Open.Locks**. The type of the lock MUST be exclusive, and the entry MUST be formatted with a 32-bit offset (LOCKING_ANDX_RANGE32).<272>

The response MUST be sent to the client as specified in section [3.3.4.1](#).

3.3.5.23 Receiving an SMB_COM_WRITE_AND_UNLOCK Request

The [SMB_COM_WRITE_AND_UNLOCK \(section 2.2.4.21\)](#) command combines the behavior of [SMB_COM_WRITE \(section 2.2.4.12\)](#) with that of [SMB_COM_UNLOCK_BYTE_RANGE \(section 2.2.4.14\)](#). SMB_COM_WRITE_AND_UNLOCK (section 2.2.4.21) is intended to be paired with [SMB_COM_LOCK_AND_READ \(section 2.2.4.20\)](#) to perform record updates to a file.

The **FID** provided in the command request MUST indicate a file held open by the client with, at minimum, write access. The server MUST first perform the write operation and then release the lock. The bytes to be written are passed in the **Data** field of the request, and MUST be written starting at the file position indicated by the **WriteOffsetInBytes** field. Once the data has been successfully written, the server MUST attempt to unlock the byte range specified by **WriteOffsetInBytes** (offset) and **CountOfBytesToWrite** (length).<273>

It is possible that the actual number of bytes available in the request, as indicated by the **DataLength** field, is less than **CountOfBytesToWrite**. If this occurs, the server MUST write **DataLength** bytes from the **Data** field to the file indicated by the FID starting at the position indicated by **WriteOffsetInBytes**. When the byte range is unlocked, however, the full range as specified by **WriteOffsetInBytes** and **CountOfBytesToWrite** MUST be unlocked.

In the event of an error, the server MUST send an error response message. If the write and unlock are successful, the server MUST construct an SMB_COM_WRITE_AND_UNLOCK response message as specified in section [2.2.4.21.2](#). The response MUST be sent to the client as specified in section [3.3.4.1](#). The server MUST remove the matching entry from the **Server.Open.Locks** list.

3.3.5.24 Receiving an SMB_COM_READ_RAW Request

Upon receipt of an [SMB_COM_READ_RAW Request \(section 2.2.4.22.1\)](#) from the client, the server MUST verify that the **Server.Capabilities** include CAP_RAW_MODE, and that **Connection.IsSigningActive** is FALSE (no SMB frame is sent in the response; therefore, this command is not compatible with SMB signing). If those conditions are met, the server MUST also verify the **FID** and the **UID** and MUST verify that the user has, at minimum, read permission on the file, named pipe, or device indicated by the **FID**. If any of these conditions is not met, the server MUST send a zero-length reply over the SMB transport to indicate failure of the request.

The server response to an SMB_COM_READ_RAW request is not a standard SMB response. Instead, the server sends raw data to the client via the underlying transport. The server relies upon the transport to ensure that the data is transferred in sequence; that the entire message is sent contiguously; that transmission errors are detected; and that the number of bytes transferred is reported to the receiving client.

Because there is no [SMB Header \(section 2.2.3.1\)](#) included in the response, there is no mechanism for reporting specific errors. If an error occurs, the server MUST send a zero-length response to the

client via the SMB transport. A zero-length reply can also indicate that the requested offset is at or beyond end of file (EOF) and that no bytes are available to be returned. The client can then use a different SMB command to perform a Read. The alternate Read request either fails, providing the client with an actionable status code, or it succeeds, allowing the client to read the data that it had originally attempted to read.

If the server receives an SMB_COM_READ_RAW request after having sent an OpLock Break Notification to the client and is actively waiting for the client's response to the OpLock Break Notification, the server MUST send a zero-length reply. The server might then re-issue the OpLock Break Notification. This is done because the OpLock Break Notification sent by the server can arrive at the client after the client has issued the SMB_COM_READ_RAW request. In this situation, the client could mistake the OpLock Break Notification request for the Raw Read response. See Receiving Any OpLock Break Notification (section [3.2.5.42](#)) for steps that the client MUST take to handle this situation.

If there are no errors and the **FID** indicates a regular file, processing is as follows:

- The server MUST attempt to read from the underlying object store for the file indicated by the **FID** in the response. It MUST start reading from the file at the offset indicated by the **Offset** field in the request, or by the combination of **Offset** and **OffsetHigh** if CAP_LARGE_FILES was negotiated. The client MUST read **BytesToReturn** bytes or until EOF, whichever comes first. [<274>](#)
- If the offset is at or beyond EOF, the server MUST send a zero-length message to the client via the SMB transport.
- If the client requests to read more bytes than the file contains, or to read beyond EOF, the number of bytes returned by the server message MUST be the number of bytes actually read from the file. A response message containing fewer bytes than were requested from a regular file indicates that EOF was encountered.

If there are no errors, and the **FID** indicates a named pipe or device, the following additional processing applies:

- The offset value is used only if it is relevant to the object from which the data is read.
- If the **Timeout** value is -1 (0xFFFFFFFF, "wait forever") or the server does not implement **Timeout** processing, [<275>](#) the server SHOULD wait until there are at least **MinCountOfBytesToReturn** bytes of data read from the device before returning a response to the client.
- If the **Timeout** value is -2 (0xFFFFFFFFE, "default"), the server SHOULD wait for the default timeout associated with the named pipe or I/O device.
- If the **Timeout** value is zero and no data is currently available, the server SHOULD send a successful response with the **DataLength** field set to zero.
- Otherwise, the server SHOULD wait to send the response until either **MinCountOfBytesToReturn** or more bytes of data become available or the **Timeout** in milliseconds elapses. If **Timeout** elapses before **MinCountOfBytesToReturn** bytes are read, the server SHOULD send a response with an error status indicating that the **Timeout** occurred and SHOULD also respond with any bytes already read.

The server MUST NOT respond as specified in section [3.3.4.1](#). The server MUST add the total number of bytes in the message to the **Server.Statistics.sts0_bytessent_low** and **Server.Statistics.sts0_bytessent_high** abstract data model elements (section [3.3.1.1](#)). The server MUST respond by sending the bytes read to the client via the SMB transport.

3.3.5.25 Receiving an SMB_COM_READ_MPX Request

CIFS permits the use of the [SMB_COM_READ_MPX \(section 2.2.4.23\)](#) command over connectionless transports only. SMB message signing is not supported over connectionless transports.

Upon receiving an [SMB_COM_READ_MPX Request \(section 2.2.4.23.1\)](#), the server MUST validate the **FID** and **UID** to ensure that the client has sufficient privilege to read the file. If no errors occur, the server MUST then attempt to read from the underlying object store for the file indicated by the **FID** of the request. <276>

As is true in SMB_COM_READ, the total number of bytes returned can be less than the number requested only if a read specifies bytes beyond the current file size, and FID refers to a disk file. In this case, the server MUST return only the bytes that exist. A read that begins at or beyond the end of file MUST result in a single response with a zero value in **Count**. If the total number of bytes returned is less than the number of bytes requested, this indicates end of file (if reading other than a standard blocked disk file, only zero bytes returned indicates end of file).

Once started, the Read Block Multiplexed operation MUST run to completion. The client MUST receive all of the responses generated by the server. Conflicting commands (such as file close) MUST NOT be sent to the server while a multiplexed operation is in progress.

Server support of this command is optional. <277>

If the read request was made to a named pipe or I/O device, the following additional rules apply:

- If the **Timeout** value is -1 (0xFFFFFFFF, "wait forever") or the server does not implement **Timeout** processing, <278> the server SHOULD wait until there are at least **MinCountOfBytesToReturn** bytes of data read from the device before returning a response to the client.
- If the **Timeout** value is -2 (0xFFFFFFFFE, "default"), the server SHOULD wait for the default timeout associated with the named pipe or I/O device.
- If the **Timeout** value is zero and no data is currently available, the server SHOULD send a successful response with the **DataLength** field set to zero.
- Otherwise, the server SHOULD wait to send the response until either **MinCountOfBytesToReturn** or more bytes of data become available or the **Timeout** in milliseconds elapses. If **Timeout** elapses before **MinCountOfBytesToReturn** bytes are read, the server SHOULD send a response with an error status indicating that the **Timeout** occurred and SHOULD also respond with any bytes already read.

If an error is detected, the server MUST send a single error response message to the client. Otherwise, the server MUST respond to the request with one or more SMB_COM_READ_MPX response messages (constructed as specified in section [2.2.4.23.2](#)) until the requested amount of data has been returned or an error occurs. Each server response MUST contain the **PID** and **MID** of the original client request, as well as the **Offset** and **Count** describing the returned data. The client has received all of the data bytes when the sum of the **DataLength** fields received in each response equals the total amount of data bytes expected (smallest **Count** received). This allows the protocol to work even if the responses are received out of sequence.

The response MUST be sent to the client as described in section [3.3.4.1](#), with the exception that SMB signing and connectionless protocols are mutually exclusive.

3.3.5.26 Receiving an SMB_COM_WRITE_RAW Request

Upon receipt of an [SMB_COM_WRITE_RAW Request \(section 2.2.4.25.1\)](#) from the client, the server MUST verify that the **Server.Capabilities** include CAP_RAW_MODE, and that **Connection.IsSigningActive** is FALSE. If those conditions are met, the server MUST also verify the following:

- FID MUST be valid.
- **UID** MUST be valid, and the user MUST have, at minimum, write permission on the file, named pipe, or device indicated by the FID.
- **DataLength** MUST be less than or equal to **CountOfBytes**.
- The number of bytes provided in the **SMB_Data.Bytes.Data** field MUST be equal to **DataLength**.

If an error is detected when verifying any of the fields listed above (or when performing any other basic validation of the message), the Write Raw operation MUST fail and the server MUST return a Final Server Response, as described in section [2.2.4.25.3](#), with the **Count** field set to zero (0x0000).

If the **DataOffset** field value is less than the offset of **SMB_Data.Bytes.Data**, or if the **DataOffset** field value is greater than the offset of the **SMB_Data.Bytes.Data** + **SMB_Parameters.Words.DataLength**, the server SHOULD [<279>](#) fail the request with STATUS_INVALID_SMB.

If the server has no resources available to process the Raw Mode portion of the command (implementation-dependent), the server MUST fail the command. The server can first write the initial data provided in the request. Whether or not the initial data is written, the server MUST return a Final Server Response message with a **Status** of STATUS_SMB_USE_STANDARD (ERRSRV/ERRusestd) and a **Count** set to the number of bytes written, which can be zero (0x0000). [<280>](#)

If the write request was made to a named pipe or I/O device, the following additional rules apply:

- If the **Timeout** value is -1 (0xFFFFFFFF, "wait forever") or the server does not implement **Timeout** processing, [<281>](#) then the server SHOULD wait until **DataLength** bytes have been written to the device before returning a response to the client.
- If the **Timeout** value is -2 (0xFFFFFFFFE, "default") the server SHOULD wait for the default time-out associated with the named pipe or I/O device.
- If the **Timeout** value is zero, the write SHOULD NOT block.
- Otherwise, the server SHOULD wait to send the response until either **DataLength** bytes are written to the device or the **Timeout** in milliseconds elapses. If **Timeout** is greater than zero and it elapses before **DataLength** bytes are written, the server SHOULD send a response with an error status indicating that the time-out occurred and SHOULD also include the count of bytes written.

If validation of the request is successful, and there are sufficient resources available to process the request, the server MUST attempt to write the initial data provided in the SMB_COM_WRITE_RAW request.

If the initial write operation succeeds and there is no additional data to be sent (**CountOfBytes** and **DataLength** are equal in the request), the server MUST send a Final Server Response indicating

success, with the **Count** field set to the number of bytes that were written (the same as **CountOfBytes** and **DataLength**).<282>

If the initial write operation succeeds and additional data is pending (**CountOfBytes** greater than **DataLength**), the server MUST send an Interim Server Response as shown in section [2.2.4.25.2](#). If, however, the initial write operation fails, the server MUST return a Final Server Response. The Final Server Response MUST return a **Status** value indicating the cause of the error and a **Count** field set to the number of bytes successfully written. If the Interim Server Response was sent, the client MUST send any additional data in Raw Mode (meaning, the data to be written to the file MUST be written directly to the SMB transport for delivery to the server). The server MUST forward the raw data to the file, named pipe, or device indicated by the FID. The client can send less than the number of bytes expected (**CountOfBytes** minus **DataLength**). In that case, the server MUST write only the data sent. The client MUST NOT send more bytes than expected in Raw Mode.

As described above, if an error is detected prior to sending the Interim Server Response, then a Final Server Response MUST be sent to indicate the error and provide the count of the number of bytes successfully written. Once the Interim Server Response has been sent, the setting of the **WritethroughMode** bit in the **WriteMode** field of the original request determines whether or not a Final Server Response is sent to complete the Write Raw operation.

- If **WritethroughMode** is set, a Final Server Response is expected following the transfer of raw data from the client. The server MUST complete writing the raw data to its final destination (file, named pipe, or device) and then MUST return the Final Server Response, indicating any errors as well as the total number of bytes written.
- If **WritethroughMode** is clear, the server can perform write-behind. The Final Server Response MUST NOT be sent, even if an error occurs. The server MUST store the error and return it on the next access to the FID. When the client has completed sending the raw write data, it can continue normal operation.

Raw mode transfers are not supported on connectionless transports.

The interim and final response messages MUST be sent to the client as described in section [3.3.4.1](#), with the exception that SMB signing is not supported for raw mode commands.

3.3.5.27 Receiving an SMB_COM_WRITE_MPX Request

Upon receipt of an [SMB_COM_WRITE_MPX Request \(section 2.2.4.26.1\)](#), the server MUST validate the following fields:

- **TID**: The tree ID MUST indicate a connected disk share.
- **UID**: The user ID MUST indicate an active SMB session. The **UID** MUST be listed in **Server.Connection.SessionTable**.
- **CID**: The SMB transport MUST be connectionless, and the Connection ID field MUST be valid for the transport.
- **PID** and **MID**: These are used to identify a single Write MPX operation that can consist of multiple Write MPX request messages.
- **SequenceNumber**: This field MUST be zero for all but the final Write MPX request sent in the operation. The requests can arrive in any order.
- **SMB_Parameters.Words.FID**: Indicates the file to which the transmitted data is to be written. The **FID** MUST represent a regular file or a printer spool file.

The **TID**, **UID**, **PID**, **MID**, and **CID** values MUST be the same for all [SMB_COM_WRITE_MPX \(section 2.2.4.26\)](#) messages sent as part of the same operation. The **FID** MUST be the same for all SMB_COM_WRITE_MPX Request messages sent as part of the same operation.

The server MUST rely on the SMB transport to determine whether each client request was successfully received. If the transport indicates an error on the receipt of the request, the request MUST be discarded. If this SMB command request is received over a connection-oriented transport, the server MUST respond immediately with an error response; the error code MUST be STATUS_SMB_USE_STANDARD (ERRSRV/ERRusestd).

When the server receives the first SMB_COM_WRITE_MPX in a Write MPX exchange, it MUST initialize the **Server.Open.MpxMask** that it returns to the client to zero (0x00000000).

For each request received as part of the SMB_COM_WRITE_MPX operation, the server MUST attempt to write the data in the **SMB_Data.Bytes.Buffer** field to the file indicated by **FID** at the location indicated by **SMB_Parameters.Words.ByteOffsetToBeginWrite**. If the write is successful, the **Server.Open.MpxMask** is updated by performing a bitwise OR with the **RequestMask** in the request. The result is stored in **Server.Open.MpxMask**:

Server.Open.MpxMask |= **RequestMask**

When the server receives an SMB_COM_WRITE_MPX request that has a nonzero **SequenceNumber** in the [SMB Header \(section 2.2.3.1\)](#), the server takes one of two actions:

- If **WritethroughMode** is set, the server writes all of the accumulated data and ensures (if possible) that the data is flushed to disk. **ResponseMask** MUST be set to **Server.Open.MpxMask**. The server then returns the [SMB_COM_WRITE_MPX Response \(section 2.2.4.26.2\)](#). The **ResponseMask** indicates the set of SMB_COM_WRITE_MPX messages in this exchange that were received by the server.
- If **WritethroughMode** is clear, the server responds immediately and sets **ResponseMask** as **Server.Open.MpxMask**; write operations that are in-progress complete asynchronously.

The client MUST resend any SMB_COM_WRITE_MPX requests that were not indicated as having been received in the **ResponseMask**. The last message resent MUST have the same nonzero **SequenceNumber** in the SMB Header as was previously used in this exchange. The server, once again, responds with an SMB_COM_WRITE_MPX Response containing the cumulative **ResponseMask**. This process continues until all request messages in the exchange have been acknowledged.

The SMB_COM_WRITE_MPX Response messages MUST be sent to the client as specified in section [3.3.4.1](#), with the exception that SMB signing is not supported over connectionless transports.

3.3.5.28 Receiving an SMB_COM_QUERY_INFORMATION2 Request

Upon receiving an [SMB_COM_QUERY_INFORMATION2 Request \(section 2.2.4.31.1\)](#) from the client, the server MUST validate the **FID** provided by looking up the **FID** in **Server.Connection.FileOpenTable**. The **FID** MUST indicate a regular file. If an error occurs, an error response message MUST be generated. If an open is found and **Open.GrantedAccess** does not include FILE_READ_ATTRIBUTES access, the server MUST send an error response with a status of STATUS_ACCESS_DENIED (ERRDOS/ERRnoaccess) and MUST increase **Server.Statistics.sts0_permerrors** by 1. If the **UID** presented is different from the **UID** that opened the file, the server MUST send the error response with a **Status** of STATUS_INVALID_HANDLE (ERRDOS/ERRbaduid). Otherwise, the server MUST obtain the required attribute information, as listed in section [2.2.4.31.2](#). The SMB_COM_QUERY_INFORMATION2

response MUST be formatted as described in that section, and the response messages MUST be sent to the client as specified in section [3.3.4.1.<283>](#)

3.3.5.29 Receiving an SMB_COM_SET_INFORMATION2 Request

Upon receiving an [SMB_COM_SET_INFORMATION2 Request \(section 2.2.4.30.1\)](#), the server MUST validate the FID by looking up the FID in **Server.Connection.FileOpenTable**, which MUST indicate a regular file. The **UID** MUST be used to find the **Server.Session.UserSecurityContext**, which MUST have sufficient privilege to set file attribute information. If the user does not have sufficient privileges, the server MUST send an error response with a status of STATUS_ACCESS_DENIED (ERRDOS/ERRnoaccess) and MUST increase **Server.Statistics.sts0_permerrors** by 1. If the UID presented is different from the UID that opened the file, the server MUST send the error response with a **Status** of STATUS_INVALID_HANDLE (ERRDOS/ERRbaduid).

For each nonzero attribute in the request, the server MUST attempt to set the attribute on the file indicated by the FID. If an error is detected, the **Status** field of the response MUST be set to the error; otherwise, **Status** MUST be set to success. The response messages MUST be sent to the client as described in section [3.3.4.1.<284>](#)

3.3.5.30 Receiving an SMB_COM_LOCKING_ANDX Request

Upon receiving an [SMB_COM_LOCKING_ANDX Request \(section 2.2.4.32.1\)](#), the server MUST validate the **FID** and **PID** by finding a matching **Server.Open** entry in the **Server.Connection.FileOpenTable** and a **Server.SMBRequest** entry in the **Server.Connection.PendingRequestsTable**, respectively.

SMB_COM_LOCKING_ANDX Request is processed in three parts, all of which are executed:

1. If **NumberOfRequestedUnlocks** is nonzero, the **Unlocks** array contains **NumberOfRequestedUnlocks** entries. Each entry requests that a lock be released. [<285>](#)
2. If **NumberOfRequestedLocks** is nonzero, the **Locks** array contains **NumberOfRequestedLocks** entries. Each entry requests the acquisition of a lock. [<286>](#)
3. If the OPLOCK_RELEASE flag is set in the **TypeOfLock** field of the request, the request is an OpLock Break Request sent by the client in response to an OpLock Break Notification from the server. The server MUST release the OpLock on the **Open**, after which it MUST allow pending operations that were waiting for the OpLock release to proceed, in an implementation-specific fashion. [<287>](#) The server MUST set **Server.Open.Oplock** to **NONE** and MUST set **Server.Open.OplockState** to **NONE**.

The release or creation of a byte-range lock MUST follow these rules:

- Overlapping locks are not allowed.
- Offsets beyond the current end of file can be locked; the server MUST NOT allocate additional file space as a result of such locks.
- The server MUST NOT allow a range to be unlocked by any **PID** other than the **PID** that performed the lock. If the **PID** in the unlock request does not match **Server.Open.Lock** in the **Open**, the server MUST send an error response message with status set to STATUS_RANGE_NOT_LOCKED (ERRDOS/ERROR_NOT_LOCKED). See [\[FSBO\]](#) section 3 for details of byte range lock semantics.
- All locks are held based upon the **FID** used to create the lock. That is, any process (**PID**) using the **FID** specified in the creation of the lock has access to the locked bytes. If the lock is an

exclusive lock, other **FIDs** indicating a separate **Open** of the same file **MUST** be denied access to the same bytes. If the lock is a shared read lock, other **FIDs** indicating a separate **Open** of the same file **MUST** be denied write access to the same bytes.

The release of an OpLock follows these rules:

- If there are no outstanding OpLock breaks, or if the FID in the request does not match the FID of an outstanding OpLock Break Notification, then no OpLock is released. This does not generate an error.
- If **NumberOfRequestedUnlocks** and **NumberOfRequestedLocks** are both zero (0x0000) in the SMB_COM_LOCKING_ANDX Request, the server **MUST NOT** send an [SMB_COM_LOCKING_ANDX Response \(section 2.2.4.32.2\)](#).
- Note that **NumberOfRequestedUnlocks** **SHOULD** always be zero (0x0000) in an OpLock Break Request, because an OpLock is an exclusive file lock. A client holding an OpLock on a file has no need to request byte-range locks from the server. There **SHOULD**, therefore, be no existing byte-range locks to be unlocked by the OpLock Break Request message. No error is generated by a nonzero **NumberOfRequestedUnlocks** value in an OpLock Break Request. [<288><289>](#)

Locking a range of bytes **MUST** fail with STATUS_LOCK_NOT_GRANTED(ERRDOS/ERRlock) if any subranges or overlapping ranges are locked, even if they are currently locked by the **PID** requesting the new lock.

This client request is atomic. If any of the lock ranges times out because the area to be locked is already locked, or the lock/unlock request otherwise fails, the lock state of the file **MUST NOT** be changed.

The server response indicates only success or failure. If failure, the response message is an error response, including the status code indicating the cause of the failure. The response messages **MUST** be sent to the client as specified in section [3.3.4.1](#).

For each byte-range lock that is granted, an entry **MUST** be added to **Server.Open.Locks**. The type of the lock **MUST** match the type indicated in the **TypeOfLock** field. If the LARGE_FILES bit of the **TypeOfLock** field is set, the entry **MUST** be formatted as a LOCKING_ANDX_RANGE64; otherwise, it **MUST** be formatted as a LOCKING_ANDX_RANGE32.

For each byte-range lock that is released, the corresponding entry in **Server.Open.Locks** **MUST** be removed.

3.3.5.31 Receiving an SMB_COM_TRANSACTION Request

The SMB_COM_TRANSACTION is processed as specified in sections [3.3.5.2.5](#) and [3.3.5.57](#). Additionally, the server **MUST** validate the contents of the **SMB_DATA.Bytes.Name** field. The subcommand transported by the transaction is interpreted based upon the object receiving the message.

3.3.5.32 Receiving an SMB_COM_IOCTL Request

Upon receipt of an SMB_COM_IOCTL request, the server **MUST** verify that the FID is valid (by locating an **Open** with a matching **Open.FID** in the **Server.Connection.FileOpenTable**). The **UID** **MUST** indicate a **Server.Session.UserSecurityContext** with sufficient permission to perform the IOCTL. The IOCTL request **MUST** be unpacked as specified in section [2.2.4.35.1](#), and the server **MUST** call the IOCTL function indicated by the **Category** and **Function** fields in the request. [<290>](#)

If the IOCTL is successful, the server MUST construct an SMB_COM_IOCTL response message as specified in section [2.2.4.35.2](#). The response MUST be sent to the client as specified in section [3.3.4.1](#).

3.3.5.33 Receiving an SMB_COM_ECHO Request

When the server receives an [SMB_COM_ECHO Request \(section 2.2.4.39.1\)](#), message handling proceeds as follows:

The value of the **TID** field MUST be either a valid **TID** (see section [3.3.5.2](#)) or 0xFFFF.<291>

If **EchoCount** is zero, a response MUST NOT be sent. If **EchoCount** is nonzero, the server SHOULD reply with the requested number of responses. The server MAY enforce any nonzero limit in the number of responses that it returns.

The server MUST construct an SMB_COM_ECHO response message as specified in section [2.2.4.39](#) and initialize it as follows:

- The **SMB_Parameters.Words.SequenceNumber** field MUST be set to 1.
- The **SMB_Data.Bytes.Data** field MUST be the same as that received in the request.

While **SMB_Parameters.Words.SequenceNumber** is less than or equal to **EchoCount**:

- The response MUST be sent to the client as described in section [3.3.4.1](#).
- The **SMB_Parameters.Words.SequenceNumber** field MUST be incremented.

Note that **SMB_Parameters.Words.SequenceNumber** is not the signing sequence number. If signing is enabled, each outgoing Echo response message is signed individually. The same signing sequence number, provided by the **Server.Connection.ServerSendSequenceNumber** table, is used for all Echo response messages to the same Echo request.

If the server receives an [SMB_COM_NT_CANCEL Request \(section 2.2.4.65.1\)](#) that matches the SMB_COM_ECHO (section 2.2.4.39) during Processing of the Echo, the Echo operation is canceled and no further responses are sent.

3.3.5.34 Receiving an SMB_COM_WRITE_AND_CLOSE Request

Upon receipt of an [SMB_COM_WRITE_AND_CLOSE Request \(section 2.2.4.40.1\)](#), the server MUST perform the following actions:

- The server MUST verify the **FID**, which MUST represent an open regular file.
- The server MUST verify the **UID** as described in section [3.3.5.2](#) and ensure that the user has permission to write to the file. If the user does not have permission to write to the file, the server MUST send an error response with a status of STATUS_ACCESS_DENIED (ERRDOS/ERRnoaccess) and MUST increase **Server.Statistics.sts0_permerrors** by 1.
- If the **UID** presented is different from the **UID** that opened the file, the server MUST send the error response with a **Status** of STATUS_INVALID_HANDLE (ERRDOS/ERRbaduid).
- In the file identified by the **FID**, the server MUST perform a seek to the offset specified in the **WriteOffsetInBytes** field in the request.

- The server MUST write **CountOfBytesToWrite** bytes sequentially from the **Data** field in the request to the file. Any failure that causes less than **CountOfBytesToWrite** bytes to be written SHOULD result in an error response to the client.
- If the **LastWriteTime** field is nonzero in the request, the server SHOULD set the last write time of the file to this value.

In the event of an error, the server MUST send an error response message. Otherwise, the server MUST close the file indicated by the **FID**. The server MUST release every lock in **Open.Locks**. The **FID** MUST be invalidated by removing the **Open** entry from **Server.Connection.FileOpenTable**. **Open.TreeConnect.OpenCount** and **Server.Statistics.sts0_fopens** MUST be decreased by 1. [<292>](#) The server MUST provide **Open.FileGlobalId** as an input parameter and MUST deregister the **Open** by invoking the event Server Deregisters an Open ([\[MS-SRVS\]](#) section 3.1.6.5).

Again, an error MUST result in an error response message being sent to the client. Otherwise, the server MUST construct an [SMB_COM_WRITE_AND_CLOSE Response \(section 2.2.4.40.2\)](#) message. The **CountOfBytesWritten** field MUST contain the number of bytes written to the file. This value SHOULD be the equal to **CountOfBytesToWrite**. If the number of bytes written differs from the number of bytes requested to be written, and no error is indicated, the server has no resources available with which to satisfy the complete write. The response MUST be sent to the client as specified in section [3.3.4.1](#).

3.3.5.35 Receiving an SMB_COM_OPEN_ANDX Request

Upon receipt of an [SMB_COM_OPEN_ANDX Request \(section 2.2.4.41.1\)](#), the server MUST validate the **TID** and **UID**, as defined in section [3.3.5.2](#).

If the **ShareType** property of the **Server.Share** specified by the **SMB_Header.TID** is equal to **Named Pipe** and if **Server.Session.IsAnonymous** is TRUE, the server MUST invoke the event specified in [\[MS-SRVS\]](#) section 3.1.6.17 by providing the **SMB_Parameters.Words.FileName** field with the "\\PIPE\" prefix removed as input parameter. If the event returns FALSE, indicating that no matching named pipe is found that allows an anonymous user, the server MUST fail the request with STATUS_ACCESS_DENIED and MUST increase **Server.Statistics.sts0_permerrors** by 1. Otherwise, the server MUST continue the open processing.

The server MUST search within the share indicated by the **Server.Share** identified by the **SMB_Header.TID** for an object with matching **SMB_Parameters.Words.FileName**. [<293>](#)

If a matching file is found and:

- The user indicated by the **Server.Session.UserSecurityContext** identified by **UID** has sufficient privileges to open the file with **AccessMode** access;
- The file is not currently open in a conflicting mode, and:
 - The FileExistsOpts flag in the **OpenMode** field is 0, the server SHOULD fail the request with error code STATUS_OBJECT_NAME_COLLISION.
 - The FileExistsOpts flag is 1, the server permits opening the file in append mode.
 - The FileExistsOpts flag is 2, the server permits overwriting the file.

If no matching file is found, but:

- **Server.Share** represents a disk share;

- **Server.Session.UserSecurityContext** has sufficient privileges to create and open the file with **AccessMode** access;
- The CreateFile flag in the **OpenMode** field is 0, the server SHOULD [<294>](#) fail the file creation and return STATUS_OS2_INVALID_ACCESS (ERRDOS/ERRbadaccess).
- The CreateFile flag in the **OpenMode** field is 1, the server permits file creation.

The server MUST attempt to create the file with the attributes specified in **FileAttrs**. If **CreationTime** is nonzero, then the creation time of the file MUST be set to the value of **CreationTime**.

If the underlying object store returns STATUS_ACCESS_DENIED, the server MUST increase **Server.Statistics.sts0_permerrors** by 1.

If the file cannot be opened, the server MUST return an error response. [<295>](#)

If the command is successful, the server MUST increase **Server.Statistics.sts0_fopens** by 1 and MUST allocate an **Open** object and insert it into **Server.Connection.FileOpenTable** with the following default values:

- A new FID MUST be created to uniquely identify this **Open** in **Server.Connection.FileOpenTable**.
- If **Server.EnableOplock** is TRUE and a requested OpLock was granted, the type of OpLock MUST be set in **Server.Open.OpLock** and **Server.Open.OplockState** MUST be set to **Held**; otherwise, **Server.Open.OpLock** MUST be set to **None** and **Server.Open.OplockState** MUST be set to **None**.
- **Server.Open.TreeConnect** MUST be set to the **TreeConnect** on which the open request was performed, and **Server.Open.TreeConnect.OpenCount** MUST be increased by 1.
- **Server.Open.Session** MUST be set to **Server.Open.TreeConnect.Session**.
- **Server.Open.Connection** MUST be set to the **Server.Open.Session.Connection**.
- **Server.Open.Locks** MUST be set to an empty list.
- **Server.Open.PID** MUST be set to the **PID** provided in the request.
- **Server.Open.PathName** MUST be set to the **FileName** field of the request.
- **Server.Open.GrantedAccess** MUST be set to the **AccessMode** field of the request.

The server MUST register the **Open** by invoking the event Server Registers a New Open ([\[MS-SRVS\]](#) section 3.1.6.4) and MUST assign the return value to **Server.Open.FileGlobalId**.

The server MUST instantiate an [SMB_COM_OPEN_ANDX Response \(section 2.2.4.41.2\)](#) message and MUST set **SMB_Header.Status** to indicate success. [<296>](#)

If the REQ_ATTRIB flag is set in the **SMB_Parameters.Words.Flags** field of the request, the values of the following response fields MUST be filled in by the server; otherwise, they SHOULD be set to zero and MUST be ignored by the client:

- **FileAttrs**
- **LastWriteTime**

- **FileDataSize**
- **AccessRights**
- **ResourceType**
- **NMPipeStatus**
- **OpenResults**

If the REQ_OPLOCK flag is set in the **SMB_Parameters.Words.Flags** field of the request, the client requests an exclusive OpLock. If REQ_OPLOCK_BATCH is also set, the client requests a batch OpLock. If the OpLock is granted, the **LockStatus** bit in the **OpenResults** field of the response MUST be set.

The response MUST be sent to the client as specified in section [3.3.4.1](#).

3.3.5.36 Receiving an SMB_COM_READ_ANDX Request

When a server receives an SMB_COM_READ_ANDX request, message handling proceeds as follows:

The server MUST verify that the FID represents a valid **Server.Open** (has an entry in the SMB connection's **Server.Connection.FileOpenTable**). If the **FID** is not valid, the server MUST return an error response with a status of STATUS_INVALID_HANDLE (ERRDOS/ERRbadfid).

The server MUST verify that the user represented by the **UID** in the request has permission to read from the file as described in section [3.3.5.2](#). If the user does not have sufficient permissions, the server MUST send an error response with a status of STATUS_ACCESS_DENIED (ERRDOS/ERRnoaccess) and MUST increase **Server.Statistics.sts0_permerrors** by 1. If the UID that is presented is different from the UID that opened the file, the server MUST send the error response with a **Status** of STATUS_INVALID_HANDLE (ERRDOS/ERRbaduid).

The server MUST attempt to read from the underlying object store for the **Server.Open** identified by the **FID** in the request. The server MUST start reading at the offset indicated by either the 32-bit offset in **Offset** or the 64-bit offset formed by combining **OffsetHigh** and **Offset**. If **WordCount** is 10 (0x0A), the client is using 32-bit offsets; if it is 12 (0x0C), the client is using 64-bit offsets.

The server MUST attempt to read **MaxCountOfBytesToReturn** number of bytes from the file. [<297>](#)

The server might read fewer than **MaxCountOfBytesToReturn** bytes if an end of file (EOF) event is encountered. A read request starting at or beyond the end of the file returns zero bytes.

If reading the requested number of bytes would lead to a response message size larger than the established **Server.Connection.ClientMaxBufferSize** and **Server.Connection.ClientCapabilities** does not have CAP_LARGE_READX set, the server MUST abort the connection to the client. If **Server.Connection.ClientCapabilities** has CAP_LARGE_READX set, the response message can exceed the negotiated buffer size if the FID refers to a disk file.

If the read request was made to a named pipe or I/O device, the following additional rules apply:

- The server MUST NOT read a number of bytes from named pipes or I/O devices greater than can be transmitted in a message less than or equal to **Server.Connection.ClientMaxBufferSize** in size, even if CAP_LARGE_READX was negotiated.

- The server MUST wait to send a response until **MinCountOfBytesToReturn** are read from the named pipe or I/O device.
- If **Timeout** is greater than zero, the server SHOULD [<298>](#) wait to send the response until either **MinCountOfBytesToReturn** are read or the **Timeout** (in milliseconds) elapses. If **Timeout** is greater than zero and it elapses before **MinCountOfBytesToReturn** bytes are read, the server SHOULD send a response with an error status indicating that the time-out occurred and SHOULD also respond with any bytes already read. If **Timeout** is zero and no data is currently available, the server SHOULD send a successful response with the **DataLength** field set to zero.
- If the **Timeout** value is -1 (0xFFFFFFFF, "wait forever") then the server MUST wait until there are at least **MinCountOfBytesToReturn** bytes of data read from the device before returning a response to the client.
- If the **Timeout** value is -2 (0xFFFFFFF, "default") the server MUST wait for the default time-out associated with the named pipe or I/O device.

If the operation is successful, the server MUST construct an [SMB_COM_READ_ANDX Response \(section 2.2.4.42.2\)](#) message with the following additional requirements:

- If the request was to a named pipe, **Available** MUST be set to the number of bytes remaining to be read from the named pipe, which can be zero. Otherwise, the server MUST set the **Available** field to -1(0xFFFF).
- The **DataLength** field MUST be set to the length, in bytes, of the data read by the server.
- The **DataOffset** field MUST be set to the offset, in bytes and relative to the start of the [SMB Header \(section 2.2.3.1\)](#), of the data read by the server.
- The **Pad** field MUST pad the **SMB_Data.Data** field to an appropriate boundary.
- The **Data** field MUST contain the data that was read from the requested file.

If the request is to read from a named pipe in message mode, and the message is larger than **MaxCountOfBytesToReturn** bytes, the server MUST respond with a complete SMB_COM_READ_ANDX response (not an error response) and the **Status** field of the response MUST contain STATUS_BUFFER_OVERFLOW (ERRDOS/ERRmoredata). Any other error MUST generate an error response message.

The response MUST be sent to the client as described in section [3.3.4.1](#).

3.3.5.37 Receiving an SMB_COM_WRITE_ANDX Request

When the server receives an [SMB_COM_WRITE_ANDX Request \(section 2.2.4.43.1\)](#), message handling proceeds as follows.

The server MUST verify that the **FID** field represents a valid **Open** (has an entry in the SMB connection's **Server.Connection.FileOpenTable**).

The server MUST verify the UID as described in section [3.3.5.2](#), and ensure that the user has permission to write to the file. If the user does not have permission to write to the file, the server MUST send an error response with a **Status** of STATUS_ACCESS_DENIED (ERRDOS/ERRnoaccess) and MUST increase **Server.Statistics.sts0_permerrors** by 1.

If the UID that is presented is different from the UID that opened the file, the server MUST send the error response with a **Status** of STATUS_INVALID_HANDLE (ERRDOS/ERRbaduid).

The server MUST attempt to write the data received in the request to the specified file at the offset indicated in the request. If **WordCount** is 12 (0x0C), the server MUST use the offset in the 32-bit **Offset** field. If **WordCount** is 14 (0x0E), the server MUST use the 64-bit offset formed by combining **OffsetHigh** and **Offset**.

If the **DataOffset** field value is less than the offset of the **SMB_Data.Bytes.Data** field, or if the **DataOffset** field value is greater than the offset of **SMB_Data.Bytes.Data** + **SMB_Parameters.Words.DataLength**, the server SHOULD [<299>](#) fail the request with STATUS_INVALID_SMB.

A write request starting at or beyond the end of the file appends to the end of the file. Any "gaps" caused by writing past the end of file MUST be filled with null (0x00) padding bytes. A request to write zero bytes causes no change to the target file and MUST return a success. If the size of the **SMB_Data.Bytes.Data** field is greater than the value of the **SMB_Parameters.Words.DataLength** field, the server SHOULD [<300>](#) fail the request and return ERRSRV/ERRerror.

If the client has set **WritethroughMode** in **WriteMode**, all written data MUST be flushed to disk before the response is sent.

If the write request is made to a named pipe or I/O device, the following additional rules apply:

- If **Timeout** is greater than zero, the server SHOULD [<301>](#) wait to send the response until either the number of bytes specified by **DataLength** are written to the device or the **Timeout** in milliseconds elapses. If **Timeout** is greater than zero and it elapses before the number of **DataLength** bytes are written, the server SHOULD send a response with an error status indicating that the time-out occurred and MUST also include the count of bytes written. This is not a normal error response; it uses the full SMB_COM_WRITE_ANDX response format. If **Timeout** is zero, the write SHOULD NOT block.
- If the **Timeout** value is -1 (0xFFFF, "wait forever"), the server SHOULD wait until the number of **DataLength** bytes have been written to the device before returning a response to the client.
- If the **Timeout** value is -2 (0xFFFE, "default"), the server SHOULD wait for the default time-out associated with the name pipes or I/O device.
- If the **Remaining** field is nonzero, and the pipe is a message mode pipe, it indicates that the pipe write spans over multiple requests. The **Remaining** field SHOULD contain the number of bytes remaining to be written. [<302>](#)

If the operation is successful, the server MUST construct an SMB_COM_WRITE_ANDX Response message as specified in section [2.2.4.43.2](#), with the following additional requirements:

- If the request is to a named pipe or an I/O device and **ReadBytesAvailable** is set in the **WriteMode** field, **Available** MUST be set to the number of bytes available to be read from the named pipe or device, which MAY be zero.
- The **Count** field MUST be set to the count, in bytes, of data written. [<303>](#)

The response MUST be sent to the client as specified in section [3.3.4.1](#).

3.3.5.38 Receiving an SMB_COM_TRANSACTION2 Request

The SMB_COM_TRANSACTION2 is processed as specified in sections [3.3.5.2.5](#) and [3.3.5.58](#).

The response MUST be sent to the client as specified in section [3.3.4.1](#).

3.3.5.39 Receiving an SMB_COM_FIND_CLOSE2 Request

The SMB_COM_FIND_CLOSE2 command is used to close a directory search handle that was created by a TRANS2_FIND_FIRST2 subcommand. Upon receipt, the server MUST verify the **UID** by performing a lookup in the **Server.Connection.SessionTable**, as described in section 3.3.5.2. The server must then locate the Search ID (**SID**) indicated by the **SearchHandle** field in the request in the **Server.Connection.SearchOpenTable**. If the **SID** is not found, the server MUST return an error response with a **Status** of STATUS_INVALID_HANDLE (ERRDOS/ERRbadfid). Otherwise, the **SID** MUST be closed, freeing the associated search context, if any. The **SID** entry MUST then be removed from Server.Connection.SearchOpenTable.

The response MUST be sent to the client as specified in section 3.3.4.1.

3.3.5.40 Receiving an SMB_COM_TREE_CONNECT Request

When the server receives an [SMB_COM_TREE_CONNECT Request \(section 2.2.4.50.1\)](#), it MUST attempt to connect to the share indicated in the **Path** field. To get the updated server name, the server MUST provide <server name, share name> parsed from the **Path** field and MUST invoke the Server Normalizes a ServerName event ([\[MS-SRVS\]](#) section 3.1.6.8). The server MUST use <updated server name, share name> to look up the **Share** in **Server.ShareTable**. If the share is not found, the server MUST send an error response with a status of STATUS_OBJECT_PATH_NOT_FOUND (ERRDOS/ERRbadpath).

Server.Paused with a value of TRUE indicates that all shares can only be accessed by an administrator. Under these conditions, if a SMB_COM_TREE_CONNECT Request (section 2.2.4.50.1) is received from a user that is not an administrator, the server MUST send an error response with a status of STATUS_SHARING_PAUSED (ERRDOS/ERRpaused).<304>

If the server global variable **Server.ShareLevelAuthentication** is FALSE, the **Password** field in the request MUST be ignored, and the **UID** in the header MUST be used to look up the **Server.Session.UserSecurityContext** to determine access rights to the share.

If **Server.ShareLevelAuthentication** is TRUE, the **Password** field MUST be passed to the Authentication subsystem as a share-level password.

The server MUST invoke the Server Notifies Current Uses of a Share ([\[MS-SRVS\]](#) section 3.1.6.15) event with the tuple <**ServerName, ShareName**> to get the total number of current uses of the share. If the number of current uses is equal to or greater than **Share.MaxUses**, the server MUST fail the request with STATUS_REQUEST_NOT_ACCEPTED.

The server MUST check the validity of the **SMB_Data.Bytes.Service** field in the request. If the value does not match any of those listed in section [2.2.4.50.1](#), the server MUST fail the request with a value of STATUS_BAD_DEVICE_TYPE (ERRSRV/ERRindevice).

If the Tree Connect is successful, the server MUST allocate a **TreeConnect** object and MUST insert it into **Server.Connection.TreeConnectTable** with the following default values:

- A new **TID** MUST be generated to uniquely identify this tree connect in the **Server.Connection.TreeConnectTable**.
- **Session** MUST be set to the session found on the **UID** lookup.
- **Share** MUST be set to the share found on the lookup in the **Server.ShareTable**.
- **OpenCount** MUST be set to zero.
- **CreationTime** MUST be set to current time.

- **Share.CurrentUses** MUST be increased by 1.

The server MUST register **TreeConnect** by invoking the event Server Registers a New Treeconnect ([\[MS-SRVS\]](#) section 3.1.6.6) and MUST assign the return value to **Server.TreeConnect.TreeGlobalId**.

The **TID** MUST be returned in both the **SMB Header.TID** field and the **SMB_Parameter.Words.TID** field of the response. The default **Server.MaxBufferSize** of the server MUST be returned in the **MaxBufferSize** field.

The [SMB_COM_TREE_CONNECT Response \(section 2.2.4.50.2\)](#) provides no field for indicating share characteristics such as DFS support or access rights.

If the Tree Connect is successful, a complete SMB_COM_TREE_CONNECT Response is sent. Otherwise, an error response message MUST be sent.

The response is sent to the client as specified in section [3.3.4.1](#).

3.3.5.41 Receiving an SMB_COM_TREE_DISCONNECT Request

When the server receives an [SMB_COM_TREE_DISCONNECT Request](#), the server can verify that the user indicated by the **Server.Session.UserSecurityContext** identified by **UID** has sufficient privileges, and it MUST:

- Validate the **TID** in the [SMB Header \(section 2.2.3.1\)](#) by verifying that it is listed in **Server.Connection.TreeConnectTable**.
- List all **Opens** (by **FID**) in the **Server.Connection.FileOpenTable** that exist within the **TID**. For each file:
 - Release every lock in **Open.Locks**.
 - Close the file, regardless of the OpLock states.
 - Remove the **Open** entry from the **Server.Connection.FileOpenTable**.
 - Decrease **Open.TreeConnect.OpenCount** and **Server.Statistics.sts0_fopens** by 1.
 - Deregister the **Open** by invoking the event Server Deregisters an Open ([\[MS-SRVS\]](#) section 3.1.6.5), providing **Open.FileGlobalId** as an input parameter.
- List all open searches (by **SID**) in the **Server.Connection.SearchOpenTable** that were opened within the specified **TID**. For each search:
 - Close the search.
 - Remove the **SID** from the **Server.Connection.SearchOpenTable**.
 - **Server.TreeConnect.Share.CurrentUses** MUST be decreased by 1.

Upon success, the resource sharing connection identified by the **TID** is closed, and the **TID** is invalidated by removing the **TreeConnect** entry from **Server.Connection.TreeConnectTable**.

The server MUST deregister **TreeConnect** by invoking the event Server Deregisters a Treeconnect ([\[MS-SRVS\]](#) section 3.1.6.7) with the tuple **<TreeConnect.Share.ServerName, TreeConnect.Share.Name>** and **Server.TreeConnect.TreeGlobalId** as input parameters.

The response message indicates success or an error condition. The list of possible error codes is specified in section [2.2.4.51.2](#). The response MUST be sent to the client as specified in section [3.3.4.1](#).

3.3.5.42 Receiving an SMB_COM_NEGOTIATE Request

When the server receives an [SMB_COM_NEGOTIATE Request \(section 2.2.4.52.1\)](#), it MUST read through the list of dialects offered by the client in the **DialectString** field of the request. If the **Server.SupportDialects** ADM element does not match with any of the dialects listed in the **DialectString** field, the server MUST set the **DialectIndex** value to 0xFFFF and return the Core Protocol form of the [SMB_COM_NEGOTIATE Response \(section 2.2.4.52.2\)](#).

If one or more dialects in the **Server.SupportDialects** ADM element match the dialects listed in the **DialectString** field, the index of the last matching dialect in **Server.SupportDialects** MUST be placed into the **DialectIndex** field of the SMB_COM_NEGOTIATE Response.

Server.Connection.SelectedDialect MUST be set to an identifier, as listed in section [1.7](#), that corresponds to the **DialectIndex** field set in the response.

If the dialect selected is "NT LM 0.12" (NT LAN Manager), then:

- The **Server.Connection.NTLMChallenge** is set to an 8-byte random number.
- The bits of the **SecurityMode** field of the response are set based upon the values of the **Server.ShareLevelAuthentication**, **Server.PlaintextAuthenticationPolicy**, and **Server.MessageSigningPolicy** server ADM elements.
- The **MaxMpxCount** field is set from the **Server.MaxMpxCount** ADM element.
- The **MaxNumberVcs** field is set from the **Server.MaxVcNumber** ADM element.
- The **SessionKey** field is set from the **Server.Connection.SessionKey** ADM element.
- The **MaxRawSize** field is set from the **Server.MaxRawSize** ADM element.
- The **MaxBufferSize** field is set from the **Server.MaxBufferSize** ADM element.
- The **Capabilities** field is set from the **Server.Capabilities** ADM element.
- The **Challenge** field is set from the **Server.Connection.NTLMChallenge** ADM element.
- The **ChallengeLength** field is set to the length of the **Challenge** field.
- Values for the remaining fields are provided as specified in section [2.2.4.52.2](#).

The SMB_COM_NEGOTIATE Response MUST be sent as specified in section [3.3.4.1](#).

3.3.5.43 Receiving an SMB_COM_SESSION_SETUP_ANDX Request

When the server receives an SMB_COM_SESSION_SETUP_ANDX request from the client, it MUST verify the **SessionKey**. If the **SessionKey** received in the request is not equal to **Server.Connection.SessionKey**, the server MAY fail the request with STATUS_INVALID_PARAMETER.

The server MUST pass the **PrimaryDomain**, **AccountName**, **OEMPassword**, and **UnicodePassword** fields to the authentication subsystem. If authentication fails, the server MUST increase **Server.Statistics.sts0_pwerrors** by 1 and MUST reply to the client with STATUS_LOGON_FAILURE (ERRDOS/ERRnoaccess) in an error response. The possible error codes

from the authentication subsystem and their detailed description are specified in [\[RFC2743\]](#) and [\[MS-ERREF\]](#).

If **Server.Connection.SessionSetupReceived** is FALSE and:

- If authentication was successful or **Server.GuestOkay** is TRUE:
- If their corresponding server connection variables are empty, the server MUST save the **MaxBufferSize**, **MaxMpxCount**, and **Capabilities** values reported by the client in the corresponding server connection variables. These values MUST NOT be overridden by values presented in future SMB_COM_SESSION_SETUP_ANDX request messages.
- If **Server.Connection.NativeLanMan** and **Server.Connection.NativeOS** are empty, the server MUST save the **NativeLanMan** and **NativeOS** values reported by the client in the **Server.Connection.NativeLanMan** and **Server.Connection.NativeOS** variables respectively. These values MUST NOT be overridden by values presented in future SMB_COM_SESSION_SETUP_ANDX request messages.
- The server MUST query the authentication subsystem to determine which response value was accepted.

If the value accepted for authentication was the value passed in the **OEMPassword** field:

- The server MUST set the 0x02 bit in the **SMB_Parameters.Words.Action** field of the response.
- **Server.Connection.SigningChallengeResponse** MUST be set to the challenge response received in the **OEMPassword** field in the client request.
- If LM challenge/response was used instead of LMv2 challenge/response, the entire LM Session Key MUST be stored in **Server.Connection.SigningSessionKey**. If LMv2 challenge/response was used, the entire NT Session Key MUST be stored in **Server.Connection.SigningSessionKey**. If the length of **Server.Connection.SigningSessionKey** is less than 16, the server SHOULD pad it with zeros up to 16 bytes.

If the value accepted for authentication was the value passed in the **UnicodePassword** field:

- The server MUST clear the 0x02 bit in the **SMB_Parameters.Words.Action** field of the response.
- **Server.Connection.SigningChallengeResponse** MUST be set to the challenge response received in the **UnicodePassword** field in the client request.

The entire NT Session Key MUST be stored in **Server.Connection.SigningSessionKey**. If the length of **Server.Connection.SigningSessionKey** is less than 16, the server SHOULD pad it with zeros up to 16 bytes.

- If authentication was successful and **IsSigningActive** is TRUE, message signing MUST be initialized.
- **Server.Connection.MaxMpxCount** MUST be set to **MaxMpxCount** field in the request.
- If **MaxMpxCount** in the request is less than two, the server MUST set **Server.Connection.OpLockSupport** to FALSE for this connection. Otherwise, a client attempting to break its own OpLock would always time out because there would not be enough outstanding command slots to properly revoke the OpLock. See section [3.2.5.42](#) for more information on receiving an OpLock Break Notification.

- The server MUST set **Server.Connection.SessionSetupReceived** to TRUE.
- The server MUST set **CreationTime** and **IdleTime** to be current time.

If authentication failed but **Server.GuestOkay** is TRUE (allowing Guest Access), the client MUST set the 0x01 bit in the **Action** field of the response to TRUE and return the response as if authentication had succeeded.

If authentication succeeded, the **Server.Session.UserSecurityContext** MUST be set to a value representing the user who successfully authenticated on the connection. The security context MUST be obtained from the authentication subsystem. The server MUST invoke the **GSS_Inquire_context** call as specified in [\[RFC2743\]](#) section 2.2.6, passing the **Server.Session.UserSecurityContext** as the input parameter, and MUST set **Server.Session.UserName** to the returned "src_name". If the returned "anon_state" is TRUE, the server MUST set **Server.Session.IsAnonymous** to TRUE. Otherwise, **Server.Session.IsAnonymous** MUST be set to FALSE.

If the **VcNumber** field in the session setup request is 0, the server MUST perform the following processing:

- Close all sessions in **Server.Connection.SessionTable** in which **UserName** matches **Server.Session.UserName** as specified in section [3.3.4.8](#).
- Disconnect each **Connection** in **Server.ConnectionTable**, except the current **Server.Connection**, in which **ClientName** matches the **Server.Connection.ClientName** as specified in section [3.3.7.2](#).

If authentication was successful or **Server.GuestOkay** is TRUE, a new **UID** and **GlobalSessionId** MUST be generated and entered into **Server.Connection.SessionTable**. If the size of **Server.Connection.SessionTable** has reached **Server.SrvMaxSessionTableSize**, the server MUST reply to the client with STATUS_TOO_MANY_SESSIONS (ERRSRV/ERRtoomanyuids) in an error response; otherwise, **Server.Statistics.sts0_sopens** MUST be increased by 1. The server MUST register the session by invoking the event Server Registers a New Session ([\[MS-SRVS\]](#) section 3.1.6.2) and MUST assign the return value to **Session.SessionGlobalId**. The server MUST fill in the additional response fields as specified in section [2.2.4.53.2](#).

If authentication was successful, the server MUST query the session key from the authentication package, as specified in [\[MS-NLMP\]](#). If the session key is equal to or longer than 16 bytes, only the least significant 16 bytes MUST be stored in **Server.Session.SessionKey**. Otherwise, the session key MUST be stored in **Server.Session.SessionKey** and MUST be padded with zeros up to 16 bytes.

The response is sent to the client as specified in section [3.2.4.1](#).

3.3.5.44 Receiving an SMB_COM_LOGOFF_ANDX Request

When the server receives an [SMB_COM_LOGOFF_ANDX Request \(section 2.2.4.54.1\)](#), it MUST first find the **UID** in the **Server.Connection.SessionTable**. If the **UID** is not found in the table, the server MUST return an error response with STATUS_SMB_BAD_UID (ERRSRV/ERRbaduid). If the **UID** is found, the server MUST release all resources that were opened by the **UID** specified in the [SMB Header \(section 2.2.3.1\)](#) of the request.

The server MUST deregister the session by invoking the event Server Deregisters a Session ([\[MS-SRVS\]](#) section 3.1.6.3), providing **Session.SessionGlobalId** as the input parameter. **Server.Statistics.sts0_sopens** MUST be decreased by 1.

The **Server.Connection.SearchOpenTable**, **Server.Connection.FileOpenTable**, and **Server.Connection.TreeConnectTable** MUST each be traversed in turn.

For each **Open** in **Connection.FileOpenTable**, where **Open.Session.UID** matches the **UID** field in the request, the server MUST close the **Open**, release every lock in **Open.Locks**, remove the **Open** entry from **Server.Connection.FileOpenTable**, and deregister that **Open**, as specified in [\[MS-SRVS\]](#) section 3.1.6.5, providing **Open.FileGlobalId** as the input parameter. For each closed **Open**, the server MUST decrease **Open.TreeConnect.OpenCount** and **Server.Statistics.sts0_fopens** by 1.

For each **SearchOpen** in **Connection.SearchOpenTable**, where **SearchOpen.UID** matches the **UID** field in the request, the server MUST close the **SearchOpen** by removing it from **Server.Connection.SearchOpenTable** and freeing any resources like the search context.

For each **TreeConnect** in **Server.Connection.TreeConnectTable**, where **TreeConnect.Session.UID** matches the **UID** field in the request, the server MUST remove the **TreeConnect** entry from **Server.Connection.TreeConnectTable** and MUST deregister the **TreeConnect** by invoking the event specified in [\[MS-SRVS\]](#) section 3.1.6.7 with the tuple <**TreeConnect.Share.ServerName**, **TreeConnect.Share.Name**> and **TreeConnect.TreeGlobalId** as input parameters. For each deregistered **TreeConnect**, **TreeConnect.Share.CurrentUses** MUST be decreased by 1.

Resources opened by the specified **UID** MUST be closed, and the resource entry MUST be removed from the table in which it was found. When all search handles, file handles, and tree connects owned by the **UID** have been closed, the **Server.Session** with the matching **UID** is invalidated and removed from the **Server.Connection.SessionTable**.

3.3.5.45 Receiving an SMB_COM_TREE_CONNECT_ANDX Request

When the server receives an [SMB_COM_TREE_CONNECT_ANDX Request \(section 2.2.4.55.1\)](#), it MUST attempt to connect to the share indicated in the **Path** field. The server MUST provide <server name, share name> parsed from the **Path** field to invoke the event **Server Normalizes a ServerName** ([\[MS-SRVS\]](#) section 3.1.6.8) and to get the updated server name. The server MUST use <updated server name, share name> to look up the **Share** in **Server.ShareTable**. If the share is not found, the server MUST send an error response with a status of STATUS_BAD_NETWORK_NAME (ERRSRV/ERRinvnetname).

Server.Paused with a value of TRUE indicates that all shares can only be accessed by an administrator. Under these conditions, if an [SMB_COM_TREE_CONNECT Request \(section 2.2.4.50.1\)](#) is received from a user that is not an administrator, the server MUST send an error response with a status of STATUS_SHARING_PAUSED (ERRDOS/ERRpaused). [<305>](#)

If the server global variable **Server.ShareLevelAuthentication** is FALSE, the **Password** field in the request MUST be ignored, and the **UID** field in the header MUST be used to look up the **Server.Session.UserSecurityContext** to determine access rights to the share. If the user is not granted access in **Share.FileSecurity**, the server MAY fail the request with STATUS_ACCESS_DENIED. [<306>](#)

If **Server.ShareLevelAuthentication** is TRUE, **PasswordLength** bytes of the **Password** field MUST be passed to the authentication subsystem as a share-level password. If authentication fails, the server MUST send an error response with a status of STATUS_LOGON_FAILURE (ERRDOS/ERRnoaccess).

The server MUST check the validity of the **SMB_Data.Bytes.Service** field in the request. If the value does not match any of those listed in section [2.2.4.55.1](#), the server MUST fail the request with a value of STATUS_BAD_DEVICE_TYPE (ERRSRV/ERRinvdevice).

The server MUST invoke the Server Notifies Current Uses of a Share ([\[MS-SRVS\]](#) section 3.1.6.15) event with the tuple <**ServerName**, **ShareName**> to get the total number of current uses of the share. If the number of current uses is equal to or greater than **Share.MaxUses**, the server MUST fail the request with STATUS_REQUEST_NOT_ACCEPTED. If the Tree Connect is successful, the server MUST allocate a **TreeConnect** object and insert it into **Server.Connection.TreeConnectTable** with the following default values:

- A new **TID** MUST be generated to uniquely identify this tree connect in **Server.Connection.TreeConnectTable**.
- **Session** MUST be set to the session found on the **UID** lookup.
- **Share** MUST be set to the share found on the lookup in the **Server.ShareTable**.
- **OpenCount** MUST be set to zero.
- **CreationTime** MUST be set to current time.
- **Share.CurrentUses** MUST be increased by 1.

The server MUST register **TreeConnect** by invoking the Server Registers a New Treeconnect ([\[MS-SRVS\]](#) section 3.1.6.6) event and MUST assign the return value to **Server.TreeConnect.TreeGlobalId**.

The **TID** MUST be returned in the **SMB_Header.TID** field of the response.

The **SMB_Parameters.Words.OptionalSupport** field of the response MUST be set from **Server.Share.OptionalSupport**:

- If **Server.Share.OptionalSupport** indicates support for exclusive search attributes in directory search operations, the server MUST set the SMB_SUPPORT_SEARCH_BITS (0x01) bit in the **OptionalSupport** field of the response.
- If **Server.Share.OptionalSupport** indicates that the share is in a DFS namespace, the server MUST set the SMB_SHARE_IS_IN_DFS (0x02) bit in the **OptionalSupport** field of the response.

The **SMB_Data.Bytes.Service** field of the response MUST be set from **Server.Share.Type**.

If the TREE_CONNECT_ANDX_DISCONNECT_TID flag is set in the **SMB_Parameter.Words.Flags** field, continue the processing for the **Opens** and open searches, as specified in section [3.3.5.41](#). If this operation fails, no error is sent to the client.

If the Tree Connect is successful, a complete [SMB_COM_TREE_CONNECT_ANDX Response \(section 2.2.4.55.2\)](#) is sent. Otherwise, an error response message MUST be sent.

The response is sent to the client as specified in section [3.3.4.1](#).

3.3.5.46 Receiving an SMB_COM_QUERY_INFORMATION_DISK Request

When the server receives an [SMB_COM_QUERY_INFORMATION_DISK Request \(section 2.2.4.57.2\)](#), it MUST look up the **Server.TreeConnect.Share** to find the **Server.Share.LocalPath**. The **Server.Share.Type** MUST be **Disk**; otherwise, the server MUST return STATUS_SMB_BAD_TID (ERRSRV/ERRinvtid).

The server MUST determine the following:

- **Blocksize** -- The number of bytes in a block.

- **BlocksPerUnit** -- The number of blocks in a "unit".
- **TotalUnits** -- The total size, in units, of the file system.
- **FreeUnits** -- The number of unused units within the file system.

<307>

In the event of an error, an error response is returned. Otherwise, the SMB_COM_QUERY_INFORMATION_DISK response is formatted as specified in section [2.2.4.57.2](#). The response MUST be sent to the client as specified in section [3.3.4.1](#).

3.3.5.47 Receiving an SMB_COM_SEARCH or SMB_COM_FIND Request

The [SMB_COM_SEARCH \(section 2.2.4.58\)](#) and [SMB_COM_FIND \(section 2.2.4.59\)](#) commands are identical in format and behavior, with the exception that SMB_COM_FIND allows the use of [SMB_COM_FIND_CLOSE \(section 2.2.4.61\)](#) to close the search context.

Upon receiving either of these commands, the server MUST first determine whether the request is a continuation of a previous search, or a new search. If the **ResumeKeyLength** field is zero, then this is a new search. A new search proceeds as follows:

- The server MUST perform a directory search using the **FileName** field as the pattern with which to search. If the **FileName** field is an empty string, the server SHOULD <308> return all the files that are present in the directory. The path indicated in the **FileName** field MUST exist within the specified **TID**.
- The **SMB_Parameters.Words.SearchAttributes** field is used to further refine the search. See the tables in section [2.2.1.2.4](#) for a list of possible values.
 - If the SMB_FILE_ATTRIBUTE_VOLUME attribute is set, the volume label MUST be returned (the Volume Label attribute is exclusive).
 - If the value of this field is zero, only "normal" files are returned. Normal files include files with no attributes, the SMB_FILE_ATTRIBUTE_READONLY attribute, and/or the SMB_FILE_ATTRIBUTE_ARCHIVE attribute.
 - The "inclusive search attributes" are:
 - SMB_FILE_ATTRIBUTE_READONLY
 - SMB_FILE_ATTRIBUTE_HIDDEN
 - SMB_FILE_ATTRIBUTE_SYSTEM
 - SMB_FILE_ATTRIBUTE_DIRECTORY
 - SMB_FILE_ATTRIBUTE_ARCHIVE

If any of these bits is included in the **SearchAttributes** field, files with matching attributes are also included in the results. (Specifying SMB_FILE_ATTRIBUTE_READONLY or SMB_FILE_ATTRIBUTE_ARCHIVE has no effect, because files with those attributes are included in "normal" searches by default.)
 - The "exclusive search attributes" are:
 - SMB_SEARCH_ATTRIBUTE_READONLY

- SMB_SEARCH_ATTRIBUTE_HIDDEN
- SMB_SEARCH_ATTRIBUTE_SYSTEM
- SMB_SEARCH_ATTRIBUTE_DIRECTORY
- SMB_SEARCH_ATTRIBUTE_ARCHIVE

These attributes are used in search operations (SMB_COM_SEARCH, SMB_COM_FIND, [SMB_COM_FIND_UNIQUE \(section 2.2.4.60\)](#), and [TRANS2_FIND_FIRST2 \(section 2.2.6.2\)](#)) to select the specific set of attributes that a file needs to have in order to be included in the results of the search. A file MUST have all of the attributes that match (by name) in order to be listed in the search results. For example:

- If SMB_SEARCH_ATTRIBUTE_HIDDEN is set in the **SearchAttributes** field, then files without the SMB_FILE_ATTRIBUTE_HIDDEN attribute will be rejected.
- If SMB_SEARCH_ATTRIBUTE_READONLY and SMB_SEARCH_ATTRIBUTE_ARCHIVE are set, files that do not have both the SMB_FILE_ATTRIBUTE_READONLY and the SMB_FILE_ATTRIBUTE_ARCHIVE attributes set will be rejected.

If no exclusive search attributes are set, then no files are rejected from being listed.

- The response is formatted as specified in [2.2.4.58](#). The number of search result entries sent in the response is the minimum of:
 - The number of entries found.
 - The value of the **MaxCount** field in the request.
 - The number of entries that can be fit into the response without exceeding the **Server.Connection.ClientMaxBufferSize** ADM element limit.
- If, after composing the response, there are still additional entries available to be sent, the server MUST create a search context. If the number of entries in the **Server.Connection.SearchOpenTable** ADM element is greater than or equal to the **Server.MaxSearches** ADM element, the server MUST fail the request with STATUS_OS2_NO_MORE_SIDS. Otherwise, the server MUST allocate a **SearchOpen** object and insert it into the **Server.Connection.SearchOpenTable** ADM element. The following values MUST be set by the server:
 - **Server.SearchOpen.MID**: The value of the **MID** field from the [SMB Header](#) of the client request.
 - **Server.SearchOpen.PID**: The value of the **PID** from the SMB Header of the client request.
 - **Server.SearchOpen.TID**: The value of the **TID** field from the SMB Header of the client request.
 - **Server.SearchOpen.UID**: The value of the **UID** field from the SMB Header of the client request.
 - **Server.SearchOpen.FindSID**: A newly generated [Search ID \(SID\)](#) value, as specified in section [2.2.1.6.5](#).
 - **Server.SearchOpen.PathName**: The **FileName** field from the client request with its final component removed.

The response MUST be sent to the client as specified in section [3.3.4.1](#).

If this is the continuation of a previous search:

- Using the **UID**, **TID**, **PID**, and **MID**, the **Server.Connection.SearchOpenTable** ADM element is scanned for a matching search context. If no matching search context is found, the server returns an error response with a **Status** value of **STATUS_NO_MORE_FILES** (ERRDOS/ERRnofiles). This indicates that the end of the search has been reached.
- If the search context is found, then a new response is created containing the next set of entries to be sent to the client. The search is resumed based upon search location indicated by the **ResumeKey** field in the request. The response MUST be sent to the client as specified in section [3.3.4.1](#).

Unlike the **SMB_COM_FIND** command, the **SMB_COM_SEARCH** command has no matching **Close** operation to allow the client to explicitly close an incomplete search. Search contexts created by the **SMB_COM_SEARCH** command MUST be closed and removed from the **Server.Connection.SearchOpenTable** ADM element when the end of the search is reached (no more matching files are found), and whenever the **PID** that created the context is closed. A **PID** is closed with an [SMB_COM_PROCESS_EXIT \(section 2.2.4.18\)](#). If the **TID** in which the search is being performed is closed (with an [SMB_COM_TREE_DISCONNECT \(section 2.2.4.51\)](#) or a similar command), the search context MUST also be closed. The server SHOULD also periodically purge unused search contexts by using the [Unused Open Search Timer \(section 3.3.2.3\)](#), if implemented, or close the least recently used search context when a new search is received and the server is out of resources to process it. [<309>](#)

If a search continuation request arrives after the search context has been purged, the client receives an error response with a **Status** of **STATUS_NO_MORE_FILES** (ERRDOS/ERRnofiles), which is the same as the value returned if the end of search has been reached. [<310>](#)

3.3.5.48 Receiving an SMB_COM_FIND_UNIQUE Request

Processing of the **SMB_COM_FIND_UNIQUE** (section 3.3.5.48) request is identical to the processing of **SMB_COM_FIND**, except that the **Find Unique** operation includes an implicit close. After the response is sent, the search context is not stored, and further requests MUST NOT be made using a **ResumeKey**.

The response is formatted as specified in [2.2.4.60.2](#). The response MUST be sent to the client as specified in section [3.3.4.1](#). [<311>](#)

3.3.5.49 Receiving an SMB_COM_FIND_CLOSE Request

The **SMB_COM_FIND_CLOSE** (section 3.3.5.49) command is used to terminate a search operation. Using the **UID**, **TID**, **PID**, **MID**, and **ResumeKey** from the request, the **Server.Connection.SearchOpenTable** is scanned for a matching search context. If the matching context is found, it is closed and the entry is removed from **Server.Connection.SearchOpenTable**.

The response is formatted as specified in [2.2.4.61.2](#). The response MUST be sent to the client as specified in section [3.3.4.1](#).

3.3.5.50 Receiving an SMB_COM_NT_TRANSACT Request

The **SMB_COM_NT_TRANSACT** (section 3.3.5.50) is processed as specified in [Receiving any Transaction Request \(section 3.3.5.2.5\)](#). The processing of **NT_Trans** subcommands is specified in section [3.3.5.59](#). In addition, the **Function** field of the request MUST be validated.

If the **Function** code is not defined, the server MUST return STATUS_INVALID_SMB (ERRSRV/ERRerror). If the **Function** code is defined but not implemented, the server MUST return STATUS_SMB_BAD_COMMAND (ERRSRV/ERRbadcmd).

The response MUST be sent to the client as specified in section [3.3.4.1](#).

3.3.5.51 Receiving an SMB_COM_NT_CREATE_ANDX Request

This command can be used by the client to create a new file, open or truncate an existing file, create a directory, or open a named pipe or device. It is similar to other SMB Open and Create commands, except that the variety of options is much greater.

Upon receipt of an [SMB_COM_NT_CREATE_ANDX Request \(section 2.2.4.64.1\)](#), the server MUST follow the steps as specified in section [3.3.5.2](#) and MUST determine the pathname of the object to open or create. This involves the interaction of three fields:

- If the **RootDirectoryFID** is nonzero, it represents a directory within the share represented by the **TID**. The **FileName** MUST be evaluated relative to the **RootDirectoryFID**, not the **TID**.
- If the **RootDirectoryFID** is zero, the **FileName** MUST be evaluated relative to the **TID**.

When opening a named pipe, the **FileName** field MUST contain only the relative name of the pipe. That is, the "\\PIPE\" prefix MUST NOT be present. This is in contrast with other commands, such as SMB_COM_OPEN_ANDX and TRANS2_OPEN2, which require that the "\\PIPE" prefix be present in the path name. If **Server.Session.IsAnonymous** is TRUE, the server MUST invoke the event specified in [\[MS-SRVS\]](#) section 3.1.6.17 by providing the **FileName** field with the "\\PIPE\" prefix removed as input parameter. If the event returns FALSE, indicating that no matching named pipe is found that allows an anonymous user, the server MUST fail the request with STATUS_ACCESS_DENIED and MUST increase **Server.Statistics.sts0_permerrors** by 1. Otherwise, the server MUST continue the create processing.

If **Server.EnableOplock** is TRUE, the **Flags** field in the request allows the client to request an exclusive or batch OpLock. The level of OpLock granted (or not) MUST be returned in the **OpLockLevel** field in the response. The **Flags** field also allows the user to request opening a directory.

If the object opened is a directory, the server MUST set the **Directory** field of the response to a nonzero value (TRUE); a zero value (FALSE) indicates that the object is not a directory.

The **DesiredAccess** field is used to indicate the access modes that the client requests. If **DesiredAccess** is not granted in **Share.FileSecurity** for the user indicated by the **UID**, the server MUST fail the request with STATUS_ACCESS_DENIED. If the user's security context indicated by the **UID** does not have appropriate privileges, the server SHOULD fail the request with STATUS_PRIVILEGE_NOT_HELD or STATUS_ACCESS_DENIED (ERRDOS/ERRnoaccess). [<312>](#) If no access is granted for the client on this file, the server MUST increase **Server.Statistics.sts0_permerrors** by 1 and MUST fail the open with STATUS_ACCESS_DENIED (ERRDOS/ERRnoaccess).

The **ImpersonationLevel** field in the request MUST be set to one of the values specified in section [2.2.4.64.1](#); otherwise, the server MUST fail the request with STATUS_BAD_IMPERSONATION_LEVEL (0xC00000A5).

If the object is a regular file and it is being created or overwritten, the **AllocationSize** indicates the number of bytes to pre-allocate.

ShareAccess provides the set of sharing modes that the client has requested. If any of these sharing modes is unavailable, the server MUST fail the open with STATUS_SHARING_VIOLATION

(ERRDOS/ERRbadshare). If **ShareAccess** values of FILE_SHARE_READ, FILE_SHARE_WRITE, or FILE_SHARE_DELETE are set for a printer file or a named pipe, the server SHOULD ignore these values.

If the object already exists, the action that the server SHOULD attempt is determined by interpreting the **CreateDisposition** field as follows: <313>

- FILE_SUPERSEDE, FILE_OVERWRITE, FILE_OVERWRITE_IF: Overwrite the file.
- FILE_OPEN, FILE_OPEN_IF: Open the existing file.
- FILE_CREATE: Fail.

If the object does not already exist, the action the server MUST attempt is determined by interpreting the **CreateDisposition** field as follows:

- FILE_SUPERSEDE, FILE_CREATE, FILE_OPEN_IF, FILE_OVERWRITE_IF: Create the file.
- FILE_OPEN, FILE_OVERWRITE: Fail.

If the object is a regular file and it is being created or overwritten, the **AllocationSize** indicates the number of bytes to pre-allocate.

If the object is being created, **ExtFileAttributes** represents a set of requested attributes to be assigned to the object. The set of attributes actually assigned is returned to the client in the **ExtFileAttributes** field of the response.

If the open or create is successful, <314> the server MUST provide additional file attribute information, including:

- The type of the object that has been opened.
- The creation, last write, last change, and last access times of the object.
- The file size (determined by the **EndOfFile** field) and file allocation size, if the object is a file.
- The named pipe state, if the object is a named pipe.

If the command is successful, the server MUST increase **Server.Statistics.sts0_fopens** by 1 and MUST allocate an **Open** object and insert it into **Server.Connection.FileOpenTable** with the following default values:

- A new **FID** MUST be created to uniquely identify this **Open** in **Server.Connection.FileOpenTable**.
- If a requested OpLock was granted, the type of OpLock MUST be set in **Server.Open.OpLock** and **Server.Open.OplockState** MUST be set to **Held**; otherwise, **Server.Open.OpLock** MUST be set to **None** and **Server.Open.OplockState** MUST be set to **None**.
- **Server.Open.TreeConnect** MUST be set to the **TreeConnect** on which the open request was performed, and **Server.Open.TreeConnect.OpenCount** MUST be increased by 1.
- **Server.Open.Session** MUST be set to **Server.Open.TreeConnect.Session**.
- **Server.Open.Connection** MUST be set to the **Server.Open.Session.Connection**.
- **Server.Open.Locks** MUST be set to an empty list.

- **Server.Open.PID** MUST be set to the **PID** provided in the request.
- **Server.Open.PathName** MUST be set to the **FileName** field of the request.
- **Server.Open.GrantedAccess** MUST be set to the **DesiredAccess** field of the request.

The server MUST register the **Open** by invoking the event Server Registers a New Open ([\[MS-SRVS\]](#) section 3.1.6.4) and MUST assign the return value to **Server.Open.FileGlobalId**.

The **FID** MUST be placed into an [SMB_COM_NT_CREATE_ANDX Response \(section 2.2.4.64.2\)](#) message. If an error is generated, an error response MUST be used instead.

If the SMB_COM_NT_CREATE_ANDX is successful, this information, along with the **FID** generated by the command, MUST be placed into an SMB_COM_NT_CREATE_ANDX Response message. The **PID** and **TID** from the request header and new **FID** MUST be entered into the **Server.Connection.FileOpenTable**. If an error is generated, an error response MUST be used instead.

The response MUST be sent to the client as specified in section [3.3.4.1](#).

3.3.5.52 Receiving an SMB_COM_NT_CANCEL Request

Upon receipt of an [SMB_COM_NT_CANCEL Request \(section 2.2.4.65.1\)](#), the server MUST search the **Server.Connection.PendingRequestTable** for any pending commands that have the same **UID**, **TID**, **PID**, and **MID** as presented in the SMB_COM_NT_CANCEL Request. If the SMB transport is connectionless, the header **CID** value SHOULD [<315>](#) also be used.

For each matching entry, the server MUST pass the **CancelRequestID** to the object store to request cancellation of the pending operation, as described in the Server Requests Canceling an Operation section in [\[MS-FSA\]](#). The canceled commands MUST return an error result or, if they complete successfully, a response message. The [SMB_COM_NT_CANCEL \(section 2.2.4.65\)](#) command MUST NOT send a response; there is no response message associated with SMB_COM_NT_CANCEL. [<316>](#)

SMB_COM_NT_CANCEL is commonly used to force completion of operations that can potentially wait for an unbounded period of time, such as an [NT_TRANSMACT_NOTIFY_CHANGE \(section 2.2.7.4\)](#).

3.3.5.53 Receiving an SMB_COM_NT_RENAME Request

Upon receipt of an [SMB_COM_NT_RENAME Request \(section 2.2.4.66.1\)](#), the server MUST verify that a file exists matching both the **OldFileName** pathname field and the **SearchAttributes** field in the request. OldFileName MUST NOT contain wildcard characters; otherwise, the server MUST return an error response with a Status of STATUS_OBJECT_PATH_SYNTAX_BAD (ERRDOS/ERRbadpath).

The processing of the request depends on the information level provided in the **InformationLevel** field of the request:

- If the **InformationLevel** field value is SMB_NT_RENAME_RENAME_FILE (0x0104), the request is treated as if it is an [SMB_COM_RENAME Request \(section 2.2.4.8.1\)](#). Message processing follows as specified in section [3.3.5.10](#), with the exception that the command code returned in the response [SMB Header \(section 2.2.3.1\)](#) MUST be SMB_COM_NT_RENAME (0xA5).
- If the **InformationLevel** field value is neither SMB_NT_RENAME_RENAME_FILE (0x0104) nor SMB_NT_RENAME_SET_LINK_INFO (0x103), the server SHOULD fail the request with STATUS_INVALID_SMB (ERRSRV/ERRerror). [<317>](#)

- If the **InformationLevel** field value is SMB_NT_RENAME_SET_LINK_INFO (0x0103), the original file MUST NOT be renamed. Instead, the server MUST attempt to create a hard link at the target specified in **NewFileName**. The processing information below applies to receiving a request with an information level of SMB_NT_RENAME_SET_LINK. <318>

If the target name already exists, the hard linking operation MUST fail with STATUS_ACCESS_DENIED(ERRDOS/ERRnoaccess) and **Server.Statistics.sts0_permerrors** MUST be increased by 1.

Other considerations:

- Only a single **TID** is supplied, so the **OldFileName** and **NewFileName** pathnames MUST be within the same share on the server. If **OldFileName** is a directory, **NewFileName** MUST NOT be a destination located within **OldFileName** or any of its subdirectories. If these conditions are not met, the server MUST return STATUS_OBJECT_PATH_SYNTAX_BAD (ERRDOS/ERRbadpath).
- The **UID** supplied in the request MUST be used to look up the **Server.Session.UserSecurityContext** of the user. The user MUST have at least read access to the file for the hard linking operation to succeed. If the user does not have read access to the file, the server MUST return STATUS_ACCESS_DENIED (ERRDOS/ERRnoaccess) and MUST increase **Server.Statistics.sts0_permerrors** by 1.
- Only the SMB_FILE_ATTRIBUTE_HIDDEN and SMB_FILE_ATTRIBUTE_SYSTEM attributes are tested against the **SearchAttributes** field. This command can hard link normal, hidden, and/or system files if the appropriate bits are set in **SearchAttributes**.
- This command MUST NOT hard link volume labels.
- If a file to be renamed is currently open:
 - If the file is opened by the requesting process, it MUST be open in compatibility mode (see section 3.2.4.5.1). If it is not open in compatibility mode, the hard linking MUST fail with STATUS_ACCESS_DENIED (ERRDOS/ERRnoaccess) and **Server.Statistics.sts0_permerrors** MUST be increased by 1. <319>
 - If another process has the file open, and that process has an opportunistic lock (OpLock) on the file, and the process has asked for extended notification (Batch OpLock), the hard link request MUST block until the server has sent an OpLock break request to the owner of the OpLock and either received a response or the OpLock break time-out has expired. If the process holding the OpLock closes the file (thus freeing the OpLock), the hard linking takes place. If not, the request MUST fail with STATUS_SHARING_VIOLATION (ERRDOS/ERRbadshare).
- It is possible for a server to be processing multiple requests on the same resource concurrently. As a result, there may be interactions between the execution of the hard link operation and other operations, such as ongoing searches ([SMB_COM_SEARCH \(section 2.2.4.58\)](#), [SMB_COM_FIND \(section 2.2.4.59\)](#), [TRANS2_FIND_FIRST2 \(section 2.2.6.2\)](#), and so on). Although creating a hard link within a directory that is actively being searched is not prohibited, the interaction can disrupt the search, causing it to complete before all directory entries have been returned. <320>

If the operation is successful, the server MUST construct an [SMB_COM_NT_RENAME Response \(section 2.2.4.66.2\)](#) message. The response MUST be sent to the client as specified in section 3.3.4.1.

3.3.5.54 Receiving an SMB_COM_OPEN_PRINT_FILE Request

Upon receipt of an [SMB_COM_OPEN_PRINT_FILE Request \(section 2.2.4.67.1\)](#), the server MUST perform the following actions:

- Verify the **TID** as described in section [3.3.5.2](#).
- Verify that the **Server.Share** identified by the **SMB_Header.TID** has a **Server.Share.Type** of **Printer**. If the share is not a printer share, the server MUST return an error response with **Status** set to STATUS_INVALID_DEVICE_REQUEST (ERRDOS/ERRbadfunc).
- Verify the **UID** as described in section [3.3.5.2](#).
- Verify that the **Server.Session** identified by the **SMB_Header.UID** in the request has a **Server.Session.UserSecurityContext** with sufficient privileges to create a new print spool file. If the underlying object store returns STATUS_ACCESS_DENIED, the server MUST increase **Server.Statistics.sts0_permerrors** by 1.
- Create a temporary file on the server to receive the spool file data.

[<321>](#)

If the spool file cannot be created, an error response MUST be sent to the client.

Otherwise, **Server.Statistics.sts0_jobsqueued** and **Server.Statistics.sts0_fopens** MUST be incremented by 1, and a new FID MUST be allocated and assigned to the newly created spool file. A new **Open** object MUST be created with the **TID**, **UID** and PID fields from the request header and the new FID. This **Open** MUST be entered into the **Server.Connection.FileOpenTable** with the following default values:

- If **Server.EnableOplock** is TRUE and a requested OpLock was granted, the type of OpLock MUST be set in **Server.Open.OpLock**; otherwise, **Server.Open.OpLock** MUST be set to None.
- **Server.Open.TreeConnect** MUST be set to the **TreeConnect** on which the open request was performed, and **Server.Open.TreeConnect.OpenCount** must be incremented by 1.

The server MUST register the **Open** by invoking the Server Registers a New Open event ([\[MS-SRVS\]](#) section 3.1.6.4) and MUST assign the return value to **Server.Open.FileGlobalId**.

The FID MUST be returned to the client in the response, which is formatted as specified in section [2.2.4.67.2](#). The response MUST be sent to the client as specified in section [3.3.4.1](#).

The first **SetupLength** bytes of **Data** written to the spool file MUST be passed to the spool file without modification. If the **Mode** is set to Text Mode in the Open request, the server might perform minimal processing on the data in the file, starting at the offset indicated by **SetupLength**. Several SMB commands, including SMB_COM_WRITE_ANDX, can be used to write data to the file.

3.3.5.55 Receiving an SMB_COM_WRITE_PRINT_FILE Request

Upon receipt of an [SMB_COM_WRITE_PRINT_FILE Request \(section 2.2.4.68.1\)](#), the **Data** field in the request MUST be written to the file indicated by the **FID** field, which MUST indicate a print spool file. The response MUST be sent to the client as specified in section [3.3.4.1.<322>](#)

3.3.5.56 Receiving an SMB_COM_CLOSE_PRINT_FILE Request

Upon receipt of an [SMB_COM_CLOSE_PRINT_FILE Request \(section 2.2.4.69.1\)](#), the server MUST verify the **UID** as in section [3.3.5.2](#).

The server MUST perform a lookup of the **FID** in **Server.Connection.FileOpenTable**. If the **FID** is not found, the server MUST return an error response with a **Status** of STATUS_INVALID_HANDLE (ERRDOS/ERRbadfid). Otherwise, the **Open** indicated by the **FID** MUST be closed, every lock in **Open.Locks** MUST be released, and **Open.TreeConnect.OpenCount**, **Server.Statistics.sts0_jobsqueued**, and **Server.Statistics.sts0_fopens** MUST be decreased by 1. The server MUST provide **Open.FileGlobalId** as an input parameter and MUST deregister the **Open** by invoking the event Server Deregisters an Open ([\[MS-SRV5\]](#) section 3.1.6.5). Once the file has been closed, the server MUST queue it for printing. The server SHOULD delete the file once it has been printed. [<323>](#)

If the file is successfully closed, the **FID** MUST be invalidated by removing the **Open** entry from **Server.Connection.FileOpenTable**. Once the **FID** has been invalidated, it is available to be reused by future open or create operations. The response MUST be sent to the client as specified in section [3.3.4.1](#).

3.3.5.57 Receiving any SMB_COM_TRANSACTION Subcommand Request

SMB_COM_TRANSACTION and SMB_COM_TRANSACTION_SECONDARY implement the original transaction subprotocol created for the **LAN Manager 1.0** dialect. The purpose of these transactions is to transfer requests and associated data to mailslots or to and from named pipes. With respect to CIFS, the operations sent to mailslots and exchanged with named pipes are known as subcommands.

The subcommands are not defined by the transaction subprotocol itself. Transactions simply provide a means for delivery and retrieval of the results. Support for and interpretation of an SMB_COM_TRANSACTION subcommand are specified by the mailslot or named pipe to which the subcommand is sent.

For example, the Remote Administration Protocol (RAP, also known as Remote API Protocol) is defined for use with the \PIPE\LANMAN named pipe. That is, if the **Name** field passed in the initial SMB_COM_TRANSACTION request contains the string "\PIPE\LANMAN", the message is designated to be delivered to the RAP subsystem, which listens on the \PIPE\LANMAN named pipe. The RAP subsystem interprets and processes the contents of the transaction request and provides the response. The RAP subsystem is documented in [\[MS-RAP\]](#). Additional information is provided below.

Other than the \PIPE\LANMAN named pipe used by RAP, all named pipes accessed via the SMB transaction subprotocol support the set of subcommands specified in section [2.2.5](#) of this document, and in the following sections. These are commonly known as the SMB Trans subcommands. Each SMB Trans subcommand is identified by a subcommand code, which is specified in the first **Setup** word--**Setup[0]**--of the SMB_COM_TRANSACTION_SECONDARY request.

Mailslots typically support only the TRANS_MAILSLLOT_WRITE subcommand. TRANS_MAILSLLOT_WRITE requests are formatted as SMB_COM_TRANSACTION request messages, but they are not sent over an SMB connection. Instead, mailslot transactions are sent as individual datagrams outside of the context of any SMB connection. The transaction subprotocol allows for the reliable transmission of mailslot requests (Class 1 mailslot messages) within the CIFS Protocol, but no operations make use of this type of exchange and no such usage has been specified or implemented. Mailslot subcommands are, therefore, not covered in this document. See [\[MS-MAIL\]](#) for the mailslot subprotocol specification.

The transaction processing subsystems can be implemented in a variety of ways:

- As an integral part of the CIFS server.
- As a loadable library module.

- As a separate process running independently.
- Via some other mechanism not listed here.

If a transaction processing subsystem is independent of the CIFS server, the CIFS server MUST verify that transaction processing is available. The mechanism for doing so is implementation-dependent. If the transaction processing subsystem (RAP or SMB Trans) is not available, the server MUST return an error response with **Status** set to STATUS_NOT_IMPLEMENTED (ERRDOS/ERRbadfunc).

Named pipes MUST exist within the IPC\$ share on the server. The **TID** in the SMB_COM_TRANSACTION request MUST represent a connection to the IPC\$ share.

A named pipe can be opened, just as a file or device can be opened. The resulting FID is used by some of the SMB Trans subcommands to identify the pipe.

The SMB_COM_TRANSACTION request, when received by the server, is handled as specified in sections [3.3.5.31](#) and [3.3.5.2.4](#). Transfer of the full transaction request might require one or more SMB_COM_TRANSACTION_SECONDARY messages, as specified in section [3.2.4.1.4](#). When the transaction is received in full, the **Setup**, **Trans_Parameters**, and **Trans_Data** are passed to the subsystem that supports operations on the named pipe. In the case of a RAP request, the transaction is passed to the RAP subsystem. Otherwise, the transaction is passed to the subsystem that implements the SMB Trans calls specified in section [2.2.5](#).

When processing of the transaction has been completed, the subsystem returns the transaction response to the CIFS server, which returns the transaction response to the client. If the transaction response is too large to fit within a single SMB_COM_TRANSACTION response message (based upon the value of **Server.Connection.ClientMaxBufferSize**), the server MUST send multiple SMB_COM_TRANSACTION Final Transaction Response messages, as specified in section [3.2.4.1.4](#), in order to transport the entire transaction response to the client.

3.3.5.57.1 Receiving a RAP Transaction Request

As described previously, the CIFS server determines that a request is a RAP request by examining the **Name** field in the [SMB_COM_TRANSACTION Request \(section 2.2.4.33.1\)](#) message. If **Name** is "\PIPE\LANMAN", the transaction MUST be passed to the RAP processing subsystem.

RAP subcommands do not make use of the **Setup** field in the SMB_COM_TRANSACTION request, so no **Setup** values are passed to the RAP subsystem:

The CIFS server MUST pass the following information to the RAP subsystem (see [\[MS-RAP\]](#)):

- The final **TotalParameterCount** indicating the number of transaction parameter bytes.
- The transaction parameter block (**Trans_Parameters**).
- The final **TotalDataCount** indicating the number of transaction data bytes.
- The transaction data block (**Trans_Data**).
- The **MaxParameterCount** field from the request, indicating the maximum size, in bytes, of the transaction parameter block permitted in the transaction response.
- The **MaxDataCount** field from the request, indicating the maximum size, in bytes, of the transaction data block permitted in the transaction response.

The response parameter buffer filled in by the RAP subsystem MUST be returned to the client via the parameter block of the [SMB_COM_TRANSACTION Response \(section 2.2.4.33.2\)](#). The **TotalParameterCount** of the transaction response MUST be set to the number of bytes in the response parameter buffer.

The response data buffer filled in by the RAP server MUST be returned to the client via the data block of the SMB_COM_TRANSACTION response. The **TotalDataCount** of the transaction response MUST be set to the number of bytes in the response data buffer.

3.3.5.57.2 Receiving a TRANS_SET_NMPIPE_STATE Request

Upon receipt of a [TRANS_SET_NMPIPE_STATE \(section 2.2.5.1\)](#) subcommand request, the SMB Trans subsystem MUST attempt to apply the state indicated by the **Trans_Parameters.PipeState** field to the named pipe indicated by the **Server.Open** identified by the **SMB_Parameters.Words.Setup.FID** field of the request. [<324>](#)

If the request fails, the status code indicating the error is returned in an [SMB_COM_TRANSACTION \(section 2.2.4.33\)](#) error response message. If successful, the server MUST construct a [TRANS_SET_NMPIPE_STATE Response \(section 2.2.5.1.2\)](#).

The CIFS server passes the results to the client in the [SMB_COM_TRANSACTION Response \(section 2.2.4.33.2\)](#).

3.3.5.57.3 Receiving a TRANS_RAW_READ_NMPIPE Request

This method of reading data from a named pipe ignores message boundaries even if the pipe is set up as a message mode pipe. [<325>](#)

Upon receipt of a TRANS_RAW_READ_NMPIPE subcommand request, the SMB Trans subsystem MUST read data from the open named pipe specified by the FID, which is contained in **Setup[1]** in the request. The amount of data to be read is specified by the **MaxDataCount** value of the SMB_COM_TRANSACTION request. The data MUST be read without regard to message boundaries (raw mode). If the named pipe is not set to non-blocking mode, and there is no data in the named pipe, the read operation on the server MUST wait indefinitely for data to become available (or until it is canceled).

If the request fails, the status code indicating the error is returned in an SMB_COM_TRANSACTION error response message. If successful, the retrieved data is returned in the **Trans_Data** section of the TRANS_RAW_READ_NMPIPE transaction response. The actual number of bytes read is returned in **TotalDataCount** in the response, and can be less than the **MaxDataCount** value specified in the request.

The CIFS server passes the results to the client in the SMB_COM_TRANSACTION response.

3.3.5.57.4 Receiving a TRANS_QUERY_NMPIPE_STATE Request

Upon receipt of a TRANS_QUERY_NMPIPE_STATE subcommand request, the SMB Trans subsystem MUST attempt to query the pipe state of the named pipe indicated by the **Server.Open** identified by the **SMB_Parameters.Words.Setup.FID** field of the request. [<326>](#)

If the request fails, the status code indicating the error is returned in an SMB_COM_TRANSACTION error response message. If successful, the server MUST construct a TRANS_QUERY_NMPIPE_STATE response, as specified in section [2.2.5.3.2](#).

The CIFS server passes the results to the client in the SMB_COM_TRANSACTION response.

3.3.5.57.5 Receiving a TRANS_QUERY_NMPIPE_INFO Request

Upon receipt of a [TRANS_QUERY_NMPIPE_INFO \(section 2.2.5.4\)](#) subcommand request, the SMB Trans subsystem **MUST** attempt to query state information for the named pipe indicated by the **Server.Open** identified by the **SMB_Parameters.Words.Setup.FID** field of the request. <327>

If the request fails, the status code indicating the error is returned in an SMB_COM_TRANSACTION error response message. The CIFS server passes the results to the client in the [SMB_COM_TRANSACTION Response \(section 2.2.4.33.2\)](#).

3.3.5.57.6 Receiving a TRANS_PEEK_NMPIPE Request

Upon receipt of a [TRANS_PEEK_NMPIPE \(section 2.2.5.5\)](#) subcommand request, the SMB Trans subsystem **MUST** attempt to peek at information from the named pipe indicated by the **Server.Open** identified by the **SMB_Parameters.Words.Setup.FID** field of the request. Data **MUST** be read from the named pipe without removing the data from the pipe queue. The maximum amount of data to be read is specified by the **SMB_Parameters.Words.MaxDataCount** field of the request. <328>

If the request fails, the status code indicating the error is returned in an [SMB_COM_TRANSACTION \(section 2.2.4.33\)](#) error response message. If successful, the server **MUST** construct a [TRANS_PEEK_NMPIPE Response \(section 2.2.5.5.2\)](#).

The CIFS server passes the results to the client in the [SMB_COM_TRANSACTION Response \(section 2.2.4.33.2\)](#).

3.3.5.57.7 Receiving a TRANS_TRANSACT_NMPIPE Request

Upon receipt of a [TRANS_TRANSACT_NMPIPE \(section 2.2.5.6\)](#) subcommand request, the SMB Trans subsystem **MUST** attempt to write data to and read data from the named pipe indicated by the **Server.Open** identified by the **SMB_Parameters.Words.Setup.FID** field of the request. The data to be written is contained in the **Trans_Data.WriteData** field of the request.

The maximum number of bytes to be read is specified by the **SMB_Parameters.Words.MaxDataCount** field of the request.

If the pipe is not a message mode pipe, the Trans subsystem **MUST** fail the request with STATUS_INVALID_PARAMETER (ERRDOS/ERRinvalidparam). <329>

If the operation fails, the status code indicating the error is returned in an [SMB_COM_TRANSACTION \(section 2.2.4.33\)](#) error response message. If the operation returns either STATUS_BUFFER_OVERFLOW (ERRDOS/ERRmoredata) or success, the server **MUST** construct a [TRANS_TRANSACT_NMPIPE Response \(section 2.2.5.6.2\)](#).

The CIFS server passes the results to the client in the [SMB_COM_TRANSACTION Response \(section 2.2.4.46.2\)](#).

3.3.5.57.8 Receiving a TRANS_RAW_WRITE_NMPIPE Request

This method of writing data to a named pipe ignores message boundaries, even if the pipe is set up as a message mode pipe.

Upon receipt of a TRANS_RAW_WRITE_NMPIPE subcommand request, the SMB Trans subsystem **MUST** write the contents of the **WriteData** field to the open named pipe specified by the FID, which is contained in **Setup[1]** in the request. The write **SHOULD** <330> be performed in **blocking mode** and byte mode, even if these modes are not set on the pipe (see the description of the **PipeState**

field of `TRANS_SET_NMPIPE_STATE` for more information). The amount of data to be written is specified by the **TotalDataCount** value of the `SMB_COM_TRANSACTION` request.

If the request fails, the status code indicating the error is returned in an `SMB_COM_TRANSACTION` error response message. If successful, the number of bytes written **MUST** be returned in the **BytesWritten** field of the transaction response. The CIFS server passes the results to the client in the `SMB_COM_TRANSACTION` response. <331>

3.3.5.57.9 Receiving a TRANS_READ_NMPIPE Request

Upon receipt of a [TRANS_READ_NMPIPE \(section 2.2.5.8\)](#) subcommand request, the SMB Trans subsystem **MUST** attempt to read data from the named pipe indicated by the **Server.Open** identified by the **SMB_Parameters.Words.Setup.FID** field of the request. The amount of data to be read is specified by the **SMB_Parameters.Words.MaxDataCount** field of the request. The data **MUST** be read with respect to the current I/O state of the pipe (see [TRANS_SET_NMPIPE_STATE \(section 2.2.5.1\)](#) and [TRANS_QUERY_NMPIPE_STATE \(section 2.2.5.3\)](#)). If the named pipe is not set to non-blocking mode, and there is no data in the named pipe, the read operation on the server **MUST** wait indefinitely for data to become available (or until it is canceled). <332>

If the operation fails, the status code indicating the error is returned in an [SMB_COM_TRANSACTION Response \(section 2.2.4.33.2\)](#) error message. If the operation returns either `STATUS_BUFFER_OVERFLOW (ERRDOS/ERRmoredata)` or success, the server **MUST** construct a [TRANS_READ_NMPIPE Response \(section 2.2.5.8.2\)](#).

The CIFS server passes the results to the client in the `SMB_COM_TRANSACTION` Response.

3.3.5.57.10 Receiving a TRANS_WRITE_NMPIPE Request

Upon receipt of a [TRANS_WRITE_NMPIPE \(section 2.2.5.9\)](#) subcommand request, the SMB Trans subsystem **MUST** attempt to write data to the underlying object store for the open named pipe identified by the **SMB_Parameters.Words.Setup.FID** field of the request. The data to be written is contained in the **Trans_Data.WriteData** field of the request. The write **MUST** be performed with respect to the current I/O state of the pipe (see [TRANS_SET_NMPIPE_STATE \(section 2.2.5.1\)](#) and [TRANS_QUERY_NMPIPE_STATE \(section 2.2.5.3\)](#)). <333>

If the operation fails, the status code indicating the error is returned in an [SMB_COM_TRANSACTION \(section 2.2.4.33\)](#) error response message. If the operation is successful, the server **MUST** construct a [TRANS_WRITE_NMPIPE Response \(section 2.2.5.9.2\)](#).

The CIFS server passes the results to the client in the [SMB_COM_TRANSACTION Response \(section 2.2.4.33.2\)](#).

3.3.5.57.11 Receiving a TRANS_WAIT_NMPIPE Request

Upon receipt of a [TRANS_WAIT_NMPIPE \(section 2.2.5.10\)](#) subcommand request, the SMB Trans subsystem **MUST** test the underlying object store for availability of the named pipe identified in the **SMB_Data.Bytes.Name** field of the request. If the named pipe cannot be opened, the SMB Trans subsystem **MUST NOT** respond to the `TRANS_WAIT_NMPIPE` subcommand request. Instead, it **MUST** enter an implementation-dependent <334> wait until the named pipe becomes available or **SMB_Parameters.Words.Timeout** milliseconds have passed.

If the request fails, the status code indicating the error is returned in an [SMB_COM_TRANSACTION \(section 2.2.4.33\)](#) error response message. If successful, the server **MUST** construct a [TRANS_WAIT_NMPIPE Response \(section 2.2.5.10.2\)](#).

The CIFS server passes the results to the client in the [SMB_COM_TRANSACTION Response \(section 2.2.4.33.2\)](#).<335>

3.3.5.57.12 Receiving a TRANS_CALL_NMPIPE Request

Upon receipt of a [TRANS_CALL_NMPIPE \(section 2.2.5.11\)](#) subcommand request, the SMB Trans subsystem MUST attempt to obtain an Open on the named pipe specified by the **SMB_Data.Bytes.Name** field in the request from the underlying object store. If successful, the Trans subsystem MUST attempt to write data to and then read data from the underlying object store as specified in section [3.3.5.57.7](#), with the following exceptions:

- The Trans subsystem MUST use the FID of the returned Open to the named pipe.
- The Trans subsystem MUST use the **Trans_Data.WriteData** of the request (using **SMB_Parameters.Words.TotalDataCount** as its length) as the data to be written.

If the operation returns either STATUS_BUFFER_OVERFLOW (ERRDOS/ERRmoredata) or success, the Trans subsystem MUST NOT construct a TRANS_TRANSACTION_NMPIPE response, but instead continue processing as follows.

If successful, the Trans subsystem MUST then attempt to close the Open on the underlying object store to the named pipe before sending a response.

If the operation fails, the status code indicating the error is returned in an error response. If the operation returns either STATUS_BUFFER_OVERFLOW (ERRDOS/ERRmoredata) or success, the server MUST construct a TRANS_CALL_NMPIPE response, as specified in section [2.2.5.11.2](#).

The CIFS server passes the results to the client in the SMB_COM_TRANSACTION response.

3.3.5.58 Receiving Any SMB_COM_TRANSACTION2 Subcommand Request

[SMB_COM_TRANSACTION2 \(section 2.2.4.46\)](#) and [SMB_COM_TRANSACTION2_SECONDARY \(section 2.2.4.47\)](#) were introduced in the **LAN Manager 1.2** dialect. They provide a second transaction subprotocol, known as the Trans2 subprotocol, which operates primarily on file system metadata. Unlike the SMB Trans subprotocol, the Trans2 subprotocol defines a specific set of subcommands; the Trans2 subcommands are not defined by the object upon which the subcommand operations are being performed.

Trans2 subcommands generally perform metadata operations on file systems (accessed via the **TID** representing the connection to the share), directories, and files. The Trans2 subcommands are always identified by a function code that is specified in **Setup[0]** (the first entry in the **Setup[]** array) in the SMB_COM_TRANSACTION2 request.

3.3.5.58.1 Receiving Any Information Level

Upon receipt of a Trans2 subcommand request with a **Trans2_Parameters.InformationLevel** field, the information level value MUST be passed to the underlying object store for processing. If the information level includes any request data, the data MUST also be passed to the underlying object store.<336>

The returned status and response data, if any, are sent to the client in a Trans2 subcommand response message corresponding to the same subcommand that initiated the request.

3.3.5.58.2 Receiving a TRANS2_OPEN2 Request

The [TRANS2_OPEN2 \(section 2.2.6.1\)](#) subcommand is used to open or create a file and set extended attributes on the file. The parameters for the Open operation are passed in the **Trans2_Parameters** block. The list of extended attribute name/value pairs is passed in the **Trans2_Data** block.

When opening a named pipe, if **Server.Session.IsAnonymous** is TRUE, the server MUST invoke the event specified in [\[MS-SRVS\]](#) section 3.1.6.17 by providing the **FileName** field with the "\PIPE\" prefix removed as input parameter. If the event returns FALSE, indicating that no matching named pipe is found that allows an anonymous user, the server MUST fail the request with STATUS_ACCESS_DENIED and MUST increase **Server.Statistics.sts0_permerrors** by 1. Otherwise, the server MUST continue the create processing.

When the Trans2 subsystem receives a [TRANS2_OPEN2 Request \(section 2.2.6.1.1\)](#), it MUST first attempt to open or create the named file. The name of the file to be opened is provided as a null-terminated string in the **FileName** field in the **Trans2_Parameters** block of the transaction. The requested access modes are listed in the **DesiredAccess** field of the request. If **DesiredAccess** is not granted in **Share.FileSecurity** for the user indicated by the **UID**, the server MUST fail the request with STATUS_ACCESS_DENIED. The **OpenMode** field indicates the action to be taken depending on whether the file does or does not already exist. If the underlying object store returns STATUS_ACCESS_DENIED, **Server.Statistics.sts0_permerrors** MUST be increased by 1.

If the file is created or overwritten (truncated), the **AllocationSize** field specifies the number of bytes that the server MUST pre-allocate for the file. If the file is created, the **FileAttributes** field provides a set of standard file attributes to be applied. The response also includes a **FileAttributes** field, which indicates the actual attributes of the file (those successfully applied if the file is created, or the existing attributes of the file if it is opened or truncated).

The **Trans2_Parameters.Flags** field MAY be used by the client to request an exclusive or a batch OpLock on the file. If the Open or Create operation is successful, the server MUST indicate whether the OpLock was granted in the **ActionTaken** field of the response. The **ActionTaken** field also indicates the action taken to open the file (create, open, or truncate).

The **Trans2_Parameters.Flags** field MAY also be used by the client to request additional information from the server. If the client requests additional information, the server MUST include the requested values, as specified in [section 2.2.6.1.1](#); otherwise, the server SHOULD zero-fill the additional information fields.

If the file is successfully opened, and a set of extended attributes is included in the request, the server MUST attempt to apply the extended attributes to the file. If an error is generated when the extended attributes are applied, the offset in bytes from the start of the extended attribute list of the attribute that caused the error MUST be returned in the **ExtendedAttributeErrorOffset** field. A full [SMB_COM_TRANSACTION2 Response \(section 2.2.4.46.2\)](#) (not an error response) MUST be sent to the client. The error code is returned in the **Status** field of the final SMB_COM_TRANSACTION2 Response. [<337>](#)

If the TRANS2_OPEN2 successfully opens the file, **Server.Statistics.sts0_fopens** MUST be increased by 1, and the **FID** MUST be returned to the client. A new **Server.Open** object with the **PID**, **UID**, **TID** from the request header, and the new **FID** MUST be entered into the **Server.Connection.FileOpenTable**. **Server.Open.TreeConnect** MUST be set to the **TreeConnect** on which the request was performed, and **Server.Open.TreeConnect.OpenCount** MUST be increased by 1. **Server.Open.Session** MUST be set to **Server.Open.TreeConnect.Session**. **Server.Open.Connection** MUST be set to the **Server.Open.Session.Connection**. **Server.Open.Locks** MUST be set to an empty list.

Server.Open.PathName MUST be set to the **FileName** field of the request.
Server.Open.GrantedAccess MUST be set to the **AccessMode** field of the request.

The server MUST register the new **FID** by invoking the Server Registers a New Open event ([\[MS-SRVS\]](#) section 3.1.6.4), and it MUST assign the return value to **Server.Open.FileGlobalId**.

The completed TRANS2_OPEN2 subcommand response MUST be returned to the client via the [SMB_COM_TRANSACTION2 \(section 2.2.4.46\)](#) transaction mechanism.

3.3.5.58.3 Receiving a TRANS2_FIND_FIRST2 Request

The server MUST perform a directory search using the **FileName** field as the pattern with which to search. If the **FileName** field is an empty string, the server MUST return all the files that are present in the directory. The path indicated in the **FileName** field MUST exist within the specified **TID**, and the **TID** MUST indicate a file system share.

The **SearchAttributes** and **Flags** fields are used to further refine the search, as specified in section [2.2.6.2.1](#).

If the **InformationLevel** parameter field in the request is set to [SMB_INFO_QUERY_EAS_FROM_LIST \(section 2.2.8.1.3\)](#), the server MUST scan the EA list of each matching file and return the EAs that match the **AttributeName** field values specified in the **GetExtendedAttributeList** field of the request. Any errors in reading the list of requested EAs MUST be reported by sending a full response (not an error response) with the **Status** field set to indicate the error. The offset of the EA that caused the error is measured in bytes from the start of the **GetExtendedAttributeList.GEAList** field in the **Trans2_Data** block of the request and is reported in the **EAErrorOffset** field of the response.

The response format is dependent upon the **InformationLevel** requested, as specified in [2.2.8.1](#). The number of search result entries sent in the response is the minimum of:

- The number of entries found.
- The value of the **SearchCount** field in the request.
- The number of entries that can fit into the response without exceeding the **MaxDataCount** field limit sent in the client's [SMB_COM_TRANSACTION2 Request \(section 2.2.4.46.1\)](#).

If no matching entries are found, the server SHOULD [<338>](#) fail the request with STATUS_NO_SUCH_FILE.

If the entire list of file system objects found by the search fit within a single response and SMB_FIND_CLOSE_AT_EOS is set in the **Flags** field, or if SMB_FIND_CLOSE_AFTER_REQUEST is set in the request, the server SHOULD [<339>](#) return a **SID** field value of zero. This indicates that the search has been closed and is no longer active on the server. [<340>](#)

Otherwise, if the number of entries in **Server.Connection.SearchOpenTable** is greater than or equal to **Server.MaxSearches**, the server MUST fail the request with STATUS_OS2_NO_MORE_SIDS. If not, the search remains open and can be continued with a [TRANS2_FIND_NEXT2 Request \(section 2.2.6.3.1\)](#) or closed using an [SMB_COM_FIND_CLOSE2 Request \(section 2.2.4.48.1\)](#).

If the search is to remain open, the server MUST allocate a **SearchOpen** object and insert it into **Server.Connection.SearchOpenTable**. The following values MUST be set by the server:

- **Server.SearchOpen.MID**: The value of the **MID** from the [SMB Header](#) of the client request.

- **Server.SearchOpen.PID**: The value of the **PID** from the SMB Header of the client request.
- **Server.SearchOpen.TID**: The value of the **TID** from the SMB Header of the client request.
- **Server.SearchOpen.UID**: The value of the **UID** from the SMB Header of the client request.
- **Server.SearchOpen.FindSID**: A newly generated [Search ID \(SID\)](#) value, as specified in section [2.2.1.6.5](#).
- **Server.SearchOpen.PathName**: The **FileName** in the client request, with its final component removed.

The search results MUST be returned to the client in a [TRANS2_FIND_FIRST2 Response \(section 2.2.6.2.2\)](#), which MUST be sent to the client as specified in section [3.3.4.1](#).

3.3.5.58.4 Receiving a TRANS2_FIND_NEXT2 Request

Upon receipt of a [TRANS2_FIND_NEXT2 Request \(section 2.2.6.3.1\)](#), the server MUST continue processing of the search indicated by the **SID** field in the request.

The **SearchAttributes** field from the original [TRANS2_FIND_FIRST2 \(section 2.2.6.2\)](#) MUST NOT be overridden by the TRANS2_FIND_NEXT2 Request. The **SearchCount**, **Flags**, and **InformationLevel** field values MUST override those used in previous requests that are part of the same search.

If the SMB_FIND_CONTINUE_FROM_LAST bit is set in the **Flags** field, the search MUST resume from the point immediately following the last entry previously returned. Otherwise, the search MUST be restarted based upon the **ResumeKey** field in the request.

Other than the modifications described preceding, search results are gathered and returned exactly as is done for the TRANS2_FIND_FIRST2. As specified for TRANS2_FIND_FIRST2 (section 2.2.6.2), if the remaining list of file system objects found by the search fits within the response and SMB_FIND_CLOSE_AT_EOS is set in the **Flags** field, or if SMB_FIND_CLOSE_AFTER_REQUEST is set in the request, the server MUST close the search.

Otherwise, the search remains open and can be continued with another TRANS2_FIND_NEXT2 Request or closed using an [SMB_COM_FIND_CLOSE2 Request \(section 2.2.4.48.1\)](#).<341>

3.3.5.58.5 Receiving a TRANS2_QUERY_FS_INFORMATION Request

Upon receipt of a TRANS2_QUERY_FS_INFORMATION subcommand request, the SMB Trans2 subsystem MUST query the object store underlying the share identified by the **TID** in the [SMB Header \(section 2.2.3.1\)](#) of the request. The Trans2 subsystem MUST use the value in the request's **Trans2_Parameters.InformationLevel** field to determine the type and format of the information that the client requests. Valid information levels are specified in section [2.2.8.2](#).

The CIFS server passes the results to the client in the [SMB_COM_TRANSACTION2 Response \(section 2.2.4.46.2\)](#).

3.3.5.58.6 Receiving a TRANS2_QUERY_PATH_INFORMATION Request

Upon receipt of a [TRANS2_QUERY_PATH_INFORMATION \(section 2.2.6.6\)](#) subcommand request, the SMB Trans2 subsystem MUST query the file or directory identified by the **Trans2_Parameters.FileName** field in the request. The Trans2 subsystem MUST use the value in the request's **Trans2_Parameters.InformationLevel** field to determine the type and format of the information that the client requests. Valid information levels are specified in section [2.2.8.3](#).

The CIFS server passes the results to the client in the [SMB_COM_TRANSACTION2 Response \(section 2.2.4.46.2\).](#)<342>

3.3.5.58.7 Receiving a TRANS2_SET_PATH_INFORMATION Request

Upon receipt of a [TRANS2_SET_PATH_INFORMATION Request \(section 2.2.6.7.1\)](#), the Trans2 subsystem MUST validate the path specified in the **FileName** field in the **Trans2_Parameters** block of the request. **FileName** is specified relative to the **TID** supplied in the [SMB Header \(section 2.2.3.1\)](#). **FileName** MUST be a valid path, and the object identified by **FileName** MUST exist and MUST be a file or directory. The file or directory does not need to be opened by the client before sending the transaction request; no FID is required.

The set of file attribute information included in the request is determined by the **InformationLevel** field. Section [2.2.8.4](#) specifies the formats and descriptions of valid information levels.

The setting of attribute information for the root directory of the share MUST NOT be supported. If the client attempts to set attributes on the root directory of the share, the server MUST return STATUS_ACCESS_DENIED (ERRDOS/ERRnoaccess) and MUST increase **Server.Statistics.sts0_permerrors** by 1.

3.3.5.58.8 Receiving a TRANS2_QUERY_FILE_INFORMATION Request

Upon receipt of a [TRANS2_QUERY_FILE_INFORMATION \(section 2.2.6.6\)](#) subcommand request, the SMB Trans2 subsystem MUST query the file or directory identified by the **Trans2_Parameters.FID** field in the request. The Trans2 subsystem MUST use the value in the request's **Trans2_Parameters.InformationLevel** field to determine the type and format of information that the client requests, which are specified in section [2.2.8.3](#).

The CIFS server passes the results to the client in the [SMB_COM_TRANSACTION2 Response \(section 2.2.4.46.2\).](#)<343>

3.3.5.58.9 Receiving a TRANS2_SET_FILE_INFORMATION Request

Upon receipt of a [TRANS2_SET_FILE_INFORMATION Request \(section 2.2.6.9.1\)](#), the Trans2 subsystem MUST validate the file handle specified in the FID field in the **Trans2_Parameters** block of the request. The file indicated by FID MUST be a directory or regular file, and MUST exist within the share indicated by the **TID** supplied in the [SMB Header \(section 2.2.3.1\)](#).

The set of standard and extended attribute information included in the request is identical to the set supported by TRANS2_SET_PATH_INFORMATION. The information level to use is specified in the **InformationLevel** field. Section [2.2.8.4](#) provides the formats and descriptions of valid information levels.

The setting of attribute information for the root directory of the share MUST NOT be supported. If the client attempts to set attributes on the root directory of the share, the server MUST return STATUS_ACCESS_DENIED (ERRDOS/ERRnoaccess) and MUST increase **Server.Statistics.sts0_permerrors** by 1.

3.3.5.58.10 Receiving a TRANS2_CREATE_DIRECTORY Request

Upon receipt of a [TRANS2_CREATE_DIRECTORY \(section 2.2.6.14\)](#) subcommand request, the Trans2 subsystem MUST validate the path provided in the **DirectoryName** field of the **Trans2_Parameters** block. All elements of the path indicated by **DirectoryName**, except for the final element of the path, MUST exist within the share indicated by the **TID** in the [SMB Header \(section 2.2.3.1\)](#). The final element of the path MUST NOT exist, otherwise, the request MUST fail

and the server MUST return an error response with **Status** set to STATUS_OBJECT_NAME_COLLISION (ERRDOS/ERRfilexists). If the underlying object store returns STATUS_ACCESS_DENIED, **Server.Statistics.sts0_permerrors** MUST be increased by 1.

If the **DirectoryName** is valid, the server MUST attempt to create the directory. Any error in creating the directory MUST be returned in an error response.

If the directory is successfully created, and if the client provided a list of Extended Attributes (EAs) in the **Trans2_Data** block of the request, the server MUST attempt to set the EAs on the newly created directory. If an error is generated when setting the EAs, the offset of the EA that caused the error relative to the start of the **ExtendedAttributeList.FEAList** MUST be returned in the **EaErrorOffset** of the response. In this case, a full response (not an error response) MUST be sent to the client. <344>

If the command is successful, **Server.Statistics.sts0_fopens** MUST be increased by 1.

3.3.5.58.11 Receiving a TRANS2_GET_DFS_REFERRAL Request

If the DFS subsystem has not indicated that it is active, the request MUST be failed with a STATUS_NO_SUCH_DEVICE error. If the **TID** in the [SMB Header \(section 2.2.3.1\)](#) does not match with the **TID** of an active connection to the IPC\$ share, the server MUST fail the request with STATUS_ACCESS_DENIED and MUST increase **Server.Statistics.sts0_permerrors** by 1. Otherwise, the CIFS server MUST pass the contents of the Trans2_Parameters data block to the DFS subsystem, as specified in [\[MS-DFSC\]](#) section 3.2.5.1.

The response returned by the DFS subsystem after it processes the request (a **RESP_GET_DFS_REFERRAL** data structure) MUST be copied into the **Trans2_Data** data block of the [TRANS2_GET_DFS_REFERRAL Response \(section 2.2.6.16.2\)](#) and returned to the client. The **TotalDataCount** field of the [SMB_COM_TRANSACTION2 Response \(section 2.2.4.46.2\)](#) MUST be set to the size in bytes of the response data block.

3.3.5.59 Receiving any SMB_COM_NT_TRANSACT Subcommand Request

The SMB_COM_NT_TRANSACT subprotocol defines a specific set of subcommands that are used to perform actions on files and file attributes. The NT Trans subcommands, as they are known, perform operations on **TIDs** and **FIDs**.

The specific NT Trans subcommand to be executed is identified by the code in the **Function** field of the [SMB_COM_NT_TRANSACT Request \(section 2.2.4.62.1\)](#).

3.3.5.59.1 Receiving an NT_TRANSACT_CREATE Request

This subcommand can be used by the client to create a new file, to open or truncate an existing file, or to create a directory. The semantics of this subcommand are similar to those of the [SMB_COM_NT_CREATE_ANDX \(section 2.2.4.64\)](#) SMB command, with the exception that [NT_TRANSACT_CREATE \(section 2.2.7.1\)](#) can be used to set security descriptors and/or extended attribute name/value pairs on the file.

If the **MaxParameterCount** field of the SMB_COM_NT_TRANSACT request contains a value that is less than the size of the NT_TRANSACT_CREATE Response as specified in section [2.2.7.1.2](#), the server MUST fail the request with STATUS_INVALID_SMB (ERRSRV/ERRerror).

Upon receipt of an NT_TRANSACT_CREATE subcommand request, the NT Trans subsystem MUST determine the pathname of the file or directory to open or create. This involves the interaction of three fields:

- If the **RootDirectoryFID** is nonzero, it represents a directory within the share represented by the **TID** specified in the [SMB Header \(section 2.2.3.1\)](#). The **Name** MUST be evaluated relative to the directory specified by **RootDirectoryFID**.
- If the **RootDirectoryFID** is zero, then the **Name** MUST be evaluated relative to the root of the share specified by the **TID**.

If **Server.EnableOplock** is TRUE, the **Flags** field in the subcommand request allows the client to ask for an exclusive or batch OpLock. The level of OpLock granted (if any) MUST be returned in the **OpLockLevel** field in the subcommand response. The **Flags** field also allows the user to request opening a directory. If the object opened is a directory, the **Directory** field of the response MUST be nonzero; a zero value (FALSE) indicates that the object is not a directory.

The **DesiredAccess** field is used to indicate the access modes that the client requests. If **DesiredAccess** is not granted in **Share.FileSecurity** for the user indicated by the **UID**, the server MUST fail the request with STATUS_ACCESS_DENIED. If the user's security context that is indicated by the **UID** does not have the appropriate privileges, the server SHOULD fail the request with STATUS_PRIVILEGE_NOT_HELD or STATUS_ACCESS_DENIED (ERRDOS/ERRnoaccess). [<345>](#) If no access is granted for the client on this file, the server MUST increase **Server.Statistics.sts0_permerrors** by 1 and MUST fail the open with STATUS_ACCESS_DENIED (ERRDOS/ERRnoaccess).

The **ImpersonationLevel** field in the request MUST be set to one of the values specified in section [2.2.7.1.1](#); otherwise, the server MUST fail the request with STATUS_BAD_IMPERSONATION_LEVEL (0xC00000A5).

If the object is a regular file and it is being created or overwritten, the **AllocationSize** indicates the number of bytes to pre-allocate.

ShareAccess provides the set of sharing modes that the client requests. If any of these sharing modes is unavailable, the server MUST fail the open with STATUS_SHARING_VIOLATION (ERRDOS/ERRbadshare).

The **CreateDisposition** field is used to determine the action the server attempts if the object already exists:

- FILE_SUPERSEDE, FILE_OVERWRITE, FILE_OVERWRITE_IF: Overwrite the file.
- FILE_OPEN, FILE_OPEN_IF: Open the existing file or directory.
- FILE_CREATE: Fail with STATUS_OBJECT_NAME_COLLISION (ERRDOS/ERRfilexists).

The **CreateDisposition** field is used to determine the action that the server attempts if the object does not already exist:

- FILE_SUPERSEDE, FILE_CREATE, FILE_OPEN_IF, FILE_OVERWRITE_IF: Create the file or directory.
- FILE_OPEN, FILE_OVERWRITE: Fail.

CreateOptions specifies the options that should be used by the server when it attempts to open or create the object. If the object is being created, **ExtFileAttributes** represents a set of requested attributes to be assigned to the object. The set of attributes actually assigned is returned to the client in the **ExtFileAttributes** field of the response.

If the open or create is successful, the server MUST apply the **SecurityDescriptor** provided in the **NT_Trans_Data** buffer of the NT_TRANSACT_CREATE Request (section 2.2.7.1.1). Likewise, the

server MUST apply the set of Extended Attribute (EA) name/value pairs provided in the request. If an error is detected while applying the EAs, the server MUST return a complete NT_TRANSACT_CREATE Response (section 2.2.7.1.2) (not an SMB error response) and MUST set the **Status** field in the SMB Header with the implementation-specific error code.

Once the file has been successfully opened, and the **SecurityDescriptor** and EAs applied, the server MUST collect additional file attribute information, including:

- The type of the object that has been opened.
- The creation, last write, last change, and last access times of the object.
- The file size and file allocation size, if the object is a file.
- The named pipe state, if the object is a named pipe.

If the NT_TRANSACT_CREATE is successful, this information, along with the **FID** that is generated by the command, MUST be placed into an NT_TRANSACT_CREATE Response (section 2.2.7.1.2) subcommand message. A new **Server.Open** object with the **PID**, **UID**, **TID** from the request header, and the new **FID** MUST be entered into the **Server.Connection.FileOpenTable**, and **Server.Statistics.sts0_fopens** MUST be increased by 1. **Server.Open.TreeConnect** MUST be set to the **TreeConnect** on which the request was performed, and **Server.Open.TreeConnect.OpenCount** MUST be increased by 1. **Server.Open.Session** MUST be set to **Server.Open.TreeConnect.Session**. **Server.Open.Connection** MUST be set to the **Server.Open.Session.Connection**. **Server.Open.Locks** MUST be set to an empty list. **Server.Open.PathName** MUST be set to the **Name** field of the request. **Server.Open.GrantedAccess** MUST be set to the **DesiredAccess** field of the request.

The server MUST register the new **FID** by invoking the event Server Registers a New Open ([\[MS-SRVS\]](#) section 3.1.6.4) and MUST assign the return value to **FileGlobalId**.

If an error is generated, other than an Extended Attribute error as specified preceding, an error response MUST be generated. The NT Trans subsystem MUST return the NT transaction response to the CIFS server for transmission to the client. [<346>](#)

3.3.5.59.2 Receiving an NT_TRANSACT_IOCTL Request

The **FunctionCode** and **FID** are taken from the [NT_TRANSACT_IOCTL \(section 2.2.7.2\)](#) subcommand request. The input to the IOCTL is contained in the **NT_Trans_Data.Data** buffer of the request. The server MUST pass the IOCTL or FSCTL request to the underlying file system. If an error is returned from the underlying file system, the server MUST NOT send an error response message. Instead, the server MUST return a complete NT_TRANSACT_IOCTL response and MUST include the error in the **Status** field of the [SMB_COM_NT_TRANSACT Response \(section 2.2.4.62.2\)](#). The server MUST return the output buffer in the **NT_Trans_Data.Data** buffer of the NT_TRANSACT_IOCTL response. [<347>](#)

3.3.5.59.3 Receiving an NT_TRANSACT_SET_SECURITY_DESC Request

Upon receipt of an [NT_TRANSACT_SET_SECURITY_DESC \(section 2.2.7.3\)](#) subcommand request, the NT Trans subsystem MUST attempt to set the security descriptors provided in the request to the file specified by the **FID**. The **SecurityDescriptor** field indicates which security descriptors are to be set.

The **FID** and **SecurityInformation** fields are passed in the **NT_Trans_Parameters** block of the request. The security descriptors are passed in the **SecurityDescriptor** array in the **NT_Trans_Data** section of the request. [<348>](#)

The response indicates either success or, if the request failed, the error that was generated.

3.3.5.59.4 Receiving an NT_TRANSACT_NOTIFY_CHANGE Request

Upon receipt of an [NT_TRANSACT_NOTIFY_CHANGE Request \(section 2.2.7.4.1\)](#), the NT Trans subsystem MUST verify the **TID** and **UID** as described in section 3.3.5.2. The server MUST perform a lookup in the **Server.Connection.FileOpenTable** to verify that the **FID**, which is passed in the **NT_Trans_Parameters** block of the request, represents an opened directory within the **TreeConnect** given by **TID**.

If the client has not issued any NT_TRANSACT_NOTIFY_CHANGE Requests on this **FID** previously, the server SHOULD allocate an empty change notification buffer and associate it with the open directory. The size of the buffer SHOULD be at least equal to the **MaxParameterCount** field in the [SMB_COM_NT_TRANSACT Request \(section 2.2.4.62.1\)](#) used to transport the NT_TRANSACT_NOTIFY_CHANGE Request. If the client previously issued an NT_TRANSACT_NOTIFY_CHANGE Request on this **FID**, the server SHOULD already have a change notification buffer associated with the **FID**. The change notification buffer is used to collect directory change information in between [NT_TRANSACT_NOTIFY_CHANGE \(section 2.2.7.4\)](#) calls that reference the same **FID**.

The **CompletionFilter** indicates the set of change events for which the client requests notification. If **WatchTree** is TRUE, all of the subdirectories below the directory specified by **FID** are also watched. If there is a change notification buffer associated with the **FID**, the changes listed in the buffer are compared against the **CompletionFilter**. If there is a match, the NT_TRANSACT_NOTIFY_CHANGE Request is complete; otherwise, the request MUST wait asynchronously until a change event occurs to complete the request.

The NT_TRANSACT_NOTIFY_CHANGE Request is entered into the **Server.Connection.PendingRequestTable**, as is any other command that is processed asynchronously by the server. The request is completed when one of the following events occurs:

- A modification matching the **CompletionFilter** occurs within the directory or directories indicated by **FID**. This is the expected completion of the request.
- The request is canceled by an [SMB_COM_NT_CANCEL Request \(section 2.2.4.65.1\)](#).
- The **FID** is closed, either by an explicit Close operation or another cause, such as an [SMB_COM_PROCESS_EXIT \(section 2.2.4.18\)](#) or [SMB_COM_TREE_DISCONNECT \(section 2.2.4.51\)](#) of the **TID** in which the directory indicated by **FID** exists.

Once the request has completed, it is removed from the **Server.Connection.PendingRequestTable**, and an [NT_TRANSACT_NOTIFY_CHANGE Response \(section 2.2.7.4.2\)](#) is composed. The response MUST contain the names of the files that changed, as well as an indication of the type of change that occurred. All changed files within the directory or directories indicated by the **FID** are returned, not just those matching **CompletionFilter**. If the operation completed because the **FID** was closed, or due to an [SMB_COM_NT_CANCEL \(section 2.2.4.65\)](#), there may be no changes listed.

Any changes that occur within the directory or directories indicated by **FID** following the completion of the NT_TRANSACT_NOTIFY_CHANGE Request are recorded in the change notification buffer on the server. This is done on the assumption that the client will reissue the NT_TRANSACT_NOTIFY_CHANGE Request upon receipt of the response. In the event that the number of changes exceeds the size of the change notify buffer, or the maximum size of the **NT_Trans_Parameter** block in the response (as indicated by the **MaxParameterCount** field in the most recent request), the NT Trans subsystem MUST return an error response with a **Status** value of STATUS_NOTIFY_ENUM_DIR (ERRDOS/ERR_NOTIFY_ENUM_DIR). This indicates to the

client that more changes have occurred on the server than the transaction has the capacity to report.

The server can also send an NT_TRANSACT_NOTIFY_CHANGE Response with a success **Status** and no changes listed (**TotalParameterCount** is zero) to cause the client to enumerate the directory and/or post a new NT_TRANSACT_NOTIFY_CHANGE Request.

If the server does not support the NT_TRANSACT_NOTIFY_CHANGE subcommand, it can return an error response with STATUS_NOT_IMPLEMENTED (ERRDOS/ERRbadfunc) in response to an NT_TRANSACT_NOTIFY_CHANGE Request. Alternatively, it can send STATUS_NOTIFY_ENUM_DIR (ERRDOS/ERR_NOTIFY_ENUM_DIR) to cause the client to enumerate the directory. <349>

3.3.5.59.5 Receiving an NT_TRANSACT_QUERY_SECURITY_DESC Request

Upon receipt of an [NT_TRANSACT_QUERY_SECURITY_DESC Request \(section 2.2.7.6.1\)](#), the NT Trans subsystem MUST query the underlying file system to retrieve the security descriptors indicated by **SecurityInfoFields** for the file indicated by **FID**. **SecurityInfoFields** and **FID** are passed in the **NT_Trans_Parameters** block of the request. <350>

If the request fails, the server MUST return an error response indicating the error that caused the failure; otherwise, the server MUST return an [NT_TRANSACT_QUERY_SECURITY_DESC Response \(section 2.2.7.6.2\)](#). The **NT_Trans_Data.SecurityInformation** field of the response contains the security descriptors retrieved from the file system.

3.3.6 Timer Events

3.3.6.1 OpLock Break Acknowledgment Timer Event

When the Oplock Break Acknowledgment timer expires, the server MUST enumerate all connections in **Server.ConnectionTable** and MUST find all **Server.Opens** in each **Server.Connection** where **Server.Open.OplockState** is **Breaking** and **Server.Open.OplockTimeout** is earlier than the current time. For each matching **Server.Open**, the server MUST acknowledge the OpLock break to the underlying object store. The server MUST set **Server.Open.Oplock** to the type of Oplock that was granted during the Oplock Break Notification, as specified in section [3.3.4.2](#), and MUST set **Server.Open.OplockState** to **None**.

If at least one **Server.Open** has a **Server.Open.OplockState** equal to **Breaking**, the [Oplock Break Acknowledgment Timer \(section 3.3.2.1\)](#) MUST be restarted to expire again at the time of the next Oplock timeout; otherwise, the Oplock Break Acknowledgment Timer MUST NOT be restarted.

3.3.6.2 Idle Connection Timer Event

The [Idle Connection Timer \(section 3.3.2.2\)](#) SHOULD periodically trigger a scan of existing SMB connections and disconnect, as specified in section [3.3.7.1](#), those on which no opens exist (**Server.Connection.FileOpenTable** and **Server.Connection.SearchOpenTable** are both empty) and no operations have been issued in the last **Server.AutoDisconnectTimeout** minutes (**Server.Connection.IdleTime** has passed). For each session in the disconnected connection, **Server.Statistics.sts0_stimedout** MUST be increased by 1.

3.3.6.3 Unused Open Search Timer Event

The [Unused Open Search Timer \(section 3.3.2.3\)](#), if implemented, SHOULD periodically trigger a scan of all open searches in existing active SMB connections and SHOULD close those open searches on which no search operations have been issued in the preceding time period specified by the value of the **Server.SrvSearchMaxTimeout** abstract data model element (section [3.3.1.1](#)).

3.3.6.4 Unused Connection Timer Event

When the [Unused Connection Timer \(section 3.3.2.4\)](#) expires, the server MUST look up all connections in global **Server.ConnectionTable**, where **Server.Connection.SessionTable** is empty and current time minus **Server.Connection.CreationTime** is more than an implementation-specific timeout, and SHOULD [<351>](#)disconnect them, as specified in section [3.3.7.1](#).

3.3.7 Other Local Events

3.3.7.1 Handling a Transport Disconnect

When the transport indicates a disconnection [<352>](#), the server MUST disconnect the **Connection** as specified in section [3.3.7.2](#).

3.3.7.2 Server Disconnects a Connection

The caller provides a **Connection** to be disconnected. The server MUST perform the following processing:

- The server MUST close the associated transport connection. [<353>](#)
- For each **Session** in **Connection.SessionTable**, the server MUST close the session as specified in section [3.3.4.8](#), providing **Session.SessionGlobalId** as the input parameter.
- For each **SearchOpen** entry in **Connection.SearchOpenTable**, the server MUST remove the **SearchOpen** entry from the **Connection.SearchOpenTable** and MUST free the **SearchOpen**.
- The server MUST invoke the event specified in [\[MS-SRVS\]](#) section 3.1.6.16 to update the connection count by providing the tuple [<Connection.TransportName, FALSE>](#).
- The **Connection** object MUST be removed from **Server.ConnectionTable** and MUST be freed.

3.3.7.3 Handling an Incoming Transport Connection

When a remote client connects, the transport invokes this event, providing a new connection. If **Server.Enabled** is FALSE, the server MUST reject the incoming connection. Otherwise, the server MUST accept the connection, and if successful, MUST invoke the processing in section [3.3.5.1](#), passing the new connection as the parameter. [<354>](#)

3.4 Local Interface Details for RPC Client Applications

The content in this section provides a unified interface for **RPC client** applications that use named pipes and other local applications that similarly employ the SMB family of protocols. Because such traffic can flow over the protocols specified in [\[MS-CIFS\]](#) and [\[MS-SMB2\]](#), these interfaces are written so that the higher-layer client application is isolated from the specifics of the underlying protocol. Implementations that support such local client applications SHOULD support one or more of the interfaces defined in this section.

This section provides an abstraction for the necessary connection establishment and negotiation operations and redirects to the equivalent higher-layer events specified in [\[MS-CIFS\]](#) and [\[MS-SMB2\]](#).

To simplify this interface, a composite structure **ClientGenericContext** is defined to encapsulate the underlying protocol and the protocol-specific client side context. The structure has the following fields:

ClientGenericContext.ProtocolDialect: The protocol dialect associated with an **open**.

ClientGenericContext.ProtocolSpecificOpen: Either the protocol-specific **Client.Open**, as specified in section [3.2.1.5](#) and in [\[MS-SMB2\]](#) section 3.2.1.6, or the protocol-specific **Client.Session**, as specified in section [3.2.1.3](#) and in [\[MS-SMB2\]](#) section [3.2.1.3](#).

This structure MUST be considered opaque to the caller.

3.4.1 Abstract Data Model

None.

3.4.2 Timers

None.

3.4.3 Initialization

None.

3.4.4 Higher-Layer Triggered Events

3.4.4.1 An RPC Client Application Opens a Named Pipe

The RPC client application provides:

- The name of the server.
- The name of the pipe.
- Credentials to be used to connect to the server.

The client MUST first connect to the server as specified in section [3.2.4.2.1](#).

Next, the client MUST negotiate the protocol by any of the methods specified in [\[MS-SMB2\]](#) section 3.2.4.2.2, initially offering the highest protocol supported by the local client implementation.

If the negotiated protocol dialect is covered in [\[MS-CIFS\]](#) or in [\[MS-SMB\]](#), the client MUST:

- Authenticate the user by invoking the processing logic specified in section [3.2.4.2.4](#), providing the credentials supplied by the caller; next, connect to the IPC\$ share by invoking the processing logic specified in [3.2.4.2.5](#).
- Open the named pipe by invoking the processing logic specified in section [3.2.4.5](#), supplying the following input parameters:
 - **Client.TreeConnect:** The **ClientGenericContext.ProtocolSpecificOpen** obtained in a preceding step.
 - Pathname: The name of the pipe supplied by the calling application.
 - **Client.Session:** The **ClientGenericContext.ProtocolSpecificOpen** obtained after the user authentication in a preceding step.
 - Access mode: Allow read and write operations.
 - Share Access: Allow read and write sharing.

- Create disposition: If the file exists, open; otherwise, fail.
- Create options: If the file is a directory, fail.
- (Optional): Return the attributes and time stamps of the file in the response: FALSE.
- (Optional): Return the total length of the file's extended attributes in the response: FALSE.
- Open parent directory: FALSE.
- Impersonation level: Impersonate.
- Security flags: zero.
- Optional allocation size: Not provided.
- Timeout: zero.
- Security descriptor: NULL
- Request for an exclusive or batch OpLock: None.

If the negotiated protocol is that specified by [MS-SMB2], the client MUST:

- Authenticate the user by invoking the processing logic specified in [\[MS-SMB2\]](#) section 3.2.4.2.3; next, connect to the IPC\$ share by invoking the processing logic specified in [\[MS-SMB2\]](#) section 3.2.4.2.4.
- Open the named pipe by invoking the processing logic specified in [\[MS-SMB2\]](#) section 3.2.4.3.1, supplying the following input parameters:
 - **Client.TreeConnect**: The **ProtocolSpecificOpen** obtained from **ClientGenericContext** in a preceding step.
 - Pathname: The name of the pipe supplied by the caller.
 - **Client.Session**: The **ProtocolSpecificOpen** obtained from **ClientGenericContext** in a preceding step.
 - Access mode: Allow read and write operations.
 - Sharing Mode: Allow read and write sharing.
 - Create disposition: If the file exists, open; otherwise, fail.
 - Create options: If the file is a directory, fail.
 - File attributes and flags: zero.
 - Impersonation level: Impersonate.
 - Security flags: zero.
 - OpLock or Lease state: None.
 - Create Contexts: None.

Any error incurred during the processing of the preceding steps MUST be returned to the caller.

Upon successful completion, a new **ClientGenericContext** structure MUST be initialized as follows and returned to the caller.

The **ClientGenericContext.ProtocolDialect** field MUST be set to an implementation-specific identifier indicating the protocol (either that specified by [MS-CIFS] or by [MS-SMB2]).

The **ClientGenericContext.ProtocolSpecificOpen** field MUST be set to the protocol-specific **Client.Open** returned from the processing logic specified in section [3.2.4.5](#) or in [\[MS-SMB2\]](#) section 3.2.4.3.1.

3.4.4.2 An RPC Client Application Writes to a Named Pipe

The caller supplies the following:

- The **ClientGenericContext** structure returned by the interface specified in section [3.4.4.1](#).
- The buffer to be written to the named pipe.

If the **ClientGenericContext.ProtocolDialect** is that specified in [MS-CIFS] or in [\[MS-SMB\]](#), the request MUST be handled as specified in section [3.2.4.15](#) with the following as input parameters:

- **Client.Open**: The **ProtocolSpecificOpen** field from the **ClientGenericContext** structure supplied by the caller.
- Offset: zero.
- A buffer supplied by the caller.
- Write-through mode: TRUE.
- Timeout: zero.

If the **ClientGenericContext.ProtocolDialect** is that specified in [\[MS-SMB2\]](#), the request MUST be handled as specified in [\[MS-SMB2\]](#) section 3.2.4.7 with the following as input parameters:

- **Open**: The **ProtocolSpecificOpen** field from the **ClientGenericContext** structure supplied by the caller.
- Offset: zero.
- The size of the caller-supplied buffer, in bytes.
- A buffer supplied by the caller.

3.4.4.3 An RPC Client Application Reads from a Named Pipe

The caller supplies the following:

- The **ClientGenericContext** structure returned by the interface specified in section [3.4.4.1](#).
- The buffer to be filled with data read from the named pipe.

If the **ClientGenericContext.ProtocolDialect** is that specified in [MS-CIFS] or in [\[MS-SMB\]](#), the request MUST be handled as specified in section [3.2.4.14](#) with the following as input parameters:

- **Client.Open**: The **ProtocolSpecificOpen** field from the **ClientGenericContext** structure supplied by the caller.

- Offset: zero.
- The size of the caller-supplied buffer, in bytes.
- The minimum number of bytes to read, which is the same as the size of the caller-supplied buffer.
- Timeout: zero.

If the **ClientGenericContext.ProtocolDialect** is that specified in [\[MS-SMB2\]](#), the request MUST be handled as specified in [\[MS-SMB2\]](#) section 3.2.4.6 with the following as input parameters:

- **Open**: The **ProtocolSpecificOpen** field from the **ClientGenericContext** structure supplied by the caller.
- Offset: zero.
- The size of the caller-supplied buffer, in bytes.
- An optional minimum number of bytes to read: Not provided.

3.4.4.4 An RPC Client Application Issues a Named Pipe Transaction

The caller supplies the following:

- The **ClientGenericContext** structure returned by the interface specified in section [3.4.4.1](#).
- The buffer to be written to the named pipe.
- The number of bytes to be read from the named pipe.

Based on the **ClientGenericContext.ProtocolDialect** field value, the request MUST be handled as specified in section [3.2.4.34](#) or in [\[MS-SMB2\]](#) section 3.2.4.20.4, providing the following input parameters:

- **Client.Open**: The **ProtocolSpecificOpen** field from the **ClientGenericContext** structure supplied by the caller.
- The size of the caller-supplied buffer, in bytes.
- A buffer supplied by the caller.
- The number of bytes to read, as supplied by the caller.

3.4.4.5 An RPC Client Application Closes a Named Pipe

The caller supplies the **ClientGenericContext** structure returned by the interface specified in section [3.4.4.1](#).

If the **ClientGenericContext.ProtocolDialect** is that specified in [MS-CIFS] or in [\[MS-SMB\]](#), the request MUST be handled as specified in section [3.2.4.7](#), with the following as input parameters:

- **Client.Open**: The **ProtocolSpecificOpen** field from the **ClientGenericContext** structure supplied by the caller.
- File creation time: zero.

If the **ClientGenericContext.ProtocolDialect** is that specified in [\[MS-SMB2\]](#), the request MUST be handled as specified in [\[MS-SMB2\]](#) section 3.2.4.5, with the following as input parameters:

- **Client.Open**: The **ProtocolSpecificOpen** field from the **ClientGenericContext** structure supplied by the caller.
- File attributes required: FALSE.

3.4.4.6 An RPC Client Application Requests the Session Key for an Authenticated Context

The caller supplies the **ClientGenericContext** structure returned by the interface specified in section [3.4.4.1](#).

Based on the **ClientGenericContext.ProtocolDialect** field value, the request MUST be handled as specified in section [3.2.4.45](#) or in [\[MS-SMB2\]](#) section 3.2.4.25, providing **ClientGenericContext.ProtocolSpecificOpen** as the input parameter.

3.4.4.7 A Local Client Application Initiates a Server Session

The local client application provides:

- The name of the server.
- Credentials to be used to connect to the server.

The client MUST first connect to the server as specified in section [3.2.4.2.1](#).

Next, the client MUST negotiate the protocol by any of the methods specified in [\[MS-SMB2\]](#) section 3.2.4.2.2, initially offering the highest protocol supported by the local client implementation.

If the negotiated protocol dialect is covered in [\[MS-CIFS\]](#) or in [\[MS-SMB\]](#), the client MUST:

- Authenticate the user by invoking the processing logic specified in section [3.2.4.2.4](#), providing the credentials supplied by the caller; next, the client MUST connect to the IPC\$ share by invoking the processing logic specified in section [3.2.4.2.5](#)

Any error incurred during the processing of the preceding steps MUST be returned to the caller.

Upon successful completion, a new **ClientGenericContext** structure MUST be initialized as follows and returned to the caller.

The **ClientGenericContext.ProtocolDialect** field MUST be set to an implementation-specific identifier indicating the protocol (either that specified by [\[MS-CIFS\]](#) or by [\[MS-SMB2\]](#)).

The **ClientGenericContext.ProtocolSpecificOpen** field MUST be set to the protocol-specific **Client.Session** obtained by the processing logic specified in section [3.2.4.2.4](#).

3.4.4.8 A Local Client Application Terminates a Server Session

The caller supplies the **ClientGenericContext** structure returned by the interface specified in [\[MS-CIFS\]](#) section 3.4.4.7.

Based on the **ClientGenericContext.ProtocolDialect** field value, the session represented by the **ClientGenericContext.ProtocolSpecificOpen** MUST be closed as specified in section [3.2.4.25](#) or in [\[MS-SMB\]](#) section 3.2.4.23.

3.4.4.9 A Local Client Application Queries DFS Referrals

The local client application provides:

- **ClientGenericContext:** An opaque blob encapsulating the underlying protocol and the protocol-specific client side context.
- **ServerName:** The name of the server from which to query referrals.
- **UserCredentials:** An opaque implementation-specific entity that contains the credentials to be used when authenticating to the remote server.
- **MaxOutputSize:** The maximum output buffer response size, in bytes.
- An input buffer containing the application-provided **REQ_GET_DFS_REFERRAL** or **REQ_GET_DFS_REFERRAL_EX** structure.
- FSCTL Code

If **ClientGenericContext.ProtocolSpecificOpen.Connection.ServerCapabilities** does not have the CAP_DFS flag set, the client SHOULD [<355>](#) return STATUS_DFS_UNAVAILABLE to the caller.

If **ClientGenericContext.ProtocolDialect** indicates the CIFS or the SMB protocol, the client MUST invoke the [Application Requests Querying DFS Referrals \(section 3.2.4.44\)](#) event, providing **ServerName**, **UserCredentials**, **MaxOutputSize**, and the input buffer as the parameters.

If the Application Requests Querying DFS Referrals event returns success, the client MUST return the **RESP_GET_DFS_REFERRAL** structure from the **Trans2_Data** block of the [TRANS2_GET_DFS_REFERRAL Response \(section 2.2.6.16.2\)](#) and MUST return success to the calling application; otherwise, the client MUST return the status code received from the event.

If **ClientGenericContext.ProtocolDialect** indicates the SMB2 protocol, the client MUST invoke the [Application Requests DFS Referral Information \(\[MS-SMB2\] section 3.2.4.20.3\)](#) event, providing **ServerName**, **UserCredentials**, **MaxOutputSize**, input buffer, and an FSCTL code as the parameters.

If the Application Requests DFS Referral Information event returns success, the client MUST return the buffer ([\[MS-SMB2\] section 3.2.5.14.4](#)) received from the server and MUST return success to the calling application; otherwise, the client MUST return the status code received from the event.

3.4.4.10 A Local Client Application Requests a Connection to a Share

The RPC client application provides:

- The name of the server.
- The name of the share.
- Credentials to be used to connect to the server.

The client MUST first connect to the server as specified in section [3.2.4.2.1](#).

Next, the client MUST negotiate the protocol by any of the methods specified in [\[MS-SMB2\] section 3.2.4.2.2](#), initially offering the highest protocol supported by the local client implementation.

If the negotiated protocol dialect is covered in [MS-CIFS] or in [\[MS-SMB\]](#), the client MUST authenticate the user by invoking the processing logic specified in section [3.2.4.2.4](#); next, the client

MUST connect to the application-supplied share by invoking the processing logic specified in section [3.2.4.2.5](#).

If the negotiated protocol is that specified by [MS-SMB2], the client MUST authenticate the user by invoking the processing logic specified in [\[MS-SMB2\]](#) section 3.2.4.2.3, providing the credentials supplied by the caller; next, the client MUST connect to the application-supplied share by invoking the processing logic specified in [\[MS-SMB2\]](#) section 3.2.4.2.4.

Any error incurred during the processing of the preceding steps MUST be returned to the caller.

Upon successful completion, a new **ClientGenericContext** structure and **ShareType** MUST be initialized.

The **ClientGenericContext.ProtocolDialect** field MUST be set to an implementation-specific identifier indicating the protocol (either that specified by [MS-CIFS] or that specified by [MS-SMB2]).

The **ClientGenericContext.ProtocolSpecificOpen** field MUST be set to the protocol-specific **Client.TreeConnect** obtained by the processing logic specified in section [3.2.5.4](#) or in [\[MS-SMB2\]](#) section 3.2.4.2.4.

ShareType MUST be set to the share type obtained by the processing logic specified in section [3.2.5.4](#) or in [\[MS-SMB2\]](#) section 3.2.4.2.4.

ClientGenericContext and **ShareType** MUST be returned to the caller.

3.4.4.11 A Local Client Application Requests a Tree Disconnect

The caller supplies the **ClientGenericContext** structure returned by the interface specified in section [3.4.4.10](#) and the optional *ForceLevel* to disconnect the connection.

If the *ForceLevel* value is 0x00000002, then based on the **ClientGenericContext.ProtocolDialect** field value and the tree connect represented by the **ClientGenericContext.ProtocolSpecificOpen**, the client MUST invoke the event specified in section [3.2.4.24](#) or in [\[MS-SMB2\]](#) section 3.2.4.22 and disconnect the tree connection.

If the *ForceLevel* value is 0x00000000 or 0x00000001, then based on the **ClientGenericContext.ProtocolDialect** field value and the tree connect represented by the **ClientGenericContext.ProtocolSpecificOpen**, the client MUST invoke the event specified in section [3.2.4.46](#) or in [\[MS-SMB2\]](#) section 3.2.4.26 for number of open files on the tree connect.

- If the number of open files on the connection is equal to zero, based on the **ClientGenericContext.ProtocolDialect** field value and the tree connect represented by the **ClientGenericContext.ProtocolSpecificOpen**, the client MUST invoke the event specified in section [3.2.4.24](#) or in [\[MS-SMB2\]](#) section 3.2.4.22 and disconnect the tree connection.
- Otherwise, the server MUST fail the call with an implementation-specific error code.

3.4.4.12 A Local Client Application Queries the Extended DFS Referral Capability

This is an optional interface to be implemented by the client.

The caller supplies the **ClientGenericContext** structure returned by the interface specified in section [3.4.4.7](#).

If **ClientGenericContext.ProtocolDialect** indicates the CIFS or the SMB protocol, or either of SMB2 dialects 2.002 or 2.100, the client MUST return FALSE; otherwise, it MUST return TRUE.

3.4.5 Message Processing Events and Sequencing Rules

None.

3.4.6 Timer Events

None.

3.4.7 Other Local Events

None.

3.5 Local Interface Details for RPC Server Applications

The content in this section provides a unified interface for **RPC server** applications that use named pipes over the SMB family of protocols. Because named pipe traffic can flow over the protocols specified in [MS-CIFS] or [MS-SMB2], these interfaces are written so that the higher-layer RPC server application is isolated from the specifics of the underlying protocol. Implementations that support RPC server applications SHOULD support the interfaces defined in this section.

This section provides a protocol-independent abstraction for RPC servers running over named pipes. It does not introduce any new semantics or state to the protocol specified in [MS-CIFS].

To simplify this interface, a composite structure **RPCServerGenericNamedPipeOpen** is defined to encapsulate the underlying protocol and the protocol-specific server side open to a named pipe. The structure has the following fields:

RPCServerGenericNamedPipeOpen.ProtocolDialect: The protocol dialect associated with the open.

RPCServerGenericNamedPipeOpen.ProtocolSpecificOpen: The protocol-specific **Server.Open**, as specified in section 3.3.1.7 and in [MS-SMB2] section 3.3.1.10.

This structure MUST be considered opaque to the caller.

3.5.1 Abstract Data Model

None.

3.5.2 Timers

None.

3.5.3 Initialization

None.

3.5.4 Higher-Layer Triggered Events

3.5.4.1 An RPC Server Application Waits for Clients to Open a Named Pipe

The RPC application provides:

- The name of the pipe.

The server MUST wait on the underlying named pipe object store for clients to open the specified named pipe. When a client opens the pipe as specified in sections [3.3.5.5](#), [3.3.5.35](#) or [3.3.5.51](#), or in [\[MS-SMB2\]](#) section 3.3.5.9, the server MUST initialize a new **RPCServerGenericNamedPipeOpen** structure as follows:

The **RPCServerGenericNamedPipeOpen.ProtocolDialect** field MUST be set to an implementation-specific identifier indicating the protocol (either that specified by [MS-CIFS] or by [MS-SMB2]) on which the client opened the pipe. The value derived from **Connection.NegotiateDialect** specified in [\[MS-SMB2\]](#) section 3.3.1.7 or from **Server.Connection.SelectedDialect** specified in section [3.3.1.3](#) can be used as a protocol identifier.

The **RPCServerGenericNamedPipeOpen.ProtocolSpecificOpen** field MUST be set to the protocol-specific **Server.Open** constructed as specified in sections [3.3.5.6](#) or [3.3.5.51](#), or in [\[MS-SMB2\]](#) section 3.3.5.9.

The server MUST return the newly-constructed **RPCServerGenericNamedPipeOpen** structure to the caller.

3.5.4.2 An RPC Server Application Closes its Open to a Named Pipe

The caller supplies the **RPCServerGenericNamedPipeOpen** structure returned by the interface specified in section [3.5.4.1](#).

The server MUST call into the underlying object store to close the named pipe identified by the **RPCServerGenericNamedPipeOpen.ProtocolSpecificOpen** field.

3.5.4.3 An RPC Server Application Requests the Security Context of a Client

The caller supplies the **RPCServerGenericNamedPipeOpen** structure returned by the interface specified in section [3.5.4.1](#).

Based on the value of the **RPCServerGenericNamedPipeOpen.ProtocolDialect** field, the request MUST be handled as specified in section [3.3.4.7](#) or in [\[MS-SMB2\]](#) section 3.3.4.10.

3.5.4.4 An RPC Server Application Requests the Session Key of a Client

The caller supplies the **RPCServerGenericNamedPipeOpen** structure returned by the interface specified in section [3.5.4.1](#).

Based on the value of the **RPCServerGenericNamedPipeOpen.ProtocolDialect** field, the request MUST be handled as specified in section [3.3.4.6](#) or in [\[MS-SMB2\]](#) section 3.3.4.5.

3.5.5 Message Processing Events and Sequencing Rules

None.

3.5.6 Timer Events

None.

3.5.7 Other Local Events

None.

4 Protocol Examples

The following sections describe common scenarios that indicate normal traffic flow on the wire in order to illustrate the function of the CIFS Protocol.

4.1 Negotiate and Tree Connect Example

This example illustrates a simple scenario of protocol negotiation and connecting to a share.

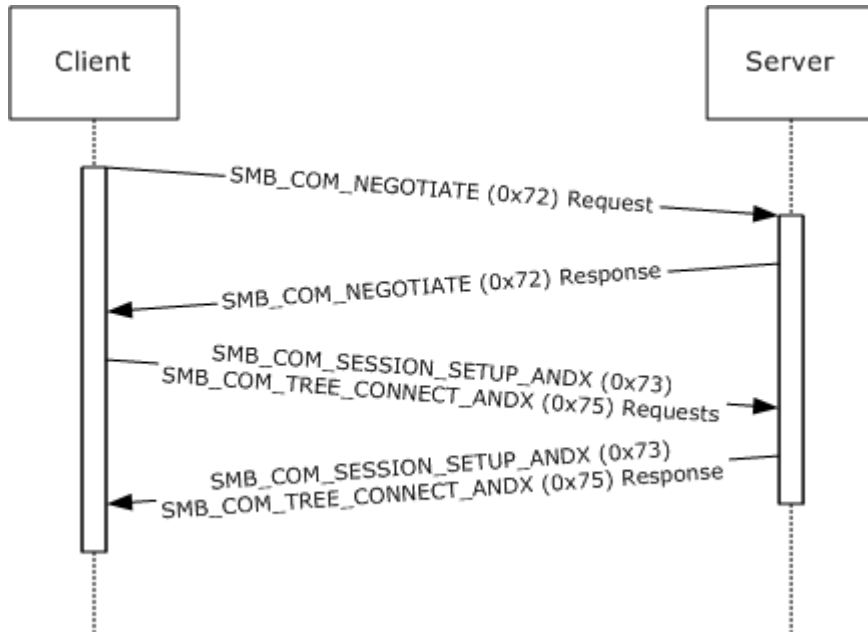

Figure 10: Protocol negotiation and connecting to a share

This capture was produced by mapping a drive letter on a Microsoft Windows 98 operating system client to a share served by Windows NT Server 4.0 operating system Service Pack 6a (SP6a). The content was produced by executing the following command at an MS-DOS prompt on a Windows 98 client:

```
C:\> net use y: \\10.9.9.47\testshare1
```

4.2 Disconnect Example

This example illustrates a client disconnecting from a share. An SMB connection and an SMB session are already assumed to have been successfully completed.

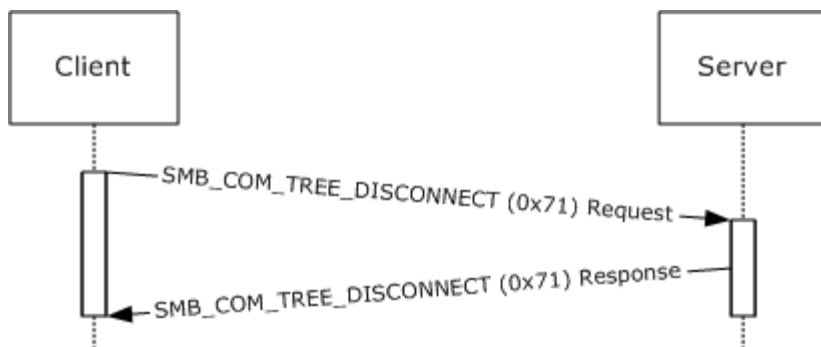

Figure 11: Disconnecting from a share

The share used here was served from Windows NT Server 4.0 operating system Service Pack 6a (SP6a). It was mapped as drive Y: on a Microsoft Windows 98 operating system client.

The user operation performed was:

```
C:\> net use y: /d
```

4.3 Message Signing Example

This example illustrates the use of the CIFS message signing capability when connecting to a share.

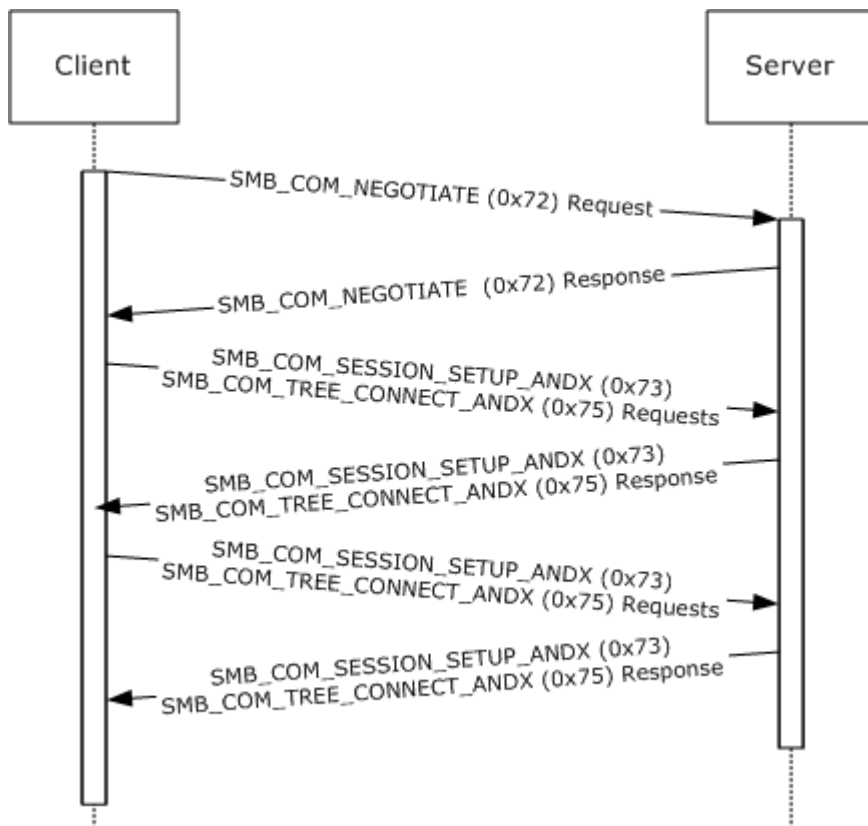

Figure 12: Message signing when connecting to a share

The example is a result of configuring a server running Windows NT Server 4.0 operating system Service Pack 6a (SP6a) both to allow and require message signing (see [\[ENSIGN\]](#) for information on configuring the registry for this feature), and likewise configuring a Windows NT Workstation 4.0 operating system Service Pack 6a (SP6a) client for message signing. A share from the server was then mapped to a drive letter on the client machine:

```
C:\> net use y: \\10.9.9.47\testshare1
```

FRAME 1. The first step is the negotiation request. This is the usual offer of dialects and exchange of the **Flags** and **Flags2** fields in the [SMB Header \(section 2.2.3.1\)](#) of the [SMB_COM_NEGOTIATE Request \(section 2.2.4.52.1\)](#). The `SMB_FLAGS2_SMB_SECURITY_SIGNATURE` bit in the **Flags2** field is cleared, and the **SecuritySignature** field is set to 0x0000000000000000. No security signature is generated at this stage.

FRAME 2. The negotiate response has the `SMB_FLAGS2_SMB_SECURITY_SIGNATURE` bit in the **Flags2** field cleared, and the **SecuritySignature** field is set to 0x0000000000000000. No signature is generated at this stage.

FRAME 3. The next exchange takes advantage of ANDX message batching. Two requests are sent together; the first [SMB_COM_SESSION_SETUP_ANDX Request \(section 2.2.4.53.1\)](#) is sent along with an [SMB_COM_TREE_CONNECT_ANDX Request \(section 2.2.4.55.1\)](#). The `SMB_FLAGS2_SMB_SECURITY_SIGNATURE` bit in the **Flags2** field is cleared in this request, and the **SecuritySignature** field is set to 0x0000000000000000. The tree connect attempt is to IPC\$.

FRAME 4. The ANDX response contains a **SecuritySignature** field set to 0x0000000000000000, and the `SMB_FLAGS2_SMB_SECURITY_SIGNATURE` bit in the **Flags2** field bit is cleared.

FRAME 5. Next, another ANDX request consisting of an `SMB_COM_SESSION_SETUP_ANDX` Request and another `SMB_COM_TREE_CONNECT_ANDX` Request is sent. This is the attempt to connect to the share.

FRAME 6. Note that this time, the `SMB_FLAGS2_SMB_SECURITY_SIGNATURE` bit in the **Flags2** field is set, and the **SecuritySignature** field contains a valid signature. From this point on, all messages will be signed.

4.4 Get File Attributes Example

This example illustrates the process of getting the attributes information from a file. An SMB connection and an SMB session are already assumed to have been successfully completed.

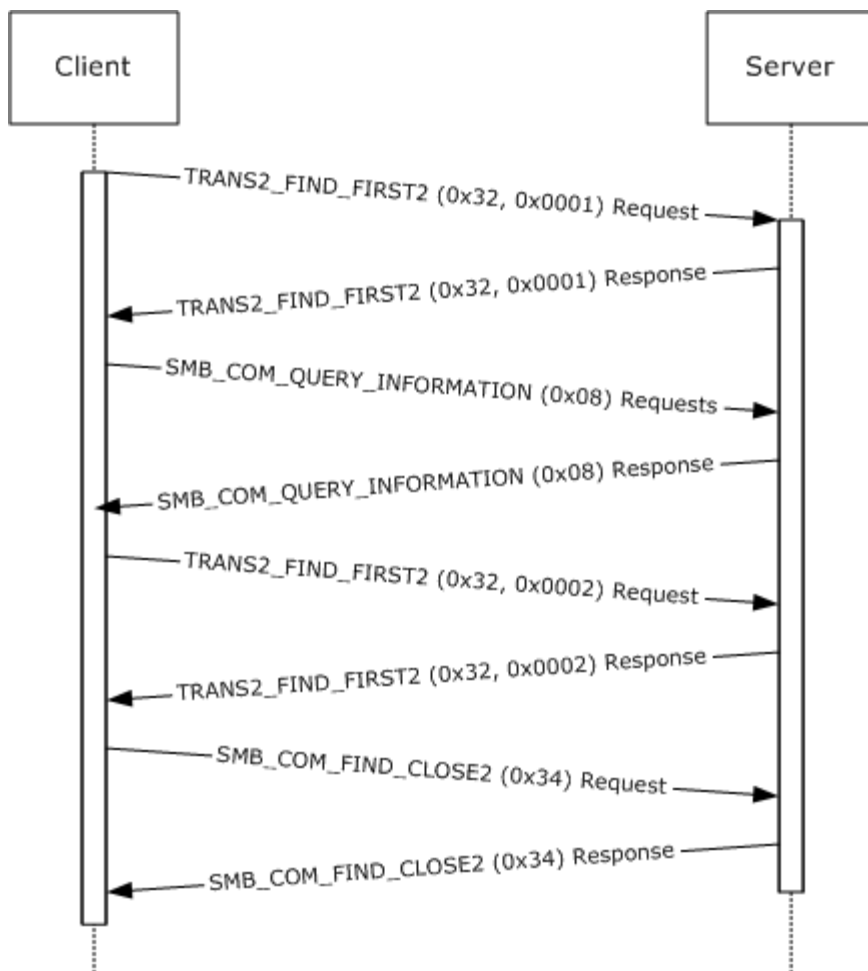

Figure 13: Getting file attributes information

The share used here was served from Windows NT Server 4.0 operating system Service Pack 6a (SP6a). It was mapped as drive Y: on a Microsoft Windows 98 operating system client. The following operation was performed in an MS-DOS window:

```
C:\> attrib y:\text.txt
```

4.5 Set File Attributes Example

This example illustrates the process of setting attribute information for a file. An SMB connection and an SMB session are already assumed to have been successfully completed.

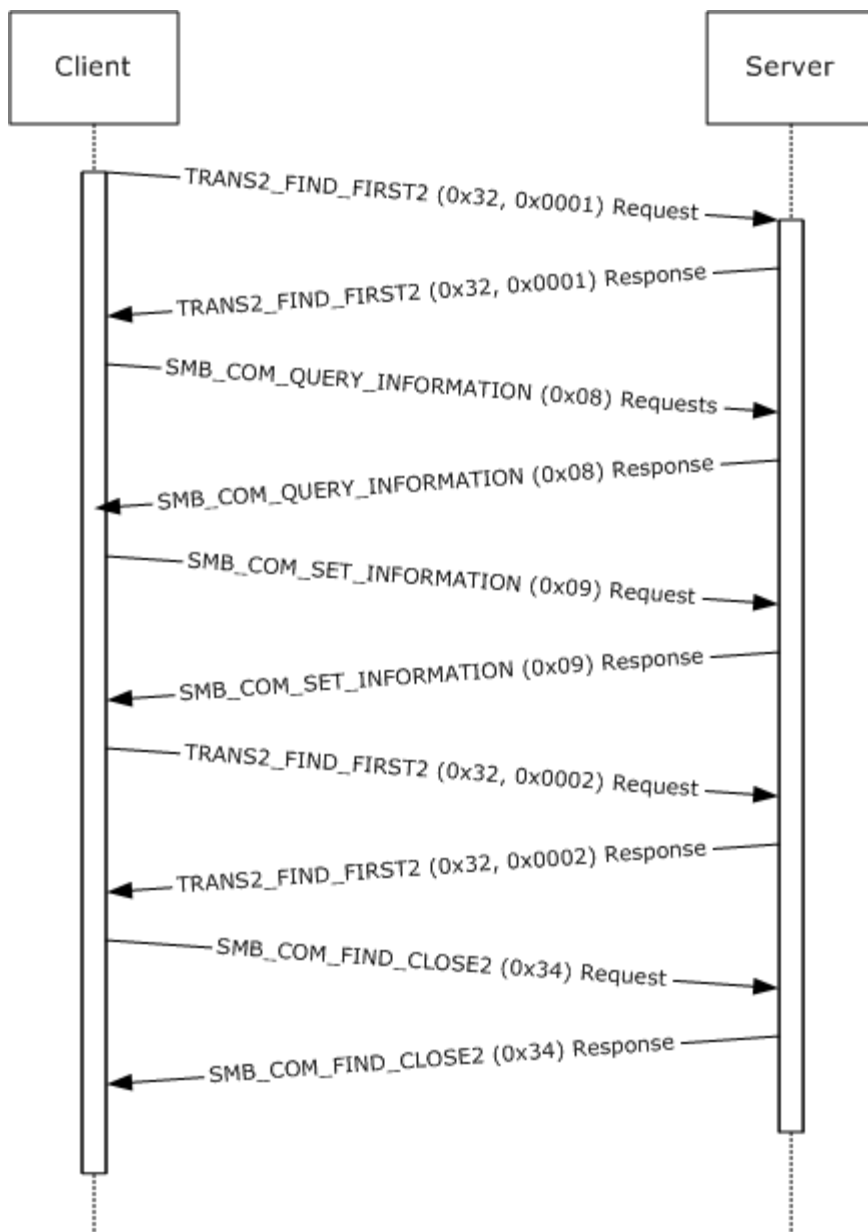

Figure 14: Setting file attribute information

The share used here was served from Windows NT Server 4.0 operating system Service Pack 6a (SP6a). It was mapped as drive Y: on a Microsoft Windows 98 operating system client. The operation performed was in an MS-DOS window:

```
C:\> attrib +r y:\text.txt
```

4.6 Copy File from Share Example

This example illustrates the process of copying a file from a share to a client (downloading). An SMB connection and an SMB session are already assumed to have been successfully completed.

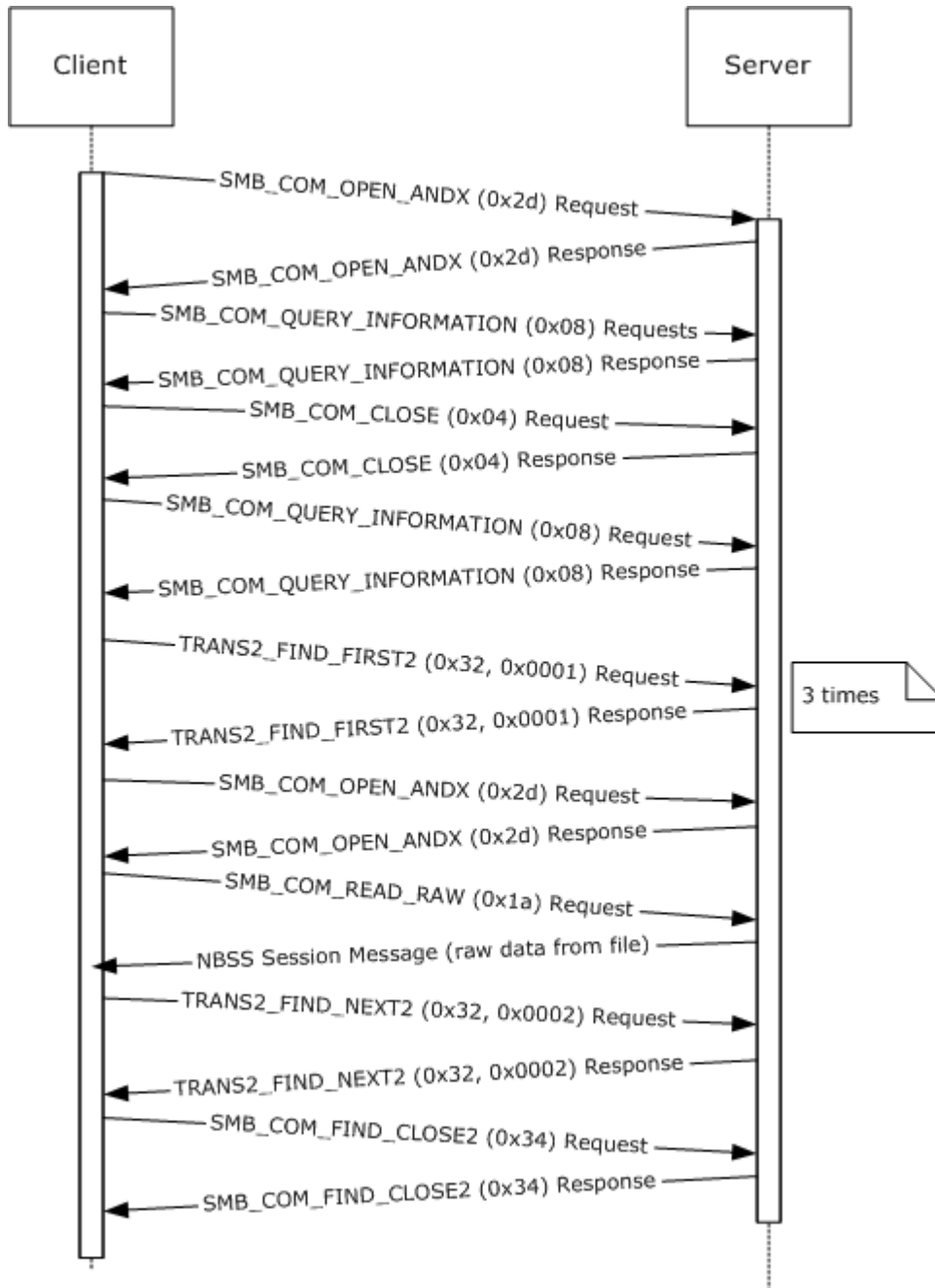

Figure 15: Command to copy y:\text.txt to the current directory

The share used here was served from Windows NT Server 4.0 operating system Service Pack 6a (SP6a). It was mapped as drive Y: on a Microsoft Windows 98 operating system client. The operation performed was in an MS-DOS window.

```
C:\> copy y:\text.txt .
```

4.7 Copy File to Share Example

This example illustrates the process of copying a file from the client to a share (uploading). An SMB connection and an SMB session are already assumed to have been successfully completed.

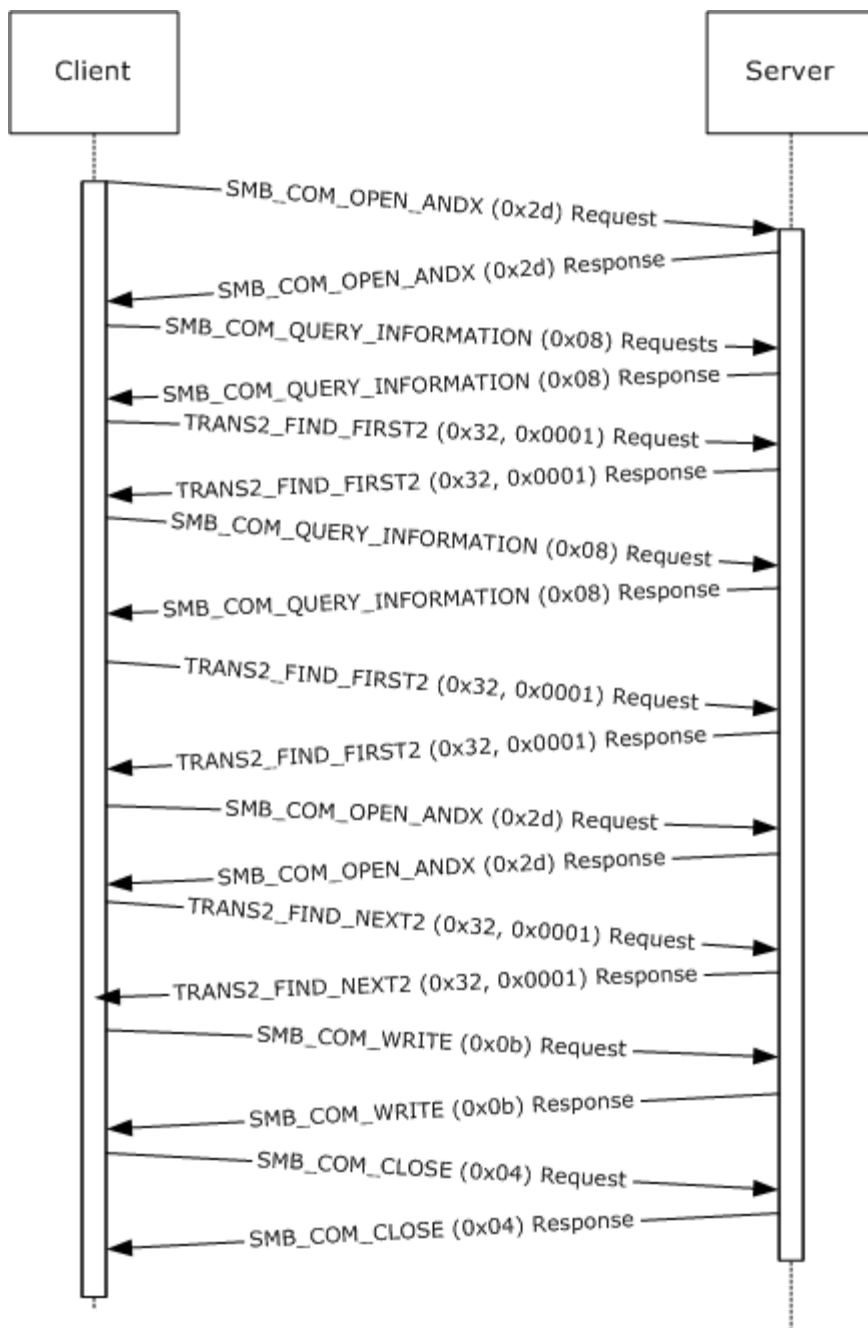

Figure 16: Copying a file from a client to a share

The share used here was served from Windows NT Server 4.0 operating system Service Pack 6a (SP6a). It was mapped as drive Y: on a Microsoft Windows 98 operating system client. The operation performed was in an MS-DOS window:

```
C:\> copy text.txt y:\text.txt
```

5 Security

The following sections specify security considerations for implementers of the CIFS Protocol.

5.1 Security Considerations for Implementers

A CIFS server can permit anonymous or guest account logons. Such unauthenticated logons can provide access to services that need to be protected, and that can potentially expose vulnerabilities in the implementation. [<356>](#)

Share level access control passwords are transmitted in plaintext. The server can also indicate that it requires plaintext user level authentication. A "man-in-the-middle" attack can be used to clear the bit in the SMB_COM_NEGOTIATE response that indicates that the server supports challenge/response authentication, thus causing the client to assume that plaintext authentication is required. [<357>](#)

Several weaknesses in the LAN Manager (LM) challenge/response authentication scheme have been discovered and published. CIFS usage of LM challenge/response is specified in section [3.1.5.2](#).

Neither the LM nor the NTLM challenge/response algorithm includes a client nonce. A client nonce is used to protect against dictionary attacks by rogue servers. The LMv2 and NTLMv2 challenge/response algorithms do include a client nonce.

Message signing is optional. Message signing is used to prevent connection hijacking.

The protocol does not sign OpLock break requests from the server to the client if message signing is enabled. This can allow an attacker to affect performance but does not allow an attacker to deny access or alter data.

The algorithm used for message signing has been shown to be subject to collision attacks. For more information, see [\[MD5Collision\]](#).

The protocol does not encrypt the data that is exchanged. To provide stricter data security, the underlying transport provides encryption. Otherwise, a different protocol is more applicable.

5.2 Index of Security Parameters

Security Parameter	Section
Unauthenticated clients (anonymous and guest access)	3.2.4.2.3
Share versus user access control	3.2.4.2.4
Plain Text Authentication	3.2.4.2.3
Challenge Response	3.2.4.2.2
Message Signing	3.1.4.1

6 Appendix A: Product Behavior

The information in this specification is applicable to the following Microsoft products or supplemental software. References to product versions include released service packs:

- Windows NT Server 3.51 operating system
- Windows NT Server 4.0 operating system
- Windows NT Workstation 4.0 operating system
- Microsoft Windows 98 operating system
- Windows 98 operating system Second Edition

Exceptions, if any, are noted below. If a service pack or Quick Fix Engineering (QFE) number appears with the product version, behavior changed in that service pack or QFE. The new behavior also applies to subsequent service packs of the product unless otherwise specified. If a product edition appears with the product version, behavior is different in that product edition.

Unless otherwise specified, any statement of optional behavior in this specification that is prescribed using the terms SHOULD or SHOULD NOT implies product behavior in accordance with the SHOULD or SHOULD NOT prescription. Unless otherwise specified, the term MAY implies that the product does not follow the prescription.

[<1> Section 2.1:](#) On Windows, SMB transports are supported as TDI Transport Drivers, as described in [\[MSDN-TrnspDrvIntfc\]](#).

[<2> Section 2.1.1:](#) On MS-DOS, OS/2, and Windows systems, NetBIOS presents a common API. The CIFS implementations on these platforms are written to use the NetBIOS API, which makes it possible to interchange NetBIOS-based transports without modifying the CIFS implementation itself. Implementation of the NetBIOS API is not necessary for CIFS interoperability.

[<3> Section 2.1.1:](#) Windows NT Server drops the transport connection and does not return an error message response with an SMB error class of ERRCMD (0xFF).

[<4> Section 2.1.1.2:](#) The Windows NT implementation of the NetBIOS Name Service for NBT is known as the Windows Internet Name Service (WINS). The Windows NT implementation of the NetBIOS Name Server (NBNS) is known as a WINS server.

Microsoft's implementation of NBT for Windows NT and Windows 98 diverges from the standard specified in [\[RFC1001\]](#) and [\[RFC1002\]](#). There are several modifications and additions to the prescribed behavior of the name service, and the implementation of the datagram service is incomplete. See [\[IMPCIFS\]](#) for a discussion of some of these variations. Windows-specific extensions to NBT are documented in [\[MS-NBTE\]](#).

[<5> Section 2.1.2:](#) Direct TCP Transport is probably the best-known example of direct hosting. Direct TCP Transport is described in [\[MS-SMB\]](#). CIFS does not support Direct TCP Transport, because it was developed for Windows 2000 and is not supported on Windows NT or Windows 98.

[<6> Section 2.1.2.1:](#) The recommended maximum interval between SMB requests is four (4) minutes. Windows NT Server 4.0 has a default time-out value of 15 minutes.

[<7> Section 2.1.3:](#) Windows NT Server 4.0 always sends a zero value for **SessionKey**.

<8> [Section 2.1.3](#): Windows-based CIFS servers set **MaxNumberVcs** in the server's SMB_COM_NEGOTIATE response to 0x0001, but do not enforce this limit. This allows a CIFS client to establish more virtual circuits than allowed by this value.

<9> [Section 2.1.3](#): Windows NT Server does disconnect all existing transport-level connections from a client when it receives a new SMB_COM_SESSION_SETUP_ANDX request from that client with a **VcNumber** value of zero.

<10> [Section 2.2.1.1.3](#): CIFS wildcard characters are based on Windows wildcard characters, as described in [\[MS-FSA\]](#) section 2.1.4.4, Algorithm for Determining if a FileName Is in an Expression. For more information on wildcard behavior in Windows, see [\[FSBO\]](#) section 7.

<11> [Section 2.2.1.2.1.1](#): Windows clients include both the size of the **SizeOfListInBytes** field and the total size of the **GEAList** field when calculating the value passed in the **SizeOfListInBytes** field for compatibility with dialects less than the LAN Manager 1.2 dialect, as implemented in OS/2 v1.2. See [\[XOPEN-SMB\]](#) sections 4.3.7 and 16.1.5 for more information.

<12> [Section 2.2.1.2.2](#): The [SMB_FEA \(section 2.2.1.2.2\)](#) structure originated with the LANMAN1.2 dialect and is, therefore, used in Trans2 calls, the majority of which also originated in the LANMAN1.2 dialect. See [\[XOPEN-SMB\]](#) section 16.1.5 for a detailed description of the [SMB_FEA](#) structure. NT_TRANSACT_CREATE makes use of the [FILE_FULL_EA_INFORMATION](#) structure, which is similar to [SMB_FEA](#). See [\[MS-FSCC\]](#) for information on the [FILE_FULL_EA_INFORMATION](#) structure.

<13> [Section 2.2.1.2.2.1](#): Windows clients include both the size of the **SizeOfListInBytes** field and the total size of the **FEAList** field when calculating the value passed in the **SizeOfListInBytes** field. This is required for compatibility with dialects less than the LAN Manager 1.2 dialect, as implemented in OS/2 v1.2. See [\[XOPEN-SMB\]](#) sections 4.3.7 and 16.1.5 for more information.

<14> [Section 2.2.1.2.3](#): The file attributes encoded in the [SMB_EXT_FILE_ATTR \(section 2.2.1.2.3\)](#) data type are based on the native Windows file attributes described in [\[MS-FSCC\]](#) section 2.6 and listed in [\[MSDN-CreateFile\]](#). The following table provides a mapping between the file attributes presented in this document and those in [\[MS-FSCC\]](#), as well as unsupported values and values unique to this document.

Name or Status in [MS-CIFS]	Name or Status in [MS-FSCC]
ATTR_READONLY	FILE_ATTRIBUTE_READONLY
ATTR_HIDDEN	FILE_ATTRIBUTE_HIDDEN
ATTR_SYSTEM	FILE_ATTRIBUTE_SYSTEM
ATTR_DIRECTORY	FILE_ATTRIBUTE_DIRECTORY
ATTR_ARCHIVE	FILE_ATTRIBUTE_ARCHIVE
ATTR_NORMAL	FILE_ATTRIBUTE_NORMAL
ATTR_TEMPORARY	FILE_ATTRIBUTE_TEMPORARY
Not Supported in CIFS	FILE_ATTRIBUTE_SPARSE_FILE
Not Supported in CIFS	FILE_ATTRIBUTE_REPARSE_POINT
ATTR_COMPRESSED	FILE_ATTRIBUTE_COMPRESSED
Not Supported in CIFS	FILE_ATTRIBUTE_OFFLINE

Name or Status in [MS-CIFS]	Name or Status in [MS-FSCC]
Not Supported in CIFS	FILE_ATTRIBUTE_NOT_CONTENT_INDEXED
Not Supported in CIFS	FILE_ATTRIBUTE_ENCRYPTED
POSIX_SEMANTICS	Unique to CIFS/SMB
BACKUP_SEMANTICS	Unique to CIFS/SMB
DELETE_ON_CLOSE	Unique to CIFS/SMB
SEQUENTIAL_SCAN	Unique to CIFS/SMB
RANDOM_ACCESS	Unique to CIFS/SMB
NO_BUFFERING	Unique to CIFS/SMB
WRITE_THROUGH	Unique to CIFS/SMB

<15> [Section 2.2.1.2.3](#): Use care when using this option because files created with this flag might not be accessible by applications written for MS-DOS, Windows 3.0, Windows NT 3.1, or Windows NT.

<16> [Section 2.2.1.2.3](#): Windows uses this flag to optimize file caching. If an application moves the file pointer for random access, optimum caching might not occur; however, correct operation is still guaranteed. Specifying this flag can increase performance for applications that read large files using sequential access. Performance gains can be even more noticeable for applications that read large files mostly sequentially, but occasionally skip over small ranges of bytes.

<17> [Section 2.2.1.4.1](#): The maximum value permitted in the **SMB_DATE.YEAR** field is 119, resulting in a year range of 1980 to 2099.

<18> [Section 2.2.1.5](#): Windows NT Server identifies these error codes as 32-bit values by leaving the **SMB_FLAGS2_NT_STATUS** bit set in the response to a request that also had the **SMB_FLAGS2_NT_STATUS** bit set.

<19> [Section 2.2.1.6](#): Windows-based clients set the **PID** to the process identifier of the actual calling process for the following commands. For all other commands, Windows-based clients set the **PID** value to 0x0000FEFF.

- **SMB_COM_NT_CREATE_ANDX** (0xA2)
- **SMB_COM_OPEN_PRINT_FILE** (0xC0)
- All subcommands of **SMB_COM_TRANSACTION** (0x25) and **SMB_COM_TRANSACTION_SECONDARY** (0x26) except **TRANS_MAILSLLOT_WRITE**, if **Client.Connection.ServerCapabilities** includes **CAP_NT_SMBS**.
- All subcommands of **SMB_COM_TRANSACTION2** (0x32) and **SMB_COM_TRANSACTION2_SECONDARY** (0x33), if **Client.Connection.ServerCapabilities** includes **CAP_NT_SMBS**.

<20> [Section 2.2.1.6.6](#): Windows NT Server always returns 0x00000000 and ignores the **SessionKey** when it is sent by the client in an [SMB_COM_SESSION_SETUP_ANDX Request \(section 2.2.4.53.1\)](#).

<21> [Section 2.2.1.6.8](#): Windows NT Server uses this value internally as part of its list management mechanism.

<22> [Section 2.2.2.3.3](#): Windows NT always returns this string in Unicode-encoded format.

<23> [Section 2.2.2.4](#): Windows NT Server returns this error code if at least one command parameter fails validation tests such as a field value being out of range or fields within a command being internally inconsistent.

<24> [Section 2.2.2.4](#): This error code is defined as ERRInvtid in Windows 98. Windows NT uses a completely different naming style.

<25> [Section 2.2.2.4](#): Windows NT Server defines this class but does not return it. Windows NT client does not test for the ERRCMD class. In many instances, Windows-based servers close transport level connections if the incoming messages cannot be parsed.

<26> [Section 2.2.3.1](#): This bit is ignored by Windows systems, which always handle pathnames as case-insensitive.

<27> [Section 2.2.3.1](#): If CAP_STATUS32 has been negotiated during the SMB connection, Windows servers ignore the value of the SMB_FLAGS2_NT_STATUS bit in client requests. If the **Status** field value to be returned in the header is STATUS_SUCCESS, Windows servers copy the value of the SMB_FLAGS2_NT_STATUS bit from the client request into the server response.

If CAP_STATUS32 has been negotiated and an error is returned and SMB_FLAGS2_NT_STATUS is not set in the request, the value of the SMB_FLAGS2_NT_STATUS bit and the format of the **Status** field in the header in the server response is undefined.

<28> [Section 2.2.4.3.1](#): Windows NT Server always ignores the **SearchAttributes** field on Open and Create operations, and searches for files by name only.

<29> [Section 2.2.4.15.2](#): Windows NT server temporary file names begin with "SRV" and are followed by the character equivalents of five (5) random hexadecimal digits (0-F). There is no extension set for the file name. The client is responsible for deleting the temporary file when it is no longer needed.

<30> [Section 2.2.4.19.1](#): Windows NT server behavior is determined by the negotiated protocol dialect. Clients that negotiate **Core Protocol** can use a negative value in the **Offset** field to position the file pointer to the beginning of the file (BOF). Clients negotiating other protocol dialects receive an error if they supply a negative value in the **Offset** field.

<31> [Section 2.2.4.19.2](#): Windows NT does not check for overflow conditions. It allows the file pointer that is maintained by the server to "wrap around".

<32> [Section 2.2.4.23](#): Windows NT clients and Windows NT servers support this command on connection-oriented transports. This command does not support named pipes or I/O devices.

Windows does not support the **Timeout** field.

<33> [Section 2.2.4.24](#): Windows NT servers return STATUS_SMB_BAD_COMMAND (ERRSRV/ERRbadcmd).

<34> [Section 2.2.4.25.2](#): Windows NT servers always set **Available** to 0xFFFF.

<35> [Section 2.2.4.26](#): Windows systems support this command only over connectionless transports. Consequently, Windows 98 and Windows NT clients and all clients connected to Windows NT servers set the 0x08 bit of the **WriteMode** field in the request. Windows NT servers

support Write MPX only to regular files or spooled printer files. This command does not support writing to named pipes or I/O devices.

The **Timeout** field is not supported.

<36> [Section 2.2.4.26.1](#): The **Timeout** field was used in earlier dialects. In the NT LAN Manager dialect, Write MPX is not used to write to named pipes or devices, so the **Timeout** field is ignored.

<37> [Section 2.2.4.27](#): Windows NT servers return STATUS_INVALID_SMB (ERRSRV/ERRerror) instead of STATUS_NOT_IMPLEMENTED (ERRDOS/ERRbadfunc).

<38> [Section 2.2.4.29](#): Windows NT Server returns STATUS_SMB_BAD_COMMAND (ERRSRV/ERRbadcmd) instead of STATUS_NOT_IMPLEMENTED (ERRDOS/ERRbadfunc) if the **WordCount** field in the request is set to 1; otherwise, Windows NT Server returns STATUS_INVALID_SMB (ERRSRV/ERRerror).

<39> [Section 2.2.4.32.1](#): Windows NT Server does not support the CHANGE_LOCKTYPE flag of **TypeOfLock**. A client requesting that the server atomically change the lock type from a shared lock to an exclusive lock or vice versa results in an error being returned to the client.

<40> [Section 2.2.4.32.1](#): If the CANCEL_LOCK bit is set, Windows NT servers cancel only the first lock request range listed in the lock array.

<41> [Section 2.2.4.33.1](#): One way transactions are used only when communicating with Mailslots, which means that they never occur within CIFS sessions.

<42> [Section 2.2.4.33.1](#): Windows NT Server honors the **Timeout** field only in transaction subcommands that specifically state that the **Timeout** field is honored. Check the individual subcommands for details.

<43> [Section 2.2.4.33.1](#): Windows always sets **ParameterOffset** to an offset location, relative to the start of the [SMB Header \(section 2.2.3.1\)](#), where the **Trans Parameters** field should be. This behavior follows even if **ParameterCount** is zero.

<44> [Section 2.2.4.33.1](#): Windows always sets **DataCount** to a value of **ParameterCount** + **ParameterOffset**. This restricts the **Trans_Data** field to follow after the **Trans_Parameters** field, although this is not strictly a protocol requirement.

<45> [Section 2.2.4.33.2](#): Windows always sets **ParameterOffset** to an offset location, relative to the start of the [SMB Header \(section 2.2.3.1\)](#), where the **Trans_Parameters** field should be. This behavior follows even if **ParameterCount** is zero.

<46> [Section 2.2.4.33.2](#): Windows always sets **DataCount** to a value of **ParameterOffset** + **ParameterCount**. This action restricts the **Trans_Data** field to follow after the **Trans_Parameters** field, although this is not strictly a protocol requirement.

<47> [Section 2.2.4.34.1](#): Windows always sets **ParameterOffset** to an offset location, relative to the start of the [SMB Header \(section 2.2.3.1\)](#), where the **Trans_Parameters** field should be. This behavior follows even if **ParameterCount** is zero.

<48> [Section 2.2.4.34.1](#): Windows always sets **DataCount** to a value of **ParameterOffset** + **ParameterCount**. This restricts the **Trans_Data** field to follow after the **Trans_Parameters** field, although this is not strictly a protocol requirement.

<49> [Section 2.2.4.35](#): Windows NT server does not implement SMB_COM_IOCTL_SECONDARY. Therefore, all of the parameters and data for a request has to fit within the **MaxBufferSize** that

was established during session setup. Windows NT server does not honor the value supplied in the **Timeout** field. Windows NT implementation specifics follow.

Category	Function	Parameters	Data	Description
SERIAL_DEVICE 0x0001	GET_BAUD_RATE 0x0061	None	USHORT BaudRate	Get the baud rate on the serial device.
	SET_BAUD_RATE 0x0041	None	USHORT BaudRate	Set the baud rate on the serial device
	GET_LINE_CONTROL 0x0062	UCHAR DataBits; UCHAR Parity; UCHAR StopBits; UCHAR TransBreak;	None.	Get serial device line control information.
	SET_LINE_CONTROL 0x0042	UCHAR DataBits; UCHAR Parity; UCHAR StopBits; UCHAR TransBreak;	None.	Set serial device line control information.
	GET_DCB_INFORMATION 0x0073	None.	USHORT WriteTimeout; USHORT ReadTimeout; UCHAR ControlHandShake; UCHAR FlowReplace; UCHAR Timeout; UCHAR ErrorReplacementChar; UCHAR BreakReplacementChar; UCHAR XonChar; UCHAR XoffChar;	Get serial device device control information.
	SET_DCB_INFORMATION 0x0053	None.	USHORT WriteTimeout; USHORT ReadTimeout; UCHAR	Get serial device device control information.

Category	Function	Parameters	Data	Description
			ControlHandShake; UCHAR FlowReplace; UCHAR Timeout; UCHAR ErrorReplacementChar; UCHAR BreakReplacementChar; UCHAR XonChar; UCHAR XoffChar;	
	GET_COMM_ERROR 0x006D	None.	USHORT Error;	Get serial device device error information.
	SET_TRANSMIT_TIMEOUT 0x0044			Not implemented.
	SET_BREAK_OFF 0x0045			Not implemented.
	SET_MODEM_CONTROL 0x0046			Not implemented.
	SET_BREAK_ON 0x004B			Not implemented.
	STOP_TRANSMIT 0x0047			Not implemented.
	START_TRANSMIT 0x0048			Not implemented.
	GET_COMM_STATUS 0x0064			Not implemented.
	GET_LINE_STATUS 0x0065			Not implemented.
	GET_MODEM_OUTPUT 0x0066			Not implemented.
	GET_MODEM_INPUT 0x0067			Not implemented.
	GET_INQUEUE_COUNT 0x0068			Not implemented.
	GET_OUTQUEUE_COUNT			Not implemented.

Category	Function	Parameters	Data	Description
	NT 0x0069			
	GET_COMM_EVENT 0x0072			Not implemented.
PRINTER_DEVICE 0x0005	GET_PRINTER_STATUS 0x0066		CHAR Status	Always returns OS2_STATUS_PRINTER_HAPPY (0x90).
SPOOLER_DEVICE 0x0053	GET_PRINTER_ID 0x0060		USHORT JobId; UCHAR Buffer[1];	Print job ID and printer share name.
GENERAL_DEVICE 0x000B				Not implemented.

<50> [Section 2.2.4.35.2](#): [XOPEN-SMB], in section 14.3, states that ERRSRV/ERRnosupport can be returned if the server does not support the SMB_COM_IOCTL command. Windows NT servers support this command, although it is deprecated.

<51> [Section 2.2.4.37](#): Windows NT servers attempt to process this command, but the implementation is incomplete and the results are not predictable.

<52> [Section 2.2.4.38](#): Windows NT servers attempt to process this command, but the implementation is incomplete and the results are not predictable.

<53> [Section 2.2.4.39.1](#): Windows 98 accept only an SMB_COM_ECHO request containing a valid **TID** or a **TID** value of 0xFFFF (-1). Windows NT ignores the **TID** in the SMB_COM_ECHO request.

<54> [Section 2.2.4.39.2](#): Windows clients ignore the **SequenceNumber** field in the server response.

<55> [Section 2.2.4.40](#): Windows NT and Windows 98 clients do not send [SMB_COM_WRITE_AND_CLOSE \(0x2C\)](#) (section 2.2.4.40) requests.

<56> [Section 2.2.4.40.2](#): Windows NT Server appends three null padding bytes to this message, following the **ByteCount** field. These three bytes are not message data and can safely be discarded.

<57> [Section 2.2.4.41.1](#): Windows NT Server ignores SearchAttrs in open requests.

<58> [Section 2.2.4.42.2](#): An AndX chain can be formed by adding an SMB_COM_CLOSE command as a follow-on to SMB_COM_READ_ANDX. SMB_COM_CLOSE is the only valid follow-on command for SMB_COM_READ_ANDX. Windows NT Server correctly processes AndX chains consisting of SMB_COM_READ_ANDX and SMB_COM_CLOSE, but does not correctly set the AndXCommand field in the response message. Windows NT Server always sets the value of AndXCommand in the SMB_COM_READ_ANDX response to SMB_COM_NO_ANDX_COMMAND (0xFF).

<59> [Section 2.2.4.42.2](#): Windows NT Server always sets this field in this message to zero, even if there is a chained SMB_COM_CLOSE follow-on response connected to the SMB_COM_READ_ANDX response message. If present, the SMB_COM_CLOSE response can be seen as three null padding

bytes (representing `WordCount==0x00` and `ByteCount==0x0000`) immediately following the `SMB_Parameters` of the `SMB_COM_READ_ANDX` portion of the message.

<60> [Section 2.2.4.42.2](#): Windows servers set the **DataLength** field to `0x0000` and return `STATUS_SUCCESS`.

<61> [Section 2.2.4.43.1](#): Windows NT and Windows 98 clients set this field to zero for non-message mode pipe writes. This field is ignored by the server if the FID indicates a file. If a pipe write spans multiple requests, for all pipe write requests Windows clients set this field to the total number of bytes to be written.

<62> [Section 2.2.4.43.2](#): Windows NT servers always set **Available** to `0xFFFF`.

<63> [Section 2.2.4.44](#): Windows NT Server returns `STATUS_SMB_BAD_COMMAND` (`ERRSRV/ERRbadcmd`) if the **WordCount** field in the request is set to 3; otherwise, Windows NT Server returns `STATUS_INVALID_SMB` (`ERRSRV/ERRerror`).

<64> [Section 2.2.4.45](#): Windows NT Server has a partial implementation that treats this SMB command as though it were an [SMB_COM_CLOSE](#) ([section 2.2.4.5](#)) followed by an [SMB_COM_TREE_DISCONNECT](#) ([section 2.2.4.51](#)); however, the [SMB_COM_TREE_DISCONNECT](#) is never called. The format of the command is identical to that of [SMB_COM_CLOSE](#). This command was never documented and is not called by Windows clients.

<65> [Section 2.2.4.46.1](#): One way transactions are used only when communicating with Mailslots, which means that they never occur within CIFS sessions.

<66> [Section 2.2.4.46.1](#): Windows NT Server honors the **Timeout** field only in transaction subcommands that specifically state that the Timeout field is honored. Check the individual subcommands for details.

<67> [Section 2.2.4.46.1](#): Windows always sets **ParameterOffset** to an offset location, relative to the start of the [SMB Header](#) ([section 2.2.3.1](#)), where the **Trans_Parameters** field should be. This behavior follows even if **ParameterCount** is zero.

<68> [Section 2.2.4.46.1](#): Windows always sets **DataCount** to a value of **ParameterOffset** + **ParameterCount**. This restricts the **Trans_Data** field to follow after the **Trans_Parameters** field, although this is not strictly a protocol requirement.

<69> [Section 2.2.4.46.2](#): Windows always sets **ParameterOffset** to an offset location, relative to the start of the [SMB Header](#) ([section 2.2.3.1](#)), where the **Trans_Parameters** field should be. This behavior follows even if **ParameterCount** is zero.

<70> [Section 2.2.4.46.2](#): Windows always sets **DataCount** to a value of **ParameterOffset** + **ParameterCount**. This action restricts the **Trans_Data** field to follow after the **Trans_Parameters** field, although this is not strictly a protocol requirement.

<71> [Section 2.2.4.46.2](#): Windows NT Server sends an arbitrary number of additional bytes beyond the end of the SMB response message. These additional bytes can be ignored by the recipient.

<72> [Section 2.2.4.47.1](#): Windows always sets **ParameterOffset** to an offset location, relative to the start of the [SMB Header](#) ([section 2.2.3.1](#)), where the **Trans_Parameters** field should be. This behavior follows even if **ParameterCount** is zero.

<73> [Section 2.2.4.47.1](#): Windows always sets **DataCount** to a value of **ParameterOffset** + **ParameterCount**. This action restricts the **Trans_Data** field to follow after the **Trans_Parameters** field, although this is not strictly a protocol requirement.

<74> [Section 2.2.4.50.1](#): Windows NT servers do not test to determine whether the strings in this request are 16-bit Unicode or 8-bit extended ASCII. It assumes that they are 8-bit strings. Clients that support Unicode use the [SMB_COM_TREE_CONNECT_ANDX \(section 2.2.4.55\)](#) command.

<75> [Section 2.2.4.52.1](#): Windows 98 and Windows NT clients typically send a **TID** value of zero (0x0000) in the SMB_COM_NEGOTIATE request. This value has no particular significance.

<76> [Section 2.2.4.52.1](#): Windows 98 and Windows NT clients typically send a **UID** value of zero (0x0000) in the SMB_COM_NEGOTIATE request. This value has no particular significance.

<77> [Section 2.2.4.52.2](#): The name of this bit value is misleading. Encrypted passwords are used to generate the response to the challenge, but are not sent across the network.

<78> [Section 2.2.4.52.2](#): In some implementations of earlier dialects, this bit was used to indicate support for the SMB_COM_SECURITY_PACKAGE_ANDX command. That usage is obsolete.

<79> [Section 2.2.4.52.2](#): On Windows NT server the default value is 50 (0x0032). This value can be set using the **MaxMpxCt** registry key.

<80> [Section 2.2.4.52.2](#): Windows-based CIFS servers set this field to 0x0001, but do not enforce this limit. This allows a CIFS client to establish more virtual circuits than allowed by this value. Because this limit is not enforced on Windows, CIFS clients can ignore this limit and attempt to establish more than the number of virtual circuits allowed by this value. The Windows behavior of the CIFS server allows a client to exceed this limit, but other server implementations can enforce this limit and not allow this to occur. Windows clients ignore the **MaxNumberVcs** field in the server response.

<81> [Section 2.2.4.52.2](#): If more than 512 MB of memory is available, by default, Windows NT Server, Windows 2000, Windows Server 2003, Windows Server 2008, Windows Server 2008 R2, Windows Server 2012, and Windows Server 2012 R2 set the **MaxBufferSize** value to 16644 bytes. The **MaxBufferSize** is configurable as described in [\[MSKB-320829\]](#).

<82> [Section 2.2.4.52.2](#): Windows clients ignore the **MaxRawSize** field in the server response and use a default value of 65536 bytes (64K) as the maximum raw buffer size for an [SMB_COM_WRITE_RAW Request \(section 2.2.4.25.1\)](#).

<83> [Section 2.2.4.52.2](#): Windows NT clients assume that CAP_NT_FIND is set if CAP_NT_SMBS is set.

<84> [Section 2.2.4.52.2](#): The CAP_BULK_TRANSFER capability was supposed to indicate server support for the SMB_COM_READ_BULK and SMB_COM_WRITE_BULK commands, which were never implemented. The CAP_BULK_TRANSFER capability bit was never used in Windows-based clients or servers.

<85> [Section 2.2.4.52.2](#): The CAP_COMPRESSED_DATA capability bit was supposed to indicate whether a server supported compressed SMB packets. This feature was never specified, implemented, or used. Windows-based clients and servers do not support CAP_COMPRESSED_DATA, so this capability is never set.

<86> [Section 2.2.4.52.2](#): The CAP_QUADWORD_ALIGNED capability bit was intended to indicate that Windows directory **InformationLevel** responses were quadword-aligned. The CAP_QUADWORD_ALIGNED capability bit was never used in released Windows-based clients or servers.

<87> [Section 2.2.4.52.2](#): Windows clients ignore the **SystemTime** field in the server response.

<88> [Section 2.2.4.52.2](#): Windows clients ignore the **ServerTimeZone** field in the server response.

<89> [Section 2.2.4.52.2](#): Windows NT servers always send the **DomainName** field in Unicode characters and never add a padding byte for alignment. Windows clients ignore the **DomainName** field in the server response.

<90> [Section 2.2.4.53](#): Windows clients always issue SMB_COM_SESSION_SETUP_ANDX and SMB_COM_TREE_CONNECT_ANDX as a batched request.

<91> [Section 2.2.4.53.1](#): Windows NT clients and servers always use a **MaxBufferSize** value that is a multiple of four (4). **MaxBufferSize** values, sent or received via SMB, are always rounded down to the nearest multiple of four before they are used. This is done by masking out the two lowest-order bits of the value: **MaxBufferSize** &= ~3;

The default **MaxBufferSize** on Windows clients is 4356 (0x1104) bytes (4KB + 260Bytes). The **MaxBufferSize** can be configured through the following registry setting:

```
HKLM\SYSTEM\CurrentControlSet\Services\LanmanServer\Parameters\SizReqBuf
```

If the client's **MaxBufferSize** value in a session setup request is below a system-specified minimum value, Windows CIFS servers will fail the request and return ERRSRV/ERRerror. The default minimum acceptable **MaxBufferSize** value is 500 (0x1F4) bytes. This value can be modified using the following registry setting:

```
HKEY_Local_Machine\System\CurrentControlSet\Services\LanManServer\Parameters\MinClientBufferSize
```

<92> [Section 2.2.4.53.1](#): Windows servers support a maximum [SMB_COM_READ_ANDX \(section 2.2.4.42\)](#) buffer size of 61440 (0xF000 = 60K) when the CAP_LARGE_READX capability is negotiated.

<93> [Section 2.2.4.53.1](#): Windows-based CIFS servers set a limit for the **MaxNumberVcs** field in the [SMB_COM_NEGOTIATE Response \(section 2.2.4.52.2\)](#) to 0x01, but do not enforce this limit. This allows a CIFS client to establish more virtual circuits than allowed by the **MaxNumberVcs** field value. Because this limit is not enforced on Windows, CIFS clients can ignore this limit and attempt to establish more than the number of virtual circuits allowed by this value. The Windows behavior of the CIFS server allows a client to exceed this limit, but other server implementations can enforce this limit and not allow this to occur.

<94> [Section 2.2.4.53.1](#): Windows NT Server ignores the client's **SessionKey**.

<95> [Section 2.2.4.53.1](#): The Windows 98 client sends only CAP_RAW_MODE and CAP_UNICODE. Windows NT clients send only CAP_NT_STATUS, CAP_UNICODE, CAP_LEVEL_II_OPLOCKS, and CAP_NT_SMBS (the latter implies CAP_NT_FIND). Windows NT Server checks only for the following capabilities in the client's SMB_COM_SESSION_SETUP_ANDX request: CAP_UNICODE, CAP_LARGE_FILES, CAP_NT_SMBS, CAP_NT_FIND, CAP_NT_STATUS, and CAP_LEVEL_II_OPLOCK.

For some capabilities, it is not necessary for the client to indicate support for a server capability in order to use that capability. For example, Windows 98 clients do not indicate support for DFS, but still request DFS referrals from the server if the server has indicated support.

<96> [Section 2.2.4.53.1](#): Windows NT and Windows 98 clients do not set the CAP_LARGE_FILES bit.

<97> [Section 2.2.4.53.1](#): Windows client systems that negotiate CAP_NT_SMBS also negotiate CAP_UNICODE. Windows NT servers expect that CAP_NT_SMBS and CAP_UNICODE will be negotiated together. This relationship, however, is not enforced by the server. If the client

negotiates one of these capabilities but not the other, the contents of SMB_STRING fields in Windows NT server response messages are undefined and can be malformed.

<98> [Section 2.2.4.53.1](#): Windows 98 and Windows NT clients do not set the CAP_NT_FIND capability bit. Windows NT Server, however, treats CAP_NT_FIND as set if CAP_NT_SMBS is set.

<99> [Section 2.2.4.53.1](#): Windows NT Server does not support plaintext Unicode authentication.

<100> [Section 2.2.4.53.1](#): Windows CIFS clients set this field based on the version and service pack level of the Windows operating system. A list of possible values for this field includes the following:

Windows OS version	NativeOS string
Windows NT 4.0	Windows NT 1381
Windows NT 3.51	Windows NT 1057
Windows 98 Second Edition	Windows 4.0

<101> [Section 2.2.4.53.1](#): Windows CIFS clients set this field based on the version of the Windows operating system. A list of possible values for this field includes the following:

Windows OS version	NativeLanMan string
Windows NT 4.0	Windows NT 4.0
Windows NT 3.51	Windows NT 3.51
Windows 98 Second Edition	Windows 4.0

Windows NT clients add an extra string terminator following the NativeOS field, so the **NativeLanMan** string appears to be the empty string. If **ByteCount** indicates that there are more bytes in the **SMB_Data.Data** block, the additional bytes are the **NativeLanMan** string. The **NativeLanMan** string also contains an extra terminating null character.

<102> [Section 2.2.4.53.2](#): Windows-based CIFS servers set this field based on the version and service pack level of the Windows operating system. The following table includes a list of possible values for this field:

Windows OS version	NativeOS string
Windows NT 3.51	Windows NT 1057
Windows NT 4.0	Windows NT 1381
Windows 98 Second Edition	Windows 4.0

Windows clients ignore the **NativeOS** field in the server response.

<103> [Section 2.2.4.53.2](#): Windows-based CIFS servers set this field based on the version of the Windows operating system. The following table lists possible values for this field:

Windows OS version	NativeLanMan string
Windows NT 3.51	NT LAN Manager 3.51

Windows OS version	NativeLanMan string
Windows NT 4.0	NT LAN Manager 4.0
Windows 98 Second Edition	Windows 4.0

Windows clients ignore the **NativeLanMan** field in the server response.

<104> [Section 2.2.4.53.2](#): Windows clients ignore the **PrimaryDomain** field in the server response.

<105> [Section 2.2.4.55.1](#): Windows 98 clients set this bit. Windows NT servers ignore the setting.

<106> [Section 2.2.4.55.2](#): Windows clients ignore the **NativeFileSystem** field in the server response.

<107> [Section 2.2.4.56](#): This command is neither reserved nor implemented in Windows. Windows NT servers return STATUS_SMB_BAD_COMMAND (ERRSRV/ERRbadcmd).

<108> [Section 2.2.4.58.1](#): Windows NT systems define this UCHAR field as follows:

bit 7 (mask 0x80): Reserved for client use.

bits 5,6 (mask 0x60): Reserved for system use.

bits 0-4 (mask 0x1F): Reserved for server use.

The above definition agrees with [\[SMB-CORE\]](#) as well as [\[CIFS\]](#), and is used in Windows NT server. [XOPEN-SMB], however, declares this field as reserved for client use. The safest course for implementers is to avoid modifying the contents of this field, whether set by the client or the server.

<109> [Section 2.2.4.58.1](#): Windows NT server makes use of the **ServerState** field as follows:

```
ServerState
{
    UCHAR FileName[8];
    UCHAR FileExt[3];
    UCHAR SearchID;
    ULONG FileIndex;
}
```

FileName (8 bytes): This is the name portion of the 8.3 format file name. The name is left-justified and space-padded.

FileExt (3 bytes): This is the file extension of the 8.3 format file name. It is left-justified and space-padded.

This 11-byte representation of the 8.3 format name is known as the "packed" format.

SearchID (1 byte) : This is a one-byte search identifier used by the server to uniquely identify the search operation. The use of a one-byte field implies that the NT server can manage a maximum of 256 concurrent searches per SMB session.

FileIndex (4 bytes): A server-specific index used to continue the search at the correct place in the remote directory.

<110> [Section 2.2.4.61.1](#): Windows clients set **MaxCount** to nonzero values. Windows servers fail the request with STATUS_INVALID_SMB if **MaxCount** is 0x0000.

<111> [Section 2.2.4.61.2](#): Windows NT servers set this field to 0x0000 and do not send the **BufferFormat** and **DataLength** fields.

<112> [Section 2.2.4.62.1](#): Windows always sets **ParameterOffset** to an offset location, relative to the start of the [SMB Header \(section 2.2.3.1\)](#), where the **Trans_Parameters** field should be. This behavior follows even if **ParameterCount** is zero.

<113> [Section 2.2.4.62.1](#): Windows always sets **DataCount** to a value of **ParameterOffset** + **ParameterCount**. This action restricts the **Trans_Data** field to follow after the **Trans_Parameters** field, although this is not strictly a protocol requirement.

<114> [Section 2.2.4.62.2](#): Windows always sets **ParameterOffset** to an offset location, relative to the start of the [SMB Header \(section 2.2.3.1\)](#), where the **Trans_Parameters** field should be. This behavior follows even if **ParameterCount** is zero.

<115> [Section 2.2.4.62.2](#): Windows always sets **DataCount** to a value of **ParameterOffset** + **ParameterCount**. This action restricts the **Trans_Data** field to follow after the **Trans_Parameters** field, although this is not strictly a protocol requirement.

<116> [Section 2.2.4.63.1](#): Windows always sets **ParameterOffset** to an offset location, relative to the start of the [SMB Header \(section 2.2.3.1\)](#), where the **Trans_Parameters** field should be. This behavior follows even if **ParameterCount** is zero.

<117> [Section 2.2.4.63.1](#): Windows always sets **DataCount** to a value of **ParameterOffset** + **ParameterCount**. This action restricts the **Trans_Data** field to follow after the **Trans_Parameters** field, although this is not strictly a protocol requirement.

<118> [Section 2.2.4.64.1](#): Windows NT CIFS servers allow only the FILE_OPEN option on a named pipe. All other options are ignored and considered the same as FILE_OPEN. Windows NT CIFS servers do not allow clients to "open" or to "create" a mailslot.

<119> [Section 2.2.4.65](#): Upon receipt of this command, the Windows NT server attempts to complete outstanding commands such as those that are waiting for a thread context or waiting to access a busy resource. If the outstanding command cannot be completed successfully, the server returns an implementation-specific error.

<120> [Section 2.2.4.66](#): Windows NT client and server both support the [SMB_COM_NT_RENAME](#) command. However, the design and implementation of this command was never completed. The [SMB_COM_NT_RENAME](#) command is not documented in [\[CIFS\]](#); the only prior documentation covering this command is [\[SNIA\]](#).

The request structure for this command includes a **Reserved** field that was originally intended to access a proposed server feature that was never implemented. The SMB_DATA portion of the message also includes **Buffer Format** fields, making this the only non-Core Protocol command to make use of **Buffer Format** fields.

This command is superseded by newer commands in updated versions of the protocol (see [\[MS-SMB\]](#)).

<121> [Section 2.2.4.66](#): The Windows server implementation of [SMB_COM_NT_RENAME](#) does not support moving a file within its existing path hierarchy. If such a move is requested, the server will copy the file instead.

<122> [Section 2.2.4.66.1](#): Windows clients never send an [SMB_COM_NT_RENAME Request \(section 2.2.4.66.1\)](#) using this information level. Instead, they use [SMB_COM_RENAME \(section 2.2.4.8\)](#) to perform rename operations. Windows servers process [SMB_COM_NT_RENAME Requests](#) with this information level in the same way as an [SMB_COM_RENAME Request \(section 2.2.4.8.1\)](#), with the exception that they do not allow wildcards in the request.

<123> [Section 2.2.4.66.1](#): Windows clients do not send [SMB_COM_NT_RENAME Requests](#) with the SMB_NT_RENAME_MOVE_FILE information level. Windows NT servers do not fully implement this information level, and perform a file copy instead of a rename or move if SMB_NT_RENAME_MOVE_FILE is specified.

<124> [Section 2.2.4.66.1](#): This field was previously designated **ClusterCount** (as listed in [\[SNIA\]](#) section 2.4.13). **ClusterCount** is not implemented in Windows.

<125> [Section 2.2.4.67.1](#): Windows NT4.SP6 server ignores the **Identifier**.

<126> [Section 2.2.4.70](#): Support for this command was not implemented in Windows NT Server. Windows 98 and Windows NT clients do not call this command.

<127> [Section 2.2.4.71](#): Windows NT Server returns STATUS_SMB_BAD_COMMAND (ERRSRV/ERRbadcmd) instead of STATUS_NOT_IMPLEMENTED (ERRDOS/ERRbadfunc) if the **WordCount** field in the request is set to 12; otherwise, Windows NT Server returns STATUS_INVALID_SMB (ERRSRV/ERRerror).

<128> [Section 2.2.4.72](#): Windows NT Server returns STATUS_SMB_BAD_COMMAND (ERRSRV/ERRbadcmd) instead of STATUS_NOT_IMPLEMENTED (ERRDOS/ERRbadfunc) if the **WordCount** field in the request is set to 12; otherwise, Windows NT Server returns STATUS_INVALID_SMB (ERRSRV/ERRerror).

<129> [Section 2.2.4.73](#): Windows NT servers return STATUS_SMB_BAD_COMMAND (ERRSRV/ERRbadcmd) instead of STATUS_NOT_IMPLEMENTED (ERRDOS/ERRbadfunc).

<130> [Section 2.2.5.1](#): The [TRANS_SET_NMPIPE_STATE](#) subcommand was introduced to provide support for the **SetNamedPipeHandleState()** system call in OS/2 and Win32. For more information, see [\[MSDN-SetNmdPipeHndState\]](#). Windows NT servers use the FilePipeInformation Information Class to implement this named pipe transaction subcommand. For more information, see [\[MS-FSCC\]](#) section 2.4.29.

<131> [Section 2.2.5.2](#): Windows NT Server does not support this transaction subcommand. It returns a status of STATUS_INVALID_PARAMETER (ERRDOS/ERRinvalidparam).

<132> [Section 2.2.5.3](#): The [TRANS_QUERY_NMPIPE_STATE](#) subcommand was introduced to provide support for the GetNamedPipeHandleState() system call in OS/2 and Win32. For more information, see [\[MSDN-GetNmdPipeHndState\]](#). Windows NT servers use the FilePipeInformation Information Class to implement this named pipe transaction subcommand. For more information, see [\[MS-FSCC\]](#) section 2.4.29.

<133> [Section 2.2.5.4](#): The [TRANS_QUERY_NMPIPE_INFO](#) subcommand was introduced to provide support for the **GetNamedPipeInfo()** system call in OS/2 and Win32. For more information, see [\[MSDN-GetNmdPipeInfo\]](#). Windows NT servers use the FilePipeLocalInformation Information Class to implement this named pipe transaction subcommand. For more information, see [\[MS-FSCC\]](#) section 2.4.30.

<134> [Section 2.2.5.5](#): The [TRANS_PEEK_NMPIPE](#) subcommand was introduced to provide support for the **PeekNamedPipe()** system call in OS/2 and Win32. For more information, see [\[MSDN-PkNmdPipe\]](#). Windows NT servers use FSCTL_PIPE_PEEK to implement this subcommand. For more information, see [\[MS-FSCC\]](#) sections [2.3.27](#) and [2.3.28](#).

<135> [Section 2.2.5.5](#): Windows always peeks from a named pipe using the read mode that was specified when the named pipe was created. The peek operation is not affected when the TRANS_SET_NMPIPE_STATE subcommand is used to change the state of the named pipe. In addition, the operation always returns immediately and is not affected by the wait mode of the named pipe. For more information, see [\[MSDN-PkNmdPipe\]](#).

<136> [Section 2.2.5.6](#): The TRANS_TRANSACT_NMPIPE subcommand was introduced to provide support for the **TransactNamedPipe()** system call in OS/2 and Win32. For more information, see [\[MSDN-TrnsactNmdPipe\]](#). Windows NT servers use FSCTL_PIPE_TRANSCEIVE to implement this subcommand. For more information, see [\[MS-FSCC\]](#) sections [2.3.31](#) and [2.3.32](#).

<137> [Section 2.2.5.6.2](#): If the Windows NT Server receives a single-request transaction where the request's **DataCount** field equals the **TotalDataCount** field and the **ParameterCount** field equals the **TotalParameterCount** field, and if the server response indicates a STATUS_BUFFER_OVERFLOW, the data read from the named pipe is included in the response's **ReadData** field, even if the amount of data read from the pipe exceeds the **MaxDataCount** field of the client's request. In this case, the response's **TotalDataCount** field is greater than the **DataCount** field and indicates the number of remaining bytes that were not transferred to the client in the response.

<138> [Section 2.2.5.7](#): Windows NT Server permits only a 2-byte write that contains two null padding bytes. The pipe must also be in message mode. If these conditions are not met, NT server returns an STATUS_INVALID_PARAMETER error.

<139> [Section 2.2.5.10](#): The TRANS_WAIT_NMPIPE subcommand was introduced to provide support for the **WaitNamedPipe()** system call in OS/2 and Win32. For more information, see [\[MSDN-WaitNmdPipe\]](#). Windows NT servers use FSCTL_PIPE_WAIT to implement this subcommand. For more information, see [\[MS-FSCC\]](#) sections [2.3.29](#) and [2.3.30](#).

<140> [Section 2.2.5.10.1](#): Windows NT server honors the **Timeout** field for this transaction.

<141> [Section 2.2.5.10.1](#): Windows NT servers ignore the **Priority** value in the TRANS_WAIT_NMPIPE Request ([section 2.2.5.10.1](#)), and do not provide a default priority.

<142> [Section 2.2.5.11](#): The TRANS_CALL_NMPIPE subcommand was introduced to provide support for the CallNamedPipe() system call in OS/2 and Win32. For more information, see [\[MSDN-CallNmdPipe\]](#). Windows NT servers use FSCTL_PIPE_TRANSCEIVE to implement this subcommand. For more information, see [\[MS-FSCC\]](#) sections [2.3.31](#) and [2.3.32](#).

<143> [Section 2.2.5.11.2](#): Windows 98 clients misread the number of data bytes returned. For more information, see [\[MSKB-235717\]](#).

<144> [Section 2.2.5.11.2](#): When the TRANS_CALL_NMPIPE ([section 2.2.5.11](#)) operation returns STATUS_BUFFER_OVERFLOW, Windows servers set the **SetupCount** field value in the TRANS_CALL_NMPIPE Response ([section 2.2.5.11.2](#)) to the **SetupCount** field value in the TRANS_CALL_NMPIPE Request ([section 2.2.5.11.1](#)) * 2.

<145> [Section 2.2.6.3.1](#): If the client sends an empty string (0x00 or 0x0000) in the **FileName** field for the TRANS2_FIND_NEXT2 Request ([section 2.2.6.3.1](#)), Windows NT servers return no data in the **Trans2_Data** block. The **SearchCount** field value in the **Trans2_Parameters** block is set to zero (0x0000).

<146> [Section 2.2.6.8.2](#): If the information level is SMB_QUERY_FILE_ALL_INFO, Windows NT servers append 4 additional bytes at the end of the **Trans2_Data** block that are set to arbitrary values and that are ignored on receipt.

<147> [Section 2.2.7.1.1](#): Windows NT Server requires that this field be aligned to a 32-bit boundary. No padding is required, however, because the NT_Trans_Data block is aligned, and the **SecurityDescriptor** field is always a multiple of 32 bits.

<148> [Section 2.2.7.2](#): Windows clients generate IOCTL and FSCTL codes that are supported only by Windows NT Server.

<149> [Section 2.2.7.3](#): Security descriptors are typically useful only to Windows clients.

<150> [Section 2.2.7.4.2](#): The Windows NT Server implementation of NT_TRANSACT_NOTIFY_CHANGE always returns the names of changed files in Unicode format.

<151> [Section 2.2.7.6](#): Security descriptors are typically useful only to Windows clients.

<152> [Section 2.2.8.1.1](#): Windows NT servers append a single NULL padding character to this field. If CAP_UNICODE has been negotiated, the server appends two NULL bytes to this field; otherwise, one NULL byte is appended. The length of the terminating NULL character is not included in the value of the **FileNameLength** field.

<153> [Section 2.2.8.1.2](#): Windows NT servers always append a single NULL padding byte to the **FileName** field. The length of this additional byte is not included in the value of the **FileNameLength** field.

<154> [Section 2.2.8.1.3](#): If CAP_UNICODE has been negotiated, Windows NT servers set the **FileNameLength** field to an arbitrary value.

<155> [Section 2.2.8.1.3](#): Windows NT servers always append a single NULL padding byte to the **FileName** field. The length of this additional byte is not included in the value of the **FileNameLength** field.

<156> [Section 2.2.8.1.4](#): Windows-based CIFS servers set the **FileIndex** field to a nonzero value if the underlying object store supports indicating the position of a **file** within the parent directory.

<157> [Section 2.2.8.1.4](#): If CAP_UNICODE has not been negotiated, Windows NT servers include the length of the terminating NULL byte in the value of the **FileNameLength** field.

<158> [Section 2.2.8.1.4](#): Windows NT servers append an arbitrary number of extra NULL padding bytes to the **FileName** field. The length of these additional NULL bytes is not included in the value of the **FileNameLength** field unless CAP_UNICODE has not been negotiated. If CAP_UNICODE has not been negotiated, only the length of the first NULL byte is included in the value of the **FileNameLength** field.

<159> [Section 2.2.8.1.5](#): Windows-based CIFS servers set the **FileIndex** field to a nonzero value if the underlying object store supports indicating the position of a file within the parent directory.

<160> [Section 2.2.8.1.5](#): If CAP_UNICODE has not been negotiated, Windows NT servers include the length of one NULL padding byte in the **FileNameLength** field value.

<161> [Section 2.2.8.1.5](#): Windows NT servers append an arbitrary number of extra NULL padding bytes to the **FileName** field. The length of these additional NULL bytes is not included in the value of the **FileNameLength** field unless CAP_UNICODE has not been negotiated. If CAP_UNICODE has not been negotiated, only the length of the first NULL byte is included in the value of the **FileNameLength** field.

<162> [Section 2.2.8.1.6](#): Windows-based CIFS servers set the **FileIndex** field to a nonzero value if the underlying object store supports indicating the position of a file within the parent directory.

<163> [Section 2.2.8.1.6](#): If CAP_UNICODE has not been negotiated, Windows NT servers include the length of one NULL padding byte in the **FileNameLength** field value.

<164> [Section 2.2.8.1.6](#): Windows NT servers append an arbitrary number of extra NULL padding bytes to the **FileName** field. The length of these additional NULL bytes is not included in the value of the **FileNameLength** field unless CAP_UNICODE has not been negotiated. If CAP_UNICODE has not been negotiated, only the length of the first NULL byte is included in the value of the **FileNameLength** field.

<165> [Section 2.2.8.1.7](#): Windows-based CIFS servers set the **FileIndex** field to a nonzero value if the underlying object store supports indicating the position of a file within the parent directory.

<166> [Section 2.2.8.1.7](#): If CAP_UNICODE has not been negotiated, Windows NT servers include the length of one NULL padding byte in the **FileNameLength** field value.

<167> [Section 2.2.8.1.7](#): Windows NT servers append an arbitrary number of extra NULL padding bytes to the **FileName** field. The length of these additional NULL bytes is not included in the value of the **FileNameLength** field unless CAP_UNICODE has not been negotiated. If CAP_UNICODE has not been negotiated, only the length of the first NULL byte is included in the value of the **FileNameLength** field.

<168> [Section 2.2.8.2.1](#): Windows servers always return zero (0x00000000).

<169> [Section 2.2.8.2.2](#): Windows NT servers use the FileFsVolumeInformation information class to retrieve file system volume information. See [\[MS-FSCC\]](#), section [2.5.9](#).

If the **VolumeLabelLength** field of the FILE_FS_VOLUME_INFORMATION data element contains a value greater than 13, an error response is returned to the client with a status of STATUS_BUFFER_OVERFLOW (ERRDOS/ERRmoredata). Otherwise, the **ulVolSerialNbr** field is copied from the **VolumeSerialNumber** field of the FILE_FS_VOLUME_INFORMATION data element. **VolumeLabelLength** is copied to **cCharCount** and **VolumeLabel** is copied to **VolumeLabel**.

Windows clients request SMB_INFO_VOLUME only if CAP_NT_SMBS has not been negotiated. If CAP_NT_SMBS has been negotiated, Windows clients request SMB_QUERY_FS_VOLUME_INFO instead of SMB_INFO_VOLUME.

If CAP_UNICODE has been negotiated, the contents of the **VolumeLabel** field returned by Windows NT servers is undefined.

If CAP_UNICODE has not been negotiated, Windows NT servers append an arbitrary number of extra NULL padded bytes to the **VolumeLabel** field.

<170> [Section 2.2.8.2.3](#): Windows NT Server servers use the FileFsVolumeInformation ([\[MS-FSCC\]](#) section 2.5.9) information class to retrieve file system volume information.

<171> [Section 2.2.8.2.4](#): Windows NT servers use the FileFsSizeInformation ([\[MS-FSCC\]](#) section 2.5.8) information class to retrieve file system allocation and size information.

<172> [Section 2.2.8.2.5](#): Windows NT servers use the FileFsDeviceInformation ([\[MS-FSCC\]](#) section 2.5.10) information class to retrieve file system device information.

<173> [Section 2.2.8.2.6](#): Windows NT Server use the FileFsAttributeInformation ([\[MS-FSCC\]](#) section 2.5.1) informationclass to retrieve file system attribute information.

```
SMB_QUERY_FS_ATTRIBUTE_INFO
{
    ULONG FileSystemAttributes;
```

```
LONG   MaxFileNameLengthInBytes;  
ULONG  LengthOfFileSystemName;  
WCHAR  FileSystemName[LengthOfFileSystemName/2];  
}
```

<174> [Section 2.2.8.3.6](#): Windows NT Server use the FileBasicInformation ([MS-FSCC] section 2.4.7) information class to retrieve timestamp and extended file attribute information for a file.

<175> [Section 2.2.8.3.7](#): Windows NT servers use the FileStandardInformation ([MS-FSCC] section 2.4.38) information class to retrieve the specified standard information for a file.

<176> [Section 2.2.8.3.8](#): Windows NT Server use the FileEaInformation ([MS-FSCC] section 2.4.12) information class to EA size information for a file.

<177> [Section 2.2.8.3.9](#): Windows NT Server use the FileNameInformation ([MS-FSCC] section 2.4.25) information class to retrieve the long name for a file.

<178> [Section 2.2.8.3.11](#): Windows NT servers use the FileAlternateNameInformation ([MS-FSCC] section 2.4.5) information class to retrieve the 8.3 format name for a file.

<179> [Section 2.2.8.3.12](#): Windows NT Server use the FileStreamInformation ([MS-FSCC] section 2.4.40) information class to retrieve the stream information for a file.

<180> [Section 2.2.8.3.13](#): Windows NT Server use the FileCompressionInformation ([MS-FSCC] section 2.4.9) information class to retrieve the compression information for a file.

<181> [Section 2.2.8.4.3](#): Windows NT servers use the FileBasicInformation ([MS-FSCC] section 2.4.7) information class to set timestamp and extended file attribute information for a file.

<182> [Section 2.2.8.4.4](#): Windows NT servers use the FileDispositionInformation ([MS-FSCC] section 2.4.11) information class to mark or unmark a file for deletion.)

<183> [Section 2.2.8.4.5](#): Windows NT servers use the FileAllocationInformation ([MS-FSCC] section 2.4.4) information class to set allocation size information for a file.

<184> [Section 2.2.8.4.6](#): Windows NT servers use the FileEndOfFileInformation ([MS-FSCC] section 2.4.13) information class to set end-of-file information for a file.

<185> [Section 3.1.5.2](#): Windows clients do not provide a configuration parameter to specify LMv2 authentication. Rather, a single system parameter enables both LMv2 and NTLMv2 authentication. For more information, see [\[MSFT-SecurityWatch\]](#).

<186> [Section 3.2.1.1](#): Windows NT Workstation 4.0 added support for the ability to enable and require signing in Service Pack 3 (SP3). See [\[ENSIGN\]](#).

<187> [Section 3.2.1.5](#): Windows 98 and NT 4 Workstation clients do not request Exclusive or Level II OpLocks.

<188> [Section 3.2.2.1](#): Windows NT and Windows 98 CIFS clients implement this timer with a default value of 30 seconds.

<189> [Section 3.2.3](#): Windows 98 clients set **Client.PlaintextAuthenticationPolicy** to **Disabled** by default. Plain text authentication can be enabled by selecting the HKLM\System\CurrentControlSet\Services\VxD\VNETSUP registry path and setting the EnablePlainTextPassword registry value to 1.

Windows NT clients prior to NT 4 SP3 set **Client.PlaintextAuthenticationPolicy** to **Enabled** by default. Windows NT 4.0 SP3 and above client systems set **Client.PlaintextAuthenticationPolicy** to **Disabled** by default. Plain text authentication can be enabled by selecting the HKLM\System\CurrentControlSet\Services\Rdr\Parameters registry path and setting the EnablePlainTextPassword registry value to 1.

Windows 98 clients determine **Client.LMAuthenticationPolicy** and **Client.NTLMAuthenticationPolicy** based upon the value of the LMCompatibility registry key. See [\[MSFT-SecurityWatch\]](#) and [IMP-CIFS] section 15.5.7 for further information. Windows 98 clients do not support NTLMv2 authentication, but support can be added. See [\[MSKB-288358\]](#).

Windows NT 4.0 Workstation clients determine **Client.LMAuthenticationPolicy** and **Client.NTLMAuthenticationPolicy** based upon the value of the LMCompatibilityLevel registry key. Support for NTLMv2 authentication was added to Windows NT 4.0 in SP4. See [\[MSFT-SecurityWatch\]](#), [\[MSKB-239869\]](#), and [IMP-CIFS] section 15.5.7 for further information.

[<190> Section 3.2.3:](#) Windows NT 3.51 servers do not support signing. Windows NT 4.0 added support for the ability to enable and require signing in Service Pack 3 (SP3). See [\[ENSIGN\]](#).

[<191> Section 3.2.3:](#) Windows NT clients use a default value of 45 seconds. This value is obtained from a system-wide configuration parameter. See [\[KB102067\]](#) for more information.

[<192> Section 3.2.3:](#) The default maximum buffer size for Windows 98 and NT 4 Workstation clients is 4356 bytes.

[<193> Section 3.2.3:](#) Windows-based clients set the list of supported dialect identifier strings in the following order.

- PC NETWORK PROGRAM 1.0
- LANMAN1.0
- MICROSOFT NETWORKS 3.0
- LM1.2X002
- LANMAN2.1
- NT LM 0.12

This technical document describes only the NT LM 0.12 dialect behavior; see section [1](#).

[<194> Section 3.2.3:](#) By default, Windows 98 and NT 4 Workstation clients set the **Client.Connection.MaxMpxCount** value to 50. This can be configured using the MaxCmds registry setting.

[<195> Section 3.2.4.1.4:](#) Windows 98 and Windows NT 4.0 clients do not send AndX chains longer than two commands in length. Windows NT Server 4.0 produces unexpected errors if an untested AndX chain is received.

[<196> Section 3.2.4.1.5:](#) Windows 98 clients and Windows NT clients and servers do not support sending a transaction with secondary messages as part of an AndX chain. The SMB_COM_SESSION_SETUP_ANDX and SMB_COM_TREE_CONNECT_ANDX commands each permits an SMB_COM_TRANSACTION as a follow-on command. Transactions that are part of an AndX chain are "complete". That is, the entire transaction request fits within the primary transaction request.

[<197> Section 3.2.4.2.1:](#) The Windows implementation, by default, attempts to connect on all available SMB transports (NetBIOS-compatible and direct IPX) simultaneously and selects the one

that succeeds the fastest. Any connection that is not selected is immediately closed. Windows also allows an upper layer to specify what transport to use.

<198> [Section 3.2.4.2.4:](#) Windows NT servers do not support share level access control.

<199> [Section 3.2.4.2.4:](#) Null sessions are also used to allow clients to access the browse list and list of available server shares. See [\[MS-BRWS\]](#) for more information on the Browser Service.

<200> [Section 3.2.4.2.4:](#) Windows NT Server does not support share level access control.

<201> [Section 3.2.4.2.4:](#) Windows clients determine the authentication type using the following rules:

```
IF Client.NTLMAuthenticationPolicy NOT EQUALS Disabled THEN
    USE NT LAN Manager (NTLM) Response OR NT LAN Manager version 2 (NTLMv2) Response
ELSE IF Client.LMAuthenticationPolicy NOT EQUALS Disabled THEN
    USE LAN Manager (LM) Response OR LAN Manager version 2 (LMv2) Response
ELSE IF Client.PlaintextAuthenticationPolicy EQUALS Enabled THEN
    USE Plaintext Authentication
ELSE
    Fail the Authentication
END IF
```

<202> [Section 3.2.4.2.4:](#) Windows 98 and NT 4 Workstation clients do not retry authentication.

<203> [Section 3.2.4.5:](#) Windows 98 and Windows NT Workstation 4.0 clients never request exclusive OpLocks.

<204> [Section 3.2.4.14.1:](#) If a Windows-based server does not support the READ RAW capability, but a client sends an SMB_COM_READ_RAW request to the server, the server sends a zero-length response.

<205> [Section 3.2.4.15:](#) Windows clients set the first two bytes of the **SMB_Data.Bytes.Data** field to the **SMB_Parameters.Words.Remaining** field value for the first write request.

<206> [Section 3.2.4.15.1:](#) Windows 98 and NT clients set the **Timeout** field to 0x00000000 in this request.

If the server has indicated support for Raw Mode by setting CAP_RAW_MODE in the [SMB_COM_NEGOTIATE Response \(section 2.2.4.52.2\)](#), a Windows NT client might send SMB_COM_WRITE_RAW, even if it has not indicated support for RAW WRITE, by setting the CAP_RAW_MODE bit in the **Capabilities** bit field of the [SMB_COM_SESSION_SETUP_ANDX Request \(section 2.2.4.53.1\)](#). This is expected to succeed, because the server has already indicated support for the Raw Mode.

<207> [Section 3.2.4.43:](#) Support for DFS Client capabilities was introduced in Windows NT 4.0 Workstation and Server.

<208> [Section 3.2.5.1.2:](#) Windows-based clients that use message signing disconnect the connection on receipt of an incorrectly signed message.

<209> [Section 3.2.5.13:](#) Windows NT CIFS servers maintain a 64-bit offset value internally, but return only the lower-order 32-bits.

<210> [Section 3.2.6.1](#): Windows NT clients use a default **Client.SessionTimeoutValue** value of 45 seconds. Additional time will be added depending upon the size of the message. See [\[KB102067\]](#) for more information.

<211> [Section 3.2.6.1](#): Windows NT and Windows 98 CIFS clients periodically scan for any commands that have not completed. If there are outstanding commands that have exceeded the **Client.SessionTimeoutValue**, an [SMB_COM_ECHO \(section 2.2.4.39\)](#) is sent to determine whether or not the connection has been lost. Regardless of whether the client receives an [SMB_COM_ECHO Response \(section 2.2.4.39.2\)](#), it closes the connection if there is no response to the outstanding commands that have exceeded the **Client.SessionTimeoutValue**.

<212> [Section 3.3.1.1](#): Windows NT Server 4.0 added support for the ability to enable and require signing in Service Pack 3 (SP3). See [\[ENSIGN\]](#).

<213> [Section 3.3.1.2](#): Windows NT servers allow the sharing of printers and traditional file shares.

<214> [Section 3.3.1.2](#): In Windows, this ADM element contains the security descriptor for the share.

<215> [Section 3.3.1.3](#): Windows NT Server 4.0 does not include the **CID** as a lookup key to identify the list of pending requests that are associated with the SMB transport in **Server.Connection.PendingRequestTable**; it includes only the **UID**, **TID**, **PID**, and **MID**.

<216> [Section 3.3.2.1](#): The default OpLock acknowledgment time-out on Windows NT Servers is 35 seconds. This value is controlled by the `\HKEY_LOCAL_MACHINE\SYSTEM\CurrentControlSet\Services\LanmanServer\Parameters\OplockBreakWait` registry parameter. See [\[KB129202\]](#).

<217> [Section 3.3.2.2](#): The default idle timer time-out value for Windows NT 4.0 is 15 minutes. See [\[KB297684\]](#) for more information on Windows NT idle timer settings.

<218> [Section 3.3.3](#): Windows NT Server initializes **Server.ShareLevelAuthentication** to FALSE because Windows NT Server does not support share-level security.

<219> [Section 3.3.3](#): Windows-based server sets the list of supported dialect identifier strings in the following order:

- PC NETWORK PROGRAM 1.0
- LANMAN1.0
- MICROSOFT NETWORKS 3.0
- LM1.2X002
- LANMAN2.1
- NT LM 0.12

This technical document describes only the NT LM 0.12 dialect behavior; see section [1](#).

<220> [Section 3.3.3](#): By default, Windows NT Server accepts plaintext authentication.

Windows NT Server determines **Server.LMAuthenticationPolicy** and **Server.NTLMAuthenticationPolicy** based upon the value of the `LMCompatibilityLevel` registry key. Support for NTLMv2 authentication was added in Windows NT 4.0 SP4. See [\[MSFT-SecurityWatch\]](#), [\[MSKB-239869\]](#), and [\[IMPCIFS\]](#) section 15.5.7 for further information.

<221> [Section 3.3.3](#): The default **MaxBufferSize** on Windows NT Server is 4356 (0x00001104) bytes (4KB + 260 bytes) if the server has 512 MB of memory or less. If the server has more than 512 MB of memory, the default **MaxBufferSize** is 16644 (0x00004104) bytes (16KB + 260Bytes). Windows NT Server always uses a **MaxBufferSize** value that is a multiple of four (0x00000004). The **MaxBufferSize** can be configured through the following registry setting:

```
HKLM\SYSTEM\CurrentControlSet\Services\LanmanServer\Parameters\SizReqBuf
```

<222> [Section 3.3.3](#): On Windows NT Server, the default value is 50 (0x0032). This value can be set using the **MaxMpxCt** registry key.

<223> [Section 3.3.3](#): Windows NT 3.51 servers do not support signing. Windows NT 4.0 added support for the ability to enable and require signing in Windows NT 4.0 SP3. See [\[ENSIGN\]](#) for more information.

<224> [Section 3.3.3](#): Windows servers set the **Server.MaxRawSize** value to 65,536 (0x00010000) bytes (64KB).

<225> [Section 3.3.3](#): Windows servers initialize **Server.MaxSearches** to 2048.

<226> [Section 3.3.4.1](#): When signing is neither enabled nor required:

- Windows servers do not initialize the **SecuritySignature** field in the header of the [SMB_COM_SESSION_SETUP_ANDX Response \(section 2.2.4.53.2\)](#). The value of this field is arbitrary.
- Windows clients ignore the **SecuritySignature** field.

<227> [Section 3.3.4.1.1](#): Windows-based servers set the **SMB_Header.Reserved** field of the response to the **SMB_Header.Reserved** value received in the request.

<228> [Section 3.3.4.1.2](#): If 32-bit status codes have not been negotiated, Windows-based servers convert NTSTATUS codes to their equivalent SMBSTATUS Class/Code pairs before sending the response.

<229> [Section 3.3.4.2](#): Windows servers receive the type of OpLock that has been requested to be broken from the object store, as described in [\[MS-FSA\]](#) section 2.1.5.17.3, with the following output element mapping:

- **NewOpLockLevel** is copied to the **NewOpLockLevel** field of the [SMB_COM_LOCKING_ANDX Request \(section 2.2.4.32.1\)](#).

<230> [Section 3.3.4.2](#): Windows NT Server 4.0 always sets the **Timeout**, **NumberOfUnlocks**, **NumberOfLocks**, and **ByteCount** fields to zero, and the client ignores these fields.

<231> [Section 3.3.4.3](#): Support for DFS Server capability was introduced in Windows NT Server 4.0 SP2.

<232> [Section 3.3.4.17](#): For each supported transport type as listed in section [2.1](#), the Windows CIFS server attempts to form an association with the specified device with local calls specific to each supported transport type and rejects the entry if none of the associations succeed.

<233> [Section 3.3.4.17](#): On Windows, **ServerName** is used only when the transport is [NBT \(section 2.1.1.2\)](#).

<234> [Section 3.3.4.17](#): On Windows, servers manage listening in TDI transport drivers through the interface described in [\[MSDN-MakeEndpoint\]](#).

<235> [Section 3.3.5.1](#): On Windows, the transport name is obtained from the TDI device object that was opened as part of transport initialization and returned by the new connection indication. For more information on TDI device objects, see [\[MSDN-TDIDeviceObj\]](#). Possible Windows-specific values for **Server.Connection.TransportName** are listed in a product behavior note attached to [\[MS-SRV5\]](#) section 2.2.4.96.

<236> [Section 3.3.5.1](#): Windows servers do not generate a token and always set **Server.Connection.SessionKey** to zero.

<237> [Section 3.3.5.2](#): Windows NT servers perform basic validation tests on received command requests before determining whether or not the command is Obsolete or Not Implemented. If a request is found to be incorrectly formatted, the server returns STATUS_INVALID_SMB (ERRSRV/ERRerror).

<238> [Section 3.3.5.2](#): Windows NT Server does not validate the **TID** field in SMB_COM_ECHO requests.

<239> [Section 3.3.5.2.5](#): Windows NT servers fail a transaction request with STATUS_INSUFF_SERVER_RESOURCES, if (**SetupCount** + **MaxSetupCount** + **TotalParameterCount** + **MaxParameterCount** + **TotalDataCount** + **MaxDataCount**) is greater than 65*1024.

<240> [Section 3.3.5.3](#): Windows servers create directories within the object store as described in [\[MS-FSA\]](#) sections [2.1.5.1](#) and [2.1.5.1.1](#), with the following mapping of input elements:

- **RootOpen** is provided by using the **SMB_Header.TID** field to find the matching **Server.TreeConnect** in the **Server.Connection.TreeConnectTable**. The server then acquires an **Open** on **Server.TreeConnect.Share.LocalPath**, which is passed as **RootOpen**.
- PathName is the **SMB_Data.Bytes.DirectoryName** field from the request.
- **SecurityContext** is found by using the **SMB_Header.UID** field to look up the matching **Session** entry in the **Server.Connection.SessionTable**. The **Server.Session.UserSecurityContext** is passed as **SecurityContext**.
- **DesiredAccess** is set to FILE_TRAVERSE, which has the same value as FILE_EXECUTE: 0x00000020.
- **ShareAccess** is set to 0x00000000.
- **CreateOptions** is set to FILE_DIRECTORY_FILE.
- **CreateDisposition** is set to FILE_CREATE.
- **DesiredFileAttributes** is set to FILE_ATTRIBUTE_NORMAL.
- **IsCaseSensitive** is set to FALSE if the SMB_FLAGS_CASE_INSENSITIVE bit is set in the **SMB_Header.Flags** field of the request. Otherwise, **IsCaseSensitive** is set depending upon system defaults. For more information, see the description of the OBJ_CASE_INSENSITIVE flag of the **OBJECT_ATTRIBUTES** structure [\[MSDN-OBJ_ATTRIBS\]](#).
- **OpLockKey** is empty.

The returned **Status** is copied into the **SMB_Header.Status** field of the response. If the operation is successful, the **Open** returned from the process described in [\[MS-FSA\]](#) section 2.1.5.1 is closed. All other results are ignored.

<241> [Section 3.3.5.4](#): Windows servers delete directories within the object store by opening them as described in [\[MS-FSA\]](#) section 2.1.5.1, with **DesiredAccess** set to DELETE. The following is a mapping of input elements:

- **RootOpen** is provided by using the **SMB_Header.TID** to find the matching treeConnect in the **Server.Connection.TreeConnectTable**, which in turn provides the **Server.TreeConnect.Share**. **Server.TreeConnect.Share** points to an entry in the **Server.Share** table. The **Server.Share.LocalPath** is the path to the root of the share. An Open directory handle representing **Server.Share.LocalPath** is passed as **RootOpen**.
- **PathName** is the **SMB_Data.Bytes.DirectoryName** field from the request.
- **SecurityContext** is found by using the **SMB_Header.UID** to look up the matching session entry in the **Server.Connection.SessionTable**. The **Server.Session.UserSecurityContext** is passed as **SecurityContext**.
- **DesiredAccess** is set to DELETE (0x00010000).
- **ShareAccess** is set to 0x00000000.
- **CreateOptions** is set to FILE_DIRECTORY_FILE.
- **CreateDisposition** is set to FILE_OPEN.
- **DesiredFileAttributes** is set to 0x00000000.
- **IsCaseSensitive** is set to FALSE if the SMB_FLAGS_CASE_INSENSITIVE bit is set in the **SMB_Header.Flags** field of the request. Otherwise, **IsCaseSensitive** is set depending upon system defaults. For more information, see the description of the OBJ_CASE_INSENSITIVE flag of the **OBJECT_ATTRIBUTES** structure [MSDN-OBJ_ATTRIBS].
- **OpLockKey** is empty.

The file is opened as described in [\[MS-FSA\]](#) section 2.1.5.1, and the returned **Status** is copied into the **SMB_Header.Status** field of the response. If the operation fails, the **Status** is returned in an Error Response and processing is complete.

If the operation is successful, the file is marked to be deleted when closed as described in [\[MS-FSA\]](#) section 2.1.5.14, passing the following mapping of input elements:

- **Open** is the **Open** returned in the previous operation.
- **FileInformationClass** is FileDispositionInformation. See [\[MS-FSA\]](#) section 2.1.5.14.3.
- **InputBuffer** is the FILE_DISPOSITION_INFORMATION data element specified in [\[MS-FSCC\]](#) section 2.4.11. **InputBuffer.DeletePending** is set to TRUE.
- **InputBufferLength** is the size of the FILE_DISPOSITION_INFORMATION data element.

If the Set File Information operation fails, the **Status** is returned in an Error Response and processing is complete. If the operation is successful, the **Open** is immediately closed, which results in the deletion of the file. All other results are ignored.

<242> [Section 3.3.5.4](#): Windows NT servers close any **SearchOpen** with a matching **TID** where the canonicalized directory name derived from the **SMB_Data.Bytes.DirectoryName** field is a prefix of the canonicalized full search path, including the filename portion. This could potentially result in unrelated **SearchOpens** being closed.

<243> [Section 3.3.5.5](#): Windows NT Server always ignores the **SearchAttributes** field on Open and Create operations, and searches for files by name only.

<244> [Section 3.3.5.5](#): Windows servers open files in the object store as described in [\[MS-FSA\]](#) section 2.1.5.1, with the following mapping of input elements:

- **RootOpen** is provided by using the **SMB_Header.TID** to find the matching **Server.TreeConnect** in the **Server.Connection.TreeConnectTable**. The server then acquires an **Open** on **Server.TreeConnect.Share.LocalPath**, which is passed as **RootOpen**.
- **PathName** is the **SMB_Data.Bytes.FileName** field from the request.
- **SecurityContext** is found by using the **SMB_Header.UID** to look up the matching **Session** entry in the **Server.Connection.SessionTable**. The **Server.Session.UserSecurityContext** is passed as **SecurityContext**.
- **DesiredAccess** is set as follows:
 - The **AccessMode** subfield of the **AccessMode** field in the request is used to set the value of **DesiredAccess**. The **AccessMode** subfield represents the lowest order four bits of the **AccessMode** field (0x0007), as shown in the table in section [2.2.4.3.1](#). The mapping of values is as follows.

AccessMode.AccessMode	DesiredAccess
0	GENERIC_READ 0x80000000
1	GENERIC_WRITE FILE_READ_ATTRIBUTES0x40000000 0x00000080
2	GENERIC_READ GENERIC_WRITE0x80000000 0x40000000
3	GENERIC_READ GENERIC_EXECUTE0x80000000 0x20000000

- For any other value of **AccessMode.AccessMode**, this algorithm returns STATUS_OS2_INVALID_ACCESS (ERRDOS/ERRbadaccess).
- **ShareAccess** is set as follows:
 - The **SharingMode** subfield of the **AccessMode** field in the request is used to set the value of **ShareAccess**. The **SharingMode** subfield is a 4-bit subfield of the **AccessMode** field (0x0070), as shown in the table in section [2.2.4.3.1](#). The mapping of values is as follows.

AccessMode.SharingMode	ShareAccess
0	Compatibility mode (see below)
1	0x0L (don't share, exclusive use)
2	FILE_SHARE_READ
3	FILE_SHARE_WRITE

AccessMode.SharingMode	ShareAccess
4	FILE_SHARE_READ FILE_SHARE_WRITE
0xFF	FCB mode (see below)

- For Compatibility mode, special filename suffixes (after the '.' in the filename) are mapped to **SharingMode** 4. The special filename suffix set is: "EXE", "DLL", "SYM", "COM". All other file names are mapped to **SharingMode** 3.
- For FCB mode, if the file is already open on the server, the current sharing mode of the existing **Open** is preserved and a **FID** for the file is returned. If the file is not already open on the server, the server attempts to open the file using **SharingMode** 1.
- For any other value of **AccessMode.SharingMode**, this algorithm returns STATUS_OS2_INVALID_ACCESS (ERRDOS/ERRbadaccess).
- **CreateOptions** is set to (**FILE_NON_DIRECTORY_FILE** | **FILE_COMPLETE_IF_OPLOCKED**). If the **SMB_Header.Flags2 SMB_FLAGS2_KNOWS_EAS** flag is not set, then the **FILE_NO_EA_KNOWLEDGE** bit is also set. The FILE_WRITE_THROUGH bit is set based on the **SMB_Parameters.Words.AccessMode.WritethroughMode** bit.
- **CreateDisposition** is set to **FILE_OPEN**.
- **DesiredFileAttributes** is set to FILE_ATTRIBUTE_NORMAL.
- **IsCaseSensitive** is set to FALSE if the **SMB_FLAGS_CASE_INSENSITIVE** bit is set in the **SMB_Header.Flags** field of the request. Otherwise, **IsCaseSensitive** is set depending upon system defaults. For more information, see the description of the **OBJ_CASE_INSENSITIVE** flag of the **OBJECT_ATTRIBUTES** structure [MSDN-OBJ_ATTRIBS].
- **OpLockKey** is empty.
- The returned **Status** is copied into the **SMB_Header.Status** field of the response. If the operation fails, the **Status** is returned in an Error Response and processing is complete.
- If the operation is successful, processing continues as follows:
- If the **SMB_FLAGS_OPLOCK** flag is set in the **SMB_Header.Flags** of the request, then an OpLock is being requested. Windows servers obtain OpLocks as described in [\[MS-FSA\]](#) section 2.1.5.17, with the following mapping of input elements:
 - **Open** is the **Open** passed through from the preceding operation.
 - **Type** is LEVEL_BATCH if the **SMB_FLAGS_OPBATCH** flag is set in the **SMB_Header.Flags** of the request; otherwise, it is LEVEL_ONE.
- If an OpLock is granted, the **SMB_Header.Flags SMB_FLAGS_OPLOCK** and **SMB_FLAGS_OPBATCH** flags are copied from the request to the response. Otherwise, both flags are set to zero in the response.
- The **SMB_Parameters.Words.AccessMode** from the request is copied to the response.
- Windows servers obtain the **SMB_Parameters.Words.FileAttributes** and **SMB_Parameters.Words.LastModified** response field values by querying file information from the object store as described in [\[MS-FSA\]](#) section 2.1.5.11, with the following mapping of input elements:

- **Open** is the **Open** passed through from the preceding operations.
- **FileInformationClass** is **FileBasicInformation**.
- If the query fails, the **Status** is returned in an Error Response and processing is complete. Otherwise:
 - **SMB_Parameters.Words.FileAttributes** is set to `OutputBuffer.FileAttributes`.
 - **SMB_Parameters.Words.LastModified** is set to `OutputBuffer.ChangeTime`.
- Windows servers obtain the **SMB_Parameters.Words.FileSize** response field values by querying file information from the object store as described in [\[MS-FSA\]](#) section 2.1.5.11, with the following mapping of input elements:
 - **Open** is the **Open** passed through from the preceding operations.
 - **FileInformationClass** is **FileStandardInformation**.
- If the query fails, the **Status** is returned in an Error Response and processing is complete. Otherwise:
 - **SMB_Parameters.Words.FileSize** is set to the lowest-order 32 bits of `OutputBuffer.EndOfFile`.
- If the query fails, the **Status** is returned in an Error Response and processing is complete.
- A new **FID** is generated for the **Open** returned. All of the other results of the **Open** operation are ignored. The **FID** is copied into the **SMB_Parameters.Words.FID** field of the response.

While opening an existing file, the underlying object store checks for the necessity of an Oplock break, as described in [\[MS-FSA\]](#) section 2.1.4.12, and if necessary, notifies the server, as described in section [3.3.4.2](#) and defers the opening of the file until the server acknowledges the Oplock break, as described in section [3.3.5.30](#).

<245> [Section 3.3.5.6](#): Windows servers ignore the **CreationTime** field in the [SMB_COM_CREATE Request \(section 2.2.4.4.1\)](#).

<246> [Section 3.3.5.6](#): When opening, overwriting, deleting, or renaming a file, Windows NT Server checks for sharing violations. If a sharing violation would be generated by the operation, by default the server delays for 200 ms and then tests again for a sharing violation. By default the server retries five times, for a total delay of approximately one second, before giving up and returning the sharing violation error. The sharing violation delay time and number of retries are configurable as described in [\[MSKB-150384\]](#).

<247> [Section 3.3.5.6](#): Windows servers create files in the object store as described in [\[MS-FSA\]](#) section 2.1.5.1, with the following mapping of input elements:

- **RootOpen** is provided by using the **SMB_Header.TID** to find the matching **TreeConnect** in the **Server.Connection.TreeConnectTable**, which in turn provides the **Server.TreeConnect.Share**. **Server.TreeConnect.Share** points to an entry in the **Server.Share** table. The **Server.Share.LocalPath** is the path to the root of the share. An Open directory handle representing **Server.Share.LocalPath** is passed as **RootOpen**.
- **PathName** is the **SMB_Data.Bytes.FileName** field from the request.

- **SecurityContext** is found by using the **SMB_Header.UID** to look up the matching **Session** entry in the **Server.Connection.SessionTable**. The **Server.Session.UserSecurityContext** is passed as **SecurityContext**.
- **DesiredAccess** is set to (GENERIC_READ | GENERIC_WRITE).
- **ShareAccess** is set to FILE_SHARE_WRITE. If the file extension (after the "." in the filename) is in the special filename suffix set ("EXE", "DLL", "SYM", "COM"), ShareAccess is set to FILE_SHARE_WRITE | FILE_SHARE_READ).
- **DesiredFileAttributes** is set as follows:
 - **DesiredFileAttributes** is set to the bitwise AND of the **FileAttributes** field in the request and
(SMB_FILE_ATTRIBUTE_READONLY |
SMB_FILE_ATTRIBUTE_HIDDEN |
SMB_FILE_ATTRIBUTE_SYSTEM |
SMB_FILE_ATTRIBUTE_ARCHIVE |
SMB_FILE_ATTRIBUTE_DIRECTORY).
 - If the resulting value of **DesiredFileAttributes** is zero, **DesiredFileAttributes** is set to FILE_ATTRIBUTE_NORMAL.
- **CreateDisposition** is set to FILE_OVERWRITE_IF.
 - If the **SMB_Header.Flags2 SMB_FLAGS2_KNOWN_EAS** flag is not set, the FILE_NO_EA_KNOWLEDGE bit is also set.
- **CreateOptions** is set to **FILE_NON_DIRECTORY_FILE**.
 - If the **WritethroughMode** bit of the **SMB_Parameters.Words.AccessMode** field is set, the FILE_WRITE_THROUGH bit is also set.
- **OpLockKey** is empty.

The returned **Status** is copied into the **SMB_Header.Status** field of the response. If the operation fails, the **Status** is returned in an Error Response and processing is complete.

If the operation is successful, processing continues as follows:

- If the **SMB_FLAGS_OPLOCK** flag is set in the **SMB_Header.Flags** of the request, an OpLock is being requested. Windows servers obtain OpLocks as described in [\[MS-FSA\]](#) section 2.1.5.17, with the following mapping of input elements:
 - **Open** is the **Open** passed through from the preceding operation.
 - **Type** is LEVEL_BATCH if the **SMB_FLAGS_OPBATCH** flag is set in the **SMB_Header.Flags** of the request; otherwise, it is LEVEL_ONE.

If an OpLock is granted, the **SMB_Header.Flags SMB_FLAGS_OPLOCK** and **SMB_FLAGS_OPBATCH** flags are copied from the request to the response. Otherwise, both flags are set to zero in the response.

- Windows servers set the **LastWriteTime** of the file if the **SMB_Parameters.Words.CreationTime** in the request is not zero or -1 (0xFFFFFFFF). Windows servers set this value as described in [\[MS-FSA\]](#) section 2.1.5.14, with the following mapping of input elements:
 - **Open** is the **Open** passed through from the preceding operations.
 - **FileInformationClass** is **FileBasicInformation**.
 - **InputBuffer.CreationTime**, **InputBuffer.LastAccessTime**, **InputBuffer.ChangeTime**, and **InputBuffer.FileAttributes** are each set to zero.
 - **InputBuffer.LastWriteTime** is set to the time value in **SMB_Parameters.Words.CreationTime**.

The result of the set operation is ignored.

- A new **FID** is generated for the **Open** returned. All of the other results of the Open operation are ignored. The **FID** is copied into the **SMB_Parameters.Words.FID** field of the response.

<248> [Section 3.3.5.7](#): Windows servers update the last modification time for the file, as described in [\[MS-FSA\]](#) section 2.1.15.14.2, with the following mapping of input elements:

- **Open** is the **Open** corresponding to the input **FID**.
- **InputBuffer.LastWriteTime** is set to **SMB_Parameters.Word.LastTimeModified**.
- **FileInformationClass** is [FileBasicInformation](#) ([\[MS-FSCC\]](#) section 2.4.7).
- **InputBuffer.CreationTime**, **InputBuffer.LastAccessTime**, **InputBuffer.ChangeTime** and **InputBuffer.FileAttributes** are all set to zero.

<249> [Section 3.3.5.7](#): Windows servers close an existing **Open** in the object store as described in [\[MS-FSA\]](#) section 2.1.5.4, Server Requests Closing an Open. The returned status is copied into the **SMB_Header.Status** field of the response. Any Oplocks held by the **Open** are cleaned up as described in Phase 8 -- Oplock Cleanup in [\[MS-FSA\]](#) section 2.1.5.4.

<250> [Section 3.3.5.7](#): Windows servers release a byte-range lock from the underlying object store as described in [\[MS-FSA\]](#) section 2.1.5.8, with the following mapping of input elements for each element **X** in the **Server.Open.Locks** array:

- **Open** is the **Open** indicated by the **FID**.
- **FileOffset** is the **Server.Open.Locks[X].ByteOffset** if the entry is formatted as a **LOCKING_ANDX_RANGE32** structure, or **Server.Open.Locks[X].ByteOffsetHigh** and **Unlocks[X].ByteOffsetLow** if the entry is formatted as a **LOCKING_ANDX_RANGE64** structure.
- **LOCKING_ANDX_RANGE32** structure, or **Server.Open.Locks[X].LengthInBytesHigh** and **Server.Open.Locks[X].LengthInBytesLow** if the entry is formatted as a **LOCKING_ANDX_RANGE64** structure

<251> [Section 3.3.5.8](#): Windows servers flush a file by passing the **Open** to the algorithm described in [\[MS-FSA\]](#) section 2.1.5.6. The returned Status is copied into the **SMB_Header.Status** field of the response.

<252> [Section 3.3.5.9](#): Windows processes any required Oplock break notification to SMB prior to deletion via the interface described in [\[MS-FSA\]](#) section 2.1.5.17.3 and defers the delete operation until acknowledged via the interface in [\[MS-FSA\]](#) section 2.1.5.18.

<253> [Section 3.3.5.9](#): The [XOPEN-SMB] specification (section 7.12) indicates that the server deletes all files matching the search criteria that it can delete and returns Success if any is deleted, stating "If a wildcard pathname matches more than one file, and not all of the files could be unlinked, the request fails silently". Windows NT CIFS servers search for and delete files matching the search criteria in a sequential fashion. If an error occurs, processing stops, and the error is returned in the **Status** field of an error response message. No more matching files are deleted.

<254> [Section 3.3.5.9](#): When opening, overwriting, deleting, or renaming a file, Windows NT Server checks for sharing violations. If a sharing violation would be generated by the operation, the server delays for 200 ms and then tests again for a sharing violation. The server retries five times, for a total delay of approximately one second, before giving up and returning the sharing violation error.

<255> [Section 3.3.5.9](#): Windows servers implement wildcard file deletion as a three-step process.

Step 1: Wildcard Matching

Windows servers match wildcard patterns within directories as described in [\[MS-FSA\]](#) section 2.1.5.5. The following is a mapping of input elements:

- **Open** is an Open resulting from opening the directory portion of the **SMB_Data.Bytes.FileName** field from the request.
- **FileNamePattern** is the final component of the **FileName** field.

If the operation fails, the **Status** is returned in an Error Response and processing is complete. Otherwise, all files that match the **FileNamePattern** are candidates for deletion. The next step is performed for each file that matches the wildcard pattern.

Step 2: SearchAttribute Filtering

Windows servers match **SearchAttributes** as follows:

If both **SMB_FILE_ATTRIBUTE_HIDDEN** and **SMB_FILE_ATTRIBUTE_SYSTEM** are specified in **SearchAttributes**, all files match.

If either or both of the **SMB_FILE_ATTRIBUTE_HIDDEN** or **SMB_FILE_ATTRIBUTE_SYSTEM** are not set, the server queries the object store for the attributes of the file.

- Windows servers obtain **FileAttributes** values by querying file information from the object store as described in [\[MS-FSA\]](#) section 2.1.5.11, with the following mapping of input elements:
 - **Open** is the Open resulting from opening the file to be queried.
 - **FileInformationClass** is **FileBasicInformation**.

If the query fails, the file does not match and is not deleted. Otherwise:

- All bits except the **SMB_FILE_ATTRIBUTE_HIDDEN** and **SMB_FILE_ATTRIBUTE_SYSTEM** bits are cleared from the **FileAttributes** returned from the query operation.

$\text{FileAttributes} \&= (\text{FILE_ATTRIBUTE_SYSTEM} | \text{FILE_ATTRIBUTE_HIDDEN})$

- If the Value of **FileAttributes**, cast to a USHORT, does not exactly match **SearchAttributes**, the file does not match and is not deleted. Otherwise, the **Open** is closed and the matching **FileName** is passed to the next step.

Step 3: File Deletion

If there are no matching **FileNames** to be deleted, the server returns an Error Response with **Status** set to STATUS_NO_SUCH_FILE (ERRDOS/ERRbadfile) and processing is complete. Otherwise:

Windows servers delete files and directories within the object store by opening them as described in [\[MS-FSA\]](#) section 2.1.5.1 with **DesiredAccess** set to DELETE. The following is a mapping of input elements:

- **RootOpen** is provided by using the **SMB_Header.TID** to find the matching **TreeConnect** in the **Server.Connection.TreeConnectTable**, which in turn provides the **Server.TreeConnect.Share**. **Server.TreeConnect.Share** points to an entry in the **Server.Share** table. The **Server.Share.LocalPath** is the path to the root of the share. An **Open** directory handle representing **Server.Share.LocalPath** is passed as **RootOpen**.
- **PathName** is the **FileName** generated as a result of the wildcard matching step.
- **SecurityContext** is found by using the **SMB_Header.UID** to look up the matching **Session** entry in the **Server.Connection.SessionTable**. The **Server.Session.UserSecurityContext** is passed as **SecurityContext**.
- **DesiredAccess** is set to **DELETE** (0x00010000).
- **ShareAccess** is set to 0x00000000.
- **CreateOptions** is set to **FILE_NON_DIRECTORY_FILE**.
- **CreateDisposition** is set to **FILE_OPEN**.
- **DesiredFileAttributes** is set to 0x00000000.
- **IsCaseSensitive** is set to FALSE if the **SMB_FLAGS_CASE_INSENSITIVE** bit is set in the **SMB_Header.Flags** field of the request. Otherwise, **IsCaseSensitive** is set depending upon system defaults. For more information, see the description of the **OBJ_CASE_INSENSITIVE** flag of the **OBJECT_ATTRIBUTES** structure [\[MSDN-OBJ_ATTRIBS\]](#).
- **OpLockKey** is empty.

The file is opened as described in [\[MS-FSA\]](#) section 2.1.5.1, and the returned **Status** is copied into the **SMB_Header.Status** field of the response. If the operation fails, the **Status** is returned in an Error Response, and processing is complete.

If the operation is successful, the file is marked to be deleted when closed as described in [\[MS-FSA\]](#) section 2.1.5.14, passing the following mapping of input elements:

- **Open** is the **Open** returned in the previous operation.
- **FileInformationClass** is **FileDispositionInformation**. See [\[MS-FSA\]](#) section 2.1.5.14.3.
- **InputBuffer** is the FILE_DISPOSITION_INFORMATION data element specified in [\[MS-FSCC\]](#). **InputBuffer.DeletePending** is set to TRUE.
- **InputBufferLength** is the size of the FILE_DISPOSITION_INFORMATION data element.

If the Set File Information operation fails, the **Status** is returned in an Error Response, and processing is complete. If the operation is successful, the **Open** is immediately closed, which results in the deletion of the file. All other results are ignored.

<256> [Section 3.3.5.10](#): Windows servers implement wildcard file rename as a three-step process.

Step 1: Old Filename Wildcard Matching

Windows servers match wildcard patterns within directories as described in [\[MS-FSA\]](#) section 2.1.5.5. The following is a mapping of input elements:

- **Open** is an **Open** resulting from opening the directory portion of the **SMB_Data.Bytes.OldFileName** field from the request.
- **FileNamePattern** is the final component of the **OldFileName** field.

If the operation fails, the **Status** is returned in an Error Response, and processing is complete. Otherwise, all files that match the **FileNamePattern** are candidates for deletion. The next step is performed for each file that matches the wildcard pattern.

Step 2: SearchAttribute Filtering

Windows servers match **SearchAttributes** as follows:

If both **SMB_FILE_ATTRIBUTE_HIDDEN** and **SMB_FILE_ATTRIBUTE_SYSTEM** are specified in **SearchAttributes**, then all files match.

If either or both of the **SMB_FILE_ATTRIBUTE_HIDDEN** or **SMB_FILE_ATTRIBUTE_SYSTEM** are not set, the server queries the object store for the attributes of the file.

- Windows servers obtain **FileAttributes** values by querying file information from the object store as described in [\[MS-FSA\]](#) section 2.1.5.11, with the following mapping of input elements:
 - **Open** is the **Open** resulting from opening the **FileName** to be queried.
 - **FileInformationClass** is **FileBasicInformation**.

If the open or the query fails, the file does not match and is not renamed. Otherwise:

- All bits except the **SMB_FILE_ATTRIBUTE_HIDDEN** and **SMB_FILE_ATTRIBUTE_SYSTEM** bits are cleared from the **FileAttributes** returned from the query operation.

FileAttributes &= (**FILE_ATTRIBUTE_SYSTEM** | **FILE_ATTRIBUTE_HIDDEN**)

- If the value of **FileAttributes** cast to a **USHORT** does not exactly match **SearchAttributes**, the file does not match and is not renamed. Otherwise, the **Open** is passed to the next step.

Step 3: Rename

Windows servers rename files as described in [\[MS-FSA\]](#) section 2.1.5.14. The following is a mapping of input elements:

- **Open** is an **Open** resulting from opening the **OldFileName**, as provided by the preceding steps.
- **FileInformationClass** is **FileRenameInformation**.
- **ReplaceIfExists** is **FALSE**.

- **RootOpen** is provided by using the **SMB_Header.TID** to find the matching **TreeConnect** in the **Server.Connection.TreeConnectTable**, which in turn provides the **Server.TreeConnect.Share**. **Server.TreeConnect.Share** points to an entry in the **Server.Share** table. The **Server.Share.LocalPath** is the path to the root of the share. An **Open** directory handle representing **Server.Share.LocalPath** is passed as **RootOpen**.
- **FileName** is generated from the **OldFileName** and the wildcard pattern in **NewFileName**. A description of the wildcard mapping that produces **FileName** is given in [XOPEN-SMB] section 3.6.
- **FileNameLength** is the length, in bytes, of the new **FileName**. The length includes the trailing null byte(s), if present.

The returned **Status** is copied into the **SMB_Header.Status** field of the response. The **Open** is closed. All other results are ignored.

<257> [Section 3.3.5.10](#): When opening, overwriting, deleting, or renaming a file, Windows NT Server checks for sharing violations. If a sharing violation would be generated by the operation, the server delays for 200 ms and then tests again for a sharing violation. The server retries five times, for a total delay of approximately one second, before giving up and returning the sharing violation error.

<258> [Section 3.3.5.10](#): Windows processes any required OpLock break notification to SMB prior to deletion via the interface described in [\[MS-FSA\]](#) section 2.1.5.17.3 and pends the delete operation until acknowledged via the interface described in [\[MS-FSA\]](#) section 2.1.5.18.

<259> [Section 3.3.5.11](#): Windows servers obtain file information from the object store as described in [\[MS-FSA\]](#) section 2.1.5.11, with the following mapping of input elements:

- **Open** is created by opening the file indicated by **FileName** in the request. If the open operation fails, the **Status** is returned in an Error Response and processing is complete. While opening the file, the underlying object store checks for the necessity of an OpLock break, as described in [\[MS-FSA\]](#) section 2.1.4.12, and if necessary, notifies the server as specified in section [3.3.4.2](#) and defers the opening of the file until the server acknowledges the Oplock break, as specified in section [3.3.5.30](#).
- **FileInformationClass** is **FileNetworkOpenInformation**.

<260> [Section 3.3.5.12](#): In order to set file attributes and the time of the last write to the file, Windows NT CIFS servers open the file in the object store as described in [\[MS-FSA\]](#) section 2.1.5.1. While opening the file, the underlying object store checks for the necessity of an OpLock break, as described in [\[MS-FSA\]](#) section 2.1.4.12, and if necessary, notifies the server via section [3.3.4.2](#) and defers the opening of the file until the server acknowledges the Oplock break, as specified in section [3.3.5.30](#).

Windows servers set the **LastWriteTime** of the file if the **SMB_Parameters.Words.LastWriteTime** field in the request is not zero or -1 (0xFFFFFFFF). Windows servers set this value as described in [\[MS-FSA\]](#) section 2.1.5.14.2, with the following mapping of input elements:

- **Open** is created by opening the file indicated by **FileName** field in the request. If the open operation fails, the **Status** is returned in an Error Response, and processing is complete.
- **FileInformationClass** is **FileBasicInformation**.
- **InputBuffer.CreationTime**, **InputBuffer.LastAccessTime**, **InputBuffer.ChangeTime**, and **InputBuffer.FileAttributes** are all set to zero.

- **InputBuffer.LastWriteTime** is set to the time value in the **SMB_Parameters.Words.LastWriteTime** field.

The returned **Status** is copied into the **SMB_Header.Status** field of the response. The **Open** is closed. All other results are ignored.

<261> [Section 3.3.5.13](#): Windows servers request a read of the file from the object store as described in [\[MS-FSA\]](#) section [2.1.5.2](#), with the following mapping of input elements:

- **Open** is the **Open** indicated by the **SMB_Parameters.Words.FID** field of the request.
- **ByteOffset** is the **SMB_Parameters.Words.ReadOffsetInBytes** field of the request.
- **ByteCount** is the **SMB_Parameters.Words.CountOfBytesToRead** field of the request.
- **IsNonCached** is not used.
- **Key** is set to $((\text{Open.FID} \ll 16) \mid \text{Open.PID.PIDLow})$.

The returned **Status** is copied into the **SMB_Header.Status** field of the response. If the operation is successful, the following additional mapping of output elements applies:

- **OutputBuffer** is copied into the **SMB_Data.Bytes.Bytes** field of the response.
- **BytesRead** is copied into both the **SMB_Parameters.Words.CountOfBytesReturned** and **SMB_Data.Bytes.CountOfBytesRead** fields of the response.

<262> [Section 3.3.5.14](#): Windows servers request a write to a file in the object store as described in [\[MS-FSA\]](#) section [2.1.5.3](#), with the following mapping of input elements:

- **Open** is the **Open** indicated by the **SMB_Parameters.Words.FID** field of the request.
- **ByteOffset** is the **SMB_Parameters.Words.WriteOffsetInBytes** field of the request.
- **ByteCount** is the **SMB_Parameters.Words.CountOfBytesToWrite** field of the request.
- **IsWriteThrough** is set to TRUE if **Open.IsWriteThrough** is TRUE.
- **IsNonCached** is not used.
- **InputBuffer** is copied from the **SMB_Data.Bytes.Bytes** field of the request.
- **Key** is set to $((\text{Open.FID} \ll 16) \mid \text{Open.PID.PIDLow})$.

The returned **Status** is copied into the **SMB_Header.Status** field of the response. If the write fails, the **Status** is returned in an Error Response, and processing is complete. If the operation is successful, the following additional mapping of output elements applies:

- **BytesWritten** is copied into the **SMB_Parameters.Words.CountOfBytesWritten** field of the response.

<263> [Section 3.3.5.15](#): Windows servers request a byte-range lock from the underlying object store as described in [\[MS-FSA\]](#) section [2.1.5.7](#), with the following mapping of input elements:

- **Open** is the **Open** indicated by the **SMB_Parameters.Words.FID** field of the request.
- **FileOffset** is the **SMB_Parameters.Words.LockOffsetInBytes** field of the request.
- **Length** is the **SMB_Parameters.Words.CountOfBytesToLock** field of the request.

- **ExclusiveLock** – TRUE
- **FailImmediately** – TRUE
- **LockKey** is set to $((\text{Open.FID} \ll 16) | \text{Open.PID.PIDLow})$.

The returned **Status** is copied into the **SMB_Header.Status** field of the response.

<264> [Section 3.3.5.15](#): The default timeout for lock violations on Windows NT CIFS servers is 250 milliseconds.

<265> [Section 3.3.5.16](#): Windows servers release a byte-range lock from the underlying object store as described in [\[MS-FSA\]](#) section [2.1.5.8](#), with the following mapping of input elements:

- **Open** is the **Open** indicated by the **SMB_Parameters.Words.FID** field of the request.
- **FileOffset** is the **SMB_Parameters.Words.UnlockOffsetInBytes** field of the request
- **Length** is the **SMB_Parameters.Words.CountOfBytesToUnlock** field of the request.
- **LockKey** is set to $((\text{Open.FID} \ll 16) | \text{Open.PID.PIDLow})$.

The returned Status is copied into the **SMB_Header.Status** field of the response.

<266> [Section 3.3.5.17](#): Windows servers create temporary files in the object store as described in [\[MS-FSA\]](#) section 2.1.5.1, with the following mapping of input elements:

- **RootOpen** is provided by using the **SMB_Header.TID** to find the matching **TreeConnect** in the **Server.Connection.TreeConnectTable**, which in turn provides the **Server.TreeConnect.Share**. **Server.TreeConnect.Share** points to an entry in the **Server.Share** table. The **Server.Share.LocalPath** is the path to the root of the share. An Open directory handle representing **Server.Share.LocalPath** is passed as **RootOpen**.
- **PathName** is created by combining the **SMB_Data.Bytes.DirectoryName** field from the request with a pseudo-randomly generated file name. Windows servers generate file names in the form SRVxxxxx, where xxxxx is a hexadecimal integer.
- **SecurityContext** is found by using the **SMB_Header.UID** to look up the matching **Session** entry in the **Server.Connection.SessionTable**. The **Server.Session.UserSecurityContext** is passed as **SecurityContext**.
- **DesiredAccess** is set to $(\text{GENERIC_READ} | \text{GENERIC_WRITE})$.
- **ShareAccess** is set to FILE_SHARE_WRITE . If the file extension (after the '.' in the filename) is in the special filename suffix set ("EXE", "DLL", "SYM", "COM"), then **ShareAccess** is set to $\text{FILE_SHARE_WRITE} | \text{FILE_SHARE_READ}$.
- **DesiredFileAttributes** is set to $\text{FILE_ATTRIBUTE_NORMAL}$.
- **CreateDisposition** is set to FILE_CREATE .
 - If the **SMB_Header.Flags2 SMB_FLAGS2_KNOWS_EAS** flag is not set, then the $\text{FILE_NO_EA_KNOWLEDGE}$ bit is also set.
- **CreateOptions** is set to $\text{FILE_NON_DIRECTORY_FILE}$.
 - If the WritethroughMode bit of the **SMB_Parameters.Words.AccessMode** field is set, then the $\text{FILE_WRITE_THROUGH}$ bit is also set.

- **OpLockKey** is empty.

The returned **Status** is copied into the **SMB_Header.Status** field of the response. If the operation fails, the **Status** is returned in an Error Response, and processing is complete.

If the operation is successful, processing continues as follows:

- If the **SMB_FLAGS_OPLOCK** flag is set in the **SMB_Header.Flags** of the request, then an OpLock is being requested. Windows servers obtain OpLocks as described in [\[MS-FSA\]](#) section 2.1.5.17, with the following mapping of input elements:
 - **Open** is the **Open** passed through from the preceding operation.
 - **Type** is LEVEL_BATCH if the **SMB_FLAGS_OPBATCH** flag is set in the **SMB_Header.Flags** of the request; otherwise, it is LEVEL_ONE.

If an OpLock is granted, the **SMB_Header.Flags SMB_FLAGS_OPLOCK** and **SMB_FLAGS_OPBATCH** flags are copied from the request to the response. Otherwise, both flags are set to zero in the response.

- Windows servers ignore the **SMB_Parameters.Words.CreationTime** in this request.
- A new **FID** is generated for the **Open** returned. All of the other results of the **Open** operation are ignored. The **FID** is copied into the **SMB_Parameters.Words.FID** field of the response. The pseudo-randomly generated file name is returned as a null-terminated OEM_STRING in the **SMB_Data.Bytes.TemporaryFileName** field.

<267> [Section 3.3.5.18](#): Windows servers process this command as an SMB_COM_CREATE request, as specified in section [3.3.5.6](#), with the exception that **CreateDisposition** is set to FILE_CREATE instead of FILE_OVERWRITE_IF.

<268> [Section 3.3.5.19](#): Windows servers obtain file information from the object store as described in [\[MS-FSA\]](#) section 2.1.5.11, with the following mapping of input elements:

- **Open** is created by opening the **DirectoryName** in the request as a directory. If the open operation fails, the Status is returned in an Error Response and processing is complete.
- **FileInformationClass** is **FileNetworkOpenInformation**.

The returned **Status** is copied into the **SMB_Header.Status** field of the response. **Success** indicates that the **DirectoryName** is the name of an existing directory.

<269> [Section 3.3.5.20](#): Windows servers close an existing **Open** in the object store as described in [\[MS-FSA\]](#) section 2.1.5.4, Server Requests Closing an Open. Any Oplocks held by the **Open** are cleaned up as described in Phase 8 -- Oplock Cleanup in [\[MS-FSA\]](#) section 2.1.5.4.

<270> [Section 3.3.5.20](#): Windows NT Server 4.0 does not use the header **CID** field as a lookup key. The list of pending requests is associated with the SMB transport, so the effect is the same.

<271> [Section 3.3.5.21](#): Windows servers query file information from the object store as described in [\[MS-FSA\]](#) section 2.1.5.11. Windows servers set information on files in the object store as described in [\[MS-FSA\]](#) section 2.1.5.14. File position can be set or retrieved with the following mapping of input elements:

Open is the Open indicated by the **SMB_Parameters.Words.FID** field of the request.

FileInformationClass is **FilePositionInformation**.

If **SMB_Parameters.Words.Mode** is 0x0000, the new current position is set; next, **InputBuffer.CurrentByteOffset** (see [\[MS-FSA\]](#) section 2.1.5.14.9) is set to **SMB_Parameters.Words.Offset**.

If **SMB_Parameters.Words.Mode** is 0x0001, the **CurrentByteOffset** is read by sending a query (see [\[MS-FSA\]](#) section 2.1.5.11.23). The **OutputBuffer.CurrentByteOffset** is then added to **SMB_Parameters.Words.Offset**, and the result is stored in **InputBuffer.CurrentByteOffset**.

If **SMB_Parameters.Words.Mode** is 0x0001, the file size is read by setting **FileInformationClass** to **FileStandardInformation**. **SMB_Parameters.Words.Offset** is then subtracted from **OutputBuffer.EndOfFile**. The result is stored in **InputBuffer.CurrentByteOffset**. **FileInformationClass** is reset to **FilePositionInformation**.

The new file position is then set as described in [\[MS-FSA\]](#) section 2.1.5.14. The returned **Status** is copied into the **SMB_Header.Status** field of the response. If the operation fails, the **Status** is returned in an Error Response, and processing is complete. If the operation is successful, the **InputBuffer.CurrentByteOffset** is copied to the **SMB_Parameters.Words.Offset** field of the response.

<272> [Section 3.3.5.22](#): Windows servers process this command as if it were an **SMB_COM_LOCK_BYTE_RANGE** (section 2.2.4.13) followed by an **SMB_COM_READ** (section 2.2.4.11). See the behavior notes in sections [3.3.5.15](#) and [3.3.5.13](#).

<273> [Section 3.3.5.23](#): With one exception, Windows servers process this command as if it were an **SMB_COM_WRITE** followed by an **SMB_COM_UNLOCK_BYTE_RANGE**. See the behavior notes for sections [3.3.5.14](#) and [3.3.5.16](#). The exception is that the write and unlock requests are passed to the underlying file system in a single step.

<274> [Section 3.3.5.24](#): Windows servers request a raw read of the file from the object store, as described in [\[MS-FSA\]](#) section 2.1.5.2, with the following mapping of input elements:

- **Open** is the **Open** indicated by the **SMB_Parameters.Words.FID** field of the request.
- **ByteOffset** is the **SMB_Parameters.Words.ReadOffsetInBytes** field of the request.
- **ByteCount** is the **SMB_Parameters.Words.CountOfBytesToRead** field of the request.
- **IsNonCached** is not used.
- **Key** is set to ((**Open.FID** << 16) | **Open.PID.PIDLow**).

Due to this command's not returning an SMB message as a response, the **Status** field is not sent to the client in the event of an error. If **Status** indicates an error, the server simply sends a zero-length response to the client. If the operation is successful, the following additional mapping of output elements applies:

- **OutputBuffer** is the raw data to be sent to the client over the SMB transport.
- **BytesRead** is not used

<275> [Section 3.3.5.24](#): Windows servers ignore the **Timeout** field.

<276> [Section 3.3.5.25](#): Windows servers request a multiplexed read of the file from the object store as described in [\[MS-FSA\]](#) section 2.1.5.2, with the following mapping of input elements:

- **Open** is the **Open** indicated by the **SMB_Parameters.Words.FID** field of the request.
- **ByteOffset** is the **SMB_Parameters.Words. Offset** field of the request.

- **ByteCount** is the **SMB_Parameters.Words.MaxCountOfBytesToReturn** field of the request.
- **IsNonCached** is not used.
- **Key** is set to $((\text{Open.FID} \ll 16) | \text{Open.PID.PIDLow})$.

The returned **Status** is copied into the **SMB_Header.Status** field of the response. If the operation is successful, the following additional mapping of output elements applies:

- **OutputBuffer** is divided among the **SMB_Data.Bytes.Data** fields of however many responses that the server needs to send to the client to complete the operation.
- **BytesRead**: The sum of all the **SMB_Parameters.Words.DataLength** fields across however many responses that the server needs to send add up to this value.

<277> [Section 3.3.5.25](#): Windows NT and Windows 98 clients and Windows NT Server support this command on connectionless transports only. In particular, clients can send this command only over the Direct IPX Transport. Windows NT Server does not support the use of SMB_COM_READ_MPX to read from named pipes or I/O devices. Server support for this command is indicated by the CAP_MPX_MODE Capability bit in the SMB_COM_NEGOTIATE response.

<278> [Section 3.3.5.25](#): Windows servers ignore the **Timeout** field.

<279> [Section 3.3.5.26](#): Windows NT servers do not validate the **DataOffset** field value.

<280> [Section 3.3.5.26](#): If raw mode data buffers or other resources are not available, Windows NT Server fails the SMB_COM_WRITE_RAW request without writing the initial data. Likewise, if the FID represents a named pipe or device, the write operation might block, and if there are insufficient resources to buffer the data while waiting to write it, Windows NT fails the request without writing the initial data.

<281> [Section 3.3.5.26](#): Windows servers ignore the **Timeout** field.

<282> [Section 3.3.5.26](#): [XOPEN-SMB] specifies that if all of the data to be written is contained in the initial request, the server has to send an Interim Server Response and the client has to send a zero-length raw write. Older clients can exhibit that behavior. Windows NT Server, however, behaves as specified in section [3.3.5.26](#) of this document. If all of the data was transferred in the initial request, the NT server sends a Final Server Response indicating that the entire write operation has been completed.

<283> [Section 3.3.5.28](#): Windows servers obtain file information from the object store as described in [\[MS-FSA\]](#) section 2.1.5.11, with the following mapping of input elements:

- **Open** is the **Open** indicated by the **SMB_Parameters.Words.FID** field of the request.
- **FileInformationClass** is **FileNetworkOpenInformation**.

If the query fails, the **Status** is returned in an Error Response and processing is complete. Otherwise, the response message fields are populated as follows:

- The **SMB_DATE** and **SMB_TIME** fields in the **SMB_Parameters.Words** block of the response are set by converting the FILETIME fields with matching names to SMB_DATE/SMB_TIME format.
 - **CreateDate** and **CreationTime** are derived from **OutputBuffer.CreationTime**.
 - **LastAccessDate** and **LastAccessTime** are derived from **OutputBuffer.LastAccessTime**.

- **LastWriteDate** and **LastWriteTime** are derived from **OutputBuffer.LastModificationTime**.
- **OutputBuffer.ChangeTime** is not returned to the client.
- **SMB_Parameters.Words.FileDataSize** is set to **OutputBuffer.EndOfFile**.
- **SMB_Parameters.Words.FileAllocationSize** is set to **OutputBuffer.AllocationSize**.
- **SMB_Parameters.Words.FileAttributes** is set by converting **OutputBuffer.FileAttributes** from the 32-bit SMB_EXT_FILE_ATTR format to the 16-bit SMB_FILE_ATTRIBUTE format (see sections [2.2.1.2.4](#) and [2.2.1.2.3](#)).

```
FileAttributes &= ( SMB_FILE_ATTRIBUTE_READONLY |
                  SMB_FILE_ATTRIBUTE_HIDDEN   |
                  SMB_FILE_ATTRIBUTE_SYSTEM   |
                  SMB_FILE_ATTRIBUTE_ARCHIVE  |
                  SMB_FILE_ATTRIBUTE_DIRECTORY )
```

<284> [Section 3.3.5.29](#): Windows servers set file information from the object store as described in [\[MS-FSA\]](#) section 2.1.5.14, with the following mapping of input elements:

- **Open** is the **Open** indicated by the **SMB_Parameters.Words.FID** field of the request.
- **FileInformationClass** is set to **FileBasicInformation**.
- The **SMB_DATE** and **SMB_TIME** fields in the **SMB_Parameters.Words** block of the request are converted to **FILETIME** fields with matching names to SMB_DATE/SMB_TIME format:
 - **CreateDate** and **CreationTime** are converted and copied to **InputBuffer.CreationTime**.
 - **LastAccessDate** and **LastAccessTime** are converted and copied to **InputBuffer.LastAccessTime**.
 - **LastWriteDate** and **LastWriteTime** are converted and copied to **OutputBuffer.LastModificationTime**.
 - **InputBuffer.ChangeTime** is set to zero (0).

The **Status** returned is copied into the **SMB_Header.Status** field of the response.

<285> [Section 3.3.5.30](#): If an [SMB_COM_LOCKING_ANDX Request](#) has a nonzero **NumberOfRequestedUnlocks** field, Windows servers release a byte-range lock from the underlying object store as described in [\[MS-FSA\]](#) section 2.1.5.8, with the following mapping of input elements for each element "X" in the **SMB_Data.Bytes.Unlocks** array:

- **Open** is the **Open** indicated by the **SMB_Parameters.Words.FID** field of the request.
- **FileOffset** is the **Unlocks[X].ByteOffset** field of the request for LOCKING_RANGE_ANDX32, or **Unlocks[X].ByteOffsetHigh** and **Unlocks[X].ByteOffsetLow** for LOCKING_ANDX_RANGE64.
- **Length** is the **Unlocks[X].LengthInBytes** field of the request for LOCKING_RANGE_ANDX32, or **Unlocks[X].LengthInBytesHigh** and **Unlocks[X].LengthInBytesLow** for LOCKING_ANDX_RANGE64.

Either the first returned **Status** indicating an error or the final returned success **Status** is copied into the **SMB_Header.Status** field of the response.

<286> [Section 3.3.5.30](#): If an [SMB_COM_LOCKING_ANDX Request](#) has a nonzero **NumberOfRequestedLocks** field, Windows servers request a byte-range lock from the underlying object store as described in [\[MS-FSA\]](#) section 2.1.5.7, with the following mapping of input elements for each element "X" in the **SMB_Data.Bytes.Lock**s array:

- **Open** is the **Open** indicated by the **SMB_Parameters.Words.FID** field of the request.
- **FileOffset** is the **Locks[X].ByteOffset** field of the request for LOCKING_RANGE_ANDX32, or **Locks[X].ByteOffsetHigh** and **Locks[X].ByteOffsetLow** for LOCKING_ANDX_RANGE64.
- **Length** is the **Locks[X].LengthInBytes** field of the request for LOCKING_RANGE_ANDX32, or **Locks[X].LengthInBytes High** and **Locks[X].LengthInBytes Low** for LOCKING_ANDX_RANGE64.
- **ExclusiveLock** is TRUE if **SMB_Parameters.Words.TypeOfLock** indicates READ_WRITE_LOCK, or FALSE if it indicates SHARED_LOCK.
- **FailImmediately** is TRUE if **SMB_Parameters.Words.Timeout** is zero, or FALSE if **Timeout** is nonzero.
- **LockKey** is set to ((**Open.FID** << 16) | **Open.PID.PIDLow**).

<287> [Section 3.3.5.30](#): Windows Servers process the Oplock break acknowledgment by invoking [\[MS-FSA\]](#) section 2.1.5.18 with the following mapping of input elements: **Open** is the **Open** indicated by the **SMB_Parameters.Words.FID** field of the request. **Type** is the resultant Oplock level from **Server.Open.Oplock**.

<288> [Section 3.3.5.30](#): Windows NT Server do not test whether **NumberOfRequestedUnlocks** is nonzero in an OpLock Break Request message.

<289> [Section 3.3.5.30](#): Windows servers acknowledge an OpLock break as described in [\[MS-FSA\]](#) section 2.1.5.18, with the following mapping of input elements:

- **Open** is the **Open** indicated by the **SMB_Parameters.Words.FID** field of the request.
- **Type** is LEVEL_TWO.

<290> [Section 3.3.5.32](#): Windows NT servers support a specific set of IOCTL requests (see the notes in section [2.2.4.35](#)). The IOCTL requests were originally defined by the OS/2 operating system.

The following table provides a mapping of OS/2 IOCTL request to Windows NT server actions. See [\[MSDN-SDCTRLREQSTS\]](#) for more information on Serial Device Control Requests.

Category	OS/2 IOCTL function	Action
SERIAL_DEVICE0x0001	GET_BAUD_RATE0x0061	NtDeviceIoControlFile() is called with IoControlCode set to IOCTL_SERIAL_GET_BAUD_RATE.
SERIAL_DEVICE0x0001	SET_BAUD_RATE0x0041	NtDeviceIoControlFile() is called with IoControlCode set to IOCTL_SERIAL_SET_BAUD_RATE.

Category	OS/2 IOCTL function	Action
SERIAL_DEVICE0x0001	GET_LINE_CONTROL0x0062	NtDeviceIoControlFile() is called with IoControlCode set to IOCTL_SERIAL_GET_LINE_CONTROL.
SERIAL_DEVICE0x0001	SET_LINE_CONTROL0x0042	NtDeviceIoControlFile() is called with IoControlCode set to IOCTL_SERIAL_SET_LINE_CONTROL.
SERIAL_DEVICE0x0001	GET_DCB_INFORMATION0x0073	NtDeviceIoControlFile() is called with IoControlCode set to IOCTL_SERIAL_GET_TIMEOUTS.
SERIAL_DEVICE0x0001	SET_DCB_INFORMATION0x0053	Windows NT Server returns STATUS_SUCCESS without processing the IOCTL. The IOCTL response returns no Parameters or Data .
SERIAL_DEVICE0x0001	GET_COMM_ERROR0x006D	Windows NT Server returns STATUS_SUCCESS without processing the IOCTL. The IOCTL response returns no Parameters or Data .
SERIAL_DEVICE0x0001	SET_TRANSMIT_TIMEOUT0x0044	Windows NT Server returns an error response with Status of STATUS_NOT_IMPLEMENTED.
SERIAL_DEVICE0x0001	SET_BREAK_OFF0x0045	Windows NT Server returns an error response with Status of STATUS_NOT_IMPLEMENTED.
SERIAL_DEVICE0x0001	SET_MODEM_CONTROL0x0046	Windows NT Server returns an error response with Status of STATUS_NOT_IMPLEMENTED.
SERIAL_DEVICE0x0001	SET_BREAK_ON0x004B	Windows NT Server returns an error response with Status of STATUS_NOT_IMPLEMENTED.
SERIAL_DEVICE0x0001	STOP_TRANSMIT0x0047	Windows NT Server returns an error response with Status of STATUS_NOT_IMPLEMENTED.
SERIAL_DEVICE0x0001	START_TRANSMIT0x0048	Windows NT Server returns an error response with Status of STATUS_NOT_IMPLEMENTED.
SERIAL_DEVICE0x0001	GET_COMM_STATUS0x0064	Windows NT Server returns an error response with Status of STATUS_NOT_IMPLEMENTED.
SERIAL_DEVICE0x0001	GET_LINE_STATUS0x0065	Windows NT Server returns an error response with Status of STATUS_NOT_IMPLEMENTED.
SERIAL_DEVICE0x0001	GET_MODEM_OUTPUT0x0066	Windows NT Server returns an error response with Status of STATUS_NOT_IMPLEMENTED.

Category	OS/2 IOCTL function	Action
SERIAL_DEVICE0x0001	GET_MODEM_INPUT0x0067	Windows NT Server returns an error response with Status of STATUS_NOT_IMPLEMENTED.
SERIAL_DEVICE0x0001	GET_INQUEUE_COUNT0x0068	Windows NT Server returns an error response with Status of STATUS_NOT_IMPLEMENTED.
SERIAL_DEVICE0x0001	GET_OUTQUEUE_COUNT0x0069	Windows NT Server returns an error response with Status of STATUS_NOT_IMPLEMENTED.
SERIAL_DEVICE0x0001	GET_COMM_EVENT0x0072	Windows NT Server returns an error response with Status of STATUS_NOT_IMPLEMENTED.
SERIAL_DEVICE0x0001	Any other value.	Windows NT Server returns an error response with Status of STATUS_INVALID_PARAMETER.
PRINTER_DEVICE0x0005	GET_PRINTER_STATUS0x0066	Windows NT Server returns STATUS_SUCCESS without processing the IOCTL. The IOCTL response returns only one Data byte, which contains an OS/2 printer status code of 0x90 (OS2_STATUS_PRINTER_HAPPY).
SPOOLER_DEVICE0x0053	GET_PRINTER_ID0x0060	Windows NT Server stores the JobID as an attribute of the printer file Open . The share name is an attribute of the TreeConnect (Server.TreeConnect.Share->Share.ShareName) and server name is the configured name of the server. These values are returned in the response.
GENERAL_DEVICE0x000B		Windows NT Server returns an error response with Status of STATUS_NOT_IMPLEMENTED.

<291> [Section 3.3.5.33](#): Windows 98 accepts only an SMB_COM_ECHO request containing a valid **TID** or a **TID** value of 0xFFFF (-1). Windows NT systems ignore the **TID** in the SMB_COM_ECHO request.

<292> [Section 3.3.5.34](#): Windows servers process this command as if it were an [SMB_COM_WRITE \(section 2.2.4.12\)](#) followed by an [SMB_COM_CLOSE \(section 2.2.4.5\)](#). See the product behavior notes for sections [3.3.5.14](#) and [3.3.5.7](#).

<293> [Section 3.3.5.35](#): Windows NT Server always ignores the **FileAttrs** field and the **SearchAttrs** field on Open and Create operations, and searches for files by name only.

<294> [Section 3.3.5.35](#): Windows-based servers permit the file creation, if the FileExistsOpts flag value is 0 and the **AccessMode.SharingMode** field value is 1, 2, 3, or 4.

<295> [Section 3.3.5.35](#): Windows servers open files in the object store as described in [\[MS-FSA\]](#) section 2.1.5.1, with the following mapping of input elements:

- **RootOpen** is provided by using the **SMB_Header.TID** to find the matching **Server.TreeConnect** in the **Server.Connection.TreeConnectTable**. The server then acquires an **Open** on **Server.TreeConnect.Share.LocalPath**, which is passed as **RootOpen**.
- **PathName** is the **SMB_Data.Bytes.FileName** field from the request.
- **SecurityContext** is found by using the **SMB_Header.UID** to look up the matching **Session** entry in the **Server.Connection.SessionTable**. The **Server.Session.UserSecurityContext** is passed as **SecurityContext**.
- **UserCertificate** is empty.
- **DesiredAccess** is set as follows:
 - The **AccessMode** subfield of the **AccessMode** field in the request is used to set the value of **DesiredAccess**. The **AccessMode** subfield represents the lowest-order four bits of the **AccessMode** field (0x0007), as shown in the table in section [2.2.4.3.1](#). The mapping of values is as follows.

AccessMode.AccessMode	DesiredAccess
0	GENERIC_READ 0x80000000
1	GENERIC_WRITE FILE_READ_ATTRIBUTES 0x40000000 0x00000080
2	GENERIC_READ GENERIC_WRITE 0x80000000 0x40000000
3	GENERIC_READ GENERIC_EXECUTE 0x80000000 0x20000000

For any other value of **AccessMode.AccessMode**, this algorithm returns STATUS_OS2_INVALID_ACCESS (ERRDOS/ERRbadaccess).

- **ShareAccess** is set as follows:
 - The **SharingMode** subfield of the **AccessMode** field in the request is used to set the value of **ShareAccess**. The **SharingMode** subfield is a 4-bit subfield of the **AccessMode** field (0x0070), as shown in the table in section [2.2.4.3.1](#). The mapping of values is as follows.

AccessMode.SharingMode	ShareAccess
0	Compatibility mode (see below)
1	0x0L (don't share, exclusive use)
2	FILE_SHARE_READ
3	FILE_SHARE_WRITE
4	FILE_SHARE_READ FILE_SHARE_WRITE
0xFF	FCB mode (see below)

- For Compatibility mode, special filename suffixes (after the '.' in the filename) are mapped to **SharingMode** 4. The special filename suffix set is: "EXE", "DLL", "SYM", and "COM". All other file names are mapped to **SharingMode** 3.

- For FCB mode, if the file is already open on the server, the current sharing mode of the existing Open is preserved, and a **FID** for the file is returned. If the file is not already open on the server, the server attempts to open the file using **SharingMode 1**.
- For any other value of **AccessMode.SharingMode**, this algorithm returns STATUS_OS2_INVALID_ACCESS (ERRDOS/ERRbadaccess).
- **CreateOptions** bits are set as follows.

CreateOptions value	SMB_COM_OPEN_ANDX equivalent
FILE_WRITE_THROUGH	AccessMode.WritethroughMode == 1
FILE_SEQUENTIAL_ONLY	AccessMode.ReferenceLocality == 1
FILE_RANDOM_ACCESS	AccessMode.ReferenceLocality == 2 or AccessMode.ReferenceLocality == 3
FILE_NO_INTERMEDIATE_BUFFERING	AccessMode.CacheMode == 1
FILE_NON_DIRECTORY_FILE	Is set
FILE_COMPLETE_IF_OPLOCKED	Is set
FILE_NO_EA_KNOWLEDGE	SMB_Header.Flags2.SMB_FLAGS2_KNOWS_EAS == 0

- All other bits are unused.
- **CreateDisposition** is set as follows.

CreateDisposition value	SMB_Parameters.Word.OpenMode equivalent
Invalid combination; return STATUS_OS2_INVALID_ACCESS (ERRDOS/ERRbadaccess)	FileExistsOpts = 0 & CreateFile = 0
FILE_CREATE	FileExistsOpts = 0 & CreateFile = 1
FILE_OPEN	FileExistsOpts = 1 & CreateFile = 0
FILE_OPEN_IF	FileExistsOpts = 1 & CreateFile = 1
FILE_OVERWRITE	FileExistsOpts = 2 & CreateFile = 0
FILE_OVERWRITE_IF	FileExistsOpts = 2 & CreateFile = 1

While opening an existing file, the underlying object store checks for the necessity of an OpLock break, as described in [\[MS-FSA\]](#) section 2.1.4.12, and if necessary, notifies the server as specified in section [3.3.4.2](#) and defers the opening of the file until the server acknowledges the OpLock break, as specified in section [3.3.5.30](#).

<296> [Section 3.3.5.35](#): When opening, overwriting, deleting, or renaming a file, Windows NT Server checks for sharing violations. If a sharing violation would be generated by the operation, the server delays for 200 ms and then tests again for a sharing violation. The server retries five times, for a total delay of approximately one second, before giving up and returning the sharing violation error.

<297> [Section 3.3.5.36](#): Windows servers request a read of the file from the object store as described in [\[MS-FSA\]](#) section 2.1.5.2, with the following mapping of input elements:

- **Open** is the **Open** indicated by the **SMB_Parameters.Words.FID** field of the request.
- **ByteOffset** is either the 32- or 64-bit offset, as determined by the server.
- **ByteCount** is the **SMB_Parameters.Words.MaxCountOfBytesToReturn** field of the request.
- **IsNonCached** is not used.
- **Key** is set to $((\text{Open.FID} \ll 16) \mid \text{Open.PID.PIDLow})$.

The returned **Status** is copied into the **SMB_Header.Status** field of the response. If the operation is successful, the following additional mapping of output elements applies:

- **OutputBuffer** is copied into the **SMB_Data.Bytes.Data** field of the response.
- BytesRead is copied into the **SMB_Parameters.Words.DataLength** field of the response.

<298> [Section 3.3.5.36](#): Windows servers ignore the **Timeout** field. Reads from named pipes and I/O devices will always block until **MinCountOfBytesToReturn** are read.

<299> [Section 3.3.5.37](#): Windows NT servers do not validate the **DataOffset** field value.

<300> [Section 3.3.5.37](#): Windows NT based servers do not fail the request; instead, they write only **SMB_Parameters.Words.DataLength** bytes from the **SMB_Data.Bytes.Data** field to the target file.

<301> [Section 3.3.5.37](#): Windows Servers ignore the **Timeout** field. Writes to named pipes or I/O devices always block until the number of **DataLength** bytes are written.

<302> [Section 3.3.5.37](#): If the **Remaining** field is nonzero, and if the MSG_START bit is set in the **SMB_Parameters.Words.WriteMode** field, Windows servers ignore the first two bytes of the **SMB_Data.Bytes.Data** field.

<303> [Section 3.3.5.37](#): Windows servers request a write to a file in the object store as described in [\[MS-FSA\]](#) section 2.1.5.3, with the following mapping of input elements:

- **Open** is the **Open** indicated by the **SMB_Parameters.Words.FID** field of the request.
- **ByteOffset** is the **SMB_Parameters.Words.Offset** field of the request.
- **ByteCount** is the **SMB_Parameters.Words.DataLength** field of the request.
- **IsWriteThrough** is the **SMB_Parameters.Words.WriteMode.WritethroughMode** bit of the request.
- **IsNonCached** is not used.
- **InputBuffer** is copied from the **SMB_Data.Bytes.Data** field of the request.
- **Key** is set to $((\text{Open.FID} \ll 16) \mid \text{Open.PID.PIDLow})$.

The returned **Status** is copied into the **SMB_Header.Status** field of the response. If the write fails, the **Status** is returned in an Error Response and processing is complete. If the operation is successful, the following additional mapping of output elements applies:

- **BytesWritten** is copied into the **SMB_Parameters.Words.Count** field of the response.

<304> [Section 3.3.5.40](#): Windows implementations check to see if the user indicated by the **Server.Session.UserSecurityContext** identified by the **SMB_Header.UID** is a member of the Administrator group.

<305> [Section 3.3.5.45](#): Windows implementations check to see if the user indicated by the **Server.Session.UserSecurityContext** identified by the **SMB_Header.UID** is a member of the Administrator group.

<306> [Section 3.3.5.45](#): Windows servers do not fail tree connects to non-administrative shares by users that are not granted access but will fail attempts by those clients to open or create files. Windows servers will fail tree-connect requests to administrative shares, such as C\$ or D\$, that are issued by a non-administrator.

<307> [Section 3.3.5.46](#): Windows servers obtain volume information from the object store as described in [\[MS-FSA\]](#) section 2.1.5.12, with the following mapping of input elements:

- **Open** is provided by using the **SMB_Header.TID** to find the matching **Server.TreeConnect** in the **Server.Connection.TreeConnectTable**. The server then acquires an **Open** on **Server.TreeConnect.Share.LocalPath**, which is passed as **Open**.
- **FsInformationClass** is set to **FileFsSizeInformation**.

The returned **Status** is copied into the **SMB_Header.Status** field of the response. If the operation fails, the **Status** is returned in an Error Response, and processing is complete. If the operation is successful, the information returned in **OutputBuffer** is adjusted to fit within the data structure provided by SMB.

All of the fields in the [SMB_COM_QUERY_INFORMATION_DISK Response \(section 2.2.4.57.2\)](#) are 16-bit, but the **FileFsSizeInformation** InformationLevel provides 32- and 64-bit values. The goal is to adjust the values so that the total bytes on disk and the total number of available (free) bytes can be calculated reasonably correctly from the numbers returned.

- The value of **Output.TotalAllocationUnits** is divided by two (bitshifted) until the result fits within a USHORT (16 bits, unsigned); that is, until the result is less than 0x00010000. The number of bit shifts is counted and stored as **HighBits** and also as **ExtraBits**. If the value of **HighBits** is greater than zero, the value of **Output.SectorsPerAllocationUnit** is multiplied by two, and **HighBits** is decremented. This is repeated until **HighBits** is zero or the result of the multiplication is greater than or equal to 0x8000. The result is copied into **SMB_Parameters.Words.BlocksPerUnit**.
- If the value of **HighBits** is still greater than zero, the value of **Output.BytesPerSector** is multiplied by two and **HighBits** is decremented. This is repeated until **HighBits** is zero or the result of the multiplication is greater than or equal to 0x8000. The result is copied into **SMB_Parameters.Words.BlockSize**.
- If the value of **HighBits** is still greater than zero, **SMB_Parameters.Words.TotalUnits** is set to the largest possible value: 0xFFFF. Otherwise, **SMB_Parameters.Words.TotalUnits** is calculated as $(\text{Output.TotalAllocationUnits} / (2 \times \text{ExtraBits}))$.
- **SMB_Parameters.Words.FreeUnits** is calculated as $(\text{Output.ActualAvailableAllocationUnits} / (2 \times (\text{ExtraBits} - \text{HighBits})))$. If the result of the calculation is greater than 0xFFFF, **SMB_Parameters.Words.FreeUnits** is set to 0xFFFF.

The **SMB_Header.Status** field of the response is set to **Success**.

<308> [Section 3.3.5.47](#): Windows NT Server 4.0 returns STATUS_NO_MORE_FILES for an empty string in the **FileName** field of the [SMB_COM_SEARCH \(section 2.2.4.58\)](#) request.

<309> [Section 3.3.5.47](#): Windows NT Server uses both of these techniques.

<310> [Section 3.3.5.47](#): If the `SMB_FILE_ATTRIBUTE_VOLUME` bit is set--and is the only bit set--in the `SMB_Parameters.Words.SearchAttributes` field in the request, Windows servers return the volume name of the volume underlying the share indicated by `SMB_Header.TID`. Volume information is queried as described in [\[MS-FSA\]](#) section 2.1.5.12. The following is a mapping of input elements:

- **Open** is an **Open** resulting from opening the directory portion of the `SMB_Data.Bytes.FileName` field from the request.
- **FileInformationClass** is set to **FileFsVolumeInformation**.

The returned Status is copied into the `SMB_Header.Status` field of the response. If the operation fails, Status is returned in an Error Response, and processing is complete; otherwise, a single `DirectoryInformationData[]` field entry is returned in the `SMB_Data.Bytes` block of the response:

- The **FileAttributes** field is set to `SMB_FILE_ATTRIBUTE_VOLUME`.
- The **LastWriteTime**, **LastWriteDate**, and **FileSize** fields are set to zero.
- The **OutputBuffer.VolumeLabel** is converted to the OEM character set and copied into the **FileName** field. At most, 11 bytes of the volume label are copied. If the volume label is greater than 8 bytes in length, a dot (".") is inserted between the 8th and 9th characters. Unused bytes are space-padded.
- The `SMB_Header.Status` field of the response is set to Success.

If the `SMB_Parameters.Words.SearchAttributes` field in the request is not equal to `SMB_FILE_ATTRIBUTE_VOLUME`, Windows servers proceed with a normal directory lookup.

Windows servers search directories for files with names that match wildcard patterns as described in [\[MS-FSA\]](#) sections [2.1.5.5](#) and [2.1.5.5.3](#). The following is a mapping of input elements:

- **Open** is an **Open** resulting from opening the directory portion of the `SMB_Data.Bytes.FileName` field from the request.
- **FileInformationClass** is set to **FileBothDirectoryInformation**.
- **OutputBufferSize** is large enough to hold at least one `FILE_BOTH_DIR_INFORMATION` ([\[MS-FSCC\]](#) section 2.4.8) structure.
- **RestartScan** is FALSE.
- **ReturnSingleEntry** is FALSE.
- If the `SMB_Data.Bytes.ResumeKeyLength` field is zero, then this is a new search, and **FileIndex** is not used; otherwise, the `SMB_Data.Bytes.ResumeKey` field is used to set **FileIndex** so that the directory search continues sequentially.
- **FileNamePattern** is the final component of the **FileName** field.

If the directory search operation fails:

- If **Status** is returned as `STATUS_NO_SUCH_FILE`, **Status** is set to `STATUS_NO_MORE_FILES` to indicate that the search has completed.

- If **Status** is returned as STATUS_NO_MORE_FILES, **Status** is set to STATUS_OBJECT_PATH_NOT_FOUND because the **SMB_Data.Bytes.FileName** field in the request provided a complete path.
- The **Status** is copied to the **SMB_Header.Status** field and returned in an Error Response. Processing is complete.

If the search operation succeeds, the **OutputBuffer.FileAttributes** of each entry in the list of files returned is compared against the **SMB_Parameters.Words.SearchAttributes** field in the request as follows:

- The SMB_FILE_ATTRIBUTE_VOLUME bit is ignored.
- If **OutputBuffer.FileAttributes** has FILE_ATTRIBUTE_HIDDEN set, but SMB_FILE_ATTRIBUTE_HIDDEN is not set in the **SMB_Parameters.Words.SearchAttributes** field, the entry is rejected.
- If **OutputBuffer.FileAttributes** has FILE_ATTRIBUTE_SYSTEM set, but SMB_FILE_ATTRIBUTE_SYSTEM is not set in the **SMB_Parameters.Words.SearchAttributes** field, the entry is rejected.
- If **OutputBuffer.FileAttributes** has FILE_ATTRIBUTE_DIRECTORY set, but SMB_FILE_ATTRIBUTE_DIRECTORY is not set in the **SMB_Parameters.Words.SearchAttributes** field, the entry is rejected.
- If there is no short name (8.3 format name) for this file, the entry is rejected.
- If there are exclusive bits set in the **SMB_Parameters.Words.SearchAttributes** field, the following additional tests are performed:
 - If SMB_SEARCH_ATTRIBUTE_READONLY is set in **SearchAttributes**, but FILE_ATTRIBUTE_READONLY is not set in **OutputBuffer.FileAttributes**, the entry is rejected.
 - If SMB_SEARCH_ATTRIBUTE_HIDDEN is set in **SearchAttributes**, but FILE_ATTRIBUTE_HIDDEN is not set in **OutputBuffer.FileAttributes**, the entry is rejected.
 - If SMB_SEARCH_ATTRIBUTE_SYSTEM is set in **SearchAttributes**, but FILE_ATTRIBUTE_SYSTEM is not set in **OutputBuffer.FileAttributes**, the entry is rejected.
 - If SMB_SEARCH_ATTRIBUTE_ARCHIVE is set in **SearchAttributes**, but FILE_ATTRIBUTE_ARCHIVE is not set in **OutputBuffer.FileAttributes**, the entry is rejected.
 - If SMB_SEARCH_ATTRIBUTE_DIRECTORY is set in **SearchAttributes**, but FILE_ATTRIBUTE_DIRECTORY is not set in **OutputBuffer.FileAttributes**, the entry is rejected.

If the entry has not been rejected, the required **OutputBuffer** fields are converted into the field formats used by the **SMB_Directory_Information** structure, described in section [2.2.4.58.2](#). A **DirectoryInformationData[]** field entry is added to the response message buffer, and the **SMB_Parameters.Words.Count** field is incremented to indicate the total number of **DirectoryInformationData[]** field entries in the response message.

- If the **SMB_Parameters.Words.Count** field is equal to the maximum number of entries to return:
 - The **SMB_Data.Bytes.BufferFormat** field is set to 0x05.

- The **SMB_Data.Bytes.DataLength** field is set to the total number of bytes copied into the **DirectoryInformationData[]** field array, which is $43 \times \text{SMB_Parameters.Words.Count}$.
- The **ResumeKey** field of the final **DirectoryInformationData[]** field entry to be placed into the response buffer is calculated and copied into the **ResumeKey** field of that entry.
- The **SMB_Header.Status** field is set to Success, and processing is complete.
- The maximum number of entries to return is the minimum of:
 - The value of the **SMB_Parameters.Words.MaxCount** field in the request.
 - The maximum number of **DirectoryInformationData[]** field entries that will fit in the **SMB_Data.Bytes** block of the response, based upon the **Server.Connection.ClientMaxBufferSize** ADM element. (The size of the response with no **DirectoryInformationData[]** entries is 40 bytes.)

If the maximum number of entries to return has not been reached, additional entries returned in **OutputBuffer** are processed as described preceding. If there are no additional entries in **OutputBuffer**, another directory query is executed, with the value of **FileIndex** set to the **FileIndex** at the end of the previous query. If Status is returned as STATUS_NO_MORE_FILES, Status is set to Success, and processing is complete. In this way, directory entries are enumerated sequentially until there are either enough entries in the **DirectoryInformationData[]** field to complete the request, or there are no more entries to be added.

<311> [Section 3.3.5.48](#): Processing of this command is identical to the processing of the SMB_COM_FIND request with **SMB_Parameters.Words.MaxCount** set to 0x0001.

<312> [Section 3.3.5.51](#): This is dependent upon the underlying file system. On Windows NT Server, if the request to create a file is performed on a Windows FAT or FAT32 file system, the request fails with STATUS_ACCESS_DENIED. Otherwise it fails with STATUS_PRIVILEGE_NOT_HELD.

<313> [Section 3.3.5.51](#): Windows NT servers allow only the FILE_OPEN option on a named pipe. All other options are ignored and considered the same as FILE_OPEN. When the object in question is a disk object, all options are valid.

<314> [Section 3.3.5.51](#): Windows servers open files in the object store as described in [\[MS-FSA\]](#) section 2.1.5.1, with the following mapping of input elements:

- **RootOpen** is provided in one of two ways:
 - If the **SMB_Parameters.Words.RootDirectoryFID** field is zero, **RootOpen** is provided by using the **SMB_Header.TID** field to find the matching **Server.TreeConnect** in the **Server.Connection.TreeConnectTable**. The server then acquires an **Open** on the **Server.TreeConnect.Share.LocalPath**, which is passed as **RootOpen**.
 - If the **SMB_Parameters.Words.RootDirectoryFID** field is non-zero, **RootOpen** is provided by looking up the **RootDirectoryFID** field in the **Server.Connection.FileOpenTable**.
- **PathName** is the **SMB_Data.Bytes.FileName** field of the request.
- **SecurityContext** is found by using the **SMB_Header.UID** field to look up the matching **Session** entry in the **Server.Connection.SessionTable**. The **Server.Session.UserSecurityContext** is passed as **SecurityContext**.
- **UserCertificate** is empty.

- **DesiredAccess** is the **SMB_Parameters.Words.DesiredAccess** field of the request. The FILE_READ_ATTRIBUTES option is added (using a bitwise OR) to the set provided by the client. If the FILE_NO_INTERMEDIATE_BUFFERING flag is set, it is cleared, and FILE_WRITE_THROUGH is set.
- **ShareAccess** is the **SMB_Parameters.Words.ShareAccess** field of the request.
- **CreateOptions** is the **SMB_Parameters.Words.CreateOptions** field of the request. The FILE_COMPLETE_IF_OPLOCKED option is added (using a bitwise OR) to the set provided by the client. If the FILE_NO_INTERMEDIATE_BUFFERING flag is set, it is cleared, and FILE_WRITE_THROUGH is set.
- **CreateDisposition** is the **SMB_Parameters.Words.CreateDisposition** field of the request.
- **DesiredFileAttributes** is the **SMB_Parameters.Words.ExtFileAttributes** field of the request.
- **IsCaseSensitive** is set to **FALSE** if the SMB_FLAGS_CASE_INSENSITIVE bit is set in the **SMB_Header.Flags** field of the request. Otherwise, **IsCaseSensitive** is set depending upon system defaults. For more information, see the description of the OBJ_CASE_INSENSITIVE flag of the **OBJECT_ATTRIBUTES** structure in [\[MSDN-OBJ_ATTRIBS\]](#).
- **OpLockKey** is empty.

The returned **Status** is copied into the **SMB_Header.Status** field of the response. If the operation fails, the **Status** is returned in an Error Response, and processing is complete.

If the operation is successful, processing continues as follows:

- If either the NT_CREATE_REQUEST_OPLOCK or the NT_CREATE_REQUEST_OPBATCH flag is set in the **SMB_Parameters.Words.Flags** field of the request, an OpLock is requested. Windows servers obtain OpLocks as described in [\[MS-FSA\]](#) section 2.1.5.17, with the following mapping of input elements:
 - **Open** is the **Open** passed through from the preceding operation.
 - **Type** is LEVEL_BATCH if the NT_CREATE_REQUEST_OPBATCH flag is set, or LEVEL_ONE if the NT_CREATE_REQUEST_OPLOCK flag is set.

If an OpLock is granted, the **SMB_Parameters.Words.OpLockLevel** field of the response is set.

- Windows servers obtain the extended file attribute and timestamp response information by querying file information from the object store as described in [\[MS-FSA\]](#) section 2.1.5.11, with the following mapping of input elements:
 - **Open** is the **Open** passed through from the preceding operations.
 - **FileInformationClass** is **FileBasicInformation** ([\[MS-FSCC\]](#) section 2.4.7).

If the query fails, the **Status** is returned in an Error Response, and processing is complete. Otherwise:

- **SMB_Parameters.Words.ExtFileAttributes** is set to **OutputBuffer.FileAttributes**.
- **SMB_Parameters.Words.CreateTime** is set to **OutputBuffer.CreateTime**.
- **SMB_Parameters.Words.LastAccessTime** is set to **OutputBuffer.LastAccessTime**.

- **SMB_Parameters.Words.LastWriteTime** is set to **OutputBuffer.LastWriteTime**.
- **SMB_Parameters.Words.LastChangeTime** is set to **OutputBuffer.ChangeTime**.
- Windows servers obtain the file size response field values by querying file information from the object store as described in [\[MS-FSA\]](#) section 2.1.5.11, with the following mapping of input elements:
 - **Open** is the **Open** passed through from the preceding operations.
 - **FileInformationClass** is **FileStandardInformation** ([\[MS-FSCC\]](#) section 2.4.38).

If the query fails, the **Status** is returned in an Error Response, and processing is complete. Otherwise:

- **SMB_Parameters.Words.AllocationSize** is set to **OutputBuffer.AllocationSize**.
- **SMB_Parameters.Words.EndOfFile** is set to **OutputBuffer.EndOfFile**.

If the query fails, the **Status** is returned in an Error Response, and processing is complete.

- **Open.File.FileType** is used to set the **SMB_Parameters.Words.ResourceType** and **SMB_Parameters.Words.Directory** fields of the response.
- If **Open.File.FileType** indicates a named pipe, Windows servers perform two queries for named pipe state on the underlying object store, each with different information levels, as described in [\[MS-FSA\]](#) section 2.1.5.11, with the following mapping of input elements:
 - **Open** is the **Server.Open** identified by the **SMB_Parameters.Words.Setup.FID** field of the request that is used for both queries.
 - **FileInformationClass** is **FilePipeInformation** ([\[MS-FSCC\]](#) section 2.4.29) for one query and **FilePipeLocalInformation** for the other ([\[MS-FSCC\]](#) section 2.4.30).
 - **OutputBufferSize** is 8 bytes for the **FilePipeInformation** buffer (size of FILE_PIPE_INFORMATION data), and 40 bytes for the **FilePipeLocalInformation** buffer (size of FILE_PIPE_LOCAL_INFORMATION data).

If either query returns an error status in **Status**, that value is set as the **SMB_Header.Status** field of the response message. If both return success, a success status is used, and the following additional mapping of output elements applies:

- **OutputBuffer**: The output buffers from both queries are used to construct an [SMB_NMPIPE_STATUS \(section 2.2.1.3\)](#) data type. The **SMB_NMPIPE_STATUS** buffer is copied into the **SMB_Parameters.Words.NMPipeState** field of the response.
- **ByteCount** is not used.
- A new **FID** is generated for the **Open** returned. All of the other results of the **Open** operation are ignored. The **FID** is copied into the **SMB_Parameters.Words.FID** field of the response.

While opening an existing file, the underlying object store checks for the necessity of an Oplock break, as described in [\[MS-FSA\]](#) section 2.1.4.12, and if necessary, notifies the server as described in section [3.3.4.2](#) and defers the opening of the file until the server acknowledges the Oplock break, as described in section [3.3.5.30](#).

<315> [Section 3.3.5.52](#): Windows NT Server 4.0 does not use the **CID** as a lookup key. The list of pending requests is associated with the SMB transport, so the effect is the same.

<316> [Section 3.3.5.52](#): Windows servers cancel object store operations, as described in the Server Requests Canceling an Operation section in [\[MS-FSA\]](#), with the following mapping of input elements:

- **IORequest** is the **IORequest** of the pending object store operation that is being canceled.

<317> [Section 3.3.5.53](#): Windows NT servers do not completely implement the obsolete SMB_NT_RENAME_MOVE_FILE information level. Instead of returning an error, Windows NT servers perform a file copy.

<318> [Section 3.3.5.53](#): Windows servers add link names to files as described in [\[MS-FSA\]](#) section 2.1.5.14, with the following mapping of input elements:

- **Open** is created by opening the file indicated by **SMB_Data.Bytes.NewFileName** in the request. If the open operation fails, the **Status** is returned in an Error Response, and processing is complete. The minimum access required in order to add a link to the file is (READ_CONTROL | FILE_READ_DATA | FILE_READ_ATTRIBUTES | FILE_READ_EA).
- **FileInformationClass** is FileLinkInformation.
- **InputBuffer.FileName** is copied from SMB_Data.Bytes.NewFileName.

The returned **Status** is copied into the **SMB_Header.Status** field of the response. If the operation fails, the **Status** is returned in an Error Response.

<319> [Section 3.3.5.53](#): When opening, overwriting, deleting, hard linking, or renaming a file, Windows NT Server checks for sharing violations. If a sharing violation would be generated by the operation, the server delays for 200 ms and then tests again for a sharing violation. The server retries five times, for a total delay of approximately one second, before giving up and returning the sharing violation error.

<320> [Section 3.3.5.53](#): It is uncertain how Windows servers respond when a hard linking operation interferes with an ongoing search or other operations.

<321> [Section 3.3.5.54](#): Windows servers open printer spool files in the object store as described in [\[MS-FSA\]](#) section 2.1.5.1, with the following mapping of input elements:

- **RootOpen** is provided by using the **SMB_Header.TID** to find the matching **Server.TreeConnect** in the **Server.Connection.TreeConnectTable**. The server then acquires an **Open** on **Server.TreeConnect.Share.LocalPath**, which is passed as **RootOpen**.
- **PathName** is "\", which indicates the root of the share.
- **SecurityContext** is found by using the **SMB_Header.UID** to look up the matching **Session** entry in the **Server.Connection.SessionTable**. The **Server.Session.UserSecurityContext** is passed as **SecurityContext**.
- **DesiredAccess** is (GENERIC_WRITE | FILE_READ_ATTRIBUTES).
- **ShareAccess** is not FILE_SHARE_READ.
- **CreateOptions** is set to (FILE_NON_DIRECTORY_FILE | FILE_SEQUENTIAL_ONLY | FILE_COMPLETE_IF_OPLOCKED). If the **SMB_Header.Flags2 SMB_FLAGS2_KNOWS_EAS** flag is not set, then the **FILE_NO_EA_KNOWLEDGE** bit is also set.
- **CreateDisposition** is set to **FILE_OVERWRITE_IF**.
- **DesiredFileAttributes** is set to FILE_ATTRIBUTE_NORMAL.

- **IsCaseSensitive** is set to FALSE if the **SMB_FLAGS_CASE_INSENSITIVE** bit is set in the **SMB_Header.Flags** field of the request. Otherwise, **IsCaseSensitive** is set depending upon system defaults. For more information, see the description of the **OBJ_CASE_INSENSITIVE** flag of the **OBJECT_ATTRIBUTES** structure [MSDN-OBJ_ATTRIBS].
- **OpLockKey** is empty.

The returned **Status** is copied into the **SMB_Header.Status** field of the response. If the operation fails, the **Status** is returned in an Error Response, and processing is complete.

If the command is successful, the server allocates an **Open** object and inserts it into **Server.Connection.FileOpenTable** with the following default values:

- A new **FID** is created to uniquely identify this **Open** in **Server.Connection.FileOpenTable**.
- **Server.Open.TreeConnect** is set to the **TreeConnect** on which the open request was performed, and **Server.Open.TreeConnect.OpenCount** is increased by 1.

The server registers the **Open** by invoking the event Server Registers a New Open ([\[MS-SRVS\]](#) section 3.1.6.4) and assigns the return value to **Server.Open.FileGlobalId**.

All of the other results of the Open operation are ignored. The **FID** is copied into the **SMB_Parameters.Words.FID** field of the response.

<322> [Section 3.3.5.55](#): Windows servers request a write to a printer spool file in the object store as described in [\[MS-FSA\]](#) section 2.1.5.3, with the following mapping of input elements:

- **Open** is the **Open** indicated by the **SMB_Parameters.Words.FID** field of the request.
- **ByteOffset** is not used.
- **ByteCount** is the **SMB_Data.Bytes.DataLength** field of the request.
- **InputBuffer** is copied from the **SMB_Data.Bytes.Data** field of the request.

The returned **Status** is copied into the **SMB_Header.Status** field of the response. If the write fails, the **Status** is returned in an Error Response.

<323> [Section 3.3.5.56](#): Windows servers flush a file by passing the **Open** to the algorithm described in [\[MS-FSA\]](#) section 2.1.5.6. The returned **Status** is copied into the **SMB_Header.Status** field of the response.

<324> [Section 3.3.5.57.2](#): Windows servers set pipe state information on named pipes as described in [\[MS-FSA\]](#) section 2.1.5.14, with the following mapping of input elements:

- **Open** is the **Server.Open** identified by the **SMB_Parameters.Words.Setup.FID** field of the request.
- **FileInformationClass** is FilePipeInformation (see [\[MS-FSCC\]](#) section 2.4).
- **InputBuffer** is a buffer formatted as a **FILE_PIPE_INFORMATION** structure, specified in [\[MS-FSCC\]](#) section 2.4.29, where the specific values are taken from the **Trans_Parameters.PipeState** field of the request, according to the following mapping.

PipeState bit name	Values	FilePipeInformation value
Nonblocking	0	FILE_PIPE_QUEUE_OPERATION

PipeState bit name	Values	FilePipeInformation value
	1	FILE_PIPE_COMPLETE_OPERATION
ReadMode	0	FILE_PIPE_BYTE_STREAM_MODE
	1	FILE_PIPE_MESSAGE_MODE

- **InputBufferSize** is 8 bytes, the size of the FILE_PIPE_INFORMATION data.

The returned **Status** is copied into the **SMB_Header.Status** field of the response.

<325> [Section 3.3.5.57.3](#): Windows NT Server does not support this transaction subcommand. It returns a **Status** of STATUS_INVALID_PARAMETER (ERRDOS/ERRinvalidparam).

<326> [Section 3.3.5.57.4](#): Windows servers perform two queries for information on the underlying object store, each with different information levels, as described in [\[MS-FSA\]](#) section 2.1.5.11, with the following mapping of input elements:

- **Open** is the **Server.Open** identified by the **SMB_Parameters.Words.Setup.FID** field of the request and is used for both queries.
- FileInformationClass is FilePipeInformation ([\[MS-FSCC\]](#) section 2.3.31) for one query and FilePipeLocalInformation ([\[MS-FSCC\]](#) section 2.3.32) for the other.
- **OutputBufferSize** is 8 bytes for the FilePipeInformation buffer (size of FILE_PIPE_INFORMATION data), and 40 bytes for the FilePipeLocalInformation buffer (size of FILE_PIPE_LOCAL_INFORMATION data).

If either query returns an error status in **Status**, that value is set as the **SMB_Header.Status** field of the response message. If both return success, a success status is used, and the following additional mapping of output elements applies:

- **OutputBuffer**: The output buffers from both queries are used to construct an SMB_NMPIPE_STATUS data type, as specified in section [2.2.1.3](#). The SMB_NMPIPE_STATUS buffer is the **Trans_Parameters.NMPipeState** field of the response.
- **ByteCount** is not used.

<327> [Section 3.3.5.57.5](#): Windows servers perform a query for state information of a named pipe on the underlying object store as described in [\[MS-FSA\]](#) section 2.1.5.11, with the following mapping of input elements:

- **Open** is the **Server.Open** identified by the **SMB_Parameters.Words.Setup.FID** field of the request.
- **FileInformationClass** is FilePipeLocalInformation ([\[MS-FSCC\]](#) section 2.4.30).
- **OutputBufferSize** is 40 bytes, the size of the **FILE_PIPE_LOCAL_INFORMATION** data.

The returned **Status** is copied into the **SMB_Header.Status** field of the response. If the operation is successful, the following additional mapping of output elements applies:

- **OutputBuffer** is used to populate the **Trans_Data** subfields of the response, according to the following mapping.

FilePipeLocalInformation field	Response Trans_Data subfield
OutboundQuota	OutputBufferSize
InboundQuota	InputBufferSize
MaximumInstances	MaximumInstances
CurrentInstances	CurrentInstances

- **ByteCount** is not used.

<328> [Section 3.3.5.57.6](#): Windows servers peek at named pipes on the underlying object store using an FSCTL_PIPE_PEEK request ([\[MS-FSCC\]](#) section 2.3.28). Processing follows as described in [\[MS-FSA\]](#) section 2.1.5.9, with the following mapping of input elements:

- **Open** is the **Server.Open** identified by the **SMB_Parameters.Words.Setup.FID** field of the request.
- **OutputBufferSize** is 16 bytes (size of FSCTL_PIPE_PEEK reply data) + **SMB_Parameters.Words.MaxDataCount** bytes.

The returned **Status** is copied into the **SMB_Header.Status** field of the response. If the operation is successful, the following additional mapping of output elements applies:

- **OutputBuffer** is an FSCTL_PIPE_PEEK reply structure ([\[MS-FSCC\]](#) section 2.3.28) and is used to populate the **Trans_Parameters** and **Trans_Data** blocks of the response. The following fields from the **OutputBuffer** map to subfields in the response. Note that **FSCTL_PIPE_PEEK.MessageLength** is not mapped directly, but is used as part of a calculation.

FSCTL_PIPE_PEEK reply field	SMB response field
NamedPipeState	Trans_Parameters.NamedPipeState
ReadDataAvailable	Trans_Parameters.ReadDataAvailable
NumberOfMessages	Not used
MessageLength	Trans_Parameters.MessageBytesLength = MessageLength - SMB_Parameters.Words.DataCount
Data	Trans_Data.ReadData

<329> [Section 3.3.5.57.7](#): Windows servers write data to and read data from ("transceive" on) named pipes on the underlying object store using an FSCTL_PIPE_TRANCEIVE request ([\[MS-FSCC\]](#) section 2.3.31). Processing follows as described in [\[MS-FSA\]](#) section 2.1.5.9, with the following mapping of input elements:

- **Open** is the **Server.Open** identified by the **SMB_Parameters.Words.Setup.FID** field of the request.
- **InputBufferSize** is **SMB_Parameters.Words.TotalDataCount** bytes.
- **InputBuffer** is the **Trans_Data.WriteData** field of the request.

- **OutputBufferSize** is 4 bytes (size of FSCTL_PIPE_TRANSCEIVE reply data) + **SMB_Parameters.Words.MaxDataCount** bytes.

The returned **Status** is copied into the **SMB_Header.Status** field of the response. If the operation is successful, the following additional mapping of output elements applies:

- **OutputBuffer** is an FSCTL_PIPE_TRANSCEIVE structure ([\[MS-FSCC\]](#) section 2.3.32) and is copied into the **ReadData** field of the response.

<330> [Section 3.3.5.57.8](#): Windows NT servers allow only message mode for raw writes on named pipes. If the ReadMode bitmask of the **PipeState** field for the named pipe is set to byte mode, the server fails raw write requests on named pipes and returns STATUS_INVALID_PARAMETER.

<331> [Section 3.3.5.57.8](#): Windows NT Server permits only a 2-byte write that contains two null (0x00) padding bytes. The pipe must also be in message mode. If these conditions are not met, NT server returns a STATUS_INVALID_PARAMETER error.

<332> [Section 3.3.5.57.9](#): Windows servers read data from named pipes on the underlying object store as described in [\[MS-FSA\]](#) section 2.1.5.2, with the following mapping of input elements:

- **Open** is the **Server.Open** identified by the **SMB_Parameters.Words.Setup.FID** field of the request.
- **ByteCount** is **SMB_Parameters.Words.MaxDataCount** bytes.
- **ByteOffset** is zero.
- **IsNonCached** is not used.

The returned **Status** is copied into the **SMB_Header.Status** field of the response. If the operation is successful, the following additional mapping of output elements applies:

<333> [Section 3.3.5.57.10](#): Windows servers write data to named pipes on the underlying object store as described in [\[MS-FSA\]](#) section 2.1.5.3, with the following mapping of input elements:

- **Open** is the **Server.Open** identified by the **SMB_Parameters.Words.Setup.FID** field of the request.
- **ByteSize** is **SMB_Parameters.Words.TotalDataCount** bytes.
- **InputBuffer** is the **Trans_Data.WriteData** field of the request.
- **ByteOffset** is zero.
- **IsWriteThrough** and **IsNonCached** are not used.

The returned **Status** is copied into the **SMB_Header.Status** field of the response. If the operation is successful, the following additional mapping of output elements applies:

- **BytesWritten** is copied into the **Trans_Parameters.BytesWritten** field of the response

<334> [Section 3.3.5.57.11](#): Windows servers test the availability of named pipes on the underlying object store using an FSCTL_PIPE_WAIT request ([\[MS-FSCC\]](#) section 2.3.29). Processing follows as described in [\[MS-FSA\]](#) section 2.1.5.9, with the following mapping of input elements:

- **InputBufferSize** is 14 + **SMB_Data.ByteCount** bytes (the size of the FSCTL_PIPE_WAIT request structure's static portion plus the size of the variable-length pipe name).

- **InputBuffer** is the FSCTL_PIPE_WAIT request structure.

The returned **Status** is copied into the **SMB_Header.Status** field of the response.

<335> [Section 3.3.5.57.11](#): Windows NT Server honors the **Timeout** field for this transaction.

<336> [Section 3.3.5.58.1](#): Windows servers pass information level requests to the underlying object store using the information level's corresponding information class. Each information level's corresponding mapping to one or more information classes is given in the information level's corresponding subsection of section [2.2.8](#). Information classes are defined in [\[MS-FSCC\]](#) sections [2.4](#) and [2.5](#), and their corresponding behaviors are described in [\[MS-FSA\]](#) sections [2.1.5.11](#) and [2.1.5.12](#), with the following additional considerations:

- The **Open** input element required for each information class's processing algorithm is either the **Server.Open** that matches the **FID** of the request or created by opening the file indicated by the pathname in the request. If the open operation fails, the **Status** is returned in an Error Response, and processing is complete.
- If the preceding open operation succeeds, once processing completes, the **Open** is closed.

<337> [Section 3.3.5.58.2](#): Windows servers open files in the object store as described in [\[MS-FSA\]](#) section 2.1.5.1, with the following mapping of input elements:

- **RootOpen** is provided by using the **SMB_Header.TID** to find the matching **Server.TreeConnect** in the **Server.Connection.TreeConnectTable**. The server then acquires an Open on **Server.TreeConnect.Share.LocalPath**, which is passed as **RootOpen**.
- **PathName** is the **Trans2_Parameters.FileName** field from the request.
- **SecurityContext** is found by using the **SMB_Header.UID** to look up the matching Session entry in the **Server.Connection.SessionTable**. The **Server.Session.UserSecurityContext** is passed as **SecurityContext**.
- **DesiredAccess** is set as follows:
 - The **AccessMode** subfield of the **Trans2_Parameters.AccessMode** field in the request is used to set the value of **DesiredAccess**. The **AccessMode** subfield represents the lowest order 4 bits of the **AccessMode** field (0x0007), as shown in the table in section [2.2.4.3.1](#). The mapping of values is as follows.

AccessMode.AccessMode	DesiredAccess
0	GENERIC_READ 0x80000000
1	GENERIC_WRITE FILE_READ_ATTRIBUTES 0x40000000 0x00000080
2	GENERIC_READ GENERIC_WRITE 0x80000000 0x40000000
3	GENERIC_READ GENERIC_EXECUTE 0x80000000 0x20000000

- For any other value of **AccessMode.AccessMode**, this algorithm returns STATUS_OS2_INVALID_ACCESS (ERRDOS/ERRbadaccess).
- **ShareAccess** is set as follows:

- The **SharingMode** subfield of the **Trans2_Parameters.AccessMode** field in the request is used to set the value of **ShareAccess**. The **SharingMode** subfield is a 4-bit subfield of the **AccessMode** field (0x0070), as shown in the table in section [2.2.4.3.1](#). The mapping of values is as follows.

AccessMode.SharingMode	ShareAccess
0	Compatibility mode (see following)
1	0x0L (don't share, exclusive use)
2	FILE_SHARE_READ
3	FILE_SHARE_WRITE
4	FILE_SHARE_READ FILE_SHARE_WRITE
0xFF	FCB mode (see following)

- For Compatibility mode, special filename suffixes (after the "." in the filename) are mapped to **SharingMode** 4. The special filename suffix set is: "EXE", "DLL", "SYM", "COM". All other file names are mapped to **SharingMode** 3.
 - For FCB mode, if the file is already open on the server, the current sharing mode of the existing Open is preserved, and a **FID** for the file is returned. If the file is not already open on the server, the server attempts to open the file using **SharingMode** 1.
 - For any other value of **AccessMode.SharingMode**, this algorithm returns STATUS_OS2_INVALID_ACCESS (ERRDOS/ERRbadaccess).
- **CreateOptions** bits are set as follows.

CreateOptions value	TRNS2_OPEN2 equivalent
FILE_WRITE_THROUGH	AccessMode.WritethroughMode == 1
FILE_SEQUENTIAL_ONLY	AccessMode.ReferenceLocality == 1
FILE_RANDOM_ACCESS	AccessMode.ReferenceLocality == 2 or AccessMode.ReferenceLocality == 3
FILE_WRITE_THROUGH	AccessMode.CacheMode == 1
FILE_NON_DIRECTORY_FILE	Is set
FILE_COMPLETE_IF_OPLOCKED	Is set
FILE_NO_EA_KNOWLEDGE	SMB_Header.Flags2 & SMB_FLAGS2_KNOWS_EAS == 0

- All other bits are unused.
- **CreateDisposition** is set as follows:

CreateDisposition Value	Trans2_Parameters.OpenMode Equivalent
Invalid combination; return STATUS_OS2_INVALID_ACCESS	FileExistsOpts = 0 & CreateFile = 0

CreateDisposition Value	Trans2_Parameters.OpenMode Equivalent
(ERRDOS/ERRbadaccess)	
FILE_CREATE	FileExistsOpts = 0 & CreateFile = 1
FILE_OPEN	FileExistsOpts = 1 & CreateFile = 0
FILE_OPEN_IF	FileExistsOpts = 1 & CreateFile = 1
FILE_OVERWRITE	FileExistsOpts = 2 & CreateFile = 0
FILE_OVERWRITE_IF	FileExistsOpts = 2 & CreateFile = 1

- **DesiredFileAttributes** is set as follows:
 - **DesiredFileAttributes** is set to the bitwise AND of the **FileAttributes** field in the request and

```
( SMB_FILE_ATTRIBUTE_READONLY |
SMB_FILE_ATTRIBUTE_HIDDEN |
SMB_FILE_ATTRIBUTE_SYSTEM |
SMB_FILE_ATTRIBUTE_ARCHIVE |
SMB_FILE_ATTRIBUTE_DIRECTORY )
```
 - If the resulting value of **DesiredFileAttributes** is zero, **DesiredFileAttributes** is set to FILE_ATTRIBUTE_NORMAL. See sections [2.2.1.2.3](#) and [2.2.1.2.4](#).
- **IsCaseSensitive** is set to FALSE if the **SMB_FLAGS_CASE_INSENSITIVE** bit is set in the **SMB_Header.Flags** field of the request; otherwise, **IsCaseSensitive** is set depending upon system defaults. For more information, see the description of the **OBJ_CASE_INSENSITIVE** flag of the **OBJECT_ATTRIBUTES** structure [\[MSDN-OBJ_ATTRIBS\]](#).
- **OpLockKey** is empty.

The returned **Status** is copied into the **SMB_Header.Status** field of the response. If the operation fails, the **Status** is returned in an Error Response and processing is complete.

If the operation is successful, processing continues as follows:

- If the request's **Trans2_Data.ExtendedAttributesList** is nonzero, Windows servers set the extended attribute information on the object store as described in [\[MS-FSA\]](#) section 2.1.5.14, with the following mapping of input elements:
 - **Open** is the **Open** passed through from the preceding operations.
 - **FileInformationClass** is **FileFullEaInformation**.
 - **InputBuffer** is the **Trans2_Data.ExtendedAttributeList** field of the request.
 - **InputBufferSize** is the **SMB_Parameters.Words.TotalDataCount** field of the request.

The returned **Status** is copied into the **SMB_Header.Status** field of the response. If the operation fails, the **Status** is returned in an Error Response, and processing is complete.

If the operation is successful, processing continues as follows:

- If the **REQ_OPLOCK** flag is set in the **Trans2_Parameters.Flags** field of the request, an OpLock is being requested. Windows servers obtain OpLocks as described in [\[MS-FSA\]](#) section 2.1.5.17, with the following mapping of input elements:
 - **Open** is the **Open** passed through from the preceding operation.
 - **Type** is **LEVEL_BATCH** if both the **REQ_OPLOCK** flag and the **REQ_OPLOCK_BATCH** flag are set, or **LEVEL_ONE** if only the **REQ_OPLOCK** flag is set.

If an OpLock is granted, the **Trans2_Parameters.OpenResults.LockStatus** bit of the response is set.

- The **Trans2_Parameters.AccessMode** from the request is copied to the response.
- **Open.File.FileType** is used to set the **Trans2_Parameters.ResourceType**.
- Windows servers obtain the **Trans2_Parameters.FileAttributes** response field values by querying file information from the object store as described in [\[MS-FSA\]](#) section 2.1.5.11, with the following mapping of input elements:
 - **Open** is the **Open** passed through from the preceding operations.
 - **FileInformationClass** is **FileBasicInformation**.

If the query fails, the **Status** is returned in an Error Response, and processing is complete. Otherwise:

- **SMB_Parameters.Words.FileAttrs** is set to **OutputBuffer.FileAttributes**.
- If the **REQ_ATTRIB** flag is set in the **Trans2_Parameters.Flags** field of the request, Windows servers obtain the **Trans2_Parameters.FileDataSize** response field values by querying file information from the object store as described in [\[MS-FSA\]](#) section 2.1.5.11, with the following mapping of input elements:
 - **Open** is the **Open** passed through from the preceding operations.
 - **FileInformationClass** is **FileStandardInformation**.

If the query fails, the **Status** is returned in an Error Response, and processing is complete. Otherwise:

- **Trans2_Parameters.FileDataSize** is set to the lowest-order 32 bits of **OutputBuffer.EndOfFile**.
- If the **REQ_EASIZE** flag is set in the **Trans2_Parameters.Flags** field of the request, Windows servers obtain the **Trans2_Parameters.ExtendedAttributeLength** response field values by querying file information from the object store as described in [\[MS-FSA\]](#) section 2.1.5.11, with the following mapping of input elements:
 - **Open** is the **Open** passed through from the preceding operations.
 - **FileInformationClass** is **FileEaInformation**.

If the query fails, the **Status** is returned in an Error Response, and processing is complete. Otherwise:

- **Trans2_Parameters.ExtendedAttributeLength** is set to **OutputBuffer.EaSize**.

If the query fails, the **Status** is returned in an Error Response, and processing is complete.

- A new **FID** is generated for the **Open** returned. All of the other results of the Open operation are ignored. The **FID** is copied into the **SMB_Parameters.Words.FID** field of the response.

<338> [Section 3.3.5.58.3](#): If no matching entries are found, Windows NT servers fail the **TRANS2_FIND_FIRST2 Request (section 2.2.6.2.1)** and return a full **TRANS2_FIND_FIRST2 Response (section 2.2.6.2.2)**, setting all the fields to zero.

<339> [Section 3.3.5.58.3](#): Windows servers close the search and return a nonzero **SID** field value.

<340> [Section 3.3.5.58.3](#): Windows servers process this command in the same way as the **SMB_COM_SEARCH (section 2.2.4.58)** and **SMB_COM_FIND (section 2.2.4.59)** commands (see the notes in section [3.3.5.47](#)), with the following differences:

- The **FileInformationClass** is set to **FileDirectoryInformation**, **FileBothDirectoryInformation**, or **FileFullDirectoryInformation**, depending upon the information required in the EA to be returned.
- The **FileIndex** field is not used.
- **Trans2_Parameters.SearchCount** replaces **SMB_Parameters.Words.MaxCount**.
- The files returned are not required to have short names.
- Instead of returning an **SMB_Directory_Information** structure for each directory entry that matches the required **FileName** and **SearchAttributes** fields, the server returns an **InformationClass** structure of the type requested in the **Trans2_Parameters.InformationLevel** field. If the requested **InformationLevel** is [SMB_INFO_QUERY_EAS_FROM_LIST \(section 2.2.8.1.3\)](#), the server queries the file for the list of extended attributes (EAs), as described in [\[MS-FSA\]](#) section 2.1.5.11. **FileInformationClass** is set to **FileFullEaInformation**. For each **AttributeName** field listed in the **GetExtendedAttributeList** field, the corresponding **FILE_FULL_EA_INFORMATION** data returned from the query is converted into [SMB_FEA \(section 2.2.1.2.2\)](#) format and copied into the **Trans2_Data** block of the response. If an error is returned, the **Status** is not copied into the **SMB_Header.Status** field. Instead, the offset of the **GetExtendedAttributeList.GEAList** field entry that caused the error is stored in the **EaErrorOffset** field, and no more EAs are returned.

<341> [Section 3.3.5.58.4](#): Windows servers process this command in the same way as the **TRANS2_FIND_FIRST2 (section 2.2.6.2)** except that the **FileIndex** field is used to restart the search at the selected location.

<342> [Section 3.3.5.58.6](#): If the **InformationLevel** field is **SMB_QUERY_FILE_NAME_INFO**, Windows servers set the **Trans2_Data.FileName** field in response to the **Server.Open.PathName** ADM element where the **Server.Open.FID** ADM element matches the **FID** field in the request. If the **InformationLevel** field is **SMB_QUERY_FILE_ALL_INFO**, Windows servers set the **Trans2_Data.FileName** field in the response to the full pathname relative to the root of the share.

<343> [Section 3.3.5.58.8](#): If the **InformationLevel** field is **SMB_QUERY_FILE_NAME_INFO**, Windows servers set the **Trans2_Data.FileName** field in response to the **Server.Open.PathName** ADM element where the **Server.Open.FID** ADM element matches the **FID** field in the request. If the **InformationLevel** field is **SMB_QUERY_FILE_ALL_INFO**, Windows servers set the **Trans2_Data.FileName** field in the response to the full pathname relative to the root of the share.

<344> [Section 3.3.5.58.10](#): Windows servers create directories within the object store as described in [\[MS-FSA\]](#) section 2.1.5.1, with the following mapping of input elements:

- **RootOpen** is provided by using the **SMB_Header.TID** to find the matching **Server.TreeConnect** in the **Server.Connection.TreeConnectTable**. The server then acquires an Open on **Server.TreeConnect.Share.LocalPath**, which is passed as **RootOpen**.
- **PathName** is the **Trans2_Parameters.DirectoryName** field from the request.
- **SecurityContext** is found by using the **SMB_Header.UID** to look up the matching Session entry in the **Server.Connection.SessionTable**. The **Server.Session.UserSecurityContext** is passed as **SecurityContext**.
- **DesiredAccess** is set to **FILE_TRAVERSE** (which has the same value as **FILE_EXECUTE**: 0x00000020).
- **ShareAccess** is set to 0x00000000.
- **CreateOptions** is set to **FILE_DIRECTORY_FILE**.
- **CreateDisposition** is set to **FILE_CREATE**.
- **DesiredFileAttributes** is set to **FILE_ATTRIBUTE_NORMAL**.
- **IsCaseSensitive** is set to FALSE if the **SMB_FLAGS_CASE_INSENSITIVE** bit is set in the **SMB_Header.Flags** field of the request. Otherwise, **IsCaseSensitive** is set depending upon system defaults. For more information, see the description of the **OBJ_CASE_INSENSITIVE** flag of the **OBJECT_ATTRIBUTES** structure [\[MSDN-OBJ_ATTRIBS\]](#).
- **OpLockKey** is empty.

The returned **Status** is copied into the **SMB_Header.Status** field of the response. If the operation fails, the **Status** is returned in an Error Response, and processing is complete.

- If the request's **Trans2_Data.ExtendedAttributesList** is nonzero, Windows servers set the extended attribute (EA) information on the object store as described in [\[MS-FSA\]](#) section 2.1.5.14, with the following mapping of input elements:
 - **Open** is the **Open** passed through from the preceding operations.
 - **FileInformationClass** is **FileFullEaInformation**.
 - **InputBuffer** is the **Trans2_Data.ExtendedAttributeList** field of the request.
 - **InputBufferSize** is the **SMB_Parameters.Words.TotalDataCount** field of the request.

The returned **Status** is copied into the **SMB_Header.Status** field of the response. If the operation is successful, the Open returned from the process described in [\[MS-FSA\]](#) section 2.1.5.1 is closed. All other results are ignored.

<345> [Section 3.3.5.59.1](#): This is dependent upon the underlying file system. On Windows NT Server, if the request to create a file is performed on a Windows FAT or FAT32 file system, the request fails with STATUS_ACCESS_DENIED. Otherwise, it fails with STATUS_PRIVILEGE_NOT_HELD.

<346> [Section 3.3.5.59.1](#): Windows servers open files in the object store as described in [\[MS-FSA\]](#) section 2.1.5.1, with the following mapping of input elements:

- **RootOpen** is provided in one of two ways:
 - If **NT_Trans_Parameters.RootDirectoryFID** is zero, **RootOpen** is provided by using the **SMB_Header.TID** to find the matching **Server.TreeConnect** in the **Server.Connection.TreeConnectTable**. The server then acquires an **Open** on **Server.TreeConnect.Share.LocalPath**, which is passed as **RootOpen**.
 - If **NT_Trans_Parameters.RootDirectoryFID** is nonzero, **RootOpen** is provided by looking up the **RootDirectoryFID** in the **Server.Connection.FileOpenTable**.
- **PathName** is the **NT_Trans_Parameters.FileName** field of the request.
- **SecurityContext** is found by using the **SMB_Header.UID** to look up the matching **Session** entry in the **Server.Connection.SessionTable**. The **Server.Session.UserSecurityContext** is passed as **SecurityContext**.
- **DesiredAccess** is the **NT_Trans_Parameters.DesiredAccess** field of the request. The **FILE_READ_ATTRIBUTES** attribute is added (using a bitwise OR) to ensure that the server can query attributes once the file has been opened.
- **ShareAccess** is the **NT_Trans_Parameters.ShareAccess** field of the request.
- **CreateOptions** is the **NT_Trans_Parameters.CreateOptions** field of the request. The **FILE_COMPLETE_IF_OPLOCKED** option is added (using a bitwise OR) to the set provided by the client. If the **FILE_NO_INTERMEDIATE_BUFFERING** flag is set, it is cleared, and **FILE_WRITE_THROUGH** is set.
- **CreateDisposition** is the **NT_Trans_Parameters.CreateDisposition** field of the request.
- **DesiredFileAttributes** is the **NT_Trans_Parameters.ExtFileAttributes** field of the request.
- **IsCaseSensitive** is set to **FALSE** if the **SMB_FLAGS_CASE_INSENSITIVE** bit is set in the **SMB_Header.Flags** field of the request; otherwise, **IsCaseSensitive** is set depending upon system defaults. For more information, see the description of the **OBJ_CASE_INSENSITIVE** flag of the **OBJECT_ATTRIBUTES** structure [\[MSDN-OBJ_ATTRIBS\]](#).
- **OpLockKey** is empty.

Windows servers complete the [NT_TRANSACT_CREATE Request \(section 2.2.7.1.1\)](#) by calling the Win32 **IoCreateFile()** function, which allows both security descriptors (SDs) and extended attributes (EAs) to be set directly rather than having to set them in separate steps. See [\[MSDN-IoCreateFile\]](#). With respect to the algorithm presented in [\[MS-FSA\]](#) section 2.1.5.1:

- If the request's **NT_Trans_Parameters.SecurityDescriptorLength** value is greater than zero, Windows servers set **Open.File.SecurityDescriptor** to the security descriptor passed in the **NT_Trans_Data.SecurityDescriptor** field in the request. (The SD is passed to the object store in the *ObjectAttributes* parameter of **IoCreateFile()**.)
- If the request's **NT_Trans_Parameters.EALength** value is greater than zero, Windows servers set **Open.File.ExtendedAttributes** and **Open.File.ExtendedAttributesLength** from **NT_Trans_Data.ExtendedAttributes** and **NT_Trans_Parameters.EALength**, respectively. (These values are passed to the object store via the *EaBuffer* and *EaLength* parameters of **IoCreateFile()**.)

The returned **Status** is copied into the **SMB_Header.Status** field of the response. If the operation fails, the **Status** is returned in an Error Response, and processing is complete.

If the operation is successful, processing continues as follows:

- If either the `NT_CREATE_REQUEST_OPLOCK` or `NT_CREATE_REQUEST_OPBATCH` flag is set in the **SMB_Parameters.Words.Flags** field of the request, an OpLock is being requested. Windows servers obtain OpLocks as described in [\[MS-FSA\]](#) section 2.1.5.17, with the following mapping of input elements:
 - **Open** is the **Open** passed through from the preceding operation.
 - **Type** is `LEVEL_BATCH` if the `NT_CREATE_REQUEST_OPBATCH` flag is set, or `LEVEL_ONE` if the `NT_CREATE_REQUEST_OPLOCK` flag is set.
- If an OpLock is granted, the **SMB_Parameters.Words.OpLockLevel** field of the response is set.

The returned **Status** is copied into the **SMB_Header.Status** field of the response. If the operation fails, the **Status** is returned in an Error Response, and processing is complete.

If the operation is successful, processing continues as follows:

- Windows servers obtain the extended file attribute and timestamp response information by querying file information from the object store as described in [\[MS-FSA\]](#) section 2.1.5.11, with the following mapping of input elements:
 - **Open** is the **Open** passed through from the preceding operations.
 - **FileInformationClass** is `FileBasicInformation`.
- If the query fails, the **Status** is returned in an Error Response, and processing is complete. Otherwise:
 - **NT_Trans_Parameters.ExtFileAttributes** is set to **OutputBuffer.FileAttributes**.
 - **NT_Trans_Parameters.CreateTime** is set to **OutputBuffer.CreateTime**.
 - **NT_Trans_Parameters.LastAccessTime** is set to **OutputBuffer.LastAccessTime**.
 - **NT_Trans_Parameters.LastWriteTime** is set to **OutputBuffer.LastWriteTime**.
 - **NT_Trans_Parameters.LastChangeTime** is set to **OutputBuffer.ChangeTime**.
- Windows servers obtain the file size response field values by querying file information from the object store as described in [\[MS-FSA\]](#) section 2.1.5.11, with the following mapping of input elements:
 - **Open** is the **Open** passed through from the preceding operations.
 - **FileInformationClass** is `FileStandardInformation`.
- If the query fails, the **Status** is returned in an Error Response, and processing is complete. Otherwise:
 - **NT_Trans_Parameters.AllocationSize** is set to **OutputBuffer.AllocationSize**.
 - **NT_Trans_Parameters.EndOfFile** is set to **OutputBuffer.EndOfFile**.
- If the query fails, the **Status** is returned in an Error Response, and processing is complete.

- **Open.File.FileType** is used to set the **NT_Trans_Parameters.ResourceType** and **NT_Trans_Parameters.Directory** fields of the response.
- If **Open.File.FileType** indicates a named pipe, Windows servers perform two queries for named pipe state on the underlying object store, each with different information levels, as described in [\[MS-FSA\]](#) section 2.1.5.11, with the following mapping of input elements:
 - **Open** is the **Server.Open** identified by the **SMB_Parameters.Words.Setup.FID** field of the request and is used for both queries.
 - **FileInformationClass** is FilePipeInformation for one query and FilePipeLocalInformation for the other ([\[MS-FSCC\]](#) section 2.4).
 - **OutputBufferSize** is 8 bytes for the FilePipeInformation buffer (size of FILE_PIPE_INFORMATION data), and 40 bytes for the FilePipeLocalInformation buffer (size of FILE_PIPE_LOCAL_INFORMATION data).
- If either query returns an error status in **Status**, that value is set as the **SMB_Header.Status** field of the response message. If both return success, a success status is used, and the following additional mapping of output elements applies:
 - **OutputBuffer**: The output buffers from both queries are used to construct an **SMB_NMPIPE_STATUS (section 2.2.1.3)** data type. The **SMB_NMPIPE_STATUS** buffer is copied into the **NT_Trans_Parameters.NMPipeState** field of the response.
 - **ByteCount** is not used.
- A new **FID** is generated for the **Open** returned. All of the other results of the **Open** operation are ignored. The **FID** is copied into the **SMB_Parameters.Words.FID** field of the response.

<347> [Section 3.3.5.59.2](#): Windows servers send IOCTL and FSCTL requests to the underlying object store as described in each control code's specific subsection of [\[MS-FSA\]](#) section 2.1.5.9.

<348> [Section 3.3.5.59.3](#): Windows servers set security descriptors on objects within the object store as described in [\[MS-FSA\]](#) section 2.1.5.16, with the following mapping of input elements:

- **Open** is the **Open** indicated by looking up **FID** in **Server.Connection.FileOpenTable**.
- **SecurityInformation** is copied from the **NT_Trans_Parameters.SecurityInformation** field in the request.
- **InputBuffer** is copied from the **NT_Trans.Data_SecurityDescriptor** field in the request.

Upon completion, the returned **Status** is copied into the **SMB_Header.Status** field of the response message.

<349> [Section 3.3.5.59.4](#): Windows servers provide notification of changes within the object store as described in [\[MS-FSA\]](#) section 2.1.5.10, with the following mapping of input elements:

- **Open** is the **Open** indicated by looking up **FID** in **Server.Connection.FileOpenTable**.
- **WatchTree** is set based upon the value of the **WatchTree** field in the request.
- **CompletionFilter** is copied from the **CompletionFilter** field in the request.

A thread of execution on the server waits for the completion of the notification request. The notification request is an object store I/O operation, and can be canceled as described in sections [2.2.4.65](#) and [3.3.5.52](#), and in [\[MS-FSA\]](#) section 2.1.5.19.

Upon completion, the returned **Status** is copied into the **SMB_Header.Status** field of the response message. If the operation is successful, the **NotifyEventEntries** are copied from the **OutputBuffer** to the **NT_Trans_Parameters.FileNotifyInformation** field.

<350> [Section 3.3.5.59.5](#): Windows servers query security descriptors on objects within the object store as described in [\[MS-FSA\]](#) section 2.1.5.13, with the following mapping of input elements:

- **Open** is the **Open** indicated by looking up **FID** in **Server.Connection.FileOpenTable**.

<351> [Section 3.3.6.4](#): Windows-based servers use a default timeout value of 2 minutes. Windows servers close the connections if **Server.Connection.SelectedDialect** is empty and current time minus **Server.Connection.CreationTime** is more than 30 seconds.

<352> [Section 3.3.7.1](#): Windows TDI transport drivers indicate transport disconnection by signaling an Error Notification as described in [\[MSDN-RecErrorNotif\]](#).

<353> [Section 3.3.7.2](#): Windows SMB servers request that a TDI transport driver close a connection by issuing a disconnect request, as described in [\[MSDN-DiscntEndpoint\]](#), and by subsequently closing the TDI file object.

<354> [Section 3.3.7.3](#): Windows SMB servers request that TDI transport drivers accept or reject incoming connections as described in [\[MSDN-MakeEndpoint\]](#).

<355> [Section 3.4.4.9](#): Windows-based SMB clients on Windows NT 4.0 SP2, Windows 2000, and Windows Server 2003 do not check the CAP_DFS flag and always send the DFS referral request to the server.

<356> [Section 5.1](#): Windows NT servers provide a mechanism for restricting the access of anonymous logon users (also known as null session connections). See [\[KB143474\]](#) for a description.

Guest account support is optional and can be disabled.

<357> [Section 5.1](#): Share level access control is deprecated in favor of user level access control.

Windows clients can be configured to fail authentication if plaintext passwords are required by the server. By default, Windows 98 clients require that the server accept challenge/response authentication. By default, Windows NT 4.0 and Windows NT 4.0 SP2 Workstation clients send plaintext passwords if requested by the server. Windows NT 4.0 SP3 clients require challenge/response by default. See [\[MSDN-ENPLAINTEXT\]](#).

7 Change Tracking

This section identifies changes that were made to the [MS-CIFS] protocol document between the February 2014 and May 2014 releases. Changes are classified as New, Major, Minor, Editorial, or No change.

The revision class **New** means that a new document is being released.

The revision class **Major** means that the technical content in the document was significantly revised. Major changes affect protocol interoperability or implementation. Examples of major changes are:

- A document revision that incorporates changes to interoperability requirements or functionality.
- The removal of a document from the documentation set.

The revision class **Minor** means that the meaning of the technical content was clarified. Minor changes do not affect protocol interoperability or implementation. Examples of minor changes are updates to clarify ambiguity at the sentence, paragraph, or table level.

The revision class **Editorial** means that the formatting in the technical content was changed. Editorial changes apply to grammatical, formatting, and style issues.

The revision class **No change** means that no new technical changes were introduced. Minor editorial and formatting changes may have been made, but the technical content of the document is identical to the last released version.

Major and minor changes can be described further using the following change types:

- New content added.
- Content updated.
- Content removed.
- New product behavior note added.
- Product behavior note updated.
- Product behavior note removed.
- New protocol syntax added.
- Protocol syntax updated.
- Protocol syntax removed.
- New content added due to protocol revision.
- Content updated due to protocol revision.
- Content removed due to protocol revision.
- New protocol syntax added due to protocol revision.
- Protocol syntax updated due to protocol revision.
- Protocol syntax removed due to protocol revision.

- Obsolete document removed.

Editorial changes are always classified with the change type **Editorially updated**.

Some important terms used in the change type descriptions are defined as follows:

- **Protocol syntax** refers to data elements (such as packets, structures, enumerations, and methods) as well as interfaces.
- **Protocol revision** refers to changes made to a protocol that affect the bits that are sent over the wire.

The changes made to this document are listed in the following table. For more information, please contact dochelp@microsoft.com.

Section	Tracking number (if applicable) and description	Major change (Y or N)	Change type
2.2.4.32.1 Request	72181 Updated the TypeOfLock field description.	Y	Content updated.
2.2.4.42.2 Response	71164 Updated the Available field description and removed the product behavior note regarding the case of the client reading from a disk file.	Y	Product behavior note removed.
2.2.5.5.1 Request	72182 Updated that the ParameterCount field MUST be set to "0x0000".	Y	Content updated.
2.2.6.2.1 Request	71159 Updated the SearchStorageType field value.	Y	Content updated.
3.3.5.13 Receiving an SMB_COM_READ Request	70854 Updated the processing rules for determining the value of Key.	Y	Product behavior note updated.
3.3.5.14 Receiving an SMB_COM_WRITE Request	70854 Updated the processing rules for determining the value of Key.	Y	Product behavior note updated.
3.3.5.15 Receiving an SMB_COM_LOCK_BYTE_RANGE Request	70854 Updated the processing rules for determining the value of LockKey.	Y	Product behavior note updated.
3.3.5.16 Receiving an SMB_COM_UNLOCK_BYTE_RANGE Request	70854 Updated the processing rules for determining the value of LockKey.	Y	Product behavior note updated.
3.3.5.24 Receiving an SMB_COM_READ_RAW	70854 Updated the processing rules for	Y	Product behavior note

Section	Tracking number (if applicable) and description	Major change (Y or N)	Change type
Request	determining the value of Key.		updated.
3.3.5.25 Receiving an SMB_COM_READ_MPX Request	70854 Updated the processing rules for determining the value of Key.	Y	Product behavior note updated.
3.3.5.30 Receiving an SMB_COM_LOCKING_ANDX Request	70854 Updated the processing rules for determining the value of LockKey.	Y	Product behavior note updated.
3.3.5.36 Receiving an SMB_COM_READ_ANDX Request	70854 Updated the processing rules for determining the value of Key.	Y	Product behavior note updated.
3.3.5.36 Receiving an SMB_COM_READ_ANDX Request	71164 Updated the requirements regarding the Available field.	Y	Content updated.
3.3.5.37 Receiving an SMB_COM_WRITE_ANDX Request	70854 Updated the processing rules for determining the value of Key.	Y	Product behavior note updated.
3.3.5.58.3 Receiving a TRANS2_FIND_FIRST2 Request	71159 Removed SearchStorageType from the list of fields that are used to refine the search.	Y	Content updated for template compliance.
3.3.5.58.4 Receiving a TRANS2_FIND_NEXT2 Request	71159 Removed SearchStorageType from the list of fields that MUST NOT be overridden.	Y	Content updated.

8 Index

A

Abstract data model

client

global ([section 3.1.1.1](#) 520, [section 3.2.1.1](#) 523)

overview ([section 3.1.1](#) 520, [section 3.2.1](#) 523)

RPC

[global](#) 520

overview ([section 3.1.1](#) 520, [section 3.4.1](#) 681)

SMB

[connection](#) 525

[session](#) 527

[tree connect](#) 527

unique

[open](#) 528

[open search](#) 528

server

global ([section 3.1.1.1](#) 520, [section 3.3.1.1](#) 598)

overview ([section 3.1.1](#) 520, [section 3.3.1](#) 598)

RPC

[global](#) 520

overview ([section 3.1.1](#) 520, [section 3.5.1](#) 688)

[share](#) 601

SMB

[command - pending](#) 604

[connection](#) 601

[session](#) 604

[tree connect](#) 605

unique

[open](#) 605

[open search](#) 606

[AndX packet](#) 87

[Applicability](#) 29

C

[Capability negotiation](#) 30

[Change tracking](#) 766

[Character sequences data type](#) 41

Client

abstract data model

global ([section 3.1.1.1](#) 520, [section 3.2.1.1](#) 523)

overview ([section 3.1.1](#) 520, [section 3.2.1](#) 523)

SMB

[connection](#) 525

[session](#) 527

[tree connect](#) 527

unique

[open](#) 528

[open search](#) 528

higher-layer triggered events

[cryptographic session key - querying](#) 577

device

[reading](#) 556

[writing](#) 560

DFS

[querying referrals](#) 577

[subsystem active](#) 577

directory

[contents change notification](#) 576

[creating](#) 543

[deleting](#) 543

[enumeration](#) 571

[verifying path](#) 568

file

attributes

[querying](#) 552

[setting](#) 554

[byte-range lock](#) 566

[byte-range lock - release](#) 567

[closing](#) 550

[create or overwrite](#) 547

[creating a hard link](#) 552

[deleting](#) 550

[flushing data](#) 550

[opening an existing](#) 544

[opportunistic lock](#) 568

[print](#) 573

[reading](#) 556

[renaming](#) 551

[seek to a location](#) 569

[sending IOCTL](#) 569

[system attributes - querying](#) 570

[writing](#) 560

named pipe

[exchange \(call\)](#) 575

[executing a transaction](#) 574

[peeking at data](#) 574

querying

[handle state](#) 573

[information](#) 574

reading ([section 3.2.4.14](#) 556, [section 3.2.4.37](#) 575)

[setting state](#) 573

[waiting for availability](#) 574

writing ([section 3.2.4.15](#) 560, [section 3.2.4.38](#) 575)

[named RAP transaction](#) 577

[number of opens on tree connect](#) 578

[operations - canceling pending](#) 572

[process exit notification](#) 569

security descriptors

[querying](#) 576

[setting](#) 576

sending any message ([section 3.1.4.1](#) 520, [section 3.2.4.1](#) 530)

[share - connecting](#) 537

[SMB session logoff](#) 570

[transport layer connection - testing](#) 570

[tree disconnect \(unmount share\)](#) 570

initialization ([section 3.1.3](#) 520, [section 3.2.3](#) 528)
local events
 [handling transport disconnect](#) 598
 [overview](#) 523
message processing
 [algorithms for challenge/response authentication](#) 522
OpLock
 [break notification](#) 596
 [grant](#) 596
receiving any message ([section 3.1.5.1](#) 522, [section 3.2.5.1](#) 578)
[SMB_COM_CLOSE response](#) 583
[SMB_COM_CREATE response](#) 583
[SMB_COM_CREATE_NEW response](#) 584
[SMB_COM_CREATE_TEMPORARY response](#) 584
[SMB_COM_ECHO response](#) 588
[SMB_COM_FIND response](#) 590
[SMB_COM_FIND_CLOSE2 response](#) 589
[SMB_COM_FIND_UNIQUE response](#) 590
[SMB_COM_IOCTL response](#) 588
[SMB_COM_LOCK_AND_READ response](#) 585
[SMB_COM_LOGOFF_ANDX response](#) 590
[SMB_COM_NEGOTIATE response](#) 580
[SMB_COM_NT_CREATE_ANDX response](#) 591
[SMB_COM_NT_TRANSACT response](#) 591
[SMB_COM_NT_TRANSACT subcommand response](#) 595
[SMB_COM_OPEN response](#) 583
[SMB_COM_OPEN_ANDX response](#) 588
[SMB_COM_OPEN_PRINT_FILE response](#) 591
[SMB_COM_QUERY_INFORMATION response](#) 584
[SMB_COM_QUERY_INFORMATION_DISK response](#) 590
[SMB_COM_QUERY_INFORMATION2 response](#) 587
[SMB_COM_READ response](#) 584
[SMB_COM_READ_ANDX response](#) 589
[SMB_COM_READ_MPX response](#) 586
[SMB_COM_READ_RAW response](#) 585
[SMB_COM_SEARCH response](#) 590
[SMB_COM_SEEK response](#) 585
[SMB_COM_SESSION_SETUP_ANDX response](#) 581
[SMB_COM_TRANSACTION response](#) 588
[SMB_COM_TRANSACTION subcommand response](#) 591
[SMB_COM_TRANSACTION2 response](#) 589
[SMB_COM_TRANSACTION2 subcommand response](#) 593
[SMB_COM_TREE_CONNECT response](#) 582
[SMB_COM_TREE_CONNECT_ANDX response](#) 582
[SMB_COM_TREE_DISCONNECT response](#) 590
[SMB_COM_WRITE response](#) 584
[SMB_COM_WRITE_AND_CLOSE response](#) 588
[SMB_COM_WRITE_AND_UNLOCK response](#) 585
[SMB_COM_WRITE_ANDX response](#) 589
[SMB_COM_WRITE_MPX response](#) 587

[SMB_COM_WRITE_RAW response](#) 586
[STATUS_PATH_NOT_COVERED](#) 597
RPC
 abstract data model
 [global](#) 520
 overview ([section 3.1.1](#) 520, [section 3.4.1](#) 681)
 higher-layer triggered events
 [DFS referrals - querying](#) 686
 [extended DFS referral capability - querying](#) 687
 named pipe
 [closing](#) 684
 [opening](#) 681
 [reading](#) 683
 [transaction - issuing](#) 684
 [writing](#) 683
 [sending any message](#) 520
 session
 [initiating](#) 685
 [key - authenticated context](#) 685
 [terminating](#) 685
 [share connection - requesting](#) 686
 [tree disconnect - requesting](#) 687
 initialization ([section 3.1.3](#) 520, [section 3.4.3](#) 681)
 local events ([section 3.1.7](#) 523, [section 3.4.7](#) 688)
 message processing
 [algorithms for challenge/response authentication](#) 522
 [overview](#) 688
 [receiving any message](#) 522
 [overview](#) 680
 sequencing rules
 [algorithms for challenge/response authentication](#) 522
 [overview](#) 688
 [receiving any message](#) 522
 timer events ([section 3.1.6](#) 523, [section 3.4.6](#) 688)
 timers ([section 3.1.2](#) 520, [section 3.4.2](#) 681)
 sequencing rules
 [algorithms for challenge/response authentication](#) 522
 OpLock
 [break notification](#) 596
 [grant](#) 596
 receiving any message ([section 3.1.5.1](#) 522, [section 3.2.5.1](#) 578)
 [SMB_COM_CLOSE response](#) 583
 [SMB_COM_CREATE response](#) 583
 [SMB_COM_CREATE_NEW response](#) 584
 [SMB_COM_CREATE_TEMPORARY response](#) 584
 [SMB_COM_ECHO response](#) 588
 [SMB_COM_FIND response](#) 590
 [SMB_COM_FIND_CLOSE2 response](#) 589
 [SMB_COM_FIND_UNIQUE response](#) 590
 [SMB_COM_IOCTL response](#) 588
 [SMB_COM_LOCK_AND_READ response](#) 585
 [SMB_COM_LOGOFF_ANDX response](#) 590

[SMB_COM_NEGOTIATE response](#) 580
[SMB_COM_NT_CREATE_ANDX response](#) 591
[SMB_COM_NT_TRANSACT response](#) 591
[SMB_COM_NT_TRANSACT subcommand response](#) 595
[SMB_COM_OPEN response](#) 583
[SMB_COM_OPEN_ANDX response](#) 588
[SMB_COM_OPEN_PRINT_FILE response](#) 591
[SMB_COM_QUERY_INFORMATION response](#) 584
[SMB_COM_QUERY_INFORMATION_DISK response](#) 590
[SMB_COM_QUERY_INFORMATION2 response](#) 587
[SMB_COM_READ response](#) 584
[SMB_COM_READ_ANDX response](#) 589
[SMB_COM_READ_MPX response](#) 586
[SMB_COM_READ_RAW response](#) 585
[SMB_COM_SEARCH response](#) 590
[SMB_COM_SEEK response](#) 585
[SMB_COM_SESSION_SETUP_ANDX response](#) 581
[SMB_COM_TRANSACTION response](#) 588
[SMB_COM_TRANSACTION subcommand response](#) 591
[SMB_COM_TRANSACTION2 response](#) 589
[SMB_COM_TRANSACTION2 subcommand response](#) 593
[SMB_COM_TREE_CONNECT response](#) 582
[SMB_COM_TREE_CONNECT_ANDX response](#) 582
[SMB_COM_TREE_DISCONNECT response](#) 590
[SMB_COM_WRITE response](#) 584
[SMB_COM_WRITE_AND_CLOSE response](#) 588
[SMB_COM_WRITE_AND_UNLOCK response](#) 585
[SMB_COM_WRITE_ANDX response](#) 589
[SMB_COM_WRITE_MPX response](#) 587
[SMB_COM_WRITE_RAW response](#) 586
[STATUS_PATH_NOT_COVERED](#) 597
timer events
 [overview](#) 523
 [request expiration](#) 597
timers
 [idle connection](#) 606
 [OpLock break acknowledgment](#) 606
 [overview](#) 520
 [request expiration](#) 528
 [unused open search](#) 607
Codes
 [command - SMB_COM](#) 54
 [data buffer format](#) 79
 [information level](#) 64
 [SMB error classes](#) 67
 [subcommand - transaction](#) 61
[Command codes - SMB_COM](#) 54
Commands - SMB
 [SMB_COM_CHECK_DIRECTORY \(0x10\)](#) 155
 [SMB_COM_CLOSE \(0x04\)](#) 105
 [SMB_COM_CLOSE_AND_TREE_DISC \(0x31\)](#) 276
 [SMB_COM_CLOSE_PRINT_FILE \(0xC2\)](#) 398
 [SMB_COM_COPY \(0x29\)](#) 239
 [SMB_COM_CREATE \(0x03\)](#) 100
 [SMB_COM_CREATE_DIRECTORY \(0x00\)](#) 88
 [SMB_COM_CREATE_NEW \(0x0F\)](#) 151
 [SMB_COM_CREATE_TEMPORARY \(0x0E\)](#) 146
 [SMB_COM_DELETE \(0x06\)](#) 111
 [SMB_COM_DELETE_DIRECTORY \(0x01\)](#) 91
 [SMB_COM_ECHO \(0x2B\)](#) 240
 [SMB_COM_FIND \(0x82\)](#) 338
 [SMB_COM_FIND_CLOSE \(0x84\)](#) 351
 [SMB_COM_FIND_CLOSE2 \(0x34\)](#) 289
 [SMB_COM_FIND_NOTIFY_CLOSE \(0x35\)](#) 291
 [SMB_COM_FIND_UNIQUE \(0x83\)](#) 345
 [SMB_COM_FLUSH \(0x05\)](#) 108
 [SMB_COM_GET_PRINT_QUEUE \(0xC3\)](#) 400
 [SMB_COM_INVALID \(0xFE\)](#) 401
 [SMB_COM_IOCTL \(0x27\)](#) 231
 [SMB_COM_IOCTL_SECONDARY \(0x28\)](#) 239
 [SMB_COM_LOCK_AND_READ \(0x13\)](#) 164
 [SMB_COM_LOCK_BYTE_RANGE \(0x0C\)](#) 138
 [SMB_COM_LOCKING_ANDX \(0x24\)](#) 208
 [SMB_COM_LOGOFF_ANDX \(0x74\)](#) 317
 [SMB_COM_MOVE \(0x2A\)](#) 240
 [SMB_COM_NEGOTIATE \(0x72\)](#) 298
 [SMB_COM_NEW_FILE_SIZE \(0x30\)](#) 276
 [SMB_COM_NO_ANDX_COMMAND \(0xFF\)](#) 401
 [SMB_COM_NT_CANCEL \(0xA4\)](#) 385
 [SMB_COM_NT_CREATE_ANDX \(0xA2\)](#) 370
 [SMB_COM_NT_RENAME \(0xA5\)](#) 387
 [SMB_COM_NT_TRANSACT \(0xA0\)](#) 356
 [SMB_COM_NT_TRANSACT_SECONDARY \(0xA1\)](#) 365
 [SMB_COM_OPEN \(0x02\)](#) 94
 [SMB_COM_OPEN_ANDX \(0x2D\)](#) 249
 [SMB_COM_OPEN_PRINT_FILE \(0xC0\)](#) 390
 [SMB_COM_PROCESS_EXIT \(0x11\)](#) 158
 [SMB_COM_QUERY_INFORMATION \(0x08\)](#) 118
 [SMB_COM_QUERY_INFORMATION_DISK \(0x80\)](#) 327
 [SMB_COM_QUERY_INFORMATION2 \(0x23\)](#) 204
 [SMB_COM_QUERY_SERVER \(0x21\)](#) 201
 [SMB_COM_READ \(0x0A\)](#) 127
 [SMB_COM_READ_ANDX \(0x2E\)](#) 259
 [SMB_COM_READ_BULK \(0xD8\)](#) 400
 [SMB_COM_READ_MPX \(0x1B\)](#) 179
 [SMB_COM_READ_MPX_SECONDARY \(0x1C\)](#) 185
 [SMB_COM_READ_RAW \(0x1A\)](#) 176
 [SMB_COM_RENAME \(0x07\)](#) 114
 [SMB_COM_SEARCH \(0x81\)](#) 331
 [SMB_COM_SECURITY_PACKAGE_ANDX \(0x7E\)](#) 327
 [SMB_COM_SEEK \(0x12\)](#) 160
 [SMB_COM_SESSION_SETUP_ANDX \(0x73\)](#) 307
 [SMB_COM_SET_INFORMATION \(0x09\)](#) 122
 [SMB_COM_SET_INFORMATION2 \(0x22\)](#) 201
 [SMB_COM_TRANSACTION \(0x25\)](#) 217
 [SMB_COM_TRANSACTION_SECONDARY \(0x26\)](#) 227
 [SMB_COM_TRANSACTION2 \(0x32\)](#) 276
 [SMB_COM_TRANSACTION2_SECONDARY \(0x33\)](#) 285
 [SMB_COM_TREE_CONNECT \(0x70\)](#) 291

- [SMB_COM_TREE_CONNECT_ANDX \(0x75\)](#) 319
- [SMB_COM_TREE_DISCONNECT \(0x71\)](#) 296
- [SMB_COM_UNLOCK_BYTE_RANGE \(0x0D\)](#) 142
- [SMB_COM_WRITE \(0x0B\)](#) 132
- [SMB_COM_WRITE_AND_CLOSE \(0x2C\)](#) 243
- [SMB_COM_WRITE_AND_UNLOCK \(0x14\)](#) 170
- [SMB_COM_WRITE_ANDX \(0x2F\)](#) 267
- [SMB_COM_WRITE_BULK \(0xD9\)](#) 400
- [SMB_COM_WRITE_BULK_DATA \(0xDA\)](#) 401
- [SMB_COM_WRITE_COMPLETE \(0x20\)](#) 201
- [SMB_COM_WRITE_MPX \(0x1E\)](#) 193
- [SMB_COM_WRITE_MPX_SECONDARY \(0x1F\)](#) 200
- [SMB_COM_WRITE_PRINT_FILE \(0xC1\)](#) 394
- [SMB_COM_WRITE_RAW \(0x1D\)](#) 185

[Common data types](#) 40

Copy file

- [from share example](#) 695
- [to share example](#) 696

D

[Data buffer format codes](#) 79

Data model - abstract

client

- global ([section 3.1.1.1](#) 520, [section 3.2.1.1](#) 523)

- overview ([section 3.1.1](#) 520, [section 3.2.1](#) 523)

RPC

- [global](#) 520

- overview ([section 3.1.1](#) 520, [section 3.4.1](#) 681)

SMB

- [connection](#) 525

- [session](#) 527

- [tree connect](#) 527

unique

- [open](#) 528

- [open search](#) 528

server

- global ([section 3.1.1.1](#) 520, [section 3.3.1.1](#) 598)

- overview ([section 3.1.1](#) 520, [section 3.3.1](#) 598)

RPC

- [global](#) 520

- overview ([section 3.1.1](#) 520, [section 3.5.1](#) 688)

- [share](#) 601

SMB

- [command - pending](#) 604

- [connection](#) 601

- [session](#) 604

- [tree connect](#) 605

unique

- [open](#) 605

- [open search](#) 606

Data types

- [character sequences](#) 41

- [common - overview](#) 40

- [file attributes](#) 43

- [SMB_ERROR](#) 50

- [SMB_NMPIPE_STATUS](#) 48

- [time](#) 49

- [unique identifiers](#) 51

[DAY](#) 49

[Direct hosting](#) 34

[Direct IPX](#) 34

[Disconnect example](#) 690

E

[Error classes and codes - SMB](#) 67

Events

local

client

- [handling transport disconnect](#) 598

- [overview](#) 523

- RPC ([section 3.1.7](#) 523, [section 3.4.7](#) 688)

server

- [disconnecting connection](#) 680

handling

- [incoming transport connection](#) 680

- [transport disconnect](#) 680

- [overview](#) 523

- RPC ([section 3.1.7](#) 523, [section 3.5.7](#) 689)

timer

client

- [overview](#) 523

- [request expiration](#) 597

- RPC ([section 3.1.6](#) 523, [section 3.4.6](#) 688)

server

- [idle connection](#) 679

- [OpLock break acknowledgment](#) 679

- [overview](#) 523

- RPC ([section 3.1.6](#) 523, [section 3.5.6](#) 689)

- [unused open search](#) 679

Examples

copy file

- [from share](#) 695

- [to share](#) 696

- [disconnect](#) 690

- [get file attributes](#) 692

- [message signing](#) 691

- [negotiate and tree connect](#) 690

- [overview](#) 690

- [set file attributes](#) 693

F

[Fields - vendor extensible](#) 32

[File attributes data type](#) 43

[Final Server Response packet](#) 190

G

[Get file attributes example](#) 692

[Glossary](#) 19

H

Higher-layer triggered events

client

- [cryptographic session key - querying](#) 577

device

- [reading](#) 556

- [writing](#) 560
- DFS
 - [querying referrals](#) 577
 - [subsystem active](#) 577
- directory
 - [contents change notification](#) 576
 - [creating](#) 543
 - [deleting](#) 543
 - [enumeration](#) 571
 - [verifying path](#) 568
- file
 - attributes
 - [querying](#) 552
 - [setting](#) 554
 - [byte-range lock](#) 566
 - [byte-range lock - release](#) 567
 - [closing](#) 550
 - [create or overwrite](#) 547
 - [creating a hard link](#) 552
 - [deleting](#) 550
 - [flushing data](#) 550
 - [opening an existing](#) 544
 - [opportunistic lock](#) 568
 - [print](#) 573
 - [reading](#) 556
 - [renaming](#) 551
 - [seek to a location](#) 569
 - [sending IOCTL](#) 569
 - [system attributes - querying](#) 570
 - [writing](#) 560
- named pipe
 - [exchange \(call\)](#) 575
 - [executing a transaction](#) 574
 - [peeking at data](#) 574
- querying
 - [handle state](#) 573
 - [information](#) 574
- reading ([section 3.2.4.14](#) 556, [section 3.2.4.37](#) 575)
- [setting state](#) 573
- [waiting for availability](#) 574
- writing ([section 3.2.4.15](#) 560, [section 3.2.4.38](#) 575)
- [named RAP transaction](#) 577
- [number of opens on tree connect](#) 578
- [operations - canceling pending](#) 572
- [process exit notification](#) 569
- RPC
 - [DFS referrals - querying](#) 686
 - [extended DFS referral capability - querying](#) 687
 - named pipe
 - [closing](#) 684
 - [opening](#) 681
 - [reading](#) 683
 - [transaction - issuing](#) 684
 - [writing](#) 683
 - [sending any message](#) 520
 - session
 - [initiating](#) 685
 - [key - authenticated context](#) 685
 - [terminating](#) 685
 - [share connection - requesting](#) 686
 - [tree disconnect - requesting](#) 687
 - security descriptors
 - [querying](#) 576
 - [setting](#) 576
 - sending any message ([section 3.1.4.1](#) 520, [section 3.2.4.1](#) 530)
 - [share - connecting](#) 537
 - [SMB session logoff](#) 570
 - [transport layer connection - testing](#) 570
 - [tree disconnect \(unmount share\)](#) 570
- server
 - client session
 - [security context](#) 610
 - [session key](#) 610
 - [configuration - updating](#) 616
 - DFS subsystem
 - [active](#) 610
 - [DFS share](#) 610
 - [not a DFS share](#) 610
 - [disabling](#) 615
 - [enabling](#) 615
 - open
 - [closing](#) 613
 - [querying](#) 614
 - [OpLock break](#) 609
 - [pausing](#) 615
 - [resuming](#) 616
 - RPC
 - named pipe
 - [closing its open](#) 689
 - [waiting for clients to open](#) 688
 - [security context](#) 689
 - [sending any message](#) 520
 - [session key](#) 689
 - sending any message ([section 3.1.4.1](#) 520, [section 3.3.4.1](#) 608)
 - session
 - [closing](#) 611
 - [querying](#) 613
 - share
 - [deregistering](#) 612
 - [querying](#) 612
 - [registering](#) 611
 - [updating](#) 612
 - [statistics](#) 616
 - [transport binding change](#) 615
 - [TreeConnect - querying](#) 614
- [HOUR](#) 50

I

- [Implementer - security considerations](#) 698
- [Index of security parameters](#) 698
- Information level
 - [codes](#) 64
 - [overview](#) 496
- [Informative references](#) 23
- Initialization
 - client
 - overview ([section 3.1.3](#) 520, [section 3.2.3](#) 528)

RPC ([section 3.1.3](#) 520, [section 3.4.3](#) 681)
server
overview ([section 3.1.3](#) 520, [section 3.3.3](#) 607)
RPC ([section 3.1.3](#) 520, [section 3.5.3](#) 688)
[Interim Server Response packet](#) 189
[Introduction](#) 19

L

Local events
client
[handling transport disconnect](#) 598
[overview](#) 523
RPC ([section 3.1.7](#) 523, [section 3.4.7](#) 688)
server
[disconnecting connection](#) 680
handling
[incoming transport connection](#) 680
[transport disconnect](#) 680
[overview](#) 523
RPC ([section 3.1.7](#) 523, [section 3.5.7](#) 689)

M

Message processing
client
[algorithms for challenge/response authentication](#) 522
OpLock
[break notification](#) 596
[grant](#) 596
receiving any message ([section 3.1.5.1](#) 522, [section 3.2.5.1](#) 578)
RPC
[algorithms for challenge/response authentication](#) 522
[overview](#) 688
[receiving any message](#) 522
[SMB_COM_CLOSE response](#) 583
[SMB_COM_CREATE response](#) 583
[SMB_COM_CREATE_NEW response](#) 584
[SMB_COM_CREATE_TEMPORARY response](#) 584
[SMB_COM_ECHO response](#) 588
[SMB_COM_FIND response](#) 590
[SMB_COM_FIND_CLOSE2 response](#) 589
[SMB_COM_FIND_UNIQUE response](#) 590
[SMB_COM_IOCTL response](#) 588
[SMB_COM_LOCK_AND_READ response](#) 585
[SMB_COM_LOGOFF_ANDX response](#) 590
[SMB_COM_NEGOTIATE response](#) 580
[SMB_COM_NT_CREATE_ANDX response](#) 591
[SMB_COM_NT_TRANSACT response](#) 591
[SMB_COM_NT_TRANSACT subcommand response](#) 595
[SMB_COM_OPEN response](#) 583
[SMB_COM_OPEN_ANDX response](#) 588
[SMB_COM_OPEN_PRINT_FILE response](#) 591
[SMB_COM_QUERY_INFORMATION response](#) 584
[SMB_COM_QUERY_INFORMATION_DISK response](#) 590

[SMB_COM_QUERY_INFORMATION2 response](#) 587
[SMB_COM_READ response](#) 584
[SMB_COM_READ_ANDX response](#) 589
[SMB_COM_READ_MPX response](#) 586
[SMB_COM_READ_RAW response](#) 585
[SMB_COM_SEARCH response](#) 590
[SMB_COM_SEEK response](#) 585
[SMB_COM_SESSION_SETUP_ANDX response](#) 581
[SMB_COM_TRANSACTION response](#) 588
[SMB_COM_TRANSACTION subcommand response](#) 591
[SMB_COM_TRANSACTION2 response](#) 589
[SMB_COM_TRANSACTION2 subcommand response](#) 593
[SMB_COM_TREE_CONNECT response](#) 582
[SMB_COM_TREE_CONNECT_ANDX response](#) 582
[SMB_COM_TREE_DISCONNECT response](#) 590
[SMB_COM_WRITE response](#) 584
[SMB_COM_WRITE_AND_CLOSE response](#) 588
[SMB_COM_WRITE_AND_UNLOCK response](#) 585
[SMB_COM_WRITE_ANDX response](#) 589
[SMB_COM_WRITE_MPX response](#) 587
[SMB_COM_WRITE_RAW response](#) 586
[STATUS_PATH_NOT_COVERED](#) 597
server
[algorithms for challenge/response authentication](#) 522
[incoming connection](#) 617
receiving any message ([section 3.1.5.1](#) 522, [section 3.3.5.2](#) 618)
RPC
[algorithms for challenge/response authentication](#) 522
[overview](#) 689
[receiving any message](#) 522
[SMB_COM_CHECK_DIRECTORY request](#) 634
[SMB_COM_CLOSE request](#) 626
[SMB_COM_CLOSE_PRINT_FILE request](#) 664
[SMB_COM_CREATE request](#) 625
[SMB_COM_CREATE_DIRECTORY request](#) 622
[SMB_COM_CREATE_NEW request](#) 633
[SMB_COM_CREATE_TEMPORARY request](#) 632
[SMB_COM_DELETE request](#) 626
[SMB_COM_DELETE_DIRECTORY request](#) 623
[SMB_COM_ECHO request](#) 644
[SMB_COM_FIND request](#) 657
[SMB_COM_FIND_CLOSE request](#) 659
[SMB_COM_FIND_CLOSE2 request](#) 650
[SMB_COM_FIND_UNIQUE request](#) 659
[SMB_COM_FLUSH request](#) 626
[SMB_COM_IOCTL request](#) 643
[SMB_COM_LOCK_AND_READ request](#) 635
[SMB_COM_LOCK_BYTE_RANGE request](#) 631
[SMB_COM_LOCKING_ANDX request](#) 642
[SMB_COM_LOGOFF_ANDX request](#) 654
[SMB_COM_NEGOTIATE request](#) 652
[SMB_COM_NT_CANCEL request](#) 662
[SMB_COM_NT_CREATE_ANDX request](#) 660

[SMB_COM_NT_RENAME_request](#) 662
[SMB_COM_NT_TRANSACT_request](#) 659
[SMB_COM_NT_TRANSACT_subcommand_request](#) 675
[SMB_COM_OPEN_request](#) 624
[SMB_COM_OPEN_ANDX_request](#) 645
[SMB_COM_OPEN_PRINT_FILE_request](#) 664
[SMB_COM_PROCESS_EXIT_request](#) 634
[SMB_COM_QUERY_INFORMATION_request](#) 629
[SMB_COM_QUERY_INFORMATION_DISK_request](#) 656
[SMB_COM_QUERY_INFORMATION2_request](#) 641
[SMB_COM_READ_request](#) 630
[SMB_COM_READ_ANDX_request](#) 647
[SMB_COM_READ_MPX_request](#) 638
[SMB_COM_READ_RAW_request](#) 636
[SMB_COM_RENAME_request](#) 628
[SMB_COM_SEARCH_request](#) 657
[SMB_COM_SEEK_request](#) 635
[SMB_COM_SESSION_SETUP_ANDX_request](#) 652
[SMB_COM_SET_INFORMATION_request](#) 629
[SMB_COM_SET_INFORMATION2_request](#) 642
[SMB_COM_TRANSACTION_request](#) 643
[SMB_COM_TRANSACTION_subcommand_request](#) 665
[SMB_COM_TRANSACTION2_request](#) 649
[SMB_COM_TRANSACTION2_subcommand_request](#) 670
[SMB_COM_TREE_CONNECT_request](#) 650
[SMB_COM_TREE_CONNECT_ANDX_request](#) 655
[SMB_COM_TREE_DISCONNECT_request](#) 651
[SMB_COM_UNLOCK_BYTE_RANGE_request](#) 632
[SMB_COM_WRITE_request](#) 630
[SMB_COM_WRITE_AND_CLOSE_request](#) 644
[SMB_COM_WRITE_AND_UNLOCK_request](#) 636
[SMB_COM_WRITE_ANDX_request](#) 648
[SMB_COM_WRITE_MPX_request](#) 640
[SMB_COM_WRITE_PRINT_FILE_request](#) 664
[SMB_COM_WRITE_RAW_request](#) 639
[Message signing example](#) 691
 Messages
 [character_sequences_data_type](#) 41
 [common_data_types](#) 40
 [data_buffer_format_codes](#) 79
 [file_attributes_data_type](#) 43
 information level
 [codes](#) 64
 [overview](#) 496
 NT Transact subcommands
 [NT_TRANSACT_CREATE\(0x0001\)](#) 469
 [NT_TRANSACT_IOCTL\(0x0002\)](#) 483
 [NT_TRANSACT_NOTIFY_CHANGE\(0x0004\)](#) 489
 [NT_TRANSACT_QUERY_SECURITY_DESC\(0x0006\)](#) 492
 [NT_TRANSACT_RENAME\(0x0005\)](#) 492
 [NT_TRANSACT_SET_SECURITY_DESC\(0x0003\)](#) 486
 SMB
 commands

[SMB_COM_CHECK_DIRECTORY\(0x10\)](#) 155
[SMB_COM_CLOSE\(0x04\)](#) 105
[SMB_COM_CLOSE_AND_TREE_DISC\(0x31\)](#) 276
[SMB_COM_CLOSE_PRINT_FILE\(0xC2\)](#) 398
[SMB_COM_COPY\(0x29\)](#) 239
[SMB_COM_CREATE\(0x03\)](#) 100
[SMB_COM_CREATE_DIRECTORY\(0x00\)](#) 88
[SMB_COM_CREATE_NEW\(0x0F\)](#) 151
[SMB_COM_CREATE_TEMPORARY\(0x0E\)](#) 146
[SMB_COM_DELETE\(0x06\)](#) 111
[SMB_COM_DELETE_DIRECTORY\(0x01\)](#) 91
[SMB_COM_ECHO\(0x2B\)](#) 240
[SMB_COM_FIND\(0x82\)](#) 338
[SMB_COM_FIND_CLOSE\(0x84\)](#) 351
[SMB_COM_FIND_CLOSE2\(0x34\)](#) 289
[SMB_COM_FIND_NOTIFY_CLOSE\(0x35\)](#) 291
[SMB_COM_FIND_UNIQUE\(0x83\)](#) 345
[SMB_COM_FLUSH\(0x05\)](#) 108
[SMB_COM_GET_PRINT_QUEUE\(0xC3\)](#) 400
[SMB_COM_INVALID\(0xFE\)](#) 401
[SMB_COM_IOCTL\(0x27\)](#) 231
[SMB_COM_IOCTL_SECONDARY\(0x28\)](#) 239
[SMB_COM_LOCK_AND_READ\(0x13\)](#) 164
[SMB_COM_LOCK_BYTE_RANGE\(0x0C\)](#) 138
[SMB_COM_LOCKING_ANDX\(0x24\)](#) 208
[SMB_COM_LOGOFF_ANDX\(0x74\)](#) 317
[SMB_COM_MOVE\(0x2A\)](#) 240
[SMB_COM_NEGOTIATE\(0x72\)](#) 298
[SMB_COM_NEW_FILE_SIZE\(0x30\)](#) 276
[SMB_COM_NO_ANDX_COMMAND\(0xFF\)](#) 401
[SMB_COM_NT_CANCEL\(0xA4\)](#) 385
[SMB_COM_NT_CREATE_ANDX\(0xA2\)](#) 370
[SMB_COM_NT_RENAME\(0xA5\)](#) 387
[SMB_COM_NT_TRANSACT\(0xA0\)](#) 356
[SMB_COM_NT_TRANSACT_SECONDARY\(0xA1\)](#) 365
[SMB_COM_OPEN\(0x02\)](#) 94
[SMB_COM_OPEN_ANDX\(0x2D\)](#) 249
[SMB_COM_OPEN_PRINT_FILE\(0xC0\)](#) 390
[SMB_COM_PROCESS_EXIT\(0x11\)](#) 158
[SMB_COM_QUERY_INFORMATION\(0x08\)](#) 118
[SMB_COM_QUERY_INFORMATION_DISK\(0x80\)](#) 327
[SMB_COM_QUERY_INFORMATION2\(0x23\)](#) 204
[SMB_COM_QUERY_SERVER\(0x21\)](#) 201
[SMB_COM_READ\(0x0A\)](#) 127
[SMB_COM_READ_ANDX\(0x2E\)](#) 259
[SMB_COM_READ_BULK\(0xD8\)](#) 400
[SMB_COM_READ_MPX\(0x1B\)](#) 179
[SMB_COM_READ_MPX_SECONDARY\(0x1C\)](#) 185
[SMB_COM_READ_RAW\(0x1A\)](#) 176
[SMB_COM_RENAME\(0x07\)](#) 114
[SMB_COM_SEARCH\(0x81\)](#) 331
[SMB_COM_SECURITY_PACKAGE_ANDX\(0x7E\)](#) 327
[SMB_COM_SEEK\(0x12\)](#) 160

- [SMB_COM_SESSION_SETUP_ANDX \(0x73\)](#) 307
- [SMB_COM_SET_INFORMATION \(0x09\)](#) 122
- [SMB_COM_SET_INFORMATION2 \(0x22\)](#) 201
- [SMB_COM_TRANSACTION \(0x25\)](#) 217
- [SMB_COM_TRANSACTION_SECONDARY \(0x26\)](#) 227
- [SMB_COM_TRANSACTION2 \(0x32\)](#) 276
- [SMB_COM_TRANSACTION2_SECONDARY \(0x33\)](#) 285
- [SMB_COM_TREE_CONNECT \(0x70\)](#) 291
- [SMB_COM_TREE_CONNECT_ANDX \(0x75\)](#) 319
- [SMB_COM_TREE_DISCONNECT \(0x71\)](#) 296
- [SMB_COM_UNLOCK_BYTE_RANGE \(0x0D\)](#) 142
- [SMB_COM_WRITE \(0x0B\)](#) 132
- [SMB_COM_WRITE_AND_CLOSE \(0x2C\)](#) 243
- [SMB_COM_WRITE_AND_UNLOCK \(0x14\)](#) 170
- [SMB_COM_WRITE_ANDX \(0x2F\)](#) 267
- [SMB_COM_WRITE_BULK \(0xD9\)](#) 400
- [SMB_COM_WRITE_BULK_DATA \(0xDA\)](#) 401
- [SMB_COM_WRITE_COMPLETE \(0x20\)](#) 201
- [SMB_COM_WRITE_MPX \(0x1E\)](#) 193
- [SMB_COM_WRITE_MPX_SECONDARY \(0x1F\)](#) 200
- [SMB_COM_WRITE_PRINT_FILE \(0xC1\)](#) 394
- [SMB_COM_WRITE_RAW \(0x1D\)](#) 185
- structure
 - [batched messages \("AndX" messages\)](#) 87
 - [data block](#) 87
 - [overview](#) 80
 - [parameter block](#) 86
 - [SMB Header](#) 80
- [SMB error classes and codes](#) 67
- [SMB_COM command codes](#) 54
- [SMB_ERROR data type](#) 50
- [SMB_NMPIPE_STATUS data type](#) 48
- [syntax](#) 38
- [time data type](#) 49
- [transaction subcommand codes](#) 61
- Transaction subcommands
 - [overview](#) 401
 - [TRANS_CALL_NMPIPE \(0x0054\)](#) 430
 - [TRANS_MAILSLLOT_WRITE \(0x0001\)](#) 434
 - [TRANS_PEEK_NMPIPE \(0x0023\)](#) 413
 - [TRANS_QUERY_NMPIPE_INFO \(0x0022\)](#) 409
 - [TRANS_QUERY_NMPIPE_STATE \(0x0021\)](#) 407
 - [TRANS_RAW_READ_NMPIPE \(0x0011\)](#) 404
 - [TRANS_RAW_WRITE_NMPIPE \(0x0031\)](#) 420
 - [TRANS_READ_NMPIPE \(0x0036\)](#) 423
 - [TRANS_SET_NMPIPE_STATE \(0x0001\)](#) 401
 - [TRANS_TRANSACT_NMPIPE \(0x0026\)](#) 417
 - [TRANS_WAIT_NMPIPE \(0x0053\)](#) 428
 - [TRANS_WRITE_NMPIPE \(0x0037\)](#) 426
- Transaction2 subcommands
 - [TRANS2_CREATE_DIRECTORY \(0x000D\)](#) 464
 - [TRANS2_FIND_FIRST2 \(0x0001\)](#) 441
 - [TRANS2_FIND_NEXT2 \(0x0002\)](#) 445
 - [TRANS2_FIND_NOTIFY_FIRST \(0x000B\)](#) 464
 - [TRANS2_FIND_NOTIFY_NEXT \(0x000C\)](#) 464
- [TRANS2_FSCTL \(0x0009\)](#) 464
- [TRANS2_GET_DFS_REFERRAL \(0x0010\)](#) 468
- [TRANS2_IOCTL2 \(0x000A\)](#) 464
- [TRANS2_OPEN2 \(0x0000\)](#) 434
- [TRANS2_QUERY_FILE_INFORMATION \(0x0007\)](#) 457
- [TRANS2_QUERY_FS_INFORMATION \(0x0003\)](#) 450
- [TRANS2_QUERY_PATH_INFORMATION \(0x0005\)](#) 452
- [TRANS2_REPORT_DFS_INCONSISTENCY \(0x0011\)](#) 469
- [TRANS2_SESSION_SETUP \(0x000E\)](#) 467
- [TRANS2_SET_FILE_INFORMATION \(0x0008\)](#) 461
- [TRANS2_SET_FS_INFORMATION \(0x0004\)](#) 451
- [TRANS2_SET_PATH_INFORMATION \(0x0006\)](#) 455
- transport
 - [direct hosting](#) 34
 - [direct IPX](#) 34
 - NetBIOS
 - [frames](#) 33
 - over
 - [IPX/SPX](#) 34
 - [TCP/UDP](#) 34
 - NetBIOS-based transports
 - [other](#) 34
 - [overview](#) 33
 - [virtual circuits](#) 38
 - [unique identifiers data type](#) 51
- [MINUTES](#) 50
- [MONTH](#) 49

N

- [Negotiate and tree connect example](#) 690
- NetBIOS
 - [frames](#) 33
 - over
 - [IPX/SPX](#) 34
 - [TCP/UDP](#) 34
- NetBIOS-based transports
 - [other](#) 34
 - [overview](#) 33
- [Normative references](#) 22
- NT Transact subcommands
 - [NT_TRANSACT_CREATE \(0x0001\)](#) 469
 - [NT_TRANSACT_IOCTL \(0x0002\)](#) 483
 - [NT_TRANSACT_NOTIFY_CHANGE \(0x0004\)](#) 489
 - [NT_TRANSACT_QUERY_SECURITY_DESC \(0x0006\)](#) 492
 - [NT_TRANSACT_RENAME \(0x0005\)](#) 492
 - [NT_TRANSACT_SET_SECURITY_DESC \(0x0003\)](#) 486

O

- [Other](#) 47
- [Overview](#) 26

P

[Parameters - security index](#) 698

[Preconditions](#) 29

[Prerequisites](#) 29

[Product behavior](#) 699

R

References

[informative](#) 23

[normative](#) 22

[Relationship to other protocols](#) 28

Request packet ([section 2.2.4.2.1](#) 91, [section 2.2.4.3.1](#) 94, [section 2.2.4.4.1](#) 101, [section 2.2.4.5.1](#) 106, [section 2.2.4.6.1](#) 108, [section 2.2.4.7.1](#) 111, [section 2.2.4.8.1](#) 114, [section 2.2.4.9.1](#) 119, [section 2.2.4.10.1](#) 123, [section 2.2.4.11.1](#) 127, [section 2.2.4.12.1](#) 133, [section 2.2.4.13.1](#) 139, [section 2.2.4.14.1](#) 142, [section 2.2.4.15.1](#) 146, [section 2.2.4.16.1](#) 151, [section 2.2.4.17.1](#) 156, [section 2.2.4.18.1](#) 158, [section 2.2.4.19.1](#) 161, [section 2.2.4.20.1](#) 165, [section 2.2.4.21.1](#) 171, [section 2.2.4.22.1](#) 176, [section 2.2.4.23.1](#) 179, [section 2.2.4.25.1](#) 186, [section 2.2.4.26.1](#) 194, [section 2.2.4.30.1](#) 201, [section 2.2.4.31.1](#) 205, [section 2.2.4.32.1](#) 209, [section 2.2.4.33.1](#) 217, [section 2.2.4.34.1](#) 228, [section 2.2.4.35.1](#) 231, [section 2.2.4.39.1](#) 240, [section 2.2.4.40.1](#) 243, [section 2.2.4.41.1](#) 249, [section 2.2.4.42.1](#) 260, [section 2.2.4.43.1](#) 267, [section 2.2.4.46.1](#) 276, [section 2.2.4.47.1](#) 285, [section 2.2.4.48.1](#) 289, [section 2.2.4.50.1](#) 292, [section 2.2.4.51.1](#) 296, [section 2.2.4.52.1](#) 298, [section 2.2.4.53.1](#) 308, [section 2.2.4.54.1](#) 317, [section 2.2.4.55.1](#) 320, [section 2.2.4.57.1](#) 328, [section 2.2.4.58.1](#) 331, [section 2.2.4.59.1](#) 338, [section 2.2.4.60.1](#) 345, [section 2.2.4.61.1](#) 351, [section 2.2.4.62.1](#) 357, [section 2.2.4.63.1](#) 365, [section 2.2.4.64.1](#) 370, [section 2.2.4.65.1](#) 385, [section 2.2.4.66.1](#) 387, [section 2.2.4.67.1](#) 390, [section 2.2.4.68.1](#) 395, [section 2.2.4.69.1](#) 398, [section 2.2.5.1.1](#) 402, [section 2.2.5.4.1](#) 410, [section 2.2.5.6.1](#) 417, [section 2.2.5.7.1](#) 420, [section 2.2.5.9.1](#) 426, [section 2.2.5.11.1](#) 430, [section 2.2.6.8.1](#) 458, [section 2.2.6.9.1](#) 461, [section 2.2.7.1.1](#) 469, [section 2.2.7.2.1](#) 483, [section 2.2.7.3.1](#) 486, [section 2.2.7.4.1](#) 489, [section 2.2.7.6.1](#) 493)

Response packet ([section 2.2.4.2.2](#) 92, [section 2.2.4.3.2](#) 97, [section 2.2.4.4.2](#) 102, [section 2.2.4.5.2](#) 107, [section 2.2.4.6.2](#) 109, [section 2.2.4.7.2](#) 113, [section 2.2.4.8.2](#) 116, [section 2.2.4.9.2](#) 120, [section 2.2.4.10.2](#) 125, [section 2.2.4.11.2](#) 129, [section 2.2.4.12.2](#) 135, [section 2.2.4.13.2](#) 140, [section 2.2.4.14.2](#) 144, [section 2.2.4.15.2](#) 148, [section 2.2.4.16.2](#) 153, [section 2.2.4.17.2](#) 157, [section 2.2.4.18.2](#) 159, [section 2.2.4.19.2](#) 162, [section 2.2.4.20.2](#) 166, [section 2.2.4.21.2](#) 173, [section 2.2.4.23.2](#) 181, [section 2.2.4.26.2](#) 197, [section 2.2.4.30.2](#) 203, [section](#)

[2.2.4.31.2](#) 206, [section 2.2.4.32.2](#) 214, [section 2.2.4.33.2](#) 223, [section 2.2.4.35.2](#) 235, [section 2.2.4.39.2](#) 241, [section 2.2.4.40.2](#) 245, [section 2.2.4.41.2](#) 254, [section 2.2.4.42.2](#) 262, [section 2.2.4.43.2](#) 271, [section 2.2.4.46.2](#) 281, [section 2.2.4.48.2](#) 290, [section 2.2.4.50.2](#) 294, [section 2.2.4.51.2](#) 297, [section 2.2.4.52.2](#) 300, [section 2.2.4.53.2](#) 313, [section 2.2.4.54.2](#) 318, [section 2.2.4.55.2](#) 324, [section 2.2.4.57.2](#) 329, [section 2.2.4.58.2](#) 334, [section 2.2.4.59.2](#) 341, [section 2.2.4.60.2](#) 347, [section 2.2.4.61.2](#) 354, [section 2.2.4.62.2](#) 361, [section 2.2.4.64.2](#) 379, [section 2.2.4.66.2](#) 388, [section 2.2.4.67.2](#) 392, [section 2.2.4.68.2](#) 396, [section 2.2.4.69.2](#) 399, [section 2.2.5.2.2](#) 405, [section 2.2.5.3.2](#) 408, [section 2.2.5.4.2](#) 411, [section 2.2.5.5.2](#) 414, [section 2.2.5.6.2](#) 418, [section 2.2.5.7.2](#) 421, [section 2.2.5.8.2](#) 424, [section 2.2.5.9.2](#) 427, [section 2.2.5.11.2](#) 432, [section 2.2.6.3.2](#) 448, [section 2.2.6.7.2](#) 456, [section 2.2.6.9.2](#) 462, [section 2.2.6.14.2](#) 465, [section 2.2.7.1.2](#) 477, [section 2.2.7.2.2](#) 484, [section 2.2.7.4.2](#) 491, [section 2.2.7.6.2](#) 494)

S

[SECONDS](#) 50

Security

[implementer considerations](#) 698

[overview](#) 698

[parameter index](#) 698

Sequencing rules

client

[algorithms for challenge/response](#)

[authentication](#) 522

OpLock

[break notification](#) 596

[grant](#) 596

receiving any message ([section 3.1.5.1](#) 522, [section 3.2.5.1](#) 578)

RPC

[algorithms for challenge/response](#)

[authentication](#) 522

[overview](#) 688

[receiving any message](#) 522

[SMB_COM_CLOSE response](#) 583

[SMB_COM_CREATE response](#) 583

[SMB_COM_CREATE_NEW response](#) 584

[SMB_COM_CREATE_TEMPORARY response](#) 584

[SMB_COM_ECHO response](#) 588

[SMB_COM_FIND response](#) 590

[SMB_COM_FIND_CLOSE2 response](#) 589

[SMB_COM_FIND_UNIQUE response](#) 590

[SMB_COM_IOCTL response](#) 588

[SMB_COM_LOCK_AND_READ response](#) 585

[SMB_COM_LOGOFF_ANDX response](#) 590

[SMB_COM_NEGOTIATE response](#) 580

[SMB_COM_NT_CREATE_ANDX response](#) 591

[SMB_COM_NT_TRANSACT response](#) 591

[SMB_COM_NT_TRANSACT subcommand response](#) 595

[SMB_COM_OPEN response](#) 583

[SMB_COM_OPEN_ANDX response](#) 588
[SMB_COM_OPEN_PRINT_FILE response](#) 591
[SMB_COM_QUERY_INFORMATION response](#) 584
[SMB_COM_QUERY_INFORMATION_DISK response](#) 590
[SMB_COM_QUERY_INFORMATION2 response](#) 587
[SMB_COM_READ response](#) 584
[SMB_COM_READ_ANDX response](#) 589
[SMB_COM_READ_MPX response](#) 586
[SMB_COM_READ_RAW response](#) 585
[SMB_COM_SEARCH response](#) 590
[SMB_COM_SEEK response](#) 585
[SMB_COM_SESSION_SETUP_ANDX response](#) 581
[SMB_COM_TRANSACTION response](#) 588
[SMB_COM_TRANSACTION subcommand response](#) 591
[SMB_COM_TRANSACTION2 response](#) 589
[SMB_COM_TRANSACTION2 subcommand response](#) 593
[SMB_COM_TREE_CONNECT response](#) 582
[SMB_COM_TREE_CONNECT_ANDX response](#) 582
[SMB_COM_TREE_DISCONNECT response](#) 590
[SMB_COM_WRITE response](#) 584
[SMB_COM_WRITE_AND_CLOSE response](#) 588
[SMB_COM_WRITE_AND_UNLOCK response](#) 585
[SMB_COM_WRITE_ANDX response](#) 589
[SMB_COM_WRITE_MPX response](#) 587
[SMB_COM_WRITE_RAW response](#) 586
[STATUS_PATH_NOT_COVERED](#) 597

server
[algorithms for challenge/response authentication](#) 522
[incoming connection](#) 617
 receiving any message ([section 3.1.5.1](#) 522, [section 3.3.5.2](#) 618)
 RPC
[algorithms for challenge/response authentication](#) 522
[overview](#) 689
[receiving any message](#) 522
[SMB_COM_CHECK_DIRECTORY request](#) 634
[SMB_COM_CLOSE request](#) 626
[SMB_COM_CLOSE_PRINT_FILE request](#) 664
[SMB_COM_CREATE request](#) 625
[SMB_COM_CREATE_DIRECTORY request](#) 622
[SMB_COM_CREATE_NEW request](#) 633
[SMB_COM_CREATE_TEMPORARY request](#) 632
[SMB_COM_DELETE request](#) 626
[SMB_COM_DELETE_DIRECTORY request](#) 623
[SMB_COM_ECHO request](#) 644
[SMB_COM_FIND request](#) 657
[SMB_COM_FIND_CLOSE request](#) 659
[SMB_COM_FIND_CLOSE2 request](#) 650
[SMB_COM_FIND_UNIQUE request](#) 659
[SMB_COM_FLUSH request](#) 626
[SMB_COM_IOCTL request](#) 643
[SMB_COM_LOCK_AND_READ request](#) 635
[SMB_COM_LOCK_BYTE_RANGE request](#) 631
[SMB_COM_LOCKING_ANDX request](#) 642
[SMB_COM_LOGOFF_ANDX request](#) 654
[SMB_COM_NEGOTIATE request](#) 652
[SMB_COM_NT_CANCEL request](#) 662
[SMB_COM_NT_CREATE_ANDX request](#) 660
[SMB_COM_NT_RENAME request](#) 662
[SMB_COM_NT_TRANSACT request](#) 659
[SMB_COM_NT_TRANSACT subcommand request](#) 675
[SMB_COM_OPEN request](#) 624
[SMB_COM_OPEN_ANDX request](#) 645
[SMB_COM_OPEN_PRINT_FILE request](#) 664
[SMB_COM_PROCESS_EXIT request](#) 634
[SMB_COM_QUERY_INFORMATION request](#) 629
[SMB_COM_QUERY_INFORMATION_DISK request](#) 656
[SMB_COM_QUERY_INFORMATION2 request](#) 641
[SMB_COM_READ request](#) 630
[SMB_COM_READ_ANDX request](#) 647
[SMB_COM_READ_MPX request](#) 638
[SMB_COM_READ_RAW request](#) 636
[SMB_COM_RENAME request](#) 628
[SMB_COM_SEARCH request](#) 657
[SMB_COM_SEEK request](#) 635
[SMB_COM_SESSION_SETUP_ANDX request](#) 652
[SMB_COM_SET_INFORMATION request](#) 629
[SMB_COM_SET_INFORMATION2 request](#) 642
[SMB_COM_TRANSACTION request](#) 643
[SMB_COM_TRANSACTION subcommand request](#) 665
[SMB_COM_TRANSACTION2 request](#) 649
[SMB_COM_TRANSACTION2 subcommand request](#) 670
[SMB_COM_TREE_CONNECT request](#) 650
[SMB_COM_TREE_CONNECT_ANDX request](#) 655
[SMB_COM_TREE_DISCONNECT request](#) 651
[SMB_COM_UNLOCK_BYTE_RANGE request](#) 632
[SMB_COM_WRITE request](#) 630
[SMB_COM_WRITE_AND_CLOSE request](#) 644
[SMB_COM_WRITE_AND_UNLOCK request](#) 636
[SMB_COM_WRITE_ANDX request](#) 648
[SMB_COM_WRITE_MPX request](#) 640
[SMB_COM_WRITE_PRINT_FILE request](#) 664
[SMB_COM_WRITE_RAW request](#) 639

Server
 abstract data model
 global ([section 3.1.1.1](#) 520, [section 3.3.1.1](#) 598)
 overview ([section 3.1.1](#) 520, [section 3.3.1](#) 598)
[share](#) 601
 SMB
[command - pending](#) 604
[connection](#) 601
[session](#) 604
[tree connect](#) 605
 unique
[open](#) 605
[open search](#) 606

- higher-layer triggered events
 - client session
 - [security context](#) 610
 - [session key](#) 610
 - [configuration - updating](#) 616
 - DFS subsystem
 - [active](#) 610
 - [DFS share](#) 610
 - [not a DFS share](#) 610
 - [disabling](#) 615
 - [enabling](#) 615
 - open
 - [closing](#) 613
 - [querying](#) 614
 - [OpLock break](#) 609
 - [pausing](#) 615
 - [resuming](#) 616
 - sending any message ([section 3.1.4.1](#) 520, [section 3.3.4.1](#) 608)
 - session
 - [closing](#) 611
 - [querying](#) 613
 - share
 - [deregistering](#) 612
 - [querying](#) 612
 - [registering](#) 611
 - [updating](#) 612
 - [statistics](#) 616
 - [transport binding change](#) 615
 - [TreeConnect - querying](#) 614
 - initialization ([section 3.1.3](#) 520, [section 3.3.3](#) 607)
 - local events
 - [disconnecting connection](#) 680
 - handling
 - [incoming transport connection](#) 680
 - [transport disconnect](#) 680
 - [overview](#) 523
 - message processing
 - [algorithms for challenge/response authentication](#) 522
 - [incoming connection](#) 617
 - receiving any message ([section 3.1.5.1](#) 522, [section 3.3.5.2](#) 618)
 - [SMB_COM_CHECK_DIRECTORY request](#) 634
 - [SMB_COM_CLOSE request](#) 626
 - [SMB_COM_CLOSE_PRINT_FILE request](#) 664
 - [SMB_COM_CREATE request](#) 625
 - [SMB_COM_CREATE_DIRECTORY request](#) 622
 - [SMB_COM_CREATE_NEW request](#) 633
 - [SMB_COM_CREATE_TEMPORARY request](#) 632
 - [SMB_COM_DELETE request](#) 626
 - [SMB_COM_DELETE_DIRECTORY request](#) 623
 - [SMB_COM_ECHO request](#) 644
 - [SMB_COM_FIND request](#) 657
 - [SMB_COM_FIND_CLOSE request](#) 659
 - [SMB_COM_FIND_CLOSE2 request](#) 650
 - [SMB_COM_FIND_UNIQUE request](#) 659
 - [SMB_COM_FLUSH request](#) 626
 - [SMB_COM_IOCTL request](#) 643
 - [SMB_COM_LOCK_AND_READ request](#) 635
 - [SMB_COM_LOCK_BYTE_RANGE request](#) 631
 - [SMB_COM_LOCKING_ANDX request](#) 642
 - [SMB_COM_LOGOFF_ANDX request](#) 654
 - [SMB_COM_NEGOTIATE request](#) 652
 - [SMB_COM_NT_CANCEL request](#) 662
 - [SMB_COM_NT_CREATE_ANDX request](#) 660
 - [SMB_COM_NT_RENAME request](#) 662
 - [SMB_COM_NT_TRANSACT request](#) 659
 - [SMB_COM_NT_TRANSACT subcommand request](#) 675
 - [SMB_COM_OPEN request](#) 624
 - [SMB_COM_OPEN_ANDX request](#) 645
 - [SMB_COM_OPEN_PRINT_FILE request](#) 664
 - [SMB_COM_PROCESS_EXIT request](#) 634
 - [SMB_COM_QUERY_INFORMATION request](#) 629
 - [SMB_COM_QUERY_INFORMATION_DISK request](#) 656
 - [SMB_COM_QUERY_INFORMATION2 request](#) 641
 - [SMB_COM_READ request](#) 630
 - [SMB_COM_READ_ANDX request](#) 647
 - [SMB_COM_READ_MPX request](#) 638
 - [SMB_COM_READ_RAW request](#) 636
 - [SMB_COM_RENAME request](#) 628
 - [SMB_COM_SEARCH request](#) 657
 - [SMB_COM_SEEK request](#) 635
 - [SMB_COM_SESSION_SETUP_ANDX request](#) 652
 - [SMB_COM_SET_INFORMATION request](#) 629
 - [SMB_COM_SET_INFORMATION2 request](#) 642
 - [SMB_COM_TRANSACTION request](#) 643
 - [SMB_COM_TRANSACTION subcommand request](#) 665
 - [SMB_COM_TRANSACTION2 request](#) 649
 - [SMB_COM_TRANSACTION2 subcommand request](#) 670
 - [SMB_COM_TREE_CONNECT request](#) 650
 - [SMB_COM_TREE_CONNECT_ANDX request](#) 655
 - [SMB_COM_TREE_DISCONNECT request](#) 651
 - [SMB_COM_UNLOCK_BYTE_RANGE request](#) 632
 - [SMB_COM_WRITE request](#) 630
 - [SMB_COM_WRITE_AND_CLOSE request](#) 644
 - [SMB_COM_WRITE_AND_UNLOCK request](#) 636
 - [SMB_COM_WRITE_ANDX request](#) 648
 - [SMB_COM_WRITE_MPX request](#) 640
 - [SMB_COM_WRITE_PRINT_FILE request](#) 664
 - [SMB_COM_WRITE_RAW request](#) 639
 - RPC
 - abstract data model
 - [global](#) 520
 - overview ([section 3.1.1](#) 520, [section 3.5.1](#) 688)
 - higher-layer triggered events
 - named pipe
 - [closing its open](#) 689
 - [waiting for clients to open](#) 688
 - [security context](#) 689
 - [sending any message](#) 520
 - [session key](#) 689
 - initialization ([section 3.1.3](#) 520, [section 3.5.3](#) 688)

[local events \(section 3.1.7 523, section 3.5.7 689\)](#)
[message processing](#)
 [algorithms for challenge/response authentication](#) 522
 [overview](#) 689
 [receiving any message](#) 522
[overview](#) 688
[sequencing rules](#)
 [algorithms for challenge/response authentication](#) 522
 [overview](#) 689
 [receiving any message](#) 522
[timer events \(section 3.1.6 523, section 3.5.6 689\)](#)
[timers \(section 3.1.2 520, section 3.5.2 688\)](#)
[sequencing rules](#)
 [algorithms for challenge/response authentication](#) 522
 [incoming connection](#) 617
 [receiving any message \(section 3.1.5.1 522, section 3.3.5.2 618\)](#)
 [SMB_COM_CHECK_DIRECTORY request](#) 634
 [SMB_COM_CLOSE request](#) 626
 [SMB_COM_CLOSE_PRINT_FILE request](#) 664
 [SMB_COM_CREATE request](#) 625
 [SMB_COM_CREATE_DIRECTORY request](#) 622
 [SMB_COM_CREATE_NEW request](#) 633
 [SMB_COM_CREATE_TEMPORARY request](#) 632
 [SMB_COM_DELETE request](#) 626
 [SMB_COM_DELETE_DIRECTORY request](#) 623
 [SMB_COM_ECHO request](#) 644
 [SMB_COM_FIND request](#) 657
 [SMB_COM_FIND_CLOSE request](#) 659
 [SMB_COM_FIND_CLOSE2 request](#) 650
 [SMB_COM_FIND_UNIQUE request](#) 659
 [SMB_COM_FLUSH request](#) 626
 [SMB_COM_IOCTL request](#) 643
 [SMB_COM_LOCK_AND_READ request](#) 635
 [SMB_COM_LOCK_BYTE_RANGE request](#) 631
 [SMB_COM_LOCKING_ANDX request](#) 642
 [SMB_COM_LOGOFF_ANDX request](#) 654
 [SMB_COM_NEGOTIATE request](#) 652
 [SMB_COM_NT_CANCEL request](#) 662
 [SMB_COM_NT_CREATE_ANDX request](#) 660
 [SMB_COM_NT_RENAME request](#) 662
 [SMB_COM_NT_TRANSACT request](#) 659
 [SMB_COM_NT_TRANSACT subcommand request](#) 675
 [SMB_COM_OPEN request](#) 624
 [SMB_COM_OPEN_ANDX request](#) 645
 [SMB_COM_OPEN_PRINT_FILE request](#) 664
 [SMB_COM_PROCESS_EXIT request](#) 634
 [SMB_COM_QUERY_INFORMATION request](#) 629
 [SMB_COM_QUERY_INFORMATION_DISK request](#) 656
 [SMB_COM_QUERY_INFORMATION2 request](#) 641
 [SMB_COM_READ request](#) 630
 [SMB_COM_READ_ANDX request](#) 647
 [SMB_COM_READ_MPX request](#) 638
 [SMB_COM_READ_RAW request](#) 636
 [SMB_COM_RENAME request](#) 628
 [SMB_COM_SEARCH request](#) 657
 [SMB_COM_SEEK request](#) 635
 [SMB_COM_SESSION_SETUP_ANDX request](#) 652
 [SMB_COM_SET_INFORMATION request](#) 629
 [SMB_COM_SET_INFORMATION2 request](#) 642
 [SMB_COM_TRANSACTION request](#) 643
 [SMB_COM_TRANSACTION subcommand request](#) 665
 [SMB_COM_TRANSACTION2 request](#) 649
 [SMB_COM_TRANSACTION2 subcommand request](#) 670
 [SMB_COM_TREE_CONNECT request](#) 650
 [SMB_COM_TREE_CONNECT_ANDX request](#) 655
 [SMB_COM_TREE_DISCONNECT request](#) 651
 [SMB_COM_UNLOCK_BYTE_RANGE request](#) 632
 [SMB_COM_WRITE request](#) 630
 [SMB_COM_WRITE_AND_CLOSE request](#) 644
 [SMB_COM_WRITE_AND_UNLOCK request](#) 636
 [SMB_COM_WRITE_ANDX request](#) 648
 [SMB_COM_WRITE_MPX request](#) 640
 [SMB_COM_WRITE_PRINT_FILE request](#) 664
 [SMB_COM_WRITE_RAW request](#) 639
[timer events](#)
 [idle connection](#) 679
 [OpLock break acknowledgment](#) 679
 [overview](#) 523
 [unused open search](#) 679
[timers](#) 520
[Set file attributes example](#) 693
[SMB commands](#)
 [SMB_COM_CHECK_DIRECTORY \(0x10\)](#) 155
 [SMB_COM_CLOSE \(0x04\)](#) 105
 [SMB_COM_CLOSE_AND_TREE_DISC \(0x31\)](#) 276
 [SMB_COM_CLOSE_PRINT_FILE \(0xC2\)](#) 398
 [SMB_COM_COPY \(0x29\)](#) 239
 [SMB_COM_CREATE \(0x03\)](#) 100
 [SMB_COM_CREATE_DIRECTORY \(0x00\)](#) 88
 [SMB_COM_CREATE_NEW \(0x0F\)](#) 151
 [SMB_COM_CREATE_TEMPORARY \(0x0E\)](#) 146
 [SMB_COM_DELETE \(0x06\)](#) 111
 [SMB_COM_DELETE_DIRECTORY \(0x01\)](#) 91
 [SMB_COM_ECHO \(0x2B\)](#) 240
 [SMB_COM_FIND \(0x82\)](#) 338
 [SMB_COM_FIND_CLOSE \(0x84\)](#) 351
 [SMB_COM_FIND_CLOSE2 \(0x34\)](#) 289
 [SMB_COM_FIND_NOTIFY_CLOSE \(0x35\)](#) 291
 [SMB_COM_FIND_UNIQUE \(0x83\)](#) 345
 [SMB_COM_FLUSH \(0x05\)](#) 108
 [SMB_COM_GET_PRINT_QUEUE \(0xC3\)](#) 400
 [SMB_COM_INVALID \(0xFE\)](#) 401
 [SMB_COM_IOCTL \(0x27\)](#) 231
 [SMB_COM_IOCTL_SECONDARY \(0x28\)](#) 239
 [SMB_COM_LOCK_AND_READ \(0x13\)](#) 164
 [SMB_COM_LOCK_BYTE_RANGE \(0x0C\)](#) 138
 [SMB_COM_LOCKING_ANDX \(0x24\)](#) 208
 [SMB_COM_LOGOFF_ANDX \(0x74\)](#) 317
 [SMB_COM_MOVE \(0x2A\)](#) 240
 [SMB_COM_NEGOTIATE \(0x72\)](#) 298

[SMB_COM_NEW_FILE_SIZE \(0x30\)](#) 276
[SMB_COM_NO_ANDX_COMMAND \(0xFF\)](#) 401
[SMB_COM_NT_CANCEL \(0xA4\)](#) 385
[SMB_COM_NT_CREATE_ANDX \(0xA2\)](#) 370
[SMB_COM_NT_RENAME \(0xA5\)](#) 387
[SMB_COM_NT_TRANSACT \(0xA0\)](#) 356
[SMB_COM_NT_TRANSACT_SECONDARY \(0xA1\)](#)
 365
[SMB_COM_OPEN \(0x02\)](#) 94
[SMB_COM_OPEN_ANDX \(0x2D\)](#) 249
[SMB_COM_OPEN_PRINT_FILE \(0xC0\)](#) 390
[SMB_COM_PROCESS_EXIT \(0x11\)](#) 158
[SMB_COM_QUERY_INFORMATION \(0x08\)](#) 118
[SMB_COM_QUERY_INFORMATION_DISK \(0x80\)](#)
 327
[SMB_COM_QUERY_INFORMATION2 \(0x23\)](#) 204
[SMB_COM_QUERY_SERVER \(0x21\)](#) 201
[SMB_COM_READ \(0x0A\)](#) 127
[SMB_COM_READ_ANDX \(0x2E\)](#) 259
[SMB_COM_READ_BULK \(0xD8\)](#) 400
[SMB_COM_READ_MPX \(0x1B\)](#) 179
[SMB_COM_READ_MPX_SECONDARY \(0x1C\)](#) 185
[SMB_COM_READ_RAW \(0x1A\)](#) 176
[SMB_COM_RENAME \(0x07\)](#) 114
[SMB_COM_SEARCH \(0x81\)](#) 331
[SMB_COM_SECURITY_PACKAGE_ANDX \(0x7E\)](#)
 327
[SMB_COM_SEEK \(0x12\)](#) 160
[SMB_COM_SESSION_SETUP_ANDX \(0x73\)](#) 307
[SMB_COM_SET_INFORMATION \(0x09\)](#) 122
[SMB_COM_SET_INFORMATION2 \(0x22\)](#) 201
[SMB_COM_TRANSACTION \(0x25\)](#) 217
[SMB_COM_TRANSACTION_SECONDARY \(0x26\)](#)
 227
[SMB_COM_TRANSACTION2 \(0x32\)](#) 276
[SMB_COM_TRANSACTION2_SECONDARY \(0x33\)](#)
 285
[SMB_COM_TREE_CONNECT \(0x70\)](#) 291
[SMB_COM_TREE_CONNECT_ANDX \(0x75\)](#) 319
[SMB_COM_TREE_DISCONNECT \(0x71\)](#) 296
[SMB_COM_UNLOCK_BYTE_RANGE \(0x0D\)](#) 142
[SMB_COM_WRITE \(0x0B\)](#) 132
[SMB_COM_WRITE_AND_CLOSE \(0x2C\)](#) 243
[SMB_COM_WRITE_AND_UNLOCK \(0x14\)](#) 170
[SMB_COM_WRITE_ANDX \(0x2F\)](#) 267
[SMB_COM_WRITE_BULK \(0xD9\)](#) 400
[SMB_COM_WRITE_BULK_DATA \(0xDA\)](#) 401
[SMB_COM_WRITE_COMPLETE \(0x20\)](#) 201
[SMB_COM_WRITE_MPX \(0x1E\)](#) 193
[SMB_COM_WRITE_MPX_SECONDARY \(0x1F\)](#) 200
[SMB_COM_WRITE_PRINT_FILE \(0xC1\)](#) 394
[SMB_COM_WRITE_RAW \(0x1D\)](#) 185
 SMB message structure
[batched messages \("AndX" messages\)](#) 87
[data block](#) 87
[overview](#) 80
[parameter block](#) 86
[SMB Header](#) 80
[SMB_COM_CREATE_DIRECTORY_REQUEST packet](#)
 88
[SMB_COM_CREATE_DIRECTORY_RESPONSE packet](#)
 89
[SMB Data packet](#) 87
[SMB_ERROR data type](#) 50
[SMB_ERROR packet](#) 50
[SMB_FEA packet](#) 44
[SMB_FEA_LIST packet](#) 45
[SMB_FILE_ATTRIBUTE_ARCHIVE](#) 47
[SMB_FILE_ATTRIBUTE_DIRECTORY](#) 47
[SMB_FILE_ATTRIBUTE_HIDDEN](#) 47
[SMB_FILE_ATTRIBUTE_NORMAL](#) 47
[SMB_FILE_ATTRIBUTE_READONLY](#) 47
[SMB_FILE_ATTRIBUTE_SYSTEM](#) 47
[SMB_FILE_ATTRIBUTE_VOLUME](#) 47
[SMB_FIND_FILE_BOTH_DIRECTORY_INFO packet](#)
 503
[SMB_FIND_FILE_DIRECTORY_INFO packet](#) 500
[SMB_FIND_FILE_FULL_DIRECTORY_INFO packet](#)
 501
[SMB_FIND_FILE_NAMES_INFO packet](#) 502
[SMB_GEA packet](#) 43
[SMB_GEA_LIST packet](#) 43
[SMB_Header packet](#) 80
[SMB_INFO_ALLOCATION packet](#) 504
[SMB_INFO_QUERY_ALL_EAS packet](#) 510
[SMB_INFO_QUERY_EA_SIZE packet \(section](#)
[2.2.8.1.2](#) 498, [section 2.2.8.3.2](#) 509)
[SMB_INFO_QUERY_EAS_FROM_LIST packet](#)
[\(section 2.2.8.1.3](#) 499, [section 2.2.8.3.3](#) 510)
[SMB_INFO_SET_EAS packet](#) 517
[SMB_INFO_STANDARD packet \(section 2.2.8.1.1](#)
[497, section 2.2.8.3.1](#) 509, [section 2.2.8.4.1](#)
[516\)](#)
[SMB_INFO_VOLUME packet](#) 505
[SMB_NMPIPE_STATUS data type](#) 48
[SMB_Parameters packet](#) 86
[SMB_QUERY_FILE_ALL_INFO packet](#) 513
[SMB_QUERY_FILE_ALT_NAME_INFO packet](#) 514
[SMB_QUERY_FILE_BASIC_INFO packet](#) 511
[SMB_QUERY_FILE_COMPRESSION_INFO packet](#) 515
[SMB_QUERY_FILE_EA_INFO packet](#) 512
[SMB_QUERY_FILE_NAME_INFO packet](#) 512
[SMB_QUERY_FILE_STANDARD_INFO packet](#) 512
[SMB_QUERY_FILE_STREAM_INFO packet](#) 514
[SMB_QUERY_FS_ATTRIBUTE_INFO packet](#) 508
[SMB_QUERY_FS_DEVICE_INFO packet](#) 506
[SMB_QUERY_FS_SIZE_INFO packet](#) 505
[SMB_QUERY_FS_VOLUME_INFO packet](#) 505
[SMB_SEARCH_ATTRIBUTE_ARCHIVE](#) 47
[SMB_SEARCH_ATTRIBUTE_DIRECTORY](#) 47
[SMB_SEARCH_ATTRIBUTE_HIDDEN](#) 47
[SMB_SEARCH_ATTRIBUTE_READONLY](#) 47
[SMB_SEARCH_ATTRIBUTE_SYSTEM](#) 47
[SMB_SET_FILE_ALLOCATION_INFO packet](#) 518
[SMB_SET_FILE_BASIC_INFO packet](#) 517
[SMB_SET_FILE_DISPOSITION_INFO packet](#) 518
[SMB_SET_FILE_END_OF_FILE_INFO packet](#) 519
[Standards assignments](#) 32
 Structures - SMB message
[batched messages \("AndX" messages\)](#) 87
[data block](#) 87

[overview](#) 80
[parameter block](#) 86
[SMB Header](#) 80
[Subcommand codes - transaction](#) 61
Subcommands
 NT Transact
 [NT TRANSACT_CREATE \(0x0001\)](#) 469
 [NT TRANSACT_IOCTL \(0x0002\)](#) 483
 [NT TRANSACT_NOTIFY_CHANGE \(0x0004\)](#) 489
 [NT TRANSACT_QUERY_SECURITY_DESC \(0x0006\)](#) 492
 [NT TRANSACT_RENAME \(0x0005\)](#) 492
 [NT TRANSACT_SET_SECURITY_DESC \(0x0003\)](#) 486
 Transaction
 [overview](#) 401
 [TRANS_CALL_NMPIPE \(0x0054\)](#) 430
 [TRANS_MAILSLLOT_WRITE \(0x0001\)](#) 434
 [TRANS_PEEK_NMPIPE \(0x0023\)](#) 413
 [TRANS_QUERY_NMPIPE_INFO \(0x0022\)](#) 409
 [TRANS_QUERY_NMPIPE_STATE \(0x0021\)](#) 407
 [TRANS_RAW_READ_NMPIPE \(0x0011\)](#) 404
 [TRANS_RAW_WRITE_NMPIPE \(0x0031\)](#) 420
 [TRANS_READ_NMPIPE \(0x0036\)](#) 423
 [TRANS_SET_NMPIPE_STATE \(0x0001\)](#) 401
 [TRANS_TRANSACT_NMPIPE \(0x0026\)](#) 417
 [TRANS_WAIT_NMPIPE \(0x0053\)](#) 428
 [TRANS_WRITE_NMPIPE \(0x0037\)](#) 426
 Transaction2
 [TRANS2_CREATE_DIRECTORY \(0x000D\)](#) 464
 [TRANS2_FIND_FIRST2 \(0x0001\)](#) 441
 [TRANS2_FIND_NEXT2 \(0x0002\)](#) 445
 [TRANS2_FIND_NOTIFY_FIRST \(0x000B\)](#) 464
 [TRANS2_FIND_NOTIFY_NEXT \(0x000C\)](#) 464
 [TRANS2_FSCTL \(0x0009\)](#) 464
 [TRANS2_GET_DFS_REFERRAL \(0x0010\)](#) 468
 [TRANS2_IOCTL2 \(0x000A\)](#) 464
 [TRANS2_OPEN2 \(0x0000\)](#) 434
 [TRANS2_QUERY_FILE_INFORMATION \(0x0007\)](#) 457
 [TRANS2_QUERY_FS_INFORMATION \(0x0003\)](#) 450
 [TRANS2_QUERY_PATH_INFORMATION \(0x0005\)](#) 452
 [TRANS2_REPORT_DFS_INCONSISTENCY \(0x0011\)](#) 469
 [TRANS2_SESSION_SETUP \(0x000E\)](#) 467
 [TRANS2_SET_FILE_INFORMATION \(0x0008\)](#) 461
 [TRANS2_SET_FS_INFORMATION \(0x0004\)](#) 451
 [TRANS2_SET_PATH_INFORMATION \(0x0006\)](#) 455

[Syntax](#) 38

T

[Time data type](#) 49

Timer events

 client

[overview](#) 523

[request expiration](#) 597

 RPC ([section 3.1.6](#) 523, [section 3.4.6](#) 688)

server

[idle connection](#) 679

[OpLock break acknowledgment](#) 679

[overview](#) 523

 RPC ([section 3.1.6](#) 523, [section 3.5.6](#) 689)

[unused open search](#) 679

Timers

 client

[idle connection](#) 606

[OpLock break acknowledgment](#) 606

[overview](#) 520

[request expiration](#) 528

 RPC ([section 3.1.2](#) 520, [section 3.4.2](#) 681)

[unused open search](#) 607

 server

[overview](#) 520

 RPC ([section 3.1.2](#) 520, [section 3.5.2](#) 688)

Tracking changes 766

[TRANS2_FIND_FIRST2_REQUEST packet](#) 441

[TRANS2_FIND_NEXT2_REQUEST packet](#) 445

[TRANS2_OPEN2_REQUEST packet](#) 434

[TRANS2_OPEN2_RESPONSE packet](#) 437

Transaction subcommands

[overview](#) 401

[TRANS_CALL_NMPIPE \(0x0054\)](#) 430

[TRANS_MAILSLLOT_WRITE \(0x0001\)](#) 434

[TRANS_PEEK_NMPIPE \(0x0023\)](#) 413

[TRANS_QUERY_NMPIPE_INFO \(0x0022\)](#) 409

[TRANS_QUERY_NMPIPE_STATE \(0x0021\)](#) 407

[TRANS_RAW_READ_NMPIPE \(0x0011\)](#) 404

[TRANS_RAW_WRITE_NMPIPE \(0x0031\)](#) 420

[TRANS_READ_NMPIPE \(0x0036\)](#) 423

[TRANS_SET_NMPIPE_STATE \(0x0001\)](#) 401

[TRANS_TRANSACT_NMPIPE \(0x0026\)](#) 417

[TRANS_WAIT_NMPIPE \(0x0053\)](#) 428

[TRANS_WRITE_NMPIPE \(0x0037\)](#) 426

Transaction2 subcommands

[TRANS2_CREATE_DIRECTORY \(0x000D\)](#) 464

[TRANS2_FIND_FIRST2 \(0x0001\)](#) 441

[TRANS2_FIND_NEXT2 \(0x0002\)](#) 445

[TRANS2_FIND_NOTIFY_FIRST \(0x000B\)](#) 464

[TRANS2_FIND_NOTIFY_NEXT \(0x000C\)](#) 464

[TRANS2_FSCTL \(0x0009\)](#) 464

[TRANS2_GET_DFS_REFERRAL \(0x0010\)](#) 468

[TRANS2_IOCTL2 \(0x000A\)](#) 464

[TRANS2_OPEN2 \(0x0000\)](#) 434

[TRANS2_QUERY_FILE_INFORMATION \(0x0007\)](#) 457

[TRANS2_QUERY_FS_INFORMATION \(0x0003\)](#) 450

[TRANS2_QUERY_PATH_INFORMATION \(0x0005\)](#) 452

[TRANS2_REPORT_DFS_INCONSISTENCY \(0x0011\)](#) 469

[TRANS2_SESSION_SETUP \(0x000E\)](#) 467

[TRANS2_SET_FILE_INFORMATION \(0x0008\)](#) 461

[TRANS2_SET_FS_INFORMATION \(0x0004\)](#) 451

[TRANS2_SET_PATH_INFORMATION \(0x0006\)](#) 455

Transport

 NetBIOS

[frames](#) 33

- over
 - [IPX/SPX](#) 34
 - [TCP/UDP](#) 34
- [overview](#) 33
- Transports
 - [direct hosting](#) 34
 - [direct IPX](#) 34
 - NetBIOS-based transports
 - [other](#) 34
 - [overview](#) 33
 - [virtual circuits](#) 38
- Triggered events
 - client
 - [cryptographic session key - querying](#) 577
 - device
 - [reading](#) 556
 - [writing](#) 560
 - DFS
 - [querying referrals](#) 577
 - [subsystem active](#) 577
 - directory
 - [contents change notification](#) 576
 - [creating](#) 543
 - [deleting](#) 543
 - [enumeration](#) 571
 - [verifying path](#) 568
 - file
 - attributes
 - [querying](#) 552
 - [setting](#) 554
 - [byte-range lock](#) 566
 - [byte-range lock - release](#) 567
 - [closing](#) 550
 - [create or overwrite](#) 547
 - [creating a hard link](#) 552
 - [deleting](#) 550
 - [flushing data](#) 550
 - [opening an existing](#) 544
 - [opportunistic lock](#) 568
 - [print](#) 573
 - [reading](#) 556
 - [renaming](#) 551
 - [seek to a location](#) 569
 - [sending IOCTL](#) 569
 - [system attributes - querying](#) 570
 - [writing](#) 560
 - named pipe
 - [exchange \(call\)](#) 575
 - [executing a transaction](#) 574
 - [peeking at data](#) 574
 - querying
 - [handle state](#) 573
 - [information](#) 574
 - reading ([section 3.2.4.14](#) 556, [section 3.2.4.37](#) 575)
 - [setting state](#) 573
 - [waiting for availability](#) 574
 - writing ([section 3.2.4.15](#) 560, [section 3.2.4.38](#) 575)
 - [named RAP transaction](#) 577
 - [number of opens on tree connect](#) 578

- [operations - canceling pending](#) 572
- [process exit notification](#) 569
- RPC
 - [DFS referrals - querying](#) 686
 - [extended DFS referral capability - querying](#) 687
 - named pipe
 - [closing](#) 684
 - [opening](#) 681
 - [reading](#) 683
 - [transaction - issuing](#) 684
 - [writing](#) 683
 - [sending any message](#) 520
 - session
 - [initiating](#) 685
 - [key - authenticated context](#) 685
 - [terminating](#) 685
 - [share connection - requesting](#) 686
 - [tree disconnect - requesting](#) 687
 - security descriptors
 - [querying](#) 576
 - [setting](#) 576
 - sending any message ([section 3.1.4.1](#) 520, [section 3.2.4.1](#) 530)
 - [share - connecting](#) 537
 - [SMB session logoff](#) 570
 - [transport layer connection - testing](#) 570
 - [tree disconnect \(unmount share\)](#) 570
- server
 - client session
 - [security context](#) 610
 - [session key](#) 610
 - [configuration - updating](#) 616
 - DFS subsystem
 - [active](#) 610
 - [DFS share](#) 610
 - [not a DFS share](#) 610
 - [disabling](#) 615
 - [enabling](#) 615
 - open
 - [closing](#) 613
 - [querying](#) 614
 - [OpLock break](#) 609
 - [pausing](#) 615
 - [resuming](#) 616
 - RPC
 - named pipe
 - [closing its open](#) 689
 - [waiting for clients to open](#) 688
 - [security context](#) 689
 - [sending any message](#) 520
 - [session key](#) 689
 - sending any message ([section 3.1.4.1](#) 520, [section 3.3.4.1](#) 608)
 - session
 - [closing](#) 611
 - [querying](#) 613
 - share
 - [deregistering](#) 612
 - [querying](#) 612
 - [registering](#) 611

[updating](#) 612
[statistics](#) 616
[transport binding change](#) 615
[TreeConnect - querying](#) 614

U

[Unique identifiers data type](#) 51

V

[Vendor-extensible fields](#) 32

[Versioning](#) 30

[Virtual circuits](#) 38

Y

[YEAR](#) 49