

[MC-DTCXA]:

MSDTC Connection Manager: OleTx XA Protocol

Intellectual Property Rights Notice for Open Specifications Documentation

- **Technical Documentation.** Microsoft publishes Open Specifications documentation (“this documentation”) for protocols, file formats, data portability, computer languages, and standards support. Additionally, overview documents cover inter-protocol relationships and interactions.
- **Copyrights.** This documentation is covered by Microsoft copyrights. Regardless of any other terms that are contained in the terms of use for the Microsoft website that hosts this documentation, you can make copies of it in order to develop implementations of the technologies that are described in this documentation and can distribute portions of it in your implementations that use these technologies or in your documentation as necessary to properly document the implementation. You can also distribute in your implementation, with or without modification, any schemas, IDLs, or code samples that are included in the documentation. This permission also applies to any documents that are referenced in the Open Specifications documentation.
- **No Trade Secrets.** Microsoft does not claim any trade secret rights in this documentation.
- **Patents.** Microsoft has patents that might cover your implementations of the technologies described in the Open Specifications documentation. Neither this notice nor Microsoft's delivery of this documentation grants any licenses under those patents or any other Microsoft patents. However, a given Open Specifications document might be covered by the Microsoft [Open Specifications Promise](#) or the [Microsoft Community Promise](#). If you would prefer a written license, or if the technologies described in this documentation are not covered by the Open Specifications Promise or Community Promise, as applicable, patent licenses are available by contacting iplg@microsoft.com.
- **License Programs.** To see all of the protocols in scope under a specific license program and the associated patents, visit the [Patent Map](#).
- **Trademarks.** The names of companies and products contained in this documentation might be covered by trademarks or similar intellectual property rights. This notice does not grant any licenses under those rights. For a list of Microsoft trademarks, visit www.microsoft.com/trademarks.
- **Fictitious Names.** The example companies, organizations, products, domain names, email addresses, logos, people, places, and events that are depicted in this documentation are fictitious. No association with any real company, organization, product, domain name, email address, logo, person, place, or event is intended or should be inferred.

Reservation of Rights. All other rights are reserved, and this notice does not grant any rights other than as specifically described above, whether by implication, estoppel, or otherwise.

Tools. The Open Specifications documentation does not require the use of Microsoft programming tools or programming environments in order for you to develop an implementation. If you have access to Microsoft programming tools and environments, you are free to take advantage of them. Certain Open Specifications documents are intended for use in conjunction with publicly available standards specifications and network programming art and, as such, assume that the reader either is familiar with the aforementioned material or has immediate access to it.

Support. For questions and support, please contact dochelp@microsoft.com.

Revision Summary

Date	Revision History	Revision Class	Comments
8/10/2007	0.1	Major	Initial Availability
9/28/2007	0.2	Minor	Clarified the meaning of the technical content.
10/23/2007	0.2.1	Editorial	Changed language and formatting in the technical content.
11/30/2007	0.2.2	Editorial	Changed language and formatting in the technical content.
1/25/2008	0.2.3	Editorial	Changed language and formatting in the technical content.
3/14/2008	0.2.4	Editorial	Changed language and formatting in the technical content.
5/16/2008	0.2.5	Editorial	Changed language and formatting in the technical content.
6/20/2008	1.0	Major	Updated and revised the technical content.
7/25/2008	1.1	Minor	Clarified the meaning of the technical content.
8/29/2008	2.0	Major	Updated and revised the technical content.
10/24/2008	2.1	Minor	Clarified the meaning of the technical content.
12/5/2008	2.1.1	Editorial	Changed language and formatting in the technical content.
1/16/2009	2.2	Minor	Clarified the meaning of the technical content.
2/27/2009	2.3	Minor	Clarified the meaning of the technical content.
4/10/2009	3.0	Major	Updated and revised the technical content.
5/22/2009	4.0	Major	Updated and revised the technical content.
7/2/2009	5.0	Major	Updated and revised the technical content.
8/14/2009	6.0	Major	Updated and revised the technical content.
9/25/2009	7.0	Major	Updated and revised the technical content.
11/6/2009	8.0	Major	Updated and revised the technical content.
12/18/2009	9.0	Major	Updated and revised the technical content.
1/29/2010	9.1	Minor	Clarified the meaning of the technical content.
3/12/2010	9.1.1	Editorial	Changed language and formatting in the technical content.
4/23/2010	9.2	Minor	Clarified the meaning of the technical content.
6/4/2010	10.0	Major	Updated and revised the technical content.
7/16/2010	11.0	Major	Updated and revised the technical content.
8/27/2010	12.0	Major	Updated and revised the technical content.
10/8/2010	13.0	Major	Updated and revised the technical content.
11/19/2010	14.0	Major	Updated and revised the technical content.
1/7/2011	14.1	Minor	Clarified the meaning of the technical content.

Date	Revision History	Revision Class	Comments
2/11/2011	15.0	Major	Updated and revised the technical content.
3/25/2011	16.0	Major	Updated and revised the technical content.
5/6/2011	16.0	None	No changes to the meaning, language, or formatting of the technical content.
6/17/2011	16.1	Minor	Clarified the meaning of the technical content.
9/23/2011	16.1	None	No changes to the meaning, language, or formatting of the technical content.
12/16/2011	17.0	Major	Updated and revised the technical content.
3/30/2012	17.0	None	No changes to the meaning, language, or formatting of the technical content.
7/12/2012	17.0	None	No changes to the meaning, language, or formatting of the technical content.
10/25/2012	17.0	None	No changes to the meaning, language, or formatting of the technical content.
1/31/2013	17.0	None	No changes to the meaning, language, or formatting of the technical content.
8/8/2013	17.1	Minor	Clarified the meaning of the technical content.
11/14/2013	17.1	None	No changes to the meaning, language, or formatting of the technical content.
2/13/2014	17.1	None	No changes to the meaning, language, or formatting of the technical content.
5/15/2014	17.1	None	No changes to the meaning, language, or formatting of the technical content.
6/30/2015	18.0	Major	Significantly changed the technical content.
10/16/2015	18.0	None	No changes to the meaning, language, or formatting of the technical content.
7/14/2016	19.0	Major	Significantly changed the technical content.
6/1/2017	20.0	Major	Significantly changed the technical content.
9/15/2017	21.0	Major	Significantly changed the technical content.

Table of Contents

1	Introduction	12
1.1	Glossary	12
1.2	References	15
1.2.1	Normative References	15
1.2.2	Informative References	16
1.3	Overview	16
1.3.1	Scenarios	17
1.3.1.1	OleTx Resource Managers Enlisting with XA Transaction Managers	17
1.3.1.1.1	Transaction Enlistment and Completion	18
1.3.1.1.2	Transaction Recovery	20
1.3.1.2	XA Resource Managers Enlisting with Transaction Managers	22
1.3.1.2.1	Transaction Recovery	24
1.3.1.2.2	Two-Pipe Model	25
1.3.1.2.2.1	XA Resource Manager Registration and Unregistration	26
1.3.1.2.2.2	Transaction Enlistment and Completion	27
1.3.1.2.3	One-Pipe Model	29
1.3.1.2.3.1	XA Resource Manager Registration and Unregistration	29
1.3.1.2.3.2	Transaction Enlistment and Completion	31
1.3.2	Roles	33
1.3.2.1	XA Resource Manager Bridge Role	33
1.3.2.2	XA Superior Transaction Manager Role	33
1.3.2.3	Transaction Manager Role	33
1.3.2.3.1	XA Resource Manager Bridge Facet	34
1.3.2.3.2	XA Subordinate Transaction Manager Facet	34
1.4	Relationship to Other Protocols	34
1.5	Prerequisites/Preconditions	34
1.6	Applicability Statement	35
1.7	Versioning and Capability Negotiation	35
1.8	Vendor-Extensible Fields	35
1.9	Standards Assignments	35
2	Messages	36
2.1	Transport	36
2.2	Message Syntax	36
2.2.1	Common Structures	36
2.2.1.1	MESSAGE_PACKET	36
2.2.1.2	XA_BQUAL_1	37
2.2.1.3	XA_XID	37
2.2.1.4	XA_UOW	39
2.2.2	Enumeration	39
2.2.2.1	Connection Types	39
2.2.3	Connection Types Relevant to XA Resource Manager Bridges and XA Resource Manager Bridge Facets	39
2.2.3.1	Versioning	39
2.2.3.2	CONNTYPE_XATM_OPEN	40
2.2.3.2.1	XATMUSER_MTAG_E_RMNONEXISTENT	40
2.2.3.2.2	XATMUSER_MTAG_E_RMNOTAVAILABLE	40
2.2.3.2.3	XATMUSER_MTAG_E_RMOPENFAILED	41
2.2.3.2.4	XATMUSER_MTAG_E_RMPROTOCOL	41
2.2.3.2.5	XATMUSER_MTAG_RMOPEN	41
2.2.3.2.6	XATMUSER_MTAG_RMOPENOK	42
2.2.3.3	CONNTYPE_XATM_OPENONEPIPE	43
2.2.3.3.1	XATMUSER_MTAG_E_CONFIGLOGWRITEFAILED	43
2.2.3.3.2	XATMUSER_MTAG_E_RMCLOSEFAILED	43
2.2.3.3.3	XATMUSER_MTAG_E_RMCLOSERMNOTAVAILABLE	44

2.2.3.3.4	XATMUSER_MTAG_E_RMCLOSETMERROR.....	44
2.2.3.3.5	XATMUSER_MTAG_E_RMCLOSETMNOTAVAILABLE.....	45
2.2.3.3.6	XATMUSER_MTAG_E_RMCLOSEUNEXPECTED.....	45
2.2.3.3.7	XATMUSER_MTAG_RMCLOSE.....	45
2.2.3.3.8	XATMUSER_MTAG_RMCLOSEOK.....	46
2.2.3.4	CONNTYPE_XATM_ENLIST.....	46
2.2.3.4.1	XATMUSER_MTAG_E_ENLISTMENTDUPLICATE.....	46
2.2.3.4.2	XATMUSER_MTAG_E_ENLISTMENTFAILED.....	47
2.2.3.4.3	XATMUSER_MTAG_E_ENLISTMENTIMPFAILED.....	47
2.2.3.4.4	XATMUSER_MTAG_E_ENLISTMENTNOMEMORY.....	48
2.2.3.4.5	XATMUSER_MTAG_E_ENLISTMENTRMNOTFOUND.....	48
2.2.3.4.6	XATMUSER_MTAG_E_ENLISTMENTRMRECOVERING.....	48
2.2.3.4.7	XATMUSER_MTAG_E_ENLISTMENTRMUNAVAILABLE.....	49
2.2.3.4.8	XATMUSER_MTAG_E_ENLISTMENTTOOLATE.....	49
2.2.3.4.9	XATMUSER_MTAG_ENLIST.....	49
2.2.3.4.10	XATMUSER_MTAG_ENLISTMENTOK.....	50
2.2.4	Connection Types Relevant to XA Superior Transaction Managers and XA Subordinate Transaction Manager Facets.....	51
2.2.4.1	Versioning.....	51
2.2.4.2	CONNTYPE_XAUSER_CONTROL.....	51
2.2.4.2.1	XAUSER_CONTROL_MTAG_CREATE.....	51
2.2.4.2.2	XAUSER_CONTROL_MTAG_CREATE_NO_MEM.....	52
2.2.4.2.3	XAUSER_CONTROL_MTAG_CREATED.....	52
2.2.4.2.4	XAUSER_CONTROL_MTAG_RECOVER.....	53
2.2.4.2.5	XAUSER_CONTROL_MTAG_RECOVER_NO_MEM.....	53
2.2.4.2.6	XAUSER_CONTROL_MTAG_RECOVER_REPLY.....	54
2.2.4.3	CONNTYPE_XAUSER_XACT_START.....	55
2.2.4.3.1	XAUSER_XACT_MTAG_START.....	55
2.2.4.3.2	XAUSER_XACT_MTAG_START_DUPLICATE.....	56
2.2.4.3.3	XAUSER_XACT_MTAG_START_LOG_FULL.....	56
2.2.4.3.4	XAUSER_XACT_MTAG_START_NO_MEM.....	57
2.2.4.3.5	XAUSER_XACT_MTAG_STARTED.....	57
2.2.4.4	CONNTYPE_XAUSER_XACT_BRANCH_START.....	58
2.2.4.5	CONNTYPE_XAUSER_XACT_OPEN.....	58
2.2.4.5.1	XAUSER_XACT_MTAG_ABORT.....	58
2.2.4.5.2	XAUSER_XACT_MTAG_COMMIT.....	58
2.2.4.5.3	XAUSER_XACT_MTAG_OPEN.....	59
2.2.4.5.4	XAUSER_XACT_MTAG_OPEN_NOT_FOUND.....	59
2.2.4.5.5	XAUSER_XACT_MTAG_OPENED.....	60
2.2.4.5.6	XAUSER_XACT_MTAG_PREPARE.....	60
2.2.4.5.7	XAUSER_XACT_MTAG_PREPARE_ABORT.....	61
2.2.4.5.8	XAUSER_XACT_MTAG_PREPARE_SINGLEPHASE_INDOUBT.....	61
2.2.4.5.9	XAUSER_XACT_MTAG_REQUEST_COMPLETED.....	62
2.2.4.5.10	XAUSER_XACT_MTAG_REQUEST_FAILED_BAD_PROTOCOL.....	62
2.2.4.6	CONNTYPE_XAUSER_XACT_BRANCH_OPEN.....	62
2.2.4.6.1	XAUSER_XACT_MTAG_READONLY.....	62
2.2.4.7	CONNTYPE_XAUSER_XACT_MIGRATE.....	63
2.2.4.7.1	XAUSER_XACT_MTAG_RESUME.....	63
2.2.4.7.2	XAUSER_XACT_MTAG_RESUME_DONE.....	64
2.2.4.7.3	XAUSER_XACT_MTAG_SUSPEND_WITH_MIGRATE.....	64
2.2.4.7.4	XAUSER_XACT_MTAG_SUSPEND_WITH_MIGRATE_DONE.....	65
2.2.4.7.5	XAUSER_XACT_MTAG_TRANSACTION_NOT_SUSPENDED.....	66
2.2.4.8	CONNTYPE_XAUSER_XACT_MIGRATE2.....	66
2.2.4.8.1	XAUSER_XACT_MTAG_RESUME_DONE.....	66
3	Protocol Details.....	68
3.1	Common Details.....	68
3.1.1	Abstract Data Model.....	68

3.1.2	Timers	68
3.1.3	Initialization	69
3.1.4	Protocol Versioning Details.....	69
3.1.5	Higher-Layer Triggered Events	69
3.1.6	Processing Events and Sequencing Rules	69
3.1.7	Timer Events.....	69
3.1.8	Other Local Events.....	69
3.1.8.1	Disconnect Connection.....	69
3.1.8.2	Connection Disconnected	69
3.2	XA Subordinate Transaction Manager Facet Details.....	69
3.2.1	Abstract Data Model.....	69
3.2.1.1	Versioning.....	72
3.2.1.2	CONNTYPE_XAUSER_CONTROL Acceptor States.....	72
3.2.1.2.1	Idle	72
3.2.1.2.2	Processing Create Request.....	73
3.2.1.2.3	Active	73
3.2.1.2.4	Ended	73
3.2.1.2.5	State Diagram	73
3.2.1.3	CONNTYPE_XAUSER_XACT_START Acceptor States	74
3.2.1.3.1	Idle	74
3.2.1.3.2	Processing Start Request.....	75
3.2.1.3.3	Active	75
3.2.1.3.4	Ended	75
3.2.1.3.5	State Diagram	75
3.2.1.4	CONNTYPE_XAUSER_XACT_OPEN Acceptor States	76
3.2.1.4.1	Idle	76
3.2.1.4.2	Processing Open Request	77
3.2.1.4.3	Active	77
3.2.1.4.4	Ended	77
3.2.1.4.5	State Diagram	77
3.2.1.5	CONNTYPE_XAUSER_XACT_MIGRATE Acceptor States	78
3.2.1.5.1	Idle	78
3.2.1.5.2	Processing Migrate Request	79
3.2.1.5.3	Ended	79
3.2.1.5.4	State Diagram	79
3.2.1.6	CONNTYPE_XAUSER_XACT_BRANCH_START Acceptor States	79
3.2.1.6.1	Idle	80
3.2.1.6.2	Processing Start Request.....	80
3.2.1.6.3	Active	80
3.2.1.6.4	Ended	80
3.2.1.6.5	State Diagram	80
3.2.1.7	CONNTYPE_XAUSER_XACT_BRANCH_OPEN Acceptor States.....	81
3.2.1.7.1	Idle	82
3.2.1.7.2	Processing Open Request	82
3.2.1.7.3	Active	82
3.2.1.7.4	Ended	82
3.2.1.7.5	State Diagram	82
3.2.1.8	CONNTYPE_XAUSER_XACT_MIGRATE2 Acceptor States	83
3.2.1.8.1	Idle	83
3.2.1.8.2	Processing Migrate2 Request.....	84
3.2.1.8.3	Ended	84
3.2.1.8.4	State Diagram	84
3.2.1.9	XA Superior Enlistment State Diagram.....	84
3.2.2	Timers	85
3.2.3	Initialization	85
3.2.4	Higher-Layer Triggered Events	86
3.2.5	Processing Events and Sequencing Rules	86
3.2.5.1	CONNTYPE_XAUSER_CONTROL as Acceptor	86

3.2.5.1.1	Receiving an XAUSER_CONTROL_MTAG_CREATE Message.....	86
3.2.5.1.2	Receiving an XAUSER_CONTROL_MTAG_RECOVER Message	87
3.2.5.1.3	Connection Disconnected.....	89
3.2.5.2	CONNTYPE_XAUSER_XACT_START as Acceptor.....	89
3.2.5.2.1	Receiving an XAUSER_XACT_MTAG_START Message.....	89
3.2.5.2.2	Connection Disconnected.....	91
3.2.5.3	CONNTYPE_XAUSER_XACT_OPEN as Acceptor	92
3.2.5.3.1	Receiving an XAUSER_XACT_MTAG_OPEN Message	92
3.2.5.3.2	Receiving an XAUSER_XACT_MTAG_PREPARE Message	92
3.2.5.3.3	Receiving an XAUSER_XACT_MTAG_COMMIT Message	93
3.2.5.3.4	Receiving an XAUSER_XACT_MTAG_ABORT Message	94
3.2.5.3.5	Connection Disconnected.....	94
3.2.5.4	CONNTYPE_XAUSER_XACT_MIGRATE as Acceptor.....	95
3.2.5.4.1	Receiving an XAUSER_XACT_MTAG_SUSPEND_WITH_MIGRATE Message	95
3.2.5.4.2	Receiving an XAUSER_XACT_MTAG_RESUME Message	96
3.2.5.5	CONNTYPE_XAUSER_XACT_BRANCH_START as Acceptor	97
3.2.5.5.1	Receiving an XAUSER_XACT_MTAG_START Message.....	97
3.2.5.5.2	Connection Disconnected.....	100
3.2.5.6	CONNTYPE_XAUSER_XACT_BRANCH_OPEN as Acceptor	101
3.2.5.6.1	Receiving an XAUSER_XACT_MTAG_OPEN Message	101
3.2.5.6.2	Receiving an XAUSER_XACT_MTAG_PREPARE Message	102
3.2.5.6.3	Receiving an XAUSER_XACT_MTAG_COMMIT Message	103
3.2.5.6.4	Receiving an XAUSER_XACT_MTAG_ABORT Message	104
3.2.5.6.5	Connection Disconnected.....	105
3.2.5.7	CONNTYPE_XAUSER_XACT_MIGRATE2 as Acceptor	106
3.2.5.7.1	Receiving an XAUSER_XACT_MTAG_SUSPEND_WITH_MIGRATE Message	106
3.2.5.7.2	Receiving an XAUSER_XACT_MTAG_RESUME Message	107
3.2.6	Timer Events.....	108
3.2.7	Other Local Events.....	108
3.2.7.1	Commit Complete	108
3.2.7.2	Create Superior Enlistment Success	109
3.2.7.3	Create Superior Enlistment Failure	110
3.2.7.4	Phase Zero Complete	110
3.2.7.5	Phase One Complete	111
3.2.7.6	Recover In Doubt Transaction.....	112
3.2.7.7	Rollback Complete	112
3.2.7.8	Unilaterally Aborted.....	112
3.3	XA Superior Transaction Manager Details	113
3.3.1	Abstract Data Model.....	113
3.3.1.1	Versioning.....	115
3.3.1.2	TM_NOTHREADAFFINITY Flag	115
3.3.1.3	CONNTYPE_XAUSER_CONTROL Initiator States.....	115
3.3.1.3.1	Idle	115
3.3.1.3.2	Awaiting Creation Response.....	116
3.3.1.3.3	Active	116
3.3.1.3.4	Awaiting Recovery Response.....	116
3.3.1.3.5	Ended	116
3.3.1.3.6	State Diagram	116
3.3.1.4	CONNTYPE_XAUSER_XACT_START Initiator States.....	117
3.3.1.4.1	Idle	117
3.3.1.4.2	Awaiting Start Response.....	117
3.3.1.4.3	Active	118
3.3.1.4.4	Ended	118
3.3.1.4.5	State Diagram	118
3.3.1.5	CONNTYPE_XAUSER_XACT_OPEN Initiator States	119
3.3.1.5.1	Idle	120
3.3.1.5.2	Awaiting Open Response	120
3.3.1.5.3	Processing Opened Response	120

3.3.1.5.4	Awaiting Prepare Response.....	120
3.3.1.5.5	Awaiting Abort Response.....	120
3.3.1.5.6	Awaiting Commit Response.....	120
3.3.1.5.7	Ended	121
3.3.1.5.8	State Diagram	121
3.3.1.6	CONNTYPE_XAUSER_XACT_MIGRATE Initiator States	122
3.3.1.6.1	Idle	122
3.3.1.6.2	Awaiting Suspension Response.....	122
3.3.1.6.3	Awaiting Resumption Response	122
3.3.1.6.4	Ended	122
3.3.1.6.5	State Diagram	122
3.3.1.7	CONNTYPE_XAUSER_XACT_BRANCH_START Initiator States	123
3.3.1.7.1	Idle	123
3.3.1.7.2	Awaiting Start Response.....	123
3.3.1.7.3	Active	124
3.3.1.7.4	Ended	124
3.3.1.7.5	State Diagram	124
3.3.1.8	CONNTYPE_XAUSER_XACT_BRANCH_OPEN Initiator States.....	125
3.3.1.8.1	Idle	126
3.3.1.8.2	Awaiting Open Response	126
3.3.1.8.3	Processing Opened Response	126
3.3.1.8.4	Awaiting Prepare Response.....	126
3.3.1.8.5	Awaiting Abort Response.....	126
3.3.1.8.6	Awaiting Commit Response.....	127
3.3.1.8.7	Ended	127
3.3.1.8.8	State Diagram	127
3.3.1.9	CONNTYPE_XAUSER_XACT_MIGRATE2 Initiator States	128
3.3.1.9.1	Idle	128
3.3.1.9.2	Awaiting Suspension Response.....	129
3.3.1.9.3	Awaiting Resumption Response	129
3.3.1.9.4	Ended	129
3.3.1.9.5	State Diagram	129
3.3.2	Timers	130
3.3.3	Initialization.....	130
3.3.4	Higher-Layer Triggered Events	131
3.3.4.1	Xa Lookup	131
3.3.4.2	Xa_close.....	131
3.3.4.3	Xa_commit.....	132
3.3.4.4	Xa_complete	135
3.3.4.5	Xa_end.....	135
3.3.4.6	Xa_forget.....	137
3.3.4.7	Xa_open	137
3.3.4.8	Xa_prepare	139
3.3.4.9	Xa_recover.....	141
3.3.4.10	Xa_rollback	143
3.3.4.11	Xa_start	145
3.3.5	Processing Events and Sequencing Rules	151
3.3.5.1	CONNTYPE_XAUSER_CONTROL Initiator	151
3.3.5.1.1	Receiving an XAUSER_CONTROL_MTAG_CREATE_NO_MEM Message	151
3.3.5.1.2	Receiving an XAUSER_CONTROL_MTAG_CREATED Message.....	151
3.3.5.1.3	Receiving an XAUSER_CONTROL_MTAG_RECOVER_NO_MEM Message ..	151
3.3.5.1.4	Receiving an XAUSER_CONTROL_MTAG_RECOVER_REPLY Message	152
3.3.5.1.5	Connection Disconnected.....	153
3.3.5.2	CONNTYPE_XAUSER_XACT_START Initiator.....	153
3.3.5.2.1	Receiving an XAUSER_XACT_MTAG_STARTED Message.....	153
3.3.5.2.2	Receiving an XAUSER_XACT_MTAG_START_NO_MEM Message	154
3.3.5.2.3	Receiving an XAUSER_XACT_MTAG_START_LOG_FULL Message	154
3.3.5.2.4	Receiving an XAUSER_XACT_MTAG_START_DUPLICATE Message	154

3.3.5.2.5	Connection Disconnected.....	155
3.3.5.3	CONNTYPE_XAUSER_XACT_OPEN Initiator	155
3.3.5.3.1	Receiving an XAUSER_XACT_MTAG_OPENED Message	155
3.3.5.3.2	Receiving an XAUSER_XACT_MTAG_OPEN_NOT_FOUND Message.....	156
3.3.5.3.3	Receiving an XAUSER_XACT_MTAG_REQUEST_COMPLETED Message....	156
3.3.5.3.4	Receiving an XAUSER_XACT_MTAG_PREPARE_ABORT Message.....	157
3.3.5.3.5	Receiving an XAUSER_XACT_MTAG_PREPARE_SINGLEPHASE_INDOUBT Message.....	157
3.3.5.3.6	Receiving an XAUSER_XACT_MTAG_REQUEST_FAILED_BAD_PROTOCOL Message.....	157
3.3.5.3.7	Connection Disconnected.....	158
3.3.5.4	CONNTYPE_XAUSER_XACT_MIGRATE Initiator	159
3.3.5.4.1	Receiving an XAUSER_XACT_MTAG_SUSPEND_WITH_MIGRATE_DONE Message.....	159
3.3.5.4.2	Receiving an XAUSER_XACT_MTAG_RESUME_DONE Message	159
3.3.5.4.3	Receiving an XAUSER_XACT_MTAG_TRANSACTION_NOT_SUSPENDED Message.....	159
3.3.5.4.4	Receiving an XAUSER_XACT_MTAG_OPEN_NOT_FOUND Message.....	160
3.3.5.4.5	Receiving an XAUSER_XACT_MTAG_START_NO_MEM Message	160
3.3.5.4.6	Connection Disconnected.....	160
3.3.5.5	CONNTYPE_XAUSER_XACT_BRANCH_START Initiator	160
3.3.5.5.1	Receiving an XAUSER_XACT_MTAG_STARTED Message.....	160
3.3.5.5.2	Receiving an XAUSER_XACT_MTAG_START_NO_MEM Message	161
3.3.5.5.3	Receiving an XAUSER_XACT_MTAG_START_LOG_FULL Message	161
3.3.5.5.4	Receiving an XAUSER_XACT_MTAG_START_DUPLICATE Message	161
3.3.5.5.5	Connection Disconnected.....	162
3.3.5.6	CONNTYPE_XAUSER_XACT_BRANCH_OPEN Initiator.....	162
3.3.5.6.1	Receiving an XAUSER_XACT_MTAG_OPENED Message	162
3.3.5.6.2	Receiving an XAUSER_XACT_MTAG_OPEN_NOT_FOUND Message.....	163
3.3.5.6.3	Receiving an XAUSER_XACT_MTAG_REQUEST_COMPLETED Message....	163
3.3.5.6.4	Receiving an XAUSER_XACT_MTAG_PREPARE_ABORT Message.....	164
3.3.5.6.5	Receiving an XAUSER_XACT_MTAG_PREPARE_SINGLEPHASE_INDOUBT Message.....	164
3.3.5.6.6	Receiving an XAUSER_XACT_MTAG_REQUEST_FAILED_BAD_PROTOCOL Message.....	164
3.3.5.6.7	Receiving an XAUSER_XACT_MTAG_READONLY Message.....	165
3.3.5.6.8	Connection Disconnected.....	165
3.3.5.7	CONNTYPE_XAUSER_XACT_MIGRATE2 Initiator	166
3.3.5.7.1	Receiving an XAUSER_XACT_MTAG_SUSPEND_WITH_MIGRATE_DONE Message.....	166
3.3.5.7.2	Receiving an XAUSER_XACT_MTAG_RESUME_DONE Message	166
3.3.5.7.3	Receiving an XAUSER_XACT_MTAG_TRANSACTION_NOT_SUSPENDED Message.....	166
3.3.5.7.4	Connection Disconnected.....	167
3.3.5.7.5	Receiving an XAUSER_XACT_MTAG_START_NO_MEM Message	167
3.3.5.7.6	Receiving an MTAG_CONNECTION_REQ_DENIED Message.....	167
3.3.5.7.7	Receiving an XAUSER_XACT_MTAG_OPEN_NOT_FOUND Message.....	168
3.3.6	Timer Events.....	168
3.3.7	Other Local Events.....	168
3.4	XA Resource Manager Bridge Facet Details	168
3.4.1	Abstract Data Model.....	168
3.4.1.1	CONNTYPE_XATM_OPEN Acceptor States	170
3.4.1.1.1	Idle	171
3.4.1.1.2	Processing Open Request	171
3.4.1.1.3	Active	171
3.4.1.1.4	Ended	171
3.4.1.1.5	State Diagram	171
3.4.1.2	CONNTYPE_XATM_OPENONEPIPE Acceptor States.....	172

3.4.1.2.1	Idle	172
3.4.1.2.2	Processing Open Request	173
3.4.1.2.3	Active	173
3.4.1.2.4	Processing Close Request	173
3.4.1.2.5	Ended	173
3.4.1.2.6	State Diagram	173
3.4.1.3	CONNTYPE_XATM_ENLIST Acceptor States.....	174
3.4.1.3.1	Idle	175
3.4.1.3.2	Processing Enlist Request	175
3.4.1.3.3	Ended	175
3.4.1.3.4	State Diagram	175
3.4.2	Timers	176
3.4.2.1	Recovery Interval Timer.....	176
3.4.3	Initialization.....	176
3.4.3.1	XA Resource Manager Bridge Facet Initialization	177
3.4.4	Higher-Layer Triggered Events	177
3.4.4.1	Recovery Event.....	177
3.4.5	Processing Events and Sequencing Rules	178
3.4.5.1	CONNTYPE_XATM_OPEN as Acceptor	178
3.4.5.1.1	Receiving an XATMUSER_MTAG_RMOPEN Message	178
3.4.5.1.2	Connection Disconnected.....	181
3.4.5.2	CONNTYPE_XATM_OPENONEPIPE as Acceptor.....	182
3.4.5.2.1	Receiving an XATMUSER_MTAG_RMOPEN Message	182
3.4.5.2.2	Receiving an XATMUSER_MTAG_RMCLOSE Message	184
3.4.5.2.3	Connection Disconnected.....	185
3.4.5.3	CONNTYPE_XATM_ENLIST as Acceptor	185
3.4.5.3.1	Receiving an XATMUSER_MTAG_ENLIST Message	185
3.4.6	Timer Events.....	187
3.4.6.1	Recovery Interval Timer.....	187
3.4.7	Other Local Events.....	187
3.4.7.1	Begin Commit.....	187
3.4.7.2	Begin Phase One.....	188
3.4.7.3	Begin Rollback.....	190
3.4.7.4	Create Subordinate Enlistment Failure	191
3.4.7.5	Create Subordinate Enlistment Success	192
3.4.7.6	Recover XA Resource Manager.....	192
3.5	XA Resource Manager Bridge Details	196
3.5.1	Abstract Data Model.....	196
3.5.1.1	CONNTYPE_XATM_OPEN Initiator States	197
3.5.1.1.1	Idle	197
3.5.1.1.2	Awaiting Open Response	198
3.5.1.1.3	Active	198
3.5.1.1.4	Ended	198
3.5.1.1.5	State Diagram	198
3.5.1.2	CONNTYPE_XATM_OPENONEPIPE Initiator States.....	199
3.5.1.2.1	Idle	199
3.5.1.2.2	Awaiting Open Response	200
3.5.1.2.3	Active	200
3.5.1.2.4	Awaiting Close Response	200
3.5.1.2.5	Ended	200
3.5.1.2.6	State Diagram	200
3.5.1.3	CONNTYPE_XATM_ENLIST Initiator States.....	201
3.5.1.3.1	Idle	202
3.5.1.3.2	Awaiting Enlist Response	202
3.5.1.3.3	Ended	202
3.5.1.3.4	State Diagram	202
3.5.2	Timers	203
3.5.3	Initialization.....	204

3.5.4	Higher-Layer Triggered Events	204
3.5.4.1	Register Two-Pipe XA Resource Manager.....	204
3.5.4.2	Unregister Two-Pipe XA Resource Manager.....	205
3.5.4.3	Enlist Two-Pipe XA Resource Manager	206
3.5.4.4	Register One-Pipe XA Resource Manager.....	206
3.5.4.5	Unregister One-Pipe XA Resource Manager.....	208
3.5.4.6	Enlist One-Pipe XA Resource Manager.....	208
3.5.4.7	Create XID	209
3.5.5	Processing Events and Sequencing Rules	210
3.5.5.1	CONNTYPE_XATM_OPEN as Initiator	210
3.5.5.1.1	Receiving an XATMUSER_MTAG_RMOPENOK Message	210
3.5.5.1.2	Receiving Other XATMUSER_MTAG_RMOPEN Messages	210
3.5.5.1.3	Connection Disconnected.....	210
3.5.5.2	CONNTYPE_XATM_OPENONEPIPE as Initiator.....	211
3.5.5.2.1	Receiving an XATMUSER_MTAG_RMOPENOK Message	211
3.5.5.2.2	Receiving Other XATMUSER_MTAG_RMOPEN Messages	211
3.5.5.2.3	Receiving an XATMUSER_MTAG_RMCLOSEOK Message	212
3.5.5.2.4	Receiving Other XATMUSER_MTAG_RMCLOSE Messages	212
3.5.5.2.5	Connection Disconnected.....	212
3.5.5.3	CONNTYPE_XATM_ENLIST as Initiator	213
3.5.5.3.1	Receiving an XATMUSER_MTAG_ENLISTMENTOK or an XATMUSER_MTAG_E_ENLISTMENTDUPLICATE Message	213
3.5.5.3.2	Receiving Other XATMUSER_MTAG_RMENLIST Messages.....	213
3.5.5.3.3	Connection Disconnected.....	214
3.5.6	Timer Events.....	214
3.5.7	Other Local Events.....	214
4	Protocol Examples	215
4.1	XA Superior Scenarios	215
4.1.1	Opening an XA Superior Connection with an XA Subordinate Transaction Manager Facet Scenario	215
4.1.2	Starting an XA Superior Transaction with an XA Subordinate Transaction Manager Facet Scenario	216
4.1.3	XA Superior Two-Phase Commit Scenario	219
4.1.3.1	Preparing an XA Superior Transaction with an XA Subordinate Transaction Manager Facet.....	220
4.1.3.2	Committing an XA Superior Transaction with an XA Subordinate Transaction Manager Facet.....	223
4.1.4	XA Superior Recovery Scenario	226
4.1.4.1	Obtaining a List of XA Superior Transactions to Recover with an XA Subordinate Transaction Manager Facet.....	226
4.2	XA Resource Manager Bridge Facet Scenarios	232
4.2.1	Two-Pipe Model	232
4.2.1.1	Registering a Two-Pipe XA Resource Manager.....	232
4.2.1.2	Enlisting a Two-Pipe XA Resource Manager in an OleTx Transaction.....	233
4.2.2	One-Pipe Model	238
4.2.2.1	Registering a One-Pipe XA Resource Manager.....	238
4.2.2.2	Unregistering a One-Pipe XA Resource Manager.....	240
5	Security	241
5.1	Security Considerations for Implementers	241
5.2	Index of Security Parameters	241
6	Appendix A: Product Behavior	242
7	Change Tracking.....	247
8	Index.....	248

1 Introduction

This document specifies the extensions to the MSDTC Connection Manager: OleTx Transaction Protocol [MS-DTCO] to support XA-compliant software components, as specified in [XOPEN-DTP], in an **OleTx** distributed **transaction** processing environment. It specifies the syntax and semantics of the new protocol messages. Because this document builds upon and relies heavily on the MSDTC Connection Manager: OleTx Transaction Protocol specification [MS-DTCO], familiarity with its terms and concepts is assumed.

Sections 1.5, 1.8, 1.9, 2, and 3 of this specification are normative. All other sections and examples in this specification are informative.

1.1 Glossary

This document uses the following terms:

application: A participant that is responsible for beginning, propagating, and completing an atomic transaction. An application communicates with a transaction manager in order to begin and complete transactions. An application communicates with a transaction manager in order to marshal transactions to and from other applications. An application also communicates in application-specific ways with a resource manager in order to submit requests for work on resources.

ASCII: The American Standard Code for Information Interchange (ASCII) is an 8-bit character-encoding scheme based on the English alphabet. ASCII codes represent text in computers, communications equipment, and other devices that work with text. ASCII refers to a single 8-bit ASCII character or an array of 8-bit ASCII characters with the high bit of each character set to zero.

atomic transaction: A shared activity that provides mechanisms for achieving the atomicity, consistency, isolation, and durability (ACID) properties when state changes occur inside participating **resource managers**.

branch: See **XA Transaction Branch**.

child branch: The second or later **XA Transaction Branch** created on an XA Subordinate Transaction Manager Facet for a given **XA Global Transaction Identifier** when using **tight coupling**.

connection: In OleTx, an ordered set of logically related messages. The relationship between the messages is defined by the higher-layer protocol, but they are guaranteed to be delivered exactly one time and in order relative to other messages in the connection.

distributed transaction: A **transaction** that updates data on two or more networked computer systems. **Distributed transactions** extend the benefits of **transactions** to **applications** that must update distributed data.

enlistment: The relationship between a participant and a **transaction manager** in an **atomic transaction**. The term typically refers to the relationship between a **resource manager** and its **transaction manager**, or between a **subordinate transaction manager** facet and its **superior transaction manager** facet.

facet: In **OleTx**, a subsystem in a **transaction manager** that maintains its own per-**transaction** state and responds to intra-**transaction manager** events from other **facets**. A **facet** can also be responsible for communicating with other participants of a **transaction**.

globally unique identifier (GUID): A term used interchangeably with universally unique identifier (UUID) in Microsoft protocol technical documents (TDs). Interchanging the usage of these terms does not imply or require a specific algorithm or mechanism to generate the value.

Specifically, the use of this term does not imply or require that the algorithms described in [\[RFC4122\]](#) or [\[C706\]](#) must be used for generating the **GUID**. See also universally unique identifier (UUID).

In Doubt outcome: One of the **outcomes** of an **atomic transaction**. The **In Doubt outcome** indicates that a commit request was issued by the root application but that the **transaction manager** cannot ascertain the actual commit or abort decision.

loose coupling: A scheme for mapping **XA Transaction Branches** to **atomic transactions**. Each **loosely coupled XA Transaction Branch** is treated as operating under a different **atomic transaction** by the XA Subordinate Transaction Manager Facet.

message tag (MTAG): A message that is sent between participants in the context of connections.

OleTx: A comprehensive distributed transaction manager processing protocol that uses the protocols specified in the following document(s): [\[MS-CMPO\]](#), [\[MS-CMP\]](#), [\[MS-DTCLU\]](#), [\[MS-DTCM\]](#), [\[MS-DTCO\]](#), [\[MC-DTCXA\]](#), [\[MS-TIPP\]](#), and [\[MS-CMOM\]](#).

one pipe: A model of communication between an **XA Resource Manager Bridge**, an **XA Resource Manager Bridge Facet**, a **Transaction Manager**, and an **XA Resource Manager**. For more information, see the description in section 1.3.1.2.

one-pipe XA Resource Manager: An **XA Resource Manager** that uses the **one-pipe** model to communicate with a **Transaction Manager**.

outcome: One of the three possible results (Commit, Abort, In Doubt) reachable at the end of a life cycle for an **atomic transaction**.

parent branch: The first **XA Transaction Branch** created on an XA Subordinate Transaction Manager Facet for a given **XA Global Transaction Identifier** when using **tight coupling**.

participant: Any of the parties that are involved in an **atomic transaction** and that have a stake in the operations that are performed under the **transaction** or in the **outcome** of the **transaction** ([\[WSAT10\]](#), [\[WSAT11\]](#)).

Phase One: The initial phase of a two-phase commit sequence. During this phase, the participants in the transaction are requested to prepare to be committed. This phase is also known as the "Prepare" phase. At the end of Phase One, the outcome of the transaction is known.

Phase Two: The second phase of a two-phase commit sequence. This phase occurs after the decision to commit or abort is determined. During this phase, the participants in the transaction are ordered to either commit or rollback.

recovery: The process of reestablishing connectivity and synchronizing views on the outcome of transactions between two participants after a transient failure. Recovery occurs either between a resource manager and a transaction manager, or between a Superior Transaction Manager Facet and a Subordinate Transaction Manager Facet.

resource manager (RM): The participant that is responsible for coordinating the state of a resource with the outcome of atomic transactions. For a specified transaction, a resource manager enlists with exactly one transaction manager to vote on that transaction outcome and to obtain the final outcome. A resource manager is either durable or volatile, depending on its resource.

Resource Manager Cookie: An identifier used to uniquely identify an **XA Resource Manager** Proxy object between calls to **XA Resource Manager Bridge** high-level events.

single-phase commit: An optimization of the Two-Phase Commit Protocol in which a **transaction manager** delegates the right to decide the outcome of a transaction to its only subordinate participant. This optimization can result in an In Doubt outcome.

subordinate transaction manager: A role taken by a **transaction manager** that is responsible for voting on the outcome of an **atomic transaction**. A **subordinate transaction manager** coordinates the voting and notification of its subordinate participants on behalf of its **superior transaction manager**. When communicating with those subordinate participants, the **subordinate transaction manager** acts in the role of **superior transaction manager**. The root **transaction manager** is never a **subordinate transaction manager**. A **subordinate transaction manager** has exactly one **superior transaction manager**.

superior transaction manager: A role taken by a **transaction manager** that is responsible for gathering outcome votes and providing the final transaction outcome. A root **transaction manager** can act as a **superior transaction manager** to a number of **subordinate transaction managers**. A **transaction manager** can act as both a **subordinate transaction manager** and a **superior transaction manager** on the same transaction.

tight coupling: A scheme for mapping **XA Transaction Branches** to **atomic transactions**. All **tightly coupled XA Transaction Branches** with the same **XA Global Transaction Identifier** are treated as operating under one **atomic transaction** by the XA Subordinate Transaction Manager Facet.

transaction: In OleTx, an **atomic transaction**.

transaction identifier: The **GUID** that uniquely identifies an **atomic transaction**.

transaction manager: The party that is responsible for managing and distributing the outcome of **atomic transactions**. A transaction manager is either a root transaction manager or a subordinate transaction manager for a specified transaction.

transient failure: Any event that could result in a loss of transport connectivity between **participants**, such as a software crash, a software restart, or a temporary problem with network **connections**.

two pipe: A model of communication between an **XA Resource Manager Bridge**, an **XA Resource Manager Bridge Facet**, a **Transaction Manager**, and an **XA Resource Manager**. For more information, see the description in section 1.3.1.2.

two-phase commit: An agreement protocol that is used to resolve the outcome of an atomic transaction in response to a commit request from the root application. Phase One and Phase Two are the distinct phases of the Two-Phase Commit Protocol.

two-pipe XA Resource Manager: An **XA Resource Manager** that uses the **two-pipe** model to communicate with a **Transaction Manager**.

work: The set of state changes that are applied to resources inside an **atomic transaction**.

XA Branch Identifier: The **globally unique identifier (GUID)** used by an **XA Resource Manager Bridge** to generate the **XA Branch Qualifier (BQUAL)** of an **XA Transaction Branch Identifier (XID)**. This **GUID** uniquely identifies the **XA Transaction Branch** within an **XA Resource Manager Bridge Facet** and **XA Resource Manager**.

XA Branch Qualifier (BQUAL): A field of an **XID** that uniquely identifies an **XA Transaction Branch** within a **transaction**. For more information, see [\[XOPEN-DTP\]](#).

XA Format Identifier: A format identifier for an **XID**. For more information, see [\[XOPEN-DTP\]](#).

XA Global Transaction Identifier: A field of an **XID** that uniquely identifies a **transaction**. For more information, see [\[XOPEN-DTP\]](#).

XA Interface: A bidirectional interface between a transaction manager and a resource manager. This interface is specified in [\[XOPEN-DTP\]](#).

XA Protocol: A protocol used to communicate XA interface calls. This protocol is implemented by an XA Resource Manager and is implementation specific.

XA Resource Manager: A **resource manager** that uses the XA interface specified in [XOPEN-DTP] to communicate with an **XA Transaction Manager**.

XA Resource Manager Bridge: A software component that allows an **application** to enlist an **XA Resource Manager** in an **OleTx Transaction**.

XA Resource Manager Bridge Facet: A software component that allows a **Transaction Manager** to communicate with an **XA Resource Manager Bridge**.

XA Resource Manager Instance Identifier: An identifier used to uniquely identify an instance of an **XA Resource Manager**. It does not persist through failure or software restart.

XA Superior Transaction Manager Identifier (Resource Manager Recovery GUID): A **GUID** used to uniquely identify an XA Superior Transaction Manager to an XA Subordinate Transaction Manager Facet. This identifier must persist through **transient failure** and **recovery**.

XA Transaction Branch: Represents a single Unit of Work done under a **transaction**. For more information, see [XOPEN-DTP].

XA Transaction Branch Identifier (XID): An identifier for an **XA Transaction Branch**.

XA Transaction Manager: A **Superior Transaction Manager** that uses the protocol specified in [XOPEN-DTP] to communicate with **XA Resource Managers**.

XA Transaction Manager Identifier: A **GUID** used by an **XA Resource Manager Bridge** to generate the **BQUAL** of an **XID**. This **GUID** uniquely identifies the **XA Resource Manager Bridge Facet** with which the **XID** is associated.

MAY, SHOULD, MUST, SHOULD NOT, MUST NOT: These terms (in all caps) are used as defined in [RFC2119]. All statements of optional behavior use either MAY, SHOULD, or SHOULD NOT.

1.2 References

Links to a document in the Microsoft Open Specifications library point to the correct section in the most recently published version of the referenced document. However, because individual documents in the library are not updated at the same time, the section numbers in the documents may not match. You can confirm the correct section numbering by checking the [Errata](#).

1.2.1 Normative References

We conduct frequent surveys of the normative references to assure their continued availability. If you have any issue with finding a normative reference, please contact dochelp@microsoft.com. We will assist you in finding the relevant information.

[C706] The Open Group, "DCE 1.1: Remote Procedure Call", C706, August 1997, <https://www2.opengroup.org/ogsys/catalog/c706>

[ISO/IEC-8859-1] International Organization for Standardization, "Information Technology -- 8-Bit Single-Byte Coded Graphic Character Sets -- Part 1: Latin Alphabet No. 1", ISO/IEC 8859-1, 1998, http://www.iso.org/iso/home/store/catalogue_tc/catalogue_detail.htm?csnumber=28245

Note There is a charge to download the specification.

[MS-CMPO] Microsoft Corporation, "[MSDTC Connection Manager: OleTx Transports Protocol](#)".

[MS-CMP] Microsoft Corporation, "[MSDTC Connection Manager: OleTx Multiplexing Protocol](#)".

[MS-DTCO] Microsoft Corporation, "[MSDTC Connection Manager: OleTx Transaction Protocol](#)".

[MS-DTYP] Microsoft Corporation, "[Windows Data Types](#)".

[MS-ERREF] Microsoft Corporation, "[Windows Error Codes](#)".

[RFC2119] Bradner, S., "Key words for use in RFCs to Indicate Requirement Levels", BCP 14, RFC 2119, March 1997, <http://www.rfc-editor.org/rfc/rfc2119.txt>

[RFC4122] Leach, P., Mealling, M., and Salz, R., "A Universally Unique Identifier (UUID) URN Namespace", RFC 4122, July 2005, <http://www.rfc-editor.org/rfc/rfc4122.txt>

[XOPEN-DTP] The Open Group, "Distributed Transaction Processing: The XA Specification", February 1992, <http://www.opengroup.org/bookstore/catalog/c193.htm>

1.2.2 Informative References

[KB938653] Microsoft Corporation, "List of MS DTC bugs that are fixed in Windows Server 2003 Post-Service Pack 2 MS DTC Hotfix Rollup Package 13", version 2.0, June 2008, <http://support.microsoft.com/kb/938653>

[MS-CMOM] Microsoft Corporation, "[MSDTC Connection Manager: OleTx Management Protocol](#)".

1.3 Overview

In a **distributed transaction**, typically three types of software components are involved:

- An application program (AP) defines **transaction** boundaries and specifies actions that constitute a transaction.
- **Resource managers (RMs)**, such as databases or file access systems, provide access to shared resources.
- A separate component called a **transaction manager (TM)** assigns identifiers to transactions, monitors their progress, and takes responsibility for transaction completion and for failure **recovery**.

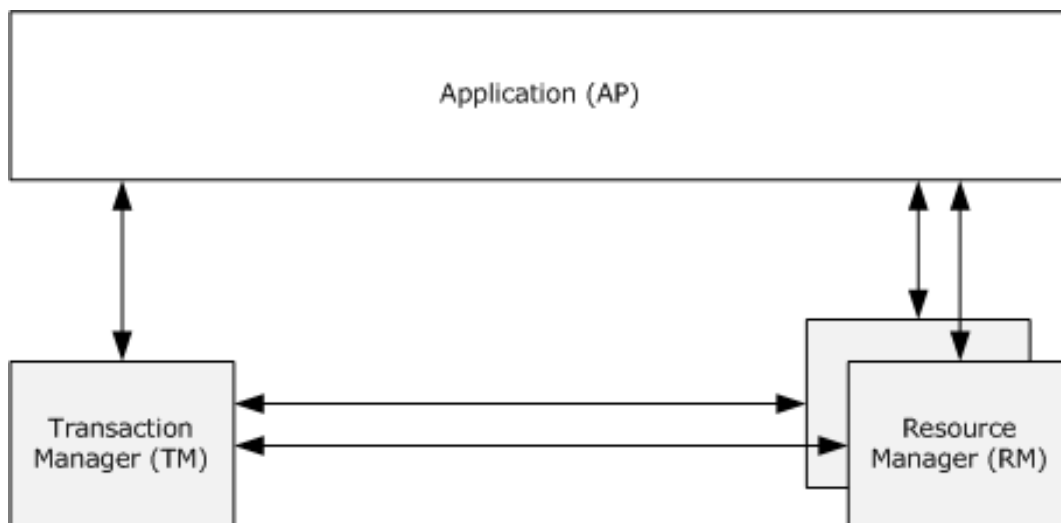

Figure 1: Software components of a typical distributed transaction

The MSDTC Connection Manager: OleTx Transaction Protocol specification [\[MS-DTCO\]](#) specifies a comprehensive distributed transaction protocol (**OleTx**). X/Open specifies a distributed transaction processing model, and a bidirectional XA interface [\[XOPEN-DTP\]](#) between a TM and an RM. There are certain differences (such as a difference in the syntax and semantics of the **transaction identifiers**) between the OleTx distributed transaction processing model, and the XA distributed transaction processing model. The protocol extensions specified in this document bridge those differences, and in particular solve the following problems:

- Enable OleTx Resource Managers to participate in transactions coordinated by **XA Transaction Managers**. In this scenario the OleTx Transaction Manager does not act as the TM as defined in [\[XOPEN-DTP\]](#). A third party TM communicates with the OleTx Transaction Manager using the extensions provided in this document and the OleTx Transaction Manager communicates with the OleTx Resource Manager via the OleTx Transaction Protocol specified in [\[MS-DTCO\]](#). This scenario is further discussed in [1.3.1.1](#).
- Enable **XA Resource Managers** to participate in transactions coordinated by OleTx Transaction Managers. In this scenario the OleTx Transaction Manager acts as TM as defined in [\[XOPEN-DTP\]](#). This scenario is further discussed in [1.3.1.2](#).

1.3.1 Scenarios

1.3.1.1 OleTx Resource Managers Enlisting with XA Transaction Managers

The communications between an XA Superior Transaction Manager and an XA Subordinate Transaction Manager Facet specified in this document enable OleTx Resource Managers to participate in **transactions** coordinated by **XA Transaction Managers**. The XA Transaction Manager component in the following diagram corresponds to the **TM** software component defined in [\[XOPEN-DTP\]](#). In this document it represents the higher-layer business logic that signals events on the XA Superior Transaction Manager component (see section [3.3](#)). The XA Superior Transaction Manager component acts as a **Resource manager (RM)** as defined in [\[XOPEN-DTP\]](#). A **subordinate transaction manager** software component with an XA Subordinate Transaction Manager Facet facilitates this scenario and bridges the **XA Protocol** to the **OleTx** protocol defined in [\[MS-DTCO\]](#). The following diagram shows components involved in this usage scenario.

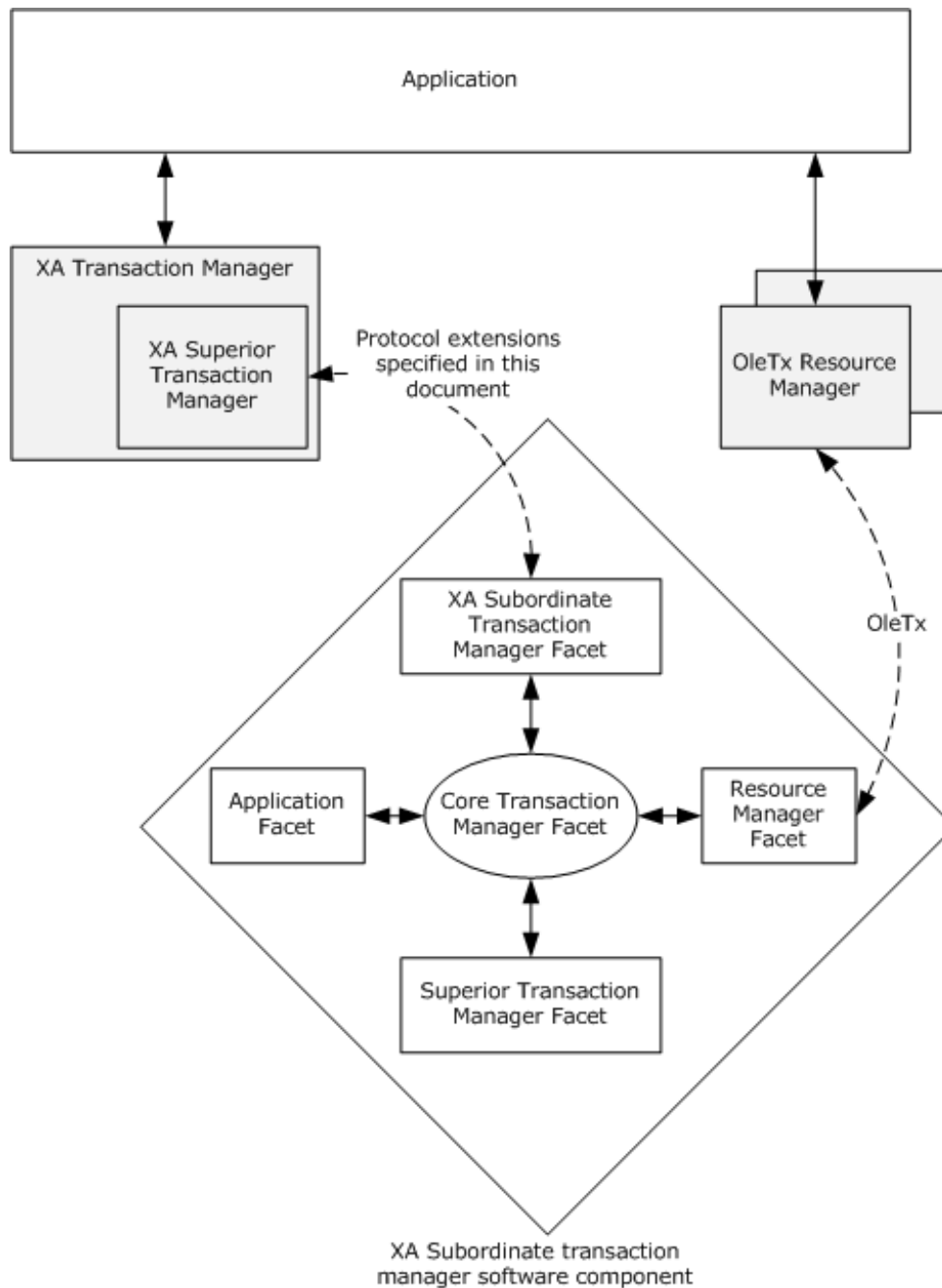

Figure 2: OleTx Resource Managers enlisting with XA Transaction Managers topology

The following sections illustrate the interactions that take place between these components in a common scenario drawn from each of the following areas of **distributed transaction** processing:

- Transaction **enlistment** and completion
- Transaction **recovery**

1.3.1.1.1 Transaction Enlistment and Completion

The following sequence diagram is a schematic of the interaction that takes place between the various software components involved in the usage scenario when an OleTx Resource Manager is enlisted in a **transaction** coordinated by an **XA Transaction Manager**, and the transaction is committed.

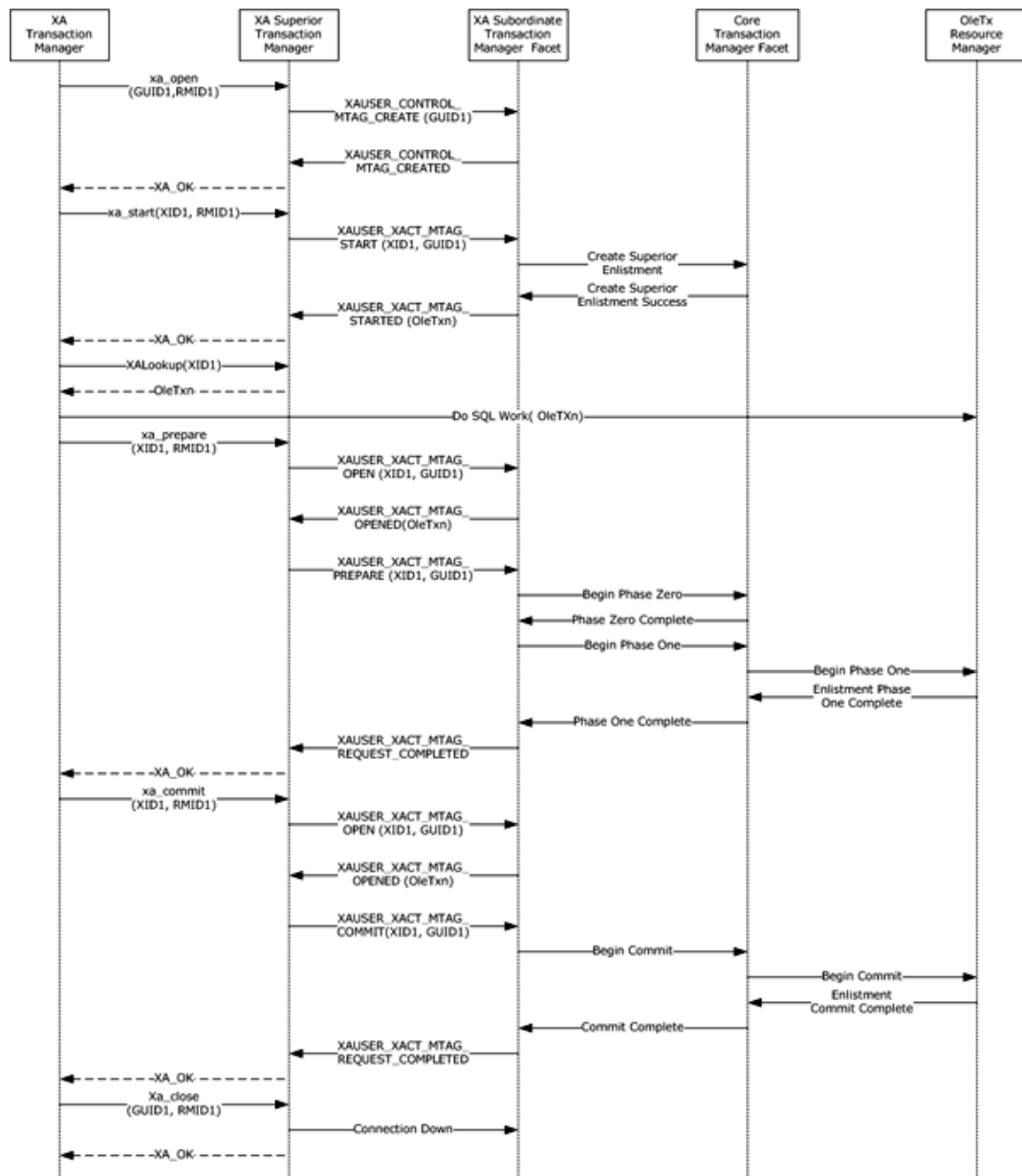

Figure 3: XA Superior Transaction enlistment and completion

The protocols involved are specified as follows:

- The protocol between the XA Superior Transaction Manager and the XA Subordinate Transaction Manager Facet is specified by this document in [2](#) and [3](#).
- The protocol between the XA Subordinate Transaction Manager Facet and the Core Transaction Manager Facet is specified in [\[MS-DTCO\]](#).
- The protocol between the OleTx Resource Manager and the Core Transaction Manager Facet is specified in [\[MS-DTCO\]](#).

- The protocol between the **application** and the OleTx Resource Manager is implementation-specific.

The interface between the XA Transaction Manager and the XA Superior Transaction Manager is specified in [\[XOPEN-DTP\]](#), with the following exceptions:

- There is an additional implementation-specific XA Lookup event.
- The ax_reg and the ax_unreg APIs are not used.

To enlist the OleTx Resource Managers, the XA Transaction Manager first calls xa_start on the XA Superior Transaction Manager, passing in an **XID**. This will cause an **OleTx** transaction to be created in the XA Subordinate Transaction Manager Facet, which will be passed back to the XA Superior Transaction Manager. The XA Transaction Manager then triggers the XA Lookup event on the XA Superior Transaction Manager, passing in the XID, which will return the OleTx transaction.

The OleTx Resource Managers are then enlisted in the OleTx transaction as specified in [MS-DTCO] section 3.5.

The XA Transaction Manager then follows the **Two-Phase Commit Protocol**.

1.3.1.1.2 Transaction Recovery

The following sequence is a schematic of the interactions that take place between the various software components involved in the usage scenario when an **XA Transaction Manager** comes up after a crash, and performs **recovery** for the **transactions** that it has not yet completed.

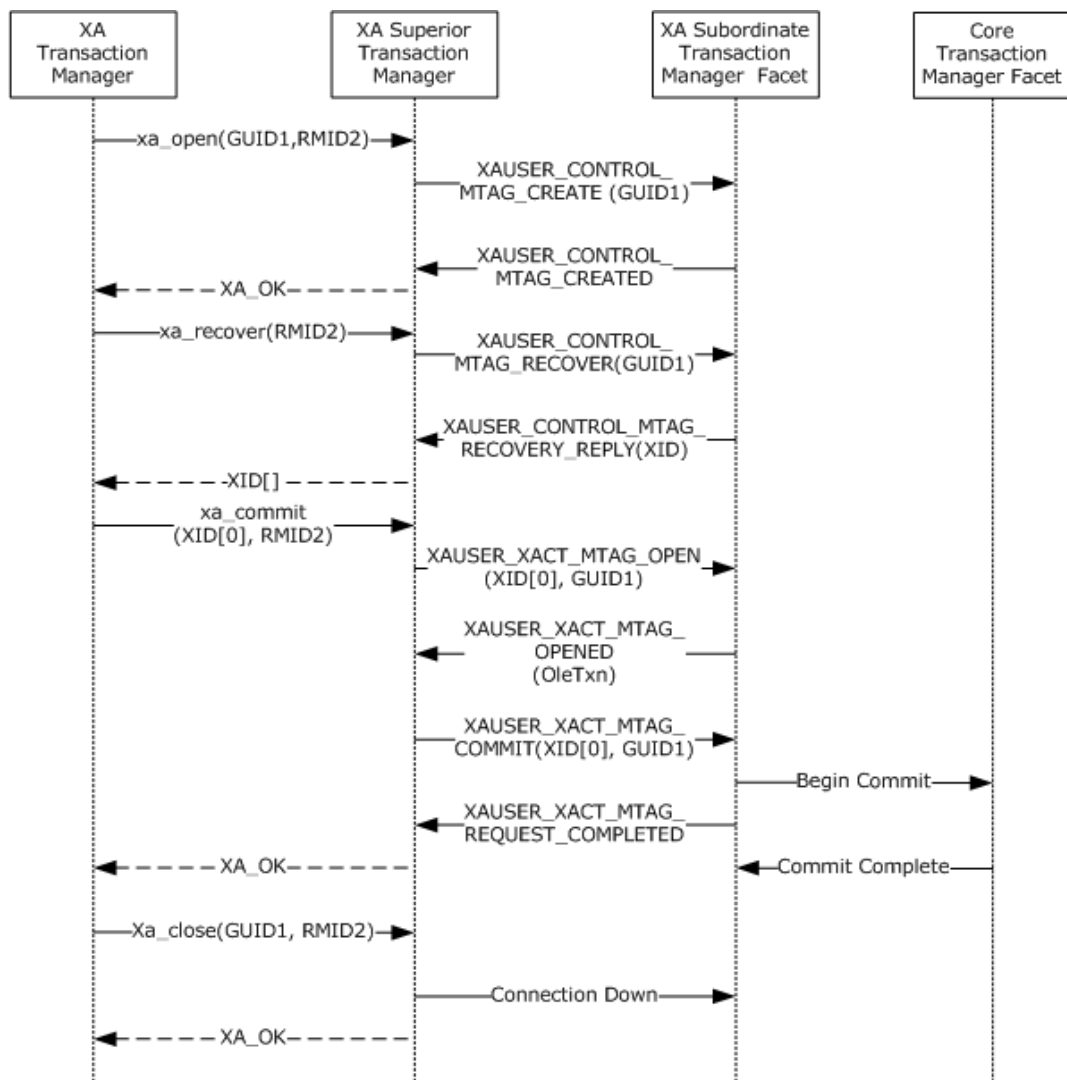

Figure 4: XA Superior Transaction recovery

The protocols involved are specified as follows:

- The protocol between the XA Superior Transaction Manager and the XA Subordinate Transaction Manager Facet is specified by this document in section 2 and section 3.
- The protocol between the XA Subordinate Transaction Manager Facet and the Core Transaction Manager Facet is specified in [\[MS-DTCO\]](#).

The interface between the XA Transaction Manager and the XA Superior Transaction Manager is specified in [\[XOPEN-DTP\]](#), with the addition of the implementation-specific XA Lookup event.

One of the differences between the **OleTx** model and the XA model, as far as the recovery process is concerned, is that in the OleTx model the recovery process is initiated by a **resource manager** that re-enlists, whereas in case of the XA model, the recovery process is initiated by an XA Transaction Manager.

The XA Transaction Manager requests a list of all those transactions in need of recovery, and makes calls on the XA Superior Transaction Manager to communicate their results using the **XA Interface** specified in [\[XOPEN-DTP\]](#).

1.3.1.2 XA Resource Managers Enlisting with Transaction Managers

The communications between an **XA Resource Manager Bridge** and an **XA Resource Manager Bridge Facet** specified in this document enable **XA Resource Managers** to participate in **transactions** coordinated by **transaction managers**. A **Superior Transaction Manager** software component with an XA Resource Manager Bridge Facet facilitates this scenario. The following figures show the components involved in this scenario.

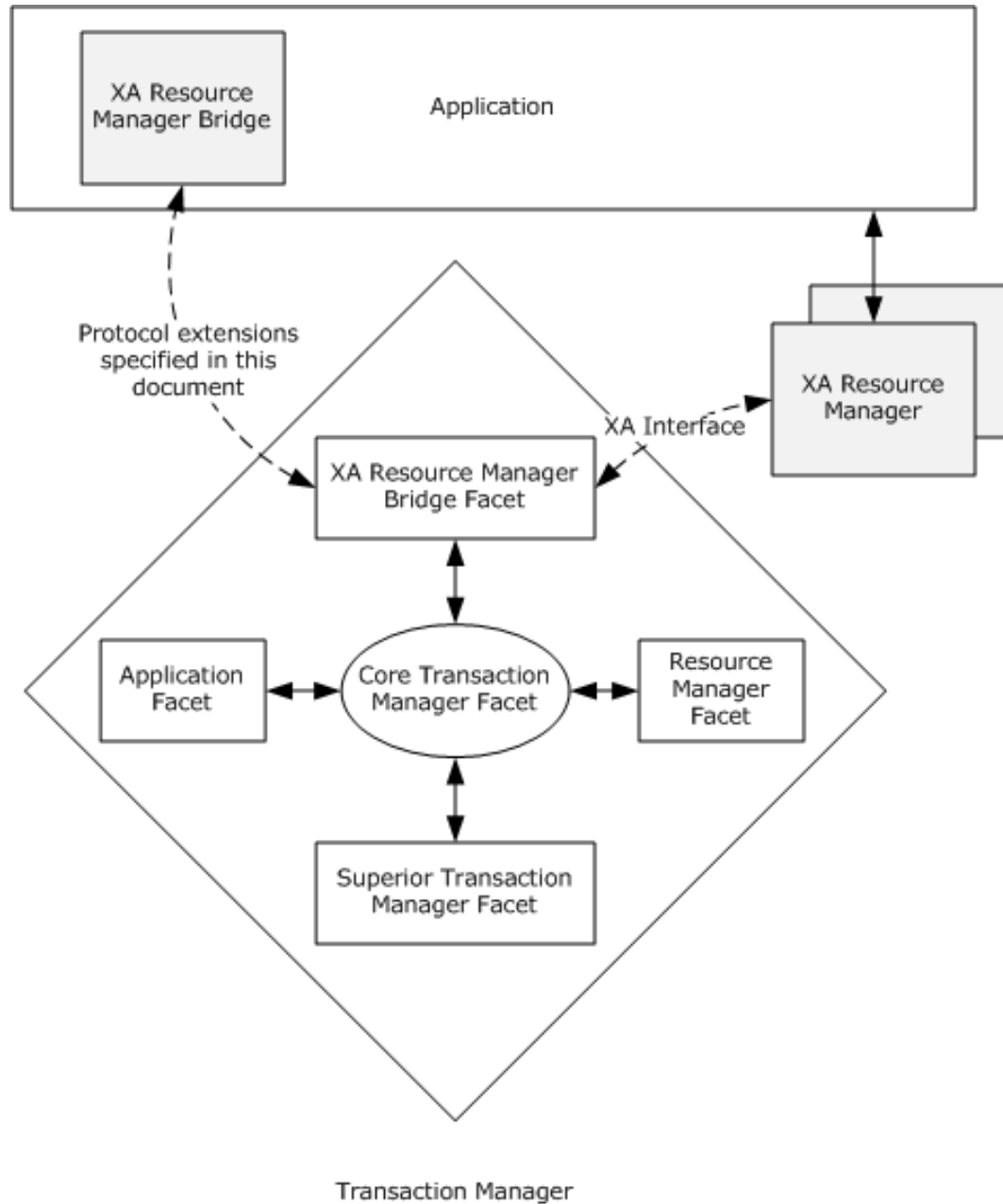

Figure 5: XA Resource Managers enlisting with Transaction Managers topology (two-pipe model)

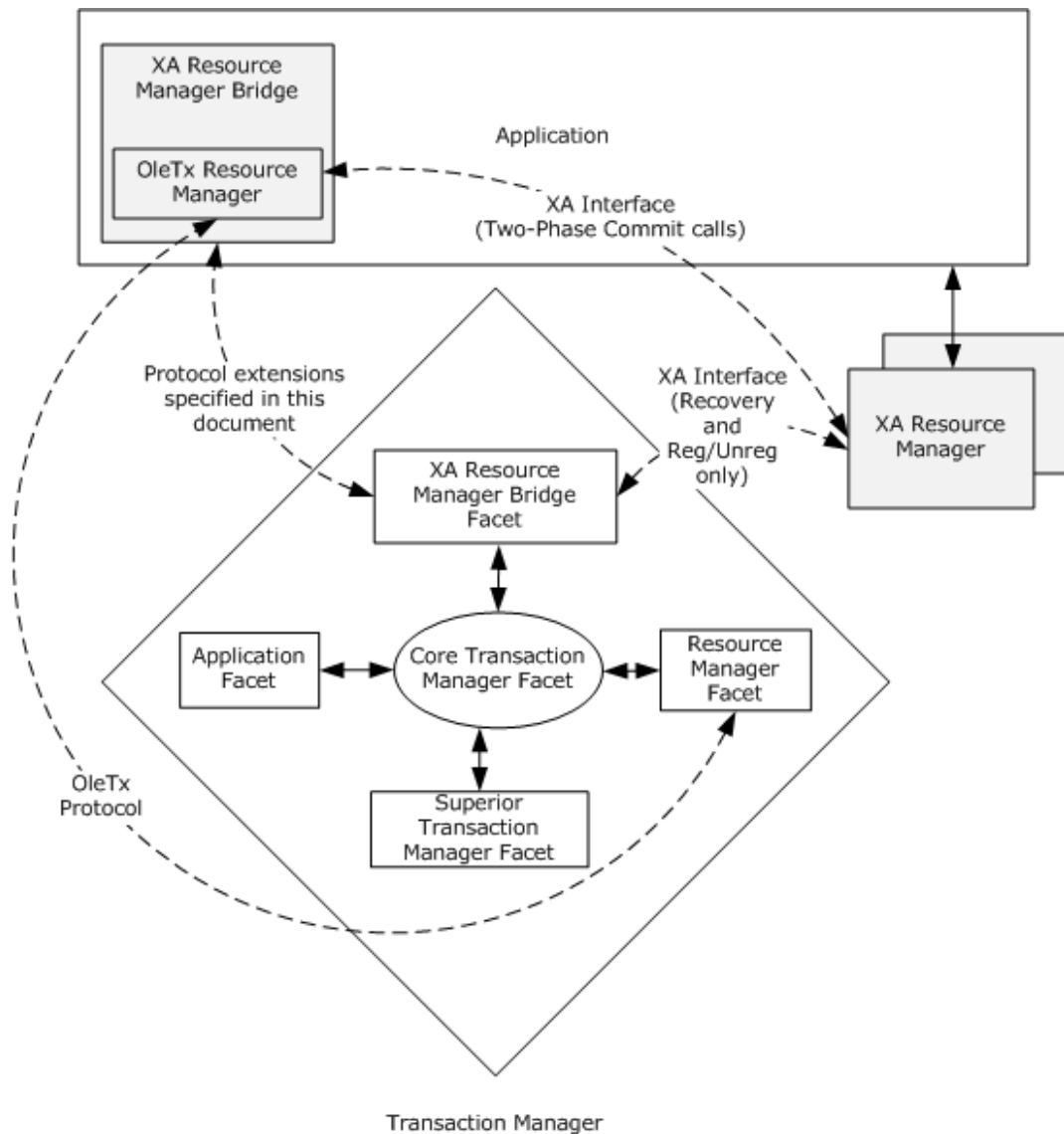

Figure 6: XA Resource Managers enlisting with Transaction Managers topology (one-pipe model)

The following sections illustrate the interactions that take place between these components in a common scenario drawn from each of the following areas of a distributed transaction processing:

- Transaction **recovery**
- XA Resource Manager registration and unregistration
- Transaction **enlistment** and completion

The protocol defined in this document supports two models to support the "XA Resource Managers enlisting with transaction managers" scenario:

- **Two-pipe** model
- **One-pipe** model

Two pipe is a model of communication between an XA Resource Manager Bridge, an XA Resource Manager Bridge Facet, a Transaction Manager, and an XA Resource Manager, where an XA Resource Manager Bridge Facet makes the **XA Interface** calls associated with **Two-Phase Commit** and Recovery to an XA Resource Manager.

One pipe is another model of communication between an XA Resource Manager Bridge, an XA Resource Manager Bridge Facet, a Transaction Manager, and an XA Resource Manager. In this model, when an XA Resource Manager is registered with the XA Resource Manager Bridge, the XA Resource Manager Bridge registers an **OleTx** Resource Manager as specified in [\[MS-DTCO\]](#) section 3.5. When a request is made to enlist the XA Resource Manager in an OleTx transaction, the OleTx Resource Manager is enlisted in the OleTx transaction. The OleTx Resource Manager enlistment inside the XA Resource Manager Bridge makes the necessary Two-Phase Commit calls of the XA Interface, defined by [\[XOPEN-DTP\]](#), to the XA Resource Manager. The only XA Interface calls made from the XA Resource Manager Bridge Facet to the XA Resource Manager are those associated with recovery and registration/unregistration.

In both models, the XA Interface is implemented by the XA Resource Manager in a third-party component. The XA Resource Manager Bridge Facet or OleTx Resource Manager loads the third-party component and makes XA Interface calls using it. The XA Interface implementation might generate messages that are implementation-specific and beyond the purview of this document.

In both models, the interactions that take place for transaction recovery between various software components are same. XA Resource Manager registration, unregistration, transaction enlistment, and completion require different interactions in the two models. The following subsections discuss interactions involved for transaction recovery, XA Resource Manager registration, unregistration, and transaction enlistment and completion in two-pipe and one-pipe models.

1.3.1.2.1 Transaction Recovery

The **atomicity** property of a **transaction** guarantees that all **participants** in the transaction will receive the same **outcome**. In order to honor this guarantee, **transaction managers** have to be capable of recovering from **transient failures**.

After a transient failure, the transaction manager reloads the `xa_switches` of each of the registered **XA Resource Managers** and polls each one for incomplete transactions. It then proceeds to inform the XA Resource Managers of the outcomes of the transactions.

The following sequence diagram is a schematic of the interactions that take place between the various software components involved when recovering from a transient failure.

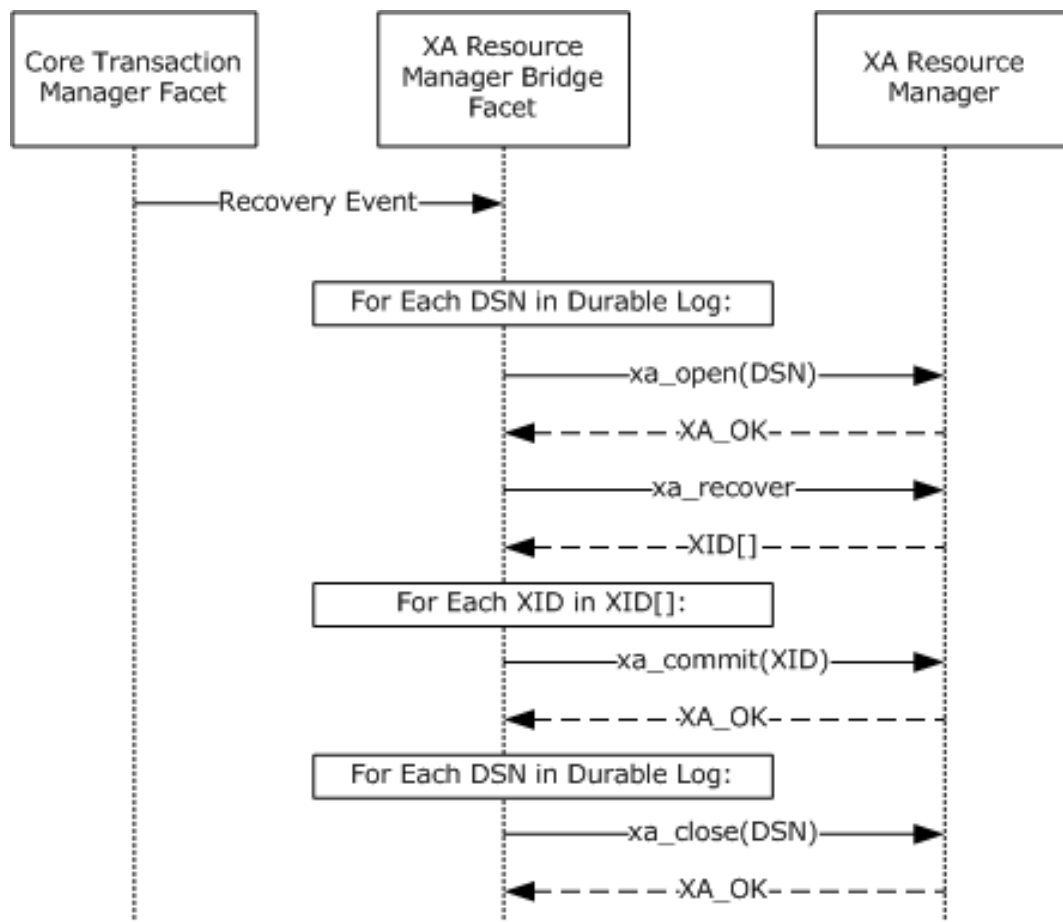

Figure 7: XA Resource Manager Transaction recovery

The protocols involved are specified as follows:

- The **XA Interface** between the **XA Resource Manager Bridge Facet** and the XA Resource Manager is implemented by the XA Resource Manager in a third-party component that is loaded by the XA Resource Manager Bridge Facet. The XA Interface implementation might generate messages that are implementation-specific and beyond the purview of this document.
- The protocol between the XA Resource Manager Bridge Facet and the Core Transaction Manager Facet is specified in [\[MS-DTCO\]](#).
- The intent of these interactions is similar to that of the Recovery protocol between a Transaction Manager and a Resource Manager as described in [\[MS-DTCO\]](#) section 1.3.4. However, [\[XOPEN-DTP\]](#) specifies that the Transaction Manager is responsible for initiating **recovery** rather than the Resource Manager.

1.3.1.2.2 Two-Pipe Model

In this model, after an **XA Resource Manager** is enlisted in an **OleTx transaction**, the XA Resource Manager Bridge Facet makes the necessary **XA Interface** calls for the **Two-Phase Commit Protocol** when communicating with the XA Resource Manager.

If a **transient failure** occurs and **recovery** is necessary, the XA Resource Manager Bridge Facet drives the recovery process with all the registered XA Resource Managers.

1.3.1.2.2.1 XA Resource Manager Registration and Unregistration

The following sequence diagram is a schematic of the interactions that take place between the various software components involved in the usage scenario when a **Two-Pipe XA Resource Manager** is registered with a **Transaction Manager**.

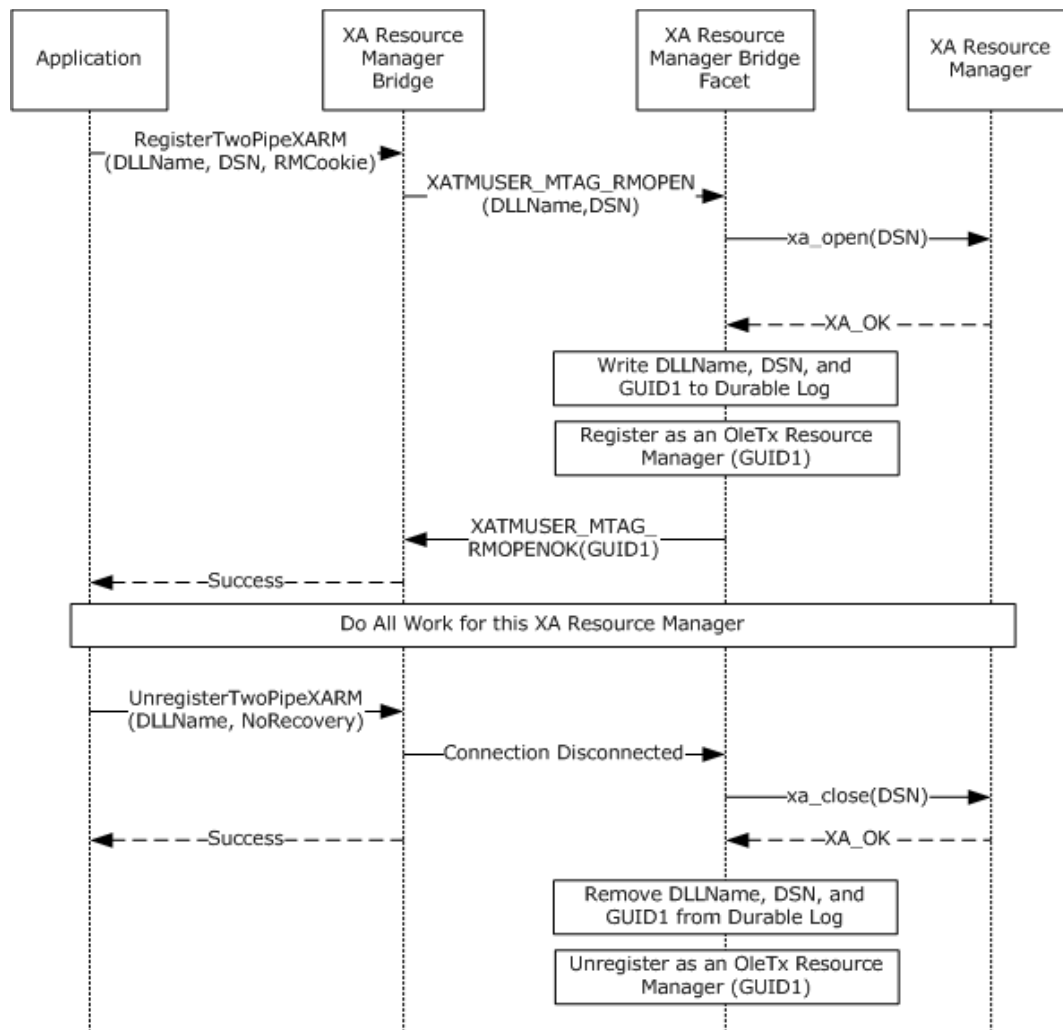

Figure 8: Two-pipe XA Resource Manager registration and unregistration

The protocols involved are specified as follows:

- The protocol between the XA Resource Manager Bridge and the XA Resource Manager Bridge Facet is specified by this document in sections [2](#) and [3](#).
- The **XA Interface** between the **XA Resource Manager Bridge Facet** and the **XA Resource Manager** is implemented by the XA Resource Manager in a third-party component that is loaded by the XA Resource Manager Bridge Facet. The XA Interface adheres to the API defined in the [\[XOPEN-DTP\]](#) specification, with the exception that ax_reg and ax_unreg operations are not supported by the transaction manager and are not used by the extensions defined in this document. The XA Interface implementation might generate messages that are implementation-specific and beyond the purview of this document.
- The protocol between the **application** and the XA Resource Manager Bridge is implementation-specific.

After the third-party component is loaded, the third-party component name is written to the **XA DLL Name** Abstract Data Model element and is used as the DLL Name parameter in the XA Resource Manager registration and unregistration.

To register an XA Resource Manager, an application passes the **XA Resource Manager Bridge** a DLL Name, a Data Source Name, and a **Resource Manager cookie**. The DLL Name is used by the XA Resource Manager Bridge Facet to load the `xa_switch` of the XA Resource Manager. The Data Source Name, an **ASCII** string, is passed to the `xa_open` and `xa_close` calls made on this XA Resource Manager. The **RM** cookie is used by the application to identify the XA Resource Manager in future calls.

The XA Resource Manager Bridge passes these parameters to the XA Resource Manager Bridge Facet, which loads the `xa_switch` of the XA Resource Manager and calls `xa_open` on it. If this succeeds it will write the DLL Name, the Data Source Name, and a **GUID** generated to uniquely identify the XA Resource Manager to a durable log to allow for **recovery** in case of a **transient failure**. The XA Resource Manager Bridge Facet then passes the GUID back to the XA Resource Manager Bridge.

The XA Resource Manager Bridge stores the GUID, indexed by the RM cookie, and returns success.

When all **Work** is complete for the XA Resource Manager, it is unregistered by passing the RM cookie to the XA Resource Manager Bridge, which calls the XA Resource Manager Bridge Facet on the same MSDTC Connection Manager: OleTx Multiplexing Protocol (as specified in [\[MS-CMP\]](#)) **connection** used to register the XA Resource Manager and requests that the XA Resource Manager be unregistered.

The XA Resource Manager Bridge Facet removes the entry for the XA Resource Manager from the durable log and returns success.

1.3.1.2.2.2 Transaction Enlistment and Completion

The following sequence diagram is a schematic of the interactions that take place between the various software components involved in the usage scenario when a **Two-Pipe XA Resource Manager** is enlisted in an **OleTx transaction**.

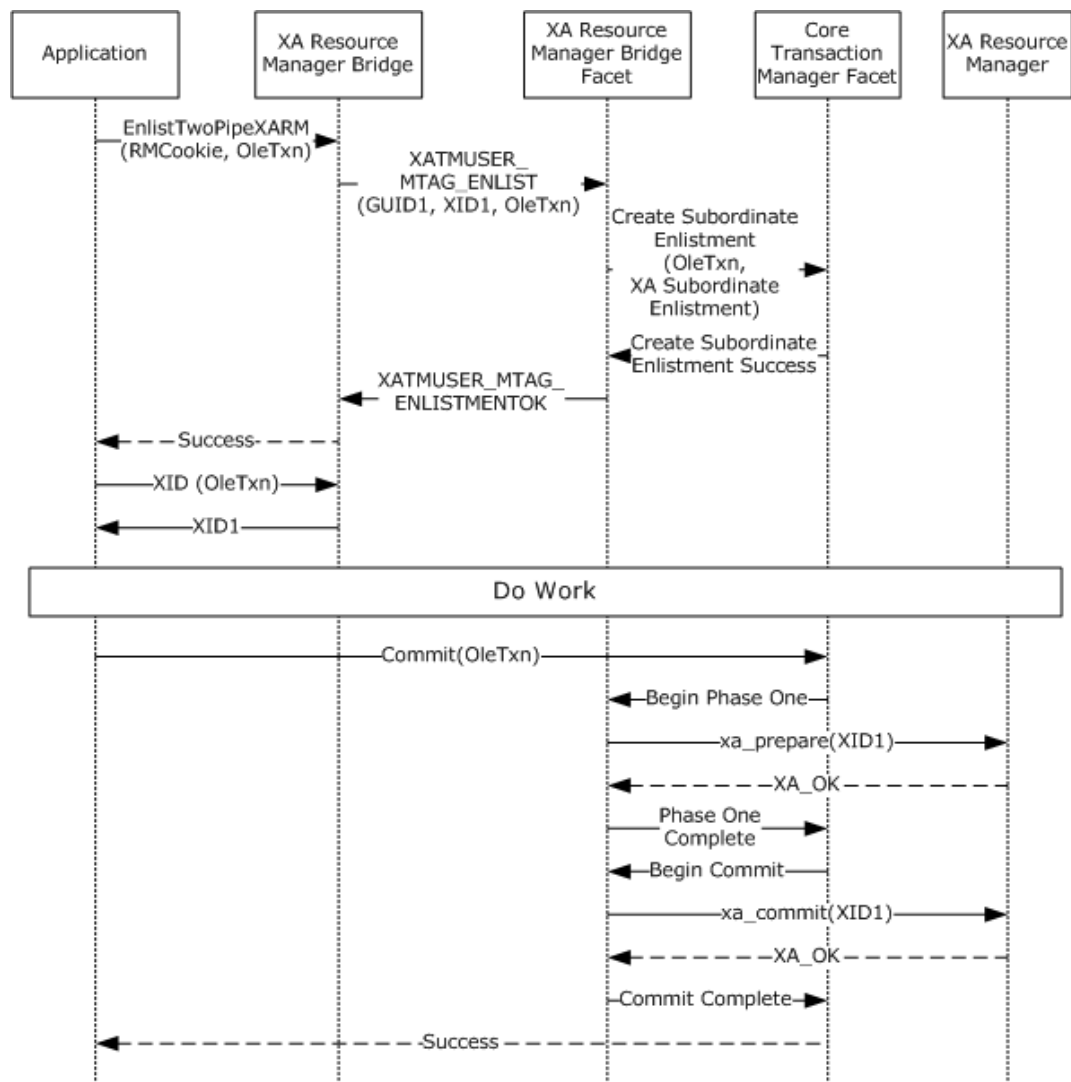

Figure 9: Two-pipe XA Resource Manager Transaction enlistment and completion

The protocols involved are specified as follows:

- The protocol between the XA Resource Manager Bridge and the XA Resource Manager Bridge Facet is specified by this document in section 2 and section 3.
- The protocol between the XA Resource Manager Bridge Facet and the Core Transaction Manager Facet is specified in [MS-DTCO].
- The protocol between the **Application** and the XA Resource Manager Bridge is implementation-specific.
- The **XA Protocol** between the XA Resource Manager Bridge Facet and the **XA Resource Manager** is implemented by the XA Resource Manager and is implementation-specific. However, the API adheres to the [XOPEN-DTP] specification, with the exception that ax_reg and ax_unreg operations are not supported by the **transaction manager** and are not used by the extensions defined in this document.

The process of enlisting an XA Resource Manager in an OleTx transaction is very similar to enlisting an OleTx Resource Manager in an OleTx transaction.

After the XA Resource Manager is enlisted in the OleTx transaction, one calls Create XID on the XA Resource Manager Bridge, passing in the OleTx transaction and receiving a corresponding **XID**. This XID is then used to perform **Work** on the XA Resource Manager.

During the **Two-Phase Commit Protocol**, when the Subordinate Enlistment created by the XA Resource Manager Bridge Facet receives a prepare request, it constructs the XID associated with the OleTx transaction and calls `xa_prepare` on the `xa_switch` of the enlisted XA Resource Manager, passing in the XID.

When the subordinate **enlistment** created by the XA Resource Manager Bridge Facet receives a commit request, it calls `xa_commit` on the `xa_switch` of the enlisted XA Resource Manager, passing in the XID.

1.3.1.2.3 One-Pipe Model

In this model, after an **XA Resource Manager** is enlisted in an **OleTx transaction**, an implementation-specific **enlistment** in the OleTx transaction makes the calls necessary for the **Two-Phase Commit Protocol**, using the **XA Interface** specified in [\[XOPEN-DTP\]](#), to the XA Resource Manager.

If a **transient failure** occurs and **recovery** is necessary, the XA Resource Manager Bridge Facet drives the recovery process with all registered XA Resource Managers.

1.3.1.2.3.1 XA Resource Manager Registration and Unregistration

The following sequence diagram is a schematic of the interactions that take place between the various software components involved in the usage scenario when a **One-Pipe XA Resource Manager** is registered with a **Transaction Manager**.

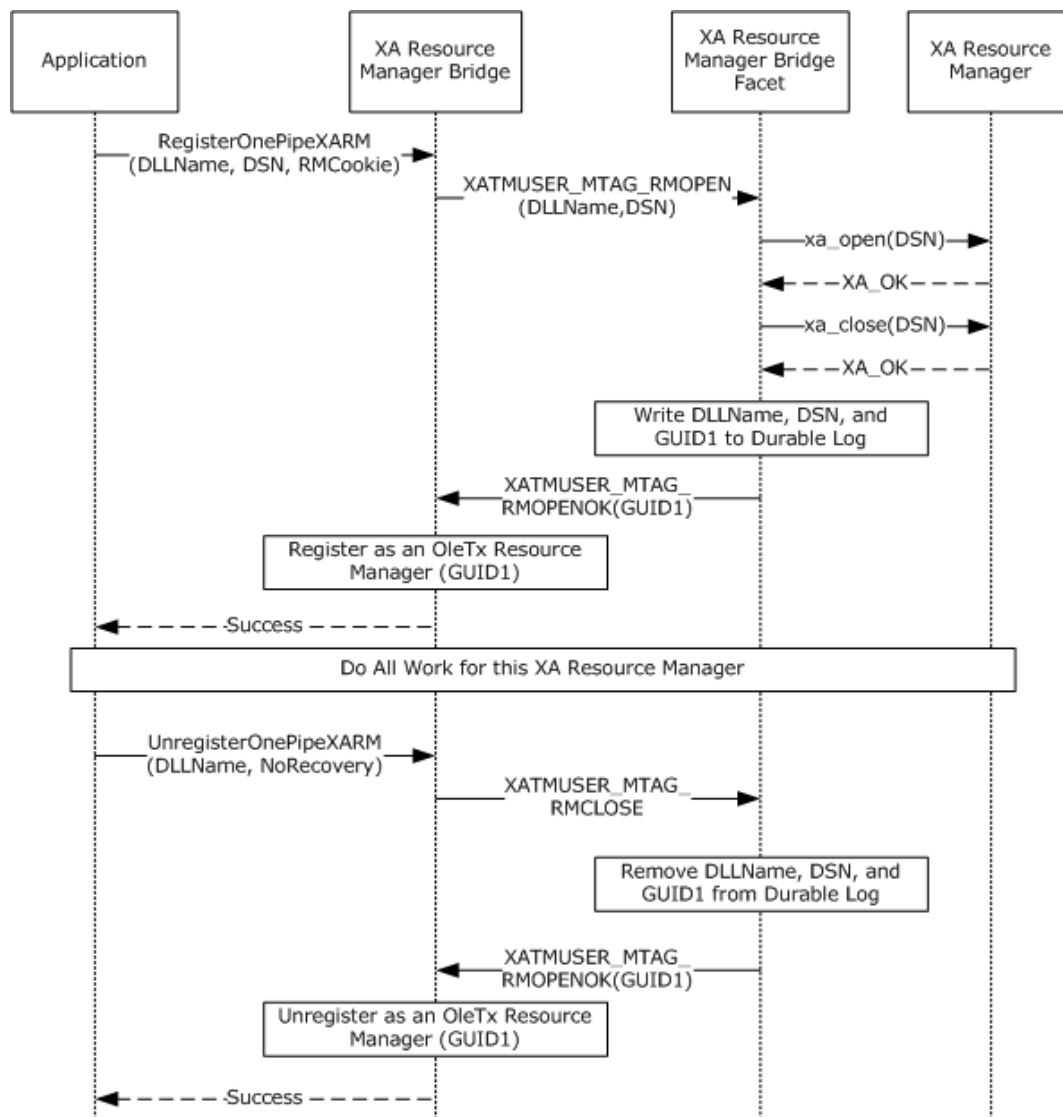

Figure 10: One-pipe XA Resource Manager registration and unregistration

The protocols involved are specified as follows:

- The protocol between the XA Resource Manager Bridge and the XA Resource Manager Bridge Facet is specified by this document in section 2 and section 3.
- The **XA Protocol** between the XA Resource Manager Bridge Facet and the **XA Resource Manager** is implemented by the XA Resource Manager and is implementation-specific. However, the API follows the [\[XOPEN-DTP\]](#) specification, with the exception that ax_reg and ax_unreg operations are not supported by the transaction manager and are not used by the extensions defined in this document.
- The protocol between the **application** and the XA Resource Manager Bridge is implementation-specific.

To register an XA Resource Manager, an application passes the XA Resource Manager Bridge a DLL Name, a Data Source Name, and an **RM** cookie. The DLL name is used by the XA Resource Manager Bridge Facet to load the xa_switch of the XA Resource Manager. The Data Source Name, an ASCII

string, is passed to the xa_open and xa_close calls made on this XA Resource Manager. The RM cookie is used by the application to identify the XA Resource Manager in future calls.

The XA Resource Manager Bridge passes these parameters to the XA Resource Manager Bridge Facet, which loads the xa_switch of the XA Resource Manager and calls xa_open and then xa_close on it. If this succeeds it will write the DLL Name, the Data Source Name, and a **GUID** generated to uniquely identify the XA Resource Manager to a durable log to allow for **recovery** in case of a **transient failure**. The XA Resource Manager Bridge Facet then passes the GUID back to the XA Resource Manager Bridge.

The XA Resource Manager Bridge uses the GUID to register an OleTx Resource Manager, then stores the GUID, indexed by the RM cookie, and returns success.

When all **Work** is complete for the XA Resource Manager, it is unregistered by passing the RM cookie to the XA Resource Manager Bridge along with a flag to indicate whether to initiate recovery on the XA Resource Manager.

If no recovery is necessary, an RMCLOSE request is sent on the same CMP **connection** (as specified in [\[MS-CMP\]](#)) used to register the XA Resource Manager to unregister XA Resource Manager.

The XA Resource Manager Bridge Facet removes the entry for the XA Resource Manager from the Durable log and returns success.

If recovery is necessary, the CMP connection (as specified in [\[MS-CMP\]](#)) used to register the XA Resource Manager is brought down, which will trigger recovery.

1.3.1.2.3.2 Transaction Enlistment and Completion

The following sequence diagram is a schematic of the interactions that take place between the various software components involved in the usage scenario when a **One-Pipe XA Resource Manager** is enlisted in an **OleTx transaction**.

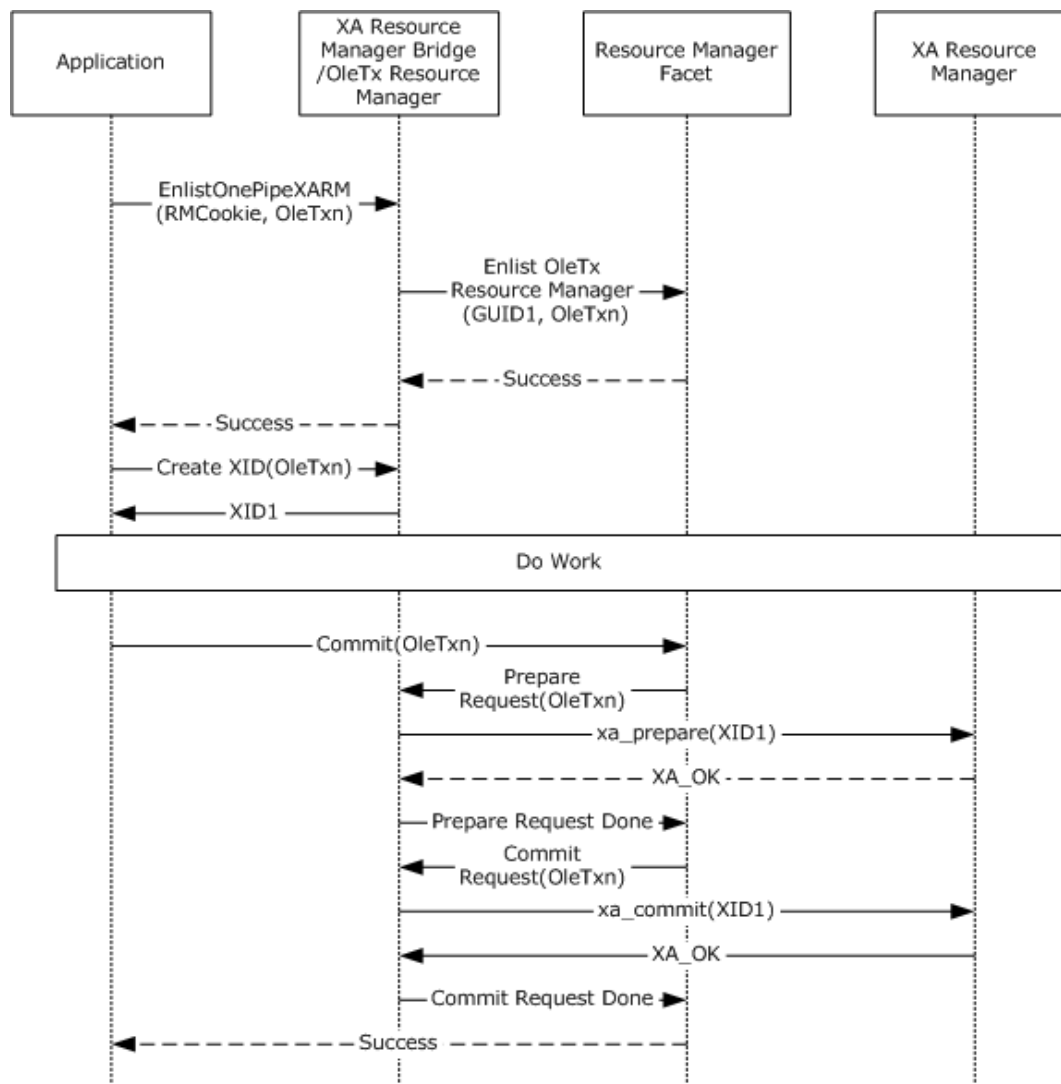

Figure 11: One-pipe XA Resource Manager transaction enlistment and completion

The protocols involved are specified as follows:

- The protocol between the **XA Resource Manager Bridge/OleTx Resource Manager** and the **Resource Manager Facet** is specified in [\[MS-DTCO\]](#).
- The protocol between the **Application** and the XA Resource Manager Bridge is implementation-specific.
- The **XA Protocol** between the XA Resource Manager Bridge Facet and the **XA Resource Manager** is implemented by the XA Resource Manager and is implementation-specific. However, the API follows the [\[XOPEN-DTP\]](#) specification, with the exception that `ax_reg` and `ax_unreg` operations are not supported by the **transaction manager** and are not used by the extensions defined in this document.

The process of enlisting a One-Pipe XA Resource Manager in an OleTx transaction involves creating an OleTx **enlistment** in the OleTx transaction. This enlistment makes the calls on the XA Resource Manager necessary for **Two-Phase Commit** according to the **XA Interface**.

After the XA Resource Manager is enlisted in the OleTx transaction, the application calls Create XID on the XA Resource Manager Bridge, passing in the OleTx transaction and receiving a corresponding **XID**. This XID is then used to perform work on the XA Resource Manager.

1.3.2 Roles

This protocol specifies two additional roles to those defined in [\[MS-DTCO\]](#), the XA Resource Manager Bridge role and the XA Superior Transaction Manager role. This protocol also, extends the **Transaction Manager** role specified by [\[MS-DTCO\]](#). These roles are described in the following sections. Note that although there are some similarities in naming and functionality, the roles defined in the following sections and in [\[MS-DTCO\]](#) are different from the three software component roles defined in [\[XOPEN-DTP\]](#): AP, RM, and TM.

1.3.2.1 XA Resource Manager Bridge Role

The XA Resource Manager Bridge role is typically responsible for performing the following tasks:

- Registration of a **Two-Pipe XA Resource Manager**.
- Unregistration of a Two-Pipe XA Resource Manager.
- **Enlistment** of a Two-Pipe XA Resource Manager on a **transaction** as a **Phase One** and **Phase Two participant**.
- Registration of a **One-Pipe XA Resource Manager**.
- Unregistration of a One-Pipe XA Resource Manager.
- Enlistment of a One-Pipe XA Resource Manager on a transaction as a Phase One and Phase-Two participant.

This role acts as the **RM** software component defined in [\[XOPEN-DTP\]](#) and depends on the [XA Resource Manager Bridge Facet \(section 1.3.2.3.1\)](#), which, along with the Core Transaction Manager Facet defined in [\[MS-DTCO\]](#), acts as the **TM** software component defined in [\[XOPEN-DTP\]](#).

1.3.2.2 XA Superior Transaction Manager Role

The XA Superior Transaction Manager role is typically responsible for performing the following tasks:

- Managing a mapping between **XIDs** provided by an **XA Transaction Manager** and the corresponding **OleTx transactions**.
- Participating in the XA Protocol coordinated by an XA Transaction Manager.
- Participating in a **Two-Phase Commit** coordinated by an XA Transaction Manager, and mapping to and from the related XA Protocol.
- Notifying a **Transaction Manager** of **recovery** initiated by an XA Transaction Manager, and participating in that process.

This role acts as the **RM** software component defined in [\[XOPEN-DTP\]](#). The TM software component defined in [\[XOPEN-DTP\]](#) is represented by an XA Transaction Manager.

1.3.2.3 Transaction Manager Role

The Transaction Manager Role defined in [\[MS-DTCO\]](#) is extended to include the following **facets**:

- XA Resource Manager Bridge Facet

- XA Subordinate Transaction Manager Facet

1.3.2.3.1 XA Resource Manager Bridge Facet

The XA Resource Manager Bridge Facet provides the following services to an XA Resource Manager Bridge:

- Registration of a **Two-Pipe XA Resource Manager**.
- Unregistration of a Two-Pipe XA Resource Manager.
- **Enlistment** of a Two-Pipe XA Resource Manager on a **transaction** as a Phase-One and **Phase-Two participant**.
- Registration of a **One-Pipe XA Resource Manager**.
- Unregistration of a One-Pipe XA Resource Manager.
- Participating in **recovery** and **outcome** notification for **XA Resource Managers** enlisted on a transaction.
- Participating in a **Two-Phase Commit** coordinated by a **Transaction Manager**, and mapping to and from the related XA Protocol.

1.3.2.3.2 XA Subordinate Transaction Manager Facet

The XA Subordinate Transaction Manager Facet provides the following services to an XA Superior Transaction Manager:

- Creation of **OleTx transactions** mapped to **XIDs**.
- Participating in the **Two-Phase Commit Protocol** coordinated by an **XA Transaction Manager**, and mapping to and from the related XA Protocol.
- Participating in **Recovery** and **outcome** notification initiated by an XA Transaction Manager.

1.4 Relationship to Other Protocols

This protocol extends the protocol described in [\[MS-DTCO\]](#). The following list illustrates the protocol layering for this protocol:

- This protocol
- [\[MS-DTCO\]](#)
- [\[MS-CMP\]](#)
- [\[MS-CMPO\]](#)

1.5 Prerequisites/Preconditions

This protocol requires that all participating roles possess implementations of the MSDTC Connection Manager: OleTx Transports Protocol (as specified in [\[MS-CMPO\]](#)) and MSDTC Connection Manager: OleTx Multiplexing Protocol (as specified in [\[MS-CMP\]](#)). This protocol also requires that an implementation of the protocol specified in [\[MS-DTCO\]](#) is accessible using the protocols specified in [\[MS-CMPO\]](#) and [\[MS-CMP\]](#) and an implementation-specific communication mechanism between **facets** as outlined in [\[MS-DTCO\]](#) (section 3.2.1.4).

1.6 Applicability Statement

This protocol applies to scenarios where an **XA Resource Manager** and an implementation of the protocol specified by [\[MS-DTCO\]](#) are available.

This protocol applies to scenarios where an **XA Transaction Manager** and an implementation of the protocol specified by [\[MS-DTCO\]](#) are available.

This protocol requires network topologies where the [\[MS-CMPO\]](#) and [\[MS-CMP\]](#) protocols constitute a viable network transport for establishing many short-lived **connection** exchanges that accomplish specific tasks.

1.7 Versioning and Capability Negotiation

This section specifies the versioning and capability aspects of this protocol.

All of the versioning, versioning negotiation, and capability negotiation mechanisms specified in [\[MS-DTCO\]](#) section 1.7 are applicable to this protocol.

The value chosen for the protocol version determines the implementation's degree of support for specific **connection** and message types as specified in the following sections:

- Section [2.2.3.1](#) defines versioning details for connection types and message types specific to the XA Resource Manager Bridge Facet role.
- Section [2.2.3.1](#) defines versioning details for connection types and message types specific to the XA Resource Manager Bridge role.
- Section [2.2.4.1](#) defines versioning details for connection types and message types specific to the XA Subordinate Transaction Manager Facet role.
- Section [2.2.4.1](#) defines versioning details for connection types and message types specific to the XA Superior Transaction Manager role.

1.8 Vendor-Extensible Fields

This protocol has no vendor-extensible fields.

1.9 Standards Assignments

This protocol has no standards assignments.

2 Messages

The following sections specify the syntax of the messages that are transported, on the wire, by this protocol.

This protocol references commonly used data types as defined in [\[MS-DTYP\]](#).

Unless otherwise qualified, instances of **GUID** in sections 2 and 3 refer to [MS-DTYP] section 2.3.4.

2.1 Transport

An implementation of this protocol uses the transport infrastructure provided by the underlying implementation of the transaction protocol specified in [\[MS-DTCO\]](#). Therefore, the set of requirements specified in [MS-DTCO] section 2.1 MUST also apply to this protocol.

2.2 Message Syntax

2.2.1 Common Structures

2.2.1.1 MESSAGE_PACKET

The MESSAGE_PACKET structure defines the initial message fields that are contained by all **MTAGs** in this protocol, as specified in [\[MS-CMP\]](#) section 2.2.2.

0	1	2	3	4	5	6	7	8	9	10	11	12	13	14	15	16	17	18	19	20	21	22	23	24	25	26	27	28	29	30	31
MsgTag																															
fIsMaster																															
dwConnectionId																															
dwUserMsgType																															
dwcbVarLenData																															
dwReserved1																															

MsgTag (4 bytes): A 4-byte integer value that describes the OLE **transaction** message type. For all uses in this document, this value MUST be MTAG_USER_MESSAGE, as specified in [MS-CMP] section 2.2.8.

fIsMaster (4 bytes): A 4-byte value that indicates the direction of the message in the conversation.

This value MUST be one of the following values.

Value	Meaning
0x00000000	The message is sent by the party that accepted the connection.
0x00000001	The message is sent by the party that initiated the connection.

dwConnectionId (4 bytes): A 4-byte integer value that MUST contain the unique identifier for the associated **connection**.

dwUserMsgType (4 bytes): This field contains the message type identifier. Each MTAG that is defined in this section MUST specify a distinct value for this field for a specified [connection type](#).

dwcbVarLenData (4 bytes): An unsigned 4-byte integer value that MUST contain the size, in bytes, of the message buffer that contains the MESSAGE_HEADER structure, minus the size, in bytes, of the MESSAGE_HEADER structure itself.

dwReserved1 (4 bytes): Reserved. This value MUST be set to an implementation-specific value and MUST be ignored on receipt.

2.2.1.2 XA_BQUAL_1

The XA_BQUAL_1 structure is used to represent the **XA Branch Qualifier** portion of an **XA Transaction Branch Identifier**.

0	1	2	3	4	5	6	7	8	9	10	11	12	13	14	15	16	17	18	19	20	21	22	23	24	25	26	27	28	29	30	31
XATMGUID (16 bytes)																															
...																															
...																															
RMGUID (16 bytes)																															
...																															
...																															
BranchGUID (16 bytes, optional)																															
...																															
...																															

XATMGUID (16 bytes): This field MUST contain a GUID that specifies the **XA Transaction Manager Identifier** for the **XA Transaction Manager** instance.

RMGUID (16 bytes): This field MUST contain a GUID that specifies the Resource Manager Identifier for the XA Transaction Manager instance.

BranchGUID (16 bytes): This field MAY contain a GUID initialized by the AP that specifies the **XA Branch Identifier** for this **branch**. Whether the AP specifies this or not is implementation-specific. The **BranchGUID** is not used by DTC; however, the **bqualLength** field in the XA_XID structure MUST be specified accordingly as in section [2.2.1.3](#).

2.2.1.3 XA_XID

The XA_XID structure is used to represent an **XA Transaction Branch**. This structure follows the format specified by the technical standard, "Distributed Transaction Processing: The XA Specification", as specified in [\[XOPEN-DTP\]](#). The particular format of the XA_XID structure is used when MSDTC

creates the **XID**, which occurs only in the scenario described in section [1.3.1.2](#). When MSDTC is the **subordinate transaction manager** as in the scenario described in section [1.3.1.1](#), the XID is provided by the superior XA Transaction Manager, and the format of the XID can vary.

0	1	2	3	4	5	6	7	8	9	0	1	2	3	4	5	6	7	8	9	0	1	2	3	4	5	6	7	8	9	0	1
formatID																															
gtridLength																															
bqualLength																															
Data (128 bytes)																															
...																															
...																															

formatID (4 bytes): A 32-bit integer value that MUST contain an **XA Format Identifier** that identifies the format used to interpret the remainder of the XA_XID. It MUST be set to the following value.

0x00445443

gtridLength (4 bytes): An integer value that MUST contain the length in bytes of the **XA Global Transaction Identifier** portion of an XA Transaction Branch Identifier, as stored in the data array. This value MUST be no greater than 64 bytes.

Value	Meaning
16	The size in bytes of a GUID structure. This value is used if the value of formatID is 0x00445443.

bqualLength (4 bytes): An integer value that MUST contain the length, in bytes, of the **XA Branch Qualifier** portion of an XA Transaction Branch Identifier, as stored in the Data array. This value MUST be no greater than 64 bytes.

Value	Meaning
32	The size, in bytes, of a XA_BQUAL_1 structure. If this value is used, the value of formatID MUST be 0x00445443, and the BranchGUID field MUST NOT be present in the XA_BQUAL_1 structure.
48	The size, in bytes, of a XA_BQUAL_1 structure. If this value is used, the value of formatID MUST be 0x00445443, and the BranchGUID field MUST be present in the XA_BQUAL_1 structure.

Data (128 bytes): An array of bytes MUST contain both the XA Global Transaction Identifier and the XA Branch Qualifier portions of an XA Transaction Branch Identifier. The array MUST be 128 bytes in length. The XA Global Transaction Identifier data MUST begin at the first byte in the array. The XA Branch Qualifier data MUST begin at an offset of **gtridLength** bytes into the array. Bytes unused by the XA Global Transaction Identifier or the XA Branch Qualifier MUST be ignored.

If the value of **formatID** is 0x00445443:

- The XA Global Transaction Identifier data MUST contain a GUID that specifies the **transaction identifier**.

- The XA Branch Qualifier data MUST contain an XA_BQUAL_1 structure.

2.2.1.4 XA_UOW

The XA_UOW structure is used to represent a length-qualified **XA Transaction Branch Identifier**.

0	1	2	3	4	5	6	7	8	9	0	1	2	3	4	5	6	7	8	9	0	1	2	3	4	5	6	7	8	9	0	1		
lenXAIdentifier										pad																							
XAIdentifier (140 bytes)																																	
...																																	
...																																	

lenXAIdentifier (1 byte): An 8-bit unsigned value that MUST contain the length in bytes of the XAIdentifier field.

pad (3 bytes): A 3-byte padding field to align the following field to the next 4-byte boundary. Any padding bytes MUST be set to an implementation-specific value, and MUST be ignored on receipt.

XAIdentifier (140 bytes): This field MUST contain an [XA_XID](#) structure that specifies an XA Transaction Branch Identifier.

2.2.2 Enumeration

2.2.2.1 Connection Types

The CONNTYPE enumeration defines the connection types that are used by this protocol.

```
typedef enum
{
    CONNTYPE_XATM_OPEN = 0x00001001,
    CONNTYPE_XATM_ENLIST = 0x00001002,
    CONNTYPE_XATM_OPENONEPIPE = 0x00001003,
    CONNTYPE_XAUSER_CONTROL = 0x00000040,
    CONNTYPE_XAUSER_XACT_START = 0x00000041,
    CONNTYPE_XAUSER_XACT_OPEN = 0x00000042,
    CONNTYPE_XAUSER_XACT_MIGRATE = 0x00000043,
    CONNTYPE_XAUSER_XACT_BRANCH_START = 0x00000050,
    CONNTYPE_XAUSER_XACT_BRANCH_OPEN = 0x00000051,
    CONNTYPE_XAUSER_XACT_MIGRATE2 = 0x00000052
} CONNTYPE;
```

2.2.3 Connection Types Relevant to XA Resource Manager Bridges and XA Resource Manager Bridge Facets

2.2.3.1 Versioning

The following table shows version-specific aspects for [Connection Types \(section 2.2.2.1\)](#) that are relevant to XA Resource Manager Bridges and XA Resource Manager Bridge Facets. This table includes Connection Types and messages that are supported on certain versions as well as messages whose size is version-specific. If a Connection Type or message that is relevant to XA Resource Manager

Bridge and XA Resource Manager Bridge Facet is omitted from this table, it is not version-specific and MUST be supported on all versions.

Version-specific aspect	Version 1	Version 2	Version 4	Version 5	Version 6
Version supports MTAG XATMUSER_MTAG_E_CONFIGLOGWRITEFAILED.		X	X	X	X

2.2.3.2 CONNTYPE_XATM_OPEN

This connection type is used to register a **Two-Pipe XA Resource Manager**.

For more information about CONNTYPE_XATM_OPEN as an initiator and as an acceptor, see [Protocol Details](#) section 3.

2.2.3.2.1 XATMUSER_MTAG_E_RMNONEXISTENT

This message indicates that the request to register an **XA Resource Manager** failed because the XA Resource Manager was not found.

0	1	2	3	4	5	6	7	8	9	10	11	12	13	14	15	16	17	18	19	20	21	22	23	24	25	26	27	28	29	30	31
MsgHeader (24 bytes)																															
...																															
...																															

MsgHeader (24 bytes): This field MUST contain a [MESSAGE_PACKET](#) structure:

- The **dwUserMsgType** field MUST be 0xA0000004.
- The **dwcbVarLenData** field MUST be 0.

2.2.3.2.2 XATMUSER_MTAG_E_RMNOTAVAILABLE

This message indicates that the request to register an **XA Resource Manager** failed because the XA Resource Manager was unavailable.

0	1	2	3	4	5	6	7	8	9	10	11	12	13	14	15	16	17	18	19	20	21	22	23	24	25	26	27	28	29	30	31
MsgHeader (24 bytes)																															
...																															
...																															

MsgHeader (24 bytes): This field MUST contain a [MESSAGE_PACKET](#) structure:

- The **dwUserMsgType** field MUST be 0xA0000005.

- The **dwcbVarLenData** field MUST be 0.

2.2.3.2.3 XATMUSER_MTAG_E_RMOPENFAILED

This message indicates that the request to register an **XA Resource Manager** failed for an unspecified reason.

0	1	2	3	4	5	6	7	8	9	10	11	12	13	14	15	16	17	18	19	20	21	22	23	24	25	26	27	28	29	30	31
MsgHeader (24 bytes)																															
...																															
...																															

MsgHeader (24 bytes): This field MUST contain a [MESSAGE PACKET](#) structure:

- The **dwUserMsgType** field MUST be 0xA0000003.
- The **dwcbVarLenData** field MUST be 0.

2.2.3.2.4 XATMUSER_MTAG_E_RMPROTOCOL

This message indicates that the request to register an **XA Resource Manager** failed because either the registration or a previous attempt to recover returned XAER_PROTO, as specified by the technical standard, "Distributed Transaction Processing: The XA Specification", as specified in [\[XOPEN-DTP\]](#).

0	1	2	3	4	5	6	7	8	9	10	11	12	13	14	15	16	17	18	19	20	21	22	23	24	25	26	27	28	29	30	31
MsgHeader (24 bytes)																															
...																															
...																															

MsgHeader (24 bytes): This field MUST contain a [MESSAGE PACKET](#) structure:

- The **dwUserMsgType** field MUST be 0xA0000007.
- The **dwcbVarLenData** field MUST be 0.

2.2.3.2.5 XATMUSER_MTAG_RMOPEN

This message requests the registration of an **XA Resource Manager**.

0	1	2	3	4	5	6	7	8	9	10	11	12	13	14	15	16	17	18	19	20	21	22	23	24	25	26	27	28	29	30	31
MsgHeader (24 bytes)																															
...																															
...																															

lenDSN
lenXaDll
Recover
DSN (variable)
...
XaDllFileName (variable)
...

MsgHeader (24 bytes): This field MUST contain a [MESSAGE PACKET](#) structure:

- The **dwUserMsgType** field MUST be 0x20000001.
- The **dwcbVarLenData** field MUST be at least 12.

lenDSN (4 bytes): A 32-bit unsigned integer that MUST contain the count of bytes in the **DSN** string that follows this message. It MUST be less than 3072, but it MAY be required to be less than 256. [<1>](#)

lenXaDll (4 bytes): A 32-bit unsigned integer that MUST contain the count of bytes in the **XaDllFileName** string that follows this message. It MUST be less than 256.

Recover (4 bytes): This value MUST be one of the following values.

Value	Meaning
0x00000000	The transaction manager SHOULD NOT perform recovery .
0x00000001	The transaction manager SHOULD perform recovery.

DSN (variable): A Latin-1 ANSI string that indicates the Data Source Name for the XA Resource Manager. It is not necessarily NULL-terminated. It MUST contain a number of bytes equal to the **lenDSN** field of the message.

XaDllFileName (variable): A Latin-1 ANSI string indicating the location of the XA DLL that SHOULD be loaded for the **Resource Manager**. It is not necessarily NULL-terminated. It MUST contain a number of bytes equal to the **lenXaDll** field of the message.

2.2.3.2.6 XATMUSER_MTAG_RMOPENOK

This message indicates the **XA Resource Manager** has been successfully registered.

0	1	2	3	4	5	6	7	8	9	0	1	2	3	4	5	6	7	8	9	0	1	2	3	4	5	6	7	8	9	0	1
MsgHeader (24 bytes)																															
...																															

...
localRmId
guidRm (16 bytes)
...
...

MsgHeader (24 bytes): This field MUST contain a [MESSAGE PACKET](#) structure:

- The **dwUserMsgType** field MUST be 0x20000002.
- The **dwcbVarLenData** field MUST be 20.

localRmId (4 bytes): A 32-bit unsigned integer that MUST contain an **XA Resource Manager Instance Identifier**.

guidRm (16 bytes): This field MUST contain a GUID that specifies a Resource Manager Identifier for the XA Resource Manager.

2.2.3.3 CONNTYPE_XATM_OPENONEPIPE

This connection type is used to register a **one-pipe XA Resource Manager**.

For more information about CONNTYPE_XATM_OPENONEPIPE as an initiator and as an acceptor, see section [3](#).

In addition to the messages listed here, the same set of message types in section [2.2.3.2](#) is sent on this connection type.

2.2.3.3.1 XATMUSER_MTAG_E_CONFIGLOGWRITEFAILED

The XATMUSER_MTAG_E_CONFIGLOGWRITEFAILED packet indicates that the request to register an **XA Resource Manager** failed because the **Transaction Manager** failed to durably record registration information.

0	1	2	3	4	5	6	7	8	9	10	11	12	13	14	15	16	17	18	19	20	21	22	23	24	25	26	27	28	29	30	31
MsgHeader (24 bytes)																															
...																															
...																															

MsgHeader (24 bytes): This field MUST contain a [MESSAGE PACKET](#) structure:

- The **dwUserMsgType** field MUST be 0xA0000008.
- The **dwcbVarLenData** field MUST be 0.

2.2.3.3.2 XATMUSER_MTAG_E_RM_CLOSEFAILED

This message indicates that the request to unregister an **XA Resource Manager** failed because of an unspecified reason.

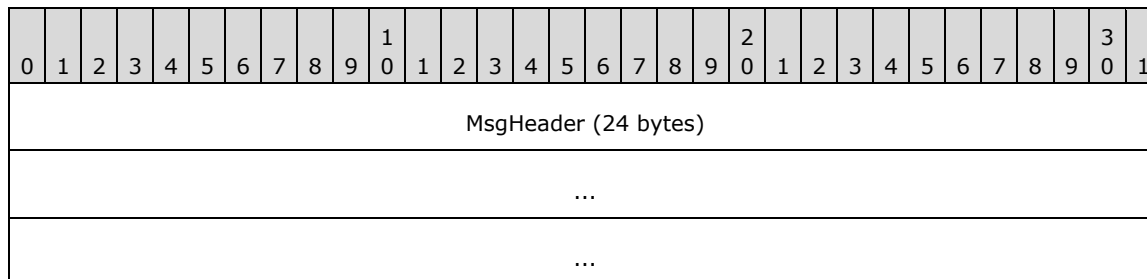

MsgHeader (24 bytes): This field MUST contain a [MESSAGE_PACKET](#) structure:

- The **dwUserMsgType** field MUST be 0x90000003.
- The **dwcbVarLenData** field MUST be 0.

2.2.3.3.3 XATMUSER_MTAG_E_RMCLOSERMNOTAVAILABLE

This message indicates that the request to unregister an **XA Resource Manager** failed because the XA Resource Manager was no longer available.

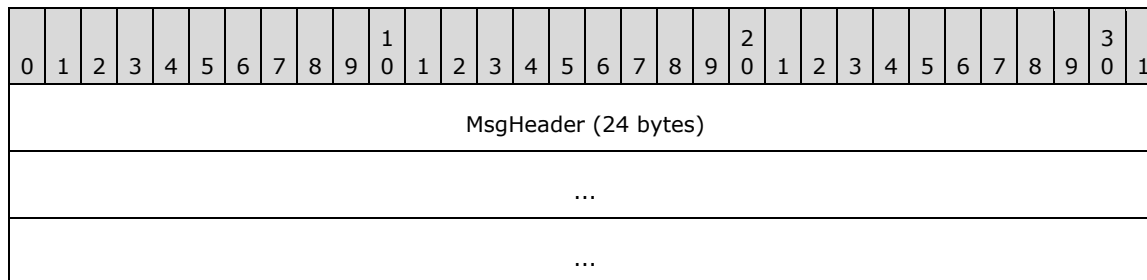

MsgHeader (24 bytes): This field MUST contain a [MESSAGE_PACKET](#) structure:

- The **dwUserMsgType** field MUST be 0x90000004.
- The **dwcbVarLenData** field MUST be 0.

2.2.3.3.4 XATMUSER_MTAG_E_RMCLOSETMERROR

This message indicates that the request to unregister an **XA Resource Manager** failed because the **Transaction Manager** reported an error.

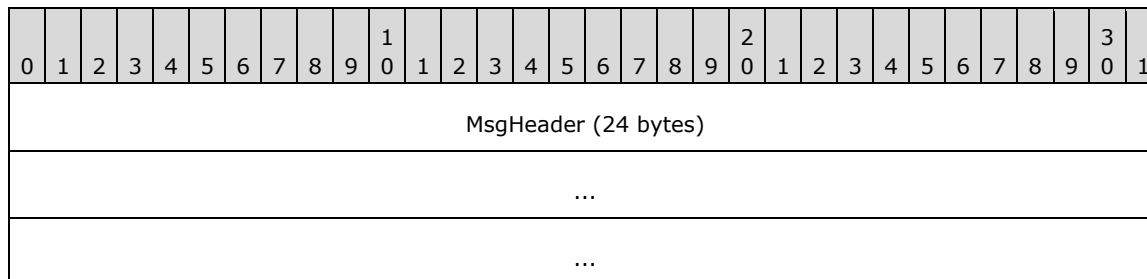

MsgHeader (24 bytes): This field MUST contain a [MESSAGE_PACKET](#) structure:

- The **dwUserMsgType** field MUST be 0x90000006.

- The **dwcbVarLenData** field MUST be 0.

2.2.3.3.5 XATMUSER_MTAG_E_RMCLOSETMNOTAVAILABLE

This message indicates that the request to unregister an **XA Resource Manager** failed because the **Transaction Manager** was no longer available.

0	1	2	3	4	5	6	7	8	9	1	0	1	2	3	4	5	6	7	8	9	2	0	1	2	3	4	5	6	7	8	9	3	0	1
MsgHeader (24 bytes)																																		
...																																		
...																																		

MsgHeader (24 bytes): This field MUST contain a [MESSAGE PACKET](#) structure:

- The **dwUserMsgType** field MUST be 0x90000005.
- The **dwcbVarLenData** field MUST be 0.

2.2.3.3.6 XATMUSER_MTAG_E_RMCLOSEUNEXPECTED

This message indicates that the request to unregister an **XA Resource Manager** failed due to an unexpected error.

0	1	2	3	4	5	6	7	8	9	1	0	1	2	3	4	5	6	7	8	9	2	0	1	2	3	4	5	6	7	8	9	3	0	1
MsgHeader (24 bytes)																																		
...																																		
...																																		

MsgHeader (24 bytes): This field MUST contain a [MESSAGE PACKET](#) structure:

- The **dwUserMsgType** field MUST be 0x90000007.
- The **dwcbVarLenData** field MUST be 0.

2.2.3.3.7 XATMUSER_MTAG_RMCLOSE

This message requests to unregister an **XA Resource Manager**.

0	1	2	3	4	5	6	7	8	9	1	0	1	2	3	4	5	6	7	8	9	2	0	1	2	3	4	5	6	7	8	9	3	0	1
MsgHeader (24 bytes)																																		
...																																		
...																																		

ShutdownAbrupt
Reserved

MsgHeader (24 bytes): This field MUST contain a [MESSAGE_PACKET](#) structure:

- The **dwUserMsgType** field MUST be 0x10000001.
- The **dwcbVarLenData** field MUST be 8.

ShutdownAbrupt (4 bytes): A 32-bit unsigned integer that MUST contain one of the following values to indicate whether this close represents an abrupt termination of the XA Resource Manager.

Value	Meaning
0x00000000	The shutdown is not abrupt.
0x00000001	The shutdown is abrupt.

Reserved (4 bytes): Reserved. This value MUST be set to an implementation-specific value and MUST be ignored on receipt.

2.2.3.3.8 XATMUSER_MTAG_RMCLOSEOK

This message indicates that the **XA Resource Manager** was unregistered successfully.

0	1	2	3	4	5	6	7	8	9	0	1	2	3	4	5	6	7	8	9	0	1	2	3	4	5	6	7	8	9	0	1
MsgHeader (24 bytes)																															
...																															
...																															

MsgHeader (24 bytes): This field MUST contain a [MESSAGE_PACKET](#) structure:

- The **dwUserMsgType** field MUST be 0x10000002.
- The **dwcbVarLenData** field MUST be 0.

2.2.3.4 CONNTYPE_XATM_ENLIST

This connection type is used to enlist an XA Resource Manager into a **transaction**.

For more information about CONNTYPE_XATM_ENLIST as an initiator and as an acceptor, see section [3](#).

2.2.3.4.1 XATMUSER_MTAG_E_ENLISTMENTDUPLICATE

This message indicates that the **enlistment** has failed because the specified **XA Resource Manager** is already enlisted on the **transaction**.

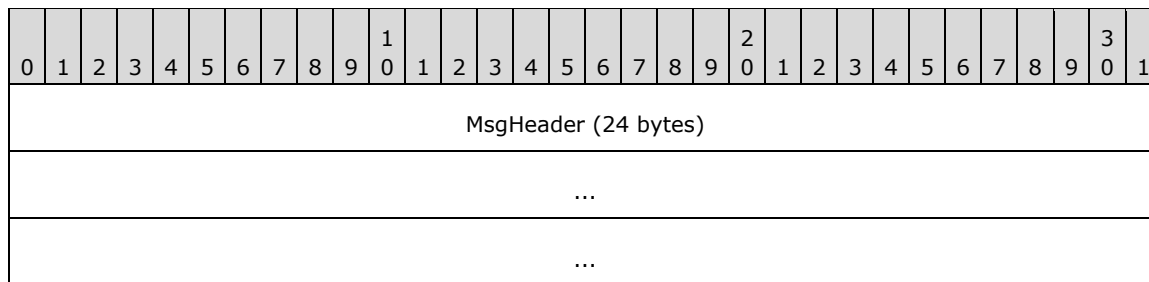

MsgHeader (24 bytes): This field MUST contain a [MESSAGE PACKET](#) structure:

- The **dwUserMsgType** field MUST be 0xC0000006.
- The **dwcbVarLenData** field MUST be 0.

2.2.3.4.2 XATMUSER_MTAG_E_ENLISTMENTFAILED

This message indicates that the **enlistment** has failed for an unspecified reason.

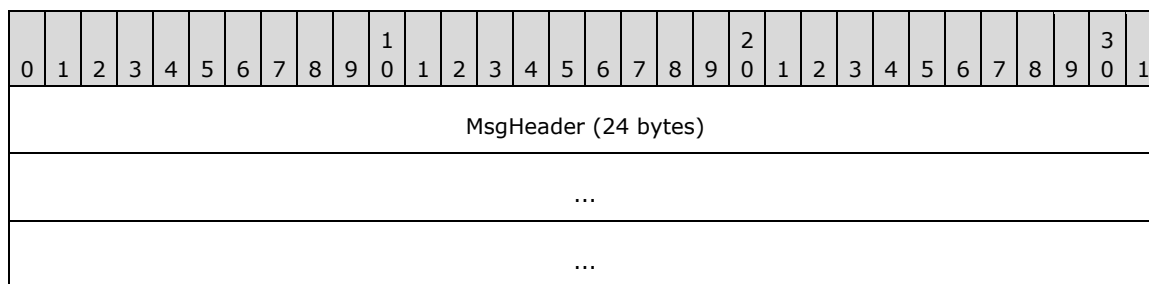

MsgHeader (24 bytes): This field MUST contain a [MESSAGE PACKET](#) structure:

- The **dwUserMsgType** field MUST be 0xC0000005.
- The **dwcbVarLenData** field MUST be 0.

2.2.3.4.3 XATMUSER_MTAG_E_ENLISTMENTIMPFAILED

This message indicates that the **enlistment** has failed because the **Transaction Manager** was unable to import the **transaction** specified by the **ImportCookie** member of the [XATMUSER_MTAG_ENLIST](#) message (section 2.2.3.4.9).

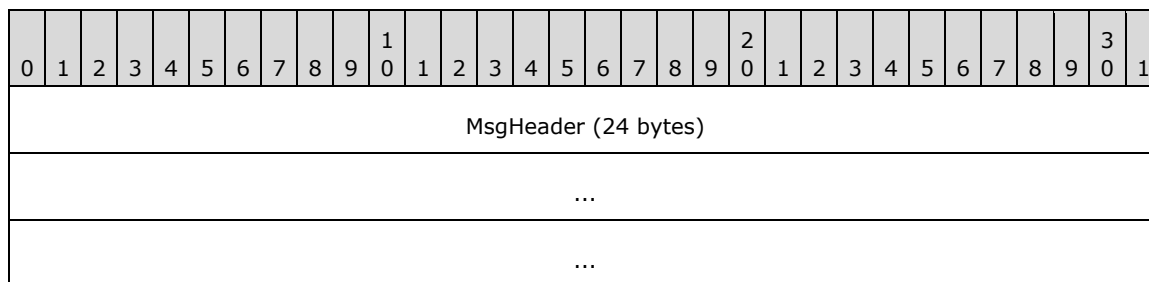

MsgHeader (24 bytes): This field MUST contain a [MESSAGE PACKET](#) structure (section 2.2.1.1):

- The **dwUserMsgType** field MUST be 0xC0000004.
- The **dwcbVarLenData** field MUST be 0.

2.2.3.4.4 XATMUSER_MTAG_E_ENLISTMENTNOMEMORY

This message indicates that the **enlistment** has failed because the **Transaction Manager** was unable to allocate sufficient memory to perform the requested operation.

0	1	2	3	4	5	6	7	8	9	0	1	2	3	4	5	6	7	8	9	0	1	2	3	4	5	6	7	8	9	0	1
MsgHeader (24 bytes)																															
...																															
...																															

MsgHeader (24 bytes): This field MUST contain a [MESSAGE PACKET](#) structure:

- The **dwUserMsgType** field MUST be 0xC0000007.
- The **dwcbVarLenData** field MUST be 0.

2.2.3.4.5 XATMUSER_MTAG_E_ENLISTMENTRMNOTFOUND

This message indicates that the **enlistment** has failed because the enlisting **XA Resource Manager** was not found.

0	1	2	3	4	5	6	7	8	9	0	1	2	3	4	5	6	7	8	9	0	1	2	3	4	5	6	7	8	9	0	1
MsgHeader (24 bytes)																															
...																															
...																															

MsgHeader (24 bytes): This field MUST contain a [MESSAGE PACKET](#) structure:

- The **dwUserMsgType** field MUST be 0xC0000003.
- The **dwcbVarLenData** field MUST be 0.

2.2.3.4.6 XATMUSER_MTAG_E_ENLISTMENTRMRECOVERING

This message indicates that the **enlistment** has failed because the **Transaction Manager** is currently performing **transaction recovery** with the enlisting **XA Resource Manager**.

0	1	2	3	4	5	6	7	8	9	0	1	2	3	4	5	6	7	8	9	0	1	2	3	4	5	6	7	8	9	0	1
MsgHeader (24 bytes)																															
...																															
...																															

MsgHeader (24 bytes): This field MUST contain a [MESSAGE PACKET](#) structure:

- The **dwUserMsgType** field MUST be 0xC0000009.
- The **dwcbVarLenData** field MUST be 0.

2.2.3.4.7 XATMUSER_MTAG_E_ENLISTMENTRMUNAVAILABLE

This message indicates that the enlistment has failed because the enlisting XA Resource Manager is no longer available to complete the enlistment.

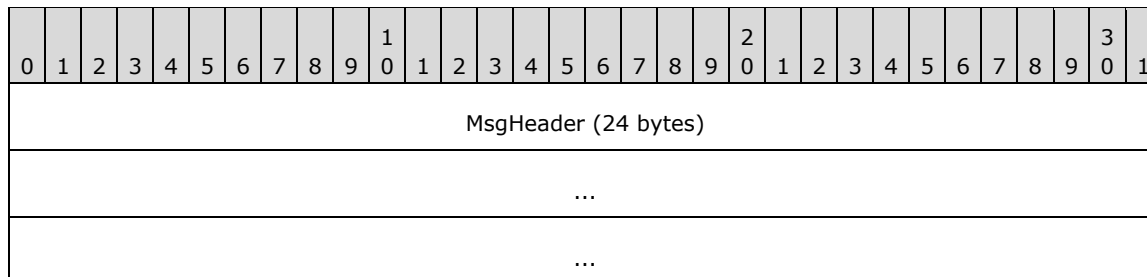

MsgHeader (24 bytes): This field MUST contain a [MESSAGE PACKET](#) structure:

- The **dwUserMsgType** field MUST be 0xC000000A.
- The **dwcbVarLenData** field MUST be 0.

2.2.3.4.8 XATMUSER_MTAG_E_ENLISTMENTTOOLATE

This message indicates that the enlistment has failed because the **transaction** is no longer in the Active or Phase 0 state, and therefore no longer able to accept new enlistments.

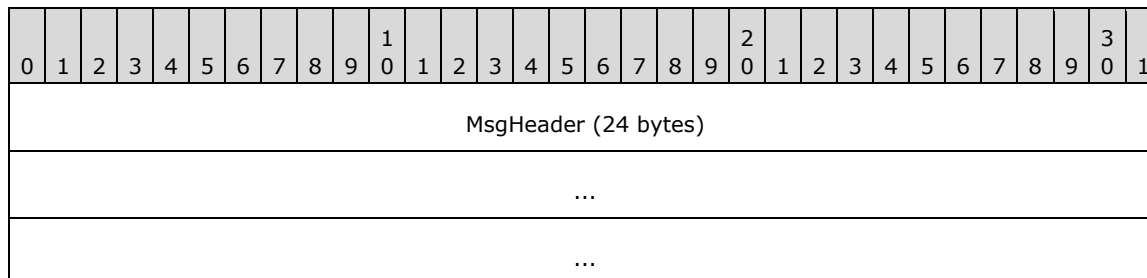

MsgHeader (24 bytes): This field MUST contain a [MESSAGE PACKET](#) structure:

- The **dwUserMsgType** field MUST be 0xC0000008.
- The **dwcbVarLenData** field MUST be 0.

2.2.3.4.9 XATMUSER_MTAG_ENLIST

This message enlists an **XA Resource Manager** into a **transaction**.

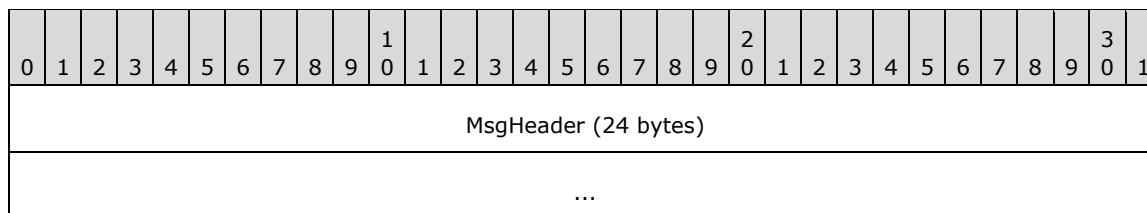

...
guidRm (16 bytes)
...
...
Xid (140 bytes)
...
...
lenImportCookie
ImportCookie (variable)
...

MsgHeader (24 bytes): This field MUST contain a [MESSAGE_PACKET](#) structure:

- The **dwUserMsgType** field MUST be 0x40000001.
- The **dwcbVarLenData** field MUST be greater than 160 (160 bytes, plus the amount for the import cookie member).

guidRm (16 bytes): This field MUST contain a GUID that specifies a resource manager identifier of the XA Resource Manager applying to enlist. There MUST be an open XA Resource Manager that is identified by this resource manager identifier.

Xid (140 bytes): This field MUST contain an [XA_XID](#) structure that specifies an **XA Transaction Branch Identifier**.

lenImportCookie (4 bytes): A 32-bit unsigned integer that MUST contain the size, in bytes, of the import cookie, which is used to determine the transaction in which to enlist.

ImportCookie (variable): This field MUST be a STxInfo structure that specifies the transaction (4) to enlist in. It is present only if the value of the **lenImportCookie** is nonzero.

2.2.3.4.10 XATMUSER_MTAG_ENLISTMENTOK

This message informs the **XA Resource Manager** that the **enlistment** has been successfully processed.

0	1	2	3	4	5	6	7	8	9	10	11	12	13	14	15	16	17	18	19	20	21	22	23	24	25	26	27	28	29	30	31
MsgHeader (24 bytes)																															
...																															
...																															

MsgHeader (24 bytes): This field MUST contain a [MESSAGE_PACKET](#) structure:

- The **dwUserMsgType** field MUST be 0x40000002.
- The **dwcbVarLenData** field MUST be 0.

2.2.4 Connection Types Relevant to XA Superior Transaction Managers and XA Subordinate Transaction Manager Facets

2.2.4.1 Versioning

The following table shows version-specific aspects for [Connection Types](#) that are relevant to [XA Superior Transaction Managers](#) and [XA Subordinate Transaction Manager Facets](#). This table includes Connection Types and messages that are supported on certain versions as well as messages whose size is version-specific. If a Connection Types or message that is relevant to XA Superior Transaction Managers and XA Subordinate Transaction Manager Facets is omitted from this table, it is not version-specific and MUST be supported on all versions. <2>

Version-specific aspect	Version 1	Version 2	Version 4	Version 5	Version 6
Version supports connection type CONNTYPE_XAUSER_XACT_MIGRATE		X	X	X	X
Version supports connection type CONNTYPE_XAUSER_XACT_MIGRATE2				X	X
Version supports connection type CONNTYPE_XAUSER_XACT_BRANCH_START				X	X
Version supports connection type CONNTYPE_XAUSER_XACT_BRANCH_OPEN				X	X

2.2.4.2 CONNTYPE_XAUSER_CONTROL

This connection type is used to create an XA Superior Transaction Manager representation in a **Transaction Manager** and to read from the Transaction Manager the list of XA **transactions** to be recovered.

For more information about CONNTYPE_XAUSER_CONTROL as an initiator and as an acceptor, see section [3](#).

This connection type uses the following message types.

2.2.4.2.1 XAUSER_CONTROL_MTAG_CREATE

This message creates an XA Superior Transaction Manager representation in a **Transaction Manager**.

0	1	2	3	4	5	6	7	8	9	1	0	1	2	3	4	5	6	7	8	9	2	0	1	2	3	4	5	6	7	8	9	3	0	1
MsgHeader (24 bytes)																																		
...																																		

...
guidXaRm (16 bytes)
...
...

MsgHeader (24 bytes): This field MUST contain a [MESSAGE PACKET](#) structure:

- The **dwUserMsgType** field MUST be 0x00004001.
- The **dwcbVarLenData** field MUST be 16.

guidXaRm (16 bytes): This field MUST contain the **XA Superior Transaction Manager Identifier** for the XA Superior Transaction Manager.

2.2.4.2.2 XAUSER_CONTROL_MTAG_CREATE_NO_MEM

This message indicates that the request to create an XA Superior Transaction Manager representation failed due to lack of memory.

0	1	2	3	4	5	6	7	8	9	10	11	12	13	14	15	16	17	18	19	20	21	22	23	24	25	26	27	28	29	30	31
MsgHeader (24 bytes)																															
...																															
...																															

MsgHeader (24 bytes): This field MUST contain a [MESSAGE PACKET](#) structure:

- The **dwUserMsgType** field MUST be 0x00004006.
- The **dwcbVarLenData** field MUST be 0.

2.2.4.2.3 XAUSER_CONTROL_MTAG_CREATED

This message indicates that the request to create an XA Superior Transaction Manager representation has completed successfully.

0	1	2	3	4	5	6	7	8	9	10	11	12	13	14	15	16	17	18	19	20	21	22	23	24	25	26	27	28	29	30	31
MsgHeader (24 bytes)																															
...																															
...																															

MsgHeader (24 bytes): This field MUST contain a [MESSAGE PACKET](#) structure:

- The **dwUserMsgType** field MUST be 0x00004002.

- The **dwcbVarLenData** field MUST be 0.

2.2.4.2.4 XAUSER_CONTROL_MTAG_RECOVER

This message discovers which XA **transactions** need **recovery**.

0	1	2	3	4	5	6	7	8	9	10	11	12	13	14	15	16	17	18	19	20	21	22	23	24	25	26	27	28	29	30	31
MsgHeader (24 bytes)																															
...																															
RequestFlags																															
totalUOWsRequested																															

MsgHeader (24 bytes): This field MUST contain a [MESSAGE_PACKET](#) structure:

- The **dwUserMsgType** field MUST be 0x00004003.
- The **dwcbVarLenData** field MUST be 8.

RequestFlags (4 bytes): Flags that control the scan performed by the Transaction Manager for XA transactions in need of recovery. It MUST be a bitwise OR operator of one or more the following flags.

Value	Meaning
XARECOVER_START_SCAN 0x00000001	The Transaction Manager MUST begin a new session to scan for transactions in need of recovery.
XARECOVER_END_SCAN 0x00000002	The Transaction Manager MUST end the current session being used to scan for transactions in need of recovery.
XARECOVER_CONTINUE_SCAN 0x00000004	The Transaction Manager MUST continue the current session being used to scan for transactions in need of recovery. This flag is assumed to be set if no other flag is set.

totalUOWsRequested (4 bytes): A 32-bit unsigned integer that MUST contain the requested number of XA transactions that need recovery. This value SHOULD be less than or equal to 5. <3>

2.2.4.2.5 XAUSER_CONTROL_MTAG_RECOVER_NO_MEM

This message indicates the **recovery** request failed due to lack of memory.

0	1	2	3	4	5	6	7	8	9	10	11	12	13	14	15	16	17	18	19	20	21	22	23	24	25	26	27	28	29	30	31
MsgHeader (24 bytes)																															
...																															

...

MsgHeader (24 bytes): This field MUST contain a [MESSAGE_PACKET](#) structure:

- The **dwUserMsgType** field MUST be 0x00004004.
- The **dwcbVarLenData** field MUST be 0.

2.2.4.2.6 XAUSER_CONTROL_MTAG_RECOVER_REPLY

This message indicates that the **recovery** request has completed successfully.

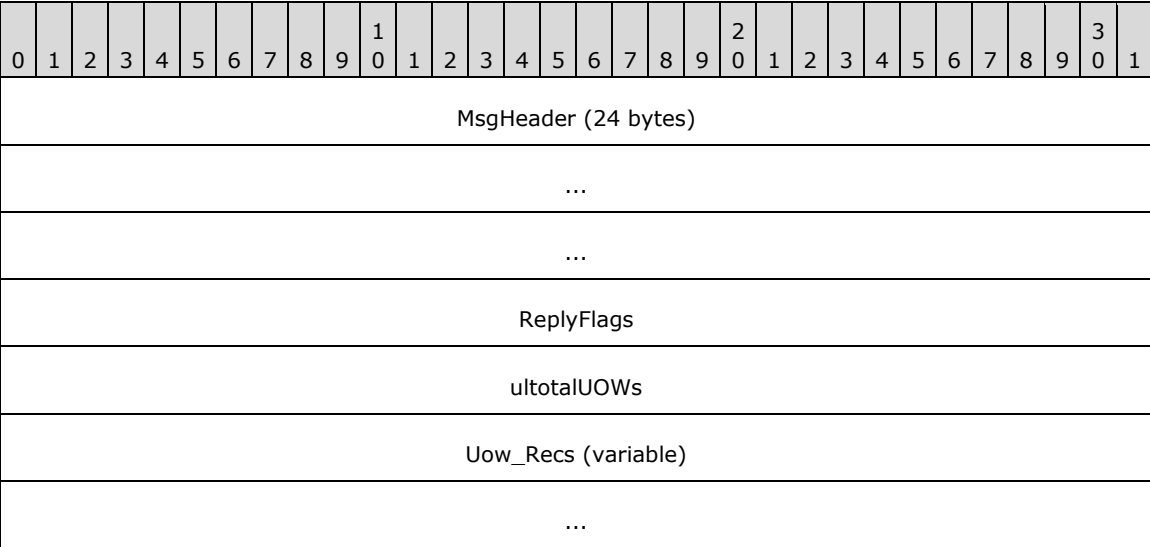

MsgHeader (24 bytes): This field MUST contain a [MESSAGE_PACKET](#) structure:

- The **dwUserMsgType** field MUST be 0x00004005.
- The **dwcbVarLenData** field MUST be 8 bytes plus the number of bytes in the **Uow_Recs** array.

ReplyFlags (4 bytes): Flags that indicate whether more unrecovered **transactions** remain. It MUST be one of the following flags.

Value	Meaning
XARECOVER_MORE_TO_COME 0x00000001	Not all recovered transactions have been scanned.
XARECOVER_END_OF_RECS 0x00000002	All recovered transactions have been scanned.

ultotalUOWs (4 bytes): A 32-bit unsigned integer that MUST contain the count of elements in the Uow_Recs array, each of which represents an XA transaction in need of recovery. This value SHOULD [<4>](#) match the **totalUOWsRequested** value in the previous XAUSER_CONTROL_MTAG_RECOVER message (section [2.2.4.2.4](#)), unless the scan has completed, in which case the **ultotalUOWs** value could be less, depending on the number of transactions that remain to be recovered.

Uow_Recs (variable): An array of [XA UOW](#) structures. The number of elements in the array MUST be equal to **ultotalUOWs** plus 5. The last 5 elements are reserved, MUST be set to implementation-specific values, and MUST be ignored on receipt.

2.2.4.3 CONNTYPE_XAUSER_XACT_START

This connection type is used to start a **loosely-coupled XA Transaction Branch**.

For more information about CONNTYPE_XAUSER_XACT_START as an initiator and as an acceptor, see section [3](#).

2.2.4.3.1 XAUSER_XACT_MTAG_START

This message creates an **XA Transaction Branch**.

0	1	2	3	4	5	6	7	8	9	0	1	2	3	4	5	6	7	8	9	0	1	2	3	4	5	6	7	8	9	0	1
MsgHeader (24 bytes)																															
...																															
...																															
guidXaRm (16 bytes)																															
...																															
...																															
XAUow (144 bytes)																															
...																															
...																															
isoLevel (optional)																															
Timeout (optional)																															
szDesc (40 bytes, optional)																															
...																															
...																															
isoFlags (optional)																															

MsgHeader (24 bytes): This field MUST contain a [MESSAGE PACKET](#) structure:

- The **dwUserMsgType** field MUST be 0x00004010.
- The **dwcbVarLenData** field MUST be one of the following:

Value	Meaning
160	The isoLevel , Timeout , szDesc , and isoFlags fields are not present in the message.
212	The isoLevel , Timeout , szDesc , and isoFlags fields are present in the message.

guidXaRm (16 bytes): This field MUST contain a GUID that specifies an **XA Superior Transaction Manager Identifier** for the XA Superior **Transaction Manager**.

XAUow (144 bytes): This field MUST contain an [XA_UOW](#) structure that specifies a length-qualified **XA Transaction Branch Identifier**.

isoLevel (4 bytes): This field MUST contain one value from the OLETX_ISOLATION_LEVEL enumeration (as specified in [\[MS-DTCO\]](#)) that specifies the isolation level of the **transaction**. It is present only when the **dwcbVarLenData** field is set to 212.

Timeout (4 bytes): A 32-bit unsigned integer value that MUST contain the time-out value, in milliseconds, for the transaction. A value of zero MUST be interpreted as an infinite time-out. A transaction SHOULD NOT abort due to time-out before the time-out that is specified by this value has expired. This field is present only when the **dwcbVarLenData** field is set to 212. [<5>](#)

szDesc (40 bytes): The description of the transaction, as a fixed-size array of 40 bytes that contains a null-terminated Latin-1 ANSI string, as specified in [\[ISO/IEC-8859-1\]](#). This field MUST be set to an implementation-specific value. Any bytes that follow the first null-terminator character SHOULD be set to zero, and MUST be ignored on receipt. It is present only when the **dwcbVarLenData** field is set to 212.

isoFlags (4 bytes): The isolation flags for the transaction. This field MUST contain the bitwise OR operator of zero or more values from the OLETX_ISOLATION_FLAGS enumeration (as specified in [\[MS-DTCO\]](#)). It is present only when the **dwcbVarLenData** field is set to 212.

2.2.4.3.2 XAUSER_XACT_MTAG_START_DUPLICATE

This message indicates that the request to create an **XA Transaction Branch** failed because an XA Transaction Branch with the same **XA Transaction Branch Identifier** already exists.

0	1	2	3	4	5	6	7	8	9	10	11	12	13	14	15	16	17	18	19	20	21	22	23	24	25	26	27	28	29	30	31
MsgHeader (24 bytes)																															
...																															
...																															

MsgHeader (24 bytes): This field MUST contain a [MESSAGE_PACKET](#) structure:

- The **dwUserMsgType** field MUST be 0x00004021.
- The **dwcbVarLenData** field MUST be 0.

2.2.4.3.3 XAUSER_XACT_MTAG_START_LOG_FULL

This message indicates that the request to create an **XA Transaction Branch** failed because of lack of log space.

0	1	2	3	4	5	6	7	8	9	10	11	12	13	14	15	16	17	18	19	20	21	22	23	24	25	26	27	28	29	30	31
MsgHeader (24 bytes)																															
...																															
...																															

MsgHeader (24 bytes): This field MUST contain a [MESSAGE_PACKET](#) structure:

- The **dwUserMsgType** field MUST be 0x00004020.
- The **dwcbVarLenData** field MUST be 0.

2.2.4.3.4 XAUSER_XACT_MTAG_START_NO_MEM

This message indicates that the request to create an **XA Transaction Branch** failed because of lack of memory.

0	1	2	3	4	5	6	7	8	9	10	11	12	13	14	15	16	17	18	19	20	21	22	23	24	25	26	27	28	29	30	31
MsgHeader (24 bytes)																															
...																															
...																															

MsgHeader (24 bytes): This field MUST contain a [MESSAGE_PACKET](#) structure:

- The **dwUserMsgType** field MUST be 0x00004019.
- The **dwcbVarLenData** field MUST be 0.

2.2.4.3.5 XAUSER_XACT_MTAG_STARTED

This message indicates that the request to create an **XA Transaction Branch** has completed successfully.

0	1	2	3	4	5	6	7	8	9	10	11	12	13	14	15	16	17	18	19	20	21	22	23	24	25	26	27	28	29	30	31
MsgHeader (24 bytes)																															
...																															
...																															
guidTx (16 bytes)																															
...																															
...																															

MsgHeader (24 bytes): This field MUST contain a [MESSAGE PACKET](#) structure:

- The **dwUserMsgType** field MUST be 0x00004011.
- The **dwcbVarLenData** field MUST be 16.

guidTx (16 bytes): This field MUST contain a GUID that specifies the **transaction identifier**.

2.2.4.4 CONNTYPE_XAUSER_XACT_BRANCH_START

This connection type is used to start a **tightly-coupled XA Transaction Branch**.

For more information about CONNTYPE_XAUSER_XACT_BRANCH_START as an initiator, see section [3.3.5.5](#), and as an acceptor, see section [3.2.5.5](#).

The same set of message types in section [2.2.4.3](#) are sent on this connection type.

2.2.4.5 CONNTYPE_XAUSER_XACT_OPEN

This connection type is used to open a **loosely-coupled XA Transaction Branch** for exchanging transactional information.

For more details on CONNTYPE_XAUSER_XACT_OPEN as an initiator and as an acceptor, see section [3](#).

2.2.4.5.1 XAUSER_XACT_MTAG_ABORT

This message requests an attempt to abort the **XA Transaction Branch**.

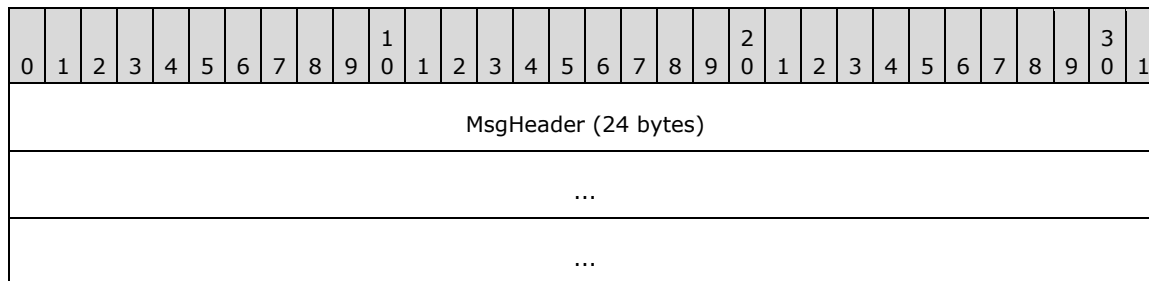

MsgHeader (24 bytes): This field MUST contain a [MESSAGE PACKET](#) structure:

- The **dwUserMsgType** field MUST be 0x00004014.
- The **dwcbVarLenData** field MUST be 0.

2.2.4.5.2 XAUSER_XACT_MTAG_COMMIT

This message requests an attempt to commit the **XA Transaction Branch**.

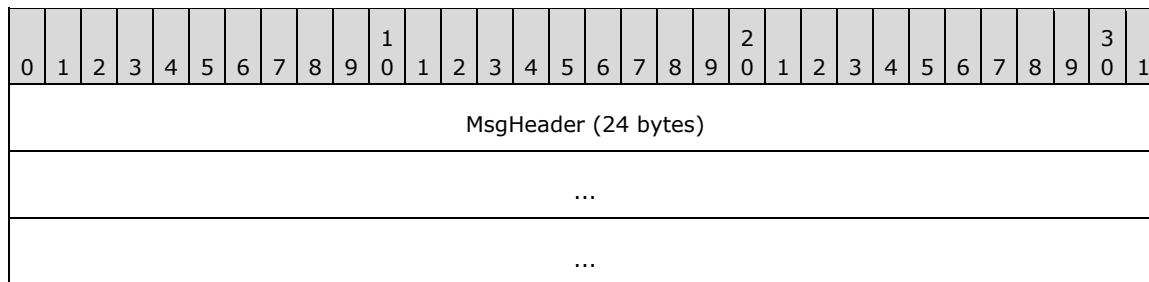

MsgHeader (24 bytes): This field MUST contain a [MESSAGE_PACKET](#) structure:

- The **dwUserMsgType** field MUST be 0x00004016.
- The **dwcbVarLenData** field MUST be 0.

2.2.4.5.3 XAUSER_XACT_MTAG_OPEN

This message opens an **XA Transaction Branch** to exchange transactional information.

0	1	2	3	4	5	6	7	8	9	10	11	12	13	14	15	16	17	18	19	20	21	22	23	24	25	26	27	28	29	30	31
MsgHeader (24 bytes)																															
...																															
...																															
guidXaRm (16 bytes)																															
...																															
...																															
XAUow (144 bytes)																															
...																															
...																															

MsgHeader (24 bytes): This field MUST contain a [MESSAGE_PACKET](#) structure:

- The **dwUserMsgType** field MUST be 0x00004012.
- The **dwcbVarLenData** field MUST be 160.

guidXaRm (16 bytes): This field MUST be a GUID that specifies an **XA Superior Transaction Manager Identifier** for the XA Superior **Transaction Manager**.

XAUow (144 bytes): This field MUST contain an [XA_UOW](#) structure that specifies a length-qualified **XA Transaction Branch Identifier**.

2.2.4.5.4 XAUSER_XACT_MTAG_OPEN_NOT_FOUND

This message indicates that the request to open an **XA Transaction Branch** failed because the **transaction** could not be found.

0	1	2	3	4	5	6	7	8	9	10	11	12	13	14	15	16	17	18	19	20	21	22	23	24	25	26	27	28	29	30	31
MsgHeader (24 bytes)																															
...																															

...

MsgHeader (24 bytes): This field MUST contain a [MESSAGE PACKET](#) structure:

- The **dwUserMsgType** field MUST be 0x00004022.
- The **dwcbVarLenData** field MUST be 0.

2.2.4.5.5 XAUSER_XACT_MTAG_OPENED

This message indicates that the request to open an **XA Transaction Branch** has completed successfully.

0	1	2	3	4	5	6	7	8	9	10	11	12	13	14	15	16	17	18	19	20	21	22	23	24	25	26	27	28	29	30	31
MsgHeader (24 bytes)																															
...																															
...																															
guidTx (16 bytes)																															
...																															
...																															

MsgHeader (24 bytes): This field MUST contain a [MESSAGE PACKET](#) structure:

- The **dwUserMsgType** field MUST be 0x00004013.
- The **dwcbVarLenData** field MUST be 16.

guidTx (16 bytes): This field MUST contain a GUID that specifies the **transaction identifier**.

2.2.4.5.6 XAUSER_XACT_MTAG_PREPARE

This message requests an attempt to prepare the **XA Transaction Branch**.

0	1	2	3	4	5	6	7	8	9	10	11	12	13	14	15	16	17	18	19	20	21	22	23	24	25	26	27	28	29	30	31
MsgHeader (24 bytes)																															
...																															
...																															
fSinglePhase																															

MsgHeader (24 bytes): This field MUST contain a [MESSAGE PACKET](#) structure:

- The **dwUserMsgType** field MUST be 0x00004015.

- The **dwcbVarLenData** field MUST be 4.

fSinglePhase (4 bytes): A value that indicates whether the XA Superior Transaction Manager wants to do Single-Phase Commit.

It MUST be one of the following values:

Value	Meaning
0x00000000	Single-Phase Commit is not allowed.
0x00000001	Single-Phase Commit is allowed. The transaction manager can do a Single-Phase Commit of the XA Transaction Branch.

2.2.4.5.7 XAUSER_XACT_MTAG_PREPARE_ABORT

This message indicates that the **Transaction Manager** is preparing to abort the **XA Transaction Branch**.

0	1	2	3	4	5	6	7	8	9	10	11	12	13	14	15	16	17	18	19	20	21	22	23	24	25	26	27	28	29	30	31
MsgHeader (24 bytes)																															
...																															
...																															

MsgHeader (24 bytes): This field MUST contain a [MESSAGE_PACKET](#) structure:

- The **dwUserMsgType** field MUST be 0x00004023.
- The **dwcbVarLenData** field MUST be 0.

2.2.4.5.8 XAUSER_XACT_MTAG_PREPARE_SINGLEPHASE_INDOUBT

This message indicates that an attempt was made to do a Single-Phase Commit, but there was a failure that has prevented the **Transaction Manager** from determining the **outcome** of the **XA Transaction Branch**.

0	1	2	3	4	5	6	7	8	9	10	11	12	13	14	15	16	17	18	19	20	21	22	23	24	25	26	27	28	29	30	31
MsgHeader (24 bytes)																															
...																															
...																															

MsgHeader (24 bytes): This field MUST contain a [MESSAGE_PACKET](#) structure:

- The **dwUserMsgType** field MUST be 0x00004024.
- The **dwcbVarLenData** field MUST be 0.

2.2.4.5.9 XAUSER_XACT_MTAG_REQUEST_COMPLETED

This message indicates that the previous request was completed successfully.

0	1	2	3	4	5	6	7	8	9	0	1	2	3	4	5	6	7	8	9	0	1	2	3	4	5	6	7	8	9	0	1
MsgHeader (24 bytes)																															
...																															
...																															

MsgHeader (24 bytes): This field MUST contain a [MESSAGE_PACKET](#) structure:

- The **dwUserMsgType** field MUST be 0x00004017.
- The **dwcbVarLenData** field MUST be 0.

2.2.4.5.10 XAUSER_XACT_MTAG_REQUEST_FAILED_BAD_PROTOCOL

This message indicates that the previous request failed because of an error in the protocol.

0	1	2	3	4	5	6	7	8	9	0	1	2	3	4	5	6	7	8	9	0	1	2	3	4	5	6	7	8	9	0	1
MsgHeader (24 bytes)																															
...																															
...																															

MsgHeader (24 bytes): This field MUST contain a [MESSAGE_PACKET](#) structure:

- The **dwUserMsgType** field MUST be 0x00004018.
- The **dwcbVarLenData** field MUST be 0.

2.2.4.6 CONNTYPE_XAUSER_XACT_BRANCH_OPEN

This connection type is used to open a **tightly-coupled XA Transaction Branch** to exchange transactional information.

XAUSER_XACT_MTAG_READONLY is sent on this connection type, in addition to the set of message types in section [2.2.4.5](#).

For more information about CONNTYPE_XAUSER_XACT_BRANCH_OPEN as an initiator and as an acceptor, see section [3](#).

2.2.4.6.1 XAUSER_XACT_MTAG_READONLY

This message indicates that the request to prepare the **XA Transaction Branch** for commitment was successful and no further involvement in the XA Transaction Branch is required.

0	1	2	3	4	5	6	7	8	9	10	11	12	13	14	15	16	17	18	19	20	21	22	23	24	25	26	27	28	29	30	31
MsgHeader (24 bytes)																															
...																															
...																															

MsgHeader (24 bytes): This field MUST contain a [MESSAGE PACKET](#) structure:

- The **dwUserMsgType** field MUST be 0x00004030.
- The **dwcbVarLenData** field MUST be 0.

2.2.4.7 CONNTYPE_XAUSER_XACT_MIGRATE

This connection type is used to migrate an **XA Transaction Branch** between threads of control. In addition to the messages defined in this section, [XAUSER_XACT_MTAG_OPEN_NOT_FOUND \(section 2.2.4.5.4\)](#) is also sent on this connection type.

For more information about CONNTYPE_XAUSER_XACT_MIGRATE as an initiator and as an acceptor, see section [3](#).

2.2.4.7.1 XAUSER_XACT_MTAG_RESUME

This message resumes an **XA Transaction Branch** on a thread of control.

0	1	2	3	4	5	6	7	8	9	10	11	12	13	14	15	16	17	18	19	20	21	22	23	24	25	26	27	28	29	30	31
MsgHeader (24 bytes)																															
...																															
...																															
lenXAIdentifier														padding																	
guidXaRm (16 bytes)																															
...																															
...																															
XAIdentifier (140 bytes)																															
...																															
...																															
dwProcessID																															

dwThreadID

MsgHeader (24 bytes): This field MUST contain a [MESSAGE_PACKET](#) structure:

- The **dwUserMsgType** field MUST be 0x00004027.
- The **dwcbVarLenData** field MUST be 168.

lenXAIdentifier (1 byte): An 8-bit unsigned value that MUST contain the length in bytes of the **XAIdentifier** field. The end of this field MUST be padded to the next 4-byte boundary.

padding (3 bytes): Padding to the next 4-byte boundary. Each padding byte MUST be set to an implementation-specific value, and MUST be ignored on receipt.

guidXaRm (16 bytes): This field MUST contain a GUID that specifies an **XA Superior Transaction Manager Identifier** for the XA Superior **Transaction Manager**.

XAIdentifier (140 bytes): This field MUST contain an [XA_XID](#) structure that specifies an **XA Transaction Branch Identifier**.

dwProcessID (4 bytes): A 32-bit unsigned integer that MUST specify the process identifier of the process that is sending the message and MUST be ignored on receipt.

dwThreadID (4 bytes): A 32-bit unsigned integer that MUST specify the thread identifier of the thread of control that is sending the message and MUST be ignored on receipt.

2.2.4.7.2 XAUSER_XACT_MTAG_RESUME_DONE

This message indicates that the **XA Transaction Branch** was successfully resumed.

0	1	2	3	4	5	6	7	8	9	1	0	1	2	3	4	5	6	7	8	9	2	0	1	2	3	4	5	6	7	8	9	3	0	1
MsgHeader (24 bytes)																																		
...																																		
...																																		

MsgHeader (24 bytes): This field MUST contain a [MESSAGE_PACKET](#) structure:

- The **dwUserMsgType** field MUST be 0x00004028.
- The **dwcbVarLenData** field MUST be 0.

2.2.4.7.3 XAUSER_XACT_MTAG_SUSPEND_WITH_MIGRATE

This message suspends an **XA Transaction Branch** on a thread of control for migration.

0	1	2	3	4	5	6	7	8	9	1	0	1	2	3	4	5	6	7	8	9	2	0	1	2	3	4	5	6	7	8	9	3	0	1
MsgHeader (24 bytes)																																		
...																																		

...	
lenXAIdentifier	padding
guidXaRm (16 bytes)	
...	
...	
XAIdentifier (140 bytes)	
...	
...	
dwProcessID	
dwThreadID	

MsgHeader (24 bytes): This field MUST contain a [MESSAGE_PACKET](#) structure:

- The **dwUserMsgType** field MUST be 0x00004025.
- The **dwcbVarLenData** field MUST be 168.

lenXAIdentifier (1 byte): An 8-bit unsigned value that MUST contain the length in bytes of the **XAIdentifier** field. The end of this field MUST be padded to the next 4-byte boundary.

padding (3 bytes): Padding to the next 4-byte boundary. Each padding byte MUST be set to an implementation-specific value, and MUST be ignored on receipt.

guidXaRm (16 bytes): This field MUST contain a GUID that specifies an **XA Superior Transaction Manager Identifier**.

XAIdentifier (140 bytes): This field MUST contain an [XA_XID](#) structure that specifies an **XA Transaction Branch Identifier**.

dwProcessID (4 bytes): A 32-bit unsigned integer that MUST specify the process identifier of the process that sends the message and MUST be ignored on receipt.

dwThreadID (4 bytes): A 32-bit unsigned integer that MUST specify the thread identifier of the thread of control that sends the message and MUST be ignored on receipt.

2.2.4.7.4 XAUSER_XACT_MTAG_SUSPEND_WITH_MIGRATE_DONE

This message indicates that the **XA Transaction Branch** was successfully suspended for migration.

0	1	2	3	4	5	6	7	8	9	10	11	12	13	14	15	16	17	18	19	20	21	22	23	24	25	26	27	28	29	30	31
MsgHeader (24 bytes)																															
...																															

...

MsgHeader (24 bytes): This field MUST contain a [MESSAGE_PACKET](#) structure:

- The **dwUserMsgType** field MUST be 0x00004026.
- The **dwcbVarLenData** field MUST be 0.

2.2.4.7.5 XAUSER_XACT_MTAG_TRANSACTION_NOT_SUSPENDED

This message indicates that the requested **XA Transaction Branch** is not currently suspended.

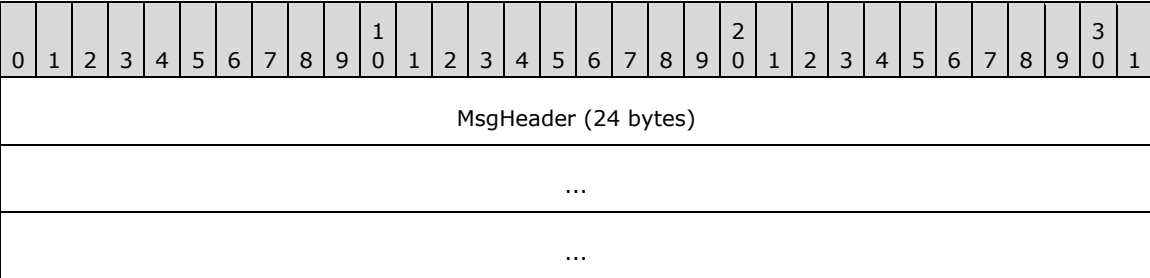

MsgHeader (24 bytes): This field MUST contain a [MESSAGE_PACKET](#) structure:

- The **dwUserMsgType** field MUST be 0x00004029.
- The **dwcbVarLenData** field MUST be 0.

2.2.4.8 CONNTYPE_XAUSER_XACT_MIGRATE2

This connection type is used to migrate an **XA Transaction Branch** between threads of control.

This connection type supersedes CONNTYPE_XAUSER_XACT_MIGRATE.

For more information about CONNTYPE_XAUSER_XACT_MIGRATE2 as an initiator and as an acceptor, see section [3](#).

The same set of message types in section [2.2.4.7](#) are sent on this connection type. The syntax of XAUSER_XACT_MTAG_RESUME_DONE is different to support cross-processes migration, as specified in section [2.2.4.8.1](#).

2.2.4.8.1 XAUSER_XACT_MTAG_RESUME_DONE

This message indicates that the **XA Transaction Branch** was successfully resumed.

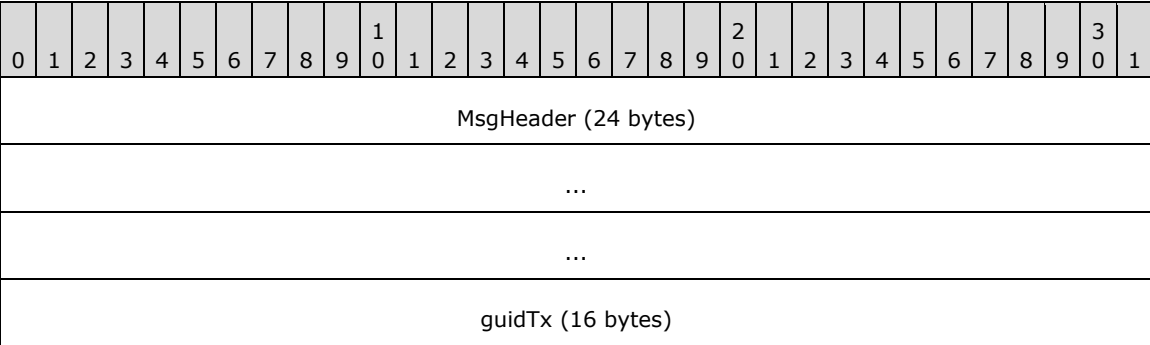

...
...

MsgHeader (24 bytes): This field MUST contain a [MESSAGE_PACKET](#) structure:

- The **dwUserMsgType** field MUST be 0x00004028.
- The **dwcbVarLenData** field MUST be 16.

guidTx (16 bytes): This field MUST contain a GUID that specifies the **transaction identifier**.

3 Protocol Details

The following sections specify details of the MSDTC Connection Manager: OleTx XA Protocol, including abstract data models, interface method syntax, and message processing rules.

3.1 Common Details

This section defines common details for the **transaction participants**, as specified in sections [3.2](#) through [3.5](#). Each participant **MUST** conform to the details as specified in this section.

3.1.1 Abstract Data Model

This section describes a conceptual model of possible data organization that an implementation maintains to participate in this protocol. The described organization is provided to facilitate the explanation of how the protocol behaves. This document does not mandate that implementations adhere to this model as long as their external behavior is consistent with the behavior that is described in this document.

Note that the abstract data model can be implemented in a variety of ways. This protocol does not prescribe or advocate any specific implementation technique.

A **participant** **MUST** maintain all the data elements as specified in [\[MS-CMP\]](#) section 3.1.1.

Participants **MUST** use [\[MS-CMP\]](#) connections as a transport protocol for sending messages. Section [2.1](#) defines the mechanisms by which this protocol initializes and makes use of the [\[MS-CMP\]](#).

A participant **MUST** extend the definition of a connection object, as specified in [\[MS-CMP\]](#), section 3.1.1.1, to include the following data elements:

- **State**: A state enumeration that represents the current state of the connection.

A **State** enumeration **MUST** contain a set of values that represent specific states in a logical state machine. For a **connection** type, these values represent the different states to which the connection's logical state machine is set during the lifetime of the connection.

When a participant initiates or accepts a connection, the **State** field of the connection **MUST** be set initially to the Idle state. When the participant acting as an initiator signals the [Disconnect Connection](#) event the connection state **MUST** be set to Ended. When a participant is acting as an acceptor, the connection state is set to Ended as part of the [Connection Disconnected](#) event processing as described in section 3.1.8.2.

A participant **MUST** support both initiating and accepting multiple concurrent connections of any type inside the same [\[MS-DTCO\]](#) session or different [\[MS-DTCO\]](#) sessions, as specified in [\[MS-CMPO\]](#). Consequently, a participant **MUST** support the existence of multiple instances of a single connection of the same type. A participant **MUST** also support initiating multiple concurrent sessions to a number of different endpoints.

A participant **MUST** maintain the following data elements:

- **XA Transaction Manager GUID**: A **GUID** used to uniquely identify an **XA Transaction Manager**. This value must be maintained through failure and **recovery**.

3.1.2 Timers

None.

3.1.3 Initialization

Initialization occurs as specified in [\[MS-DTCO\]](#) section 3.1.3.

The **XA Transaction Manager GUID** MUST be set to a value that is obtained from an implementation-specific source.

3.1.4 Protocol Versioning Details

The versioning details of the OleTx Transports Protocol messages are specified in [\[MS-DTCO\]](#) section 3.1.4.

3.1.5 Higher-Layer Triggered Events

None.

3.1.6 Processing Events and Sequencing Rules

As specified in [\[MS-DTCO\]](#) section 3.1.6.

3.1.7 Timer Events

None.

3.1.8 Other Local Events

3.1.8.1 Disconnect Connection

The **Disconnect Connection** event MUST be signaled with the following argument:

- A Connection object.

Set the connection state to Ended and continue processing as specified in [\[MS-DTCO\]](#) section 3.1.8.2.

3.1.8.2 Connection Disconnected

The **Connection Disconnected** event MUST be signaled with the following argument:

- A Connection object.

This event for all connection types specified in section [3](#) MUST be processed as specified in [\[MS-DTCO\]](#) section 3.1.8.3. If there are extra processing steps necessary for a specific connection type, they are called out in the relevant section.

3.2 XA Subordinate Transaction Manager Facet Details

3.2.1 Abstract Data Model

This section describes a conceptual model of possible data organization that an implementation maintains to participate in this protocol. The described organization is provided to facilitate the explanation of how the protocol behaves. This document does not mandate the implementations adhere to this model as long as their external behavior is consistent with the behavior that is described in this document.

Note that the abstract data model can be implemented in a variety of ways. This protocol does not prescribe or advocate any specific implementation technique.

The [XA Subordinate Transaction Manager Facet](#) MUST maintain all the data elements that are specified in section [3.1.1](#).

The XA Subordinate Transaction Manager Facet MUST also maintain the following data elements:

- **Wait For All XA Branch Prepares:** A flag that indicates whether the primary **branch** of a set of **tightly coupled XA Transaction Branches** will wait for all branches to receive Prepare requests before initiating **Two-Phase Commit** processing.
- **XA Superior Table:** A table of XA Superior Objects keyed by **Resource Manager Recovery GUID**.
- **XA Superior Object:** This object represents an XA Superior Transaction Manager associated with a Resource Manager Recovery **GUID**. An XA Superior Object MUST contain the following elements:
 - **Open Count:** Specifies how many times `xa_open()` has been called.
 - **XA Superior Enlistment Table:** A table of XA Superior Enlistment Objects keyed by **XID**. This table is used to track XA Transactions associated with the Resource Manager Recovery GUID.
 - **Current Recovery XID:** Specifies the current XID to be recovered.
- **XA Superior Enlistment Object:** Specifies an XA Superior Enlistment, which associates the Primary Branch of an XA Transaction with a **transaction** Object. This extends the Enlistment Object defined in [\[MS-DTCO\]](#). An XA Superior Enlistment Object MUST contain the following elements:
 - **Coupling:** Indicates the type of coupling between the XA Transaction Branches. This field MUST be set to one of the following values:
 - **Tight:** Indicates that different XIDs with the same **XA Global Transaction Identifier** will be associated with a single Ole Transaction. Also, different XIDs that have different XA Global Transaction Identifiers will be associated with their own, different Ole Transactions.
 - **Loose:** Indicates that different XIDS will be associated with their own, different Ole Transactions.
 - **Resource Manager Recovery GUID:** Associates an **Enlistment** with XA Superior Transaction Manager.
 - **XID:** Specifies the XID associated with the XA Superior Enlistment Object.
 - **State:** Specifies the current state of the Enlistment. This field MUST contain one of the following values:
 - **Init:** XA Superior Enlistment Object is not enlisted in a transaction Object.
 - **Active:** XA Superior Enlistment Object is enlisted in a transaction Object.
 - **Migrate:** XA Superior Enlistment Object has been suspended, and MUST be resumed before it can begin Two-Phase Commit processing.
 - **Preparing:** XA Superior Enlistment Object is awaiting a response to its Prepare request to the associated Transaction Object.
 - **Preparing Single Phase:** XA Superior Enlistment Object is awaiting a response to its **single-phase commit** to the associated Transaction Object.

- **Prepared:** State field of the Transaction Object associated with the XA Superior Enlistment Object is set to Prepared.
- **In Doubt:** State field of the Transaction Object associated with the XA Superior Enlistment Object is set to In Doubt.
- **Aborting:** XA Superior Enlistment Object is awaiting a response to its abort request to the associated Transaction Object.
- **Aborted:** State field of the Transaction Object associated with the XA Superior Enlistment Object is set to Aborted.
- **Committing:** XA Superior Enlistment Object is awaiting a response to its commit request to the associated Transaction Object.
- **Committed:** State field of the Transaction Object associated with the XA Superior Enlistment Object is set to Committed.
- **Current Request CMP Connection:** Specifies the CMP Connection associated with the XA Superior Transaction Manager request being processed.
- **Child Branch table:** A table of XA Superior Child Branch Enlistment Objects keyed by XID.
- **Name:** The XA Global Transaction Identifier portion of the data field of the XID structure associated with the XA Superior Enlistment object, formatted as a string.
- **Identifier:** The bqual portion of the data field of the XID associated with the XA Superior Enlistment object, formatted as a string.
- **Transaction:** A reference to the transaction object associated with the XA Superior enlistment object. The transaction object is defined in [MS-DTCO] sections 3.1.1 and 3.2.1.
- **XA Superior Child Branch Enlistment Object:** Specifies an XA Enlistment, which associates the **Child Branch** of an XA Transaction with the Primary Branch. This Object MUST contain the following elements:
 - XID: Specifies the XID associated with the XA Superior Enlistment Object.
 - **State:** Specifies the current state of the Enlistment. This field MUST contain one of the following values:
 - **Init:** This is the initial state.
 - **Active:** The request received from the XA Superior Transaction Manager is being processed.
 - **Child Branch:** The request to suspend a transaction has been processed.
 - **Complete:** This is the final state.
 - **Parent XA Superior Enlistment Object:** Specifies the XA Superior Enlistment Object associated with the **Parent Branch**.
 - **Current Request CMP Connection:** Specifies the CMP Connection associated with the XA Superior Transaction Manager request being processed.
- **XA Superior Enlistment CMP Connection:** CMP Connection associated with [CONNTYPE_XAUSER_XACT_START](#), [CONNTYPE_XAUSER_XACT_OPEN](#), [CONNTYPE_XAUSER_XACT_MIGRATE](#), [CONNTYPE_XAUSER_XACT_BRANCH_START](#), [CONNTYPE_XAUSER_XACT_BRANCH_OPEN](#), and [CONNTYPE_XAUSER_XACT_MIGRATE2](#) acceptors. The definition of an [\[MS-CMP\]](#) connection Object is extended to include the following elements:

- **State:** A state enumeration that represents the current state of the connection.
- Reference to XA Superior Enlistment Object or XA Superior Child Branch Enlistment Object.
- **XA Superior CMP Connection:** CMP Connection associated with [CONNTYPE_XAUSER_CONTROL](#) acceptor. The definition of an [MS-CMP] connection Object is extended to include the following elements:
 - **State:** A state enumeration that represents the current state of the connection.
 - Reference to XA Superior Object.

3.2.1.1 Versioning

The [XA Subordinate Transaction Manager Facet](#) MUST maintain the data that pertains to the branching functionality only on versions where the connection types [CONNTYPE_XAUSER_XACT_BRANCH_START](#) and [CONNTYPE_XAUSER_XACT_BRANCH_OPEN](#) are supported as specified in section [2.2.4.1](#). The following data elements, as specified in [3.2.1](#), are affected:

- Wait For All XA Branch Prepares flag
- XA Superior Enlistment Object
 - Coupling
 - **Child Branch** Table

The XA Subordinate Transaction Manager Facet MUST maintain the data that pertains to the migrate functionality only on versions where the connection type [CONNTYPE_XAUSER_XACT_MIGRATE](#) or [CONNTYPE_XAUSER_XACT_MIGRATE2](#) is supported, as specified in section [2.2.4.1](#). The following data elements, as specified in section [3.2.1](#), are affected:

- XA Superior Enlistment Object
 - State
 - Migrate
- XA Child Branch Enlistment Object
 - State
 - Migrate

3.2.1.2 CONNTYPE_XAUSER_CONTROL Acceptor States

The [XA Subordinate Transaction Manager Facet](#) MUST act as an acceptor for the [CONNTYPE_XAUSER_CONTROL](#) connection type. In this role, the XA Subordinate Transaction Manager Facet MUST provide support for the following states:

- [Idle](#)
- [Processing Create Request](#)
- [Active](#)
- [Ended](#)

3.2.1.2.1 Idle

This is the initial state. The following event is processed in this state:

- [Receiving an XAUSER CONTROL MTAG CREATE Message](#)

3.2.1.2.2 Processing Create Request

This is a transient state that is assumed during the synchronous processing of the [XAUSER CONTROL MTAG CREATE](#) request. No events are processed in this state.

3.2.1.2.3 Active

The following events are processed in this state:

- [Receiving an XAUSER CONTROL MTAG RECOVER Message](#)
- [Connection Disconnected \(section 3.2.5.1.3\)](#)

3.2.1.2.4 Ended

This is the final state.

3.2.1.2.5 State Diagram

The following figure shows the relationship between the [CONNTYPE XAUSER CONTROL](#) acceptor states.

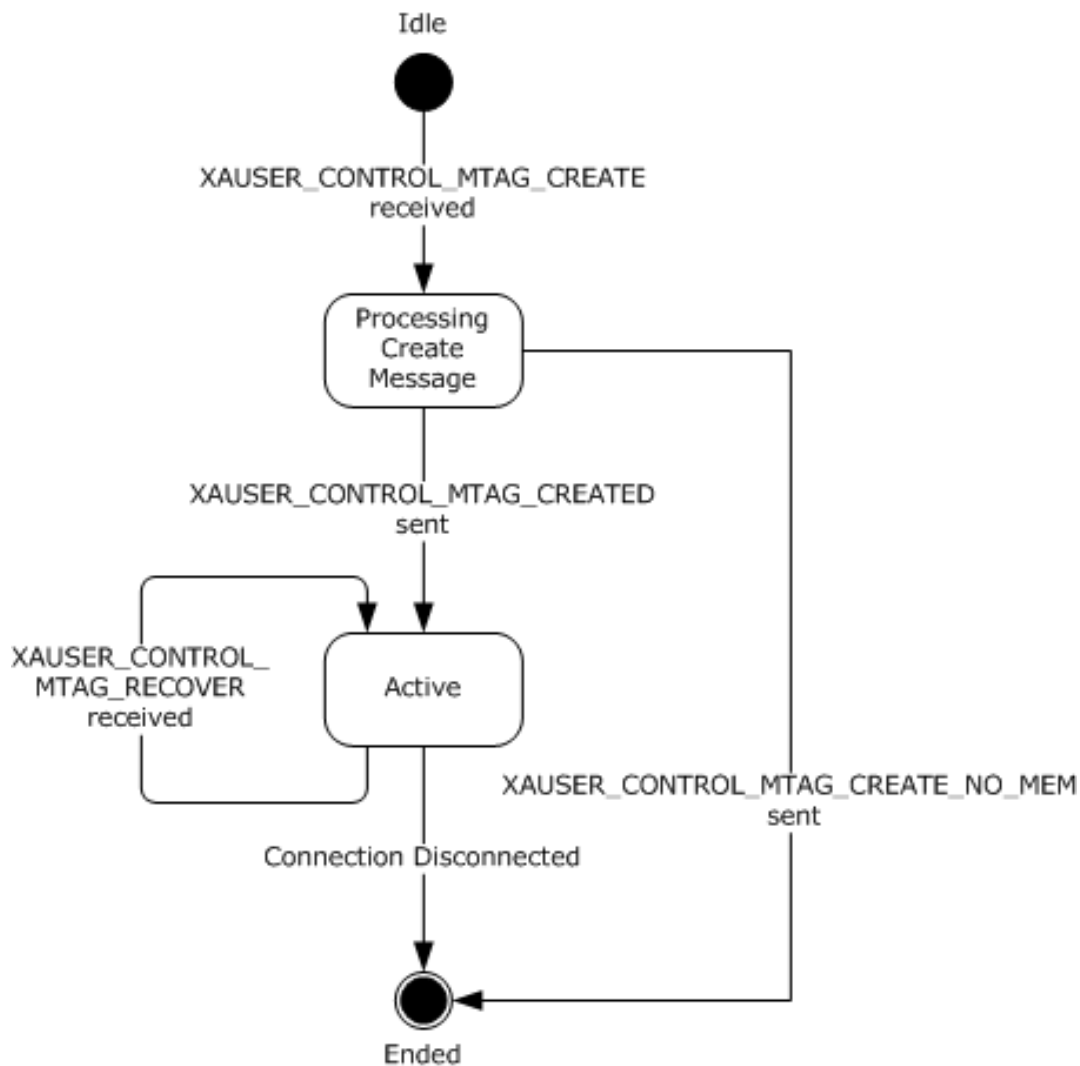

Figure 12: CONNTYPE_XAUSER_CONTROL acceptor states

3.2.1.3 CONNTYPE_XAUSER_XACT_START Acceptor States

The [XA Subordinate Transaction Manager Facet](#) MUST act as an acceptor for the [CONNTYPE_XAUSER_XACT_START](#) connection type. In this role, the XA Subordinate Transaction Manager Facet MUST provide support for the following states:

- [Idle](#)
- [Processing Start Request](#)
- [Active](#)
- [Ended](#)

3.2.1.3.1 Idle

This is the initial state. The following event is processed in this state:

- [Receiving an XAUSER_XACT_MTAG_START Message](#)

3.2.1.3.2 Processing Start Request

This is a transient state that is assumed during the synchronous processing of the [XAUSER XACT MTAG START \(section 2.2.4.3.1\)](#) request.

The following events are processed in this state:

- [Create Superior Enlistment Success \(section 3.2.7.2\)](#).
- [Create Superior Enlistment Failure \(section 3.2.7.3\)](#).

3.2.1.3.3 Active

The following event is processed in this state:

- [Connection Disconnected \(section 3.2.5.2.2\)](#)

3.2.1.3.4 Ended

This is the final state.

3.2.1.3.5 State Diagram

The following figure shows the relationship between the [CONNTYPE XAUSER XACT START](#) acceptor states.

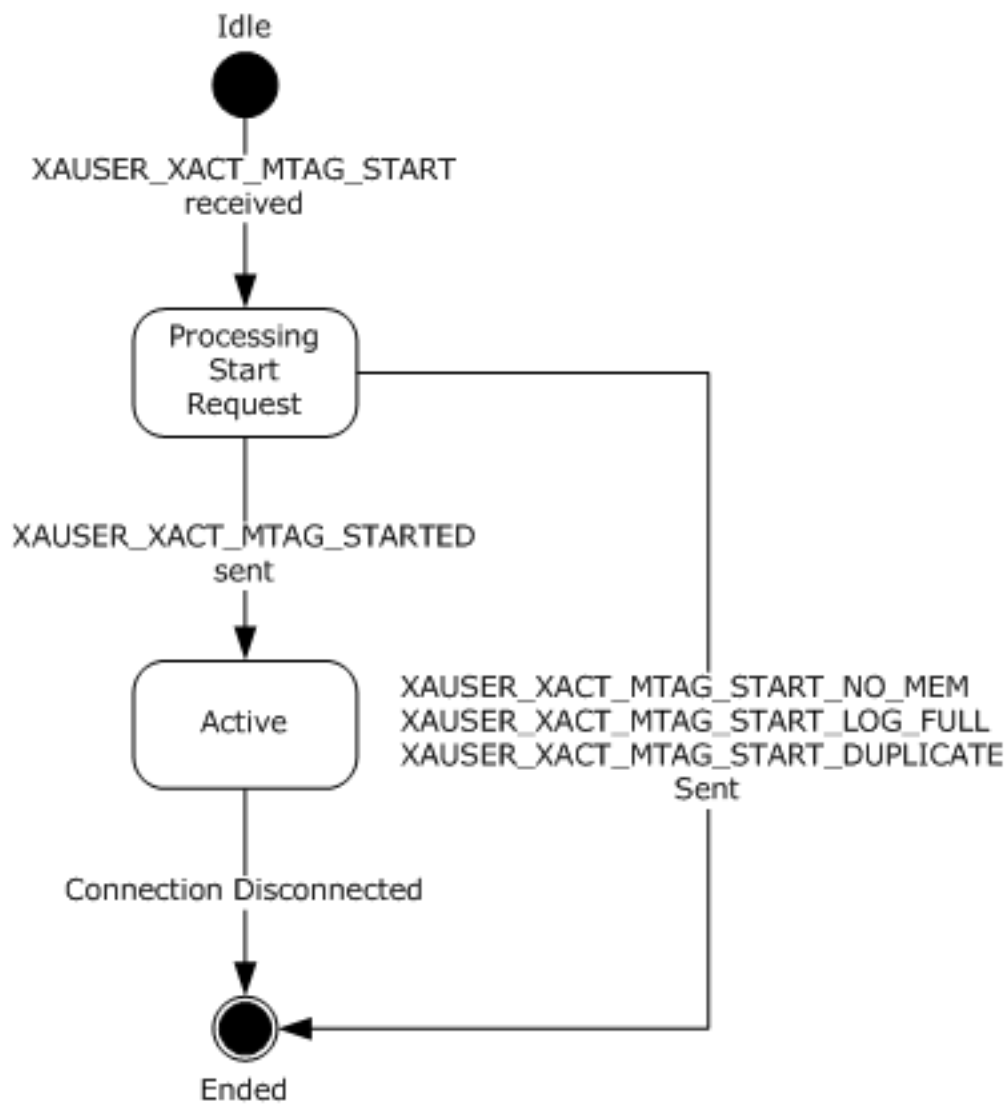

Figure 13: CONNTYPE_XAUSER_XACT_START acceptor states

3.2.1.4 CONNTYPE_XAUSER_XACT_OPEN Acceptor States

The [XA Subordinate Transaction Manager Facet](#) MUST act as an acceptor for the [CONNTYPE_XAUSER_XACT_OPEN](#) connection type. In this role, the XA Subordinate Transaction Manager Facet MUST provide support for the following states:

- [Idle](#)
- [Active](#)
- [Ended](#)

3.2.1.4.1 Idle

This is the initial state. The following event is processed in this state:

- [Receiving an XAUSER_XACT_MTAG_OPEN Message](#)

3.2.1.4.2 Processing Open Request

This is a transient state that is assumed during the synchronous processing of the [XAUSER XACT MTAG OPEN](#) request. No non-local events are processed in this state.

3.2.1.4.3 Active

The following events are processed in this state:

- [Receiving an XAUSER XACT MTAG PREPARE Message \(section 3.2.5.3.2\)](#)
- [Receiving an XAUSER XACT MTAG ABORT Message \(section 3.2.5.3.4\)](#)
- [Receiving a XAUSER XACT MTAG COMMIT Message \(section 3.2.5.3.3\)](#)
- [Connection Disconnected \(section 3.2.5.3.5\)](#)

3.2.1.4.4 Ended

This is the final state.

3.2.1.4.5 State Diagram

The following figure shows the relationship between the [CONNTYPE XAUSER XACT OPEN](#) acceptor states.

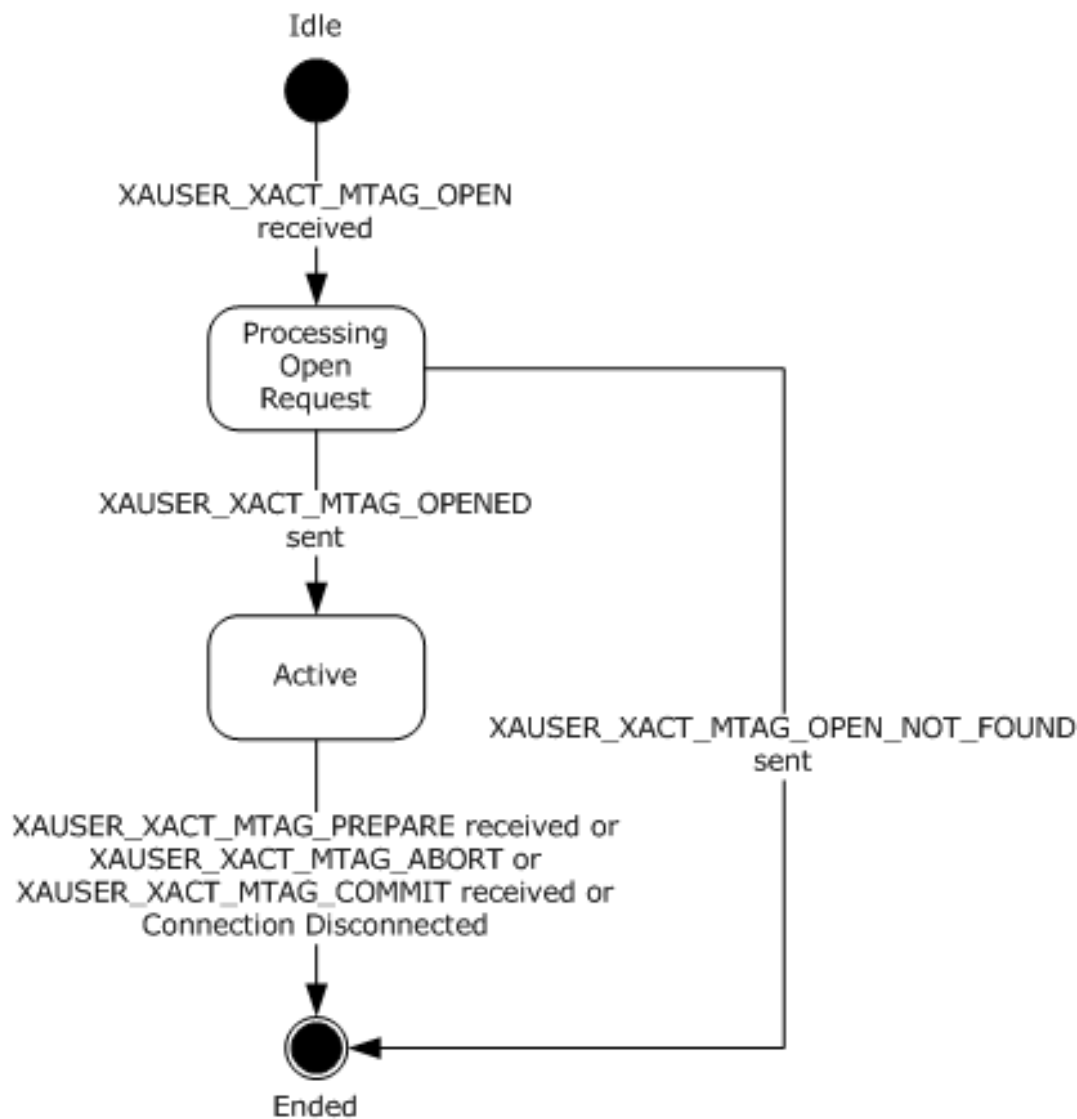

Figure 14: CONNTYPE_XAUSER_XACT_OPEN acceptor states

3.2.1.5 CONNTYPE_XAUSER_XACT_MIGRATE Acceptor States

The [XA Subordinate Transaction Manager Facet](#) MUST act as an acceptor for the [CONNTYPE_XAUSER_XACT_MIGRATE](#) connection type. In this role, the XA Subordinate Transaction Manager Facet MUST provide support for the following states:

- [Idle](#)
- [Processing Migrate Request](#)
- [Ended](#)

3.2.1.5.1 Idle

This is the initial state. The following events are processed in this state:

- [Receiving an XAUSER_XACT_MTAG_SUSPEND_WITH_MIGRATE Message](#)

- [Receiving an XAUSER_XACT_MTAG_RESUME Message](#)

3.2.1.5.2 Processing Migrate Request

This is a transient state that is assumed during the synchronous processing of the [XAUSER_XACT_MTAG_SUSPEND_WITH_MIGRATE](#) or [XAUSER_XACT_MTAG_RESUME](#) request. No events are processed in this state.

3.2.1.5.3 Ended

This is the final state.

3.2.1.5.4 State Diagram

The following figure shows the relationship between the [CONNTYPE_XAUSER_XACT_MIGRATE](#) acceptor states.

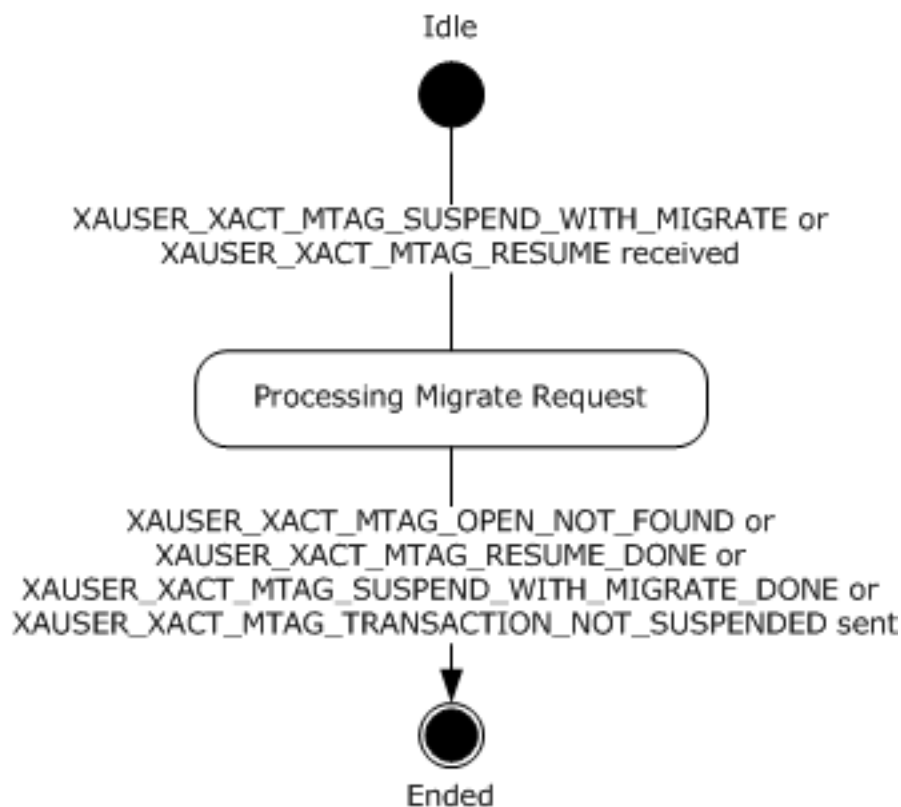

Figure 15: CONNTYPE_XAUSER_XACT_MIGRATE acceptor states

3.2.1.6 CONNTYPE_XAUSER_XACT_BRANCH_START Acceptor States

The [XA Subordinate Transaction Manager Facet](#) MUST act as an acceptor for the [CONNTYPE_XAUSER_XACT_BRANCH_START](#) connection type. In this role, the XA Subordinate Transaction Manager Facet MUST provide support for the following states:

- [Idle](#)
- [Active](#)
- [Ended](#)

3.2.1.6.1 Idle

This is the initial state. The following events are processed in this state:

- [Receiving an XAUSER XACT MTAG START Message.](#)

3.2.1.6.2 Processing Start Request

This is a transient state that is assumed during the synchronous processing of the [XAUSER XACT MTAG START \(section 2.2.4.3.1\)](#) request.

The following events are processed in this state:

- [Create Superior Enlistment Success \(section 3.2.7.2\).](#)
- [Create Superior Enlistment Failure \(section 3.2.7.3\).](#)

3.2.1.6.3 Active

The following event is processed in this state:

- [Connection Disconnected \(section 3.2.5.5.2\)](#)

3.2.1.6.4 Ended

This is the final state.

3.2.1.6.5 State Diagram

The following figure shows the relationship between the [CONNTYPE XAUSER XACT BRANCH START](#) acceptor states.

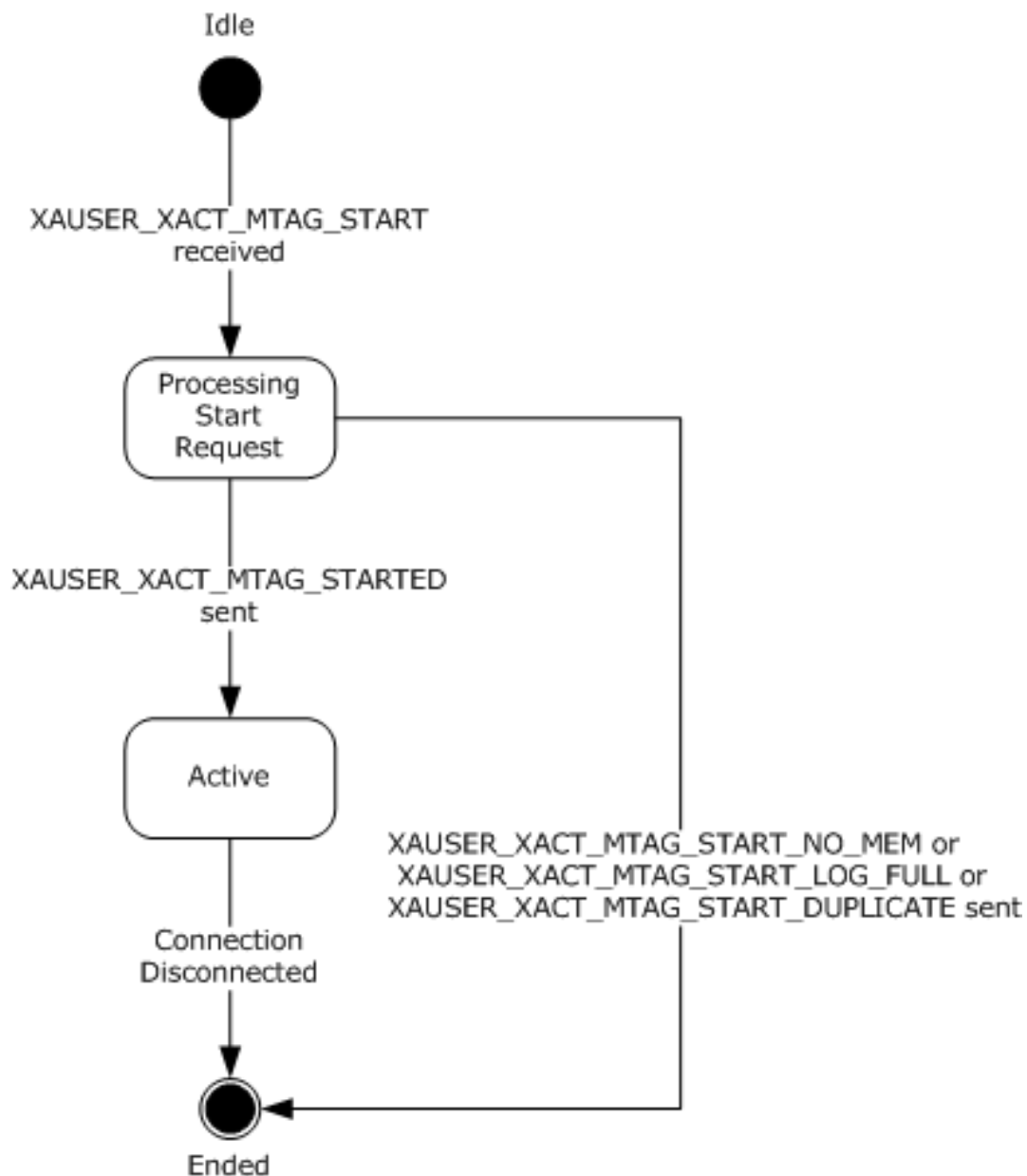

Figure 16: CONNTYPE_XAUSER_XACT_BRANCH_START acceptor states

3.2.1.7 CONNTYPE_XAUSER_XACT_BRANCH_OPEN Acceptor States

The [XA Subordinate Transaction Manager Facet](#) MUST act as an acceptor for the [CONNTYPE_XAUSER_XACT_BRANCH_OPEN](#) connection type. In this role, the XA Subordinate Transaction Manager Facet MUST provide support for the following states:

- [Idle](#)
- [Active](#)
- [Ended](#)

3.2.1.7.1 Idle

This is the initial state. The following event is processed in this state:

- [Receiving an XAUSER XACT MTAG OPEN Message](#)

3.2.1.7.2 Processing Open Request

This is a transient state that is assumed during the synchronous processing of the [XAUSER XACT MTAG OPEN](#) request. No events are processed in this state.

3.2.1.7.3 Active

The following events are processed in this state:

- [Receiving an XAUSER XACT MTAG PREPARE Message \(section 3.2.5.6.2\)](#)
- [Receiving an XAUSER XACT MTAG ABORT Message \(section 3.2.5.6.4\)](#)
- [Receiving an XAUSER XACT MTAG COMMIT Message \(section 3.2.5.6.3\)](#)
- [Connection Disconnected \(section 3.2.5.6.5\)](#)

3.2.1.7.4 Ended

This is the final state.

3.2.1.7.5 State Diagram

The following figure shows the relationship between the [CONNTYPE XAUSER XACT BRANCH OPEN](#) acceptor states.

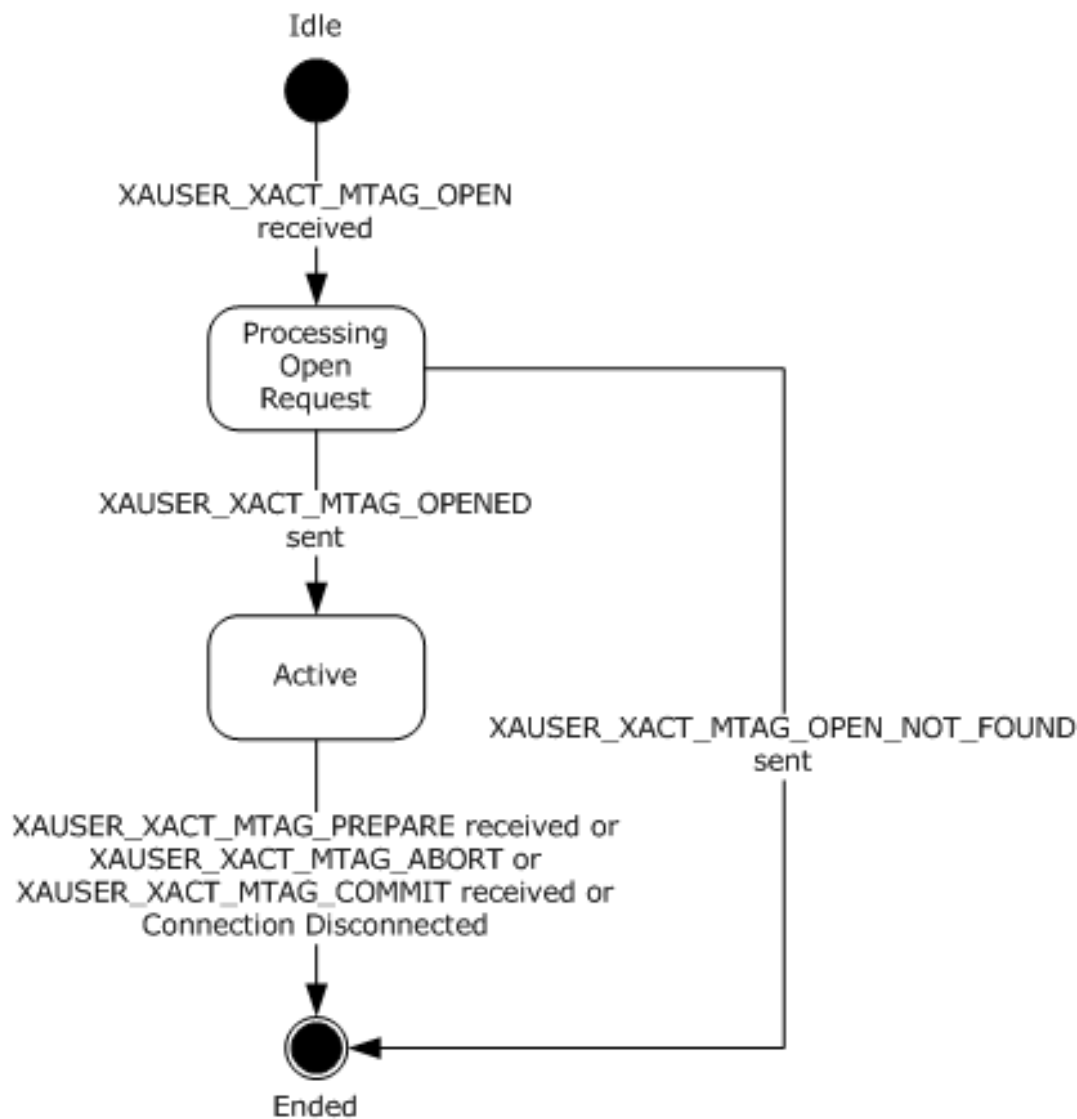

Figure 17: CONNTYPE_XAUSER_XACT_BRANCH_OPEN acceptor states

3.2.1.8 CONNTYPE_XAUSER_XACT_MIGRATE2 Acceptor States

The [XA Subordinate Transaction Manager Facet](#) MUST act as an acceptor for the [CONNTYPE_XAUSER_XACT_MIGRATE2](#) connection type. In this role, the XA Subordinate Transaction Manager Facet MUST provide support for the following states:

- [Idle](#)
- [Processing Migrate2 Request](#)
- [Ended](#)

3.2.1.8.1 Idle

This is the initial state. The following events are processed in this state:

- [Receiving an XAUSER_XACT_MTAG_SUSPEND_WITH_MIGRATE Message](#)

- [Receiving an XAUSER_XACT_MTAG_RESUME Message](#)

3.2.1.8.2 Processing Migrate2 Request

This is a transient state that is assumed during the synchronous processing of the [XAUSER_XACT_MTAG_SUSPEND_WITH_MIGRATE](#) or [XAUSER_XACT_MTAG_RESUME](#) request. No events are processed in this state.

3.2.1.8.3 Ended

This is the final state.

3.2.1.8.4 State Diagram

The following figure shows the relationship between the [CONNTYPE_XAUSER_XACT_MIGRATE2](#) acceptor states.

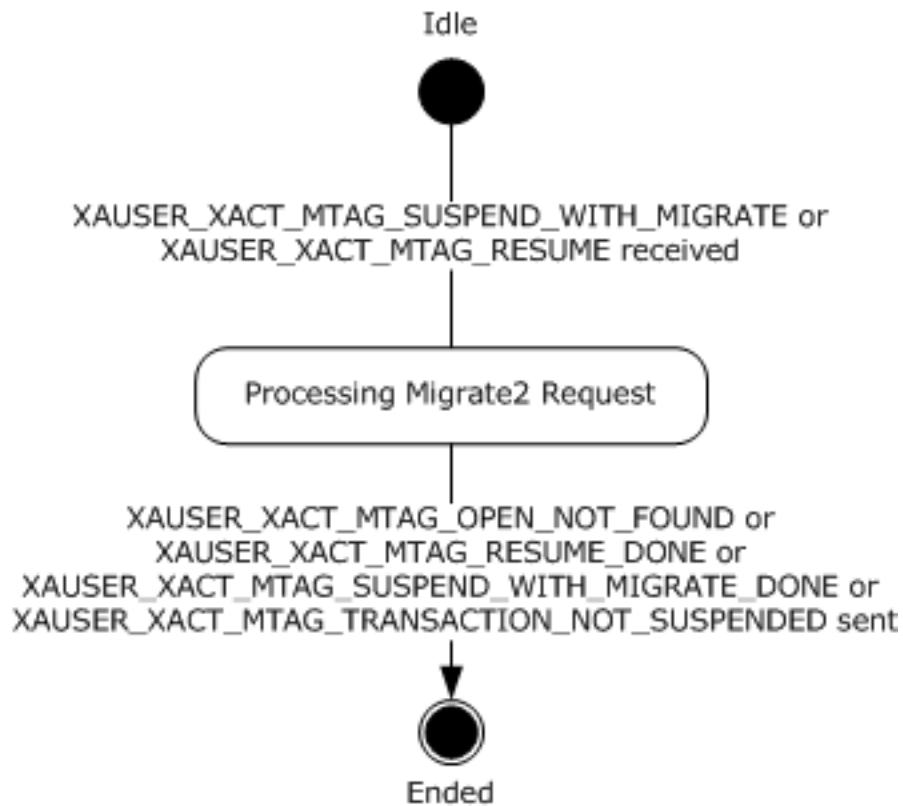

Figure 18: CONNTYPE_XAUSER_XACT_MIGRATE2 acceptor states

3.2.1.9 XA Superior Enlistment State Diagram

The following figure shows the relationship between the XA Superior Enlistment states.

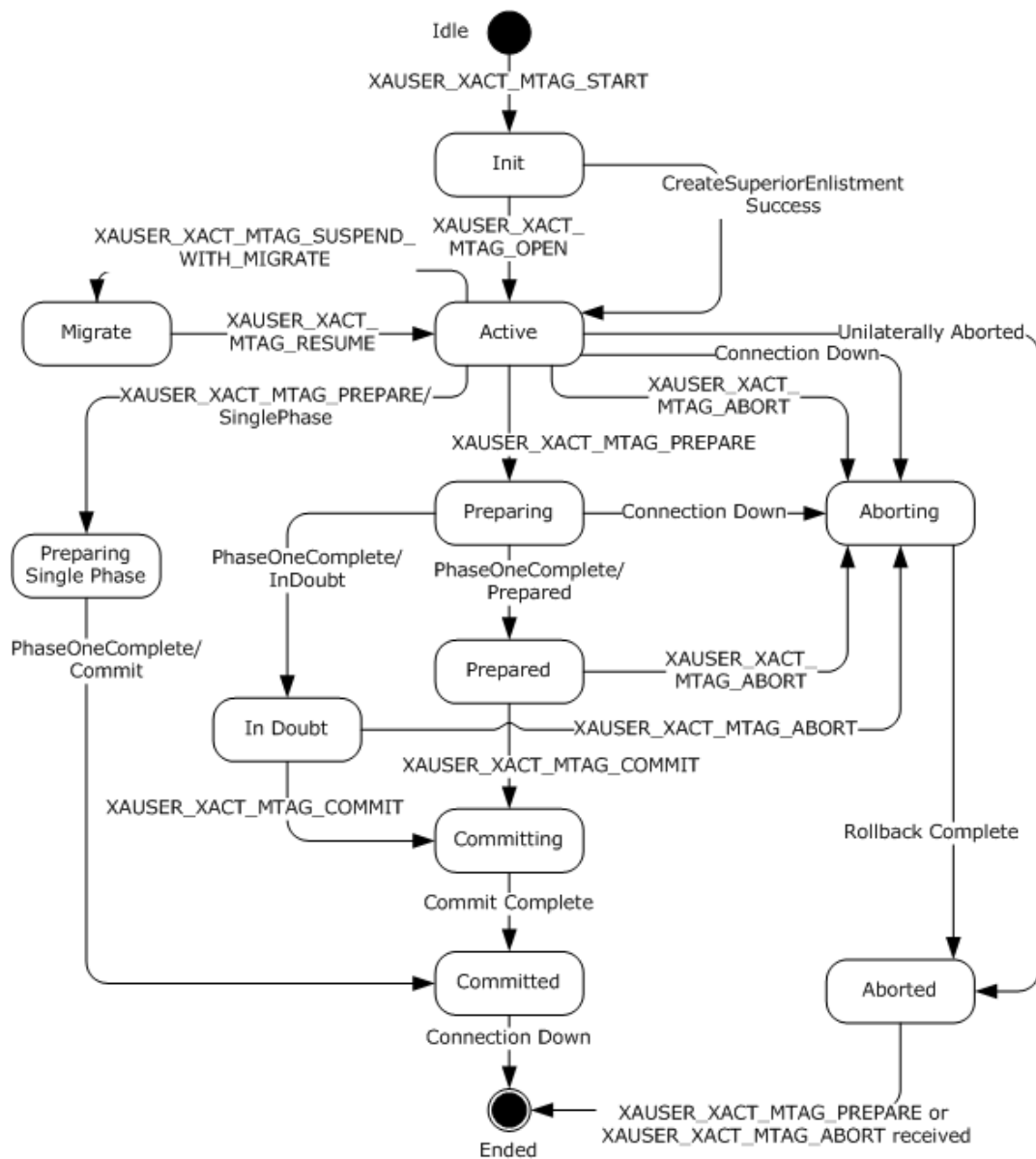

Figure 19: XA Superior Enlistment Object states

3.2.2 Timers

None.

3.2.3 Initialization

When the [XA Subordinate Transaction Manager Facet](#) is initialized:

- The *Wait For All XA Branch Prepares* flag is set to an implementation-specific value.
- The XA Subordinate Transaction Manager Facet MUST examine the **Allow XA** flag on the Core Transaction Manager Facet specified in [\[MS-DTCO\]](#) section 3.2.1 and, if it is not set, perform the following:

- For all of the connection types listed in section [3.2](#), the XA Subordinate Transaction Manager Facet MUST refuse to accept incoming connections from remote machines as specified in [\[MS-CMP\]](#) section 3.1.5.5 with the rejection **Reason** set to 0x80070005.

3.2.4 Higher-Layer Triggered Events

None.

3.2.5 Processing Events and Sequencing Rules

3.2.5.1 CONNTYPE_XAUSER_CONTROL as Acceptor

This is an XA Superior CMP Connection.

For all messages received in this [Connection Type](#), the [XA Subordinate Transaction Manager Facet](#) MUST process the message as specified in section [3.1](#). The XA Subordinate Transaction Manager Facet MUST also follow the processing rules specified in the following sections.

3.2.5.1.1 Receiving an XAUSER_CONTROL_MTAG_CREATE Message

When the [XA Subordinate Transaction Manager Facet](#) receives an [XAUSER_CONTROL_MTAG_CREATE](#) message, it MUST perform the following actions:

- If the connection state is Idle:
 - Set the connection state to [Processing Create Message](#).
 - Attempt to find the XA Superior Object in the XA Superior Table keyed by the **guidXaRm** field of the message.
 - If an Object is found:
 - Increment the **Open Count** field of the found XA Superior Object.
 - Send an [XAUSER_CONTROL_MTAG_CREATED](#) message using the connection.
 - Set the connection state to Active.
 - Set the XA Superior Object referenced by the XA Superior CMP Connection to the found XA Superior Object.
 - Otherwise:
 - Attempt to create a new XA Superior Object with the following values:
 - Set the **Open Count** field to 1.
 - If the creation of the new XA Superior Object fails:
 - Send a [XAUSER_CONTROL_MTAG_CREATE_NO_MEM](#) message using the connection.
 - Set the **connection** state to Ended.
 - Otherwise:
 - Add the new XA Superior Object to the XA Superior Table referenced by the XA Subordinate Transaction Manager Facet with the **guidXaRm** field of the message as its key.
 - Send an XAUSER_CONTROL_MTAG_CREATED message using the receiving connection.

- Set the connection state to Active.
- Set the XA Superior Object referenced by the XA Superior CMP Connection to the newly created XA Superior Object.
- Otherwise, the message MUST be processed as an invalid message as specified in section [3.1.6](#).

3.2.5.1.2 Receiving an XAUSER_CONTROL_MTAG_RECOVER Message

When the [XA Subordinate Transaction Manager Facet](#) receives an [XAUSER_CONTROL_MTAG_RECOVER](#) message, it MUST perform the following actions.

- If the connection state is Active, SHOULD check the following conditions: [<6>](#)
 - The **totalUOWsRequested** field of the message is less than or equal to an implementation-specific value and greater than 0x00000000. [<7>](#)
 - If the conditions are not met:
 - Stop processing the message. The connection stays in the Active state.
 - Otherwise:
 - **totalUOWsRequested** SHOULD be set to the minimum between an implementation-specific value and **totalUOWsRequested**. [<8>](#)
 - Attempt to create a new [XAUSER_CONTROL_MTAG_RECOVER_REPLY](#) message:
 - The **ultotalUOWs** field is set to 0.
 - The **Uow_Recs** field is set to an array of (**totalUOWsRequested** + 5) uninitialized [XA_UOW](#) elements.
 - If failed:
 - Send a [XAUSER_CONTROL_MTAG_RECOVER_NO_MEM](#) message using the receiving connection.
 - Otherwise:
 - If **RequestFlags** field of the message is set to XARECOVER_START_SCAN:
 - Set the **Current Recovery XID** field of the **XA Superior Object** referenced by the receiving connection to a null XID value as defined in [\[XOPEN-DTP\]](#) section 4.2.
 - If the **Current Recovery XID** field of the **XA Superior Object** referenced by the receiving connection is set to a null XID value and XA Superior table is not empty:
 - Set the **Current Recovery XID** field of the **XA Superior Object** referenced by the receiving connection to the **XID** field of the first **XA Superior Enlistment Object** in the XA Superior Enlistment Table referenced by the **XA Superior Object** referenced by the receiving connection.
 - Perform the following steps until one of the following conditions is TRUE:
 - The **Current Recovery XID** field of the **XA Superior Object** referenced by the receiving connection is set to a null XID value.

- The **ultotalUOWs** field of the XAUSER_CONTROL_MTAG_RECOVER_REPLY message is equal to **totalUOWsRequested** field of the XAUSER_CONTROL_MTAG_RECOVER message.
- SHOULD<9> attempt to find an **XA Superior Enlistment Object** in the **XA Superior Enlistment Table** of the **XA Superior Object** referenced by the receiving connection which meets both of the following conditions:
 - The **XID** field is set to the **Current Recovery XID** field of the **XA Superior Object** referenced by the receiving connection.
 - The **State** field is set to either **Prepared** or **In Doubt**.
- If one of the conditions is met:
 - Set the **lenXAIdentifier** field of the XA_UOW structure referenced by the element at the **ultotalUOWs** index in the **Uow_Recs** field of the XAUSER_CONTROL_MTAG_RECOVER_REPLY message to the size of an XA_XID structure (section [2.2.1.3](#)).
 - Set the **XAIdentifier** field of the XA_UOW structure referenced by the element at the **ultotalUOWs** index in the **Uow_Recs** field of the XAUSER_CONTROL_MTAG_RECOVER_REPLY message to the **Current Recovery XID** field of the **XA Superior Object** referenced by the receiving connection.
 - Increment the **ultotalUOWs** field of the XAUSER_CONTROL_MTAG_RECOVER_REPLY message.
- If the **Current Recovery XID** field of the **XA Superior Object** is not the last **XID** in the XA Superior Enlistment Table referenced by the **XA Superior Object**:
 - Set the **Current Recovery XID** field of the **XA Superior Object** referenced by the receiving connection to the **XID** field of the next **XA Superior Enlistment Object** in the XA Superior Enlistment Table referenced by the **XA Superior Object**.
- Otherwise:
 - Set the **Current Recovery XID** field of the **XA Superior Object** to a null XID value.
- Test the following conditions:
 - The **Current Recovery XID** field of the **XA Superior Object** is set to a null XID value.
 - The **RequestFlags** field of the message is set to XARECOVER_END_SCAN.
- If one of the conditions is met:
 - Set the **ReplyFlags** field of the XAUSER_CONTROL_MTAG_RECOVER_REPLY message to XARECOVER_END_OF_RECS.
- Otherwise:
 - Set the **ReplyFlags** field of the XAUSER_CONTROL_MTAG_RECOVER_REPLY message to XARECOVER_MORE_TO_COME.
- Send the XAUSER_CONTROL_MTAG_RECOVER_REPLY message using the receiving connection.

- Otherwise, the message MUST be processed as an invalid message as specified in section [3.1.6](#).

3.2.5.1.3 Connection Disconnected

When a [CONNTYPE_XAUSER_CONTROL](#) connection is disconnected, the [XA Subordinate Transaction Manager Facet](#) MUST perform the following actions:

- If XA Superior Object reference is set:
 - Decrement the **Open Count** field of the XA Superior Object referenced by the connection.
 - If **Open Count** field of the XA Superior Object is set to 0 perform the following actions:
 - Remove XA Superior Object from XA Superior table.
 - For each XA Superior Enlistment Object in the XA Superior Enlistment Table of the XA Superior Object, if the **State** field is set to Active:
 - Signal the Begin Rollback event ([\[MS-DTCO\]](#) section 3.2.7.6) on the Core Transaction Manager Facet with the following argument:
 - The Transaction Object referenced by the XA Superior Enlistment Object.
 - Delete the XA Superior Object.

3.2.5.2 CONNTYPE_XAUSER_XACT_START as Acceptor

This is an XA Superior Enlistment CMP Connection.

For all messages received in this [Connection Type](#), the [XA Subordinate Transaction Manager Facet](#) MUST process the message as specified in the section [3.1](#). The XA Subordinate Transaction Manager Facet MUST also follow the processing rules specified in the following sections.

3.2.5.2.1 Receiving an XAUSER_XACT_MTAG_START Message

When the [XA Subordinate Transaction Manager Facet](#) receives an [XAUSER_XACT_MTAG_START](#) message, it MUST perform the following actions:

- If the **State** field of the receiving XA Superior Enlistment CMP Connection is set to Idle:
 - Set the state of the connection to [Processing Start Request](#).
 - If the **transaction manager** does not have sufficient memory available to process the message, it MUST perform the following actions:
 - Send an XAUSER_XACT_MTAG_START_NO_MEM message (section [2.2.4.3.4](#)).
 - Set the connection state to Ended.
 - Processing for this event is complete.
 - Otherwise:
 - Attempt to find the XA Superior Object in the XA Superior Table keyed by the **guidXaRm** field of the message.
 - If an Object is found:
 - Use this as the XA Superior Object in the remainder of the processing of this event.
 - Otherwise:

- Attempt to create a new XA Superior Object.
- If the creation of the new XA Superior Object fails:
 - Send an XAUSER_XACT_MTAG_START_NO_MEM message using the connection.
 - Set the connection state to Ended.
 - Processing for this event is complete.
- Otherwise:
 - Set the **Open Count** field of the new XA Superior Object to 1.
 - Add the new XA Superior Object to the XA Superior Table referenced by the XA Subordinate Transaction Manager Facet with the **guidXaRm** field of the message as its key.
 - Use this as the XA Superior Object in the remainder of the processing of this event.
- Attempt to create a new XA Superior Enlistment Object with the following values:
 - The **Coupling** field is set to Loose.
 - The **Resource Manager Recovery GUID** field is set to **guidXaRm** field of the message.
 - The **XID** field is set to the value of the **XAIdentifier** field of the [XA_UOW](#) structure (section 2.2.1.4) contained within the **XAUow** field of the message.
 - The **State** field is set to Init.
 - The Current Request CMP connection field is set to the receiving connection.
- If failed:
 - Send an XAUSER_XACT_MTAG_START_NO_MEM message using the connection.
 - Set the connection state to [Ended](#).
- Otherwise:
 - Create a new GUID as specified in [\[RFC4122\]](#).
 - Attempt to create new **transaction** with the following settings:
 - The **Isolation Level** field is set to the **isoLevel** field of the message or 0.
 - The **Timeout** field is set to the **Timeout** field of the message or 0.
 - The **Description** field is set to the **szDesc** of the message or "".
 - The **Isolation Flags** field is set to **isoFlags** field of the message or 0.
 - The **Transaction Object.Identifier** field is set to the GUID created in the previous step.
 - If failed:
 - Send an XAUSER_XACT_MTAG_START_NO_MEM message using the connection.
 - Set the connection state to Ended.

- Otherwise:
 - Attempt to find an XA Superior Enlistment Object in the XA Superior Enlistment Table referenced by the XA Superior Object that meets both of the following conditions:
 - The **XID** field is set to the value of the **XAIdentifier** field of the **XA_UOW** structure contained within the **XAUow** field of the message.
 - The **Coupling** field is set to **Loose**.
 - If found:
 - Send an [XAUSER_XACT_MTAG_START_DUPLICATE](#) message using the connection.
 - Set the connection state to Ended.
 - Otherwise:
 - Set the **Transaction** field of the XA Superior Enlistment Object to the newly-created transaction.
 - Signal the Create Superior Enlistment event on the Core Transaction Manager Facet with the following argument:
 - The XA Superior Enlistment Object.
- Otherwise, the message MUST be processed as an invalid message as specified in section [3.1.6](#).

3.2.5.2.2 Connection Disconnected

The Connection Disconnected event MUST be signaled with the following argument:

- **XA Superior Enlistment CMP Connection.**

When a [CONNTYPE XAUSER_XACT_START](#) connection (section 2.2.4.3) is disconnected, the [XA Subordinate Transaction Manager Facet \(section 1.3.2.3.2\)](#) SHOULD perform the following actions: [<10>](#)

- If the **Connection** state is set to **Active** and the **State** field of the **XA Superior Enlistment Object** referenced by the provided **XA Superior Enlistment CMP Connection** is set to either **Active** or **Preparing**:
 - Set the **State** field of **XA Superior Enlistment Object** referenced by the provided **XA Superior Enlistment CMP Connection** to **Aborting**.
 - If the **Current Request CMP Connection** field of the **XA Superior Enlistment Object** referenced by the provided **XA Superior Enlistment CMP Connection** is set to the provided **XA Superior Enlistment CMP Connection**:
 - Remove the reference to the **XA Superior Enlistment CMP Connection** from the **Current Request CMP Connection** field of the **XA Superior Enlistment Object**.
 - Signal the Begin Rollback event ([\[MS-DTCO\]](#) section 3.2.7.6) on the Core Transaction Manager Facet with the following argument:
 - The **Transaction Object**, referenced by the **XA Superior Enlistment Object**, referenced by the provided **XA Superior Enlistment CMP Connection**.

3.2.5.3 CONNTYPE_XAUSER_XACT_OPEN as Acceptor

This is an XA Superior Enlistment CMP Connection.

For all messages received in this [Connection Type](#), the [XA Subordinate Transaction Manager Facet](#) MUST process the message as specified in section [3.1](#). The XA Subordinate Transaction Manager Facet MUST also follow the processing rules specified in the following sections.

3.2.5.3.1 Receiving an XAUSER_XACT_MTAG_OPEN Message

When the [XA Subordinate Transaction Manager Facet](#) receives an [XAUSER_XACT_MTAG_OPEN](#) message, it MUST perform the following actions:

- If the connection state is Idle:
 - Set the connection state to [Processing Open Request](#).
 - Attempt to find an XA Superior Object in the XA Superior Table keyed by the **guidXaRm** field of the message.
 - If not found:
 - Send an [XAUSER_XACT_MTAG_OPEN_NOT_FOUND](#) message using the connection.
 - Set the connection state to Ended.
 - Otherwise:
 - Attempt to find XA Superior Enlistment Object in XA Superior Enlistment Table referenced by the XA Superior Object that meet both of the following criteria:
 - The **XID** field is set to the **XAIdentifier** field of the [XA_UOW](#) structure in the **XAUOW** field of the message.
 - Coupling set to Loose.
 - If not found:
 - Send an XAUSER_XACT_MTAG_OPEN_NOT_FOUND message using the connection.
 - Set the connection state to Ended.
 - Otherwise:
 - Set the **State** field of receiving connection to **Active**.
 - Set the **State** field of the XA Superior Enlistment Object to **Active**.
 - Set the XA Superior Enlistment Object referenced by the receiving XA Superior Enlistment CMP Connection Object to the located XA Superior Enlistment Object.
 - Send an [XAUSER_XACT_MTAG_OPENED](#) message with the following arguments:
 - **Transaction Identifier** of the Transaction Object referenced by the located XA Superior Enlistment Object.
- Otherwise, the message MUST be processed as an invalid message as specified in section [3.1.6](#).

3.2.5.3.2 Receiving an XAUSER_XACT_MTAG_PREPARE Message

When the [XA Subordinate Transaction Manager Facet](#) receives an [XAUSER_XACT_MTAG_PREPARE](#) message, it MUST perform the following actions:

- If the Connection state is set to Active and the State field of the XA Superior Enlistment Object referenced by the XA Superior Enlistment CMP Connection is set to Active:
 - Set Current Request CMP Connection field of XA Superior Enlistment Object referenced by the XA Superior Enlistment CMP Connection to receiving connection.
 - If the **Single Phase** field of the message is set to 0x00000001:
 - Set the **State** field of the XA Superior Enlistment Object referenced by the XA Superior Enlistment CMP Connection to Preparing Single Phase.
 - Otherwise:
 - Set the **State** field of the XA Superior Enlistment Object referenced by the XA Superior Enlistment CMP Connection to Preparing.
 - Signal the Begin Phase Zero event ([\[MS-DTCO\]](#) section 3.2.7.5) on the Core Transaction Manager Facet with the following argument:
 - The Transaction Object referenced by the XA Superior Enlistment Object referenced by the XA Superior Enlistment CMP Connection.
- Otherwise if the Connection state is set to Active and the **State** field of the XA Superior Enlistment Object referenced by the XA Superior Enlistment CMP Connection is set to Aborted:
 - Send an [XAUSER_XACT_MTAG_PREPARE_ABORT](#) message using the connection.
 - Remove XA Superior Enlistment Object referenced by the XA Superior Enlistment CMP Connection from the XA Superior Enlistment Table referenced by the XA Superior Object indexed in the XA Superior Table by **Resource Manager Recovery GUID** field of the XA Superior Enlistment Object.
 - Set the connection state to Ended.
- Otherwise:
 - Send [XAUSER_XACT_MTAG_REQUEST_FAILED_BAD_PROTOCOL](#) message upon receiving connection.

3.2.5.3.3 Receiving an XAUSER_XACT_MTAG_COMMIT Message

When the [XA Subordinate Transaction Manager Facet](#) receives an [XAUSER_XACT_MTAG_COMMIT](#) message, it MUST perform the following actions:

- If the Connection state is set to Active and the **State** field of the XA Superior Enlistment Object referenced by the XA Superior Enlistment CMP Connection is set to either Prepared or In Doubt:
 - Set the Current Request CMP Connection field of XA Superior Enlistment referenced by the XA Superior Enlistment CMP Connection to receiving connection.
 - Set the **State** field of XA Superior Enlistment Object referenced by the XA Superior Enlistment CMP Connection to Committing.
 - Signal the Begin Commit event on the Core Transaction Manager Facet with the following argument:
 - The Transaction Object referenced by the XA Superior Enlistment Object referenced by the XA Superior Enlistment CMP Connection.

- Otherwise:
 - Send [XAUSER XACT MTAG REQUEST FAILED BAD PROTOCOL](#) message upon receiving connection.

3.2.5.3.4 Receiving an XAUSER_XACT_MTAG_ABORT Message

When the [XA Subordinate Transaction Manager Facet](#) receives an [XAUSER XACT MTAG ABORT](#) message, it MUST perform the following actions:

- If the Connection state is set to Active and the **State** field of the XA Superior Enlistment Object referenced by the XA Superior Enlistment CMP Connection is set to Aborted:
 - Send an [XAUSER XACT MTAG REQUEST COMPLETED](#) message.
 - Remove the XA Superior Enlistment Object referenced by the XA Superior Enlistment CMP Connection from the XA Superior Enlistment Table of the XA Superior Object indexed in the XA Superior Table by the **Resource Manager Recovery GUID** of the XA Superior Enlistment Object.
- Otherwise, if the Connection state is set to **Active** and the **State** field of the XA Superior Enlistment Object referenced by the XA Superior Enlistment CMP Connection is set to either Active, Prepared, or In Doubt:
 - Set the Current Request CMP Connection field of XA Superior Enlistment referenced by the XA Superior Enlistment CMP Connection to receiving connection.
 - Set the **State** field of XA Superior Enlistment Object referenced by the XA Superior Enlistment CMP Connection to Aborting.
 - Signal the Begin Rollback event ([\[MS-DTCO\]](#) section 3.2.7.6) on the Core Transaction Manager Facet with the following argument:
 - The Transaction Object referenced by the XA Superior Enlistment Object referenced by the XA Superior Enlistment CMP Connection.
- Otherwise:
 - Send [XAUSER XACT MTAG REQUEST FAILED BAD PROTOCOL](#) message on receiving connection.

3.2.5.3.5 Connection Disconnected

The Connection Disconnected event MUST be signaled with the following argument:

- **XA Superior Enlistment CMP Connection**

When a [CONNTYPE XAUSER XACT OPEN](#) connection (section 2.2.4.5) is disconnected, the [XA Subordinate Transaction Manager Facet](#) ([section 1.3.2.3.2](#)) SHOULD perform the following actions: [<11>](#)

- If the **State** field of the provided **XA Superior Enlistment CMP Connection** is set to **Active** and the **State** field of the **XA Superior Enlistment Object** referenced by the provided **XA Superior Enlistment CMP Connection** is set to **Active** or **Preparing**:
 - Set the **State** field of the **XA Superior Enlistment Object** referenced by the provided **XA Superior Enlistment CMP Connection** to **Aborting**.
 - If the **Current Request CMP Connection** field of the **XA Superior Enlistment Object** referenced by the provided **XA Superior Enlistment CMP Connection** is set to the **provided XA Superior Enlistment CMP Connection**:

- Remove the reference to the **XA Superior Enlistment CMP Connection** from the **Current Request CMP Connection field** of the **XA Superior Enlistment Object**.
- Signal the Begin Rollback ([\[MS-DTCO\]](#) section 3.2.7.6) event on the Core Transaction Manager Facet with the following argument:
 - The **Transaction Object** referenced by the **XA Superior Enlistment Object** referenced by the provided **XA Superior Enlistment CMP Connection**.

3.2.5.4 CONNTYPE_XAUSER_XACT_MIGRATE as Acceptor

This is an XA Superior Enlistment CMP Connection.

For all messages received in this [Connection Type](#), the [XA Subordinate Transaction Manager Facet](#) MUST process the message as specified in section [3.1](#). The XA Subordinate Transaction Manager Facet MUST also follow the processing rules specified in the following sections.

3.2.5.4.1 Receiving an XAUSER_XACT_MTAG_SUSPEND_WITH_MIGRATE Message

When the XA Subordinate Transaction Manager Facet receives an [XAUSER_XACT_MTAG_SUSPEND_WITH_MIGRATE](#) message, it MUST perform the following actions:

- If the connection state is [Idle](#):
 - Set the connection state to [Processing Migrate Request](#).
 - Attempt to find an XA Superior Object in the XA Superior Table keyed by the **guidXaRm** field of the message.
 - If the Object is not found:
 - Send an [XAUSER_XACT_MTAG_OPEN_NOT_FOUND](#) message using the connection.
 - Set the connection state to [Ended](#).
 - Otherwise:
 - Attempt to find XA Superior Enlistment Object in XA Superior Enlistment Table referenced by the XA Superior Object that meets one of the following conditions:
 - The **XID** field is set to the **XAIdentifier** field of the message.
 - The Coupling field is set to **Tight** and has a Child Branch Table which contains an XA Superior Child Branch Enlistment Object with a XID field set to the value of the **XAIdentifier** field of the message.
 - If an Object is not found:
 - Send an XAUSER_XACT_MTAG_OPEN_NOT_FOUND message using the connection.
 - Set the connection state to Ended.
 - Otherwise:
 - If first condition was satisfied:
 - If the **State** field of the XA Superior Enlistment Object is set to Active:
 - Set the **State** field of XA Superior Enlistment Object to Migrate.
 - Send an [XAUSER_XACT_MTAG_SUSPEND_WITH_MIGRATE_DONE](#) message.

- Set the connection state to Ended.
- Otherwise, if second condition was satisfied:
 - If the **State** field of the XA Superior Child Branch Enlistment Object is set to Active:
 - Set the **State** field of XA Superior Child Branch Enlistment Object to Migrate.
 - Send an XAUSER_XACT_MTAG_SUSPEND_WITH_MIGRATE_DONE message.
 - Set the connection state to Ended.
- Otherwise, the message MUST be processed as an invalid message as specified in section [3.1.6](#).

3.2.5.4.2 Receiving an XAUSER_XACT_MTAG_RESUME Message

When the [XA Subordinate Transaction Manager Facet](#) receives an [XAUSER_XACT_MTAG_RESUME](#) message, it MUST perform the following actions:

- If the connection state is [Idle](#):
 - Set the connection state to [Processing Migrate Request](#).
 - Attempt to find an XA Superior Object in the XA Superior Table referenced by this connection keyed by the **guidXaRm** field of the message.
 - If an Object is not found:
 - Send an [XAUSER_XACT_MTAG_OPEN_NOT_FOUND](#) message using the connection.
 - Set the connection state to [Ended](#).
 - Otherwise:
 - Attempt to find XA Superior Enlistment Object in XA Superior Enlistment Table referenced by the XA Superior Object that meets one of the following conditions:
 - The **XID** field is set to the **XAIdentifier** field of the message.
 - The **Coupling** field of the XA Superior Enlistment Object is set to **Tight** and has a Child Branch Table which contains an XA Superior Child Branch Enlistment Object with a XID field set to the value of the **XAIdentifier** field of the message.
 - If an Object is not found:
 - Send an XAUSER_XACT_MTAG_OPEN_NOT_FOUND message using the connection.
 - Otherwise:
 - If first condition was satisfied:
 - If the **State** field of the XA Superior Enlistment Object is set to Migrate:
 - Set **State** field of the XA Superior Enlistment Object to Active.
 - Send an XAUSER_XACT_MTAG_OPEN_NOT_FOUND message.
 - Otherwise:
 - Send an [XAUSER_XACT_MTAG_TRANSACTION_NOT_SUSPENDED](#) message.

- Otherwise, if second condition was satisfied:
 - If the **State** field of the XA Superior Child Branch Enlistment Object is set to Migrate:
 - Set **State** field of the XA Superior Child Branch Enlistment Object to Active.
 - Send an [XAUSER_XACT_MTAG_RESUME_DONE](#) message.
 - Otherwise:
 - Send an XAUSER_XACT_MTAG_TRANSACTION_NOT_SUSPENDED message.
- Set the connection state to Ended.
- Otherwise, the message MUST be processed as an invalid message as specified in section [3.1.6](#).

3.2.5.5 CONNTYPE_XAUSER_XACT_BRANCH_START as Acceptor

This is an XA Superior Enlistment CMP Connection.

For all messages received in this [Connection Type](#), the [XA Subordinate Transaction Manager Facet](#) MUST process the message as specified in the [Common Details](#) section. The XA Subordinate Transaction Manager Facet MUST also follow the processing rules specified in the following sections.

3.2.5.5.1 Receiving an XAUSER_XACT_MTAG_START Message

When the [XA Subordinate Transaction Manager Facet](#) receives an [XAUSER_XACT_MTAG_START](#) message, it MUST perform the following actions:

- If the connection state is Idle:
 - Set the connection state to Processing Start Request.
 - Attempt to find the XA Superior Object in the XA Superior Table keyed by the **guidXaRm** field of the message.
 - If an Object is found:
 - Use this as the XA Superior Object in the remainder of the processing of this event.
 - Otherwise:
 - Attempt to create a new XA Superior Object with the following values:
 - Set the **Open Count** field to 1.
 - If the creation of the new XA Superior Object fails:
 - Send an [XAUSER_XACT_MTAG_START_NO_MEM](#) message using the connection.
 - Set the connection state to Ended.
 - Processing for this event is complete.
 - Otherwise:
 - Add the new XA Superior Object to the XA Superior Table referenced by the XA Subordinate Transaction Manager Facet with the **guidXaRm** field of the message as its key.

- Use the created XA Superior Object as the XA Superior Object in the remainder of the processing of this event.
- Attempt to find the XA Superior Enlistment Object in the XA Superior Enlistment Table referenced by the XA Superior Object that meets both of the following conditions:
 - The XID field is set to the value of the **XAIdentifier** field of the [XA_UOW](#) structure (section 2.2.1.4) contained within the **XAUow** field of the message.
 - The **Coupling** field is set to **Tight**.
- If an Object is found:
 - Send an [XAUSER_XACT_MTAG_START_DUPLICATE](#) message using the connection.
 - Set the connection state to Ended.
- Otherwise:
 - Attempt to find the XA Superior Enlistment Object in the XA Superior Enlistment Table referenced by the XA Superior Object that meets all of the following conditions:
 - The **XA Global Transaction Identifier** field of the **XID** field of the XA Superior Enlistment Object is set to the XA Global Transaction Identifier field of the value of the **XAIdentifier** field of the **XA_UOW** structure contained within the **XAUow** field of the message.
 - The **Coupling** field is set to Tight.
 - The **State** field set to Active or Migrate.
 - If an Object is not found:
 - Attempt to create a new XA Superior Enlistment Object with the following values:
 - The **Coupling** field is set to Tight.
 - The **Resource Manager Recovery GUID** is set to **guidXaRm** field of the message.
 - The XID field is set to the value of the **XAIdentifier** field of the **XA_UOW** structure contained within the **XAUow** field of the message.
 - The **State** field is set to Init.
 - The Current Request CMP connection Object is set to receiving connection.
 - If failed:
 - Send an XAUSER_XACT_MTAG_START_NO_MEM message using the connection.
 - Set the connection state to Ended.
 - Otherwise:
 - Create a new GUID as specified in [\[RFC4122\]](#).
 - Attempt to create a new Transaction with the following settings:
 - The **Isolation Level** field is set to the **isoLevel** field of the message or 0.
 - The **Timeout** field is set to the **Timeout** field of the message or 0.

- The **Description** field is set to the **szDesc** field of the message or "".
- The **Isolation Flags** field is set to the **isoFlags** field of the message or 0.
- The **Transaction Object.Identifier** field is set to the GUID created in the previous step.
- If failed:
 - Send an XAUSER_XACT_MTAG_START_NO_MEM message using the connection.
 - Set the connection state to Ended.
- Otherwise:
 - Set the **Transaction** field of the XA Superior Enlistment Object to the newly created Transaction.
 - Signal the Create Superior Enlistment event on the Core Transaction Manager Facet with the following argument:
 - The XA Superior Enlistment Object.
- Otherwise:
 - If the XA Superior Enlistment Object has an XA Superior Child Branch Enlistment Object in Child Branch table with the XID field set to the value of the **XAIdentifier** field of the **XA_UOW** structure contained within the **XAUow** field of the message:
 - Send an XAUSER_XACT_MTAG_START_DUPLICATE message using the connection.
 - Set the connection state to Ended.
 - Otherwise:
 - Attempt to create a new XA Superior Child Branch Enlistment Object with the following values:
 - The XID field is set to the value of the **XAIdentifier** field of the **XA_UOW** structure contained within the **XAUow** field of the message.
 - The **State** field is set to Active.
 - The Parent XA Superior Enlistment Object set to found XA Superior Enlistment Object.
 - If failure:
 - Send an XAUSER_XACT_MTAG_START_NO_MEM message using the connection.
 - Set the connection state to Ended.
 - Otherwise:
 - Add the XA Superior Child Branch Enlistment Object to the XA Superior Enlistment Object's Child Branch Table.
 - Set the **State** field of receiving connection to Active.

- Set the XA Superior Child Branch Enlistment Object reference of the receiving connection to the new XA Superior Child Branch Enlistment.
- Send an [XAUSER_XACT_MTAG_STARTED](#) message with the following arguments:
 - **Transaction Identifier** of the Transaction Object referenced by the found XA Superior Enlistment Object.
- Otherwise, the message MUST be processed as an invalid message as specified in section [3.1.6](#).

3.2.5.5.2 Connection Disconnected

The Connection Disconnected event MUST be signaled with the following argument:

- **XA Superior Enlistment CMP Connection.**

When a [CONNTYPE_XAUSER_XACT_BRANCH_START](#) connection (section 2.2.4.4) is disconnected, the [XA Subordinate Transaction Manager Facet \(section 1.3.2.3.2\)](#) SHOULD perform the following actions: [<12>](#)

- Test if the provided **XA Superior Enlistment CMP Connection** satisfies the following conditions:
 - The **State** field of the provided **XA Superior Enlistment CMP Connection** is set to **Active**.
 - The **XA Superior Enlistment Object** referenced by the **XA Superior Enlistment CMP Connection** references an **XA Superior Enlistment Object**.
 - The **State** field of the **XA Superior Enlistment Object** referenced by the provided **XA Superior Enlistment CMP Connection** is set to either **Active** or **Preparing**.
- If the conditions are met, perform the following actions:
 - Set the **State** field of the **XA Superior Enlistment Object** to **Aborting**.
 - If the **Current Request CMP Connection** field of the **XA Superior Enlistment Object** referenced by the provided **XA Superior Enlistment CMP Connection** is set to the provided **XA Superior Enlistment CMP Connection**:
 - Remove the reference to the **XA Superior Enlistment CMP Connection** from the **Current Request CMP Connection** field of the **XA Superior Enlistment Object**.
 - Signal the Begin Rollback event ([\[MS-DTCO\]](#) section 3.2.7.6) on the Core Transaction Manager Facet with the following argument:
 - The **Transaction Object** referenced by the **XA Superior Enlistment Object** referenced by provided **XA Superior Enlistment CMP Connection**.
- Test if the provided **XA Superior Enlistment CMP Connection** satisfies the following conditions:
 - The **State** field of the provided **XA Superior Enlistment CMP Connection** is set to **Active**.
 - The **XA Superior Enlistment Object** referenced by **XA Superior Enlistment CMP Connection** references an **XA Superior Child Branch Enlistment Object**.
 - The **State** field of the **XA Superior Enlistment Object** referenced by the provided **XA Superior Enlistment CMP Connection** is set to **Active**.
- If the conditions are met, perform the following actions:

- Set the **State** field of the **Parent XA Superior Enlistment of XA Child Branch Enlistment** to **Aborting**.
- If the **Current Request CMP Connection** field of the **XA Child Branch Enlistment Object** referenced by the provided **Connection** is set to the provided **XA Superior Enlistment CMP Connection**:
 - Remove the reference to the **XA Child Branch Enlistment Object** from the **Current Request CMP Connection** field of the **XA Child Branch Enlistment Object**.
- Signal the Begin Rollback event ([MS-DTCO] section 3.2.7.6) on the Core Transaction Manager Facet with the following argument:
 - The **Transaction Object**, referenced by the **Parent XA Superior Enlistment Object**, referenced by the **XA Superior Child Branch Enlistment**.

3.2.5.6 CONNTYPE_XAUSER_XACT_BRANCH_OPEN as Acceptor

This is an XA Superior Enlistment CMP Connection.

For all messages received in this [Connection Type](#), the [XA Subordinate Transaction Manager Facet](#) MUST process the message as specified in section [3.1](#). The XA Subordinate Transaction Manager Facet MUST also follow the processing rules specified in the following sections.

3.2.5.6.1 Receiving an XAUSER_XACT_MTAG_OPEN Message

When the XA Subordinate Transaction Manager Facet receives an [XAUSER_XACT_MTAG_OPEN](#) message, it MUST perform the following actions:

- If the connection state is Idle:
 - Set the connection state to Processing Open Request.
 - Attempt to find an XA Superior Object in the XA Superior Table referenced by this connection keyed by the **guidXaRm** field of the message.
 - If an Object is not found:
 - Send an [XAUSER_XACT_MTAG_OPEN_NOT_FOUND](#) message using the connection.
 - Set the connection state to Ended.
- Otherwise:
 - Attempt to find XA Superior Enlistment Object in XA Superior Enlistment Table referenced by the XA Superior Object that meets one of the following conditions:
 - The **XID** field is set to the **XAIdentifier** field of the message.
 - The **Coupling** field of the XA Superior Enlistment Object is set to **Tight** and the **XA Global Transaction Identifier** field of the **XID** field of the XA Superior Enlistment Object is set to the GUID structure contained within the **Data** field of the [XA_XID](#) structure (section 2.2.1.3) contained within the **XAIdentifier** field of the [XA_UOW](#) structure (section 2.2.1.4) contained within the **XAUow** field of the message.
 - If an Object is not found:
 - Send an XAUSER_XACT_MTAG_OPEN_NOT_FOUND message using the connection.
 - Set the connection state to Ended.

- Otherwise:
 - If the Child Branch Table referenced by the XA Superior Enlistment Object does not contain an XA Superior Child Branch Enlistment Object with a **XID** field set to the value of the **XAIdentifier** field of the message.
 - Send an `XAUSER_XACT_MTAG_REQUEST_FAILED_BAD_PROTOCOL` using the connection.
 - Otherwise:
 - Set the **State** field of receiving connection to Active.
 - Set the **State** field of the XA Superior Child Branch Enlistment Object to Active.
 - Set the XA Superior Child Branch Enlistment Object reference of the receiving connection to the found XA Superior Child Branch Enlistment Object.
 - Send an `XAUSER_XACT_MTAG_OPENED` message with the following argument:
 - **Transaction Identifier** of the Transaction Object referenced by the found XA Superior Enlistment Object.
- Otherwise, the message MUST be processed as an invalid message as specified in section [3.1.6](#).

3.2.5.6.2 Receiving an `XAUSER_XACT_MTAG_PREPARE` Message

When the [XA Subordinate Transaction Manager Facet](#) receives an `XAUSER_XACT_MTAG_PREPARE` message, it MUST perform the following actions:

- If the XA Superior Enlistment Object referenced by the XA Superior Enlistment CMP Connection is set:
 - If the Connection state is set to Active and the State field of the XA Superior Enlistment Object referenced by the XA Superior Enlistment CMP Connection is set to Active:
 - If the **fSinglePhase** field of the message is set to 0x00000001:
 - If the Child Branch Table referenced by the XA Superior Enlistment Object referenced by the receiving connection is not empty:
 - Send `XAUSER_XACT_MTAG_REQUEST_FAILED_BAD_PROTOCOL` message on receiving connection.
 - The processing for this message is complete.
 - Set the **State** field of the XA Superior Enlistment Object referenced by the XA Superior Enlistment CMP Connection to Preparing Single Phase.
 - Otherwise:
 - Set **State** field of the XA Superior Enlistment Object referenced by the XA Superior Enlistment CMP Connection to Preparing.
 - Set Current Request CMP Connection field of the XA Superior Enlistment referenced by the XA Superior Enlistment CMP Connection to receiving connection.
 - If Wait For All XA Branch Prepares flag is not set:
 - Signal the Begin Phase Zero event on the Core Transaction Manager Facet with the following argument:

- The Transaction Object, referenced by the XA Superior Enlistment Object, referenced by the XA Superior Enlistment CMP Connection.
- Otherwise, if the Connection state is set to Active and the State field of the XA Superior Enlistment Object referenced by the XA Superior Enlistment CMP Connection is set to Aborted:
 - Send [XAUSER_XACT_MTAG_PREPARE_ABORT](#) message.
 - Remove the XA Superior Enlistment Object referenced by the XA Superior Enlistment CMP Connection from the XA Superior Enlistment Table of the XA Superior Object indexed in the XA Superior Table by the **Resource Manager Recovery GUID** of the XA Superior Enlistment Object.
 - Set the connection state to Ended.
- Otherwise, the message MUST be processed as an invalid message as specified in section [3.1.6](#).
- Otherwise, if the XA Superior Child Branch Enlistment Object referenced by the receiving connection is set:
 - If the **fSinglePhase** field of the message is set to 0x00000001:
 - Send XAUSER_XACT_MTAG_REQUEST_FAILED_BAD_PROTOCOL message on receiving connection.
 - The processing for this message is complete.
 - If the Connection state is set to Active and the State field of the XA Superior Child Branch Enlistment Object is set to Active:
 - Remove the XA Superior Child Branch Enlistment from the Child Branch Table referenced by its Parent XA Superior Enlistment Object.
 - Send [XAUSER_XACT_MTAG_READONLY](#) message on receiving connection.
 - If the Child Branch Table referenced by the Parent XA Superior Enlistment Object referenced by the XA Superior Child Branch Enlistment Object is empty and Wait For All XA Branch Prepares flag is set:
 - Signal the Begin Phase Zero event on the Core Transaction Manager Facet with the following argument:
 - The Transaction Object referenced by the Parent XA Superior Enlistment Object referenced by the XA Superior Child Branch Enlistment Object.
- Otherwise:
 - Send XAUSER_XACT_MTAG_REQUEST_FAILED_BAD_PROTOCOL message upon receiving connection.

3.2.5.6.3 Receiving an XAUSER_XACT_MTAG_COMMIT Message

When the [XA Subordinate Transaction Manager Facet](#) receives an [XAUSER_XACT_MTAG_COMMIT](#) message, it MUST perform the following actions:

- If the Connection state is set to Active and the State field of the XA Superior Enlistment Object referenced by the XA Superior Enlistment CMP Connection is set to either Prepared or In Doubt:
 - Set Current Request CMP Connection field of XA Superior Enlistment Object referenced by the XA Superior Enlistment CMP Connection to receiving connection.

- Set State field of the XA Superior Enlistment Object referenced by the XA Superior Enlistment CMP Connection to Committing.
- Signal the Begin Commit event ([\[MS-DTCO\]](#) section 3.2.7.2) on the Core Transaction Manager Facet with the following argument:
 - The Transaction Object, referenced by the XA Superior Enlistment Object, referenced by the XA Superior Enlistment CMP Connection.
- Otherwise:
 - Send a [XAUSER_XACT_MTAG_REQUEST_FAILED_BAD_PROTOCOL](#) message upon receiving connection.

3.2.5.6.4 Receiving an XAUSER_XACT_MTAG_ABORT Message

When the XA Subordinate Transaction Manager Facet receives an [XAUSER_XACT_MTAG_ABORT](#) message, it MUST perform the following actions:

- If the receiving connection references XA Superior Enlistment:
 - If the Connection state is set to Active and the State field of the XA Superior Enlistment Object referenced by the XA Superior Enlistment CMP Connection is set to Aborted:
 - Send an [XAUSER_XACT_MTAG_REQUEST_COMPLETED](#) message.
 - Remove XA Superior Enlistment Object from the XA Superior Enlistment Table of the XA Superior Object indexed in the XA Superior Table by the **Resource Manager Recovery GUID** of the XA Superior Enlistment Object.
 - Otherwise if the Connection state is set to Active and the State field of the XA Superior Enlistment Object referenced by the XA Superior Enlistment CMP Connection is set to either Active, Prepared, or In Doubt:
 - Set Current Request CMP Connection field of XA Superior Enlistment Object referenced by the XA Superior Enlistment CMP Connection to receiving connection.
 - Set **State** field of XA Superior Enlistment Object referenced by the XA Superior Enlistment CMP Connection to Aborting.
 - Signal the Begin Rollback event ([\[MS-DTCO\]](#) section 3.2.7.6) on the Core Transaction Manager Facet with the following argument:
 - The Transaction Object referenced by the XA Superior Enlistment Object referenced by the XA Superior Enlistment CMP Connection.
 - Otherwise, if the Connection state is set to Active and the State field of the XA Superior Enlistment Object referenced by the XA Superior Enlistment CMP Connection is set to Aborting and Current Request CMP Connection referenced by XA Superior Enlistment referenced by the XA Superior Enlistment CMP Connection is not set:
 - Set Current Request CMP Connection field of XA Superior Enlistment referenced by the XA Superior Enlistment CMP Connection to receiving connection.
 - Set the Connection state to Ended.
 - Otherwise, the message MUST be processed as an invalid message as specified in section [3.1.6](#).
- Otherwise, if receiving connection references XA Superior Child Branch Enlistment:

- If the Connection state is set to Active and the State field of the Parent XA Superior Enlistment Object referenced by XA Superior Child Branch Enlistment referenced by receiving connection is set to Aborted:
 - Send XAUSER_XACT_MTAG_REQUEST_COMPLETED message.
 - Remove the XA Superior Child Branch Enlistment from the Child Branch table referenced by the Parent XA Superior Enlistment Object referenced by the XA Superior Child Branch Enlistment.
- Otherwise, if the Connection state is set to Active and the State field of the XA Superior Enlistment is set to either Active, Prepared, or In Doubt:
 - Set Current Request CMP Connection field of the XA Superior Child Branch Enlistment to receiving connection.
 - Set the State field of Parent XA Superior Enlistment referenced by XA Superior Child Branch Enlistment to Aborting.
 - Signal the Begin Rollback event ([MS-DTCO] section 3.2.7.6) on the Core Transaction Manager Facet with the following argument:
 - The Transaction Object referenced by Parent XA Superior Enlistment Object.
- Otherwise, if the Connection state is set to Active and the State field of the XA Superior Enlistment Object is set to Aborting and Current Request CMP Connection referenced by XA Superior Enlistment is not set:
 - Set Current Request CMP Connection field of XA Superior Child Branch Enlistment to receiving connection.
- Otherwise:
 - Send a [XAUSER_XACT_MTAG_REQUEST_FAILED_BAD_PROTOCOL](#) message upon receiving connection.

3.2.5.6.5 Connection Disconnected

The Connection Disconnected event MUST be signaled with the following argument:

- **XA Superior Enlistment CMP Connection.**

When a [CONNTYPE XAUSER_XACT_BRANCH_OPEN](#) connection (section 2.2.4.6) is disconnected, the **XA Subordinate Transaction Manager Facet** SHOULD perform the following actions: [<13>](#)

- If the **Connection** state is set to **Active** and the **State** field of the **XA Superior Enlistment Object** referenced by the provided **XA Superior Enlistment CMP Connection** is set to either **Active** or **Preparing**:
 - Set the **State** field of the **XA Superior Enlistment Object** referenced by the provided **XA Superior Enlistment CMP Connection** to **Aborting**.
 - If the **Current Request CMP Connection** field of the **XA Superior Enlistment** referenced by the provided **XA Superior Enlistment CMP Connection** is set to the provided **XA Superior Enlistment CMP Connection**:
 - Remove the reference to the **XA Superior Enlistment CMP Connection** from the **Current Request CMP Connection** field of the **XA Superior Enlistment Object**.
- Signal the Begin Rollback event ([\[MS-DTCO\]](#) section 3.2.7.6) on the Core Transaction Manager Facet with the following argument:

- The **Transaction Object** referenced by the **XA Superior Enlistment Object** referenced by the provided **XA Superior Enlistment CMP Connection**.
- If the **Connection** state is set to **Active** and the **State** field of the **XA Superior Child Branch Enlistment Object** is set to either **Active** or **Preparing**:
 - Set the **State** field of the **Parent XA Superior Enlistment Object** of the **XA Superior Child Branch Enlistment** to **Aborting**.
 - If the **Current Request CMP Connection** field of the **XA Child Branch Enlistment Object** referenced by the provided **Connection** is set to the provided **XA Superior Enlistment CMP Connection**:
 - Remove the reference to the **XA Superior Enlistment CMP Connection** from the **Current Request CMP Connection** field of the **XA Superior Enlistment Object**.
 - Signal the Begin Rollback event ([MS-DTCO] section 3.2.7.6) on the Core Transaction Manager Facet with the following argument:
 - The **Transaction Object** referenced by the **Parent XA Superior Enlistment** of the **XA Child Branch Enlistment**.

3.2.5.7 CONNTYPE_XAUSER_XACT_MIGRATE2 as Acceptor

This is an XA Superior Enlistment CMP Connection.

For all messages received in this [Connection Type](#), the [XA Subordinate Transaction Manager Facet](#) MUST process the message as specified in section [3.1](#). The XA Subordinate Transaction Manager Facet MUST also follow the processing rules specified in the following sections.

3.2.5.7.1 Receiving an XAUSER_XACT_MTAG_SUSPEND_WITH_MIGRATE Message

When the [XA Subordinate Transaction Manager Facet](#) receives an [XAUSER_XACT_MTAG_SUSPEND_WITH_MIGRATE](#) message, it MUST perform the following actions:

- If the connection state is [Idle](#):
 - Set the connection state to [Processing Migrate2 Request](#).
 - Attempt to find an XA Superior Object in the XA Superior Table keyed by the **guidXaRm** field of the message.
 - If an Object is not found:
 - Send an [XAUSER_XACT_MTAG_OPEN_NOT_FOUND](#) message using the connection.
 - Otherwise:
 - Attempt to find an XA Superior Enlistment Object in the XA Superior Enlistment Table referenced by the XA Superior Object that meets one of the following conditions:
 - The **XID** field is set to the value of the **XAIdentifier** field in the message.
 - The **Coupling** field is set to **Tight** and has a **Child Branch Table** that contains an XA Superior Child Branch Enlistment Object with an XID field set to the value of the **XAIdentifier** field of the message.
 - If an Object is not found:
 - Send an XAUSER_XACT_MTAG_OPEN_NOT_FOUND message using the connection.

- Otherwise:
 - If first condition was satisfied:
 - If the **State** field of the XA Superior Enlistment Object is set to Active:
 - Set the **State** field of the XA Superior Enlistment Object to Migrate.
 - Send an [XAUSER_XACT_MTAG_SUSPEND_WITH_MIGRATE_DONE](#) message.
 - Otherwise:
 - Send an XAUSER_XACT_MTAG_OPEN_NOT_FOUND message.
 - Otherwise if second condition was satisfied:
 - If the **State** field of the XA Superior Child Branch Enlistment is set to Active:
 - Set the **State** field of the XA Superior Child Branch Enlistment to Migrate.
 - Send an XAUSER_XACT_MTAG_SUSPEND_WITH_MIGRATE_DONE message.
 - Otherwise:
 - Send an XAUSER_XACT_MTAG_OPEN_NOT_FOUND message.
- Set the connection state to [Ended](#).
- Otherwise, the message MUST be processed as an invalid message as specified in section [3.1.6](#).

3.2.5.7.2 Receiving an XAUSER_XACT_MTAG_RESUME Message

When the [XA Subordinate Transaction Manager Facet](#) receives an [XAUSER_XACT_MTAG_RESUME](#) message, it MUST perform the following actions:

- If the connection state is [Idle](#):
 - Set the connection state to [Processing Migrate2 Request](#).
 - Attempt to find an XA Superior Object in the XA Superior Table keyed by the **guidXaRm** field of the message.
 - If an Object is not found:
 - Send an [XAUSER_XACT_MTAG_OPEN_NOT_FOUND](#) message using the connection.
 - Otherwise:
 - Attempt to find XA Superior Enlistment Object in XA Superior Enlistment Table referenced by the XA Superior Object that meets one of the following conditions:
 - The **XID** field is set to the value of the **XAIdentifier** field of the message.
 - The **Coupling** field is set to **Tight** and has a Child Branch Table which contains an XA Superior Child Branch Enlistment Object with a XID field set to the value of the **XAIdentifier** field of the message.
 - If an Object is not found:
 - Send an XAUSER_XACT_MTAG_OPEN_NOT_FOUND message using the connection.
 - Otherwise:

- If first condition was satisfied:
 - If **State** field of the XA Superior Enlistment Object is set to Migrate:
 - Set the **State** field of the XA Superior Enlistment Object to Active.
 - Send an [XAUSER_XACT_MTAG_RESUME_DONE](#) message with the following value:
 - **Transaction Identifier** of the Transaction Object referenced by the found XA Superior Enlistment Object.
 - Otherwise:
 - Send an [XAUSER_XACT_MTAG_TRANSACTION_NOT_SUSPENDED](#) message.
- Otherwise if second condition was satisfied:
 - If **State** field of the XA Superior Child Branch Enlistment Object is set to Migrate:
 - Set the **State** field of the XA Superior Child Branch Enlistment to Active.
 - Send an XAUSER_XACT_MTAG_RESUME_DONE message with the following argument:
 - Transaction Identifier of the Transaction Object referenced by the found XA Superior Enlistment Object.
 - Otherwise:
 - Send an XAUSER_XACT_MTAG_TRANSACTION_NOT_SUSPENDED message.
- Set the connection state to [Ended](#).
- Otherwise, the message MUST be processed as an invalid message as specified in section [3.1.6](#).

3.2.6 Timer Events

This role has no protocol-specific timer events.

3.2.7 Other Local Events

3.2.7.1 Commit Complete

The Commit Complete event MUST be signaled with the following arguments:

- An XA Superior Enlistment Object.

If the Commit Complete event is signaled, the [XA Subordinate Transaction Manager Facet](#) MUST perform the following actions:

- If the **State** field of the provided XA Superior Enlistment Object is set to Committing:
 - Set the **State** field of the provided XA Superior Enlistment Object to Committed.
 - Send an [XAUSER_XACT_MTAG_REQUEST_COMPLETED](#) message using the connection referenced by the Current Request CMP Connection field of the provided XA Superior Enlistment Object.

- Disconnect the Current Request CMP Connection field of the provided XA Superior Enlistment Object.
- Remove the provided XA Superior Enlistment Object from the XA Superior Enlistment Table, referenced by the XA Superior Object indexed in the XA Superior Table by the **Resource Manager Recovery GUID** field of the provided XA Superior Enlistment Object.

3.2.7.2 Create Superior Enlistment Success

The Create Superior Enlistment Success event MUST be signaled with the following arguments:

- An XA Superior Enlistment Object.

If the Create Superior Enlistment Success event is signaled, the [XA Subordinate Transaction Manager Facet](#) MUST perform the following actions:

- If the **State** field of the provided XA Superior Enlistment Object is set to Init:
 - Attempt to find XA Superior Object in XA Superior Table keyed by the **Resource Manager Recovery GUID** field of the provided XA Superior Enlistment Object.
 - If an Object is not found:
 - Attempt to create a new XA Superior Object with the following values:
 - The **Open Count** field is set to 1.
 - The Current Recovery XID is set to the XID field of the provided XA Superior Enlistment Object.
 - If creation of the new XA Superior Object fails:
 - Send an [XAUSER XACT MTAG START NO MEM](#) message using the connection referenced by the Current Request CMP connection field of the XA Superior Enlistment Object.
 - The processing for this event is complete.
 - Add the provided XA Superior Enlistment Object to the XA Superior Enlistment Table referenced by the XA Superior Object indexed in the XA Superior Table by the Resource Manager Recovery GUID field of XA Superior Enlistment Object.
 - Set the **State** field of the Current Request CMP connection field of the provided XA Superior Enlistment Object to Active.
 - Set the **State** field of the provided XA Superior Enlistment Object to Active.
 - Set the XA Superior Enlistment Object reference of the XA Superior Enlistment's Current Request CMP Connection to the located XA Superior Enlistment Object.
 - Send an [XAUSER XACT MTAG STARTED](#) message with the following arguments using the connection referenced by the Current Request CMP connection field of the XA Superior Enlistment Object:
 - The **Transaction Identifier** of the Transaction Object referenced by the provided XA Superior Enlistment Object.
 - Disconnect the XA Superior Enlistment's Current Request CMP Connection Object.

3.2.7.3 Create Superior Enlistment Failure

The Create Superior Enlistment Failure event MUST be signaled with the following arguments:

- An XA Superior Enlistment Object.
- Failure Reason.

If the Create Superior Enlistment Failure event is signaled, the [XA Subordinate Transaction Manager Facet](#) MUST perform the following actions:

- If the **State** field of the provided XA Superior Enlistment Object is set to Init:
 - If Failure Reason is set to Log Full:
 - Send an [XAUSER XACT MTAG START LOG FULL](#) message using the connection referenced by the Current Request CMP connection field of the XA Superior Enlistment object.
 - Otherwise if Failure Reason is set to Duplicate:
 - Send an [XAUSER XACT MTAG START DUPLICATE](#) message using the connection referenced by the Current Request CMP connection field of the XA Superior Enlistment object.
 - Remove the provided XA Superior Enlistment Object from the XA Superior Enlistment Table referenced by the XA Superior Object indexed in the XA Superior Table by the Resource Manager Recovery GUID field of the XA Superior Enlistment Object.

3.2.7.4 Phase Zero Complete

The Phase Zero Complete event MUST be signaled with the following arguments:

- An XA Superior Enlistment Object.
- **Outcome.**

If the Phase Zero Complete event is signaled, the [XA Subordinate Transaction Manager Facet](#) MUST perform the following actions:

- If the provided Outcome is set to Failure and the Current Request CMP Connection Object referenced by the provided XA Superior Enlistment Object is set:
 - Send an [XAUSER XACT MTAG PREPARE ABORT](#) message.
 - Set State of provided XA Superior Enlistment Object to ABORTED.
 - Disconnect the Current Request CMP Connection of the provided XA Superior Enlistment Object.
 - Remove the provided XA Superior Enlistment Object from the XA Superior Enlistment Table referenced by the XA Superior Object indexed in the XA Superior Table by the **Resource Manager Recovery GUID** field of XA Superior Enlistment Object.
- Otherwise:
 - If the **State** field of the provided XA Superior Enlistment Object is set to Preparing Single Phase:
 - Signal the Begin Phase One event on the Core Transaction Manager Facet with the following arguments:

- The Transaction Object referenced by the provided XA Superior Enlistment Object.
- A Single Phase value set to TRUE.
- Otherwise if the **State** field of the provided XA Superior Enlistment Object is set to Preparing:
 - Signal the Begin Phase One event on the Core Transaction Manager Facet with the following arguments:
 - The Transaction Object referenced by the provided XA Superior Enlistment Object.
 - A Single Phase value set to FALSE.

3.2.7.5 Phase One Complete

The Phase One Complete event MUST be signaled with the following arguments:

- An XA Superior Enlistment Object.
- **Outcome.**

If the Phase One Complete event is signaled, the [XA Subordinate Transaction Manager Facet](#) MUST perform the following actions:

- If the Current Request CMP Connection Object referenced by the provided XA Superior Enlistment Object is set:
 - If the provided Outcome is set to **In Doubt**:
 - Set the **State** field of the provided XA Superior Enlistment Object to In Doubt.
 - Send an [XAUSER XACT MTAG PREPARE SINGLEPHASE INDOUBT](#) message.
 - Disconnect the Current Request CMP Connection Object referenced by the provided XA Superior Enlistment Object.
 - Otherwise if the provided Outcome value is set to Committed and the **State** field of the provided XA Superior Enlistment Object is set to Preparing Single Phase:
 - Set the **State** field of the provided XA Superior Enlistment Object to Committed.
 - Send an [XAUSER XACT MTAG REQUEST COMPLETED](#) message.
 - Disconnect the Current Request CMP Connection Object referenced by the provided XA Superior Enlistment Object.
 - Remove the provided XA Superior Enlistment Object from the XA Superior Enlistment Table referenced by the XA Superior Object indexed in the XA Superior Table by the **Resource Manager Recovery GUID** field of XA Superior Enlistment Object.
- Otherwise if Outcome value is set to Aborted:
 - Set the **State** field of the provided XA Superior Enlistment Object to Aborted.
 - Send an [XAUSER XACT MTAG PREPARE ABORT](#) message.
 - Disconnect the Current Request CMP Connection Object referenced by the provided XA Superior Enlistment Object.
 - Remove the provided XA Superior Enlistment from XA Superior's XA Superior Enlistment Table.

- Otherwise if the Outcome value is set to Prepared:
 - Set the **State** field of the provided XA Superior Enlistment Object to Prepared.
 - Send an XAUSER_XACT_MTAG_REQUEST_COMPLETED message.
 - Disconnect the Current Request CMP Connection Object referenced by the provided XA Superior Enlistment Object.
- Otherwise if Outcome value is set to ReadOnly:
 - The XA Subordinate Transaction Manager Facet will drop the connection.

3.2.7.6 Recover In Doubt Transaction

If the Recover In Doubt event is signaled, the [XA Subordinate Transaction Manager Facet](#) MUST take no action.

3.2.7.7 Rollback Complete

The Rollback Complete event MUST be signaled with the following arguments:

- An XA Superior Enlistment Object.

If the Rollback Complete event is signaled, the [XA Subordinate Transaction Manager Facet](#) MUST perform the following actions:

- If the **State** field of the provided XA Superior Enlistment Object is set to Aborting:
 - Set the **State** field of the provided XA Superior Enlistment Object to Aborted.
 - If Current Request CMP Connection Object of the provided XA Superior Enlistment Object is set:
 - Send [XAUSER_XACT_MTAG_REQUEST_COMPLETED](#) message.
 - Disconnect the Current Request CMP Connection of the provided XA Superior Enlistment Object.
 - Remove the provided XA Superior Enlistment Object from the XA Superior Enlistment Table referenced by the XA Superior Object indexed in the XA Superior Table by the **Resource Manager Recovery GUID** field of XA Superior Enlistment Object.
- Perform the following actions on each XA Superior Child Branch Enlistment Object in the **Child Branch Table** referenced by the XA Superior Enlistment Object:
 - If Current Request CMP Connection Object of XA Superior Child Branch Enlistment Object is set:
 - Send XAUSER_XACT_MTAG_REQUEST_COMPLETED message.
 - Disconnect the Current Request CMP Connection of XA Superior Child Branch Enlistment Object.
 - Remove the XA Superior Child Branch Enlistment object from the Child Branch Table referenced by Parent XA Superior Enlistment Object.

3.2.7.8 Unilaterally Aborted

The Unilaterally Aborted event MUST be signaled with the following arguments:

- An XA Superior Enlistment Object.

If the Unilaterally Aborted event is signaled, the [XA Subordinate Transaction Manager Facet](#) MUST perform the following actions:

- If the **State** field of the provided XA Superior Enlistment Object is set to Active:
 - Set the **State** field of the provided XA Superior Enlistment Object to Aborted.

3.3 XA Superior Transaction Manager Details

3.3.1 Abstract Data Model

This section describes a conceptual model of possible data organization that an implementation maintains to participate in this protocol. The described organization is provided to facilitate the explanation of how the protocol behaves. This document does not mandate the implementations adhere to this model as long as their external behavior is consistent with the behavior that is described in this document.

Note that the abstract data model can be implemented in a variety of ways. This protocol does not prescribe or advocate any specific implementation technique.

The XA Superior Transaction Manager MUST maintain all the data elements that are specified in section [3.1.1](#).

The **Superior Transaction Manager** MUST also maintain the following data elements:

- **XA Superior Proxy object:** This object represents a Superior **XA Transaction Manager** associated with a Resource Manager ID. An XA Superior Proxy object MUST contain the following elements:
 - **Transaction Manager Connection:** A connection object as defined by [\[MS-CMP\]](#) to hold the connection with the XA Subordinate Transaction Manager Facet, which has been extended to include a State data element as specified in section 3.1.1.
 - **Open Count:** Specifies how many times `xa_open` has been called in association with the current Resource Manager ID.
 - **Resource Manager Recovery GUID:** An identifier provided to identify the XA Superior Transaction Manager to the XA Subordinate Transaction Manager Facet. This identifier persists through failure and **recovery**.
 - **Resource Manager ID:** A 32-bit unsigned integer that identifies the XA Superior Proxy object in the XA Superior Proxy Table.
 - **Transaction Timeout:** A 32-bit unsigned integer that represents the number of milliseconds to wait before a **transaction** will time out in the Core Transaction Manager (see [\[MS-DTCO\]](#) section 3.2.1).
 - **Branch Isolation:** A flag specifying whether the associated XA Branches corresponding to the XA Transaction objects in the XA Transaction table are **loosely** or **tightly** coupled:
 - **Tight:** Transaction objects are associated to **XIDs** based on the **XA Global Transaction Identifier** field of the XID.
 - **Loose:** Transaction objects are associated to XIDs based on the entire XID.
 - **TM:** A **transaction manager** description, used for the Transaction object.

- **Recovery Complete {true,false}**: A Boolean flag indicating if the current recovery process is complete. This flag can have one of the two values: TRUE or FALSE. If there was no recovery started or if the recovery process has ended its value will be TRUE otherwise FALSE.
- **XA Transaction Table**: A table of XA Transaction objects associated with the resource manager ID keyed by XID.
- **Recovery Request Number**: The number of XIDs requested from XA Subordinate Transaction Manager Facet in the most recent XAUSER_CONTROL_MTAG_RECOVER message.
- **Recovery Max Return**: The maximum number of XIDs to return to **xa_recover** event triggered on the XA Superior Transaction Manager.
- **Recovery Return Number**: The number of XIDs in need of Recovery that have been received from the XA Subordinate Transaction Manager Facet.
- **Recovery Array**: A reference to an array of XIDs in need of Recovery that have been received from the XA Subordinate Transaction Manager Facet.
- **XA Superior Proxy Table**: A table of XA Superior Proxy objects that is keyed by Resource Manager ID.
- **XA Transaction object**: This object represents an XA Transactions Branch. An XA Transactions object MUST contain the following elements:
 - **XID**: The XID associated with the XA Transaction.
 - **Transaction Identifier**: The identifier field of the **OleTx** transaction object associated with the XA Transaction.
 - **Thread Identifier**: The execution Thread Identifier used to ensure thread affinity if required by setting Require Thread Affinity attribute to TRUE.
 - **Migrate**: A Boolean flag indicating if the XA Transaction has been migrated. This flag can take one of the two values: TRUE or FALSE.
 - **Require Thread Affinity**: A Boolean flag indicating if additional validation is to be performed to enforce thread affinity for the XA Transaction. This flag can take one of the two values: TRUE or FALSE.
 - **Parent XA Superior Proxy Object**: A reference to the corresponding XA Superior Proxy object.
 - **State**: The current state of the XA Transaction. This attribute can take of the following values:
 - {Idle, Starting, Opening, Preparing, Prepared, Committing, Aborting, Active, Suspended, Complete}.
 - **Connection**: A reference to XA Transaction CMP Connection object.
- **XA Superior Proxy CMP Connection** object: CMP connection object extended to include the following:
 - A reference to an XA Superior Proxy object.
 - **State**: A state enumeration that represents the current state of the connection.
- **XA Transaction CMP Connection** object: CMP Connection object extended to include the following:
 - Reference to an XA Transaction Object.

- **Action:**
 - {Prepare, Prepare Single Phase, Commit, Rollback, None, Migrate, Resume}.
- **State:** A state enumeration that represents the current state of the connection.
- **XA Switch** object: An instance of the xa_switch_t structure as defined in [\[XOPEN-DTP\]](#) chapter 4.3.

3.3.1.1 Versioning

The XA Superior Transaction Manager MUST maintain the data that pertains to the migrate functionality only on versions where the connection type [CONNTYPE_XAUSER_XACT_MIGRATE](#) or [CONNTYPE_XAUSER_XACT_MIGRATE2](#) is supported as specified in [2.2.4.1](#). The following data elements, as specified in section [3.3.1](#), are affected:

- XA Transaction Object:
 - Migrate
- XA Transaction CMP Connection Object:
 - Action:
 - Migrate

3.3.1.2 TM_NOTHREADAFFINITY Flag

This is an extension of the flags defined in [\[XOPEN-DTP\]](#) chapter 4.4.

Value	Meaning
TM_NOTHREADAFFINITY 0x00040000L	The XA Superior Transaction manager is not required to associate the transaction with a single thread during processing.

3.3.1.3 CONNTYPE_XAUSER_CONTROL Initiator States

The XA Superior Transaction Manager MUST act as an initiator for the [CONNTYPE_XAUSER_CONTROL](#) connection type. In this role, the XA Superior Transaction Manager MUST provide support for the following states:

- [Idle](#)
- [Awaiting Creation Response](#)
- [Active](#)
- [Awaiting Recovery Response](#)
- [Ended](#)

3.3.1.3.1 Idle

This is the initial state. The following event is processed in this state:

- [Xa open \(section 3.3.4.7\)](#)

3.3.1.3.2 Awaiting Creation Response

The following events are processed in this state:

- [Receiving an XAUSER CONTROL MTAG CREATED Message \(section 3.3.5.1.2\)](#)
- [Receiving an XAUSER CONTROL MTAG CREATE NO MEM Message \(section 3.3.5.1.1\)](#)
- [Connection Disconnected \(section 3.3.5.1.5\)](#)

3.3.1.3.3 Active

The following events are processed in this state:

- [Xa recover \(section 3.3.4.9\)](#)
- [Connection Disconnected \(section 3.3.5.1.5\)](#)

3.3.1.3.4 Awaiting Recovery Response

The following events are processed in this state:

- [Receiving an XAUSER CONTROL MTAG RECOVER NO MEM Message \(section 3.3.5.1.3\)](#)
- [Receiving an XAUSER CONTROL MTAG RECOVER REPLY Message \(section 3.3.5.1.4\)](#)
- [Connection Disconnected \(section 3.3.5.1.5\)](#)

3.3.1.3.5 Ended

This is the final state.

3.3.1.3.6 State Diagram

The following figure shows the relationships between the [CONNTYPE XAUSER CONTROL Initiator States \(section 3.3.1.3\)](#).

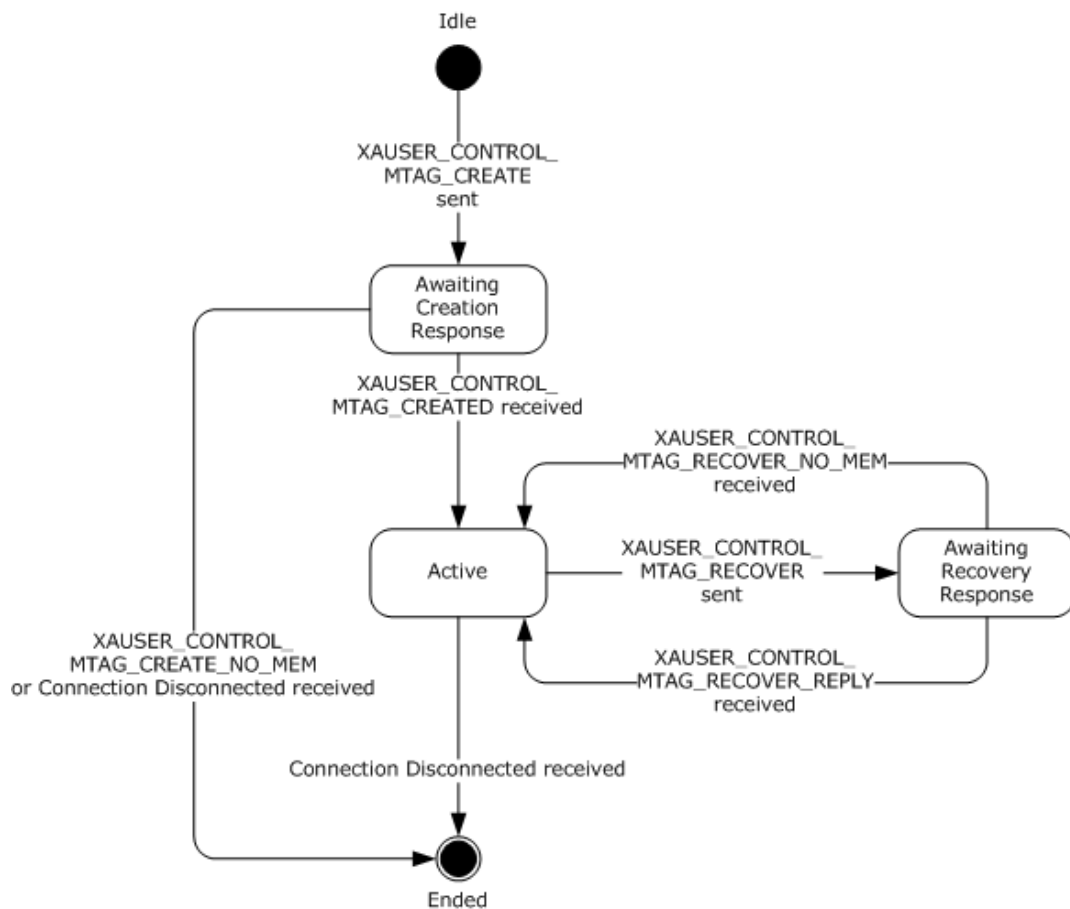

Figure 20: Relationships between the CONNTYPE_XAUSER_CONTROL initiator states

3.3.1.4 CONNTYPE_XAUSER_XACT_START Initiator States

The XA Superior Transaction Manager MUST act as an initiator for the [CONNTYPE_XAUSER_XACT_START](#) connection type. In this role, the XA Superior Transaction Manager MUST provide support for the following states:

- [Idle](#)
- [Awaiting Start Response](#)
- [Active](#)
- [Ended](#)

3.3.1.4.1 Idle

This is the initial state. The following event is processed in this state:

- [Xa_start \(section 3.3.4.11\)](#)

3.3.1.4.2 Awaiting Start Response

The following events are processed in this state:

- [Receiving an XAUSER XACT MTAG STARTED Message \(section 3.3.5.2.1\)](#)
- [Receiving an XAUSER XACT MTAG START NO MEM Message \(section 3.3.5.2.2\)](#)
- [Receiving an XAUSER XACT MTAG START LOG FULL Message \(section 3.3.5.2.3\)](#)
- [Receiving an XAUSER XACT MTAG START DUPLICATE Message \(section 3.3.5.2.4\)](#)
- [Connection Disconnected \(section 3.3.5.2.5\)](#)

3.3.1.4.3 Active

The following event is processed in this state:

- [Connection Disconnected \(section 3.3.5.2.5\)](#)

3.3.1.4.4 Ended

This is the final state.

3.3.1.4.5 State Diagram

The following figure shows the relationships between the [CONNTYPE XAUSER XACT START](#) initiator states.

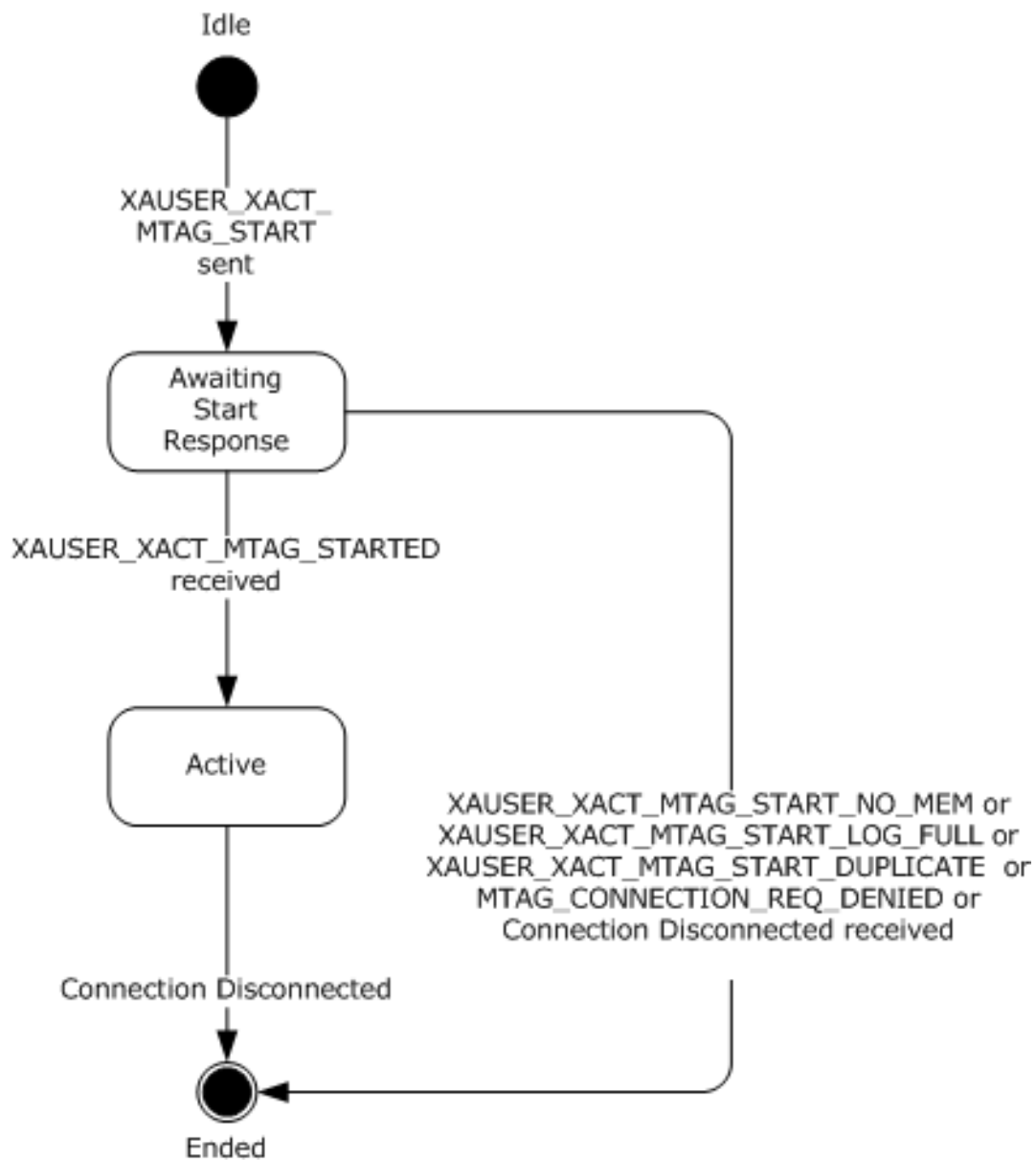

Figure 21: CONNTYPE_XAUSER_XACT_START initiator states

3.3.1.5 CONNTYPE_XAUSER_XACT_OPEN Initiator States

The XA Superior Transaction Manager MUST act as an initiator for the [CONNTYPE_XAUSER_XACT_OPEN](#) connection type. In this role, the XA Superior Transaction Manager MUST provide support for the following states:

- [Idle](#)
- [Awaiting Open Response](#)
- [Processing Opened Response](#)
- [Awaiting Prepare Response](#)

- [Awaiting Abort Response](#)
- [Awaiting Commit Response](#)
- [Ended](#)

3.3.1.5.1 Idle

This is the initial state. The following events are processed in this state:

- [Xa_commit \(section 3.3.4.3\)](#)
- [Xa_prepare \(section 3.3.4.8\)](#)
- [Xa_rollback \(section 3.3.4.10\)](#)
- [Xa_start \(section 3.3.4.11\)](#)

3.3.1.5.2 Awaiting Open Response

The following events are processed in this state:

- [Receiving an XAUSER XACT MTAG OPENED Message \(section 3.3.5.3.1\)](#)
- [Receiving an XAUSER XACT MTAG OPEN NOT FOUND Message \(section 3.3.5.3.2\)](#)
- [Connection Disconnected \(section 3.3.5.3.7\)](#)

3.3.1.5.3 Processing Opened Response

This is a transient state that is assumed during the synchronous processing of the [XAUSER XACT MTAG OPENED](#) response (section 2.2.4.5.5). No events are processed in this state.

3.3.1.5.4 Awaiting Prepare Response

The following events are processed in this state:

- [Receiving an XAUSER XACT MTAG REQUEST COMPLETED Message \(section 3.3.5.3.3\)](#)
- [Receiving an XAUSER XACT MTAG REQUEST FAILED BAD PROTOCOL Message \(section 3.3.5.3.6\)](#)
- [Receiving an XAUSER XACT MTAG PREPARE ABORT Message \(section 3.3.5.3.4\)](#)
- [Receiving an XAUSER XACT MTAG PREPARE SINGLEPHASE INDOUBT \(section 3.3.5.3.5\)](#)
- [Connection Disconnected \(section 3.3.5.3.7\)](#)

3.3.1.5.5 Awaiting Abort Response

The following events are processed in this state:

- [Receiving an XAUSER XACT MTAG REQUEST COMPLETED Message \(section 3.3.5.3.3\)](#)
- [Receiving an XAUSER XACT MTAG REQUEST FAILED BAD PROTOCOL Message \(section 3.3.5.3.6\)](#)
- [Connection Disconnected \(section 3.3.5.3.7\)](#)

3.3.1.5.6 Awaiting Commit Response

The following events are processed in this state:

- [Receiving an XAUSER_XACT_MTAG_REQUEST_COMPLETED Message \(section 3.3.5.3.3\)](#)
- [Receiving an XAUSER_XACT_MTAG_REQUEST_FAILED_BAD_PROTOCOL Message \(section 3.3.5.3.6\)](#)
- [Connection Disconnected \(section 3.3.5.3.7\)](#)

3.3.1.5.7 Ended

This is the final state.

3.3.1.5.8 State Diagram

The following figure shows the relationship between the [CONNTYPE_XAUSER_XACT_OPEN](#) initiator states.

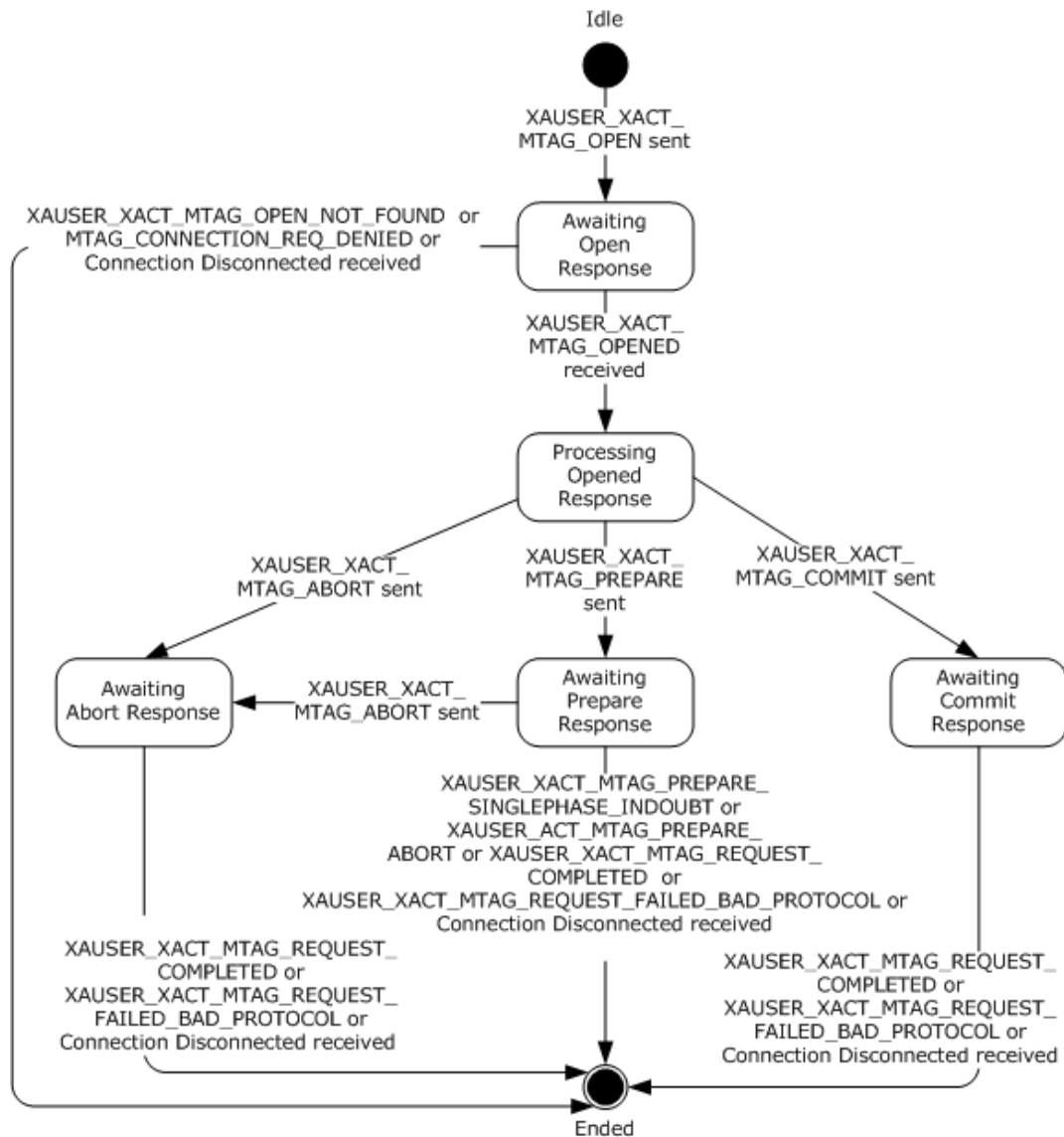

Figure 22: CONNTYPE_ XAUSER_XACT_OPEN initiator states

3.3.1.6 CONNTYPE_XAUSER_XACT_MIGRATE Initiator States

The XA Superior Transaction Manager MUST act as an initiator for the [CONNTYPE_XAUSER_XACT_MIGRATE](#) connection type. In this role, the XA Superior Transaction Manager MUST provide support for the following states:

- [Idle \(section 3.3.1.6.1\)](#)
- [Awaiting Suspension Response \(section 3.3.1.6.2\)](#)
- [Awaiting Resumption Response \(section 3.3.1.6.3\)](#)
- [Ended \(section 3.3.1.6.4\)](#)

3.3.1.6.1 Idle

This is the initial state. The following events are processed in this state:

- [Xa_end \(section 3.3.4.5\)](#)
- [Xa_start \(section 3.3.4.11\)](#)

3.3.1.6.2 Awaiting Suspension Response

The following events are processed in this state:

- [Receiving an XAUSER_XACT_MTAG_SUSPEND_WITH_MIGRATE_DONE Message](#)
- [Receiving an XAUSER_XACT_MTAG_TRANSACTION_NOT_SUSPENDED Message](#)
- [Connection Disconnected \(section 3.3.5.4.6\)](#)

3.3.1.6.3 Awaiting Resumption Response

The following events are processed in this state:

- [Receiving an XAUSER_XACT_MTAG_RESUME_DONE Message \(section 3.3.5.4.2\)](#)
- [Receiving an XAUSER_XACT_MTAG_TRANSACTION_NOT_SUSPENDED Message \(section 3.3.5.4.3\)](#)
- [Connection Disconnected \(section 3.3.5.4.6\)](#)

3.3.1.6.4 Ended

This is the final state.

3.3.1.6.5 State Diagram

The following figure shows the relationship between the [CONNTYPE_XAUSER_XACT_MIGRATE](#) initiator states.

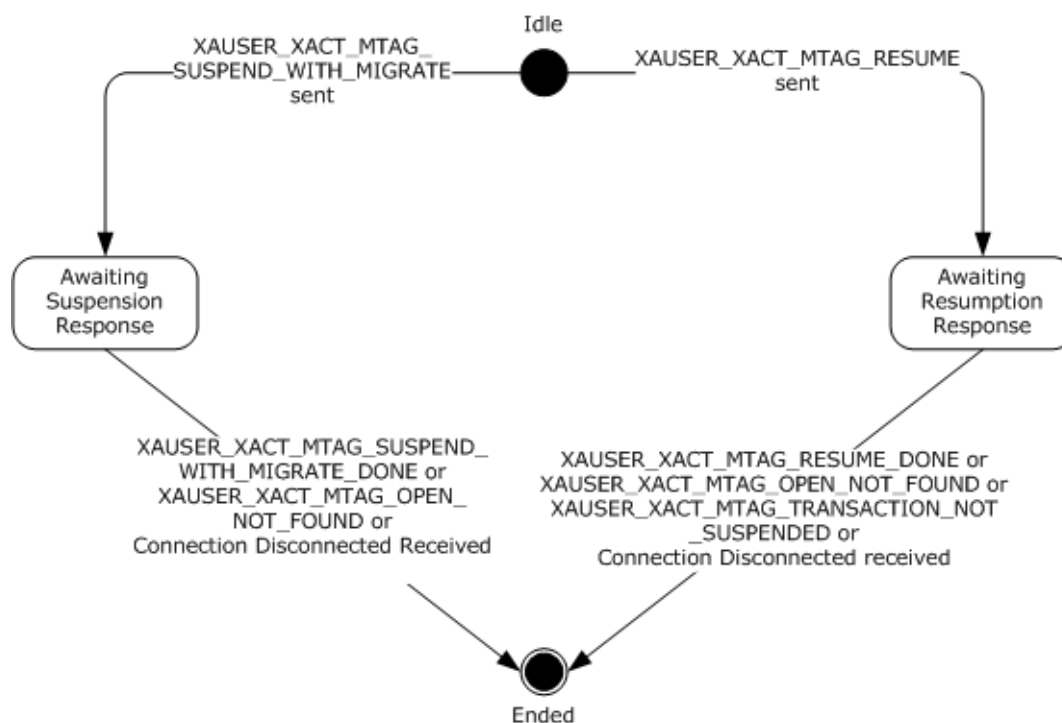

Figure 23: CONNTYPE_XAUSER_XACT_MIGRATE initiator states

3.3.1.7 CONNTYPE_XAUSER_XACT_BRANCH_START Initiator States

The XA Superior Transaction Manager MUST act as an initiator for the [CONNTYPE_XAUSER_XACT_BRANCH_START](#) connection type. In this role, the XA Superior Transaction Manager MUST provide support for the following states:

- [Idle](#)
- [Awaiting Start Response](#)
- [Active](#)
- [Ended](#)

3.3.1.7.1 Idle

This is the initial state. The following event is processed in this state:

- [Xa_start \(section 3.3.4.11\)](#)

3.3.1.7.2 Awaiting Start Response

The following events are processed in this state:

- [Receiving an XAUSER_XACT_MTAG_STARTED Message \(section 3.3.5.5.1\)](#)
- [Receiving an XAUSER_XACT_MTAG_START_NO_MEM Message \(section 3.3.5.5.2\)](#)
- [Receiving an XAUSER_XACT_MTAG_START_LOG_FULL Message \(section 3.3.5.5.3\)](#)
- [Receiving an XAUSER_XACT_MTAG_START_DUPLICATE Message \(section 3.3.5.5.4\)](#)

- [Connection Disconnected \(section 3.3.5.5.5\)](#)

3.3.1.7.3 Active

The following event is processed in this state:

- [Connection Disconnected \(section 3.3.5.5.5\)](#)

3.3.1.7.4 Ended

This is the final state.

3.3.1.7.5 State Diagram

The following figure shows the relationship between the [CONNTYPE XAUSER XACT BRANCH START](#) initiator states.

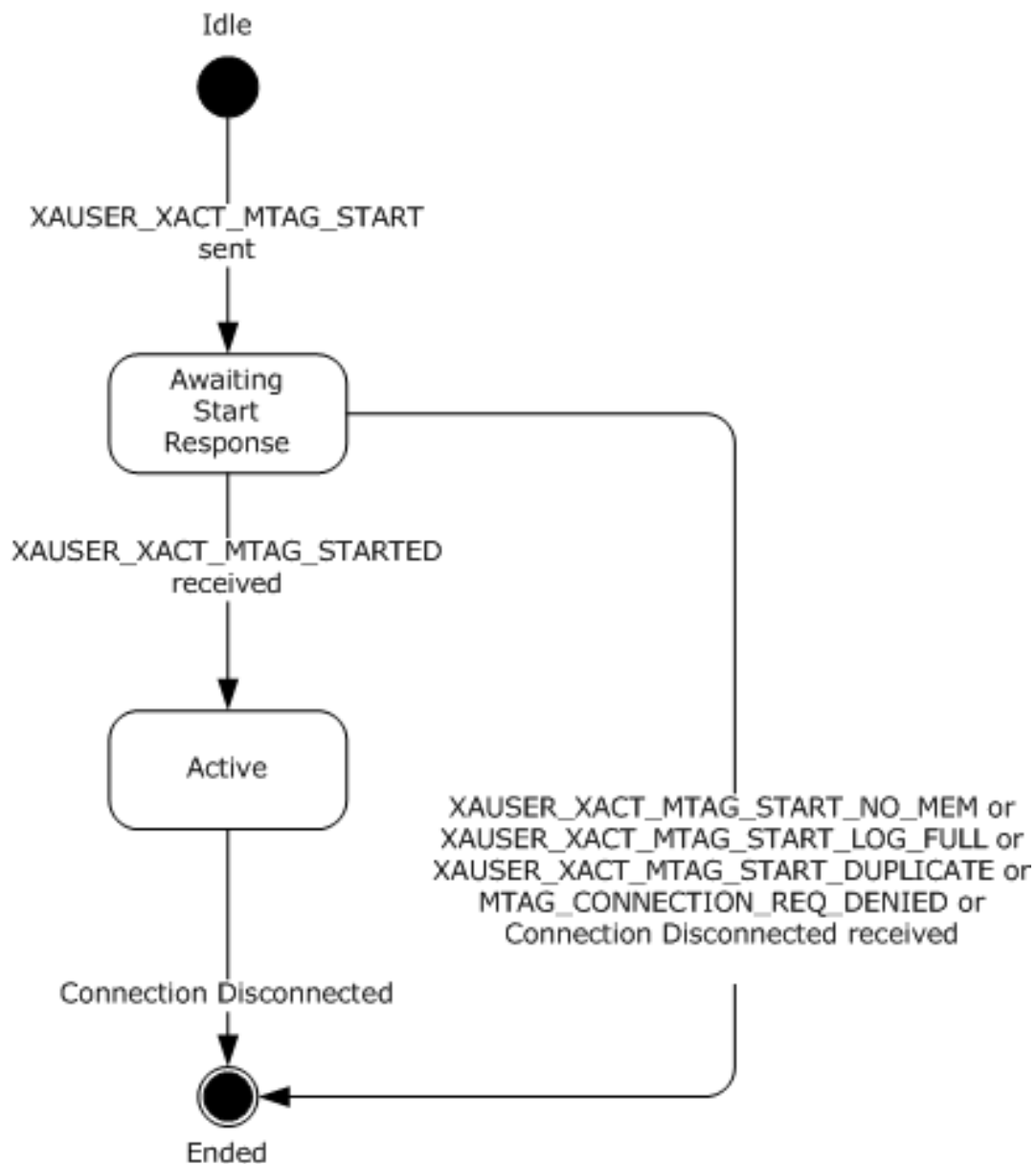

Figure 24: CONNTYPE_XAUSER_XACT_BRANCH_START initiator states

3.3.1.8 CONNTYPE_XAUSER_XACT_BRANCH_OPEN Initiator States

The XA Superior Transaction Manager MUST act as an initiator for the [CONNTYPE_XAUSER_XACT_BRANCH_OPEN](#) connection type. In this role, the XA Superior Transaction Manager MUST provide support for the following states:

- [Idle](#)
- [Awaiting Open Response](#)
- [Processing Opened Response](#)
- [Awaiting Prepare Response](#)

- [Awaiting Abort Response](#)
- [Awaiting Commit Response](#)
- [Ended](#)

3.3.1.8.1 Idle

This is the initial state. The following events are processed in this state:

- [Xa_commit \(section 3.3.4.3\)](#)
- [Xa_prepare \(section 3.3.4.8\)](#)
- [Xa_rollback \(section 3.3.4.10\)](#)
- [Xa_start \(section 3.3.4.11\)](#)

3.3.1.8.2 Awaiting Open Response

The following events are processed in this state:

- [Receiving an XAUSER XACT MTAG OPENED Message \(section 3.3.5.6.1\)](#)
- [Receiving an XAUSER XACT MTAG OPEN NOT FOUND Message \(section 3.3.5.6.2\)](#)
- [Connection Disconnected \(section 3.3.5.6.8\)](#)

3.3.1.8.3 Processing Opened Response

This is a transient state that is assumed during the synchronous processing of the [XAUSER XACT MTAG OPENED](#) response (section 2.2.4.5.5). No events are processed in this state.

3.3.1.8.4 Awaiting Prepare Response

The following events are processed in this state:

- [Receiving an XAUSER XACT MTAG REQUEST COMPLETED Message \(section 3.3.5.6.3\)](#)
- [Receiving an XAUSER XACT MTAG REQUEST FAILED BAD PROTOCOL Message \(section 3.3.5.6.6\)](#)
- [Receiving an XAUSER XACT MTAG PREPARE ABORT Message \(section 3.3.5.6.4\)](#)
- [Receiving an XAUSER XACT MTAG PREPARE SINGLEPHASE INDOUBT Message \(section 3.3.5.6.5\)](#)
- [Receiving an XAUSER XACT MTAG READONLY Message \(section 3.3.5.6.7\)](#)
- [Connection Disconnected \(section 3.3.5.6.8\)](#)

3.3.1.8.5 Awaiting Abort Response

The following events are processed in this state:

- [Receiving an XAUSER XACT MTAG REQUEST COMPLETED Message \(section 3.3.5.6.3\)](#)
- [Receiving an XAUSER XACT MTAG REQUEST FAILED BAD PROTOCOL Message \(section 3.3.5.6.6\)](#)
- [Connection Disconnected \(section 3.3.5.6.8\)](#)

3.3.1.8.6 Awaiting Commit Response

The following events are processed in this state:

- [Receiving an XAUSER_XACT_MTAG_REQUEST_COMPLETED Message \(section 3.3.5.6.3\)](#)
- [Receiving an XAUSER_XACT_MTAG_REQUEST_FAILED_BAD_PROTOCOL Message \(section 3.3.5.6.6\)](#)
- [Connection Disconnected \(section 3.3.5.6.8\)](#)

3.3.1.8.7 Ended

This is the final state.

3.3.1.8.8 State Diagram

The following figure shows the relationship between the [CONNTYPE_XAUSER_XACT_BRANCH_OPEN](#) initiator states.

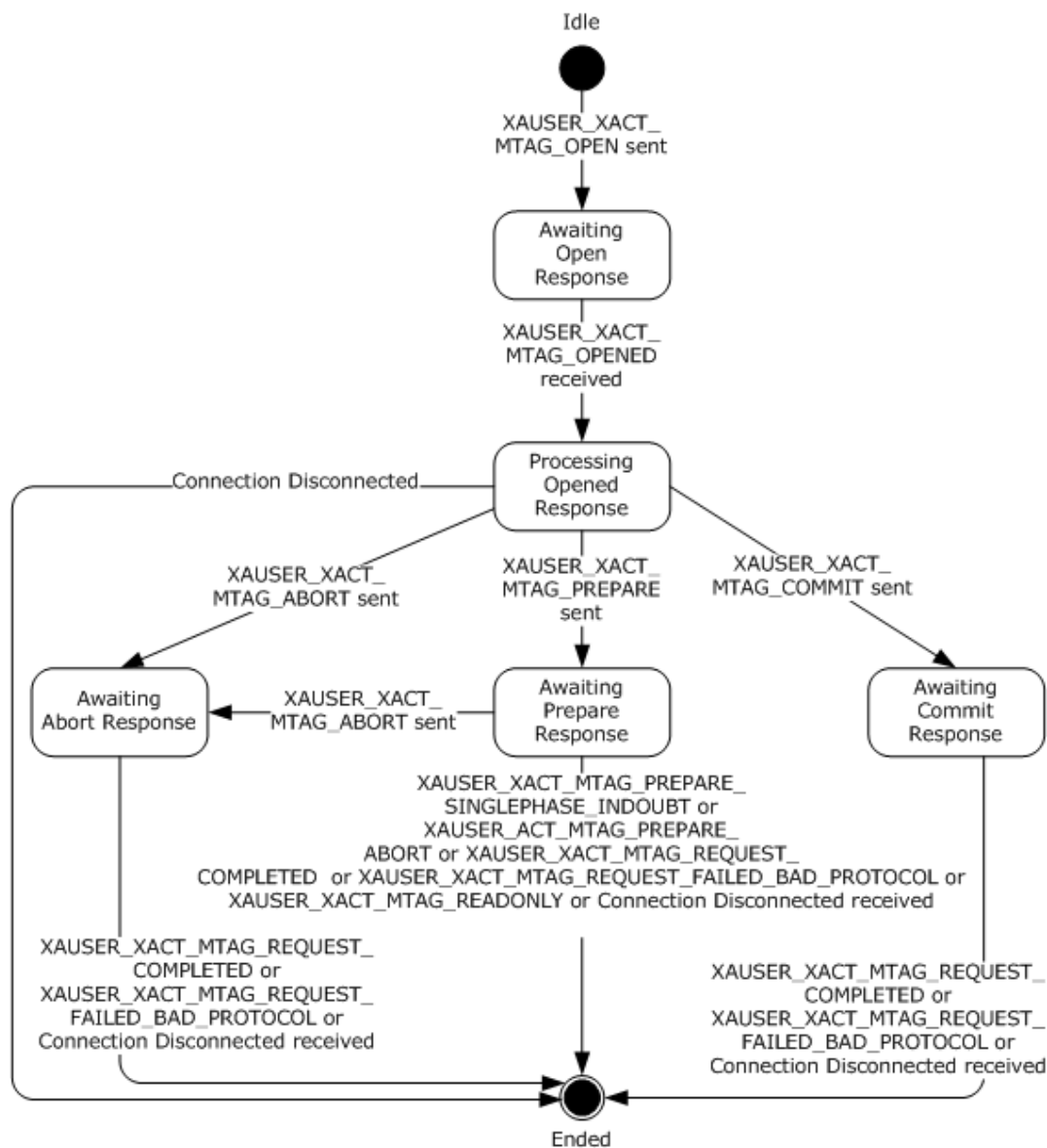

Figure 25: CONNTYPE_XAUSER_XACT_BRANCH_OPEN initiator states

3.3.1.9 CONNTYPE_XAUSER_XACT_MIGRATE2 Initiator States

The XA Superior Transaction Manager MUST act as an initiator for the [CONNTYPE_XAUSER_XACT_MIGRATE2](#) connection type. In this role, the XA Superior Transaction Manager MUST provide support for the following states:

- [Idle](#)
- [Awaiting Suspension Response](#)
- [Awaiting Resumption Response](#)
- [Ended](#)

3.3.1.9.1 Idle

This is the initial state. The following events are processed in this state:

- [Xa_end \(section 3.3.4.5\)](#)
- [Xa_start \(section 3.3.4.11\)](#)

3.3.1.9.2 Awaiting Suspension Response

The following events are processed in this state:

- [Receiving an XAUSER XACT MTAG OPEN NOT FOUND Message \(section 3.3.5.7.7\)](#)
- [Receiving an XAUSER XACT MTAG SUSPEND WITH MIGRATE DONE Message \(section 3.3.5.7.1\)](#)
- [Connection Disconnected \(section 3.3.5.7.4\)](#)

3.3.1.9.3 Awaiting Resumption Response

The following events are processed in this state:

- [Receiving an XAUSER XACT MTAG OPEN NOT FOUND Message \(section 3.3.5.7.7\)](#)
- [Receiving an XAUSER XACT MTAG RESUME DONE Message \(section 3.3.5.7.2\)](#)
- [Receiving an XAUSER XACT MTAG TRANSACTION NOT SUSPENDED Message \(section 3.3.5.7.3\)](#)
- [Connection Disconnected \(section 3.3.5.7.4\)](#)

3.3.1.9.4 Ended

This is the final state.

3.3.1.9.5 State Diagram

The following figure shows the relationship between the [CONNTYPE XAUSER XACT MIGRATE2](#) initiator states.

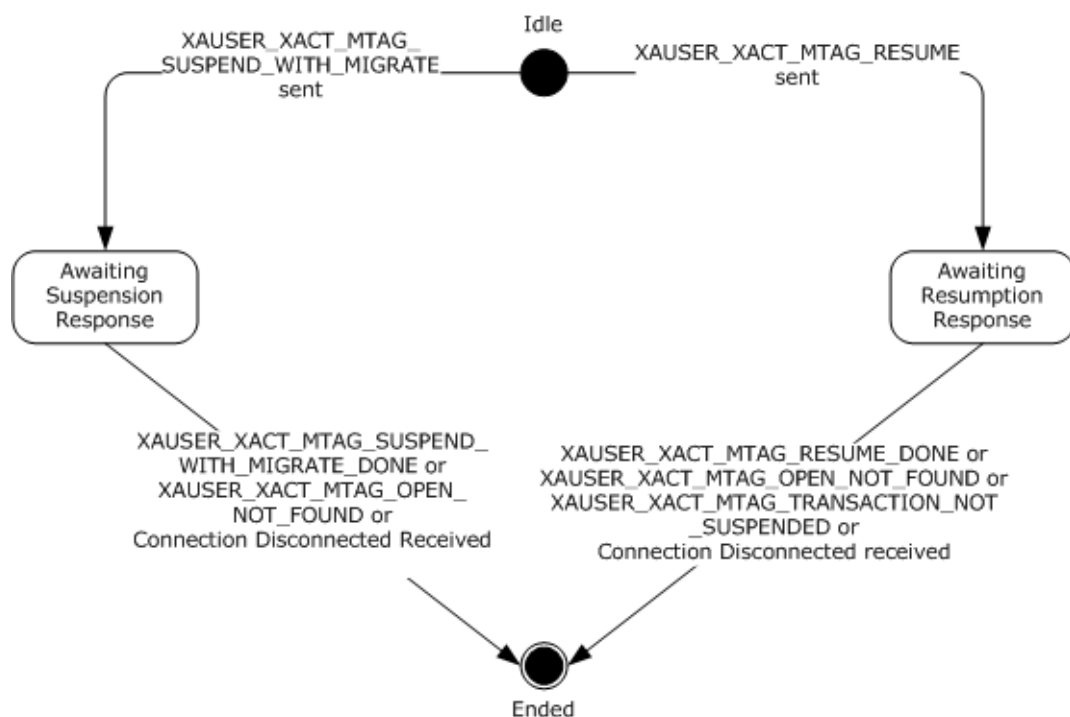

Figure 26: CONNTYPE_ XAUSER_XACT_MIGRATE2 initiator states

3.3.2 Timers

No timers apply here.

3.3.3 Initialization

The XA Superior Transaction Manager SHOULD obtain the Security Configuration of the Transaction Manager as specified in [\[MS-DTCO\]](#) section 3.3.4.11. <14>

- If the **grfXaTransactions** field of the TXUSER_GETSECURITYFLAGS_MTAG_FETCHED response message defined in [\[MS-DTCO\]](#) section 2.2.8.4.1.1 is set to 0x00000000, then when the following higher-layer events are triggered, the XA Superior Transaction Manager SHOULD return the appropriate error code:
 - Xa_close returns XAER_PROTO.
 - Xa_commit returns XAER_RMFAIL.
 - Xa_complete returns XAER_PROTO.
 - Xa_open returns XAER_RMERR.
 - Xa_end returns XAER_RMFAIL.
 - Xa_prepare returns XAER_RMFAIL.
 - Xa_recover returns XAER_RMFAIL.
 - Xa_rollback returns XAER_RMFAIL.
 - Xa_start returns XAER_RMFAIL.

- Xa_forget returns XAER_NOTA.

The XA Superior Transaction Manager MUST construct an xa_switch_t structure, as defined in [\[XOPEN-DTP\]](#) chapter 4.3, to provide access to the xa_* routines implemented, and assign it to the XA Switch field.

3.3.4 Higher-Layer Triggered Events

When the processing of these higher-layer events results in a message being sent to the [XA Subordinate Transaction Manager Facet](#), it is assumed that the processing waits for a response before continuing. This act of waiting for a response action is also specified in the processing descriptions where applicable. The processing that occurs after a response is received is further defined in [Processing Events and Sequencing Rules \(section 3.3.5\)](#).

3.3.4.1 XA Lookup

The XA Lookup event MUST be signaled with the following arguments:

- **XID** - The XA Transaction Branch Identifier to look for.
- Resource Manager Identifier - The resource manager ID to be used to look for the corresponding XA Superior Proxy object.

The XA Lookup event MUST return the following value:

- **Transaction Identifier** - Identifier field of the associated **OleTx transaction** object. Null indicates a failure.

If the XA Lookup event is signaled, the XA Superior Transaction Manager MUST perform the following actions:

- Attempt to find the XA Superior Proxy object whose key is set to the provided Resource Manager Identifier in the XA Superior Proxy Table.
- If the XA Superior Proxy object is found:
 - Attempt to find XA Transaction object whose key is set to the provided XID in the XA Transaction Table referenced by the located XA Superior Proxy object:
 - If the XA Transaction object is found:
 - Return the Transaction Identifier field of the located XA Transaction object.
 - Otherwise:
 - Return NULL.
- Otherwise:
 - Return NULL.

3.3.4.2 Xa_close

The Xa_close event MUST be signaled with the following arguments:

- xa_info - String using an implementation-specific format that contains the following fields:
 - **TM** - Transaction Manager description.
 - RM Recovery GUID - **Resource Manager Recovery GUID**.

- Transaction Timeout (optional).
- Branch Isolation (optional).
- RMID - Resource Manager ID to use for identifying the XA Superior Proxy object in the XA Superior Proxy Table.
- Flags - Flags defined in [\[XOPEN-DTP\]](#) Chapter 4.4.

The Xa_close event MUST return the following value:

- XA Result - Return code defined in [\[XOPEN-DTP\]](#) Chapter 4.5.

If the Xa_close event is signaled, the XA Superior Transaction Manager MUST perform the following actions:

- If the TMASYNC is set in the provided Flags:
 - Return XAER_ASYNC.
- Otherwise, if provided Flags are not equal to TMNOFLAGS:
 - Return XAER_INVALID.
- Otherwise:
 - Attempt to find an XA Superior Proxy object in the XA Superior Proxy Table corresponding to the provided RMID.
 - If the XA Superior Proxy object is found:
 - Decrement the Open Count field of the located XA Superior Proxy object.
 - If the **Open Count** field of the located XA Superior Proxy object is set to 0:
 - Disconnect the transaction manager Connection referenced by the XA Superior Proxy object.
 - Remove the XA Superior Proxy object from the XA Superior Proxy Table.
 - Return XA_OK.
 - Otherwise:
 - Return XAER_PROTO.

3.3.4.3 Xa_commit

The Xa_commit event MUST be signaled with the following arguments:

- **XID** - XA Transaction Branch Identifier.
- RMID - Resource Manager ID.
- Flags - Flags defined in [\[XOPEN-DTP\]](#) Chapter 4.4 and section [3.3.1.2](#) of this document.

The Xa_commit event MUST return the following value:

- XA Result- Return code defined in [\[XOPEN-DTP\]](#) Chapter 4.5.

If the Xa_commit event is signaled, the XA Superior Transaction Manager MUST perform the following actions:

- If Flags provided has TMASYNC set:
 - Return XAER_ASYNC.
- Otherwise:
 - Attempt to find an XA Superior Proxy object in the XA Superior Proxy Table corresponding to the provided RMID.
 - If the XA Superior Proxy object is not found:
 - Return XAER_RMFAIL.
 - Otherwise:
 - Attempt to find an XA Transaction object corresponding to the provided XID in the XA Transaction Table referenced by the located XA Superior Proxy object.
 - If the XA Transaction object is found:
 - Use this as the XA Transaction for the remaining steps.
 - Otherwise:
 - Attempt to create a new XA Transaction Object with the following values:
 - XID field set to the provided XID.
 - **Thread Identifier** field set to the identifier of the current thread of control.
 - **Migrate** field set to FALSE.
 - **State** field set to Suspended.
 - The **Require Thread Affinity** field SHOULD be set to whether Flags does not have TM_NOTHREADAFFINITY set. <15>
 - Parent XA Superior Proxy object reference set to located XA Superior Proxy object.
 - If failed:
 - Return XAER_RMERR.
 - Otherwise:
 - Add this XA Transaction object to the XA Transaction Table referenced by the located XA Superior Proxy object.
 - Use this as the XA Transaction for the remaining steps.
 - If **Branch Isolation** field of located XA Superior Proxy object is set to Tight:
 - Attempt to create an XA Transaction CMP Connection with the following settings:
 - **Connection Type** field set to [CONNTYPE_XAUSER_XACT_BRANCH_OPEN](#).
 - XA Transaction Object set to the located or created XA Transaction object.
 - **State** field set to Awaiting Open Response.
 - If Successful:
 - Set **State** field of located or created XA Transaction object to Opening.

- If provided Flags have TMONEPHASE set:
 - Set Action to Prepare Single Phase.
- Otherwise:
 - Set Action to Commit.
- Send an [XAUSER_XACT_MTAG_OPEN](#) message with the following values:
 - The **guidXaRM** field set to the Resource Manager Recovery GUID field of the located XA Superior Proxy object.
 - The **lenXAIdentifier** field of the [XA_UOW](#) structure (section 2.2.1.4) in the **XAUow** field set to the size of an [XA_XID](#) structure (section 2.2.1.3).
 - The **XAIdentifier** field of the XA_UOW structure in the **XAUow** field set to the provided XID.
 - Wait for a response and continue with the processing rules defined in [CONNTYPE_XAUSER_XACT_BRANCH_OPEN Initiator \(section 3.3.5.6\)](#).
- Otherwise:
 - Return XA_RMFAIL.
- Otherwise:
 - Attempt to create an XA Transaction CMP Connection with the following settings:

Connection Type field set to [CONNTYPE_XAUSER_XACT_OPEN](#).

XA Transaction Object set to the located or created XA Transaction object.

State field set to Awaiting Open Response.

- If Successful:
 - Set **State** field of located or created XA Transaction object to Opening.
 - If provided Flags have TMONEPHASE set:
 - Set Action to Prepare Single Phase.
 - Otherwise:
 - Set Action to Commit.
 - Send an XAUSER_XACT_MTAG_OPEN message with the following values:
 - The **guidXaRM** field set to the Resource Manager Recovery GUID field of the located XA Superior Proxy object.
 - The **lenXAIdentifier** field of the XA_UOW structure (section 2.2.1.4) in the **XAUow** field set to the size of an XA_XID structure (section 2.2.1.3).
 - The **XAIdentifier** field of the XA_UOW structure in the **XAUow** field set to the provided XID.
 - Wait for a response and continue with the processing rules specified in [CONNTYPE_XAUSER_XACT_OPEN Initiator \(section 3.3.5.3\)](#).
- Otherwise:

- Return XA_RMFAIL.

3.3.4.4 Xa_complete

The Xa_complete event MUST be signaled with the following arguments:

- XA Handle - Ignored on receipt.
- XA Return Handle - Ignored on receipt.
- RMID - Resource Manager ID.
- Flags - Flags defined in [\[XOPEN-DTP\]](#) Chapter 4.4.

The Xa_complete event MUST return the following value:

- XA Result - Return code defined in [\[XOPEN-DTP\]](#) Chapter 4.5.

If the Xa_complete event is signaled, the XA Superior Transaction Manager MUST perform the following actions:

- Return XAER_PROTO.

3.3.4.5 Xa_end

The Xa_end event MUST be signaled with the following arguments:

- **XID** - XA Transaction Branch Identifier.
- RMID - Resource Manager ID.
- Flags - Flags defined [\[XOPEN-DTP\]](#) Chapter 4.4.

The Xa_end event MUST return the following value:

- XA Result - Return code defined in [\[XOPEN-DTP\]](#) Chapter 4.5.

If the Xa_end event is signaled, the XA Superior Transaction Manager MUST perform the following actions:

- If provided Flags has TMASYNC set:
 - Return XAER_ASYNC.
- If provided Flags has TMMIGRATE set: [<16>](#)
 - SHOULD check if TMSUSPEND flag is not set:
 - Return XAER_PROTO.
- Attempt to find an XA Superior Proxy object in the XA Superior Proxy Table corresponding to the provided RMID.
- If not found:
 - Return XAER_RMFAIL.
- Otherwise:
 - Attempt to find an XA Transaction object corresponding to the provided XID in the XA Transaction Table referenced by XA Superior Proxy object.

- If found:
 - If Flags has TMSUSPEND set:
 - If the **State** field of the located XA Transaction object is set to Active:
 - Set the **State** field of the located XA Transaction to Suspended.
 - If Flags has TMMIGRATE set:
 - Attempt to create XA Transaction CMP Connection with the following settings:
 - Connection type SHOULD<17> be set to [CONNTYPE_XAUSER_XACT_MIGRATE2 \(section 2.2.4.8\)](#).
 - XA Transaction Object set to the located XA Transaction object.
 - State set to Awaiting Suspension Response.
 - XA Transaction object State set to Suspended.
 - Action set to Migrate.
 - If Successful:
 - Send an [XAUSER_XACT_MTAG_SUSPEND_WITH_MIGRATE](#) message with the following values:
 - guidXaRm is set to the Resource Manager Recovery GUID field of the located XA Superior Proxy object.
 - lenXAIdentifier is set to the size of an [XA_XID](#) structure (section 2.2.1.3).
 - XAIdentifier is set to the provided XID.
 - dwProcessId is set to the Current Process Identifier.
 - dwThreadId set to the Current Thread Identifier.
 - Wait for a response and continue with the processing rules defined in [CONNTYPE_XAUSER_XACT_MIGRATE2 Initiator \(section 3.3.5.7\)](#).
 - Otherwise:
 - Return XA_RMFAIL.
 - Otherwise:
 - Return XA_OK.
 - Otherwise:
 - Return XAER_RMERR.
- Otherwise:
 - Verify that the Thread Identifier field of the XA Transaction object is set to the Current Thread Identifier.
 - If Fail:
 - Return XAER_PROTO.

- Otherwise:
 - Signal the Disconnect Connection event using the connection referenced by the XA Transaction object as the argument.
 - Remove the XA Transaction object from the XA Transaction Table of the located XA Superior Proxy.
 - Return XA_OK.
- Otherwise:
 - Return XAER_NOTA.

3.3.4.6 Xa_forget

The Xa_forget event MUST be signaled with the following arguments:

- **XID** - XA Transaction Branch Identifier.
- RMID - Resource Manager ID.
- Flags - Flags defined in [\[XOPEN-DTP\]](#) Chapter 4.4.

The Xa_forget event MUST return the following value:

- XA Result - Return code defined in [\[XOPEN-DTP\]](#) Chapter 4.5.

If the Xa_forget event is signaled, the XA Superior Transaction Manager MUST perform the following actions:

- The XA Superior Transaction Manager will return XAER_NOTA.

3.3.4.7 Xa_open

The Xa_open event MUST be signaled with the following arguments:

- xa_info - String using an implementation-specific format that contains the following fields:
 - **TM** - Transaction Manager description.
 - RM Recovery GUID - **Resource Manager Recovery GUID**.
 - Transaction Timeout (optional).[<18>](#)
 - Branch Isolation (optional).[<19>](#)
- RMID - Resource Manager ID.
- Flags - Flags defined in [\[XOPEN-DTP\]](#) Chapter 4.4.

The Xa_open event MUST return the following value:

- XA Result - Return code defined in [\[XOPEN-DTP\]](#) Chapter 4.5 or a Windows Error Code as defined in [\[MS-ERREF\]](#) section 2.1.1.

If the Xa_open event is signaled, the XA Superior Transaction Manager MUST perform the following actions:

- If the provided Flags field has TMASYNC set:

- Return XAER_ASYNC.
- If the provided **Flags** field is not set to TMNOFLAGS or the xa_info argument is not set:
 - Return E_INVALIDARG.
- If the Branch Isolation argument is set and the value is not equal to Tight:
 - Return XAER_INVALID.
- Attempt to find an XA Superior Proxy object in the XA Superior Proxy Table keyed by the provided RMID.
- If an object is found:
 - If the provided **Branch Isolation** is not set and the value of the **Branch Isolation** field of the XA Superior Proxy object is not set to Loose:
 - Return XAER_INVALID.
 - Otherwise, if the value of the provided Branch Isolation is not equal to the value of the **Branch Isolation** field of the XA Superior Proxy object:
 - Return XAER_INVALID.
 - Otherwise:
 - Increment the **Open Count** field of the XA Superior Proxy object.
 - The implementation SHOULD check whether Transaction Timeout is provided:
 - If Transaction Timeout is provided, the implementation SHOULD set the **Transaction Timeout** field of the XA Superior Proxy object to the provided **Transaction Timeout** converted to a 32-bit unsigned integer.
 - Return XA_OK.
- Otherwise:
 - Attempt to create a new XA Superior Proxy Object with the following values:
 - The TM field is set to the TM field of the provided xa_info.
 - The Resource Manager Recovery GUID field is set to the provided RM Recovery GUID field.
 - The **Resource Manager ID** field is set to the provided RMID.
 - Transaction Timeout is set if provided.
 - The **Branch Isolation** field is set to the Branch Isolation field if provided; otherwise set the Branch Isolation field to Loose.
 - The **Recovery Complete** field is set to FALSE.
 - If failed:
 - Return XAER_RMERR.
 - Otherwise:
 - Attempt to create a new XA Superior Proxy CMP Connection object with the following values:

- The Connection type field is set to [CONNTYPE_XAUSER_CONTROL](#).
- The XA Superior Proxy Object is set to created XA Superior Proxy object.
- The State is set to Awaiting Creation Response.
- If failed:
 - Return XAER_RMERR.
- Otherwise:
 - Set the Transaction Manager Connection field of XA Superior Proxy object to the newly created XA Superior Proxy CMP Connection object.
 - Send an [XAUSER_CONTROL_MTAG_CREATE](#) message with the following argument:
 - The **guidXaRm** field of the message is set to the provided RM Recovery GUID.
 - Wait for a response and continue with the processing rules defined in [CONNTYPE_XAUSER_CONTROL Initiator \(section 3.3.5.1\)](#).

3.3.4.8 Xa_prepare

The Xa_prepare event MUST be signaled with the following arguments:

- **XID** - XA Transaction Branch Identifier.
- RMID - Resource Manager ID.
- Flags - Flags defined in [\[XOPEN-DTP\] Chapter 4.4](#) and section [3.3.1.2](#) of this document.

The Xa_prepare event MUST return the following value:

- XA Result - Return code defined in [\[XOPEN-DTP\] Chapter 4.5](#).

If the Xa_prepare event is signaled, the XA Superior Transaction Manager MUST perform the following actions:

- If the provided Flags field has TMASYNC set:
 - Return XAER_ASYNC.
- Otherwise:
 - Attempt to find an XA Superior Proxy object in the XA Superior Proxy Table keyed by the provided RMID.
 - If an object is not found:
 - Return XAER_RMFAIL.
 - Otherwise:
 - Attempt to find an XA Transaction object in the XA Transaction Table referenced by the XA Superior Proxy object keyed by the provided XID.
 - If an object is found:
 - Use this as the XA Transaction.
 - Otherwise:

- Attempt to create a new XA Transaction Object with the following values:
 - The **XID** field is set to the provided XID.
 - The **Thread Identifier** field is set to the Current Thread ID.
 - The **Migrate** field is set to FALSE.
 - The **State** field is set to Suspended.
 - If the provided **Flags** field has TM_NOTTHREADAFFINITY set:
 - Set **Require Thread Affinity** field to TRUE.
 - Otherwise:
 - SHOULD set **Require Thread Affinity** field to false. <20>
 - The Parent XA Superior Proxy object is set to the found XA Superior Proxy object.
- If failed:
 - Return XAER_RMERR.
- Otherwise:
 - Use this as the XA Transaction object.
- If the found XA Superior Proxy object has the **Branch Isolation** field set to Tight:
 - Attempt to create a new XA Transaction CMP Connection with the following values:
 - The **Connection Type** field is set to [CONNTYPE_XAUSER_XACT_BRANCH_OPEN](#).
 - The XA Transaction Object is set to the created XA Transaction object.
 - The **State** field is set to Awaiting Open Response.
 - The **State** field of the XA Transaction object is set to Opening.
 - The **Action** field is set to Prepare.
 - If failed:
 - Return XAER_RMERR.
 - Send an [XAUSER_XACT_MTAG_OPEN](#) message with the following values:
 - The **guidXaRm** field set to the **Resource Manager Recovery GUID** field of the found XA Superior Proxy object.
 - The **lenXAIdentifier** field of the [XA_UOW](#) structure (section 2.2.1.4) in the **XAUow** field set to the size of an [XA_XID](#) structure (section 2.2.1.3).
 - The **XAIdentifier** field of the XA_UOW structure in the **XAUow** field set to the provided XID field.
 - Wait for a response and continue with the processing rules defined in [CONNTYPE_XAUSER_XACT_BRANCH_OPEN Initiator \(section 3.3.5.6\)](#).
- Otherwise:

- Attempt to create a new XA Transaction CMP Connection object with the following values:
 - The Connection Type is set to [CONNTYPE_XAUSER_XACT_OPEN](#).
 - The XA Transaction Object is set to the previously found or created XA Transaction object.
 - The **State** field is set to Awaiting Open Response.
 - The **Action** field is set to Prepare.
- If failed:
 - Return XAER_RMERR.
- Set the **State** field of the XA Transaction object to Opening.
- Send an XAUSER_XACT_MTAG_OPEN message with the following values:
 - The **guidXaRm** field set to the Resource Manager Recovery GUID field of the found XA Superior Proxy object.
 - The **lenXAIdentifier** field of the XA_UOW structure in the **XAUOW** field set to the size an XA_XID structure.
 - The **XAIdentifier** field of the XA_UOW structure in the **XAUOW** field set to the provided XID field.
 - Wait for a response and continue with the processing rules defined in [CONNTYPE_XAUSER_XACT_OPEN Initiator \(section 3.3.5.3\)](#).

3.3.4.9 Xa_recover

The **Xa_recover** event MUST be signaled with the following arguments:

- **XID** Array - Array into which recovered XIDs are to be placed.
- Count - Maximum number of XIDs to be returned.
- RMID - Resource Manager ID.
- Flags - Flags defined in [\[XOPEN-DTP\]](#) Chapter 4.4.

The **Xa_recover** event MUST return the following value:

- XA Result - If successful, the number of XIDs being returned. If unsuccessful, a return code defined in [\[XOPEN-DTP\]](#) Chapter 4.5.

If the **Xa_recover** event is signaled, the XA Superior Transaction Manager MUST perform the following actions:

- If the provided **Count** field is less than 1:
 - Return XAER_INVALID.
- Attempt to find an XA Superior Proxy object in the XA Superior Proxy Table keyed by the provided RMID.
- If an object found:

- If the State of the Transaction Manager Connection referenced by the XA Superior Proxy Object is not set to Active:
 - Return XAER_RMFAIL.
- Otherwise:
 - Create a RequestFlags variable with no flags set initially.
 - SHOULD <21> test if the **Recovery Complete** field of the found XA Superior Proxy object is set to TRUE and the provided **Flags** field does not have TMSTARTRSCAN set:
 - Return 0.
 - If TMSTARTRSCAN is set in the provided Flags field:
 - SHOULD <22> set the **Recovery Complete** field of the found XA Superior Proxy object to FALSE.
 - Set the **Recovery Return Number** field of the found XA Superior Proxy object to 0.
 - Set the XARECOVER_START_SCAN flag in the RequestFlags variable.
 - Otherwise:
 - If TMENDRSCAN is set in the provided **Flags** field:
 - SHOULD <23> set the **Recovery Complete** field of the found XA Superior Proxy object to TRUE.
 - MAY <24> set the XARECOVER_END_SCAN flag in the RequestFlags variable.
 - Otherwise:
 - Set the XARECOVER_CONTINUE_SCAN flag in the RequestFlags variable.
 - If the provided Flags field is not set to TMNOFLAGS:
 - SHOULD <25> return XAER_INVALID.
 - Set the XARECOVER_CONTINUE_SCAN flag in the RequestFlags variable.
 - SHOULD set the **Recovery Request Number** field of the found XA Superior Proxy object to a minimum value between an implementation-specific value and provided Count. <26>
 - Set the Recovery Max Return field of the found XA Superior Proxy object to the provided Count field.
 - Set the Transaction Manager Connection's State to Awaiting Recovery Response.
 - Set the Recovery Array field of the found XA Superior Proxy object to reference the provided XID Array.
 - Using the Transaction Manager Connection, send an [XAUSER CONTROL MTAG RECOVER](#) message with the following values:
 - The **RequestFlags** field is set to the created the RequestFlags variable.
 - The **totalUOWsRequested** field SHOULD be set to a minimum value between an implementation-specific value and the provided Count field. <27>

- Wait for a response and continue with the processing rules defined in [CONNTYPE_XAUSER_CONTROL Initiator \(section 3.3.5.1\)](#).
- Otherwise:
 - Return XAER_RMFAIL.

3.3.4.10 Xa_rollback

The Xa_rollback event MUST be signaled with the following arguments:

- **XID** - XA Transaction Branch Identifier.
- RMID - Resource Manager ID.
- Flags - Flags defined in Chapter 4.4 of [\[XOPEN-DTP\]](#) and section [3.3.1.2](#) of this document.

The Xa_rollback event MUST return the following value:

- XA Result - Return code defined in [\[XOPEN-DTP\] Chapter 4.5](#).

If the Xa_rollback event is signaled, the XA Superior Transaction Manager MUST perform the following actions:

- If the provided Flags field has TMASYNC set:
 - Return XAER_ASYNC.
- Otherwise:
 - Attempt to find an XA Superior Proxy object in the XA Superior Proxy Table keyed by the provided RMID.
 - If an object is not found:
 - Return XAER_RMFAIL.
 - Otherwise:
 - Attempt to find an XA Transaction object in the XA Transaction Table referenced by the XA Superior Proxy object keyed by the provided XID.
 - If an object is found:
 - Use this as the XA Transaction.
 - Otherwise:
 - Attempt to create a new XA Transaction Object with the following values:
 - The XID field is set to the provided XID.
 - The Thread Identifier field is set to the Current Thread ID.
 - The Migrate field is set to FALSE.
 - The State field is set to Suspended.
 - If the provided Flags field has TM_NOTTHREADAFFINITY set: [<28>](#)
 - Set the Require Thread Affinity field to TRUE.

- Otherwise:
 - Set the Require Thread Affinity field to FALSE.
 - The Parent XA Superior Proxy object is set to XA Superior Proxy object.
- If failed:
 - Return XAER_RMERR.
- Otherwise:
 - Use this as the XA Transaction object.
- If the found XA Superior Proxy object has Branch Isolation field set to Tight:
 - Create a new XA Transaction CMP Connection object with the following values:
 - The Connection type field is set to CONNTYPE_XAUSER_XACT_BRANCH_OPEN.
 - The XA Transaction Object is set to created XA Transaction object.
 - The State field set to Awaiting Open Response.
 - The State field of the XA Transaction object is set to Opening.
 - The Action field is set to Rollback.
 - Send an [XAUSER_XACT_MTAG_OPEN](#) message with the following values:
 - The **guidXaRm** is set to the **Resource Manager Recovery GUID** field of the found XA Superior Proxy object.
 - The **lenXAIdentifier** field of the [XA_UOW](#) structure (section 2.2.1.4) in the **XAUow** field is set to size of an [XA_XID](#) structure (section 2.2.1.3).
 - The **XAIdentifier** field of the XA_UOW structure in the **XAUow** field is set to the provided **XID** field.
 - Wait for a response and continue with the processing rules defined in [CONNTYPE_XAUSER_XACT_BRANCH_OPEN Initiator \(section 3.3.5.6\)](#).
- Otherwise:
 - Attempt to create a new XA Transaction CMP Connection object with the following values:
 - The Connection type field is set to CONNTYPE_XAUSER_XACT_OPEN.
 - The XA Transaction object is set to the created XA Transaction object.
 - The State field is set to Awaiting Open Response.
 - The Action field is set to Rollback.
 - If failed:
 - Return XAER_RMERR.
 - The State field of the XA Transaction object is set to Opening.
 - Send an XAUSER_XACT_MTAG_OPEN message with the following values:

- The **guidXaRm** is set to the Resource Manager Recovery GUID field of the found XA Superior Proxy object.
- The **lenXAIdentifier** field of the XA_UOW structure in the **XAUow** field is set to the size of an XA_XID structure.
- The **XAIdentifier** field of the XA_UOW structure in the **XAUow** field is set to the provided **XID** field.
- Wait for a response and continue with the processing rules defined in [CONNTYPE_XAUSER_XACT_OPEN Initiator \(section 3.3.5.3\)](#).

3.3.4.11 Xa_start

The Xa_start event MUST be signaled with the following arguments:

- **XID** - XA Transaction Branch ID.
- RMID - Resource Manager ID.
- Flags - Flags defined in [\[XOPEN-DTP\] Chapter 4.4](#) and section [3.3.1.2](#) of this document.

The Xa_start event MUST return the following value:

- XA Result - Return code defined in [\[XOPEN-DTP\] Chapter 4.5](#).

If the Xa_start event is signaled, the XA Superior Transaction Manager MUST perform the following actions:

- If the provided Flags argument has TMASYNC set:
 - Return XAER_ASYNC.
- Attempt to find an XA Superior Proxy object in the XA Superior Proxy Table keyed by the provided RMID.
- If an object is not found:
 - Return XAER_RMFAIL.
- Otherwise:
 - Attempt to find an XA Transaction object in the XA Transaction Table referenced by the found XA Superior Proxy object keyed by the provided XID.
 - If an object is found:
 - If the provided Flags argument has TMRESUME set:
 - If the **State** field of the found XA Transaction object is set to Suspended:
 - If the **Migrate** field of the found XA Transaction object is set to TRUE:
 - Attempt to create a new XA Transaction CMP Connection object with the following values:
 - The **Connection Type** field SHOULD be set to [CONNTYPE_XAUSER_XACT_MIGRATE2.<29>](#)
 - The XA Transaction Object is set to the located XA Transaction object.
 - The **State** field is set to Awaiting Resumption Response.

- The **State** field of the XA Transaction object is set to Suspended.
 - The **Action** field is set to Resume.
 - If failed:
 - Return XAER_RMERR.
 - Send an [XAUSER XACT MTAG RESUME](#) message with the following values:
 - The **guidXaRm** field is set to the **Resource Manager Recovery GUID** field of the found XA Superior Proxy object.
 - The **lenXAIdentifier** field is set to the size of an [XA_XID](#) structure (section 2.2.1.3).
 - The **XAIdentifier** field is set to the provided XID.
 - The **dwProcessId** field is set to the Current Process ID.
 - The **dwThreadId** field is set to the Current Thread ID.
 - Wait for a response and continue with the processing rules defined in [CONNTYPE XAUSER XACT MIGRATE2 Initiator \(section 3.3.5.7\)](#).
 - Otherwise:
 - Set the State of the found XA Transaction object to Active.
- Otherwise:
 - Return XAER_RMERR.
- Otherwise:
 - If the provided Flags argument does not have TMJOIN set:
 - Return XAER_DUPID.
 - Otherwise:
 - If the **Require Thread Affinity** field of the found XA Transaction object is set to TRUE, check if the Current Thread ID is set to the Thread Identifier of the found XA Transaction object.
 - If failed:
 - Return XAER_RMERR.
 - Otherwise:
 - If the **State** field of the found XA Transaction object is set to Suspended:
 - SHOULD set the **State** field of the XA Transaction object to Active. [<30>](#)
 - Return XA_OK.
 - Otherwise:
 - Return XAER_RMERR.
- Otherwise:

- If the provided Flags argument has TMRESUME set:
 - MAY return XAER_NOTA.
 - Attempt to create a new XA Transaction object with the following values:
 - The XID field is set to the provided XID.
 - The **Thread Identifier** field is set to the Current Thread ID.
 - The **Migrate** field is set to FALSE.
 - The **State** field is set to Suspended.
 - The **Require Thread Affinity** field SHOULD be set to whether the Flags argument does not have TM_NOTHREADAFFINITY set. [<31>](#)
 - The Parent XA Superior Proxy object is set to the found XA Superior Proxy object.
 - If failed:
 - Return XAER_RMERR.
 - Otherwise:
 - Attempt to create XA Transaction CMP Connection object with the following values:
 - The Connection type field SHOULD be set to CONNTYPE_XAUSER_XACT_MIGRATE2. [<32>](#)
 - The XA Transaction object is set to the created XA Transaction object.
 - The **State** field is set to Awaiting Resumption Response.
 - The **State** field of the created XA Transaction object is set to Suspended.
 - The **Action** field is set to Resume.
 - If failed:
 - Return XAER_RMERR.
 - Send an XAUSER_XACT_MTAG_RESUME message with the following values:
 - The **guidXaRm** field is set to the Resource Manager Recovery GUID field of the found XA Superior Proxy object.
 - The **lenXAIdentifier** field is set to the size of an XA_XID structure.
 - The **XAIdentifier** field is set to the provided XID.
 - The **dwProcessId** field is set to the Current Process ID.
 - The **dwThreadId** field is set to the Current Thread ID.
 - Wait for a response and continue with the processing rules defined in CONNTYPE_XAUSER_XACT_MIGRATE2 Initiator (section 3.3.5.7).
- Otherwise:
 - Attempt to create a new XA Transaction object with the following values:
 - The **XID** field is set to the provided XID.

- The **Thread Identifier** field is set to the Current Thread ID.
- The **Migrate** field is set to FALSE.
- The **State** field is set to Idle.
- The Require Thread Affinity field SHOULD be set to whether the Flags argument does not have TM_NOTHREADAFFINITY set. [<33>](#)
- The Parent XA Superior Proxy object is set to the found XA Superior Proxy object.
- If failed:
 - Return XAER_RMERR.
- Otherwise:
 - If the found XA Superior Proxy object has the Branch Isolation field set to Tight:
 - If the provided Flags argument has TMJOIN set:
 - Create a new XA Transaction CMP Connection object with the following values:
 - The Connection type is set to [CONNTYPE_XAUSER_XACT_BRANCH_OPEN](#).
 - The XA Transaction object is set to the created XA Transaction object.
 - The **State** field is set to Awaiting Open Response.
 - The **State** field of the XA Transaction object is set to Opening.
 - The **Action** field is set to None.
 - Send an [XAUSER_XACT_MTAG_OPEN](#) message with the following values:
 - The **guidXaRm** is set to the Resource Manager Recovery GUID field of the found XA Superior Proxy object.
 - The **lenXAIdentifier** field of the [XA_UOW](#) structure in the **XAUow** field is set to size of an XA_XID structure.
 - The **XAIdentifier** field of the XA_UOW structure in the **XAUow** field is set to the provided XID field.
 - Wait for a response and continue with the processing rules defined in [CONNTYPE_XAUSER_XACT_BRANCH_OPEN Initiator \(section 3.3.5.6\)](#).
 - Otherwise:
 - Attempt to create a new XA Transaction CMP Connection object with the following values:
 - The Connection Type is set to [CONNTYPE_XAUSER_XACT_BRANCH_START](#).
 - The XA Transaction object is set to the created XA Transaction object.
 - The **State** field of the XA Transaction object is set to Starting.
 - The **State** field is set to Awaiting Start Response.

- The **Action** field is set to None.
- If failed:
 - Return XAER_RMERR.
- Send an [XAUSER_XACT_MTAG_START](#) message with the following values:
 - The **guidXaRm** field is set to the Resource Manager Recovery GUID field of the found XA Superior Proxy object.
 - The **lenXAIdentifier** field of the XA_UOW structure in the **XAUow** field is set to size of an XA_XID structure.
 - The **XAIdentifier** field of the XA_UOW structure in the **XAUow** field is set to the provided XID field.
 - The **isoLevel** field is set to ISOLATIONLEVEL_ISOLATED.
 - The **Timeout** field is set to the Transaction Timeout field of the found XA Superior Proxy object.
 - If the **TM** field of the found XA Superior Proxy is not set to "":
 - Set the **szDesc** field of the message to "Transaction", appended if possible.
 - Otherwise:
 - Set the **szDesc** field of the message to "XA Transaction".
 - The **isoFlags** field is set to 0.
 - Wait for a response and continue with the processing rules defined in [CONNTYPE_XAUSER_XACT_BRANCH_START Initiator \(section 3.3.5.5\)](#).
- Otherwise:
 - If the provided Flags argument has TMJOIN set:
 - Attempt to create a new XA Transaction CMP Connection object with the following values:
 - The Connection type is set to CONNTYPE_XAUSER_XACT_OPEN.
 - The XA Transaction object is set to the created XA Transaction object.
 - The State is set to Awaiting Open Response.
 - The Action is set to None.
 - If failed:
 - Return XAER_RMERR.
 - Set the State of the created XA Transaction object to Opening.
 - Send an XAUSER_XACT_MTAG_OPEN message with the following values:
 - The **guidXaRm** is set to the Resource Manager Recovery GUID field of the found XA Superior Proxy object.

- The **lenXAIdentifier** field of the XA_UOW structure in the **XAUow** field is set to size of an XA_XID structure.
- The **XAIdentifier** field of the XA_UOW structure in the **XAUow** field is set to the provided XID field.
- Wait for a response and continue with the processing rules defined in [CONNTYPE_XAUSER_XACT_OPEN Initiator \(section 3.3.5.3\)](#).
- Otherwise:
 - Attempt to create a new XA Transaction CMP Connection object with the following values:
 - The Connection type is set to CONNTYPE_XAUSER_XACT_START.
 - The XA Transaction object is set to the created XA Transaction object.
 - The **State** field is set to Awaiting Start Response.
 - The **Action** field is set to None.
 - If failed:
 - Return XAER_RMERR.
 - The State of the created XA Transaction object is set to Starting.
 - Send an XAUSER_XACT_MTAG_START message with the following values:
 - The **guidXaRm** field is set to the Resource Manager Recovery GUID field of the found XA Superior Proxy object.
 - The **lenXAIdentifier** field of the XA_UOW structure in the **XAUow** field is set to size of an XA_XID structure.
 - The **XAIdentifier** field of the XA_UOW structure in the **XAUow** field is set to the provided XID field.
 - The **isoLevel** field is set to ISOLATIONLEVEL_ISOLATED.
 - The **Timeout** field is set to the Transaction Timeout field of the found XA Superior Proxy object.
 - If the TM field of the found XA Superior Proxy is not set to "":
 - Set the **szDesc** field of the message to "Transaction", appended if possible.
 - Otherwise:
 - Set the **szDesc** field of the message to "XA Transaction".
 - The **isoFlags** field is set to 0.
 - Wait for a response and continue with the processing rules defined in [CONNTYPE_XAUSER_XACT_START Initiator \(section 3.3.5.2\)](#).

3.3.5 Processing Events and Sequencing Rules

3.3.5.1 CONNTYPE_XAUSER_CONTROL Initiator

This is an **XA Superior Proxy CMP Connection**.

For all messages received in this [Connection Type](#), the XA Superior Transaction Manager Facet MUST process the message as specified in section [3.1](#). The XA Superior Transaction Manager Facet MUST also follow the processing rules specified in the following sections.

3.3.5.1.1 Receiving an XAUSER_CONTROL_MTAG_CREATE_NO_MEM Message

When the XA Superior Transaction Manager receives the following:

- [XAUSER_CONTROL_MTAG_CREATE_NO_MEM](#)

It MUST perform the following actions:

- If the State field of the receiving XA Superior Proxy CMP Connection is set to Awaiting Creation Response:
 - Return XAER_RMERR from xa_open call.
 - Signal the Disconnect Connection event using the receiving connection as the argument.
- Otherwise:
 - Signal the Disconnect Connection event using the receiving connection as the argument.

3.3.5.1.2 Receiving an XAUSER_CONTROL_MTAG_CREATED Message

When the XA Superior Transaction Manager receives an [XAUSER_CONTROL_MTAG_CREATED](#) message, it MUST perform the following actions:

- If the State field of receiving XA Superior Proxy CMP Connection is set to Awaiting Creation Response:
 - Set the State field of receiving XA Superior Proxy CMP Connection to Active.
 - Add the XA Superior Proxy object referenced by receiving connection to XA Superior Proxy Table with the key set to the value of the Resource Manager ID field of the XA Superior Proxy object.
 - Return XA_OK from xa_open call.
- Otherwise:
 - Signal the Disconnect Connection event using the receiving connection as the argument.

3.3.5.1.3 Receiving an XAUSER_CONTROL_MTAG_RECOVER_NO_MEM Message

When the XA Superior Transaction Manager receives an [XAUSER_CONTROL_MTAG_RECOVER_NO_MEM](#) message, it MUST perform the following actions:

- If the State field of the receiving XA Superior Proxy CMP Connection is set to Awaiting Recovery Response:
 - Return XAER_RMFAIL from xa_recover call.
 - Set the State field of the receiving connection to Active.

- Signal the Disconnect Connection event using the receiving connection as the argument.
- Remove the XA Superior Proxy object referenced by receiving connection from XA Superior Proxy Table.
- Otherwise:
 - Signal the Disconnect Connection event using the receiving connection as the argument.
 - Remove the XA Superior Proxy object referenced by receiving connection from XA Superior Proxy Table.

3.3.5.1.4 Receiving an XAUSER_CONTROL_MTAG_RECOVER_REPLY Message

When the XA Superior Transaction Manager receives an XAUSER_CONTROL_MTAG_RECOVER_REPLY message, it MUST perform the following actions:

- If the **State** of the receiving Connection is not set to [Awaiting Recovery Response \(section 3.3.1.3.4\)](#):
 - Signal the Disconnect Connection event using the receiving connection as the argument.
 - Remove the **XA Superior Proxy object** referenced by the receiving connection from the **XA Superior Proxy Table**.
- Otherwise:
 - Set the **State** of the receiving connection to Active.
 - If the **ulTotalUoWs** field of the message is greater than **Recovery Request Number**, the XA Superior Transaction Manager SHOULD perform the following actions:
 - SHOULD [<34>](#) return XAER_RMFAIL from an xa_recover call.
 - Signal the Disconnect Connection event using the receiving connection as the argument.
 - Remove the **XA Superior Proxy object** referenced by the receiving connection from the **XA Superior Proxy Table**.
 - If the **ReplyFlags** field of the message has XARECOVER_END_OF_RECS set:
 - Set the **Recovery Complete** field of the **XA Superior Proxy object** referenced by the receiving connection.
 - Copy the **ulTotalUoWs** field of the message number of **XIDs** from the **UoW_Recs** field of the message to the **Recovery Array** of the **XA Superior Proxy object** referenced by the receiving connection.
 - Increment the **Recovery Return Number** field of the **XA Superior Proxy object** referenced by the receiving connection by the **ulTotalUoWs** field of the message.
 - If the **Recovery Return Number** field of the **XA Superior Proxy object** referenced by the receiving connection is set to the value of the **Recovery Max Return** field of the **XA Superior Proxy object** referenced by the receiving connection or the **ulTotalUoWs** field of the message is less than the **Recovery Request Number** field of the **XA Superior Proxy object** referenced by the receiving connection:
 - Return the **Recovery Return Number** field of the **XA Superior Proxy object** referenced by the receiving connection from xa_recover.

- Signal the Disconnect Connection event using the receiving connection as the argument.
- Otherwise:
 - Set the **Recovery Request Number** field of the **XA Superior Proxy object** referenced by the receiving connection to the minimum value between an implementation-specific value and the difference between the **Recovery Max Return** field of the **XA Superior Proxy Object** referenced by the receiving connection and the **Recovery Return Number** field of the **XA Superior Proxy Object** referenced by the receiving connection. <35>
 - Send an [XAUSER_CONTROL_MTAG_RECOVER](#) message (section 2.2.4.2.4) with the following values:
 - The **RequestFlags** field is set to XARECOVER_CONTINUE_SCAN.
 - The **totalUOWsRequested** field is set to the **Recovery Request Number** of the **XA Superior Proxy object** referenced by the receiving connection.
- Set the **State** of the receiving connection to Awaiting Recovery Response (section 3.3.1.3.4).

3.3.5.1.5 Connection Disconnected

When a [CONNTYPE_XAUSER_CONTROL](#) connection (section 2.2.4.2) is disconnected, it MUST perform the following actions:

- If the **State** field of the receiving **XA Superior Proxy CMP Connection** is set to [Awaiting Creation Response \(section 3.3.1.3.2\)](#):
 - Return XAER_RMERR from xa_open call.
 - Signal the Disconnect Connection event using the receiving connection as the argument.
- Otherwise, if the **State** field of the receiving **XA Superior Proxy CMP Connection** is set to [Awaiting Recovery Response \(section 3.3.1.3.4\)](#):
 - Return XAER_RMFAIL from the xa_recover call.
 - Signal the Disconnect Connection event using the receiving connection as the argument.
 - Remove the **XA Superior Proxy object** referenced by the receiving connection from the **XA Superior Proxy Table**.
- Otherwise:
 - Signal the Disconnect Connection event using the receiving connection as the argument.

3.3.5.2 CONNTYPE_XAUSER_XACT_START Initiator

This is an **XA Transaction CMP Connection**.

For all messages received in this [Connection Type](#), the XA Superior Transaction Manager Facet MUST process the message as specified in section 3.1. The XA Superior Transaction Manager Facet MUST also follow the processing rules specified in the following sections.

3.3.5.2.1 Receiving an XAUSER_XACT_MTAG_STARTED Message

When the XA Superior Transaction Manager receives an [XAUSER_XACT_MTAG_STARTED](#) message, it MUST perform the following actions:

- If the State field of the receiving XA Transaction CMP Connection object is set to Awaiting Start Response:
 - Set the **Transaction Identifier** of XA Transaction object referenced by receiving connection to the **guidTx** field of the message.
 - Set the State of the receiving connection to Active.
 - Set the State of XA Transaction object referenced by receiving connection to Active.
 - Add the XA Transaction object referenced by receiving connection to XA Transaction Table referenced by the Parent XA Superior Proxy referenced by the XA Transaction object.
 - Return XA_OK from xa_start call.
- Otherwise:
 - Signal the Disconnect Connection event using the receiving connection as the argument.

3.3.5.2.2 Receiving an XAUSER_XACT_MTAG_START_NO_MEM Message

When the XA Superior Transaction Manager receives an [XAUSER_XACT_MTAG_START_NO_MEM](#) message, it MUST perform the following actions:

- If the State field of the receiving XA Transaction CMP Connection is set to Awaiting Start Response:
 - Return XAER_RMERR from xa_start call.
 - Signal the Disconnect Connection event using the receiving connection as the argument.
- Otherwise:
 - Signal the Disconnect Connection event using the receiving connection as the argument.

3.3.5.2.3 Receiving an XAUSER_XACT_MTAG_START_LOG_FULL Message

When the XA Superior Transaction Manager receives an [XAUSER_XACT_MTAG_START_LOG_FULL](#) message, it MUST perform the following actions:

- If the State field of the receiving XA Transaction CMP Connection is set to Awaiting Start Response:
 - Return XAER_RBTRANSIENT from xa_start call.
 - Signal the Disconnect Connection event using the receiving connection as the argument.
- Otherwise:
 - Signal the Disconnect Connection event using the receiving connection as the argument.

3.3.5.2.4 Receiving an XAUSER_XACT_MTAG_START_DUPLICATE Message

When the XA Superior Transaction Manager receives an [XAUSER_XACT_MTAG_START_DUPLICATE](#) message, it MUST perform the following actions:

- If the State field of the receiving XA Transaction CMP Connection is set to Awaiting Start Response:
 - Return XAER_DUPID from xa_start call.

- Signal the Disconnect Connection event using the receiving connection as the argument.
- Otherwise:
 - Signal the Disconnect Connection event using the receiving connection as the argument.

3.3.5.2.5 Connection Disconnected

When a [CONNTYPE_XAUSER_XACT_START](#) connection (section 2.2.4.3) is disconnected, the XA Superior Transaction Manager MUST perform the following actions:

- If the **State** field of the receiving **XA Transaction CMP Connection** is set to [Awaiting Start Response \(section 3.3.1.4.2\)](#):
 - Return XAER_RMFAIL from xa_start call.
- Disconnect the receiving connection.

3.3.5.3 CONNTYPE_XAUSER_XACT_OPEN Initiator

3.3.5.3.1 Receiving an XAUSER_XACT_MTAG_OPENED Message

When the XA Superior Transaction Manager receives an [XAUSER_XACT_MTAG_OPENED](#) message, it MUST perform the following actions:

- If the State field of the receiving XA Transaction CMP Connection is set to Awaiting Open Response:
 - Set the **Transaction Identifier** field of the XA Transaction object referenced by receiving connection to the **guidTx** field of the message.
 - Set the receiving connection state to Processing Opened Response.
 - Set the State field of the XA Transaction object referenced by receiving connection to Active.
 - Add the XA Transaction Object referenced by receiving connection to the XA Transaction Table referenced by the Parent XA Superior Proxy referenced by the XA Transaction object.
 - If the Action field of the receiving Connection is set to Prepare:
 - Set the State field of the receiving connection to Awaiting Prepare Response.
 - Set the State field of XA Transaction object referenced by receiving connection to Preparing.
 - Send an [XAUSER_XACT_MTAG_PREPARE](#) message with the following values:
 - The **fSinglePhase** field set to 0x00000000.
 - Otherwise if the Action field of the receiving Connection is set to Prepare Single Phase:
 - Set the State field of the receiving connection to Awaiting Prepare Response.
 - Set the State field of the XA Transaction object referenced by receiving connection to Preparing.
 - Send an XAUSER_XACT_MTAG_PREPARE message with the following values:
 - The **fSinglePhase** field set to 0x00000001.
 - Otherwise if the Action field of the receiving Connection is set to Commit:

- Set the State of the receiving connection to Awaiting Commit Response.
- Set the State field of the XA Transaction object referenced by receiving connection to Committing.
- Send an [XAUSER XACT MTAG COMMIT](#) message.
- Otherwise if the Action field of the receiving Connection is set to Rollback:
 - Set the State field of the receiving connection to Awaiting Abort Response.
 - Set the State field of the XA Transaction object referenced by receiving connection to Aborting.
 - Send an [XAUSER XACT MTAG ABORT](#) message.
- Otherwise:
 - Signal the Disconnect Connection event using the receiving connection as the argument.

3.3.5.3.2 Receiving an XAUSER_XACT_MTAG_OPEN_NOT_FOUND Message

When the XA Superior Transaction Manager receives an [XAUSER XACT MTAG OPEN NOT FOUND](#) message, it MUST perform the following actions:

- If the State of receiving XA Transaction CMP Connection is set to Awaiting Open Response:
 - Return XAER_NOTA from originating XA call.
 - Signal the Disconnect Connection event using the receiving connection as the argument.

3.3.5.3.3 Receiving an XAUSER_XACT_MTAG_REQUEST_COMPLETED Message

When the XA Superior Transaction Manager receives an [XAUSER XACT MTAG REQUEST COMPLETED](#) message, it MUST perform the following actions:

- If the State field of the receiving Connection is set to Awaiting Prepare Response:
 - Set the State field of the XA Transaction object to Prepared.
 - Signal the Disconnect Connection event using the receiving Connection as the argument.
 - Return XA_OK from xa_prepare call.
- If the State field of the receiving Connection is set to Awaiting Commit Response:
 - Set the State field of the XA Transaction object to Complete.
 - Signal the Disconnect Connection event using the receiving Connection as the argument.
 - Remove the XA Transaction object from the XA Transaction Table referenced by the Parent XA Superior Proxy object referenced by the XA Transaction object.
 - Return XA_OK from xa_commit call.
- If the State field of the receiving Connection is set to Awaiting Abort Response:
 - Set the State field of the XA Transaction object to Complete.
 - Signal the Disconnect Connection event using the receiving Connection as the argument.

- Remove the XA Transaction object from the XA Transaction Table referenced by the Parent XA Superior Proxy object referenced by the XA Transaction object.
- Return XA_OK from xa_rollback call.

3.3.5.3.4 Receiving an XAUSER_XACT_MTAG_PREPARE_ABORT Message

When the XA Superior Transaction Manager receives an [XAUSER_XACT_MTAG_PREPARE_ABORT](#) message, it MUST perform the following actions:

- If Receiving connection state is Awaiting Prepare Response:
 - Set the State field of the XA Transaction object to Complete.
 - Signal the Disconnect Connection event using the receiving Connection as the argument.
 - Remove the XA Transaction object from the XA Transaction Table referenced by the Parent XA Superior Proxy object referenced by the XA Transaction object.
 - Return XA_RBROLLBACK from xa_prepare call.

3.3.5.3.5 Receiving an XAUSER_XACT_MTAG_PREPARE_SINGLEPHASE_INDOUBT Message

When the XA Superior Transaction Manager receives an [XAUSER_XACT_MTAG_PREPARE_SINGLEPHASE_INDOUBT](#) message, it MUST perform the following actions:

- If the State field of the receiving connection is set to Awaiting Prepare Response:
 - Set the State field of the XA Transaction object to Complete.
 - Signal the Disconnect Connection event using the receiving Connection as the argument.
 - Remove the XA Transaction object from the XA Transaction Table referenced by the Parent XA Superior Proxy object referenced by the XA Transaction object.
 - Return XA_RBPROTO from xa_prepare call.

3.3.5.3.6 Receiving an XAUSER_XACT_MTAG_REQUEST_FAILED_BAD_PROTOCOL Message

When the XA Superior Transaction Manager receives an [XAUSER_XACT_MTAG_REQUEST_FAILED_BAD_PROTOCOL](#) message, it MUST perform the following actions:

- If the State field of the receiving connection is set to Awaiting Prepare Response:
 - Set the State field of the XA Transaction object to Complete.
 - Signal the Disconnect Connection event using the receiving Connection as the argument.
 - Remove the XA Transaction object from the XA Transaction Table referenced by the Parent XA Superior Proxy object referenced by the XA Transaction object.
 - Return XAER_PROTO from xa_prepare call.
- If the State field of the receiving connection is set to Awaiting Commit Response:
 - Set the State field of the XA Transaction object to Complete.

- Signal the Disconnect Connection event using the receiving Connection as the argument.
- Remove the XA Transaction object from the XA Transaction Table referenced by the Parent XA Superior Proxy object referenced by the XA Transaction object.
- Return XAER_PROTO from xa_commit call.
- If the State field of the receiving connection is set to Awaiting Abort Response:
 - Set the State field of the XA Transaction object to Complete.
 - Signal the Disconnect Connection event using the receiving Connection as the argument.
 - Remove the XA Transaction object from the XA Transaction Table referenced by the Parent XA Superior Proxy object referenced by the XA Transaction object.
 - Return XAER_PROTO from xa_rollback call.

3.3.5.3.7 Connection Disconnected

When a [CONNTYPE_XAUSER_XACT_OPEN](#) connection (section 2.2.4.5) is disconnected, the XA Superior Transaction Manager MUST perform the following actions:

- If the State field of the receiving connection is set to Awaiting Open Response:
 - Disconnect the receiving Connection.
 - Return XA_RBCOMMFAIL from the originating XA call.
- If the State field of the receiving connection is set to Awaiting Prepare Response:
 - Set the State field of the XA Transaction object to Complete.
 - Disconnect the receiving Connection.
 - Remove the XA Transaction object from the XA Transaction Table referenced by the Parent XA Superior Proxy object referenced by the XA Transaction object.
 - Return XA_RBCOMMFAIL from xa_prepare call.
- If the State field of the receiving connection is set to Awaiting Commit Response:
 - Set the State field of the XA Transaction object to Complete.
 - Disconnect the receiving Connection.
 - Remove the XA Transaction object from the XA Transaction Table referenced by the Parent XA Superior Proxy object referenced by the XA Transaction object.
 - SHOULD return XAER_RMFAIL from xa_commit call. [<36>](#)
- If the State field of the receiving connection is set to Awaiting Abort Response:
 - Set the State field of the XA Transaction object to Complete.
 - Disconnect receiving Connection.
 - Remove the XA Transaction object from the XA Transaction Table referenced by the Parent XA Superior Proxy object referenced by the XA Transaction object.
 - SHOULD return XAER_RMFAIL from xa_rollback call. [<37>](#)

3.3.5.4 CONNTYPE_XAUSER_XACT_MIGRATE Initiator

3.3.5.4.1 Receiving an XAUSER_XACT_MTAG_SUSPEND_WITH_MIGRATE_DONE Message

When the XA Superior Transaction Manager receives an [XAUSER_XACT_MTAG_SUSPEND_WITH_MIGRATE_DONE](#) message, it MUST perform the following actions:

- If the State field of the XA Transaction object referenced by the receiving connection is set to Suspended:
 - Set the Migrate field of the XA Transaction object to TRUE.
 - Return XA_OK from xa_end.
 - Set the Connection state to Ended.

3.3.5.4.2 Receiving an XAUSER_XACT_MTAG_RESUME_DONE Message

When the XA Superior Transaction Manager receives an [XAUSER_XACT_MTAG_RESUME_DONE](#) message (section 2.2.4.7.2), it MUST perform the following actions:

- If the State field of the XA Transaction object referenced by the receiving connection is set to Suspended:
 - Leave the Transaction Identifier field of the XA Transaction referenced by the receiving connection uninitialized. The behavior is different for the same event on a CONNTYPE_XAUSER_XACT_MIGRATE2 connection (section [3.3.5.7.2](#)).
 - Set the State field of the XA Transaction object referenced by the receiving connection to Active.
 - Insert the XA Transaction object in the XA Transaction Table referenced by the Parent XA Superior Proxy object referenced by the XA Transaction object.
 - Return XA_OK from xa_start call.
 - Set the Connection state to Ended.
- Otherwise:
 - Signal the Disconnect Connection event using the receiving Connection as the argument.

3.3.5.4.3 Receiving an XAUSER_XACT_MTAG_TRANSACTION_NOT_SUSPENDED Message

When the XA Superior Transaction Manager receives an [XAUSER_XACT_MTAG_TRANSACTION_NOT_SUSPENDED](#) message, it MUST perform the following actions:

- If the State field of the XA Transaction object referenced by the receiving connection is set to Suspended:
 - Signal the Disconnect Connection event using the receiving Connection as the argument.
 - Return XAER_PROTO from xa_start call.
- Otherwise:

- Signal the Disconnect Connection event using the receiving Connection as the argument.

3.3.5.4.4 Receiving an XAUSER_XACT_MTAG_OPEN_NOT_FOUND Message

When the XA Superior Transaction Manager receives an [XAUSER_XACT_MTAG_OPEN_NOT_FOUND](#) message, it MUST perform the following actions:

- If the State field of the XA Transaction object referenced by the receiving connection is set to Suspended:
 - Signal the Disconnect Connection event using the receiving Connection as the argument.
 - Return XAER_NOTA from xa_start call.
- Otherwise:
 - Signal the Disconnect Connection event using the receiving Connection as the argument.

3.3.5.4.5 Receiving an XAUSER_XACT_MTAG_START_NO_MEM Message

When the XA Superior Transaction Manager receives an [XAUSER_XACT_MTAG_START_NO_MEM](#) message, it MUST perform the following actions:

- If the State field of the XA Transaction object referenced by the receiving connection is set to Suspended:
 - Signal the Disconnect Connection event using the receiving Connection as the argument.
 - Return XAER_RMERR from xa_start call.
- Otherwise:
 - Signal the Disconnect Connection event using the receiving Connection as the argument.

3.3.5.4.6 Connection Disconnected

When a [CONNTYPE_XAUSER_XACT_MIGRATE](#) connection (section 2.2.4.7) is disconnected, the XA Superior Transaction Manager MUST perform the following actions:

- If the **State** field of the XA Transaction object referenced by the receiving connection is set to **Suspended**:
 - Disconnect the receiving connection.
 - Return XAER_NOTA from xa_start call.
- Otherwise:
 - Disconnect the receiving connection.

3.3.5.5 CONNTYPE_XAUSER_XACT_BRANCH_START Initiator

3.3.5.5.1 Receiving an XAUSER_XACT_MTAG_STARTED Message

When the XA Superior Transaction Manager receives an [XAUSER_XACT_MTAG_STARTED](#) message, it MUST perform the following actions:

- If the State field of the receiving XA Transaction CMP Connection object is set to Awaiting Start Response:

- Set the **Transaction Identifier** field of the XA Transaction object referenced by receiving connection to the **guidTx** field of the message.
- Set the State field of the receiving connection to Active.
- Set the State field of the XA Transaction object referenced by receiving connection to Active.
- Add the XA Transaction Object referenced by the receiving connection to the XA Transaction Table, referenced by the Parent XA Superior Proxy object referenced by the XA Transaction object.
- Return XA_OK from xa_start call.
- Otherwise:
 - Signal the Disconnect Connection event using the receiving Connection as the argument.

3.3.5.5.2 Receiving an XAUSER_XACT_MTAG_START_NO_MEM Message

When the XA Superior Transaction Manager receives an [XAUSER_XACT_MTAG_START_NO_MEM](#) message, it MUST perform the following actions:

- If the State field of the receiving XA Transaction CMP Connection object is set to Awaiting Start Response:
 - Return XAER_RMERR from xa_start call.
 - Signal the Disconnect Connection event using the receiving Connection as the argument.
- Otherwise:
 - Signal the Disconnect Connection event using the receiving Connection as the argument.

3.3.5.5.3 Receiving an XAUSER_XACT_MTAG_START_LOG_FULL Message

When the XA Superior Transaction Manager receives an [XAUSER_XACT_MTAG_START_LOG_FULL](#) message, it MUST perform the following actions:

- If the State field of the receiving XA Transaction CMP Connection object is set to Awaiting Start Response:
 - Return XA_RBTRANSIENT from xa_start call.
 - Signal the Disconnect Connection event using the receiving Connection as the argument.
- Otherwise:
 - Signal the Disconnect Connection event using the receiving Connection as the argument.

3.3.5.5.4 Receiving an XAUSER_XACT_MTAG_START_DUPLICATE Message

When the XA Superior Transaction Manager receives an [XAUSER_XACT_MTAG_START_DUPLICATE](#) message, it MUST perform the following actions:

- If the State field of the receiving XA Transaction CMP Connection object is set to Awaiting Start Response:
 - Return XAER_DUPID from xa_start call.
 - Signal the Disconnect Connection event using the receiving Connection as the argument.

- Otherwise:
 - Signal the Disconnect Connection event using the receiving Connection as the argument.

3.3.5.5.5 Connection Disconnected

When a [CONNTYPE_XAUSER_XACT_BRANCH_START](#) connection (section 2.2.4.4) is disconnected, the XA Superior Transaction Manager MUST perform the following actions:

- If the **State** field of the receiving **XA Transaction CMP Connection** object is set to [Awaiting Start Response \(section 3.3.1.7.2\)](#):
 - Return XAER_RMFAIL from xa_start call.
 - Disconnect the receiving connection.
- Otherwise:
 - Disconnect the receiving connection.

3.3.5.6 CONNTYPE_XAUSER_XACT_BRANCH_OPEN Initiator

3.3.5.6.1 Receiving an XAUSER_XACT_MTAG_OPENED Message

When the XA Superior Transaction Manager receives an [XAUSER_XACT_MTAG_OPENED](#) message, it MUST perform the following actions:

- If the State field of the receiving XA Transaction CMP Connection object is set to Awaiting Open Response:
 - Set **Transaction Identifier** of XA Transaction object referenced by receiving connection to the **guidTx** field of the message.
 - Set the State of the receiving Connection to Processing Opened Response.
 - Set the State field of the XA Transaction object referenced by receiving connection to Active.
 - If the Action field of the receiving Connection is set to Prepare:
 - Set the State field of the receiving connection to Awaiting Prepare Response.
 - Set the State field of the XA Transaction object referenced by receiving connection to Preparing.
 - Send an [XAUSER_XACT_MTAG_PREPARE](#) message with the following values:
 - The **fSinglePhase** field is set to 0x00000000.
 - Otherwise, if the Action field of the receiving Connection is set to Prepare Single Phase:
 - Set the State of the receiving connection to Awaiting Prepare Response.
 - Set the State field of the XA Transaction object referenced by receiving connection to Preparing.
 - Send an XAUSER_XACT_MTAG_PREPARE message with the following values:
 - The **fSinglePhase** field is set to 0x00000001.
- Otherwise, if the Action field of the receiving Connection is set to Commit:

- Set the State of the receiving connection to Awaiting Commit Response.
- Set the State field of the XA Transaction object referenced by receiving connection to Committing.
- Send an [XAUSER_XACT_MTAG_COMMIT](#) message.
- Otherwise, if the Action field of the receiving Connection is set to Rollback:
 - Set the State of the receiving connection to Awaiting Abort Response.
 - Set State of XA Transaction object referenced by the receiving Connection to Aborting.
 - Send an [XAUSER_XACT_MTAG_ABORT](#) message.
- Otherwise:
 - Signal the Disconnect Connection event using the receiving Connection as the argument.

3.3.5.6.2 Receiving an XAUSER_XACT_MTAG_OPEN_NOT_FOUND Message

When the XA Superior Transaction Manager receives an [XAUSER_XACT_MTAG_OPEN_NOT_FOUND](#) message, it MUST perform the following actions:

- If the State field of the receiving XA Transaction CMP Connection object is set to Awaiting Open Response:
 - Return XAER_NOTA from originating XA call.
 - Signal the Disconnect Connection event using the receiving Connection as the argument.

3.3.5.6.3 Receiving an XAUSER_XACT_MTAG_REQUEST_COMPLETED Message

When the XA Superior Transaction Manager receives an [XAUSER_XACT_MTAG_REQUEST_COMPLETED](#) message, it MUST perform the following actions:

- If the State field of the receiving Connection is set to Awaiting Prepare Response:
 - Set the State field of the XA Transaction object to Prepared.
 - Signal the Disconnect Connection event using the receiving Connection as the argument.
 - Return XA_OK from xa_prepare call.
- If the State field of the receiving Connection is set to Awaiting Commit Response:
 - Set the State field of the XA Transaction object to Complete.
 - Signal the Disconnect Connection event using the receiving Connection as the argument.
 - Remove the XA Transaction object from the XA Transaction Table referenced by the Parent XA Superior Proxy object referenced by the XA Transaction object.
 - Return XA_OK from xa_commit call.
- If the State field of the receiving Connection is set to Awaiting Abort Response:
 - Set the State field of the XA Transaction object to Complete.
 - Signal the Disconnect Connection event using the receiving Connection as the argument.

- Remove the XA Transaction object from the XA Transaction Table referenced by the Parent XA Superior Proxy object referenced by the XA Transaction object.
- Return XA_OK from xa_rollback call.

3.3.5.6.4 Receiving an XAUSER_XACT_MTAG_PREPARE_ABORT Message

When the XA Superior Transaction Manager receives an [XAUSER_XACT_MTAG_PREPARE_ABORT](#) message, it MUST perform the following actions:

- If the State field of the receiving Connection is set to Awaiting Prepare Response:
 - Set the State field of the XA Transaction object to Complete.
 - Signal the Disconnect Connection event using the receiving Connection as the argument.
 - Remove the XA Transaction object from the XA Transaction Table referenced by the Parent XA Superior Proxy object referenced by the XA Transaction object.
 - Return XA_RBROLLBACK from xa_prepare.

3.3.5.6.5 Receiving an XAUSER_XACT_MTAG_PREPARE_SINGLEPHASE_INDOUBT Message

When the XA Superior Transaction Manager receives an [XAUSER_XACT_MTAG_PREPARE_SINGLEPHASE_INDOUBT](#) message, it MUST perform the following actions:

- If the State field of the receiving Connection is set to Awaiting Prepare Response:
 - Set the State field of the XA Transaction object to Complete.
 - Signal the Disconnect Connection event using the receiving Connection as the argument.
 - Remove the XA Transaction object from the XA Transaction Table referenced by the Parent XA Superior Proxy object referenced by the XA Transaction object.
 - Return XA_RBPROTO from xa_prepare.

3.3.5.6.6 Receiving an XAUSER_XACT_MTAG_REQUEST_FAILED_BAD_PROTOCOL Message

When the XA Superior Transaction Manager receives an [XAUSER_XACT_MTAG_REQUEST_FAILED_BAD_PROTOCOL](#) message, it MUST perform the following actions:

- If the **State** field of the receiving Connection is set to Awaiting Prepare Response:
 - Set the **State** field of the XA Transaction object to Complete.
 - Signal the Disconnect Connection event using the receiving Connection as the argument.
 - Remove the XA Transaction object from the XA Transaction Table referenced by the Parent XA Superior Proxy object referenced by the XA Transaction object.
 - Return XAER_PROTO from xa_prepare.
- If the **State** field of the receiving Connection is set to Awaiting Commit Response:
 - Set the **State** field of the XA Transaction object to Complete.

- Signal the Disconnect Connection event using the receiving Connection as the argument.
- Remove the XA Transaction object from the XA Transaction Table referenced by the Parent XA Superior Proxy object referenced by the XA Transaction object.
- Return XAER_PROTO from xa_commit call.
- If the **State** field of the receiving Connection is set to Awaiting Abort Response:
 - Set the **State** field of the XA Transaction object to Complete.
 - Signal the Disconnect Connection event using the receiving Connection as the argument.
 - Remove the XA Transaction object from the XA Transaction Table referenced by the Parent XA Superior Proxy object referenced by the XA Transaction object.
 - Return XAER_PROTO from xa_rollback call.

3.3.5.6.7 Receiving an XAUSER_XACT_MTAG_READONLY Message

When the XA Superior Transaction Manager receives an [XAUSER_XACT_MTAG_READONLY](#) message, it MUST perform the following actions:

- If the State field of the receiving Connection is set to Awaiting Prepare Response:
 - Set the State field of the XA Transaction object to Complete.
 - Signal the Disconnect Connection event using the receiving Connection as the argument.
 - Remove the XA Transaction object from the XA Transaction Table referenced by the Parent XA Superior Proxy object referenced by the XA Transaction object.
 - Return XA_RDONLY from xa_prepare.

3.3.5.6.8 Connection Disconnected

When a [CONNTYPE_XAUSER_XACT_BRANCH_OPEN](#) connection (section 2.2.4.6) is disconnected, the XA Superior Transaction Manager MUST perform the following actions:

- If the State field of the receiving Connection is set to Awaiting Open Response:
 - Disconnect the receiving Connection.
 - Return XA_RBCOMMFAIL from the originating XA call.
- If the State field of the receiving Connection is set to Awaiting Prepare Response:
 - Set the State field of the XA Transaction object to Complete.
 - Disconnect the receiving Connection.
 - Remove the XA Transaction object from the XA Transaction Table referenced by the Parent XA Superior Proxy object referenced by the XA Transaction object.
 - Return XA_RBCOMMFAIL from xa_prepare.
- If the State field of the receiving Connection is set to Awaiting Commit Response:
 - Set the State field of the XA Transaction object to Complete.
 - Disconnect the receiving Connection.

- Remove the XA Transaction object from the XA Transaction Table referenced by the Parent XA Superior Proxy object referenced by the XA Transaction object.
- SHOULD return XAER_RMFAIL from xa_commit call. <38>
- If the State field of the receiving Connection is set to Awaiting Abort Response:
 - Set the State field of the XA Transaction object to Complete.
 - Disconnect the receiving Connection.
 - Remove the XA Transaction object from the XA Transaction Table referenced by the Parent XA Superior Proxy object referenced by the XA Transaction object.
 - SHOULD return XAER_RMFAIL from xa_rollback call. <39>

3.3.5.7 CONNTYPE_XAUSER_XACT_MIGRATE2 Initiator

3.3.5.7.1 Receiving an XAUSER_XACT_MTAG_SUSPEND_WITH_MIGRATE_DONE Message

When the XA Superior Transaction Manager receives an [XAUSER_XACT_MTAG_SUSPEND_WITH_MIGRATE_DONE](#) message, it MUST perform the following actions:

- If the State field of the XA Transaction object referenced by receiving connection is set to Suspended:
 - Set the Migrate field of the XA Transaction object to TRUE.
 - Return XA_OK from xa_end.

3.3.5.7.2 Receiving an XAUSER_XACT_MTAG_RESUME_DONE Message

When the XA Superior Transaction Manager receives an [XAUSER_XACT_MTAG_RESUME_DONE](#) message (section 2.2.4.8.1), it MUST perform the following actions:

- If the State field of the XA Transaction object referenced by the receiving connection is set to Suspended:
 - Set the **Transaction Identifier** field of the XA Transaction referenced by the receiving connection to the **guidTx** field of the message.
 - Insert the XA Transaction object into the XA Transaction Table referenced by the Parent XA Superior Proxy object referenced by the XA Transaction object.
 - Set the State field of the XA Transaction object to Active.
 - Return XA_OK from xa_start call.
- Otherwise:
 - Signal the Disconnect Connection event using the receiving Connection as the argument.

3.3.5.7.3 Receiving an XAUSER_XACT_MTAG_TRANSACTION_NOT_SUSPENDED Message

When the XA Superior Transaction Manager receives an [XAUSER_XACT_MTAG_TRANSACTION_NOT_SUSPENDED](#) message, it MUST perform the following actions:

- If the State of XA Transaction referenced by the receiving connection is Suspended:
 - Signal the Disconnect Connection event using the receiving Connection as the argument.
 - Return XAER_PROTO from xa_start call.
- Otherwise:
 - Signal the Disconnect Connection event using the receiving Connection as the argument.

3.3.5.7.4 Connection Disconnected

When a [CONNTYPE_XAUSER_XACT_MIGRATE2](#) connection (section 2.2.4.8) is disconnected, the XA Superior Transaction Manager MUST perform the following actions:

- If the **State** field of the XA Transaction object referenced by the receiving connection is set to Suspended:
 - Disconnect the receiving connection.
 - Return XAER_NOTA from xa_start call.
- Otherwise:
 - Disconnect the receiving connection.

3.3.5.7.5 Receiving an XAUSER_XACT_MTAG_START_NO_MEM Message

When the XA Superior Transaction Manager receives an [XAUSER_XACT_MTAG_START_NO_MEM](#) message, it MUST perform the following actions:

- If the State field of the XA Transaction object referenced by the receiving connection is set to Suspended:
 - Disconnect the receiving connection.
 - Return XAER_RMERR from xa_start call.
- Otherwise:
 - Disconnect the receiving connection.

3.3.5.7.6 Receiving an MTAG_CONNECTION_REQ_DENIED Message

When the XA Superior Transaction Manager receives an MTAG_CONNECTION_REQ_DENIED message, it MUST perform the following actions:

- If the State field of the XA Transaction Object referenced by receiving connection is set to Suspended:
 - Set the Connection Type field of the XA Transaction CMP Connection object to CONNTYPE_XAUSER_XACT_MIGRATE.<40>
 - Send an [XAUSER_XACT_MTAG_RESUME](#) message with the following values:
 - The **guidXaRm** field is set to the **Resource Manager Recovery GUID** field of the Parent XA Superior Proxy Object referenced by the XA Transaction Object referenced by the receiving connection.
 - The **lenXAIdentifier** field is set to size of an [XA_XID](#) structure (section 2.2.1.3).

- The **XAIdentifier** field is set to the **XID** field of the XA Transaction Object referenced by the receiving connection.
- The **dwProcessId** field is set to the Current Process ID.
- The **dwThreadId** field is set to the Current Thread ID.

3.3.5.7.7 Receiving an XAUSER_XACT_MTAG_OPEN_NOT_FOUND Message

When the XA Superior Transaction Manager receives an [XAUSER_XACT_MTAG_OPEN_NOT_FOUND](#) message, it MUST perform the following actions:

- If the State field of the XA Transaction object referenced by the receiving connection is set to Suspended:
 - Signal the Disconnect Connection event using the receiving Connection as the argument.
 - Return XAER_NOTA from xa_start call.
- Otherwise:
 - Signal the Disconnect Connection event using the receiving Connection as the argument.

3.3.6 Timer Events

None.

3.3.7 Other Local Events

None.

3.4 XA Resource Manager Bridge Facet Details

3.4.1 Abstract Data Model

This section describes a conceptual model of possible data organization that an implementation maintains to participate in this protocol. The described organization is provided to facilitate the explanation of how the protocol behaves. This document does not mandate the implementations adhere to this model as long as their external behavior is consistent with the behavior that is described in this document.

Note that the abstract data model can be implemented in a variety of ways. This protocol does not prescribe or advocate any specific implementation technique.

The XA Resource Manager Bridge Facet MUST maintain all the data elements that are specified in section [3.1.1](#).

The XA Resource Manager Bridge Facet MUST also maintain the following data elements:

- **XA Resource Manager Durable Log:** A durable list of **XA Resource Manager** objects. The contents of this log MUST persist across software restarts or **transient failures**.
- **XA Resource Manager Table:** A table of all currently active XA Resource Manager objects.
- **XA Resource Manager Identifier Index:** A monotonically increasing counter to provide Resource Manager Identifiers that are unique for the lifetime of an XA Resource Manager.

- **XaTmMinWarmRecoveryInterval:** Specifies minimum time in seconds to wait between Recovery attempts. After each successive failure the wait will be doubled to a maximum of XaTmMaxWarmRecoveryInterval.
- **XaTmMaxWarmRecoveryInterval:** Specifies maximum time in seconds to wait between **Recovery** attempts.
- **XA Resource Manager object:** Represents a currently active XA Resource Manager. This extends the **resource manager** object defined in [\[MS-DTCO\]](#):
 - When an XA Resource Manager object is stored in the XA Resource Manager Durable Log, the XA Resource Manager Bridge Facet MUST record only the following fields:
 - Resource Manager Global Identifier.
 - Data Source Name.
 - XA DLL Name.
 - This object MUST contain the following elements:
 - **Resource Manager Global Identifier:** Unique identifier associated with XA Resource Manager. Persists through failure and recovery.
 - **Data Source Name:** Implementation-specific ASCII string to be passed to xa_open and xa_close calls on the XA Switch.
 - **XA Resource Manager Identifier:** Integer identifier to be passed to XA calls. This identifier is unique for the lifetime of the XA Resource Manager instance.
 - **State:** Specifies the current state of XA Resource Manager object. This field MUST contain one of the following values:
 - **Idle:** This is the initial state.
 - **Recovering:** The Recovery processing is being carried out.
 - **Active:** The XA Resource Manager object has been registered.
 - **Ended:** The XA Resource Manager object has been unregistered.
 - **XA Switch:** Interface to XA Resource Manager. For a fuller definition, see [\[XOPEN-DTP\]](#) Chapter 5.
 - **Recovery Interval:** Specifies the interval for Recovery timer.
 - **XA DLL Name:** Specifies DLL Name used to look up XA Switch for XA Resource Manager.
 - **Single Pipe:** A flag used to indicate whether XA Resource is Single Pipe or **Two Pipe**.
 - **XA Subordinate Enlistment Table:** A table of currently existing XA Subordinate Enlistment objects in the XA Resource Manager object.
 - **Call Count:** Specifies number of calls made to register an XA Resource Manager object with a given Data Source Name.
 - **Request Connections Table:** A table containing the XA Resource Manager CMP Connection objects associated with the XA Resource Manager object.
 - **Pending Open Connections Table:** A Table containing the XA Resource Manager CMP Connection objects associated with registration requests received during recovery.

- **XA Subordinate Enlistment object:** Represents a XA Subordinate Enlistment to an **OleTx transaction**. This extends the **Enlistment** object specified in [MS-DTCO]. This object MUST contain the following elements:
 - **State:** Specifies the current state of XA Subordinate Enlistment object. This field MUST contain one of the following values:
 - **Idle:** This is the initial state.
 - **Enlisted:** XA Subordinate Enlistment object is enlisted in a transaction object.
 - **Prepared:** State field of the Transaction object associated with the XA Subordinate Enlistment object is set to Prepared.
 - **Ended:** The processing for the XA Subordinate Enlistment object has been completed.
 - **XID:** Specifies the XA Transaction Identifier associated with the Enlistment.
 - **Current Request Connection:** Specifies the CMP Connection on which the Enlistment request was received.
 - **XA Resource Manager:** Specifies the reference to the XA Resource Manager object corresponding to the XA Subordinate Enlistment object.
 - **Name:** The resource manager identifier field of the Enlistment object, formatted as a string specified in [C706] Appendix A.
 - **Identifier:** An empty string.
- **XA Resource Manager CMP Connection object:** CMP Connection associated with CONNTYPE_XATM_OPEN and CONNTYPE_XATM_OPENONEPIPE acceptors. The definition of an [MS-CMP] connection object is extended to include the following elements:
 - Reference to XA Resource Manager object
 - **State:** A state enumeration that represents the current state of the connection.
- **XA Subordinate Enlistment CMP Connection object:** CMP Connection associated with CONNTYPE_XATM_ENLIST acceptor. The definition of an [MS-CMP] connection object is extended to include the following elements:
 - A reference to an XA Subordinate Enlistment object
 - **State:** A state enumeration that represents the current state of the connection
- **Transaction Manager Name:** A **Name** object that identifies the **transaction manager**.

3.4.1.1 CONNTYPE_XATM_OPEN Acceptor States

The XA Resource Manager Bridge Facet MUST act as an acceptor for the CONNTYPE_XATM_OPEN connection type. In this role, the XA Resource Manager Bridge Facet MUST provide support for the following states:

- [Idle](#)
- [Processing Open Request](#)
- [Active](#)
- [Ended](#)

3.4.1.1.1 Idle

This is the initial state. The following event is processed in this state:

- [Receiving an XATMUSER_MTAG_RMOPEN Message](#) (section 3.4.5.1.1)

3.4.1.1.2 Processing Open Request

This is a transient state that is assumed during the synchronous processing of the [XATMUSER_MTAG_RMOPEN](#) request (section 2.2.3.2.5). No events are processed in this state.

3.4.1.1.3 Active

The following event is processed in this state:

- [Connection Disconnected](#) (section 3.4.5.1.2)

3.4.1.1.4 Ended

This is the final state.

3.4.1.1.5 State Diagram

The following figure shows the relationship between the CONNTYPE_XATM_OPEN acceptor states.

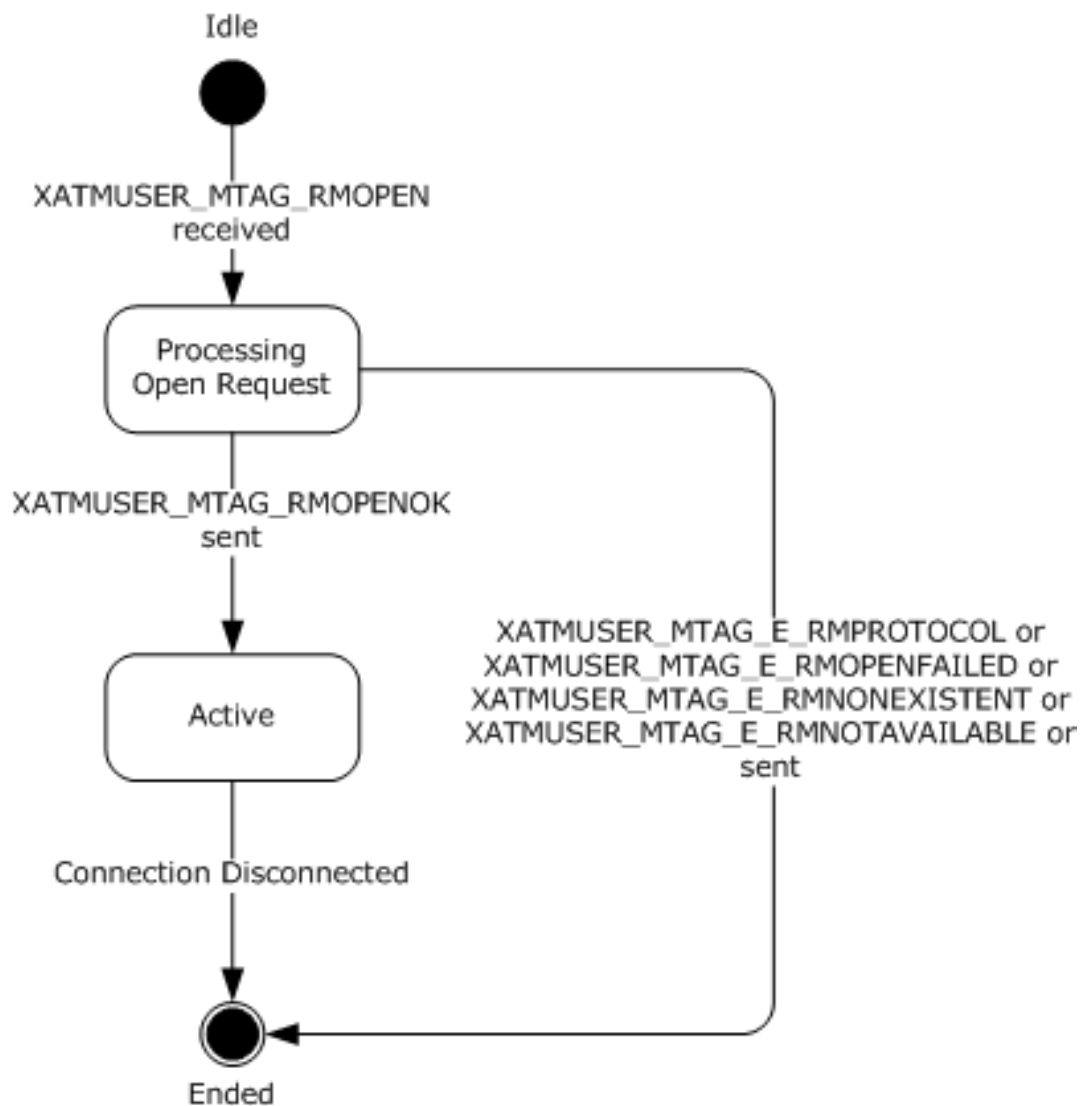

Figure 27: CONNTYPE_XATM_OPEN acceptor states

3.4.1.2 CONNTYPE_XATM_OPENONEPIPE Acceptor States

The XA Resource Manager Bridge Facet MUST act as an acceptor for the CONNTYPE_XATM_OPENONEPIPE connection type. In this role, the XA Resource Manager Bridge Facet MUST provide support for the following states:

- [Idle](#)
- [Processing Open Request](#).
- [Active](#)
- [Processing close Request](#)
- [Ended](#)

3.4.1.2.1 Idle

This is the initial state. The following event is processed in this state:

- [Receiving an XATMUSER MTAG RMOPEN Message](#) (section 3.4.5.1.1)

3.4.1.2.2 Processing Open Request

This is a transient state that is assumed during the synchronous processing of the [XATMUSER MTAG RMOPEN](#) request (section 2.2.3.2.5). No events are processed in this state.

3.4.1.2.3 Active

The following events are processed in this state:

- [Receiving an XATMUSER MTAG RMCLOSE Message](#) (section 3.4.5.2.2)
- [Connection Disconnected](#) (section 3.4.5.2.3)

3.4.1.2.4 Processing Close Request

This is a transient state that is assumed during the synchronous processing of the [XATMUSER MTAG RMCLOSE](#) request. No events are processed in this state.

3.4.1.2.5 Ended

This is the final state.

3.4.1.2.6 State Diagram

The following figure shows the relationship between the CONNTYPE_XATM_OPENONEPIPE acceptor states.

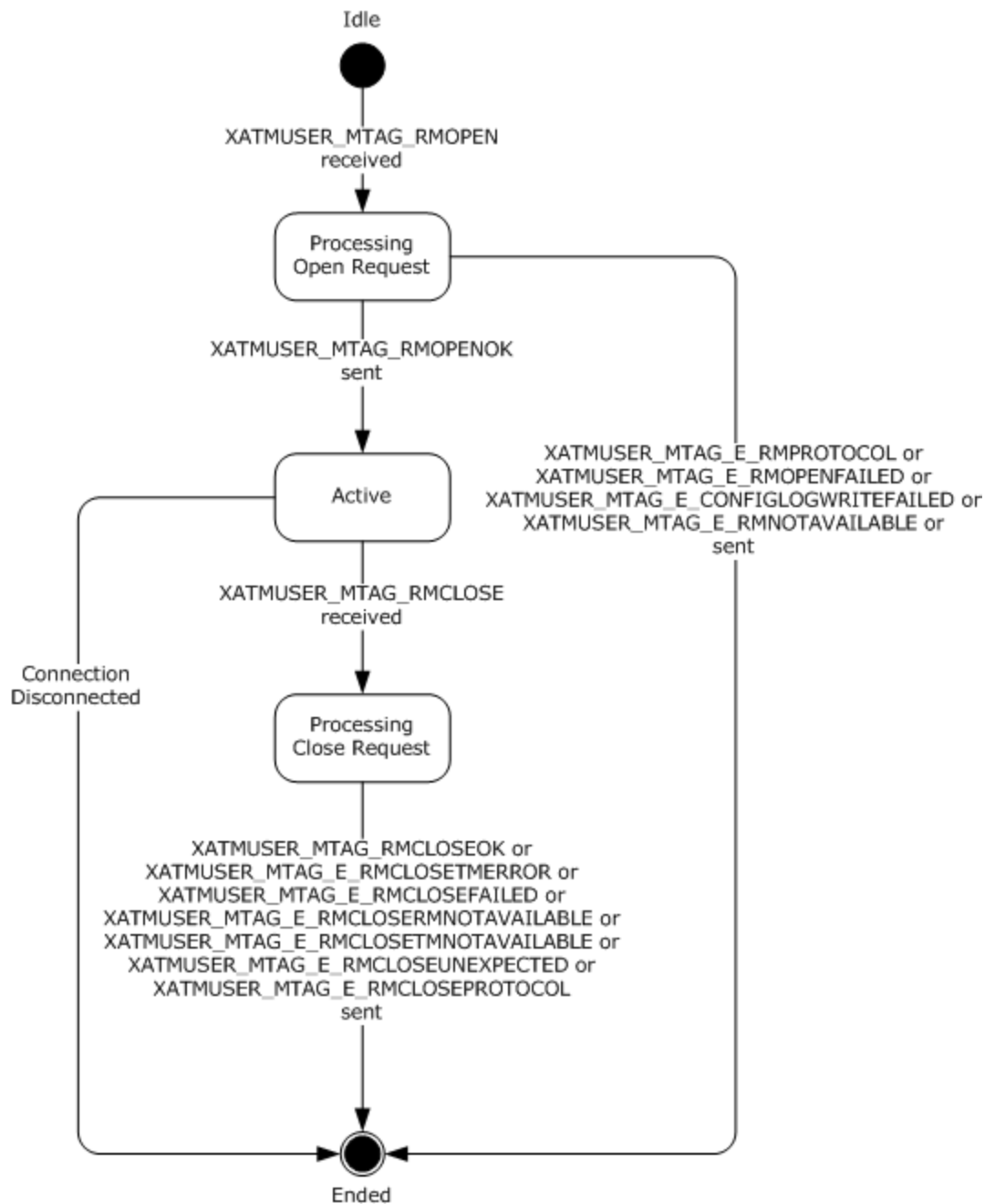

Figure 28: CONNTYPE_XATM_OPENONEPIPE acceptor states

3.4.1.3 CONNTYPE_XATM_ENLIST Acceptor States

The XA Resource Manager Bridge Facet MUST act as an acceptor for the CONNTYPE_XATM_ENLIST connection type. In this role, the XA Resource Manager Bridge Facet MUST provide support for the following states:

- [Idle](#)
- [Processing Enlist Request](#)

- [Ended](#)

3.4.1.3.1 Idle

This is the initial state. The following event is processed in this state:

- [Receiving an XATMUSER_MTAG_ENLIST Message](#)

3.4.1.3.2 Processing Enlist Request

This is a transient state that is assumed during the synchronous processing of the [XATMUSER_MTAG_ENLIST](#) request (section 2.2.3.4.9).

The following events are processed in this state:

- [Create Subordinate Enlistment Success \(section 3.4.7.5\)](#).
- [Create Subordinate Enlistment Failure \(section 3.4.7.4\)](#).

3.4.1.3.3 Ended

This is the final state.

3.4.1.3.4 State Diagram

The following figure shows the relationship between the CONNTYPE_XATM_ENLIST acceptor states.

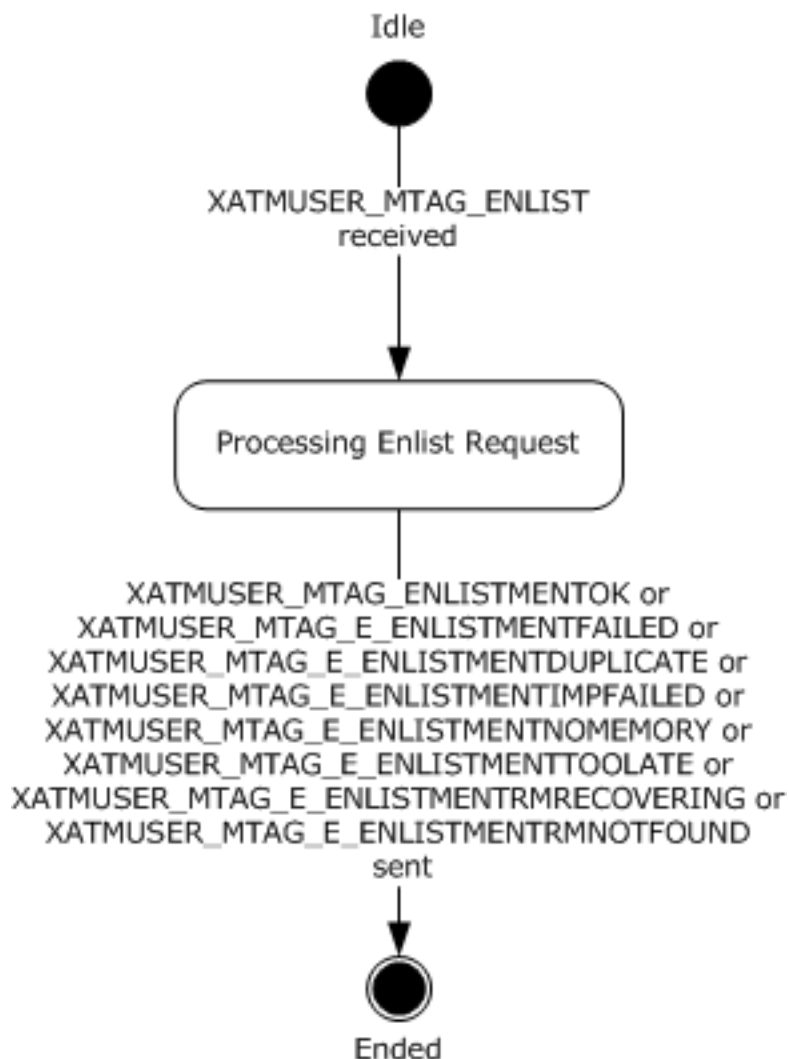

Figure 29: CONNTYPE_XATM_ENLIST acceptor states

3.4.2 Timers

The XA Resource Manager Bridge Facet MUST provide the timer specified in the next section.

3.4.2.1 Recovery Interval Timer

The default value of the timer is XATmMinWarmRecoveryInterval.

When the timer is initialized, the XA Resource Manager Bridge Facet MUST specify an **XA Resource Manager** object to associate with the timer. When the timer expires, the same XA Resource Manager object MUST be provided when triggering the Recovery Interval Timer event. The XA Resource Manager Bridge Facet MUST specify a distinct Recovery Interval Timer instance for each recovering XA Resource Manager object.

3.4.3 Initialization

When the XA Resource Manager Bridge Facet is initialized:

- The XA Resource Manager Bridge Facet MUST examine the Allow XA flag on the Core Transaction Manager Facet specified in [\[MS-DTCO\]](#) section 3.2.1 and, if it is not set, perform the following actions:
 - For all connection types listed in section [3.4](#), the XA Resource Manager Bridge Facet MUST refuse to accept incoming connections as specified in [\[MS-CMP\]](#) section 3.1.5.5 with the reject **Reason** set to 0x80070005.
- **XaTmMinWarmRecoveryInterval** SHOULD be set to a value that is obtained from an implementation-specific source.
- **XaTmMaxWarmRecoveryInterval** SHOULD be set to a value that is obtained from an implementation-specific source.
- XA Resource Manager Identifier Index MUST be set to an implementation-specific value.
- The **Transaction Manager Name** field SHOULD be set to a value that is obtained from an implementation-specific source. This value MUST remain consistent across multiple software restarts or transient failures.

3.4.3.1 XA Resource Manager Bridge Facet Initialization

The XA Resource Manager Bridge Facet MUST perform the following initialization steps when the **facet** is initialized:

- **XaTmMinWarmRecoveryInterval** SHOULD be set to an implementation-specific value.[<41>](#)
- **XaTmMaxWarmRecoveryInterval** SHOULD be set to an implementation-specific value.[<42>](#)

3.4.4 Higher-Layer Triggered Events

The operation of the XA Resource Manager Bridge Facet MUST be prepared to process the higher-layer events in this section.

3.4.4.1 Recovery Event

This event is triggered by the higher-layer software hosting infrastructure when it reinitializes the system after a software failure or restart.

When the XA Resource Manager Bridge Facet is asked to recover after a software failure or restart, it MUST perform the following actions:

- For each **XA Resource Manager** object in the XA Resource Manager Durable Log of the XA Resource Manager Bridge Facet:
 - Attempt to create a new XA Resource Manager object with the following values:
 - The Resource Manager Global Identifier field is set from XA Resource Manager Durable Log.
 - The XA Resource Manager Identifier field is generated by incrementing the XA Resource Manager Identifier Index field of the XA Resource Manager Bridge Facet.
 - The Data Source Name field is set from XA Resource Manager Durable Log.
 - The State field is set to Recovering.
 - The Recovery Interval field SHOULD be set to XaTmMinWarmRecoveryInterval.[<43>](#)

- The Single Pipe field is set to FALSE.
- The Call Count field is set to 0.
- The XA DLL Name is set from the XA Resource Manager Durable Log.
- If the object is created successfully:
 - Attempt to load XA Switch for XA Resource Manager object using the XA DLL Name of the XA Resource Manager object.
 - If successful:
 - Set the XA Switch field of the XA Resource Manager object to the loaded XA Switch.
 - Add the new XA Resource Manager object to the XA Resource Manager Table referenced by the XA Resource Manager Bridge Facet.
 - Otherwise:
 - Discard the newly created XA Resource Manager Object.
 - Continue for each loop.
- Otherwise:
 - Continue for each loop.
- For each XA Resource Manager object in the XA Resource Manager Table of the XA Resource Manager Bridge Facet:
 - Signal [Recover XA Resource Manager](#) event on XA Resource Manager Bridge Facet with the following argument:
 - The XA Resource Manager object.

3.4.5 Processing Events and Sequencing Rules

3.4.5.1 CONNTYPE_XATM_OPEN as Acceptor

For all messages received in this Connection Type, the XA Resource Manager Bridge Facet MUST process the message as specified in section [3.1](#). The XA Resource Manager Bridge Facet MUST also follow the processing rules specified in the following sections.

3.4.5.1.1 Receiving an XATMUSER_MTAG_RMOPEN Message

When the XA Resource Manager Bridge Facet receives an [XATMUSER_MTAG_RMOPEN](#) message (section 2.2.3.2.5), it MUST perform the following actions:

- If the State field of the receiving Connection is set to Idle:
 - Set the State field of the receiving Connection to [Processing Open Request \(section 3.4.1.1.2\)](#).
- Otherwise:
 - The message MUST be processed as an invalid message as specified in section [3.1.6](#) and processing of this message halted.
- Test if all of the following conditions are satisfied:

- SHOULD check if the **lenDSN** field of the message is less than an implementation-specific value.<44>
- SHOULD check if the **lenXaDII** field of the message is less than an implementation-specific value.<45>
- If all the conditions are met:
 - Attempt to find an **XA Resource Manager** object in the XA Resource Manager Table that meets the following conditions:
 - The Data Source Name field is set to the value of the **DSN** field of the message.
 - If an XA Resource Manager object is found:
 - If the State field of the found XA Resource Manager object is set to Recovering:
 - Set the XA Resource Manager object referenced by the receiving connection to the located XA Resource Manager object.
 - Increment the Call Count field of the XA Resource Manager object.
 - Add the receiving connection to the Pending Open Connections Table referenced by the located XA Resource Manager object.
 - Set the state of the receiving connection to Active.
 - Otherwise, if the State field of XA Resource Manager object is set to Active:
 - If the Call Count field of the XA Resource Manager object is greater than 0:
 - Increment the Call Count field of the XA Resource Manager object.
 - Set the State field of the Connection to Active.
 - Add the receiving connection to Request Connections Table referenced by the found XA Resource Manager object.
 - Set the XA Resource Manager object of the receiving Connection to the located XA Resource Manager object.
 - Send an [XATMUSER_MTAG_RMOPENOK](#) message (section 2.2.3.2.6) on the receiving connection with the following settings:
 - **localRmId** is set to the XA Resource Manager Identifier field of the located XA Resource Manager object.
 - **guidRm** is set to the Resource Manager Global Identifier field of the located XA Resource Manager object.
 - Otherwise:
 - Send an [XATMUSER_MTAG_RMNONEXISTENT](#) message (section 2.2.3.2.1) on the receiving connection.
 - Set the connection state to Ended.
 - Otherwise:
 - Send an [XATMUSER_MTAG_E_RMNOTAVAILABLE](#) message (section 2.2.3.2.2) on the receiving connection.

- Set the connection state to Ended.
- Otherwise:
 - Attempt to load XA Switch for XA Resource Manager using the **XaDllFileName** field of the message:
 - If successful:
 - Attempt to create a new XA Resource Manager object with the following values:
 - The Resource Manager Global Identifier field is set to newly created **GUID**.
 - The XA Resource Manager Identifier field is set to the value of the incremented XA Resource Manager Identifier Index.
 - The Data Source Name field is set to the **DSN** field of the message.
 - The State field is set to Idle.
 - The XA Switch set to loaded XA Switch.
 - The Recovery Interval field SHOULD be set to XaTmMinWarmRecoveryInterval.<46>
 - The Single Pipe field set to FALSE.
 - The Call Count field is set to 1.
 - The XA DLL Name field is set to the **XaDllFileName** field of the message.
 - If successful:
 - Set the XA Resource Manager of the receiving connection to the created XA Resource Manager object.
 - Call xa_open() on the XA Switch referenced by the new XA Resource Manager object with the following arguments:
 - Data Source Name of the created XA Resource Manager object.
 - XA Resource Manager Identifier of the created XA Resource Manager object.
 - TMNOFLAGS.
 - If the **outcome** is set to XA_OK:
 - Write the created XA Resource Manager object to the XA Resource Manager Durable Log.
 - Add the created XA Resource Manager object to the XA Resource Manager Table referenced by the XA Resource Manager Bridge Facet.
 - Set the State field of the XA Resource Manager object to Active.
 - Add receiving connection to Request Connections Table referenced by the XA Resource Manager object.
 - Set the State of Connection to Active.
 - Send an XATMUSER_MTAG_RMOPENOK message on the receiving connection with the following arguments:

- The XA Resource Manager Identifier field of the created XA Resource Manager.
 - The Resource Manager Global Identifier field of the created XA Resource Manager.
- Otherwise if outcome is set to XAER_PROTO:
 - Set the State field of the created XA Resource Manager object to Ended.
 - Send an [XATMUSER_MTAG_E_RMPROTOCOL](#) message (section 2.2.3.2.4) on the receiving connection.
 - Set the Connection State to Ended.
- Otherwise: [<47>](#)
 - Set the State field of the created XA Resource Manager object to Ended.
 - Send an [XATMUSER_MTAG_E_RMOPENFAILED](#) message (section 2.2.3.2.3) on the receiving connection.
 - Set Connection State to Ended.
- Otherwise:
 - Send an XATMUSER_MTAG_E_RMOPENFAILED message using the receiving connection.
 - Set Connection State to Ended.
- Otherwise:
 - Send an XATMUSER_MTAG_E_RMOPENFAILED message using the receiving connection.
 - Set Connection State to Ended.
- Otherwise:
 - XA Resource Manager Bridge Facet MAY: [<48>](#)
 - Send an XATMUSER_MTAG_E_RMOPENFAILED message (section 2.2.3.2.3) using the receiving connection.
 - Set the Connection State to Ended.

3.4.5.1.2 Connection Disconnected

When a CONNTYPE_ XATM_OPEN connection is disconnected, the XA Resource Manager Bridge Facet MUST perform the following actions:

- If the State of receiving Connection is set to Active and the State field of the **XA Resource Manager** object referenced by the **XA Resource Manager CMP Connection object** is set to Active:
 - Set the State of receiving Connection to Ended.
 - Decrement the Call Count field of the XA Resource Manager object referenced by the **XA Resource Manager CMP Connection object**.

- Remove the receiving connection from Request Connections Table referenced by XA Resource Manager object referenced by the **XA Resource Manager CMP Connection object**.
- If the Call Count field of the XA Resource Manager object referenced by the **XA Resource Manager CMP Connection object** is set to 0:
 - Call `xa_close()` on XA Switch of XA Resource Manager object with the following arguments:
 - The Data Source Name field of the XA Resource Manager object referenced by the **XA Resource Manager CMP Connection object**.
 - The XA Resource Manager Identifier of the XA Resource Manager object referenced by the **XA Resource Manager CMP Connection object**.
 - `TMNOFLAGS`.
 - Set the State field of the XA Resource Manager object referenced by the **XA Resource Manager CMP Connection object** to Ended.
 - If the XA Subordinate Enlistment Table referenced by the XA Resource Manager object referenced by the **XA Resource Manager CMP Connection object** is empty:
 - Remove the XA Resource Manager object referenced by the **XA Resource Manager CMP Connection object** from the XA Resource Manager Durable Log.
 - Remove the XA Resource Manager referenced by the **XA Resource Manager CMP Connection object** from the XA Resource Manager Table.

3.4.5.2 CONNTYPE_XATM_OPENONEPIPE as Acceptor

For all messages received in this Connection Type, the XA Resource Manager Bridge Facet MUST process the message as specified in section [3.1](#). The XA Resource Manager Bridge Facet MUST also follow the processing rules specified in the following sections.

3.4.5.2.1 Receiving an XATMUSER_MTAG_RMOPEN Message

When the XA Resource Manager Bridge Facet receives an [XATMUSER_MTAG_RMOPEN](#) message (section 2.2.3.2.5), it MUST perform the following actions:

- If the State field of receiving Connection is set to Idle:
 - Set the State field of the Connection to Processing Open Request.
- Otherwise:
 - The message MUST be processed as an invalid message as specified in section [3.1.6](#); the implementation SHOULD perform no further processing of the message.
- Test if all of the following conditions are satisfied:
 - SHOULD check if the **lenDSN** field of the message is less than an implementation-specific value. [<49>](#)
 - SHOULD check if the **lenXaDII** field of the message is less than an implementation-specific value. [<50>](#)
- If all the conditions are met:
 - Attempt to load XA Switch for **XA Resource Manager** using the **XaDIIFileName** field of the message.

- If successful:
 - Call `xa_open()` on the XA Switch of the XA Resource Manager object with the following arguments:
 - **DSN** field of the message.
 - Randomly generated integer.
 - `TMNOFLAGS`.
 - If the **outcome** of the call to `xa_open()` is set to `XA_OK`:
 - Call `xa_close()` on the XA Switch with the following arguments:
 - **DSN** field of the message.
 - Previously generated Resource Manager Identifier.
 - `TMNOFLAGS`.
 - If the outcome of the call to `xa_close()` is set to `XA_OK`:
 - Attempt to create a new XA Resource Manager object with the following values:
 - The Resource Manager Global Identifier field is set to newly created **GUID**.
 - The XA Resource Manager Identifier is set to the randomly generated Resource Manager Identifier.
 - The Data Source Name field is set to the **DSN** field of the message.
 - The State field is set to Idle.
 - The XA Switch is set to loaded XA Switch.
 - The Recovery Interval field SHOULD be set to `XaTmMinWarmRecoveryInterval`.[<51>](#)
 - The Single Pipe field is set to `TRUE`.
 - The Call Count field is set to 1.
 - The XA DLL Name field is set to the **XaDllFileName** field of the message.
 - If successful:
 - Set the XA Resource Manager of the receiving connection to the new XA Resource Manager.
 - Attempt to write the new XA Resource Manager to the XA Resource Manager Durable Log.
 - If successful:
 - Set the State of Connection to Active.
 - Send an [XATMUSER_MTAG_RMOPENOK](#) message (section 2.2.3.2.6) on the receiving connection with the following settings:
 - **localRmId** set to the XA Resource Manager Identifier of the created XA Resource Manager.

- **guidRm** set to the Resource Manager Global Identifier of the created XA Resource Manager.
 - Otherwise:
 - Send an [XATMUSER_MTAG_E_CONFIGLOGWRITEFAILED](#) message on the receiving connection.
 - Set the State of the receiving connection to Ended.
 - Otherwise:
 - Send an [XATMUSER_MTAG_E_RMOPENFAILED](#) message (section 2.2.3.2.3) on the receiving connection.
 - Set the State of the receiving connection to Ended.
 - Otherwise:
 - Send an XATMUSER_MTAG_E_RMOPENFAILED message on the receiving connection.
 - Set the State of the receiving connection to Ended.
 - Otherwise:
 - Send an XATMUSER_MTAG_E_RMOPENFAILED message on the receiving connection.
 - Set the State of the receiving connection to Ended.
 - Otherwise:
 - Send an XATMUSER_MTAG_E_RMOPENFAILED message on the receiving connection.
 - Set the State of the receiving connection to Ended.
- Otherwise, the message MUST be processed as an invalid message, as specified in section 3.1.6.

3.4.5.2.2 Receiving an XATMUSER_MTAG_RMCLOSE Message

When the XA Resource Manager Bridge Facet receives a [XATMUSER_MTAG_RMCLOSE](#) message (section 2.2.3.3.7), it MUST perform the following actions:

- If the State field of receiving Connection is set to Active:
 - Set the State field of the receiving Connection to Processing Close Request:
 - Attempt to delete the **XA Resource Manager** object referenced by the XA Resource Manager CMP Connection from the XA Resource Manager Durable Log.
 - If the delete is successful:
 - Send an [XATMUSER_MTAG_RMCLOSEOK](#) message (section 2.2.3.3.8) using the receiving connection.
 - Otherwise:
 - Send [XATMUSER_MTAG_E_RMCLOSEFAILED](#) (section 2.2.3.3.2) to all connections in Request Connections Table of XA Resource Manager.
- Set State of receiving connection to Ended.

3.4.5.2.3 Connection Disconnected

When a [CONNTYPE_XATM_OPENONEPIPE](#) connection (section 2.2.3.3) is disconnected, the XA Resource Manager Bridge Facet MUST perform the following actions:

- If State field of the receiving Connection is set to Active:
 - Trigger the [Recover XA Resource Manager](#) event on XA Resource Manager Bridge Facet with the following argument:
 - The **XA Resource Manager object** referenced by the **XA Resource Manager CMP Connection object**.

3.4.5.3 CONNTYPE_XATM_ENLIST as Acceptor

For all messages received in this Connection Type, the XA Resource Manager Bridge Facet MUST process the message as specified in section [3.1](#). The XA Resource Manager Bridge Facet MUST also follow the processing rules specified in the following sections.

3.4.5.3.1 Receiving an XATMUSER_MTAG_ENLIST Message

When the XA Resource Manager Bridge Facet receives a [XATMUSER_MTAG_ENLIST](#) message (section 2.2.3.4.9), it MUST perform the following actions:

- If the State field of the receiving Connection is set to Idle:
 - Set the State of the receiving Connection to Processing Enlist Request.
 - Attempt to find an **XA Resource Manager** object in the XA Resource Manager Table that meets the following condition:
 - The resource manager Global Identifier field is set to **guidRM** field of the message.
 - If the condition is met:
 - If the State field of the XA Resource Manager object is set to Active:
 - Attempt to find an XA Subordinate Enlistment object in the XA Subordinate Enlistment Table referenced by the found XA Resource Manager object that meets the following condition:
 - The XA Global Transaction Identifier portion of the Data field of the XA_XID structure contained in the **XID** field of the XA Subordinate Enlistment object is set to the XA Global Transaction Identifier portion of the Data field of the XA_XID structure contained in the Xid field of the message.
 - If an object is found:
 - Send an [XATMUSER_MTAG_E_ENLISTMENTDUPLICATE](#) message (section 2.2.3.4.1) on the receiving Connection.
 - Set the State field of the receiving Connection to Ended.
 - Otherwise:
 - Attempt to create an XA Subordinate Enlistment object with the following values:
 - The State field is set to Idle.
 - The Transaction Manager Facet field is set to the XA Resource Manager Bridge Facet.

- The resource manager Identifier field is set to **guidRM** field of the message.
- The XID field is set to the Xid field of the message.
- The Current Request Connection field is set to the receiving Connection.
- If successful:
 - Add the newly created XA Subordinate Enlistment object to the XA Subordinate Enlistment Table referenced by the found XA Resource Manager object.
 - Acting as an Application Role as specified in [\[MS-DTCO\]](#) section 3.3 and signaling the event specified in [\[MS-DTCO\]](#) section 3.3.4.6, attempt to import a **transaction** using the following value:
 - The ImportCookie of the received message.
 - If successful:
 - Set the XA Subordinate Enlistment object referenced by the receiving connection to the created XA Subordinate Enlistment object.
 - Set the Transaction referenced by the created XA Subordinate Enlistment object to the Imported Transaction.
 - Signal the [Create Subordinate Enlistment Success](#) event (section 3.4.7.5) on the Core Transaction Manager Facet with the following argument.
 - The created XA Subordinate Enlistment object.
 - Otherwise:
 - Remove the created XA Subordinate Enlistment object from the XA Subordinate Enlistment Table referenced by the found XA Resource Manager object.
 - Send an [XATMUSER_MTAG_E_ENLISTMENTIMPFAILED](#) using the receiving connection.
 - Set the State of receiving connection to Ended.
- Otherwise:
 - Send an [XATMUSER_MTAG_E_ENLISTMENTNOMEMORY](#) message using the receiving connection.
 - Set the State of receiving connection to Ended.
- Otherwise, if the State field of the XA Resource Manager object is set to Ended:
 - Send an [XATMUSER_MTAG_E_ENLISTMENTTOOLATE](#) message using the receiving connection.
 - Set the State of receiving connection to Ended.
- Otherwise:
 - Send an [XATMUSER_MTAG_E_ENLISTMENTRMRECOVERING](#) message using the receiving connection.
 - Set the State of the receiving Connection to Ended.

- Otherwise:
 - Send an [XATMUSER_MTAG_E_ENLISTMENTRMNOTFOUND](#) message using the receiving connection.
 - Set the State of receiving Connection to Ended.
- Otherwise, the message MUST be processed as an invalid message as specified in section [3.1.6](#).

3.4.6 Timer Events

3.4.6.1 Recovery Interval Timer

When this timer expires, the XA Resource Manager Bridge Facet MUST perform the following actions:

- Signal the [Recover XA Resource Manager](#) event on the XA Resource Manager Bridge Facet with the following argument:
 - The provided **XA Resource Manager** object.

3.4.7 Other Local Events

3.4.7.1 Begin Commit

The Begin Commit event MUST be signaled with the following arguments:

- An XA Subordinate Enlistment object.

If the Begin Commit event is signaled, the XA Resource Manager Bridge Facet MUST perform the following actions:

- If the State field of the provided XA Subordinate Enlistment object is set to Prepared:
 - Call `xa_commit()` on the XA Switch of the **XA Resource Manager** object referenced by the provided XA Subordinate Enlistment object with the following arguments:
 - The **XID** field of the provided XA Subordinate Enlistment object.
 - The XA Resource Manager Identifier field of the XA Resource Manager object referenced by the provided XA Subordinate Enlistment object.
 - TMNOFLAGS.
 - If the Output is either XAER_RMFAIL, XA_RETRY, XAER_RMERR, XAER_NOTA, XAER_INVALID, or XAER_PROTO:
 - Set the State field of the provided XA Subordinate Enlistment object to Ended.
 - Remove the provided XA Subordinate Enlistment object from XA Subordinate Enlistment Table referenced by XA Resource Manager object referenced by the provided XA Subordinate Enlistment object.
 - Signal the [Recover XA Resource Manager](#) event on the XA Resource Manager Bridge Facet with the following argument.
 - The XA Resource Manager object referenced by the XA Subordinate Enlistment object provided.
- Otherwise:

- Set the State field of the XA Subordinate Enlistment object to Ended.
- Remove the provided XA Subordinate Enlistment object from the XA Subordinate Enlistment Table referenced by XA Resource Manager object referenced by provided XA Subordinate Enlistment object.
- Signal the Enlistment Commit Complete event on the Core Transaction Manager Facet with the following arguments:
 - The provided XA Subordinate Enlistment object.
- If the XA Subordinate Enlistment Table of XA Resource Manager referenced by the provided XA Subordinate Enlistment object is empty and the State field of the XA Resource Manager object is set to Ended:
 - Remove the XA Resource Manager object referenced by the provided XA Subordinate Enlistment object from the XA Resource Manager Durable Log.
 - Remove the XA Resource Manager referenced by the provided XA Subordinate Enlistment object from the XA Resource Manager Table.

3.4.7.2 Begin Phase One

The Begin Phase One event MUST be signaled with the following arguments:

- An XA Subordinate Enlistment object.
- Single Phase flag.

If the Begin Phase One event is signaled, the XA Resource Manager Bridge Facet MUST perform the following actions:

- If the State field of the provided XA Subordinate Enlistment object is set to Enlisted:
 - If the provided Single Phase flag is set to FALSE:
 - Call xa_prepare() on the XA Switch of the **XA Resource Manager** object referenced by the provided XA Subordinate Enlistment object with the following arguments:
 - The **XID** field of the provided XA Subordinate Enlistment object.
 - The XA Resource Manager Identifier field of the XA Resource Manager object referenced by the provided XA Subordinate Enlistment object.
 - TMNOFLAGS.
 - If the Output is set to XA_OK:
 - Set the State field of the XA Subordinate Enlistment object to Prepared.
 - Signal the Enlistment Phase One Complete event on the Core Transaction Manager Facet with the following arguments:
 - The provided XA Subordinate Enlistment object.
 - The **Outcome** set to Prepared.
 - If the Output is set to XA_RDONLY:
 - Signal the Enlistment Phase One event on Core Transaction Manager Facet with the following arguments:

- The provided XA Subordinate Enlistment object.
 - The Outcome set to Read Only.
- Set the State field of the XA Subordinate Enlistment object to Ended.
- Remove the provided XA Subordinate Enlistment object from the XA Subordinate Enlistment Table referenced by the XA Resource Manager object referenced by the provided XA Subordinate Enlistment object.
- If the Output is set to XAER_RMFAIL or XAER_RMERR:
 - Signal the Enlistment Phase One Complete event on the Core Transaction Manager Facet with the following arguments:
 - The provided XA Subordinate Enlistment object.
 - The Outcome set to Aborted.
 - Set the State of the provided XA Subordinate Enlistment object to Ended.
 - Remove the provided XA Subordinate Enlistment object from the XA Subordinate Enlistment Table referenced by the XA Resource Manager object referenced by the provided XA Subordinate Enlistment object.
 - Signal the [Recover XA Resource Manager](#) event on the XA Resource Manager Bridge Facet with the following argument:
 - The XA Resource Manager object referenced by the provided XA Subordinate Enlistment object.
- Otherwise:
 - Signal the Enlistment Phase One Complete event on the Core Transaction Manager Facet with the following arguments:
 - The provided XA Subordinate Enlistment object.
 - The Outcome set to Aborted.
 - Set the State field of the provided XA Subordinate Enlistment object to Ended.
 - Remove the provided XA Subordinate Enlistment object from the XA Subordinate Enlistment Table referenced by XA Resource Manager object referenced by the provided XA Subordinate Enlistment.
- Otherwise:
 - Call xa_commit() on the XA Switch of the XA Resource Manager object referenced by the provided XA Subordinate Enlistment object with the following arguments:
 - The XID field of the provided XA Subordinate Enlistment object.
 - The XA Resource Manager Identifier field of the XA Resource Manager object referenced by the provided XA Subordinate Enlistment object.
 - TMONEPHASE.
 - If the Output is set to XA_OK:
 - Signal the Enlistment Phase One Complete event on the Core Transaction Manager Facet with the following arguments:

- The provided XA Subordinate Enlistment object.
- The Outcome set to Committed.
- Set the State field of the XA Subordinate Enlistment object to Ended.
- Remove the provided XA Subordinate Enlistment object from the XA Subordinate Enlistment Table referenced by XA Resource Manager object referenced by provided XA Subordinate Enlistment object.
- If the Output is set to XAER_RMFAIL:
 - Signal Enlistment Phase One Complete event on the Core Transaction Manager Facet with the following arguments:
 - The provided XA Subordinate Enlistment object.
 - The Outcome set to Aborted.
 - Set the State field of the XA Subordinate Enlistment object to Ended.
 - Remove the provided XA Subordinate Enlistment object from the XA Subordinate Enlistment Table referenced by XA Resource Manager object referenced by provided XA Subordinate Enlistment.
 - Signal the Recover XA Resource Manager event on XA Resource Manager Bridge Facet with the following argument:
 - The XA Resource Manager object referenced by the provided XA Subordinate Enlistment object.
- Otherwise:
 - Signal Enlistment Phase One Complete event on the Core Transaction Manager Facet with the following arguments:
 - The provided XA Subordinate Enlistment object.
 - The Outcome set to Aborted.
 - Set the State field of the provided XA Subordinate Enlistment object to Ended.
 - Remove the provided XA Subordinate Enlistment object from the XA Subordinate Enlistment Table referenced by the XA Resource Manager referenced by the provided XA Subordinate Enlistment object.
- If the XA Subordinate Enlistment Table of the XA Resource Manager object referenced by the provided XA Subordinate Enlistment object is empty and the State field of XA Resource Manager referenced by the provided XA Subordinate Enlistment object is set to Ended:
 - Remove the XA Resource Manager referenced by the provided XA Subordinate Enlistment object from the XA Resource Manager Durable Log.
 - Remove the XA Resource Manager referenced by the provided XA Subordinate Enlistment object from the XA Resource Manager Table.

3.4.7.3 Begin Rollback

The Begin Rollback event MUST be signaled with the following arguments:

- An XA Subordinate Enlistment object.

If the Begin Rollback event is signaled, the XA Resource Manager Bridge Facet MUST perform the following actions:

- If the State field of the provided XA Subordinate Enlistment object is set to Enlisted or Prepared:
 - Call `xa_rollback()` on the XA Switch of the **XA Resource Manager** object referenced by the provided XA Subordinate Enlistment object with the following arguments:
 - The **XID** field of the provided XA Subordinate Enlistment object.
 - The XA Resource Manager Identifier field of the XA Resource Manager object referenced by the provided XA Subordinate Enlistment object.
 - `TMNOFLAGS`.
 - If the Output is set to either `XAER_RMFAIL`, `XA_RETRY`, `XAER_RMERR`, `XAER_NOTA`, `XAER_INVALID`, or `XAER_PROTO`:
 - Set the State field of the XA Subordinate Enlistment object to Ended.
 - Remove the provided XA Subordinate Enlistment object from the XA Subordinate Enlistment Table referenced by the XA Resource Manager object referenced by provided XA Subordinate Enlistment object.
 - Signal the [Recover XA Resource Manager](#) event on XA Resource Manager Bridge Facet with the following argument:
 - The XA Resource Manager object referenced by the provided XA Subordinate Enlistment object.
- Otherwise:
 - Set the State field of the XA Subordinate Enlistment object to Ended.
 - Remove the provided XA Subordinate Enlistment object from the XA Subordinate Enlistment Table referenced by the XA Resource Manager referenced by the provided XA Subordinate Enlistment.
 - Signal the Enlistment Rollback Complete event on the Core Transaction Manager Facet with the following argument:
 - The Provided XA Subordinate Enlistment object.
- If the XA Subordinate Enlistment Table referenced by the XA Resource Manager referenced by the provided XA Subordinate Enlistment object is empty and State of XA Resource Manager referenced by the provided XA Subordinate Enlistment object is set to Ended:
 - Remove the XA Resource Manager referenced by the provided XA Subordinate Enlistment object from the XA Resource Manager Durable Log.
 - Remove the XA Resource Manager referenced by the provided XA Subordinate Enlistment object from the XA Resource Manager Table.

3.4.7.4 Create Subordinate Enlistment Failure

The Create Subordinate Enlistment Failure event MUST be signaled with the following arguments:

- An XA Subordinate Enlistment object.

If the Create Subordinate Enlistment Failure event is signaled, the XA Resource Manager Bridge Facet MUST perform the following actions:

- Remove the provided XA Subordinate Enlistment object from the XA Subordinate Enlistment Table referenced by the **XA Resource Manager** referenced by the provided XA Subordinate Enlistment object.
- Set the State field of the provided XA Subordinate Enlistment object to Ended.
- Send an [XATMUSER_MTAG_E_ENLISTMENTFAILED](#) message using the Current Request Connection field of the provided XA Subordinate Enlistment object.
- Set the State of the Current Request Connection field of the provided XA Subordinate Enlistment object to Ended.

3.4.7.5 Create Subordinate Enlistment Success

The Create Subordinate Enlistment Success event MUST be signaled with the following arguments:

- An XA Subordinate Enlistment object.

If the Create Subordinate Enlistment Success event is signaled, the XA Resource Manager Bridge Facet MUST perform the following actions:

- Set the State field of the provided XA Subordinate Enlistment object to Enlisted.
- Send an [XATMUSER_MTAG_ENLISTMENTOK](#) message using the Current Request Connection field of the provided XA Subordinate Enlistment object.
- Set the State of the Current Request Connection field of the provided XA Subordinate Enlistment object to Ended.

3.4.7.6 Recover XA Resource Manager

The Recover XA Resource Manager event MUST be signaled with the following arguments:

- An **XA Resource Manager** object.

If the Recover XA Resource Manager event is signaled, the XA Resource Manager Bridge Facet MUST perform the following actions:

- Set the State field of the provided XA Resource Manager object to Recovering.
- Create a local Recovery Flags variable that is set to TMSTARTRSCAN.
- For each XA Subordinate Enlistment object in the XA Subordinate Enlistment Table referenced by the provided XA Resource Manager object:
 - Set the State field of the XA Subordinate Enlistment object to Ended.
 - Remove the XA Subordinate Enlistment object from the XA Subordinate Enlistment Table referenced by the provided XA Resource Manager object.
- Call `xa_open()` on the XA Switch referenced by the XA Resource Manager object with the following arguments:
 - The Data Source Name field of the provided XA Resource Manager object.
 - The XA Resource Manager Identifier field of the provided XA Resource Manager object.
 - TMNOFLAGS.
- If the result is set to XA_OK:

- Repeat the following steps until the return value from `xa_recover()` is less than 10 or the result of the call is `XAER_RMERR`, `XAER_RMFAIL`, `XAER_INVALID`, or `XAER_PROTO`. If the value returned is less than 10, follow the steps, but do not repeat them.
 - Call `xa_recover()` on the XA Switch of the provided XA Resource Manager with the following arguments:
 - `XA_UOW xidbuffer[10]`.
 - 10.
 - XA Resource Manager Identifier field of the XA Resource Manager object.
 - Recovery Flags.
 - If the Outcome is not set to `XAER_RMERR`, `XAER_RMFAIL`, `XAER_INVALID`, or `XAER_PROTO`:
 - Set Recovery Flags to `TMNOFLAGS`.
 - Repeat the following steps for each of the **XIDs** passed back in `xidbuffer`:
 - Test if the following set of conditions is met:
 - XID from `xidbuffer` has [XA_BQUAL_1](#) with `XATMGUID` set to XA Transaction Manager GUID.
 - XID from `xidbuffer` has `XA_BQUAL_1` with `RMguid` set to Resource Manager Global Identifier of the XA Resource Manager object.
 - If the conditions are satisfied:
 - Attempt to find a **transaction** in the Transaction Table referenced by the Core Transaction Manager Facet which has **Transaction Identifier** equal to the **XA Global Transaction Identifier** contained within the **Data** field of the [XA_XID](#) structure (section 2.2.1.3) contained within the **XAIdentifier** field of the [XA_UOW](#) structure (section 2.2.1.4) contained within the `xidbuffer`.
 - If found:
 - If the State of the found Transaction is set to Committed:
 - Call `xa_commit()` on the XA Switch of the provided XA Resource Manager object with the following arguments:
 - The XID from `xidbuffer`.
 - The XA Resource Manager Identifier field of the provided XA Resource Manager object.
 - `TMNOFLAGS`.
 - If the **Outcome** is set to `XA_RETRY`:
 - Initialize a [Recovery Interval Timer \(section 3.4.2.1\)](#) with a time out of the Recovery Interval field of the provided XA Resource Manager object and the following argument: The provided XA Resource Manager object.
 - The Recovery Interval field of the provided XA Resource Manager object SHOULD be set to double its previous value, with a ceiling of **XaTmMaxWarmRecoveryInterval**.[<52>](#)

- Otherwise, if the Outcome is set to either XA_HEURCOM or XA_OK:
 - Continue to next XID to be recovered.
- Otherwise:
 - Set the State field of the XA Resource Manager object to Ended.
 - Remove the provided XA Resource Manager object from the XA Resource Manager Durable Log.
 - Remove the provided XA Resource Manager object from the XA Resource Manager Table.
 - If Pending Open Connections Table referenced by the XA Resource Manager object is not empty, the following actions MUST be performed on each XA Resource Manager CMP Connection in the Pending Open Connections Table referenced by the XA Resource Manager Object: (1) Remove the XA Resource Manager CMP Connection from the Pending Open Connections Table referenced by the XA Resource Manager object. (2) If the Outcome of the xa_commit() call was XAER_PROTO, send an XATMUSER_MTAG_E_RMPROTOCOL message on the XA Resource Manager CMP Connection; otherwise, send an XATMUSER_MTAG_E_RMOPENFAILED message on the XA Resource Manager CMP Connection. (3) Set the State field of the XA Resource Manager CMP Connection to Ended.
 - Terminate the processing for this event.
- Otherwise:
 - Continue to the next XID to be recovered.
- Otherwise:
 - Call xa_rollback() on the XA Switch of the provided XA Resource Manager object with the following arguments:
 - The XID from xidbuffer.
 - The XA Resource Manager Identifier field of the provided XA Resource Manager object.
 - TMNOFLAGS.
 - If the Outcome is set to either XA_HEURRB, XA_OK, or XA_RB*:
 - Continue to next XID to be recovered.
 - Otherwise:
 - Set the State field of the XA Resource Manager object to Ended.
 - Remove the provided XA Resource Manager object from the XA Resource Manager Durable Log.
 - Remove the provided XA Resource Manager object from the XA Resource Manager Table.

- The localRmId field is set to the XA Resource Manager Identifier field of the XA Resource Manager object.
 - The guidRM field is set to the Resource Manager Global Identifier field of the XA Resource Manager object.
- Otherwise if Outcome is XAER_RMERR:
 - Initialize a Recovery Interval Timer with a time out of the Recovery Interval field of the provided XA Resource Manager object and the following argument:
 - The provided XA Resource Manager object.
 - Recovery Interval field of the provided XA Resource Manager SHOULD be set to double its previous value, with a ceiling of **XaTmMaxWarmRecoveryInterval**.[<53>](#)
- Otherwise:
 - Remove the provided XA Resource Manager object from the XA Resource Manager Durable Log.
 - Remove the provided XA Resource Manager object from the XA Resource Manager Table.
 - If Pending Open Connections Table referenced by the XA Resource Manager object is not empty:
 - The following actions MUST be performed on each XA Resource Manager CMP Connection in the Pending Open Connections Table referenced by the XA Resource Manager Object:
 - Remove the XA Resource Manager CMP Connection from the Pending Open Connections Table referenced by the XA Resource Manager object.
 - If the Outcome of the xa_open() call was XAER_PROTO:
 - Send an XATMUSER_MTAG_E_RMPROTOCOL message on the XA Resource Manager CMP Connection.
 - Otherwise:
 - Send an XATMUSER_MTAG_E_RMOPENFAILED message on the XA Resource Manager CMP Connection.
 - Set the State field of the XA Resource Manager CMP Connection to Ended.

3.5 XA Resource Manager Bridge Details

3.5.1 Abstract Data Model

This section describes a conceptual model of possible data organization that an implementation maintains to participate in this protocol. The described organization is provided to facilitate the explanation of how the protocol behaves. This document does not mandate the implementations adhere to this model as long as their external behavior is consistent with the behavior that is described in this document.

Note that the abstract data model can be implemented in a variety of ways. This protocol does not prescribe or advocate any specific implementation technique.

The XA Resource Manager Bridge MUST maintain all the data elements that are specified in section [3.1.1](#).

The XA Resource Manager Bridge MUST also maintain the following data elements:

- **One-Pipe XA Resource Manager Proxy Table:** A table of the currently active XA Resource Manager Proxy objects keyed by the **Resource Manager Cookie** that is passed in from the higher layer.
- **Two-Pipe XA Resource Manager Proxy Table:** A table of the currently active XA Resource Manager Proxy objects keyed by the **Resource Manager Cookie** that is passed in from the higher layer.
- **XA Resource Manager Proxy object:** Represents a currently active **XA Resource Manager**:
 - **Resource Manager Global Identifier:** Specifies a unique identifier associated with an XA Resource Manager.
 - **Request Connection:** Specifies the XA Resource Manager Proxy Connection to the XA Resource Manager Bridge Facet.
 - **DLL Name:** Specifies the DLL name of an XA Resource Manager.
 - **Data Store Name:** Implementation-specific ASCII string to be passed to xa_open and xa_close calls on the XA Switch.
 - **Pipe:** Identifies whether the XA Resource Manager Proxy is using the **one pipe** or **Two Pipe** protocol:
 - **One:** Uses the One-Pipe protocol.
 - **Two:** Uses the Two-Pipe protocol.
 - **Resource Manager:** Corresponds to the **resource manager** described in [\[MS-DTCO\]](#) section 3.5. This field is used only when the value of the Pipe field is set to One.
- **XA Resource Manager Bridge Facet Name:** A Name object that identifies the XA Bridge Facet that is associated with the XA Bridge.
- **Transaction Manager Name:** A Name object that identifies the **transaction manager**.
- **XA Resource Manager Bridge CMP Connection object:** CMP Connection associated with CONNTYPE_XATM_OPEN and CONNTYPE_XATM_OPENONEPIPE initiators. The definition of an [\[MS-CMP\]](#) connection object is extended to include the following elements:
 - Reference to a XA Resource Manager Proxy object.
 - **State:** A state enumeration that represents the current state of the connection.

3.5.1.1 CONNTYPE_XATM_OPEN Initiator States

The XA Resource Manager Bridge MUST act as an initiator for the CONNTYPE_XATM_OPEN connection type. In this role, the XA Resource Manager Bridge MUST provide support for the following states:

- [Idle](#)
- [Awaiting Open Response](#)
- [Active](#)
- [Ended](#)

3.5.1.1.1 Idle

This is the initial state. The following event is processed in this state:

- [Register Two-Pipe XA Resource Manager](#) (section 3.5.4.1)

3.5.1.1.2 Awaiting Open Response

The following events are processed in this state:

- [Receiving an XATMUSER_MTAG_RMOPENOK Message](#) (section 3.5.5.1.1)
- [Receiving Other XATMUSER_MTAG_RMOPEN Messages](#) (section 3.5.5.1.2)
- [Connection Disconnected](#) (section 3.5.5.1.3)

3.5.1.1.3 Active

The following events are processed in this state:

- [Connection Disconnected](#) (section 3.5.5.1.3)

3.5.1.1.4 Ended

This is the final state.

3.5.1.1.5 State Diagram

The following figure shows the relationship between the CONNTYPE_XATM_OPEN initiator states.

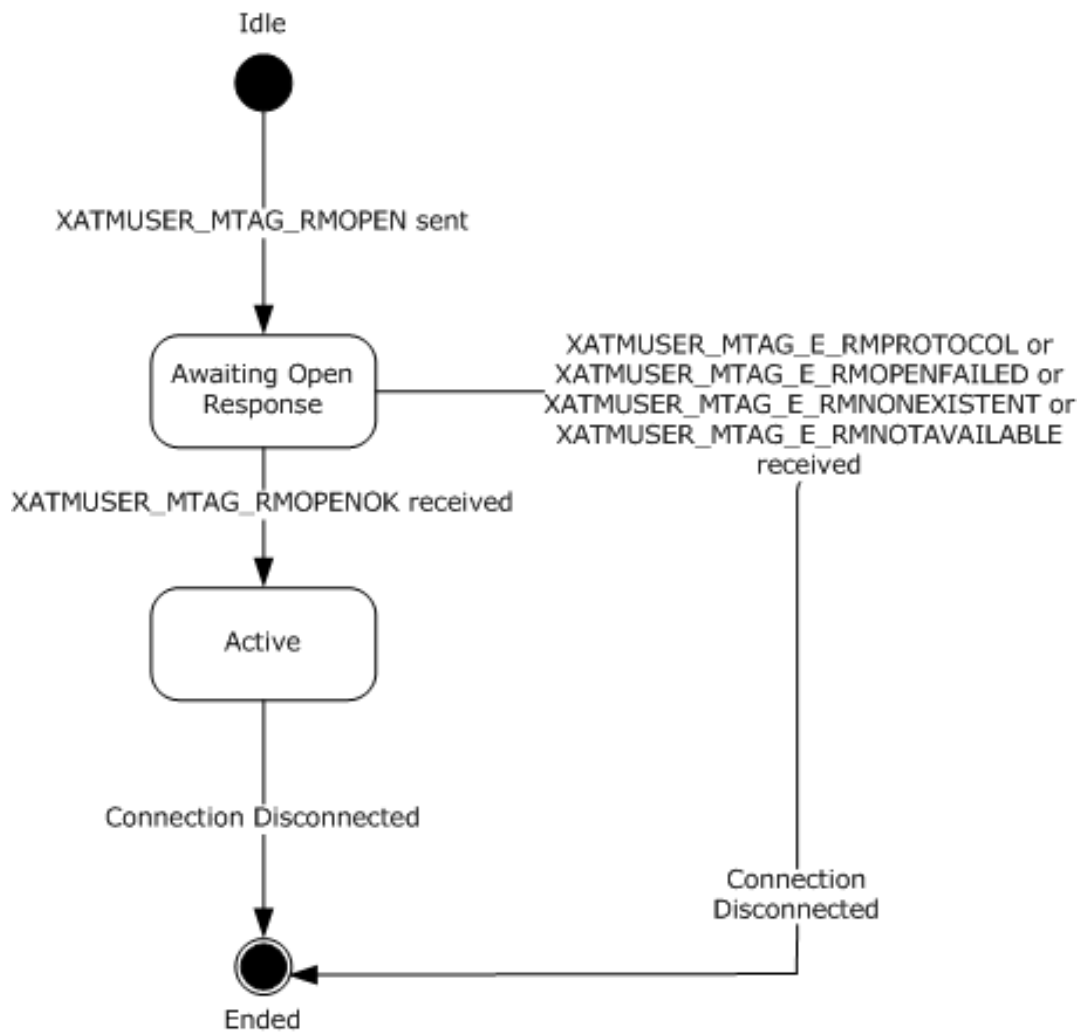

Figure 30: CONNTYPE_XATM_OPEN initiator states

3.5.1.2 CONNTYPE_XATM_OPENONEPIPE Initiator States

The XA Resource Manager Bridge MUST act as an initiator for the CONNTYPE_XATM_OPENONEPIPE connection type. In this role, the XA Resource Manager Bridge MUST provide support for the following states.

- [Idle](#)
- [Awaiting Open Response](#)
- [Active](#)
- [Awaiting Close Response](#)
- [Ended](#)

The following figure shows the relationship between the CONNTYPE_XATM_OPENONEPIPE initiator states.

3.5.1.2.1 Idle

This is the initial state. The following event is processed in this state:

- [Register One-Pipe XA Resource Manager](#) (section 3.5.4.4)

3.5.1.2.2 Awaiting Open Response

The following events are processed in this state:

- [Receiving an XATMUSER_MTAG_RMOPENOK Message](#) (section 3.5.5.2.1)
- [Receiving Other XATMUSER_MTAG_RMOPEN Messages](#) (section 3.5.5.2.2)
- [Connection Disconnected](#) (section 3.5.5.2.5)

3.5.1.2.3 Active

The following events are processed in this state:

- [Unregister One-Pipe XA Resource Manager](#) (section 3.5.4.5)
- [Connection Disconnected](#) (section 3.5.5.2.5)

3.5.1.2.4 Awaiting Close Response

The following events are processed in this state:

- [Receiving an XATMUSER_MTAG_RMCLOSEOK Message](#) (section 3.5.5.2.3)
- [Receiving Other XATMUSER_MTAG_RMCLOSE Messages](#) (section 3.5.5.2.4)
- [Connection Disconnected](#) (section 3.5.5.2.5)

3.5.1.2.5 Ended

This is the final state.

3.5.1.2.6 State Diagram

The following figure shows the relationship between the CONNTYPE_XATM_OPENONEPIPE initiator states.

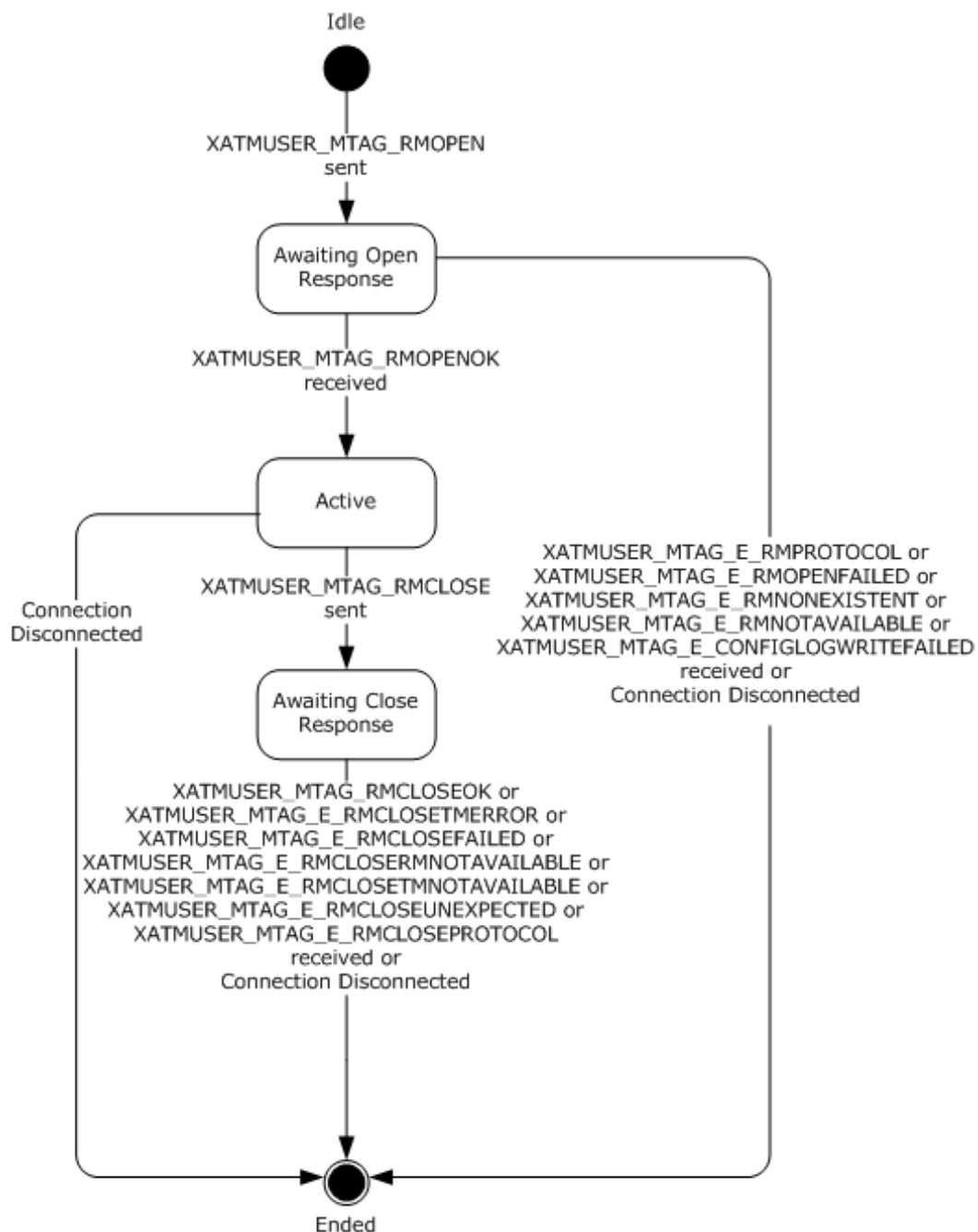

Figure 31: CONNTYPE_XATM_OPENONEPIPE initiator states

3.5.1.3 CONNTYPE_XATM_ENLIST Initiator States

The XA Resource Manager Bridge MUST act as an initiator for the CONNTYPE_XATM_ENLIST connection type. In this role, the XA Resource Manager Bridge MUST provide support for the following states:

- [Idle](#)
- [Awaiting Enlist Response](#)

- [Ended](#)

3.5.1.3.1 Idle

This is the initial state. The following event is processed in this state:

- [Enlist Two-Pipe XA Resource Manager \(section 3.5.4.3\)](#)

3.5.1.3.2 Awaiting Enlist Response

The following events are processed in this state:

- [Receiving Other XATMUSER_MTAG_RMENLIST Messages \(section 3.5.5.3.2\)](#)
- [Receiving an XATMUSER_MTAG_ENLISTMENTOK or an XATMUSER_MTAG_E_ENLISTMENTDUPLICATE Message \(section 3.5.5.3.1\)](#)
- [Connection Disconnected \(section 3.5.5.3.3\)](#)

3.5.1.3.3 Ended

This is the final state.

3.5.1.3.4 State Diagram

The following figure shows the relationship between the CONNTYPE_XATM_ENLIST initiator states.

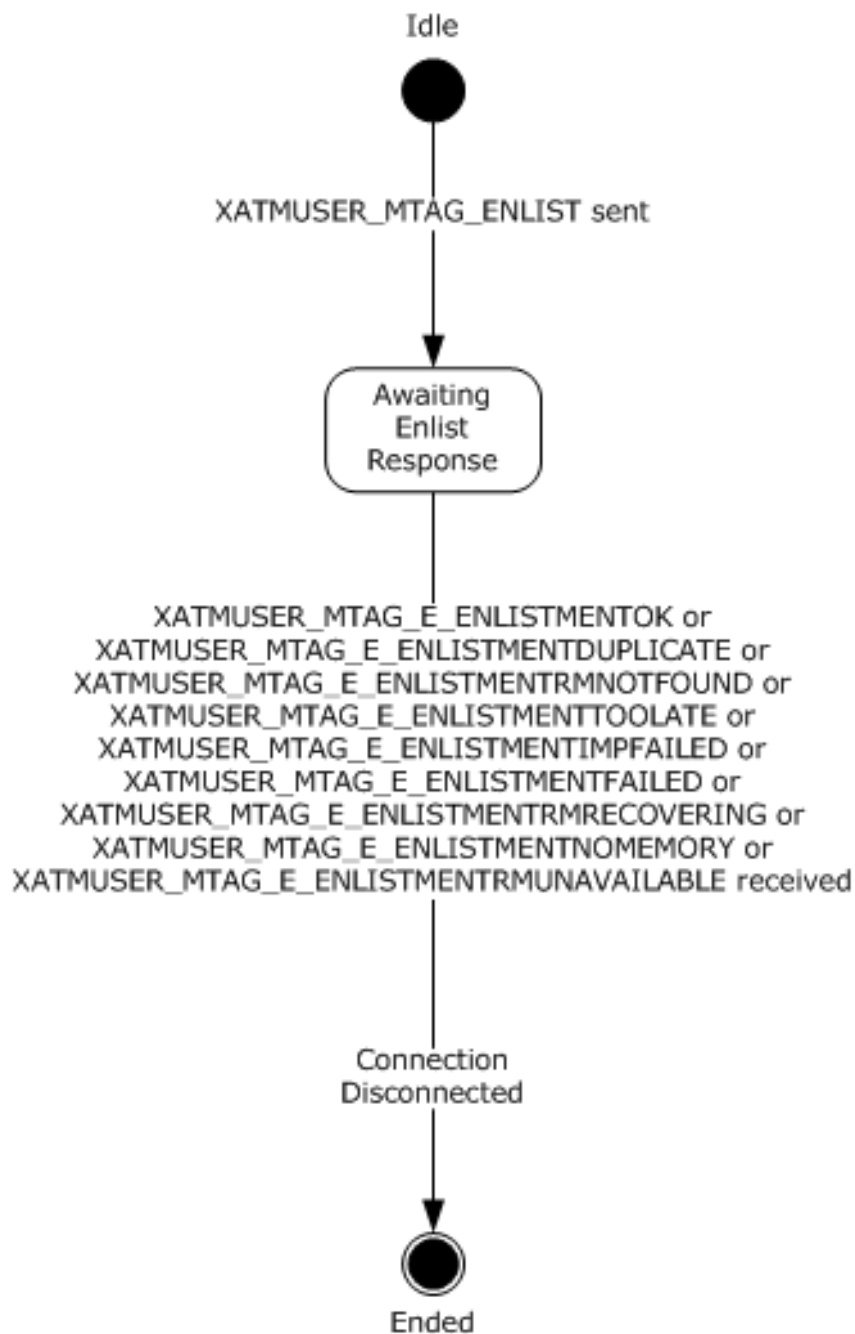

Figure 32: CONNTYPE_XATM_ENLIST initiator states

3.5.2 Timers

None.

3.5.3 Initialization

The **XA Resource Manager Bridge Facet Name** field is the Name object of the XA Resource Manager Bridge Facet that MUST be set to a value that is obtained from an implementation-specific source. This value MUST remain consistent across multiple software restarts or transient failures.

The **Transaction Manager Name** field SHOULD be set to a value that is obtained from an implementation-specific source. This value MUST remain consistent across multiple software restarts or transient failures.

The XA Resource Manager Bridge SHOULD obtain the Security Configuration of the Transaction Manager by temporarily acting as an Application Role as specified in [\[MS-DTCO\]](#) section 3.3 and signaling the event specified in [\[MS-DTCO\]](#) section 3.3.4.11.

- If the **grfXaTransactions** field of the TXUSER_GETSECURITYFLAGS_MTAG_FETCHED response message defined in [\[MS-DTCO\]](#) section 2.2.8.4.1.1 is set to 0x00000000, then when higher-layer events are triggered that would cause the XA Resource Manager Bridge to initiate any of the connection types defined in section [3.5](#), the XA Resource Manager Bridge SHOULD refuse to initiate the outgoing connections by returning a failure.

3.5.4 Higher-Layer Triggered Events

The operation of the XA Resource Manager Bridge MUST be prepared to process the higher-layer events in this section.

3.5.4.1 Register Two-Pipe XA Resource Manager

This event MUST be signaled by the higher-layer business logic with the following arguments:

- Data Store Name
- DLL Name
- **Resource Manager Cookie**

If the Register Two-Pipe XA Resource Manager event is signaled, the XA Resource Manager Bridge MUST perform the following actions:

- Attempt to find an XA Resource Manager Proxy object in the Two-Pipe XA Resource Manager Proxy Table referenced by the XA Resource Manager Bridge keyed by the provided Resource Manager Cookie.
- If an object is found:
 - Return Failure.
- Otherwise:
 - Attempt to create a new XA Resource Manager Proxy object with the following settings:
 - The resource manager Global Identifier field is set to NULL GUID.
 - The DLL Name field is set to the provided DLL Name.
 - The Data Store Name field is set to the provided Data Store Name.
 - The Pipe field is set to 2.
 - If Successful:

- Create a new XA Resource Manager Bridge CMP connection using the **XA Resource Manager Bridge Facet Name** field of the **XA Resource Manager Bridge**:
 - Set the **Connection Type** to CONNTYPE_XATM_OPEN.
- Set the Request Connection field of the XA Resource Manager Proxy object to the newly created CONNTYPE_XATM_OPEN connection.
- Set the Connection's XA Resource Manager Proxy reference to the created XA Resource Manager Proxy object.
- Add the newly created XA Resource Manager Proxy to the Two-Pipe XA Resource Manager Proxy Table referenced by the XA Resource Manager Bridge keyed by the provided Resource Manager Cookie.
- Send an [XATMUSER_MTAG_RMOPEN](#) message (section 2.2.3.2.5) with the following settings:
 - The **lenDSN** field is set to the length of the provided Data Store Name.
 - The **lenXaDll** field is set to the length of the provided DLL Name.
 - The **Recover** field is set to 0x00000000.
 - The **DSN** field is set to the provided Data Store Name.
 - The **XaDllFileName** field is set to the provided DLL Name.
- Set the State of Connection referenced by the **Request Connection** field of the created XA Resource Manager Proxy object to Awaiting Open Response.
- Otherwise:
 - Return Failure.

3.5.4.2 Unregister Two-Pipe XA Resource Manager

This event MUST be signaled by the higher-layer business logic with the following arguments:

- **Resource Manager Cookie**

If the Unregister Two-Pipe XA Resource Manager event is signaled, the XA Resource Manager Bridge MUST perform the following actions:

- Attempt to find an XA Resource Manager Proxy object in the Two-Pipe XA Resource Manager Proxy Table referenced by the XA Resource Manager Bridge keyed by the provided Resource Manager Cookie.
- If an object is found:
 - Remove the XA Resource Manager Proxy object from the Two-Pipe XA Resource Manager Proxy Table maintained by the XA Resource Manager Bridge.
 - If the State of Connection referenced by the **Request Connection** field of the XA Resource Manager Proxy is set to Active:
 - Signal the Disconnect Connection event using the connection referenced by the **Request Connection** field of the found XA Resource Manager Proxy object as the argument.
- Otherwise:

- Return Failure.

3.5.4.3 Enlist Two-Pipe XA Resource Manager

This event MUST be signaled by the higher-layer business logic with the following arguments:

- **Resource Manager Cookie**
- Transaction object

If the Enlist Two-Pipe XA Resource Manager event is signaled, the **XA Resource Manager Bridge** MUST perform the following actions:

- Initiate a new CONNTYPE_XATM_ENLIST connection using the **XA Resource Manager Bridge Facet Name** field of the XA Resource Manager Bridge.
- Attempt to find an XA Resource Manager Proxy object in the Two-Pipe XA Resource Manager Proxy Table referenced by the XA Resource Manager Bridge keyed by the provided Resource Manager Cookie.
- If an object is found:
 - Construct an [XA_XID](#) by signaling the Create XID event and passing the following arguments:
 - The specified Resource Manager Cookie.
 - The specified Transaction Object.
 - Construct an STxInfo, defined in [\[MS-DTCO\]](#) section 2.2.5.10, using the following settings:
 - Set the guidSignature field to the binary value representation of the GUID {2adb4463-bd41-11d0-b12e-00c04fc2f3ef}.
 - Set uowTx field to Identifier field of the provided Transaction object.
 - SHOULD set tmprotUsed field to 3. [<54>](#)
 - Set cbProtocolSpecificTxInfo to 0.
 - Send [XATMUSER_MTAG_ENLIST](#) message to the CONNTYPE_XATM_ENLIST connection created above, with the following arguments:
 - The resource manager Global Identifier field of the found XA Resource Manager Proxy object.
 - The constructed XA_XID.
 - lenImportCookie set to length of constructed STxInfo.
 - ImportCookie set to the constructed STxInfo.
 - Set the State of the CONNTYPE_XATM_ENLIST Connection to Awaiting Enlist Response.
- Otherwise:
 - Return Failure.

3.5.4.4 Register One-Pipe XA Resource Manager

This event MUST be signaled by the higher-layer business logic with the following arguments:

- Data Store Name
- DLL Name
- **Resource Manager Cookie**

If the Register One-Pipe XA Resource Manager event is signaled, the **XA Resource Manager Bridge** MUST perform the following actions:

- Attempt to find an XA Resource Manager Proxy object in the One-Pipe XA Resource Manager Proxy Table referenced by the XA Resource Manager Bridge keyed by the provided Resource Manager Cookie.
- If an object is found:
 - Return Failure.
- Otherwise:
 - Attempt to create a new XA Resource Manager Proxy object with the following values:
 - The resource manager Global Identifier field is set to NULL GUID.
 - The DLL Name field is set to the provided DLL name.
 - The Data Store Name field is set to the provided Data Store Name.
 - The Pipe field is set to 1.
 - If successful:
 - Create a new XA Resource Manager Bridge CMP connection using the **XA Resource Manager Bridge Facet Name** field of the XA Resource Manager Bridge:
 - Set the **Connection Type** to CONNTYPE_XATM_OPENONEPIPE.
 - Set the Request Connection field of the XA Resource Manager Proxy to the newly created CONNTYPE_XATM_OPENONEPIPE connection.
 - Set the XA Resource Manager Proxy referenced by the Connection to the created XA Resource Manager Proxy object.
 - Add the newly created XA Resource Manager Proxy object to the One-Pipe XA Resource Manager Proxy Table referenced by the XA Resource Manager Bridge keyed by the provided Resource Manager Cookie.
 - Send an [XATMUSER_MTAG_RMOPEN](#) message (section 2.2.3.2.5) with the following arguments:
 - The **lenDSN** field is set to the length of the provided Data Store Name.
 - The **lenXaDll** field is set to the length of the provided DLL Name.
 - The **Recover** field is set to 0x00000000.
 - The **DSN** field is set to the provided Data Store Name.
 - The **XaDllFileName** field is set to the provided DLL Name.
 - Set the State of the Connection referenced by the **Request Connection** field of the created XA Resource Manager Proxy object to Awaiting Open Response.

- Otherwise:
 - Return Failure.

3.5.4.5 Unregister One-Pipe XA Resource Manager

This event MUST be signaled by the higher-layer business logic with the following arguments:

- **Resource Manager Cookie**
- RecoveryNotNecessary flag

If the Unregister One-Pipe XA Resource Manager event is signaled, the XA Resource Manager Bridge MUST perform the following actions:

- Attempt to find an XA Resource Manager Proxy object in the One-Pipe XA Resource Manager Proxy Table referenced by the XA Resource Manager Bridge keyed by the provided Resource Manager Cookie.
- If an object is found:
 - If the State of Connection referenced by XA Resource Manager Proxy object is set to Active:
 - If the provided RecoveryNotNecessary flag is set to TRUE:
 - Send an [XATMUSER_MTAG_RM_CLOSE](#) message with the following arguments:
 - The **ShutDownAbrupt** field is set to 0x00000000.
 - The **Reserved** field is set to an implementation-specific value.
 - Set the State of the Connection referenced by XA Resource Manager Proxy object to Awaiting Close Response.
 - Otherwise:
 - Signal the Disconnect Connection event using the connection referenced by the **Request Connection** field of the XA Resource Manager Proxy object as the argument.
- Otherwise:
 - Return Failure.

3.5.4.6 Enlist One-Pipe XA Resource Manager

This event MUST be signaled by the higher-layer business logic with the following arguments:

- **Resource Manager Cookie**
- Transaction Object

If the Enlist One-Pipe XA Resource Manager event is signaled, the XA Resource Manager Bridge MUST perform the following actions:

- Attempt to find an XA Resource Manager Proxy object in the One-Pipe XA Resource Manager Proxy Table referenced by the XA Resource Manager Bridge keyed by the provided Resource Manager Cookie:
 - If an object is found:

- Signal the Enlisting on a Specific Transaction event ([\[MS-DTCO\]](#) section 3.5.4.3) on the Resource Manager specified by the Resource Manager field of the found XA Resource Manager Proxy object with the provided Transaction object.
- Otherwise:
 - Return Failure.

3.5.4.7 Create XID

This event MUST be signaled by the higher-layer business logic with the following arguments:

- **Resource Manager Cookie**
- Transaction object
- BranchIdentifier (optional) – A **GUID** that can be used by the higher-layer application and the **XA Resource Manager** for defining branches of work that are all associated with the same **transaction**.

This event returns an [XA XID \(section 2.2.1.3\)](#).

If the Create XID event is signaled, the XA Resource Manager Bridge MUST perform the following actions:

- Attempt to find an XA Resource Manager Proxy object in the Two-Pipe XA Resource Manager Proxy Table maintained by the XA Resource Manager Bridge keyed by the provided Resource Manager Cookie:
 - If an object is found:
 - Attempt to Create an XA_XID object with the following values:
 - formatID field set to 0x00445443.
 - gtridLength set to 16.
 - bqualLength set to 48 if BranchIdentifier is set; otherwise, to 32.
 - data set to a 128-byte array with the following format:
 - The value of the **Identifier** field of the provided Transaction Object is copied to the first set of 16 bytes of data (bytes 0 thru 15).
 - The value of the **contact identifier (CID)** field of the **XA Resource Manager Bridge Facet Name** is copied to the second set of 16 bytes of data (bytes 16-31).
 - The value of the **Resource Manager Global Identifier** field of the found XA Resource Manager Proxy object is copied to the third set of 16 bytes of data (bytes 32-47).
 - If the BranchIdentifier is set:
 - The value of the BranchIdentifier field is copied to the fourth set of 16 bytes of data (bytes 48-63).
 - The remaining 64 bytes of data are not used.
 - Otherwise, the remaining 80 bytes of data are not used.
- Return the XA_XID.

- If an object is not found or an attempt to Create an XA_XID fails:
 - Return NULL to indicate failure.

3.5.5 Processing Events and Sequencing Rules

3.5.5.1 CONNTYPE_XATM_OPEN as Initiator

For all messages received in this Connection Type, the XA Resource Manager Bridge MUST process the message as specified in section [3.1](#). The XA Resource Manager Bridge MUST also follow the processing rules specified in the following sections.

3.5.5.1.1 Receiving an XATMUSER_MTAG_RMOPENOK Message

When the XA Resource Manager Bridge receives an [XATMUSER_MTAG_RMOPENOK](#) message (section 2.2.3.2.6), it MUST perform the following actions:

- If the State of Connection is set to Awaiting Open Response:
 - Set the Resource Manager Global Identifier field of the XA Resource Manager Proxy object referenced by receiving Connection to the **guidRm** field of the message.
 - Set the State of receiving Connection to Active.
 - Return success to Register Two-Pipe XA Resource Manager event.
- Otherwise, the message MUST be processed as an invalid message as specified in section [3.1.6](#).

3.5.5.1.2 Receiving Other XATMUSER_MTAG_RMOPEN Messages

When the XA Resource Manager Bridge receives one of the following messages:

- [XATMUSER_MTAG_E_RMOPENFAILED](#) (section 2.2.3.2.3)
- [XATMUSER_MTAG_E_RMNONEXISTENT](#) (section 2.2.3.2.1)
- [XATMUSER_MTAG_E_RMNOTAVAILABLE](#) (section 2.2.3.2.2)
- [XATMUSER_MTAG_E_RMPROTOCOL](#) (section 2.2.3.2.4)

The XA Resource Manager Bridge MUST perform the following actions:

- If the State of Connection is set to Awaiting Open Response:
 - Remove the XA Resource Manager Proxy object referenced by receiving Connection from the **two-pipe** XA Resource Manager Proxy Table.
 - Signal the Disconnect Connection event using the receiving Connection as the argument.
 - Return failure to [Register Two-Pipe XA Resource Manager](#) event.
- Otherwise, the message MUST be processed as an invalid message as specified in section [3.1.6](#).

3.5.5.1.3 Connection Disconnected

When a [CONNTYPE_XATM_OPEN](#) connection is disconnected, the XA Resource Manager Bridge MUST perform the following actions:

- If the state of Connection is set to Awaiting Open Response:

- Remove the XA Resource Manager Proxy object referenced by the receiving Connection from the Two-Pipe XA Resource Manager Proxy Table.
- Set the State of the receiving Connection to Ended.
- Return failure to [Register Two-Pipe XA Resource Manager](#) event.
- Otherwise if the State of the Connection is set to Active:
 - Remove the XA Resource Manager Proxy object referenced by the receiving Connection from the Two-Pipe XA Resource Manager Proxy Table.
 - Set the State of receiving Connection to Ended.
- Otherwise, this event MUST be processed as specified in section [3.1.8.2](#).

3.5.5.2 CONNTYPE_XATM_OPENONEPIPE as Initiator

For all messages received in this Connection Type, the XA Resource Manager Bridge MUST process the message as specified in section [3.1](#). The XA Resource Manager Bridge MUST also follow the processing rules specified in the following sections.

3.5.5.2.1 Receiving an XATMUSER_MTAG_RMOPENOK Message

When the XA Resource Manager Bridge receives an [XATMUSER_MTAG_RMOPENOK](#) message (section 2.2.3.2.6), it MUST perform the following actions:

- If the State of the Connection is set to Awaiting Open Response:
 - Set the Resource Manager Global Identifier field of the XA Resource Manager Proxy object referenced by receiving Connection to the **guidRm** field of the message.
 - Set the State field of the receiving Connection to Active.
 - Create a new **GUID**.
 - Attempt to create a new **Resource Manager** object as defined in [\[MS-DTCO\]](#) section 3.5 using the newly created GUID as the Session Identifier.
 - If successful:
 - Set the **Resource Manager** field of the XA Resource Manager Proxy object to the newly created **Resource Manager** object.
 - Return success to the [Register One-Pipe XA Resource Manager](#) event (section 3.5.4.4).
 - Otherwise:
 - Return failure to the Register One-Pipe XA Resource Manager event.
- Otherwise, the message MUST be processed as an invalid message as specified in section [3.1.6](#).

3.5.5.2.2 Receiving Other XATMUSER_MTAG_RMOPEN Messages

When the XA Resource Manager Bridge receives one of the following messages:

- [XATMUSER_MTAG_E_RMOPENFAILED](#) (section 2.2.3.2.3)
- [XATMUSER_MTAG_E_RMNOTAVAILABLE](#) (section 2.2.3.2.2)
- [XATMUSER_MTAG_E_RMPROTOCOL](#) (section 2.2.3.2.4)

- [XATMUSER_MTAG_E_CONFIGLOGWRITEFAILED](#) (section 2.2.3.3.1)

The XA Resource Manager Bridge MUST perform the following actions:

- If the State of the Connection is set to Awaiting Open Response:
 - Remove the XA Resource Manager Proxy object referenced by the receiving Connection from the One-Pipe XA Resource Manager Proxy Table.
 - Signal the Disconnect Connection event using the receiving Connection as the argument.
 - Return failure to [Register One-Pipe XA Resource Manager](#) event.
- Otherwise, the message MUST be processed as an invalid message as specified in section [3.1.6](#).

3.5.5.2.3 Receiving an XATMUSER_MTAG_RMCLOSEOK Message

When the XA Resource Manager Bridge receives a [XATMUSER_MTAG_RMCLOSEOK](#) message, it MUST perform the following actions:

- If the State of the Connection is set to Awaiting Close Response:
 - Remove the XA Resource Manager Proxy object with Request Connection field set to the receiving Connection from the One-Pipe XA Resource Manager Proxy Table.
 - Signal the Disconnect Connection event using the receiving Connection as the argument.
 - Return success to [Unregister One-Pipe XA Resource Manager](#) event.
- Otherwise, the message MUST be processed as an invalid message as specified in section [3.1.6](#).

3.5.5.2.4 Receiving Other XATMUSER_MTAG_RMCLOSE Messages

When the XA Resource Manager Bridge receives one of the following messages:

- [XATMUSER_MTAG_E_RMCLOSEFAILED](#)
- [XATMUSER_MTAG_E_RMCLOSERMNOTAVAILABLE](#)
- [XATMUSER_MTAG_E_RMCLOSETMNOTAVAILABLE](#)
- [XATMUSER_MTAG_E_RMCLOSETMERROR](#)
- [XATMUSER_MTAG_E_RMCLOSEUNEXPECTED](#)

The XA Resource Manager Bridge MUST perform the following actions:

- If the State of Connection is set to Awaiting Close Response:
 - Remove the XA Resource Manager Proxy object referenced by the receiving Connection from the One-Pipe XA Resource Manager Proxy Table.
 - Signal the Disconnect Connection event using the receiving Connection as the argument.
 - Return success to [Unregister One-Pipe XA Resource Manager](#) event.
- Otherwise, the message MUST be processed as an invalid message as specified in section [3.1.6](#).

3.5.5.2.5 Connection Disconnected

When a [CONNTYPE_XATM_OPENONEPIPE](#) connection (section 2.2.3.3) is disconnected, the XA Resource Manager Bridge MUST perform the following actions:

- If the **State** of the receiving **Connection** is set to [Awaiting Open Response \(section 3.5.1.2.2\)](#):
 - Remove the **XA Resource Manager Proxy object** referenced by the receiving **Connection** from the One-Pipe XA Resource Manager Proxy Table.
 - Set the **State** of the receiving **Connection** to **Ended**.
 - Return failure to the [Register One-Pipe XA Resource Manager](#) event (section 3.5.4.4).
- Otherwise, if the **State** of the receiving **Connection** is set to [Awaiting Close Response \(section 3.5.1.2.4\)](#):
 - Remove the **XA Resource Manager Proxy object** referenced by the receiving **Connection** from the **One-Pipe XA Resource Manager Proxy Table**.
 - Set the **State** of the receiving **Connection** to **Ended**.
 - Return success to the [Unregister One-Pipe XA Resource Manager](#) event (section 3.5.4.5).
- Otherwise, if the **State** of the **Connection** is set to **Active**:
 - Remove the **XA Resource Manager Proxy object** referenced by the receiving **Connection** from the **One-Pipe XA Resource Manager Proxy Table**.
 - Set the **State** of the receiving **Connection** to **Ended**.
- Otherwise, this event MUST be processed as specified in section [3.1.8.2](#).

3.5.5.3 CONNTYPE_XATM_ENLIST as Initiator

For all messages received in this Connection Type, the XA Resource Manager Bridge MUST process the message as specified in section [3.1](#). The XA Resource Manager Bridge MUST also follow the processing rules specified in the following sections.

3.5.5.3.1 Receiving an XATMUSER_MTAG_ENLISTMENTOK or an XATMUSER_MTAG_E_ENLISTMENTDUPLICATE Message

When the XA Resource Manager Bridge receives a [XATMUSER_MTAG_ENLISTMENTOK](#) or a [XATMUSER_MTAG_E_ENLISTMENTDUPLICATE](#) message, it MUST perform the following actions:

- If the State of the Connection is set to Awaiting Enlist Response:
 - Set the State of receiving Connection to Ended.
 - Return success to [Enlist Two-Pipe XA Resource Manager](#) event.
- Otherwise the message MUST be processed as an invalid message as specified in section [3.1.6](#).

3.5.5.3.2 Receiving Other XATMUSER_MTAG_RMENLIST Messages

When the XA Resource Manager Bridge receives one of the following messages:

- [XATMUSER_MTAG_E_ENLISTMENTIMPFAILED](#)
- [XATMUSER_MTAG_E_ENLISTMENTNOMEMORY](#)
- [XATMUSER_MTAG_E_ENLISTMENTFAILED](#)
- [XATMUSER_MTAG_E_ENLISTMENTTOOLATE](#)
- [XATMUSER_MTAG_E_ENLISTMENTRMRECOVERING](#)

- [XATMUSER_MTAG_E_ENLISTMENTRMUNAVAILABLE](#)
- [XATMUSER_MTAG_E_ENLISTMENTRMNOTFOUND](#)

The XA Resource Manager Bridge MUST perform the following actions:

- If the State of the Connection is set to Awaiting Enlist Response:
 - Signal the Disconnect Connection event using the receiving Connection as the argument.
 - Return failure to [Enlist Two-Pipe XA Resource Manager](#) event.
- Otherwise, the message MUST be processed as an invalid message as specified in section [3.1.6](#).

3.5.5.3.3 Connection Disconnected

When a [CONNTYPE_XATM_ENLIST](#) connection (section 2.2.3.4) is disconnected, the XA Resource Manager Bridge MUST perform the following actions:

- If the State of the Connection is set to Awaiting Enlist Response:
 - Set the State of receiving Connection to Ended.
 - Return failure to the [Enlist Two-Pipe XA Resource Manager](#) event (section 3.5.4.3).
- Otherwise, this event MUST be processed as specified in section [3.1.8.2](#).

3.5.6 Timer Events

None.

3.5.7 Other Local Events

None.

4 Protocol Examples

The following sections describe several examples of common scenarios to illustrate the function of the MSDTC Connection Manager: OleTx XA Transaction Protocol Extension. These protocol examples assume that an **OleTx** transports session, as specified in [\[MS-CMPO\]](#), has already been established between the two **participants**.

In these examples, the abbreviation "gtrid" is used for "XA Global Transaction Identifier" to conserve space.

Participants communicate with each other using OleTx multiplexing connections (as specified in [\[MS-CMP\]](#)) that are in turn layered on top of the OleTx transports infrastructure (as specified in [\[MS-CMPO\]](#)). In these examples, messages are sent from one participant to another by submitting a [MESSAGE PACKET \(section 2.2.1.1\)](#) to the underlying OleTx multiplexing layer, as specified in [\[MS-CMP\]](#).

4.1 XA Superior Scenarios

These scenarios show how an XA Superior Transaction Manager interoperates with an XA Subordinate Transaction Manager Facet.

4.1.1 Opening an XA Superior Connection with an XA Subordinate Transaction Manager Facet Scenario

This packet sequence is initiated by starting a connection on a transport session between an XA Superior Transaction Manager and an [XA Subordinate Transaction Manager Facet](#).

[CONNTYPE_XAUSER_CONTROL](#): The packet sequence starts when an XA Superior Transaction Manager initiates a connection with an XA Subordinate Transaction Manager Facet using [CONNTYPE_XAUSER_CONTROL](#).

Field	Value	Value description
MsgTag	0x00000005	MTAG_CONNECTION_REQ
fIsMaster	0x00000001	1
dwConnectionId	0x00000001	1
dwUserMsgType	0x00000040	CONNTYPE_XAUSER_CONTROLL
dwcbVarLenData	0x00000000	0
dwReserved1	0x00000000	0

The XA Superior Transaction Manager then sends a [XAUSER_CONTROL MTAG_CREATE](#) user message specifying its **Resource Manager Recovery GUID** (guidXaRM: a9b05f39-2368-4c99-94bc-7b5a4bb3f07d).

Field	Value	Value description
MsgTag	0x00000FFF	MTAG_USER_MESSAGE
fIsMaster	0x00000001	1
dwConnectionId	0x00000001	1
dwUserMsgType	0x00004001	XAUSER_CONTROL_MTAG_CREATE

Field	Value	Value description
dwcbVarLenData	0x00000010	16
dwReserved1	0xCD64CD64	dwReserved1: 0xcd64cd64
guidXaRm	0xA9B05F39	a9b05f39-2368-4c99-94bc-7b5a4bb3f07d
	0x4C992368	
	0x5A7BBC94	
	0x7DF0B34B	

When the XA Subordinate Transaction Manager Facet receives the XAUSER_CONTROL_MTAG_CREATE message from the XA Superior Transaction Manager, the XA Subordinate Transaction Manager Facet attempts to add the Resource Manager Recovery GUID to its list of known Resource Manager Recovery GUIDs. If the Resource Manager Recovery GUID is successfully added, then the XA Subordinate Transaction Manager Facet sends a XAUSER_CONTROL_MTAG_CREATED user message to the XA Superior Transaction Manager.

Field	Value	Value description
MsgTag	0x00000FFF	MTAG_USER_MESSAGE
fIsMaster	0x00000000	0
dwConnectionId	0x00000001	1
dwUserMsgType	0x00004002	XAUSER_CONTROL_MTAG_CREATED
dwcbVarLenData	0x00000000	0
dwReserved1	0xCD64CD64	dwReserved1: 0xcd64cd64

When the XA Superior Transaction Manager gets the XAUSER_CONTROL_MTAG_CREATED response from the XA Subordinate Transaction Manager Facet, the XA Superior Transaction Manager maintains this connection to perform **transaction recovery** and new transactional work with the XA Subordinate Transaction Manager Facet. When the XA Superior Transaction Manager is finished with all transactional work with the XA Subordinate Transaction Manager Facet, it closes the connection by initiating the Disconnect sequence.

4.1.2 Starting an XA Superior Transaction with an XA Subordinate Transaction Manager Facet Scenario

This packet sequence is initiated by starting a connection on a transport session between an XA Superior Transaction Manager and an XA Subordinate Transaction Manager Facet. This scenario assumes that the XA Superior Transaction Manager is maintaining an XA Superior connection with the XA Subordinate Transaction Manager Facet (see section [4.1.1](#)).

CONNTYPE_XAUSER_XACT_START: The packet sequence starts when an XA Superior Transaction Manager initiates a connection with an XA Subordinate Transaction Manager Facet using CONNTYPE_XAUSER_XACT_START.

Field	Value	Value description
MsgTag	0x00000005	MTAG_CONNECTION_REQ
fIsMaster	0x00000001	1

Field	Value	Value description
dwConnectionId	0x00000002	2
dwUserMsgType	0x00000041	CONNTYPE_XAUSER_XACT_START
dwcbVarLenData	0x00000000	0
dwReserved1	0xCD64CD64	dwReserved1: 0xcd64cd64

The XA Superior Transaction Manager then sends a XAUSER_XACT_MTAG_START user message. In this example, the XA Superior Transaction Manager specifies its **Resource Manager Recovery GUID** (guidXaRM: a9b05f39-2368-4c99-94bc-7b5a4bb3f07d) and initializes the **XID** to a format different from the MSDTC format described in section [2.2.1.3](#). The XID specified has (formatId:"0x0000cafe";gtrid:"4f1f5346-e4d2-4ae8-9633-5ab7b8440ef8"; bqual:"0") and requests an associated **transaction** with ISOLATIONLEVEL_SERIALIZABLE, no time out, a description of "sample transaction", and ISOFLAG_RETAIN_DONTCARE.

Field	Value	Value description
MsgTag	0x00000FFF	MTAG_USER_MESSAGE
fIsMaster	0x00000001	1
dwConnectionId	0x00000002	2
dwUserMsgType	0x00004010	XAUSER_XACT_MTAG_START
dwcbVarLenData	0x000000D4	212
dwReserved1	0xCD64CD64	dwReserved1: 0xcd64cd64
guidXaRm	0xA9B05F39	a9b05f39-2368-4c99-94bc-7b5a4bb3f07d
	0x4C992368	
	0x5A7BBC94	
	0x7DF0B34B	
lenXAIdentifier	0x0000008C	140 (+ 3 bytes of padding)
formatId	0x0000CAFE	formatId: 0x0000cafe
gtridLength	0x00000024	36
bqualLength	0x00000001	1
Data	0x66316634	gtrid:"4f1f5346-e4d2-4ae8-9633-5ab7b8440ef8"
	0x36343335	
	0x6434652D	
	0x61342D32	
	0x392D3865	
	0x2D333336	
	0x37626135	
	0x34343862	

Field	Value	Value description
	0x38666530	
	0x00000030	bqual:"0"
	0x00000000	
	0x00000000	
	0x00000000	
	0x00000000	
	0x00000000	
	0x00000000	
	0x00000000	
	0x00000000	
	0x00000000	
	0x00000000	
	0x00000000	
	0x00000000	
	0x00000000	
	0x00000000	
	0x00000000	
	0x00000000	
	0x00000000	
	0x00000000	
	0x00000000	
	0x00000000	
	0x00000000	
	0x00000000	
	0x00000000	
	0x00000000	
	0x00000000	
	0x00000000	
isoLevel	0x00100000	ISOLATIONLEVEL_SERIALIZABLE
dwTimeout	0x00000000	0
szDesc	0x706D6173	sample transaction
	0x7420656C	
	0x736E6172	
	0x69746361	
	0x00006E6F	
	0x00000000	

Field	Value	Value description
	0x00000000	
	0x00000000	
	0x00000000	
	0x00000000	
isoFlags	0x00000005	ISOFLAG_RETAIN_DONTCARE

When the XA Subordinate Transaction Manager Facet receives the XAUSER_XACT_MTAG_START message from the XA Superior Transaction Manager, the XA Subordinate Transaction Manager Facet attempts to add the XID to its list of known XIDs.

In this example, the XID is successfully added. The XA Subordinate Transaction Manager Facet then creates an associated **OleTx** transaction and send a XAUSER_XACT_MTAG_STARTED user message to the XA Superior Transaction Manager specifying the new OleTx **transaction identifier** (guidTx: 4046037e-9722-46c9-9883-99062341cb35).

Field	Value	Value description
MsgTag	0x00000FFF	MTAG_USER_MESSAGE
fIsMaster	0x00000000	0
dwConnectionId	0x00000002	2
dwUserMsgType	0x00004011	XAUSER_XACT_MTAG_STARTED
dwcbVarLenData	0x00000010	16
dwReserved1	0xCD64CD64	dwReserved1: 0xcd64cd64
guidTx	0x4046037E	4046037e-9722-46c9-9883-99062341cb35
	0x46C99722	
	0x06999883	
	0x35CB4123	

When the XA Superior Transaction Manager receives the XAUSER_XACT_MTAG_STARTED response from the XA Subordinate Transaction Manager Facet, the XA Superior Transaction Manager maintains this connection to perform work on the transaction. When the XA Superior Transaction Manager is finished with all transactional work associated with the transaction, it closes the connection by initiating the Disconnect sequence.

4.1.3 XA Superior Two-Phase Commit Scenario

This scenario shows how an XA Superior Transaction Manager performs the **Two-Phase Commit Protocol** with an XA Subordinate Transaction Manager Facet. This scenario assumes that the XA Superior Transaction Manager is maintaining an XA Superior connection with the XA Subordinate Transaction Manager Facet (see section [4.1.1](#)).

4.1.3.1 Preparing an XA Superior Transaction with an XA Subordinate Transaction Manager Facet

This packet sequence is initiated by starting a connection on a transport session between an XA Superior Transaction Manager and an [XA Subordinate Transaction Manager Facet](#).

[CONNTYPE_XAUSER_XACT_OPEN](#): The packet sequence starts when an XA Superior Transaction Manager initiates a connection with an XA Subordinate Transaction Manager Facet using CONNTYPE_XAUSER_XACT_OPEN.

Field	Value	Value description
MsgTag	0x00000005	MTAG_CONNECTION_REQ
fIsMaster	0x00000001	1
dwConnectionId	0x00000002	2
dwUserMsgType	0x00000042	CONNTYPE_XAUSER_XACT_OPEN
dwcbVarLenData	0x00000000	0
dwReserved1	0xCD64CD64	dwReserved1: 0xcd64cd64

The XA Superior Transaction Manager then sends a [XAUSER_XACT_MTAG_OPEN](#) user message. In this example, the XA Superior Transaction Manager specifies its **Resource Manager Recovery GUID** (guidXaRM: a9b05f39-2368-4c99-94bc-7b5a4bb3f07d) and initializes the **XID** to a format different from the MSDTC format described in section [2.2.1.3](#). The XID specified has (formatId: "0x0000cafe"; gtrid:"4f1f5346-e4d2-4ae8-9633-5ab7b8440ef8"; bqual:"0").

Field	Value	Value description
MsgTag	0x00000FFF	MTAG_USER_MESSAGE
fIsMaster	0x00000001	1
dwConnectionId	0x00000002	2
dwUserMsgType	0x00004012	XAUSER_XACT_MTAG_OPEN
dwcbVarLenData	0x000000A0	160
dwReserved1	0xCD64CD64	dwReserved1: 0xcd64cd64
guidXaRm	0xA9B05F39	a9b05f39-2368-4c99-94bc-7b5a4bb3f07d
	0x4C992368	
	0x5A7BBC94	
	0x7DF0B34B	
lenXAIdentifier	0x0000008C	140 (+ 3 bytes of padding)
formatId	0x0000CAFE	formatId: 0x0000cafe
gtridLength	0x00000024	36
bqualLength	0x00000001	1
Data	0x66316634	gtrid:"4f1f5346-e4d2-4ae8-9633-5ab7b8440ef8"

When the XA Subordinate Transaction Manager Facet receives the XAUSER_XACT_MTAG_OPEN message from the XA Superior Transaction Manager, the XA Subordinate Transaction Manager Facet attempts to locate the XID to its list of known XIDs.

In this example, the XID is located and the XA Subordinate Transaction Manager Facet sends a XAUSER_XACT_MTAG_OPENED user message to the XA Superior Transaction Manager specifying the **OleTx transaction identifier** (guidTx: 4046037e-9722-46c9-9883-99062341cb35).

Field	Value	Value description
MsgTag	0x00000FFF	MTAG_USER_MESSAGE
fIsMaster	0x00000000	0
dwConnectionId	0x00000002	2
dwUserMsgType	0x00004013	XAUSER_XACT_MTAG_OPENED
dwcbVarLenData	0x00000010	16
dwReserved1	0xCD64CD64	dwReserved1: 0xcd64cd64
guidTx	0x4046037E	4046037e-9722-46c9-9883-99062341cb35
	0x46C99722	
	0x06999883	
	0x35CB4123	

When the XA Superior Transaction Manager receives the XAUSER_XACT_MTAG_OPENED response from the XA Subordinate Transaction Manager Facet, the XA Superior Transaction Manager sends a XAUSER_XACT_MTAG_PREPARE user message to the XA Subordinate Transaction Manager Facet specifying that this is not a single-phase commit (fSinglePhase: 0).

Field	Value	Value description
MsgTag	0x00000FFF	MTAG_USER_MESSAGE
fIsMaster	0x00000001	1
dwConnectionId	0x00000002	2
dwUserMsgType	0x00004015	XAUSER_XACT_MTAG_PREPARE
dwcbVarLenData	0x00000004	4
dwReserved1	0xCD64CD64	dwReserved1: 0xcd64cd64
fSinglePhase	0x00000000	FALSE: 0

When the XA Subordinate Transaction Manager Facet receives the XAUSER_XACT_MTAG_PREPARE message from the XA Superior Transaction Manager, the XA Subordinate Transaction Manager Facet signals the Core Transaction Manager Facet that **transaction** processing has begun.

In this example, the XA Subordinate Transaction Manager Facet receives Phase One Complete notification from the Core Transaction Manager Facet. In response, the XA Subordinate Transaction Manager Facet sends a XAUSER_XACT_MTAG_REQUEST_COMPLETED user message to XA Superior Transaction Manager indicating that the XA Subordinate Transaction Manager Facet is prepared to commit the transaction.

Field	Value	Value description
MsgTag	0x00000FFF	MTAG_USER_MESSAGE
fIsMaster	0x00000000	0
dwConnectionId	0x00000002	2
dwUserMsgType	0x00004017	XAUSER_XACT_MTAG_REQUEST_COMPLETED
dwcbVarLenData	0x00000000	0
dwReserved1	0xCD64CD64	dwReserved1: 0xcd64cd64

When the XA Superior Transaction Manager receives the XAUSER_XACT_MTAG_REQUEST_COMPLETED response from the XA Subordinate Transaction Manager Facet, the XA Superior Transaction Manager closes the connection by initiating the Disconnect sequence.

4.1.3.2 Committing an XA Superior Transaction with an XA Subordinate Transaction Manager Facet

This packet sequence is initiated by starting a connection on a transport session between an XA Superior Transaction Manager and an [XA Subordinate Transaction Manager Facet](#).

CONNTYPE_XAUSER_XACT_OPEN: The packet sequence starts when an XA Superior Transaction Manager initiates a connection with an XA Subordinate Transaction Manager Facet using CONNTYPE_XAUSER_XACT_OPEN.

Field	Value	Value description
MsgTag	0x00000005	MTAG_CONNECTION_REQ
fIsMaster	0x00000001	1
dwConnectionId	0x00000002	2
dwUserMsgType	0x00000042	CONNTYPE_XAUSER_XACT_OPEN
dwcbVarLenData	0x00000000	0
dwReserved1	0xCD64CD64	dwReserved1: 0xcd64cd64

The XA Superior Transaction Manager then sends a [XAUSER_XACT_MTAG_OPEN](#) user message. In this example, the XA Superior Transaction Manager specifies its **Resource Manager Recovery GUID** (guidXaRM: a9b05f39-2368-4c99-94bc-7b5a4bb3f07d) and initializes the **XID** to a format different from the MSDTC format described in section [2.2.1.3](#). The XID specified has (formatId: "0x0000cafe"; grid:"4f1f5346-e4d2-4ae8-9633-5ab7b8440ef8"; bqual:"0").

Field	Value	Value description
MsgTag	0x00000FFF	MTAG_USER_MESSAGE
fIsMaster	0x00000001	1
dwConnectionId	0x00000002	2
dwUserMsgType	0x00004012	XAUSER_XACT_MTAG_OPEN
dwcbVarLenData	0x000000A0	160

Field	Value	Value description
dwReserved1	0xCD64CD64	dwReserved1: 0xcd64cd64
guidXaRm	0xA9B05F39	a9b05f39-2368-4c99-94bc-7b5a4bb3f07d
	0x4C992368	
	0x5A7BBC94	
	0x7DF0B34B	
lenXAIdentifier	0x0000008C	140 (+ 3 bytes of padding)
formatId	0x0000CAFE	formatId: 0x0000cafe
gtridLength	0x00000024	36
bqualLength	0x00000001	1
Data	0x66316634	gtrid:"4f1f5346-e4d2-4ae8-9633-5ab7b8440ef8"
	0x36343335	
	0x6434652D	
	0x61342D32	
	0x392D3865	
	0x2D333336	
	0x37626135	
	0x34343862	
	0x38666530	
	0x00000030	bqual:"0"
	0x00000000	
	0x00000000	
	0x00000000	
	0x00000000	
	0x00000000	
	0x00000000	
	0x00000000	
	0x00000000	
	0x00000000	
	0x00000000	
	0x00000000	
	0x00000000	
	0x00000000	
	0x00000000	
	0x00000000	
	0x00000000	
	0x00000000	
	0x00000000	
	0x00000000	

Field	Value	Value description
	0x00000000	
	0x00000000	
	0x00000000	
	0x00000000	
	0x00000000	
	0x00000000	
	0x00000000	
	0x00000000	
	0x00000000	

When the XA Subordinate Transaction Manager Facet receives the XAUSER_XACT_MTAG_OPEN message from the XA Superior Transaction Manager, the XA Subordinate Transaction Manager Facet attempts to locate the XID to its list of known XIDs.

In this example, the XID is located and the XA Subordinate Transaction Manager Facet sends a [XAUSER_XACT_MTAG_OPENED](#) user message to the XA Superior Transaction Manager specifying the **OleTx transaction identifier** (guidTx: 4046037e-9722-46c9-9883-99062341cb35).

Field	Value	Value description
MsgTag	0x00000FFF	MTAG_USER_MESSAGE
fIsMaster	0x00000000	0
dwConnectionId	0x00000002	2
dwUserMsgType	0x00004013	XAUSER_XACT_MTAG_OPENED
dwcbVarLenData	0x00000010	16
dwReserved1	0xCD64CD64	dwReserved1: 0xcd64cd64
guidTx	0x4046037E	4046037e-9722-46c9-9883-99062341cb35
	0x46C99722	
	0x06999883	
	0x35CB4123	

When the XA Superior Transaction Manager receives the XAUSER_XACT_MTAG_OPENED response from the XA Subordinate Transaction Manager Facet, the XA Superior Transaction Manager sends an XAUSER_XACT_MTAG_COMMIT user message to the XA Subordinate Transaction Manager Facet.

Field	Value	Value description
MsgTag	0x00000FFF	MTAG_USER_MESSAGE
fIsMaster	0x00000001	1
dwConnectionId	0x00000002	2

Field	Value	Value description
dwUserMsgType	0x00004016	XAUSER_XACT_MTAG_COMMIT
dwcbVarLenData	0x00000000	0
dwReserved1	0xCD64CD64	dwReserved1: 0xcd64cd64

When the XA Subordinate Transaction Manager Facet receives the [XAUSER_XACT_MTAG_COMMIT](#) message from the XA Superior Transaction Manager, the XA Subordinate Transaction Manager Facet signals the Core Transaction Manager Facet that the **transaction** has committed.

When the XA Subordinate Transaction Manager Facet receives [Commit Complete](#) notification from the Core Transaction Manager Facet, the XA Subordinate Transaction Manager Facet sends a [XAUSER_XACT_MTAG_REQUEST_COMPLETED](#) user message to XA Superior Transaction Manager indicating that the XA Subordinate Transaction Manager Facet has committed the transaction.

Field	Value	Value description
MsgTag	0x00000FFF	MTAG_USER_MESSAGE
fIsMaster	0x00000000	0
dwConnectionId	0x00000002	2
dwUserMsgType	0x00004017	XAUSER_XACT_MTAG_REQUEST_COMPLETED
dwcbVarLenData	0x00000000	0
dwReserved1	0xCD64CD64	dwReserved1: 0xcd64cd64

When the XA Superior Transaction Manager receives the XAUSER_XACT_MTAG_REQUEST_COMPLETED response from the XA Subordinate Transaction Manager Facet, the XA Superior Transaction Manager closes the connection by initiating the Disconnect sequence.

4.1.4 XA Superior Recovery Scenario

This scenario shows how an XA Superior Transaction Manager performs XA Recovery with an [XA Subordinate Transaction Manager Facet](#). This scenario assumes that the XA Superior Transaction Manager is maintaining an XA Superior connection with the XA Subordinate Transaction Manager Facet (see section [4.1.1](#)).

4.1.4.1 Obtaining a List of XA Superior Transactions to Recover with an XA Subordinate Transaction Manager Facet

This packet sequence uses the XA Superior connection already established with the [XA Subordinate Transaction Manager Facet](#) (see section [4.1.1](#)).

To initiate **recovery**, the [XA Superior Transaction Manager](#) sends a [XAUSER_CONTROL_MTAG_RECOVER](#) user message. In this example, the XA Superior Transaction Manager specifies to start a new scan (RequestFlags: XARECOVER_START_SCAN) and to return a maximum of five **XIDs** (totalUOWsRequested: 5).

Field	Value	Value description
MsgTag	0x00000FFF	MTAG_USER_MESSAGE
fIsMaster	0x00000001	1

Field	Value	Value description
dwConnectionId	0x00000001	1
dwUserMsgType	0x00004003	XAUSER_CONTROL_MTAG_RECOVER
dwcbVarLenData	0x00000008	8
dwReserved1	0xCD64CD64	dwReserved1: 0xcd64cd64
RequestFlags	0x00000001	XARECOVER_START_SCAN
totalUOWsRequested	0x00000005	5

When the XA Subordinate Transaction Manager Facet receives the XAUSER_CONTROL_MTAG_RECOVER message from the XA Superior Transaction Manager, the XA Subordinate Transaction Manager Facet starts a scan through its list of known XIDs for any **transactions** that are prepared but for which the XA Subordinate Transaction Manager Facet does not know **outcome**. The scan is halted if the number of transactions needing recovery reaches five (totalUOWsRequested: 5).

In this example, the XA Subordinate Transaction Manager Facet locates a total of one transaction in need of recovery. The XA Subordinate Transaction Manager Facet sends a [XAUSER_CONTROL_MTAG_RECOVER_REPLY](#) user message to the XA Superior Transaction Manager specifying that there it has one transaction that needs recovery (ulTotalUOWs: 1) and that there are no more recovery records to scan (ReplyFlags: XARECOVER_END_OF_RECS). The message also contains the list of one XID (formatId: "0x0000cafe"; gtrid:" 4046037e-9722-46c9-9883-99062341cb35"; bqual:"0") in need of outcome.

Field	Value	Value description
MsgTag	0x00000FFF	MTAG_USER_MESSAGE
fIsMaster	0x00000000	0
dwConnectionId	0x00000001	1
dwUserMsgType	0x00004005	XAUSER_CONTROL_MTAG_RECOVER_REPLY
dwcbVarLenData	0x00000098	152
dwReserved1	0xCD64CD64	dwReserved1: 0xcd64cd64
ReplyFlags	0x00000002	XARECOVER_END_OF_RECS
ulTotalUOWs	0x00000001	1
lenXAIdentifier	0x0000008C	140 (+ 3 bytes of padding)
formatId	0x0000CAFE	formatId: 0x0000cafe
gtridLength	0x00000024	36
bqualLength	0x00000001	1
Data	0x36343034	gtrid:"4046037e-9722-46c9-9883-99062341cb35"
	0x65373330	
	0x3237392D	
	0x36342D32	

In this example, the XA Superior Transaction Manager determines that the transaction has aborted and so it initiates a [CONNTYPE_XAUSER_XACT_OPEN](#) connection with the XA Subordinate Transaction Manager Facet.

Field	Value	Value description
MsgTag	0x00000005	MTAG_CONNECTION_REQ
fIsMaster	0x00000001	1
dwConnectionId	0x00000002	2
dwUserMsgType	0x00000042	CONNTYPE_XAUSER_XACT_OPEN
dwcbVarLenData	0x00000000	0
dwReserved1	0xCD64CD64	dwReserved1: 0xcd64cd64

The XA Superior Transaction Manager then sends a [XAUSER_XACT_MTAG_OPEN](#) user message. In this example, the XA Superior Transaction Manager specifies its **Resource Manager Recovery GUID** (guidXaRM: a9b05f39-2368-4c99-94bc-7b5a4bb3f07d) and the XID (formatId: "0x0000cafe"; gtrid:"4046037e-9722-46c9-9883-99062341cb35"; bqual:"0") that needs recovery.

Field	Value	Value description
MsgTag	0x00000FFF	MTAG_USER_MESSAGE
fIsMaster	0x00000001	1
dwConnectionId	0x00000002	2
dwUserMsgType	0x00004012	XAUSER_XACT_MTAG_OPEN
dwcbVarLenData	0x000000A0	160
dwReserved1	0xCD64CD64	dwReserved1: 0xcd64cd64
guidXaRm	0xA9B05F39	a9b05f39-2368-4c99-94bc-7b5a4bb3f07d
	0x4C992368	
	0x5A7BBC94	
	0x7DF0B34B	
lenXAIdentifier	0x0000008C	140 (+ 3 bytes of padding)
formatId	0x0000CAFE	formatId: 0x0000cafe
gtridLength	0x00000024	36
bqualLength	0x00000001	1
formatId	0x0000CAFE	formatId: 0x0000cafe
gtridLength	0x00000024	36
bqualLength	0x00000001	1
Data	0x36343034	gtrid:"4046037e-9722-46c9-9883-99062341cb35"
	0x65373330	

Field	Value	Value description
MsgTag	0x00000FFF	MTAG_USER_MESSAGE
fIsMaster	0x00000000	0
dwConnectionId	0x00000002	2
dwUserMsgType	0x00004013	XAUSER_XACT_MTAG_OPENED
dwcbVarLenData	0x00000010	16
dwReserved1	0xCD64CD64	dwReserved1: 0xcd64cd64
guidTx	0x8F5204B3	8f5204b3-5fb9-466a-a0b8-2daf3fcbd9aa
	0x466A5FB9	
	0xAF2DA0B8	
	0xAAD9CB3F	

When the XA Superior Transaction Manager receives the XAUSER_XACT_MTAG_OPENED response from the XA Subordinate Transaction Manager Facet, the XA Superior Transaction Manager sends a [XAUSER_XACT_MTAG_ABORT](#) user message to the XA Subordinate Transaction Manager Facet.

Field	Value	Value description
MsgTag	0x00000FFF	MTAG_USER_MESSAGE
fIsMaster	0x00000001	1
dwConnectionId	0x00000002	2
dwUserMsgType	0x00004014	XAUSER_XACT_MTAG_ABORT
dwcbVarLenData	0x00000000	0
dwReserved1	0xCD64CD64	dwReserved1: 0xcd64cd64

When the XA Subordinate Transaction Manager Facet receives the XAUSER_XACT_MTAG_ABORT message from the XA Superior Transaction Manager, the XA Subordinate Transaction Manager Facet signals the Core Transaction Manager Facet that the transaction has aborted.

When the XA Subordinate Transaction Manager Facet receives [Rollback Complete](#) notification from the Core Transaction Manager Facet, the XA Subordinate Transaction Manager Facet sends a [XAUSER_XACT_MTAG_REQUEST_COMPLETED](#) user message to XA Superior Transaction Manager indicating that the XA Subordinate Transaction Manager Facet has aborted the transaction.

Field	Value	Value description
MsgTag	0x00000FFF	MTAG_USER_MESSAGE
fIsMaster	0x00000000	0
dwConnectionId	0x00000002	2
dwUserMsgType	0x00004017	XAUSER_XACT_MTAG_REQUEST_COMPLETED
dwcbVarLenData	0x00000000	0
dwReserved1	0xCD64CD64	dwReserved1: 0xcd64cd64

When the XA Superior Transaction Manager receives the XAUSER_XACT_MTAG_REQUEST_COMPLETED response from the XA Subordinate Transaction Manager Facet, the XA Superior Transaction Manager closes the connection by initiating the Disconnect sequence.

4.2 XA Resource Manager Bridge Facet Scenarios

These scenarios show how an XA Resource Manager Bridge Facet interoperates with an XA Resource Manager Bridge.

4.2.1 Two-Pipe Model

These scenarios show the interactions that take place when a Two-Pipe XA Resource Manager is registered with a Transaction Manager.

4.2.1.1 Registering a Two-Pipe XA Resource Manager

This scenario is initiated when the higher-level logic signals the [Register Two-Pipe XA Resource Manager](#) event on an **XA Resource Manager Bridge**, providing a Data Store Name, a DLL Name, and a **Resource Manager Cookie**.

The XA Resource Manager Bridge initiates a connection with the **XA Resource Manager Bridge Facet** using [CONNTYPE_XATM_OPEN](#) as follows.

Field	Value	Value description
MsgTag	0x00000005	MTAG_CONNECTION_REQ
fIsMaster	0x00000001	1
dwConnectionId	0x00000002	2
dwUserMsgType	0x00001001	CONNTYPE_XATM_OPEN
dwcbVarLenData	0x00000000	0
dwReserved1	0xCD64CD64	dwReserved1: 0xcd64cd64

The XA Resource Manager Bridge then sends an [XATMUSER_MTAG_RMOPEN](#) user message specifying the Data Store Name and DLL Name as follows.

Field	Value	Value description
MsgTag	0x00000FFF	MTAG_USER_MESSAGE
fIsMaster	0x00000001	1
dwConnectionId	0x00000002	2
dwUserMsgType	0x20000001	XATMUSER_MTAG_RMOPEN
dwcbVarLenData	0x00000024	36
dwReserved1	0xCD64CD64	dwReserved1: 0xcd64cd64
lenDSN	0x00000010	16
lenXaDll	0x00000008	8
Recover	0x00000000	The transaction manager does not perform recovery.

Field	Value	Value description
DSN	0x656D614E	"Data Source Name"
	0x20656372	
	0x756F5320	
	0x61746144	
XaDllFileName	0x6C6C642E	"AnXa.dll"
	0x61586E41	

When the XA Resource Manager Bridge Facet receives the XATMUSER_MTAG_RMOPEN message from the XA Resource Manager Bridge, the XA Resource Manager Bridge Facet attempts to find an **XA Resource Manager** object in the XA Resource Manager Table that has its Data Source Name set to the value of the DSN field of the message. In this example, assume such an object was found and its State is Active. The XA Resource Manager Bridge Facet then sends an [XATMUSER_MTAG_RMOPENOK](#) message to the XA Resource Manager Bridge specifying the **XA Resource Manager Identifier** field (localRmId:5) and the **Resource Manager Global Identifier** (guidRm: 31d8fe66-7752-4bd5-a2b2-b6c4937e601e) field of the XA Resource Manager object.

Field	Value	Value description
MsgTag	0x00000FFF	MTAG_USER_MESSAGE
fIsMaster	0x00000000	0
dwConnectionId	0x00000002	2
dwUserMsgType	0x20000002	XATMUSER_MTAG_RMOPENOK
dwcbVarLenData	0x00000014	20
dwReserved1	0xCD64CD64	dwReserved1: 0xcd64cd64
localRmId	0x00000005	5
guidRm	0x31D8FE66	0x31d8fe66-7752-4bd5-a2b2-b6c4937e601e
	0x4BD57752	
	0xC4B6A2B2	
	0x1E607E93	

When the XA Resource Manager Bridge receives the XATMUSER_MTAG_RMOPEN message, it sets the **Resource Manager Global Identifier** field of the XA Resource Manager Proxy object referenced by the receiving Connection to the **guidRm** field of the message, and returns success to the Register Two-Pipe XA Resource Manager event.

4.2.1.2 Enlisting a Two-Pipe XA Resource Manager in an OleTx Transaction

This scenario is initiated when the higher-level logic signals the [Enlist Two-Pipe XA Resource Manager](#) event on **XA Resource Manager Bridge**, providing a Transaction object and a **Resource Manager Cookie**.

The XA Resource Manager Bridge initiates a connection with the **XA Resource Manager Bridge Facet** using [CONNTYPE_XATM_ENLIST](#) as follows.

Field	Value	Value description
MsgTag	0x00000005	MTAG_CONNECTION_REQ
fIsMaster	0x00000001	1
dwConnectionId	0x00000003	3
dwUserMsgType	0x00001002	CONNTYPE_XATM_ENLIST
dwcbVarLenData	0x00000000	0
dwReserved1	0xCD64CD64	dwReserved1: 0xcd64cd64

The XA Resource Manager Bridge then attempts to find an XA Resource Manager Proxy object in the Two-Pipe XA Resource Manager Proxy Table referenced by the XA Resource Manager Bridge keyed by the provided Resource Manager Cookie. Assuming such an object is found, the XA Resource Manager Bridge initializes an XID as specified in section [2.2.1.3](#), as follows.

Field	Value	Value description
formatId	0x00445443	formatId: 0x00445443
gtridLength	0x00000010	16
bqualLength	0x00000020	32
Data	0xCE5163B5	Global Tx Identifier: ce5163b5-61c6-4091-a1d1-e6b5ef55c26f
	0x409161C6	
	0xB5E6D1A1	
	0x6FC255EF	
	0xC59B5217	XATMGUID: c59b5217-c34a-4180-8575-dba2eb499cf2
	0x4180C34A	
	0xA2DB7585	
	0xF29C49EB	
	0x31D8FE66	RMGUID: 31d8fe66-7752-4bd5-a2b2-b6c4937e601e
	0x4BD57752	
	0xC4B6A2B2	
	0x1E607E93	
	0x00000000	
	0x00000000	
	0x00000000	
	0x00000000	
	0x00000000	
	0x00000000	
	0x00000000	

Field	Value	Value description
	0x00000000	
	0x00000000	
	0x00000000	
	0x00000000	
	0x00000000	
	0x00000000	
	0x00000000	
	0x00000000	
	0x00000000	
	0x00000000	
	0x00000000	
	0x00000000	
	0x00000000	
	0x00000000	
	0x00000000	
	0x00000000	

The XA Resource Manager Bridge then constructs an STxInfo (as defined in [\[MS-DTCO\]](#) section 2.2.5.10) using the following settings.

Field	Value	Value description
guidSignature	0x2ADB4463	2adb4463-bd41-11d0-b12e-00c04fc2f3ef
	0x11D0BD41	
	0xC0002EB1	
	0xEFF3C24F	
uowTx	0xCE5163B5	Global Tx Identifier: ce5163b5-61c6-4091-a1d1-e6b5ef55c26f
	0x409161C6	
	0xB5E6D1A1	
	0x6FC255EF	
tmprotUsed	0x00000003	3
cbProtocolSpecificTxInfo	0x00000000	0

The XA Resource Manager Bridge then sends an [XATMUSER_MTAG_ENLIST](#) user message specifying the Data Store Name and DLL Name.

Field	Value	Value description
MsgTag	0x00000FFF	MTAG_USER_MESSAGE
fIsMaster	0x00000001	1
dwConnectionId	0x00000003	3

Field	Value	Value description
dwUserMsgType	0x40000001	XATMUSER_MTAG_ENLIST
dwcbVarLenData	0x000000C8	200
dwReserved1	0xCD64CD64	dwReserved1: 0xcd64cd64
guidXaRm	0x31D8FE66	31d8fe66-7752-4bd5-a2b2-b6c4937e601e
	0x4BD57752	
	0xC4B6A2B2	
	0x1E607E93	
formatId	0x00445443	formatId: 0x00445443
gtridLength	0x00000010	16
bqualLength	0x00000020	32
Data (XID)	0xCE5163B5	Global Tx Identifier: ce5163b5-61c6-4091-a1d1-e6b5ef55c26f
	0x409161C6	
	0xB5E6D1A1	
	0x6FC255EF	
	0xC59B5217	XATMGUID: c59b5217-c34a-4180-8575-dba2eb499cf2
	0x4180C34A	
	0xA2DB7585	
	0xF29C49EB	
	0x10CADAB6	RMGUID: 10cadab6-8120-4409-8650-7395edc6bea0
	0x44098120	
	0x95735086	
	0xA0BEC6ED	
	0x00000000	
	0x00000000	
	0x00000000	
	0x00000000	
	0x00000000	
	0x00000000	
	0x00000000	
	0x00000000	
	0x00000000	
	0x00000000	
	0x00000000	
	0x00000000	

Field	Value	Value description
	0x00000000	
	0x00000000	
	0x00000000	
	0x00000000	
	0x00000000	
	0x00000000	
	0x00000000	
	0x00000000	
	0x00000000	
	0x00000000	
(lenImportCookie)	0x00000028	40
(ImportCookie)	0x2ADB4463	2adb4463-bd41-11d0-b12e-00c04fc2f3ef
	0x11D0BD41	
	0xC0002EB1	
	0xEFF3C24F	
	0xCE5163B5	Global Tx Identifier: ce5163b5-61c6-4091-a1d1-e6b5ef55c26f
	0x409161C6	
	0xB5E6D1A1	
	0x6FC255EF	
	0x00000003	3
	0x00000000	0

When the XA Resource Manager Bridge Facet receives the XATMUSER_MTAG_ENLIST message from the XA Resource Manager Bridge, the XA Resource Manager Bridge Facet attempts to find an XA Resource Manager object in the XA Resource Manager Table that has its Resource Manager Global Identifier field set to the **guidRM** field of the message. In this example, assume such an object was found.

Next, the XA Resource Manager Bridge Facet attempts to find an XA Subordinate Enlistment object in the XA Subordinate Enlistment Table referenced by the found XA Resource Manager object that has an XID field that contains an object that has a Data Field that contains an XA Global Transaction identifier that is set to the XA Global Transaction Identifier portion of the Data field of the XA_XID structure contained in the Xid field of the message. In this example, assume such an object was NOT found.

Next, the XA Resource Manager Bridge Facet attempts to create an XA Subordinate Enlistment object as outlined in section [3.4.1](#) and import a **transaction** as specified in [MS-DTCO] section 3.3.4.6 using the **ImportCookie** value of the received message. Assume the transaction was imported successfully. The XA Resource Manager Bridge Facet signals the [Create Subordinate Enlistment Success](#) event (section 3.4.7.5) providing the created XA Subordinate Enlistment object.

The Create Subordinate Enlistment Success event sends an [XATMUSER_MTAG_ENLISTMENTOK](#) message to the XA Resource Manager Bridge.

Field	Value	Value description
MsgTag	0x00000FFF	MTAG_USER_MESSAGE
fIsMaster	0x00000000	0
dwConnectionId	0x00000003	3
dwUserMsgType	0x40000002	XATMUSER_MTAG_ENLISTMENTOK
dwcbVarLenData	0x00000000	0

When the XA Resource Manager Bridge receives the XATMUSER_MTAG_ENLISTMENTOK message, it returns success to the Enlist Two-Pipe XA Resource Manager event.

4.2.2 One-Pipe Model

The scenarios in the following subsections show the interactions that take place when a One-Pipe XA Resource Manager is registered (section [3.5.4.4](#)) with a Transaction Manager.

4.2.2.1 Registering a One-Pipe XA Resource Manager

This scenario is initiated when the higher-level logic signals the [Register One-Pipe XA Resource Manager](#) event on **XA Resource Manager Bridge**, providing a Data Store Name, a DLL Name, and a **Resource Manager Cookie**.

The XA Resource Manager Bridge initiates a connection with the **XA Resource Manager Bridge Facet** using [CONNTYPE_XATM_OPENONEPIPE](#).

Field	Value	Value description
MsgTag	0x00000005	MTAG_CONNECTION_REQ
fIsMaster	0x00000001	1
dwConnectionId	0x00000002	2
dwUserMsgType	0x00001003	CONNTYPE_XATM_OPENONEPIPE
dwcbVarLenData	0x00000000	0
dwReserved1	0xCD64CD64	dwReserved1: 0xcd64cd64

The XA Resource Manager Bridge then sends an [XATMUSER_MTAG_RMOPEN](#) user message specifying the Data Store Name and DLL Name.

Field	Value	Value description
MsgTag	0x00000FFF	MTAG_USER_MESSAGE
fIsMaster	0x00000001	1
dwConnectionId	0x00000002	2
dwUserMsgType	0x20000001	XATMUSER_MTAG_RMOPEN
dwcbVarLenData	0x00000024	36

Field	Value	Value description
dwReserved1	0xCD64CD64	dwReserved1: 0xcd64cd64
lenDSN	0x00000010	16
lenXaDll	0x00000008	8
Recover	0x00000000	The transaction manager does not perform recovery.
DSN	0x656D614E	"Data Source Name"
	0x20656372	
	0x756F5320	
	0x61746144	
XaDllFileName	0x6C6C642E	"AnXa.dll"
	0x61586E41	

When the XA Resource Manager Bridge Facet receives the XATMUSER_MTAG_RMOPEN message from the XA Resource Manager Bridge, the XA Resource Manager Bridge Facet calls `xa_open()` on the XA Switch of the XA Resource Manager object providing the following arguments: the DSN field of the message, a randomly generated integer, and TMNOFLAGS. Assuming that the outcome of the `xa_open()` call is XA_OK, the XA Resource Manager Bridge Facet calls `xa_close()` on the XA Switch using the same arguments used for the `xa_open()` call. Assuming that the outcome of the `xa_close()` call is XA_OK, the XA Resource Manager Bridge Facet creates a new XA Resource Manager object as outlined in section [3.4.5.2.1](#) and writes the new XA Resource Manager to the XA Resource Manager Durable Log.

The XA Resource Manager Bridge Facet then sends an [XATMUSER_MTAG_RMOPENOK](#) message to the XA Resource Manager Bridge specifying the XA Resource Manager Identifier field (`localRmId:3`) and the Resource Manager Global Identifier (`guidRm: e3e6e8e7-f33c-40d7-81bf-fc23bb4e7fc4`) field of the XA Resource Manager object.

Field	Value	Value description
MsgTag	0x00000FFF	MTAG_USER_MESSAGE
fIsMaster	0x00000000	0
dwConnectionId	0x00000002	2
dwUserMsgType	0x20000002	XATMUSER_MTAG_RMOPENOK
dwcbVarLenData	0x00000014	20
dwReserved1	0xCD64CD64	dwReserved1: 0xcd64cd64
localRmId	0x00000003	3
guidRm	0xE3E6E8E7	e3e6e8e7-f33c-40d7-81bf-fc23bb4e7fc4
	0x40D7F33C	
	0x23FCBF81	
	0xC47F4EBB	

When the XA Resource Manager Bridge receives the XATMUSER_MTAG_RMOPENOK message, it sets the **Resource Manager Global Identifier** field of the XA Resource Manager Proxy object referenced by receiving the Connection to the **guidRm** field of the message. Next, the XA Resource Manager Bridge attempts to create a new Resource Manager object as defined in [\[MS-DTCO\]](#) section 3.5 using a newly created GUID as the session identifier. Finally, the XA Resource Manager Bridge returns success to the Register One-Pipe XA Resource Manager event.

4.2.2.2 Unregistering a One-Pipe XA Resource Manager

This scenario is initiated when the higher-level logic signals the [Unregister One-Pipe XA Resource Manager](#) event on **XA Resource Manager Bridge** providing a **Resource Manager Cookie** and a RecoveryNotNecessary flag. Assuming the RecoveryNotNecessary flag is set to TRUE, the XA Resource Manager Bridge then sends an [XATMUSER_MTAG_RMCLOSE](#) user message with the **ShutdownAbrupt** field set to 0.

Field	Value	Value description
MsgTag	0x00000FFF	MTAG_USER_MESSAGE
fIsMaster	0x00000001	1
dwConnectionId	0x00000002	2
dwUserMsgType	0x10000001	XATMUSER_MTAG_RMCLOSE
dwcbVarLenData	0x00000008	8
dwReserved1	0xCD64CD64	dwReserved1: 0xcd64cd64
ShutdownAbrupt	0x00000000	The shutdown is not abrupt.
Reserved	0x00000001	Implementation-specific and to be ignored.

When the **XA Resource Manager Bridge Facet** receives the XATMUSER_MTAG_RMCLOSE message from the XA Resource Manager Bridge, the XA Resource Manager Bridge Facet attempts to remove the XA Resource Manager object referenced by the XA Resource Manager CMP Connection from the XA Resource Manager Durable Log. Assuming the removal is successful, the XA Resource Manager Bridge Facet sends an [XATMUSER_MTAG_RMCLOSEOK](#) message.

Field	Value	Value description
MsgTag	0x00000FFF	MTAG_USER_MESSAGE
fIsMaster	0x00000000	0
dwConnectionId	0x00000002	2
dwUserMsgType	0x10000002	XATMUSER_MTAG_RMCLOSEOK
dwcbVarLenData	0x00000000	0

When the XA Resource Manager Bridge receives the XATMUSER_MTAG_RMCLOSEOK message, it signals the [Disconnect Connection](#) event using the receiving Connection as the argument. Then the XA Resource Manager Bridge returns success to the Unregister One-Pipe XA Resource Manager event.

5 Security

5.1 Security Considerations for Implementers

The **transaction** processing protocol that is defined by this specification is intended for use in an environment where all **participants** are trusted to collaborate in driving transactions toward a final **outcome**.

Misuse of this transaction processing protocol can enable participants to perform simple denial of service attacks on their **transaction managers**. Because transaction managers generally communicate with multiple participants simultaneously, this condition represents a denial of service to other participants.

Consequently, implementers are strongly encouraged to take the following steps to ensure that transaction processing occurs in a secure environment:

- Each participant follows the security level usage outlined in [\[MS-DTCO\]](#) (section 2.1.2.1).
- No transaction remains In Doubt for a longer period of time than the **application's** higher-layer business logic accepts.

5.2 Index of Security Parameters

None.

6 Appendix A: Product Behavior

The information in this specification is applicable to the following Microsoft products or supplemental software. References to product versions include updates to those products.

- Windows NT operating system
- Windows 2000 operating system
- Windows XP operating system
- Windows Server 2003 operating system
- Windows Vista operating system
- Windows Server 2008 operating system
- Windows 7 operating system
- Windows Server 2008 R2 operating system
- Windows 8 operating system
- Windows Server 2012 operating system
- Windows 8.1 operating system
- Windows Server 2012 R2 operating system
- Windows 10 operating system
- Windows Server 2016 operating system
- Windows Server operating system

Exceptions, if any, are noted in this section. If an update version, service pack or Knowledge Base (KB) number appears with a product name, the behavior changed in that update. The new behavior also applies to subsequent updates unless otherwise specified. If a product edition appears with the product version, behavior is different in that product edition.

Unless otherwise specified, any statement of optional behavior in this specification that is prescribed using the terms "SHOULD" or "SHOULD NOT" implies product behavior in accordance with the SHOULD or SHOULD NOT prescription. Unless otherwise specified, the term "MAY" implies that the product does not follow the prescription.

[<1> Section 2.2.3.2.5](#): On Windows Server 2003, Windows Vista, Windows Server 2008, Windows 7, Windows Server 2008 R2, Windows 8, Windows Server 2012, Windows 8.1, and Windows Server 2012 R2, the **lenDSN** field is less than 256.

[<2> Section 2.2.4.1](#): The [CONNTYPE_XAUSER_XACT_MIGRATE](#) and [CONNTYPE_XAUSER_XACT_MIGRATE2](#) are not supported by Windows NT 4.0 operating system Option Pack for Windows NT Server or Windows XP. The [CONNTYPE_XAUSER_XACT_MIGRATE2](#) connection type is not supported by Windows 2000, Windows Server 2003, or Windows Vista. The [CONNTYPE_XAUSER_XACT_MIGRATE](#) connection type is used instead. The [CONNTYPE_XAUSER_XACT_BRANCH_START](#) and [CONNTYPE_XAUSER_XACT_BRANCH_OPEN](#) connection types are not supported by Windows NT 4.0 Option Pack, Windows 2000, Windows XP, Windows Server 2003, or Windows Vista.

[<3> Section 2.2.4.2.4](#): When processing an [XAUSER_CONTROL_MTAG_RECOVER](#) message, in Windows NT 4.0 Option Pack, Windows 2000, or Windows XP the value of **totalUOWsRequested** is not verified to be valid and when processing an **Xa_recover** event the count is not minimized by an

implementation-specific value. On Windows Server 2003 the value for **totalUOWsRequested** is only verified not to be 0 and the value used is set to the minimum value between the provided value and 10000. When sending the message, Windows limits the value of the **totalUOWsRequested** field and the **Open Count** field of the **XA Superior Proxy** object to a maximum of 5.

<4> [Section 2.2.4.2.6](#): When processing an XAUSER_CONTROL_MTAG_RECOVER_REPLY message (section [2.2.4.2.6](#)) on Windows NT 4.0 Option Pack, Windows 2000, Windows XP, and Windows Server 2003, the provided **totalUOWs** field is not validated to be less than the number of requested **XIDs** (**totalUOWsRequested**).

<5> [Section 2.2.4.3.1](#): Setting the **Timeout** of a **transaction** created by an **xa_start** call is not supported on Windows NT 4.0 Option Pack, Windows 2000, Windows XP, and Windows Server 2003. The default value of 0x00000000 is used.

<6> [Section 3.2.5.1.2](#): When processing an XAUSER_CONTROL_MTAG_RECOVER message, the value of **totalUOWsRequested** is not verified to be valid on Windows NT 4.0 Option Pack, Windows 2000, or Windows XP. On Windows Server 2003, it is only verified not to be 0.

<7> [Section 3.2.5.1.2](#): When processing an XAUSER_CONTROL_MTAG_RECOVER message, the value that Windows uses as a maximum for **totalUOWsRequested** is 10000.

<8> [Section 3.2.5.1.2](#): When processing a XAUSER_CONTROL_MTAG_RECOVER message, the value that Windows uses as a maximum for **totalUOWsRequested** is 10000.

<9> [Section 3.2.5.1.2](#): When iterating over available **XA Superior Enlistment Objects** during processing of an XAUSER_CONTROL_MTAG_RECOVER message (section 2.2.4.2.4) on Windows NT 4.0 Option Pack, no check is performed, and the actions are taken for all **XA Superior Enlistment Objects**. Under the same conditions, only **XA Superior Enlistment Objects** in the **Preparing State** are returned.

<10> [Section 3.2.5.2.2](#): A [Connection Disconnected](#) event (section 3.2.5.2.2) on a [CONNTYPE_XAUSER_XACT_START](#) (section 2.2.4.3), [CONNTYPE_XAUSER_XACT_OPEN](#) (section 2.2.4.5), [CONNTYPE_XAUSER_XACT_BRANCH_START](#) (section 2.2.4.4), or [CONNTYPE_XAUSER_XACT_BRANCH_OPEN](#) (section 2.2.4.6) connection type is not processed on Windows NT 4.0 Option Pack, Windows 2000, Windows XP, or Windows Server 2003.

<11> [Section 3.2.5.3.5](#): A [Connection Disconnected](#) event (section 3.2.5.3.5) on a [CONNTYPE_XAUSER_XACT_START](#) (section 2.2.4.3), [CONNTYPE_XAUSER_XACT_OPEN](#) (section 2.2.4.5), [CONNTYPE_XAUSER_XACT_BRANCH_START](#) (section 2.2.4.4), or [CONNTYPE_XAUSER_XACT_BRANCH_OPEN](#) (section 2.2.4.6) connection type is not processed on Windows NT 4.0 Option Pack, Windows 2000, Windows XP, or Windows Server 2003.

<12> [Section 3.2.5.5.2](#): A [Connection Disconnected](#) event (section 3.2.5.5.2) on a [CONNTYPE_XAUSER_XACT_START](#) (section 2.2.4.3), [CONNTYPE_XAUSER_XACT_OPEN](#) (section 2.2.4.5), [CONNTYPE_XAUSER_XACT_BRANCH_START](#) (section 2.2.4.4), or [CONNTYPE_XAUSER_XACT_BRANCH_OPEN](#) (section 2.2.4.6) connection type is not processed on Windows NT 4.0 Option Pack, Windows 2000, Windows XP, or Windows Server 2003.

<13> [Section 3.2.5.6.5](#): A [Connection Disconnected](#) event (section 3.2.5.6.5) on a [CONNTYPE_XAUSER_XACT_START](#) (section 2.2.4.3), [CONNTYPE_XAUSER_XACT_OPEN](#) (section 2.2.4.5), [CONNTYPE_XAUSER_XACT_BRANCH_START](#) (section 2.2.4.4), or [CONNTYPE_XAUSER_XACT_BRANCH_OPEN](#) (section 2.2.4.6) connection type is not processed on Windows NT 4.0 Option Pack, Windows 2000, Windows XP, or Windows Server 2003.

<14> [Section 3.3.3](#): The XATransactions registry key, defined in [\[MS-CMOM\]](#) section 3.3.1.2.1, is not supported on Windows NT 4.0 Option Pack, Windows 2000, and Windows XP.

<15> [Section 3.3.4.3](#): Disabling Require Thread Affinity is not supported on Windows NT 4.0 Option Pack and Windows XP, and thus Require Thread Affinity is always set to TRUE.

<16> [Section 3.3.4.5](#): CONNTYPE_XAUSER_XACT_MIGRATE2 connection type is not supported by Windows 2000, Windows Server 2003 or, Windows Vista. CONNTYPE_XAUSER_XACT_MIGRATE connection type is used instead. CONNTYPE_XAUSER_XACT_MIGRATE2 and CONNTYPE_XAUSER_XACT_MIGRATE are not supported by Windows NT 4.0 Option Pack or Windows XP.

<17> [Section 3.3.4.5](#): The CONNTYPE_XAUSER_XACT_MIGRATE2 connection type (section 2.2.4.8) is not supported by Windows 2000, Windows Server 2003, or Windows Vista; the CONNTYPE_XAUSER_XACT_MIGRATE connection type (section 2.2.4.7) is used instead. The CONNTYPE_XAUSER_XACT_MIGRATE2 and CONNTYPE_XAUSER_XACT_MIGRATE connection types are not supported by the Windows NT 4.0 Option Pack or Windows XP; a result of XA_RMFAIL is returned when attempting to connect.

<18> [Section 3.3.4.7](#): Setting the Timeout of a transaction created by an xa_open call is not supported on Windows NT 4.0 Option Pack, Windows 2000, Windows XP, and Windows Server 2003. The default value of INFINITE is used.

<19> [Section 3.3.4.7](#): CONNTYPE_XAUSER_XACT_BRANCH_START and CONNTYPE_XAUSER_XACT_BRANCH_OPEN connection types are not supported by Windows NT 4.0 Option Pack, Windows 2000, Windows XP, Windows Server 2003, or Windows Vista. However, Windows Server 2003 operating system with Service Pack 2 (SP2) will support these connection types if updated using the hotfix located here: [\[KB938653\]](#).

<20> [Section 3.3.4.8](#): Disabling Require Thread Affinity is not supported on Windows NT 4.0 Option Pack and Windows XP, and thus Require Thread Affinity is always set to TRUE.

<21> [Section 3.3.4.9](#): On Windows NT 4.0 Option Pack, Windows 2000, and Windows XP, the **Recovery Complete** field is not supported.

<22> [Section 3.3.4.9](#): On Windows NT 4.0 Option Pack, Windows 2000, and Windows XP, the **Recovery Complete** field is not supported.

<23> [Section 3.3.4.9](#): On Windows NT 4.0 Option Pack, Windows 2000, and Windows XP, the **Recovery Complete** field is not supported.

<24> [Section 3.3.4.9](#): On Windows Server 2003, Windows Vista, Windows Server 2008, Windows 7, Windows Server 2008 R2 operating system, Windows 8, Windows Server 2012, Windows 8.1, and Windows Server 2012 R2, the XARECOVER_END_SCAN flag is not set.

<25> [Section 3.3.4.9](#): The Flags argument provided for the xa_recover event is not validated on Windows NT 4.0 Option Pack, Windows 2000, and Windows XP; therefore, in these releases, XAER_INVALID is not returned if TMSTARTSCAN is not set, AND TMENDSCAN is not set, but the provided Flags argument is not TMNOFLAGS.

<26> [Section 3.3.4.9](#): The value provided to the **Recovery Request Number** field will not be minimized between the provided Count value and an implementation-specific value when processing an xa_recover event on Windows NT 4.0 Option Pack, Windows 2000, and Windows XP.

<27> [Section 3.3.4.9](#): The value provided to the **Recovery Request Number** field will not be minimized between the provided Count value and an implementation-specific value when processing an xa_recover event on Windows NT 4.0 Option Pack, Windows 2000, and Windows XP.

<28> [Section 3.3.4.10](#): Disabling Require Thread Affinity is not supported on Windows NT 4.0 Option Pack and Windows XP, and thus Require Thread Affinity is always set to TRUE.

<29> [Section 3.3.4.11](#): The CONNTYPE_XAUSER_XACT_MIGRATE2 connection type is not supported by Windows 2000, Windows Server 2003, or Windows Vista. The CONNTYPE_XAUSER_XACT_MIGRATE

connection type is used instead. The CONNTYPE_XAUSER_XACT_MIGRATE2 and CONNTYPE_XAUSER_XACT_MIGRATE connection types are not supported by the Windows NT 4.0 Option Pack or Windows XP.

<30> [Section 3.3.4.11](#): Calling Xa_start with TMJOIN will not resume a Suspended transaction on Windows NT 4.0 Option Pack and Windows XP.

<31> [Section 3.3.4.11](#): Disabling Require Thread Affinity is not supported on Windows NT 4.0 Option Pack or Windows XP, and thus Require Thread Affinity is always set to TRUE.

<32> [Section 3.3.4.11](#): The CONNTYPE_XAUSER_XACT_MIGRATE2 connection type is not supported by Windows 2000, Windows Server 2003, or Windows Vista. The CONNTYPE_XAUSER_XACT_MIGRATE connection type is used instead. The CONNTYPE_XAUSER_XACT_MIGRATE2 and CONNTYPE_XAUSER_XACT_MIGRATE connection types are not supported by the Windows NT 4.0 Option Pack or Windows XP.

<33> [Section 3.3.4.11](#): Disabling Require Thread Affinity is not supported on Windows NT 4.0 Option Pack or Windows XP, and thus Require Thread Affinity is always set to TRUE.

<34> [Section 3.3.5.1.4](#): On Windows NT 4.0 Option Pack and Windows 2000 if the connection is disconnected while waiting for an Abort or a Commit response, a result of XA_RBCOMMFAIL is returned.

<35> [Section 3.3.5.1.4](#): When sending an XAUSER_CONTROL_MTAG_RECOVER message (section 2.2.4.2.4), Windows limits the values of the **totalUOWsRequested** field and the **Open Count** field of the **XA Superior Proxy object** to a maximum of 5.

<36> [Section 3.3.5.3.7](#): Losing connection when waiting for an Abort or Commit response will result in a result of XA_RBCOMMFAIL being returned on Windows NT 4.0 Option Pack and Windows 2000.

<37> [Section 3.3.5.3.7](#): Losing connection when waiting for an Abort or Commit response will result in a result of XA_RBCOMMFAIL being returned on Windows NT 4.0 Option Pack and Windows 2000.

<38> [Section 3.3.5.6.8](#): Losing connection when waiting for an Abort or Commit response will cause a result of XA_RBCOMMFAIL being returned on Windows NT 4.0 Option Pack and Windows 2000.

<39> [Section 3.3.5.6.8](#): Losing connection when waiting for an Abort or Commit response will cause a result of XA_RBCOMMFAIL being returned on Windows NT 4.0 Option Pack and Windows 2000.

<40> [Section 3.3.5.7.6](#): The CONNTYPE_XAUSER_XACT_MIGRATE2 connection type is not supported by Windows 2000, Windows Server 2003, or Windows Vista. If the Transaction Manager does not support this connection type and a MTAG_CONNECTION_REQ_DENIED is returned, the connection type will be converted to CONNTYPE_XAUSER_XACT_MIGRATE and processing continues.

<41> [Section 3.4.3.1](#): In applicable Windows releases, except Windows NT, the **XaTmMinWarmRecoveryInterval** is initialized to 15 seconds and is configurable to a positive number of seconds.

<42> [Section 3.4.3.1](#): In applicable Windows releases, except Windows NT, the **XaTmMaxWarmRecoveryInterval** is initialized to 600 seconds and is configurable to a positive number of seconds.

<43> [Section 3.4.4.1](#): The Recovery Interval of all **XA resource managers** is set to 60 seconds on Windows NT 4.0 Option Pack.

<44> [Section 3.4.5.1.1](#): On Windows Server 2003, Windows Vista, Windows Server 2008, Windows 7, Windows Server 2008 R2, Windows 8, Windows Server 2012, Windows 8.1, and Windows Server 2012 R2, the **lenDSN** field in an [XATMUSER_MTAG_RMOPEN](#) message (section 2.2.3.2.5) is less than 256. On Windows 10 and Windows Server 2016, the **lenDSN** field in an XATMUSER_MTAG_RMOPEN message is less than 3072.

<45> [Section 3.4.5.1.1](#): On Windows Server 2003, Windows Vista, Windows Server 2008, Windows 7, Windows Server 2008 R2, Windows 8, Windows Server 2012, Windows 8.1, Windows Server 2012 R2, Windows 10, and Windows Server 2016, the **lenXaDII** field in an XATMUSER_MTAG_RMOPEN message (section 2.2.3.2.5) is less than 256.

<46> [Section 3.4.5.1.1](#): The Recovery Interval of all XA resource managers is set to 60 seconds on Windows NT 4.0 Option Pack.

<47> [Section 3.4.5.1.1](#): When an error condition other than those specified occurs during the processing of an XATMUSER_MTAG_RMOPEN message (section 2.2.3.2.5), a message with an invalid **MTAG** is sent back on Windows NT 4.0 Option Pack.

<48> [Section 3.4.5.1.1](#): On Windows NT, Windows 2000, and Windows XP, the message is ignored, and the Connection State remains at Processing Open Request.

On Windows Server 2003, Windows Vista, Windows Server 2008, Windows 7, Windows Server 2008 R2, Windows 8, Windows Server 2012, Windows 8.1, and Windows Server 2012 R2, if the value of the **lenDSN** field or the **lenXaDII** field in an XATMUSER_MTAG_RMOPEN message (section 2.2.3.2.5) is greater than or equal to 256, an [XATMUSER_MTAG_E_RMOPENFAILED](#) response message (section 2.2.3.2.3) is sent, and the Connection State is set to Ended.

On Windows 10 and Windows Server 2016, if the value of the **lenDSN** field in an XATMUSER_MTAG_RMOPEN message is greater than or equal to 3072 or the **lenXaDII** field in an XATMUSER_MTAG_RMOPEN message is greater than or equal to 256, an XATMUSER_MTAG_E_RMOPENFAILED response message is sent, and the Connection State is set to Ended.

<49> [Section 3.4.5.2.1](#): In Windows Server 2003, Windows Vista, Windows Server 2008, Windows 7, Windows Server 2008 R2, Windows 8, Windows Server 2012, Windows 8.1, and Windows Server 2012 R2, the **lenDSN** field in an XATMUSER_MTAG_RMOPEN message (section 2.2.3.2.5) is less than 256. In Windows 10, and Windows Server 2016, the **lenDSN** field in an XATMUSER_MTAG_RMOPEN message is less than 3072.

<50> [Section 3.4.5.2.1](#): In applicable Windows releases, except Windows NT and Windows 2000, the **lenXaDII** field in an XATMUSER_MTAG_RMOPEN message (section 2.2.3.2.5) is less than 256.

<51> [Section 3.4.5.2.1](#): The Recovery Interval of all XA resource managers is set to 60 seconds on Windows NT 4.0 Option Pack.

<52> [Section 3.4.7.6](#): The Recovery Interval of an XA resource manager is not increased after signaling the [Recovery Interval Timer \(section 3.4.2.1\)](#) on Windows NT 4.0 Option Pack.

<53> [Section 3.4.7.6](#): The Recovery Interval of an XA resource manager is not increased after signaling the Recovery Interval Timer (section 3.4.2.1) on Windows NT 4.0 Option Pack.

<54> [Section 3.5.4.3](#): On Windows NT 4.0 Option Pack, the value of tmprotUsed field of an STxInfo is set to 2.

7 Change Tracking

This section identifies changes that were made to this document since the last release. Changes are classified as Major, Minor, or None.

The revision class **Major** means that the technical content in the document was significantly revised. Major changes affect protocol interoperability or implementation. Examples of major changes are:

- A document revision that incorporates changes to interoperability requirements.
- A document revision that captures changes to protocol functionality.

The revision class **Minor** means that the meaning of the technical content was clarified. Minor changes do not affect protocol interoperability or implementation. Examples of minor changes are updates to clarify ambiguity at the sentence, paragraph, or table level.

The revision class **None** means that no new technical changes were introduced. Minor editorial and formatting changes may have been made, but the relevant technical content is identical to the last released version.

The changes made to this document are listed in the following table. For more information, please contact dochelp@microsoft.com.

Section	Description	Revision class
6 Appendix A: Product Behavior	Added Windows Server to the applicable products list.	Major

8 Index

A

Abstract data model
XA Resource Manager Bridge ([section 3.1.1](#) 68, [section 3.5.1](#) 196)
XA Resource Manager Bridge Facet ([section 3.1.1](#) 68, [section 3.4.1](#) 168)
XA Subordinate Transaction Manager Facet ([section 3.1.1](#) 68, [section 3.2.1](#) 69)
XA Superior Transaction Manager ([section 3.1.1](#) 68, [section 3.3.1](#) 113)
[Applicability](#) 35

B

[Bridge role - XA Resource Manager](#) 33

C

[Capability negotiation](#) 35
[Change tracking](#) 247
[Connection Disconnected event](#) 69
[CONNTYPE enumeration](#) 39
CONNTYPE_XATM_ENLIST
[acceptor states - XA Resource Manager Bridge Facet](#) 174
[connection type](#) 46
[initiator states - XA Resource Manager Bridge](#) 201
CONNTYPE_XATM_OPEN
[acceptor states - XA Resource Manager Bridge Facet](#) 170
[connection type](#) 40
[initiator states - XA Resource Manager Bridge](#) 197
CONNTYPE_XATM_OPENONEPIPE
[acceptor states - XA Resource Manager Bridge Facet](#) 172
[connection type](#) 43
[initiator states - XA Resource Manager Bridge](#) 199
CONNTYPE_XAUSER_CONTROL
[acceptor states - XA Subordinate Transaction Manager Facet](#) 72
[connection type](#) 51
[initiator states - XA Superior Transaction Manager](#) 115
CONNTYPE_XAUSER_XACT_BRANCH_OPEN
[acceptor states - XA Subordinate Transaction Manager Facet](#) 81
[connection type](#) 62
[initiator states - XA Superior Transaction Manager](#) 125
CONNTYPE_XAUSER_XACT_BRANCH_START
[acceptor states - XA Subordinate Transaction Manager Facet](#) 79
[connection type](#) 58
[initiator states - XA Superior Transaction Manager](#) 123
CONNTYPE_XAUSER_XACT_MIGRATE
[acceptor states - XA Subordinate Transaction Manager Facet](#) 78
[connection type](#) 63

[initiator states - XA Superior Transaction Manager](#) 122
CONNTYPE_XAUSER_XACT_MIGRATE2
[acceptor states - XA Subordinate Transaction Manager Facet](#) 83
[connection type](#) 66
[initiator states - XA Superior Transaction Manager](#) 128
CONNTYPE_XAUSER_XACT_OPEN
[acceptor states - XA Subordinate Transaction Manager Facet](#) 76
[connection type](#) 58
[initiator states - XA Superior Transaction Manager](#) 119
CONNTYPE_XAUSER_XACT_START
[acceptor states - XA Subordinate Transaction Manager Facet](#) 74
[connection type](#) 55
[initiator states - XA Superior Transaction Manager](#) 117

D

Data model - abstract
XA Resource Manager Bridge ([section 3.1.1](#) 68, [section 3.5.1](#) 196)
XA Resource Manager Bridge Facet ([section 3.1.1](#) 68, [section 3.4.1](#) 168)
XA Subordinate Transaction Manager Facet ([section 3.1.1](#) 68, [section 3.2.1](#) 69)
XA Superior Transaction Manager ([section 3.1.1](#) 68, [section 3.3.1](#) 113)
[Disconnect Connection event](#) 69

E

[Examples - overview](#) 215

F

[Fields - vendor-extensible](#) 35

G

[Glossary](#) 12

H

Higher-layer triggered events
XA Resource Manager Bridge
[Create XID](#) 209
[Enlist One-Pipe XA Resource Manager](#) 208
[Enlist Two-Pipe XA Resource Manager](#) 206
[overview](#) 204
[Register One-Pipe XA Resource Manager](#) 206
[Register Two-Pipe XA Resource Manager](#) 204
[Unregister One-Pipe XA Resource Manager](#) 208
[Unregister Two-Pipe XA Resource Manager](#) 205
XA Resource Manager Bridge Facet
[overview](#) 177
[Recovery Event](#) 177

XA Subordinate Transaction Manager Facet
([section 3.1.5](#) 69, [section 3.2.4](#) 86)
XA Superior Transaction Manager
[XA Lookup](#) 131
[XA_close](#) 131
[XA_commit](#) 132
[XA_complete](#) 135
[XA_end](#) 135
[XA_forget](#) 137
[XA_open](#) 137
[XA_prepare](#) 139
[XA_recover](#) 141
[XA_rollback](#) 143
[XA_start](#) 145

I

[Implementer - security considerations](#) 241
[Index of security parameters](#) 241
[Informative references](#) 16
Initialization
XA Resource Manager Bridge ([section 3.1.3](#) 69,
[section 3.5.3](#) 204)
XA Resource Manager Bridge Facet ([section 3.1.3](#)
69, [section 3.4.3](#) 176, [section 3.4.3.1](#) 177)
XA Subordinate Transaction Manager Facet
([section 3.1.3](#) 69, [section 3.2.3](#) 85)
XA Superior Transaction Manager ([section 3.1.3](#)
69, [section 3.3.3](#) 130)
[Introduction](#) 12

L

Local events
XA Resource Manager Bridge ([section 3.1.8](#) 69,
[section 3.5.7](#) 214)
XA Resource Manager Bridge Facet
[Begin Commit](#) 187
[Begin Phase One](#) 188
[Begin Rollback](#) 190
[Create Subordinate Enlistment Failure](#) 191
[Create Subordinate Enlistment Success](#) 192
[Recover XA Resource Manager](#) 192
XA Subordinate Transaction Manager Facet
[Commit Complete](#) 108
[Create Superior Enlistment Failure](#) 110
[Create Superior Enlistment Success](#) 109
[Phase One Complete](#) 111
[Phase Zero Complete](#) 110
[Recover In Doubt Transaction](#) 112
[Rollback Complete](#) 112
[Unilaterally Aborted](#) 112
XA Superior Transaction Manager ([section 3.1.8](#)
69, [section 3.3.7](#) 168)

M

Message processing
XA Resource Manager Bridge
[CONNTYPE_XATM_ENLIST_initiator](#) 213
[CONNTYPE_XATM_OPEN_initiator](#) 210
[CONNTYPE_XATM_OPENONEPIPE_initiator](#) 211
XA Resource Manager Bridge Facet
[CONNTYPE_XATM_ENLIST_acceptor](#) 185
[CONNTYPE_XATM_OPEN_acceptor](#) 178

[CONNTYPE_XATM_OPENONEPIPE_acceptor](#) 182
[overview](#) 69

XA Subordinate Transaction Manager Facet
[CONNTYPE_XAUSER_CONTROL_acceptor](#) 86
[CONNTYPE_XAUSER_XACT_BRANCH_OPEN
acceptor](#) 101
[CONNTYPE_XAUSER_XACT_BRANCH_START
acceptor](#) 97
[CONNTYPE_XAUSER_XACT_MIGRATE_acceptor](#)
95
[CONNTYPE_XAUSER_XACT_MIGRATE2_acceptor](#)
106
[CONNTYPE_XAUSER_XACT_OPEN_acceptor](#) 92
[CONNTYPE_XAUSER_XACT_START_acceptor](#) 89

XA Superior Transaction Manager
[CONNTYPE_XAUSER_CONTROL_initiator](#) 151
[CONNTYPE_XAUSER_XACT_START_initiator](#) 153
[overview](#) 69

[MESSAGE_PACKET_packet](#) 36

Messages
[overview](#) 36
[transport](#) 36

N

[Normative references](#) 15

O

[Overview \(synopsis\)](#) 16
[overview](#) 16
roles
[overview](#) 33
[Transaction Manager](#) 33
[XA Resource Manager Bridge](#) 33
[XA Superior Transaction Manager](#) 33
scenarios
[OleTx Resource Managers enlisting with XA
Transaction Managers](#) 17
[XA Resource Managers enlisting with Transaction
Managers](#) 22

P

[Parameters - security index](#) 241
[Preconditions](#) 34
[Prerequisites](#) 34
[Product behavior](#) 242
Protocol Details
[overview](#) 68

R

[References](#) 15
[informative](#) 16
[normative](#) 15
[Relationship to other protocols](#) 34
Resource Manager
OleTx - enlisting with XA Transaction Managers
[overview](#) 17
[transaction enlistment and completion](#) 18
[transaction recovery](#) 20

XA
[Bridge Facet](#) 34
[Bridge role](#) 33

XA - enlisting with Transaction Managers
[one-pipe model](#) 29
[overview](#) 22
[transaction recovery](#) 24
[two-pipe model](#) 25

XA - registration and unregistration
[one-pipe model](#) 29
[two-pipe model](#) 26

Roles
[overview](#) 33

Transaction Manager
[overview](#) 33
[XA Resource Manager Bridge Facet](#) 34
[XA Subordinate Transaction Manager Facet](#) 34
[XA Resource Manager Bridge](#) 33
[XA Superior Transaction Manager](#) 33

S

Scenarios

OleTx Resource Managers enlisting with XA Transaction Managers
[overview](#) 17
[transaction enlistment and completion](#) 18
[transaction recovery](#) 20

XA Resource Managers enlisting with Transaction Managers
[one-pipe model](#) 29
[overview](#) 22
[transaction recovery](#) 24
[two-pipe model](#) 25

XA Superior
[committing a transaction with an XA Subordinate Transaction Manager Facet](#) 223
[obtaining a list of transactions to recover with an XA Subordinate Transaction Manager Facet](#) 226
[opening a connection with an XA Subordinate Transaction Manager Facet](#) 215
[overview](#) 215
[preparing a transaction with an XA Subordinate Transaction Manager Facet](#) 220
[Recovery](#) 226
[starting a transaction with an XA Subordinate Transaction Manager Facet](#) 216
[Two-Phase Commit Protocol](#) 219

Security

[implementer considerations](#) 241
[parameter index](#) 241

Sequencing rules

XA Resource Manager Bridge
[CONNTYPE_XATM_ENLIST_initiator](#) 213
[CONNTYPE_XATM_OPEN_initiator](#) 210
[CONNTYPE_XATM_OPENONEPIPE_initiator](#) 211

XA Resource Manager Bridge Facet
[CONNTYPE_XATM_ENLIST_acceptor](#) 185
[CONNTYPE_XATM_OPEN_acceptor](#) 178
[CONNTYPE_XATM_OPENONEPIPE_acceptor](#) 182
[overview](#) 69

XA Subordinate Transaction Manager Facet
[CONNTYPE_XAUSER_CONTROL_acceptor](#) 86
[CONNTYPE_XAUSER_XACT_BRANCH_OPEN_acceptor](#) 101
[CONNTYPE_XAUSER_XACT_BRANCH_START_acceptor](#) 97

[CONNTYPE_XAUSER_XACT_MIGRATE_acceptor](#) 95
[CONNTYPE_XAUSER_XACT_MIGRATE2_acceptor](#) 106
[CONNTYPE_XAUSER_XACT_OPEN_acceptor](#) 92
[CONNTYPE_XAUSER_XACT_START_acceptor](#) 89

XA Superior Transaction Manager
[CONNTYPE_XAUSER_CONTROL_initiator](#) 151
[CONNTYPE_XAUSER_XACT_START_initiator](#) 153
[overview](#) 69
[Standards assignments](#) 35
[Superior Transaction Manager role - XA Transaction Manager](#) 33

T

Timer events

XA Resource Manager Bridge ([section 3.1.7](#) 69, [section 3.5.6](#) 214)

XA Resource Manager Bridge Facet
[overview](#) 69
[Recovery Interval Timer](#) 187

XA Subordinate Transaction Manager Facet ([section 3.1.7](#) 69, [section 3.2.6](#) 108)

XA Superior Transaction Manager ([section 3.1.7](#) 69, [section 3.3.6](#) 168)

Timers

XA Resource Manager Bridge ([section 3.1.2](#) 68, [section 3.5.2](#) 203)

XA Resource Manager Bridge Facet
[overview](#) ([section 3.1.2](#) 68, [section 3.4.2](#) 176)
[Recovery Interval Timer](#) 176

XA Subordinate Transaction Manager Facet ([section 3.1.2](#) 68, [section 3.2.2](#) 85)

XA Superior Transaction Manager ([section 3.1.2](#) 68, [section 3.3.2](#) 130)

Tracking changes

Transaction

enlistment and completion
[OleTx Resource Managers enlisting with XA Transaction Managers](#) 18
[XA Resource Managers enlisting with Transaction Managers \(one-pipe model\)](#) 31
[XA Resource Managers enlisting with Transaction Managers \(two-pipe model\)](#) 27
recovery ([section 1.3.1.1.2](#) 20, [section 1.3.1.2.1](#) 24)

Transaction Manager - XA

OleTx Resource Managers enlisting with
[overview](#) 17
[transaction enlistment and completion](#) 18
[transaction recovery](#) 20
[Superior Transaction Manager role](#) 33

Transaction Manager - XA Resource Managers enlisting with

[one-pipe model](#) 29
[overview](#) 22
[transaction recovery](#) 24
[two-pipe model](#) 25

Transaction Manager role

[overview](#) 33
[XA Resource Manager Bridge Facet](#) 34
[XA Subordinate Transaction Manager Facet](#) 34
[Transport](#) 36

Triggered events - higher-layer

[XA Resource Manager Bridge](#)
[Create_XID](#) 209
[Enlist One-Pipe XA Resource Manager](#) 208
[Enlist Two-Pipe XA Resource Manager](#) 206
[overview](#) 204
[Register One-Pipe XA Resource Manager](#) 206
[Register Two-Pipe XA Resource Manager](#) 204
[Unregister One-Pipe XA Resource Manager](#) 208
[Unregister Two-Pipe XA Resource Manager](#) 205

XA Resource Manager Bridge Facet
[overview](#) 177
[Recovery Event](#) 177

XA Subordinate Transaction Manager Facet
 ([section 3.1.5](#) 69, [section 3.2.4](#) 86)

XA Superior Transaction Manager
[XA Lookup](#) 131
[Xa_close](#) 131
[Xa_commit](#) 132
[Xa_complete](#) 135
[Xa_end](#) 135
[Xa_forget](#) 137
[Xa_open](#) 137
[Xa_prepare](#) 139
[Xa_recover](#) 141
[Xa_rollback](#) 143
[Xa_start](#) 145

V

[Vendor-extensible fields](#) 35
[Versioning](#) 35

XA Resource Manager Bridge ([section 2.2.3.1](#) 39, [section 3.1.4](#) 69)
 XA Resource Manager Bridge Facet ([section 2.2.3.1](#) 39, [section 3.1.4](#) 69)
 XA Subordinate Transaction Manager Facet
 ([section 2.2.4.1](#) 51, [section 3.1.4](#) 69, [section 3.2.1.1](#) 72)
 XA Superior Transaction Manager ([section 2.2.4.1](#) 51, [section 3.1.4](#) 69, [section 3.3.1.1](#) 115)

X

XA Resource Manager Bridge
 abstract data model ([section 3.1.1](#) 68, [section 3.5.1](#) 196)
[CONNTYPE_XATM_ENLIST_initiator_states](#) 201
[CONNTYPE_XATM_OPEN_initiator_states](#) 197
[CONNTYPE_XATM_OPENONEPIPE_initiator_states](#) 199
 higher-layer triggered events
[Create_XID](#) 209
[Enlist One-Pipe XA Resource Manager](#) 208
[Enlist Two-Pipe XA Resource Manager](#) 206
[overview](#) 204
[Register One-Pipe XA Resource Manager](#) 206
[Register Two-Pipe XA Resource Manager](#) 204
[Unregister One-Pipe XA Resource Manager](#) 208
[Unregister Two-Pipe XA Resource Manager](#) 205
 initialization ([section 3.1.3](#) 69, [section 3.5.3](#) 204)
 local events ([section 3.1.8](#) 69, [section 3.5.7](#) 214)
 message processing
[CONNTYPE_XATM_ENLIST_initiator](#) 213
[CONNTYPE_XATM_OPEN_initiator](#) 210
[CONNTYPE_XATM_OPENONEPIPE_initiator](#) 211
[overview](#) 68
 sequencing rules
[CONNTYPE_XATM_ENLIST_initiator](#) 213
[CONNTYPE_XATM_OPEN_initiator](#) 210
[CONNTYPE_XATM_OPENONEPIPE_initiator](#) 211
 timer events ([section 3.1.7](#) 69, [section 3.5.6](#) 214)
 timers ([section 3.1.2](#) 68, [section 3.5.2](#) 203)
 versioning ([section 2.2.3.1](#) 39, [section 3.1.4](#) 69)

XA Resource Manager Bridge Facet
 abstract data model ([section 3.1.1](#) 68, [section 3.4.1](#) 168)
[CONNTYPE_XATM_ENLIST_acceptor_states](#) 174
[CONNTYPE_XATM_OPEN_acceptor_states](#) 170
[CONNTYPE_XATM_OPENONEPIPE_acceptor_states](#) 172
 higher-layer triggered events
[overview](#) 177
[Recovery Event](#) 177
 initialization ([section 3.1.3](#) 69, [section 3.4.3](#) 176, [section 3.4.3.1](#) 177)
 local events
[Begin Commit](#) 187
[Begin Phase One](#) 188
[Begin Rollback](#) 190
[Create Subordinate Enlistment Failure](#) 191
[Create Subordinate Enlistment Success](#) 192
[Recover XA Resource Manager](#) 192
 message processing
[CONNTYPE_XATM_ENLIST_acceptor](#) 185
[CONNTYPE_XATM_OPEN_acceptor](#) 178
[CONNTYPE_XATM_OPENONEPIPE_acceptor](#) 182
[overview](#) 69
[overview](#) 68
 sequencing rules
[CONNTYPE_XATM_ENLIST_acceptor](#) 185
[CONNTYPE_XATM_OPEN_acceptor](#) 178
[CONNTYPE_XATM_OPENONEPIPE_acceptor](#) 182
[overview](#) 69
 timer events
[overview](#) 69
[Recovery Interval Timer](#) 187
 timers
[overview](#) ([section 3.1.2](#) 68, [section 3.4.2](#) 176)
[Recovery Interval Timer](#) 176
 versioning ([section 2.2.3.1](#) 39, [section 3.1.4](#) 69)

XA Subordinate Transaction Manager Facet
 abstract data model ([section 3.1.1](#) 68, [section 3.2.1](#) 69)
[CONNTYPE_XAUSER_CONTROL_acceptor_states](#) 72
[CONNTYPE_XAUSER_XACT_BRANCH_OPEN_acceptor_states](#) 81
[CONNTYPE_XAUSER_XACT_BRANCH_START_acceptor_states](#) 79
[CONNTYPE_XAUSER_XACT_MIGRATE_acceptor_states](#) 78
[CONNTYPE_XAUSER_XACT_MIGRATE2_acceptor_states](#) 83
[CONNTYPE_XAUSER_XACT_OPEN_acceptor_states](#) 76
[CONNTYPE_XAUSER_XACT_START_acceptor_states](#) 74
 higher-layer triggered events ([section 3.1.5](#) 69, [section 3.2.4](#) 86)
 initialization ([section 3.1.3](#) 69, [section 3.2.3](#) 85)
 local events

- [Commit Complete](#) 108
- [Create Superior Enlistment Failure](#) 110
- [Create Superior Enlistment Success](#) 109
- [Phase One Complete](#) 111
- [Phase Zero Complete](#) 110
- [Recover In Doubt Transaction](#) 112
- [Rollback Complete](#) 112
- [Unilaterally Aborted](#) 112
- message processing
 - [CONNTYPE_XAUSER_CONTROL_acceptor](#) 86
 - [CONNTYPE_XAUSER_XACT_BRANCH_OPEN_acceptor](#) 101
 - [CONNTYPE_XAUSER_XACT_BRANCH_START_acceptor](#) 97
 - [CONNTYPE_XAUSER_XACT_MIGRATE_acceptor](#) 95
 - [CONNTYPE_XAUSER_XACT_MIGRATE2_acceptor](#) 106
 - [CONNTYPE_XAUSER_XACT_OPEN_acceptor](#) 92
 - [CONNTYPE_XAUSER_XACT_START_acceptor](#) 89
- [overview](#) 68
- sequencing rules
 - [CONNTYPE_XAUSER_CONTROL_acceptor](#) 86
 - [CONNTYPE_XAUSER_XACT_BRANCH_OPEN_acceptor](#) 101
 - [CONNTYPE_XAUSER_XACT_BRANCH_START_acceptor](#) 97
 - [CONNTYPE_XAUSER_XACT_MIGRATE_acceptor](#) 95
 - [CONNTYPE_XAUSER_XACT_MIGRATE2_acceptor](#) 106
 - [CONNTYPE_XAUSER_XACT_OPEN_acceptor](#) 92
 - [CONNTYPE_XAUSER_XACT_START_acceptor](#) 89
- timer events ([section 3.1.7](#) 69, [section 3.2.6](#) 108)
- timers ([section 3.1.2](#) 68, [section 3.2.2](#) 85)
- versioning ([section 2.2.4.1](#) 51, [section 3.1.4](#) 69, [section 3.2.1.1](#) 72)
- [XA Superior Enlistment states](#) 84
- [XA Superior Enlistment states - XA Subordinate Transaction Manager Facet](#) 84
- XA Superior Transaction Manager
 - abstract data model ([section 3.1.1](#) 68, [section 3.3.1](#) 113)
 - [CONNTYPE_XAUSER_CONTROL_initiator_states](#) 115
 - [CONNTYPE_XAUSER_XACT_BRANCH_OPEN_initiator_states](#) 125
 - [CONNTYPE_XAUSER_XACT_BRANCH_START_initiator_states](#) 123
 - [CONNTYPE_XAUSER_XACT_MIGRATE_initiator_states](#) 122
 - [CONNTYPE_XAUSER_XACT_MIGRATE2_initiator_states](#) 128
 - [CONNTYPE_XAUSER_XACT_OPEN_initiator_states](#) 119
 - [CONNTYPE_XAUSER_XACT_START_initiator_states](#) 117
- higher-layer triggered events
 - [XA Lookup](#) 131
 - [Xa_close](#) 131
 - [Xa_commit](#) 132
 - [Xa_complete](#) 135
 - [Xa_end](#) 135
 - [Xa_forget](#) 137
 - [Xa_open](#) 137
 - [Xa_prepare](#) 139
- [Xa_recover](#) 141
- [Xa_rollback](#) 143
- [Xa_start](#) 145
- initialization ([section 3.1.3](#) 69, [section 3.3.3](#) 130)
- local events ([section 3.1.8](#) 69, [section 3.3.7](#) 168)
- message processing
 - [CONNTYPE_XAUSER_CONTROL_initiator](#) 151
 - [CONNTYPE_XAUSER_XACT_START_initiator](#) 153
- [overview](#) 69
- [overview](#) 68
- sequencing rules
 - [CONNTYPE_XAUSER_CONTROL_initiator](#) 151
 - [CONNTYPE_XAUSER_XACT_START_initiator](#) 153
- [overview](#) 69
- timer events ([section 3.1.7](#) 69, [section 3.3.6](#) 168)
- timers ([section 3.1.2](#) 68, [section 3.3.2](#) 130)
- versioning ([section 2.2.4.1](#) 51, [section 3.1.4](#) 69, [section 3.3.1.1](#) 115)
- [XA_BQUAL_1_packet](#) 37
- [XA_UOW_packet](#) 39
- [XA_XID_packet](#) 37
- [XATMUSER_MTAG_E_CONFIGLOGWRITEFAILED_ONE_PIPE_packet](#) 43
- [XATMUSER_MTAG_E_ENLISTMENTDUPLICATE_packet](#) 46
- [XATMUSER_MTAG_E_ENLISTMENTFAILED_packet](#) 47
- [XATMUSER_MTAG_E_ENLISTMENTIMPFALLED_packet](#) 47
- [XATMUSER_MTAG_E_ENLISTMENTNOMEMORY_packet](#) 48
- [XATMUSER_MTAG_E_ENLISTMENTRMNOTFOUND_packet](#) 48
- [XATMUSER_MTAG_E_ENLISTMENTRMRECOVERING_packet](#) 48
- [XATMUSER_MTAG_E_ENLISTMENTRMUNAVAILABLE_packet](#) 49
- [XATMUSER_MTAG_E_ENLISTMENTTOOLATE_packet](#) 49
- [XATMUSER_MTAG_E_RMCLOSEFAILED_packet](#) 43
- [XATMUSER_MTAG_E_RMCLOSERMNOTAVAILABLE_packet](#) 44
- [XATMUSER_MTAG_E_RMCLOSETMERROR_packet](#) 44
- [XATMUSER_MTAG_E_RMCLOSETMNOTAVAILABLE_packet](#) 45
- [XATMUSER_MTAG_E_RMCLOSEUNEXPECTED_packet](#) 45
- [XATMUSER_MTAG_E_RMNONEXISTENT_TWOPIPE_packet](#) 40
- [XATMUSER_MTAG_E_RMNOTAVAILABLE_TWOPIPE_packet](#) 40
- [XATMUSER_MTAG_E_RMOPENFAILED_TWOPIPE_packet](#) 41
- [XATMUSER_MTAG_E_RMPROTOCOL_TWOPIPE_packet](#) 41
- [XATMUSER_MTAG_ENLIST_packet](#) 49
- [XATMUSER_MTAG_ENLISTMENTOK_packet](#) 50
- [XATMUSER_MTAG_RMCLOSE_packet](#) 45
- [XATMUSER_MTAG_RMCLOSEOK_packet](#) 46
- [XATMUSER_MTAG_RMOPEN_TWOPIPE_packet](#) 41
- [XATMUSER_MTAG_RMOPENOK_TWOPIPE_packet](#) 42
- [XAUSER_CONTROL_MTAG_CREATE_packet](#) 51
- [XAUSER_CONTROL_MTAG_CREATE_NO_MEM_packet](#) 52
- [XAUSER_CONTROL_MTAG_CREATED_packet](#) 52
- [XAUSER_CONTROL_MTAG_RECOVER_packet](#) 53

[XAUSER CONTROL MTAG RECOVER NO MEM packet](#) 53
[XAUSER CONTROL MTAG RECOVER REPLY packet](#)
54
[XAUSER XACT MTAG ABORT packet](#) 58
[XAUSER XACT MTAG COMMIT packet](#) 58
[XAUSER XACT MTAG OPEN packet](#) 59
[XAUSER XACT MTAG OPEN NOT FOUND packet](#) 59
[XAUSER XACT MTAG OPENED packet](#) 60
[XAUSER XACT MTAG PREPARE packet](#) 60
[XAUSER XACT MTAG PREPARE ABORT packet](#) 61
[XAUSER XACT MTAG PREPARE SINGLEPHASE IND
OUBT packet](#) 61
[XAUSER XACT MTAG READONLY packet](#) 62
[XAUSER XACT MTAG REQUEST COMPLETED packet](#)
62
[XAUSER XACT MTAG REQUEST FAILED BAD PROT
OCOL packet](#) 62
[XAUSER XACT MTAG RESUME packet](#) 63
[XAUSER XACT MTAG RESUME DONE packet](#) 64
[XAUSER XACT MTAG RESUME DONE 2 packet](#) 66
[XAUSER XACT MTAG START packet](#) 55
[XAUSER XACT MTAG START DUPLICATE packet](#) 56
[XAUSER XACT MTAG START LOG FULL packet](#) 56
[XAUSER XACT MTAG START NO MEM packet](#) 57
[XAUSER XACT MTAG STARTED packet](#) 57
[XAUSER XACT MTAG SUSPEND WITH MIGRATE
packet](#) 64
[XAUSER XACT MTAG SUSPEND WITH MIGRATE D
ONE packet](#) 65
[XAUSER XACT MTAG TRANSACTION NOT SUSPEN
DED packet](#) 66